

# **MySQL 5.1 with Maria Reference Manual**

---

# MySQL 5.1 with Maria Reference Manual

## Abstract

This is the MySQL Reference Manual. It documents MySQL 5.1 through 5.1.32. This manual also includes specific information on the [Maria](#) storage engine.

MySQL 5.1 with [Maria](#) does not include support for MySQL Cluster; for information about MySQL Cluster, please see [MySQL Cluster NDB 6.X/7.X](#).

MySQL 5.1 Features — This manual describes features that are not included in every edition of MySQL 5.1 and such features may not be included in the edition of MySQL 5.1 licensed to you. If you have any questions about the features included in your edition of MySQL 5.1, refer to your MySQL 5.1 license agreement or contact your Sun Microsystems sales representative."

Document generated on: 2009-06-03 (revision: 15169)

The following table provides direct links into areas of the manual according to different topics. Links marked with » link to online guides and other manuals for more information.

**Table 1. Topic Quick Reference**

Getting Started	Platforms	Administrators	Developers	Functionality	Connectors	HA/Scalability
<a href="#">Tutorial</a>	» <a href="#">Linux/Unix</a>	<a href="#">Server Option/Variable Reference</a>	<a href="#">Server Option/Variable Reference</a>	<a href="#">SQL Syntax</a>	<a href="#">Connector/J</a>	» <a href="#">HA/Scalability Guide</a>
<a href="#">Installation</a>	» <a href="#">Mac OS X</a>	<a href="#">MySQL Change History</a>	» <a href="#">MySQL Version Reference</a>	<a href="#">Views</a>	<a href="#">Connector/ODBC</a>	<a href="#">MySQL and DRBD</a>
<a href="#">Upgrading</a>	» <a href="#">Windows</a>	» <a href="#">MySQL Version Reference</a>	<a href="#">SQL Syntax</a>	<a href="#">Stored Routines</a>	<a href="#">Connector/NET</a>	<a href="#">MySQL and Virtualization</a>
<a href="#">Server Administration</a>	» <a href="#">Solaris</a>	» <a href="#">Security</a>	<a href="#">Optimization</a>	<a href="#">Replication</a>	<a href="#">Connector/C++</a>	<a href="#">Memcached</a>
<a href="#">FAQs</a>	» <a href="#">Building from Source</a>	» <a href="#">Startup/Shutdown</a>	<a href="#">Connectors &amp; APIs</a>	<a href="#">Spatial Extensions</a>	<a href="#">Connector/OOo</a>	<a href="#">MySQL Proxy</a>
		<a href="#">MySQL Enterprise Monitor</a>	<a href="#">Functions and Operators</a>	<a href="#">Precision Math</a>	<a href="#">PHP</a>	<a href="#">Replication</a>
		» <a href="#">Backup and Recovery</a>		<a href="#">I18N &amp; L18N</a>	<a href="#">C API</a>	
		<a href="#">Partitioning</a>		<a href="#">Partitioning</a>		
		<a href="#">Information Schema</a>				

Copyright © 1997-2008 MySQL AB, 2009 Sun Microsystems, Inc. All rights reserved. U.S. Government Rights - Commercial software. Government users are subject to the Sun Microsystems, Inc. standard license agreement and applicable provisions of the FAR and its supplements. Use is subject to license terms. Sun, Sun Microsystems, the Sun logo, Java, Solaris, StarOffice, MySQL Enterprise Monitor 2.0, MySQL logo™ and MySQL™ are trademarks or registered trademarks of Sun Microsystems, Inc. in the U.S. and other countries. UNIX is a registered trademark in the U.S. and other countries, exclusively licensed through X/Open Company, Ltd.

Copyright © 1997-2008 MySQL AB, 2009 Sun Microsystems, Inc. Tous droits réservés. L'utilisation est soumise aux termes du contrat de licence. Sun, Sun Microsystems, le logo Sun, Java, Solaris, StarOffice, MySQL Enterprise Monitor 2.0, MySQL logo™ et MySQL™ sont des marques de fabrique ou des marques déposées de Sun Microsystems, Inc. aux Etats-Unis et dans d'autres pays. UNIX est une marque déposée aux Etats-Unis et dans d'autres pays et licenciée exclusivement par X/Open Company, Ltd.

This documentation is NOT distributed under a GPL license. Use of this documentation is subject to the following terms: You may create a printed copy of this documentation solely for your own personal use. Conversion to other formats is allowed as long as the actual content is not altered or edited in any way. You shall not publish or distribute this documentation in any form or on any media, except if you distribute the documentation in a manner similar to how Sun disseminates it (that is, electronically for download on a Web site with the software) or on a CD-ROM or similar medium, provided however that the documentation is disseminated together with the software on the same medium. Any other use, such as any dissemination of printed copies or use of this documentation, in whole or in part, in another publication, requires the prior written consent from an authorized representative of Sun Microsystems, Inc. Sun Microsystems, Inc. and MySQL AB reserve any and all rights to this documentation not expressly granted above.

---

---

For more information on the terms of this license, for details on how the MySQL documentation is built and produced, or if you are interested in doing a translation, please contact the [Documentation Team](#).

For additional licensing information, including licenses for libraries used by MySQL, see [Preface](#), [Notes](#), [Licenses](#).

If you want help with using MySQL, please visit either the [MySQL Forums](#) or [MySQL Mailing Lists](#) where you can discuss your issues with other MySQL users.

For additional documentation on MySQL products, including translations of the documentation into other languages, and downloadable versions in variety of formats, including HTML, CHM, and PDF formats, see [MySQL Documentation Library](#).

---

---

---



---

# Table of Contents

Preface, Notes, Licenses .....	xxvii
1. MySQL Copyright Notice .....	xxvii
2. <code>regex</code> Library License .....	xxvii
3. <code>libedit</code> License .....	xxviii
4. <code>getarg</code> License .....	xxix
1. General Information .....	1
1.1. About This Manual .....	1
1.2. Typographical and Syntax Conventions .....	2
1.3. Overview of the MySQL Database Management System .....	3
1.3.1. What is MySQL? .....	3
1.3.2. History of MySQL .....	4
1.3.3. The Main Features of MySQL .....	4
1.4. MySQL Development Roadmap .....	7
1.4.1. What Is New in MySQL 5.1 .....	7
1.4.2. What Is Planned for MySQL 6.0 .....	8
1.5. MySQL Information Sources .....	9
1.5.1. MySQL Mailing Lists .....	9
1.5.2. MySQL Community Support at the MySQL Forums .....	11
1.5.3. MySQL Community Support on Internet Relay Chat (IRC) .....	12
1.5.4. MySQL Enterprise .....	12
1.6. How to Report Bugs or Problems .....	12
1.7. MySQL Standards Compliance .....	15
1.7.1. What Standards MySQL Follows .....	16
1.7.2. Selecting SQL Modes .....	16
1.7.3. Running MySQL in ANSI Mode .....	16
1.7.4. MySQL Extensions to Standard SQL .....	16
1.7.5. MySQL Differences from Standard SQL .....	19
1.7.6. How MySQL Deals with Constraints .....	23
1.8. Credits .....	25
1.8.1. Contributors to MySQL .....	25
1.8.2. Documenters and translators .....	29
1.8.3. Libraries used by and included with MySQL .....	30
1.8.4. Packages that support MySQL .....	31
1.8.5. Tools that were used to create MySQL .....	31
1.8.6. Supporters of MySQL .....	32
2. Installing and Upgrading MySQL .....	33
2.1. General Installation Issues .....	33
2.1.1. Operating Systems Supported by MySQL Community Server .....	34
2.1.2. Choosing Which MySQL Distribution to Install .....	35
2.1.3. How to Get MySQL .....	42
2.1.4. Verifying Package Integrity Using MD5 Checksums or <code>GnuPG</code> .....	42
2.1.5. Installation Layouts .....	45
2.2. Standard MySQL Installation Using a Binary Distribution .....	47
2.3. Installing MySQL on Windows .....	47
2.3.1. Choosing An Installation Package .....	48
2.3.2. Installing MySQL with the Automated Installer .....	48
2.3.3. Using the MySQL Installation Wizard .....	49
2.3.4. MySQL Server Instance Configuration Wizard .....	51
2.3.5. Installing MySQL from a Noinstall Zip Archive .....	61
2.3.6. Extracting the Install Archive .....	62
2.3.7. Creating an Option File .....	62
2.3.8. Selecting a MySQL Server Type .....	63
2.3.9. Starting the Server for the First Time .....	63
2.3.10. Starting MySQL from the Windows Command Line .....	64
2.3.11. Starting MySQL as a Windows Service .....	65
2.3.12. Testing The MySQL Installation .....	67
2.3.13. Troubleshooting a MySQL Installation Under Windows .....	67
2.3.14. Upgrading MySQL on Windows .....	68
2.3.15. MySQL on Windows Compared to MySQL on Unix .....	69
2.4. Installing MySQL from RPM Packages on Linux .....	71
2.5. Installing MySQL on Mac OS X .....	74
2.6. Installing MySQL on Solaris .....	75
2.7. Installing MySQL on i5/OS .....	76
2.8. Installing MySQL on NetWare .....	78

---

2.9. Installing MySQL from <code>tar.gz</code> Packages on Other Unix-Like Systems .....	80
2.10. MySQL Installation Using a Source Distribution .....	82
2.10.1. Source Installation Overview .....	83
2.10.2. Typical <code>configure</code> Options .....	85
2.10.3. Installing from the Development Source Tree .....	92
2.10.4. Dealing with Problems Compiling MySQL .....	94
2.10.5. MIT-pthreads Notes .....	96
2.10.6. Installing MySQL from Source on Windows .....	97
2.10.7. Compiling MySQL Clients on Windows .....	100
2.11. Post-Installation Setup and Testing .....	100
2.11.1. Windows Post-Installation Procedures .....	100
2.11.2. Unix Post-Installation Procedures .....	101
2.11.3. Securing the Initial MySQL Accounts .....	109
2.12. Upgrading or Downgrading MySQL .....	112
2.12.1. Upgrading MySQL .....	112
2.12.2. Downgrading MySQL .....	119
2.12.3. Checking Whether Table Indexes Must Be Rebuilt .....	120
2.12.4. Rebuilding or Repairing Tables or Indexes .....	122
2.12.5. Copying MySQL Databases to Another Machine .....	123
2.13. Operating System-Specific Notes .....	123
2.13.1. Linux Notes .....	123
2.13.2. Mac OS X Notes .....	128
2.13.3. Solaris Notes .....	129
2.13.4. BSD Notes .....	132
2.13.5. Other Unix Notes .....	134
2.14. Environment Variables .....	147
2.15. Perl Installation Notes .....	147
2.15.1. Installing Perl on Unix .....	148
2.15.2. Installing ActiveState Perl on Windows .....	148
2.15.3. Problems Using the Perl <code>DBI/DBD</code> Interface .....	149
3. Tutorial .....	151
3.1. Connecting to and Disconnecting from the Server .....	151
3.2. Entering Queries .....	152
3.3. Creating and Using a Database .....	154
3.3.1. Creating and Selecting a Database .....	155
3.3.2. Creating a Table .....	155
3.3.3. Loading Data into a Table .....	156
3.3.4. Retrieving Information from a Table .....	157
3.4. Getting Information About Databases and Tables .....	167
3.5. Using <code>mysql</code> in Batch Mode .....	168
3.6. Examples of Common Queries .....	169
3.6.1. The Maximum Value for a Column .....	169
3.6.2. The Row Holding the Maximum of a Certain Column .....	170
3.6.3. Maximum of Column per Group .....	170
3.6.4. The Rows Holding the Group-wise Maximum of a Certain Field .....	170
3.6.5. Using User-Defined Variables .....	171
3.6.6. Using Foreign Keys .....	171
3.6.7. Searching on Two Keys .....	172
3.6.8. Calculating Visits Per Day .....	173
3.6.9. Using <code>AUTO_INCREMENT</code> .....	173
3.7. Queries from the Twin Project .....	174
3.7.1. Find All Non-distributed Twins .....	174
3.7.2. Show a Table of Twin Pair Status .....	176
3.8. Using MySQL with Apache .....	176
4. MySQL Programs .....	177
4.1. Overview of MySQL Programs .....	177
4.2. Using MySQL Programs .....	181
4.2.1. Invoking MySQL Programs .....	181
4.2.2. Connecting to the MySQL Server .....	181
4.2.3. Specifying Program Options .....	184
4.2.4. Setting Environment Variables .....	193
4.3. MySQL Server and Server-Startup Programs .....	194
4.3.1. <code>mysqld</code> — The MySQL Server .....	194
4.3.2. <code>mysqld_safe</code> — MySQL Server Startup Script .....	194
4.3.3. <code>mysql.server</code> — MySQL Server Startup Script .....	198
4.3.4. <code>mysqld_multi</code> — Manage Multiple MySQL Servers .....	199
4.4. MySQL Installation-Related Programs .....	202
4.4.1. <code>comp_err</code> — Compile MySQL Error Message File .....	202
4.4.2. <code>make_win_bin_dist</code> — Package MySQL Distribution as ZIP Archive .....	203
4.4.3. <code>mysqlbug</code> — Generate Bug Report .....	204

---

4.4.4.	<code>mysql_fix_privilege_tables</code> — Upgrade MySQL System Tables	204
4.4.5.	<code>mysql_install_db</code> — Initialize MySQL Data Directory	205
4.4.6.	<code>mysql_secure_installation</code> — Improve MySQL Installation Security	206
4.4.7.	<code>mysql_tzinfo_to_sql</code> — Load the Time Zone Tables	206
4.4.8.	<code>mysql_upgrade</code> — Check Tables for MySQL Upgrade	207
4.5.	MySQL Client Programs	208
4.5.1.	<code>mysql</code> — The MySQL Command-Line Tool	209
4.5.2.	<code>mysqladmin</code> — Client for Administering a MySQL Server	224
4.5.3.	<code>mysqlcheck</code> — A Table Maintenance Program	230
4.5.4.	<code>mysqldump</code> — A Database Backup Program	235
4.5.5.	<code>mysqlimport</code> — A Data Import Program	247
4.5.6.	<code>mysqlshow</code> — Display Database, Table, and Column Information	252
4.5.7.	<code>mysqlslap</code> — Load Emulation Client	254
4.6.	MySQL Administrative and Utility Programs	261
4.6.1.	<code>innochecksum</code> — Offline InnoDB File Checksum Utility	261
4.6.2.	<code>myisam_ftdump</code> — Display Full-Text Index information	261
4.6.3.	<code>myisamchk</code> — MyISAM Table-Maintenance Utility	262
4.6.4.	<code>myisamlog</code> — Display MyISAM Log File Contents	270
4.6.5.	<code>myisampack</code> — Generate Compressed, Read-Only MyISAM Tables	271
4.6.6.	<code>mysqlaccess</code> — Client for Checking Access Privileges	276
4.6.7.	<code>mysqlbinlog</code> — Utility for Processing Binary Log Files	278
4.6.8.	<code>mysqldumpslow</code> — Summarize Slow Query Log Files	288
4.6.9.	<code>mysqlhotcopy</code> — A Database Backup Program	289
4.6.10.	<code>mysqlmanager</code> — The MySQL Instance Manager	292
4.6.11.	<code>mysql_convert_table_format</code> — Convert Tables to Use a Given Storage Engine	303
4.6.12.	<code>mysql_find_rows</code> — Extract SQL Statements from Files	304
4.6.13.	<code>mysql_fix_extensions</code> — Normalize Table File Name Extensions	304
4.6.14.	<code>mysql_setpermission</code> — Interactively Set Permissions in Grant Tables	305
4.6.15.	<code>mysql_waitpid</code> — Kill Process and Wait for Its Termination	305
4.6.16.	<code>mysqlzap</code> — Kill Processes That Match a Pattern	306
4.7.	MySQL Program Development Utilities	306
4.7.1.	<code>mysql2mysql</code> — Convert mSQL Programs for Use with MySQL	307
4.7.2.	<code>mysql_config</code> — Get Compile Options for Compiling Clients	307
4.7.3.	<code>my_print_defaults</code> — Display Options from Option Files	308
4.7.4.	<code>resolve_stack_dump</code> — Resolve Numeric Stack Trace Dump to Symbols	309
4.8.	Miscellaneous Programs	309
4.8.1.	<code>pererror</code> — Explain Error Codes	309
4.8.2.	<code>replace</code> — A String-Replacement Utility	310
4.8.3.	<code>resolveip</code> — Resolve Host name to IP Address or Vice Versa	310
5.	MySQL Server Administration	312
5.1.	The MySQL Server	312
5.1.1.	Server Option and Variable Reference	312
5.1.2.	Server Command Options	328
5.1.3.	Server System Variables	352
5.1.4.	Session System Variables	415
5.1.5.	Using System Variables	418
5.1.6.	Server Status Variables	427
5.1.7.	Server SQL Modes	443
5.1.8.	Server-Side Help	448
5.1.9.	Server Response to Signals	448
5.1.10.	The Shutdown Process	449
5.2.	MySQL Server Logs	450
5.2.1.	Selecting General Query and Slow Query Log Output Destinations	450
5.2.2.	The Error Log	452
5.2.3.	The General Query Log	453
5.2.4.	The Binary Log	454
5.2.5.	The Slow Query Log	461
5.2.6.	Server Log Maintenance	462
5.3.	General Security Issues	463
5.3.1.	General Security Guidelines	463
5.3.2.	Making MySQL Secure Against Attackers	465
5.3.3.	Security-Related <code>mysqld</code> Options	466
5.3.4.	Security Issues with <code>LOAD DATA LOCAL</code>	468
5.3.5.	How to Run MySQL as a Normal User	469
5.4.	The MySQL Access Privilege System	469
5.4.1.	Privileges Provided by MySQL	470
5.4.2.	Privilege System Grant Tables	473
5.4.3.	Specifying Account Names	476
5.4.4.	Access Control, Stage 1: Connection Verification	478
5.4.5.	Access Control, Stage 2: Request Verification	480

---

5.4.6. When Privilege Changes Take Effect .....	481
5.4.7. Causes of Access-Denied Errors .....	482
5.5. MySQL User Account Management .....	486
5.5.1. User Names and Passwords .....	486
5.5.2. Adding User Accounts .....	487
5.5.3. Removing User Accounts .....	489
5.5.4. Limiting Account Resources .....	489
5.5.5. Assigning Account Passwords .....	491
5.5.6. Password Security in MySQL .....	492
5.5.7. Using SSL for Secure Connections .....	497
5.5.8. Connecting to MySQL Remotely from Windows with SSH .....	504
5.5.9. Auditing MySQL Account Activity .....	505
5.6. Running Multiple MySQL Servers on the Same Machine .....	506
5.6.1. Running Multiple Servers on Windows .....	507
5.6.2. Running Multiple Servers on Unix .....	510
5.6.3. Using Client Programs in a Multiple-Server Environment .....	510
6. Backup and Recovery .....	512
6.1. Database Backups .....	514
6.2. Example Backup and Recovery Strategy .....	515
6.2.1. Backup Policy .....	516
6.2.2. Using Backups for Recovery .....	517
6.2.3. Backup Strategy Summary .....	518
6.3. Point-in-Time Recovery .....	518
6.3.1. Specifying Times for Recovery .....	518
6.3.2. Specifying Positions for Recovery .....	519
6.4. Table Maintenance and Crash Recovery .....	519
6.4.1. Using <code>myisamchk</code> for Crash Recovery .....	520
6.4.2. How to Check <code>MyISAM</code> Tables for Errors .....	520
6.4.3. How to Repair Tables .....	521
6.4.4. Table Optimization .....	523
6.4.5. Getting Information About a Table .....	523
6.4.6. Setting Up a Table Maintenance Schedule .....	527
7. Optimization .....	529
7.1. Optimization Overview .....	529
7.1.1. MySQL Design Limitations and Tradeoffs .....	529
7.1.2. Designing Applications for Portability .....	529
7.1.3. What We Have Used MySQL For .....	530
7.1.4. The MySQL Benchmark Suite .....	531
7.1.5. Using Your Own Benchmarks .....	531
7.2. Optimizing <code>SELECT</code> and Other Statements .....	532
7.2.1. Optimizing Queries with <code>EXPLAIN</code> .....	532
7.2.2. Estimating Query Performance .....	540
7.2.3. Speed of <code>SELECT</code> Queries .....	540
7.2.4. <code>WHERE</code> Clause Optimization .....	540
7.2.5. Range Optimization .....	542
7.2.6. Index Merge Optimization .....	544
7.2.7. Condition Pushdown Optimization .....	546
7.2.8. <code>IS NULL</code> Optimization .....	548
7.2.9. <code>LEFT JOIN</code> and <code>RIGHT JOIN</code> Optimization .....	548
7.2.10. Nested-Loop Join Algorithms .....	549
7.2.11. Nested Join Optimization .....	550
7.2.12. Outer Join Simplification .....	555
7.2.13. <code>ORDER BY</code> Optimization .....	557
7.2.14. <code>GROUP BY</code> Optimization .....	559
7.2.15. <code>DISTINCT</code> Optimization .....	560
7.2.16. Optimizing <code>IN/=ANY</code> Subqueries .....	561
7.2.17. <code>LIMIT</code> Optimization .....	564
7.2.18. Using <code>optimizer_switch</code> to Control the Optimizer .....	565
7.2.19. How to Avoid Table Scans .....	566
7.2.20. <code>INFORMATION_SCHEMA</code> Optimization .....	566
7.2.21. Speed of <code>INSERT</code> Statements .....	571
7.2.22. Speed of <code>UPDATE</code> Statements .....	572
7.2.23. Speed of <code>DELETE</code> Statements .....	572
7.2.24. Other Optimization Tips .....	572
7.3. Locking Issues .....	575
7.3.1. Internal Locking Methods .....	575
7.3.2. Table Locking Issues .....	577
7.3.3. Concurrent Inserts .....	578
7.3.4. External Locking .....	578
7.4. Optimizing Database Structure .....	579

---

---

7.4.1. Make Your Data as Small as Possible .....	579
7.4.2. Column Indexes .....	580
7.4.3. Multiple-Column Indexes .....	580
7.4.4. How MySQL Uses Indexes .....	581
7.4.5. The <code>MyISAM</code> Key Cache .....	583
7.4.6. <code>MyISAM</code> Index Statistics Collection .....	587
7.4.7. How MySQL Opens and Closes Tables .....	588
7.4.8. Disadvantages of Creating Many Tables in the Same Database .....	589
7.5. Optimizing the MySQL Server .....	589
7.5.1. How Compiling and Linking Affects the Speed of MySQL .....	589
7.5.2. System Factors and Startup Parameter Tuning .....	590
7.5.3. Tuning Server Parameters .....	591
7.5.4. Controlling Query Optimizer Performance .....	595
7.5.5. The MySQL Query Cache .....	595
7.5.6. Examining Thread Information .....	600
7.5.7. How MySQL Uses Threads for Client Connections .....	611
7.5.8. How MySQL Uses Memory .....	611
7.5.9. Enabling Large Page Support .....	612
7.5.10. How MySQL Uses Internal Temporary Tables .....	614
7.5.11. How MySQL Uses DNS .....	614
7.6. Disk Issues .....	615
7.6.1. Using Symbolic Links .....	615
8. Language Structure .....	618
8.1. Literal Values .....	618
8.1.1. Strings .....	618
8.1.2. Numbers .....	620
8.1.3. Hexadecimal Values .....	620
8.1.4. Boolean Values .....	620
8.1.5. Bit-Field Values .....	621
8.1.6. <code>NULL</code> Values .....	621
8.2. Schema Object Names .....	621
8.2.1. Identifier Qualifiers .....	623
8.2.2. Identifier Case Sensitivity .....	623
8.2.3. Mapping of Identifiers to File Names .....	624
8.2.4. Function Name Parsing and Resolution .....	626
8.3. Reserved Words .....	628
8.4. User-Defined Variables .....	631
8.5. Comment Syntax .....	633
9. Internationalization and Localization .....	635
9.1. Character Set Support .....	635
9.1.1. Character Sets and Collations in General .....	635
9.1.2. Character Sets and Collations in MySQL .....	636
9.1.3. Specifying Character Sets and Collations .....	637
9.1.4. Connection Character Sets and Collations .....	642
9.1.5. Configuring the Character Set and Collation for Applications .....	644
9.1.6. Collation Issues .....	645
9.1.7. String Repertoire .....	651
9.1.8. Operations Affected by Character Set Support .....	652
9.1.9. Unicode Support .....	654
9.1.10. UTF-8 for Metadata .....	655
9.1.11. Column Character Set Conversion .....	656
9.1.12. Character Sets and Collations That MySQL Supports .....	657
9.2. The Character Set Used for Data and Sorting .....	666
9.2.1. Using the German Character Set .....	667
9.3. Setting the Error Message Language .....	667
9.4. Adding a New Character Set .....	667
9.4.1. The Character Definition Arrays .....	669
9.4.2. String Collating Support .....	669
9.4.3. Multi-Byte Character Support .....	670
9.5. How to Add a New Collation to a Character Set .....	670
9.5.1. Collation Implementation Types .....	670
9.5.2. Choosing a Collation ID .....	672
9.5.3. Adding a Simple Collation to an 8-Bit Character Set .....	672
9.5.4. Adding a UCA Collation to a Unicode Character Set .....	673
9.6. Problems With Character Sets .....	675
9.7. MySQL Server Time Zone Support .....	676
9.7.1. Staying Current with Time Zone Changes .....	678
9.7.2. Time Zone Leap Second Support .....	679
9.8. MySQL Server Locale Support .....	679
10. Data Types .....	682

---

---

10.1. Data Type Overview .....	682
10.1.1. Overview of Numeric Types .....	682
10.1.2. Overview of Date and Time Types .....	684
10.1.3. Overview of String Types .....	685
10.1.4. Data Type Default Values .....	688
10.2. Numeric Types .....	689
10.3. Date and Time Types .....	691
10.3.1. The <code>DATETIME</code> , <code>DATE</code> , and <code>TIMESTAMP</code> Types .....	692
10.3.2. The <code>TIME</code> Type .....	696
10.3.3. The <code>YEAR</code> Type .....	697
10.3.4. Year 2000 Issues and Date Types .....	697
10.4. String Types .....	698
10.4.1. The <code>CHAR</code> and <code>VARCHAR</code> Types .....	698
10.4.2. The <code>BINARY</code> and <code>VARBINARY</code> Types .....	699
10.4.3. The <code>BLOB</code> and <code>TEXT</code> Types .....	700
10.4.4. The <code>ENUM</code> Type .....	701
10.4.5. The <code>SET</code> Type .....	702
10.5. Data Type Storage Requirements .....	704
10.6. Choosing the Right Type for a Column .....	707
10.7. Using Data Types from Other Database Engines .....	707
11. Functions and Operators .....	709
11.1. Operator and Function Reference .....	709
11.2. Operators .....	715
11.2.1. Operator Precedence .....	716
11.2.2. Type Conversion in Expression Evaluation .....	716
11.2.3. Comparison Functions and Operators .....	717
11.2.4. Logical Operators .....	721
11.3. Control Flow Functions .....	723
11.4. String Functions .....	724
11.4.1. String Comparison Functions .....	733
11.4.2. Regular Expressions .....	735
11.5. Numeric Functions .....	740
11.5.1. Arithmetic Operators .....	740
11.5.2. Mathematical Functions .....	742
11.6. Date and Time Functions .....	749
11.7. What Calendar Is Used By MySQL? .....	764
11.8. Full-Text Search Functions .....	765
11.8.1. Natural Language Full-Text Searches .....	765
11.8.2. Boolean Full-Text Searches .....	768
11.8.3. Full-Text Searches with Query Expansion .....	770
11.8.4. Full-Text Stopwords .....	770
11.8.5. Full-Text Restrictions .....	773
11.8.6. Fine-Tuning MySQL Full-Text Search .....	773
11.9. Cast Functions and Operators .....	774
11.10. XML Functions .....	776
11.11. Other Functions .....	785
11.11.1. Bit Functions .....	786
11.11.2. Encryption and Compression Functions .....	787
11.11.3. Information Functions .....	791
11.11.4. Miscellaneous Functions .....	796
11.12. Functions and Modifiers for Use with <code>GROUP BY</code> Clauses .....	800
11.12.1. <code>GROUP BY</code> (Aggregate) Functions .....	800
11.12.2. <code>GROUP BY</code> Modifiers .....	803
11.12.3. <code>GROUP BY</code> and <code>HAVING</code> with Hidden Columns .....	805
11.13. Spatial Extensions .....	806
11.13.1. Introduction to MySQL Spatial Support .....	806
11.13.2. The OpenGIS Geometry Model .....	807
11.13.3. Supported Spatial Data Formats .....	812
11.13.4. Creating a Spatially Enabled MySQL Database .....	813
11.13.5. Analyzing Spatial Information .....	818
11.13.6. Optimizing Spatial Analysis .....	826
11.13.7. MySQL Conformance and Compatibility .....	828
11.14. Precision Math .....	829
11.14.1. Types of Numeric Values .....	829
11.14.2. <code>DECIMAL</code> Data Type Changes .....	830
11.14.3. Expression Handling .....	831
11.14.4. Rounding Behavior .....	832
11.14.5. Precision Math Examples .....	832
12. SQL Statement Syntax .....	836
12.1. Data Definition Statements .....	836

---



12.1.1. ALTER DATABASE Syntax	836
12.1.2. ALTER EVENT Syntax	836
12.1.3. ALTER LOGFILE GROUP Syntax	838
12.1.4. ALTER FUNCTION Syntax	839
12.1.5. ALTER PROCEDURE Syntax	839
12.1.6. ALTER SERVER Syntax	839
12.1.7. ALTER TABLE Syntax	839
12.1.8. ALTER TABLESPACE Syntax	851
12.1.9. ALTER VIEW Syntax	851
12.1.10. CREATE DATABASE Syntax	852
12.1.11. CREATE EVENT Syntax	852
12.1.12. CREATE FUNCTION Syntax	856
12.1.13. CREATE INDEX Syntax	856
12.1.14. CREATE LOGFILE GROUP Syntax	859
12.1.15. CREATE PROCEDURE and CREATE FUNCTION Syntax	859
12.1.16. CREATE SERVER Syntax	863
12.1.17. CREATE TABLE Syntax	864
12.1.18. CREATE TABLESPACE Syntax	878
12.1.19. CREATE TRIGGER Syntax	879
12.1.20. CREATE VIEW Syntax	882
12.1.21. DROP DATABASE Syntax	885
12.1.22. DROP EVENT Syntax	886
12.1.23. DROP FUNCTION Syntax	886
12.1.24. DROP INDEX Syntax	886
12.1.25. DROP LOGFILE GROUP Syntax	886
12.1.26. DROP PROCEDURE and DROP FUNCTION Syntax	887
12.1.27. DROP SERVER Syntax	887
12.1.28. DROP TABLE Syntax	887
12.1.29. DROP TABLESPACE Syntax	888
12.1.30. DROP TRIGGER Syntax	888
12.1.31. DROP VIEW Syntax	888
12.1.32. RENAME DATABASE Syntax	888
12.1.33. RENAME TABLE Syntax	889
12.2. Data Manipulation Statements	889
12.2.1. CALL Syntax	889
12.2.2. DELETE Syntax	890
12.2.3. DO Syntax	893
12.2.4. HANDLER Syntax	893
12.2.5. INSERT Syntax	895
12.2.6. LOAD DATA INFILE Syntax	900
12.2.7. REPLACE Syntax	907
12.2.8. SELECT Syntax	908
12.2.9. Subquery Syntax	922
12.2.10. TRUNCATE Syntax	931
12.2.11. UPDATE Syntax	932
12.3. MySQL Utility Statements	933
12.3.1. DESCRIBE Syntax	933
12.3.2. EXPLAIN Syntax	933
12.3.3. HELP Syntax	934
12.3.4. USE Syntax	936
12.4. MySQL Transactional and Locking Statements	936
12.4.1. START TRANSACTION, COMMIT, and ROLLBACK Syntax	936
12.4.2. Statements That Cannot Be Rolled Back	937
12.4.3. Statements That Cause an Implicit Commit	938
12.4.4. SAVEPOINT and ROLLBACK TO SAVEPOINT Syntax	938
12.4.5. LOCK TABLES and UNLOCK TABLES Syntax	939
12.4.6. SET TRANSACTION Syntax	943
12.4.7. XA Transactions	944
12.5. Database Administration Statements	947
12.5.1. Account Management Statements	947
12.5.2. Table Maintenance Statements	956
12.5.3. Plugin and User-Defined Function Statements	962
12.5.4. SET Syntax	964
12.5.5. SHOW Syntax	966
12.5.6. Other Administrative Statements	997
12.6. Replication Statements	1001
12.6.1. SQL Statements for Controlling Master Servers	1001
12.6.2. SQL Statements for Controlling Slave Servers	1002
12.7. SQL Syntax for Prepared Statements	1007
12.7.1. PREPARE Syntax	1009

---

12.7.2. EXECUTE Syntax .....	1010
12.7.3. DEALLOCATE PREPARE Syntax .....	1010
12.7.4. Automatic Prepared Statement Repreparation .....	1010
12.8. MySQL Compound-Statement Syntax .....	1010
12.8.1. BEGIN ... END Compound Statement Syntax .....	1011
12.8.2. DECLARE Syntax .....	1011
12.8.3. Variables in Stored Programs .....	1011
12.8.4. Conditions and Handlers .....	1012
12.8.5. Cursors .....	1014
12.8.6. Flow Control Constructs .....	1015
12.8.7. RETURN Syntax .....	1018
13. Storage Engines .....	1019
13.1. Overview of MySQL Storage Engine Architecture .....	1019
13.1.1. The Common Database Server Layer .....	1020
13.1.2. Pluggable Storage Engine Architecture .....	1021
13.2. Supported Storage Engines .....	1021
13.2.1. Choosing a Storage Engine .....	1022
13.2.2. Comparing Transaction and Non-Transaction Engines .....	1023
13.2.3. Other Storage Engines .....	1023
13.3. Setting the Storage Engine .....	1024
13.4. The MyISAM Storage Engine .....	1024
13.4.1. MyISAM Startup Options .....	1026
13.4.2. Space Needed for Keys .....	1028
13.4.3. MyISAM Table Storage Formats .....	1028
13.4.4. MyISAM Table Problems .....	1030
13.5. The Maria Storage Engine .....	1031
13.5.1. Maria Configuration .....	1032
13.5.2. Maria Table Options .....	1035
13.5.3. Maria Transaction Log .....	1036
13.5.4. Maria Recovery .....	1038
13.5.5. Maria Usage Notes .....	1038
13.5.6. Maria Statement Concurrency .....	1039
13.5.7. Maria Design Notes .....	1040
13.5.8. Maria Command-line Tools .....	1041
13.5.9. Maria Open Bugs .....	1042
13.5.10. Maria FAQ .....	1042
13.6. The InnoDB Storage Engine .....	1043
13.6.1. InnoDB Contact Information .....	1044
13.6.2. InnoDB Configuration .....	1044
13.6.3. InnoDB Startup Options and System Variables .....	1050
13.6.4. Creating and Using InnoDB Tables .....	1059
13.6.5. Adding, Removing, or Resizing InnoDB Data and Log Files .....	1069
13.6.6. Backing Up and Recovering an InnoDB Database .....	1070
13.6.7. Moving an InnoDB Database to Another Machine .....	1073
13.6.8. The InnoDB Transaction Model and Locking .....	1073
13.6.9. InnoDB Multi-Versioning .....	1082
13.6.10. InnoDB Table and Index Structures .....	1082
13.6.11. InnoDB Disk I/O and File Space Management .....	1085
13.6.12. InnoDB Error Handling .....	1086
13.6.13. InnoDB Performance Tuning and Troubleshooting .....	1091
13.6.14. Restrictions on InnoDB Tables .....	1102
13.7. The MERGE Storage Engine .....	1104
13.7.1. MERGE Table Problems .....	1106
13.8. The MEMORY (HEAP) Storage Engine .....	1107
13.9. The EXAMPLE Storage Engine .....	1110
13.10. The FEDERATED Storage Engine .....	1110
13.10.1. FEDERATED Storage Engine Overview .....	1110
13.10.2. How to Create FEDERATED Tables .....	1111
13.10.3. FEDERATED Storage Engine Notes and Tips .....	1114
13.10.4. FEDERATED Storage Engine Resources .....	1115
13.11. The ARCHIVE Storage Engine .....	1115
13.12. The CSV Storage Engine .....	1116
13.12.1. Repairing and Checking CSV Tables .....	1117
13.12.2. CSV Limitations .....	1117
13.13. The BLACKHOLE Storage Engine .....	1118
14. High Availability and Scalability .....	1120
14.1. Using MySQL with DRBD .....	1122
14.1.1. Configuring the DRBD Environment .....	1123
14.1.2. Configuring MySQL for DRBD .....	1131
14.1.3. Optimizing Performance and Reliability .....	1132

---



---

14.2. Using Linux HA Heartbeat .....	1135
14.2.1. Heartbeat Configuration .....	1136
14.2.2. Using Heartbeat with MySQL and DRBD .....	1137
14.2.3. Using Heartbeat with DRBD and <code>dopd</code> .....	1139
14.2.4. Dealing with System Level Errors .....	1139
14.3. MySQL and Virtualization .....	1140
14.3.1. Common Issues with Virtualization .....	1141
14.3.2. Using MySQL within an Amazon EC2 Instance .....	1142
14.3.3. Virtualization Resources .....	1147
14.4. Using ZFS Replication .....	1147
14.4.1. Using ZFS for Filesystem Replication .....	1148
14.4.2. Configuring MySQL for ZFS Replication .....	1149
14.4.3. Handling MySQL Recovery with ZFS .....	1150
14.5. Using MySQL with <code>memcached</code> .....	1150
14.5.1. Installing <code>memcached</code> .....	1151
14.5.2. Using <code>memcached</code> .....	1152
14.5.3. <code>memcached</code> Interfaces .....	1164
14.5.4. Getting <code>memcached</code> Statistics .....	1185
14.5.5. <code>memcached</code> FAQ .....	1189
14.6. MySQL Proxy .....	1193
14.6.1. MySQL Proxy Supported Platforms .....	1194
14.6.2. Installing MySQL Proxy .....	1194
14.6.3. MySQL Proxy Command-Line Options .....	1196
14.6.4. MySQL Proxy Scripting .....	1197
14.6.5. Using MySQL Proxy .....	1206
14.6.6. MySQL Proxy FAQ .....	1207
15. MySQL Enterprise Monitor .....	1212
15.1. An Overview of the Service .....	1212
15.1.1. The Service Architecture .....	1213
15.1.2. Service Features .....	1214
15.1.3. Security .....	1215
15.2. Conventions Used in This Document .....	1215
15.3. Installation and Upgrades .....	1216
15.3.1. User Roles .....	1217
15.3.2. Service Manager Installation .....	1218
15.3.3. Monitor Agent Installation .....	1234
15.3.4. Unattended Installation .....	1258
15.3.5. Post-Installation Considerations .....	1262
15.3.6. Upgrading, Re-Installing or Changing Your Installation .....	1262
15.3.7. Uninstalling the MySQL Enterprise Monitor .....	1272
15.4. Deploying MySQL Enterprise Service Manager .....	1275
15.4.1. Backing up MySQL Enterprise Service Manager .....	1275
15.4.2. Migrating 1.3.x Historical Data to MySQL Enterprise Monitor 2.0 .....	1275
15.4.3. Regular MySQL Enterprise Monitor Maintenance .....	1278
15.4.4. Choosing Suitable MySQL Enterprise Service Manager Hardware Configurations .....	1278
15.5. MySQL Enterprise Dashboard .....	1278
15.5.1. The Server Tree .....	1280
15.5.2. The Server Graphs and Critical Events .....	1280
15.5.3. The Heat Chart .....	1281
15.6. The Settings Page .....	1283
15.6.1. Global Settings .....	1283
15.6.2. User Preferences .....	1286
15.6.3. Manage Servers .....	1286
15.6.4. Managing Users .....	1289
15.6.5. Manage Notification Groups .....	1289
15.6.6. Logs .....	1290
15.6.7. The Product Information Screen .....	1291
15.7. The Advisors Page .....	1292
15.7.1. Installing and Updating Advisors .....	1293
15.7.2. Scheduling Rules .....	1293
15.7.3. Editing Built-in Rules .....	1295
15.7.4. Creating Advisors and Rules .....	1297
15.7.5. Disabling and Uncheduling Rules .....	1302
15.7.6. Advisor Blackout Periods .....	1302
15.8. The Events Page .....	1303
15.8.1. Closing an Event .....	1305
15.9. The Graphs Page .....	1305
15.9.1. Displaying Graphs .....	1305
15.9.2. Setting an Interval .....	1306
15.9.3. Setting a Time Span .....	1306

---

---

15.10. The Query Analyzer Page .....	1306
15.10.1. Enabling Query Analyzer .....	1308
15.10.2. Getting Detailed Query Information .....	1312
15.10.3. Filtering Query Analyzer Data .....	1315
15.10.4. Using Query Analyzer Data .....	1316
15.10.5. Troubleshooting Query Analyzer .....	1316
15.10.6. Query Analyzer Settings .....	1317
15.11. The Replication Page .....	1319
15.11.1. Replication Page Details .....	1320
15.12. MySQL Enterprise Monitor Frequently Asked Questions .....	1320
16. Replication .....	1330
16.1. Replication Configuration .....	1330
16.1.1. How to Set Up Replication .....	1331
16.1.2. Replication Formats .....	1338
16.1.3. Replication and Binary Logging Options and Variables .....	1343
16.1.4. Common Replication Administration Tasks .....	1365
16.2. Replication Solutions .....	1367
16.2.1. Using Replication for Backups .....	1367
16.2.2. Using Replication with Different Master and Slave Storage Engines .....	1370
16.2.3. Using Replication for Scale-Out .....	1371
16.2.4. Replicating Different Databases to Different Slaves .....	1372
16.2.5. Improving Replication Performance .....	1373
16.2.6. Switching Masters During Failover .....	1374
16.2.7. Setting Up Replication Using SSL .....	1376
16.3. Replication Notes and Tips .....	1378
16.3.1. Replication Features and Issues .....	1378
16.3.2. Replication Compatibility Between MySQL Versions .....	1389
16.3.3. Upgrading a Replication Setup .....	1390
16.3.4. Replication FAQ .....	1390
16.3.5. Troubleshooting Replication .....	1393
16.3.6. How to Report Replication Bugs or Problems .....	1394
16.4. Replication Implementation .....	1395
16.4.1. Replication Implementation Details .....	1395
16.4.2. Replication Relay and Status Files .....	1396
16.4.3. How Servers Evaluate Replication Rules .....	1398
17. Partitioning .....	1401
17.1. Overview of Partitioning in MySQL .....	1402
17.2. Partition Types .....	1404
17.2.1. RANGE Partitioning .....	1405
17.2.2. LIST Partitioning .....	1407
17.2.3. HASH Partitioning .....	1409
17.2.4. KEY Partitioning .....	1411
17.2.5. Subpartitioning .....	1412
17.2.6. How MySQL Partitioning Handles NULL .....	1415
17.3. Partition Management .....	1418
17.3.1. Management of RANGE and LIST Partitions .....	1419
17.3.2. Management of HASH and KEY Partitions .....	1423
17.3.3. Maintenance of Partitions .....	1423
17.3.4. Obtaining Information About Partitions .....	1424
17.4. Partition Pruning .....	1426
17.5. Restrictions and Limitations on Partitioning .....	1428
17.5.1. Partitioning Keys, Primary Keys, and Unique Keys .....	1431
17.5.2. Partitioning Limitations Relating to Storage Engines .....	1434
17.5.3. Partitioning Limitations Relating to Functions .....	1434
18. Stored Programs and Views .....	1436
18.1. Defining Stored Programs .....	1436
18.2. Using Stored Routines (Procedures and Functions) .....	1437
18.2.1. Stored Routine Syntax .....	1438
18.2.2. Stored Routines and MySQL Privileges .....	1438
18.2.3. Stored Routine Metadata .....	1438
18.2.4. Stored Procedures, Functions, Triggers, and LAST_INSERT_ID() .....	1439
18.3. Using Triggers .....	1439
18.3.1. Trigger Syntax .....	1439
18.3.2. Trigger Metadata .....	1441
18.4. Using the Event Scheduler .....	1441
18.4.1. Event Scheduler Overview .....	1442
18.4.2. Event Scheduler Configuration .....	1442
18.4.3. Event Syntax .....	1444
18.4.4. Event Metadata .....	1445
18.4.5. Event Scheduler Status .....	1445

---

---

18.4.6. The Event Scheduler and MySQL Privileges .....	1445
18.5. Using Views .....	1448
18.5.1. View Syntax .....	1448
18.5.2. View Processing Algorithms .....	1448
18.5.3. Updatable and Insertable Views .....	1450
18.5.4. View Metadata .....	1451
18.6. Binary Logging of Stored Programs .....	1451
19. <a href="#">INFORMATION_SCHEMA</a> Tables .....	1457
19.1. The <a href="#">INFORMATION_SCHEMA</a> <a href="#">SCHEMATA</a> Table .....	1458
19.2. The <a href="#">INFORMATION_SCHEMA</a> <a href="#">TABLES</a> Table .....	1458
19.3. The <a href="#">INFORMATION_SCHEMA</a> <a href="#">COLUMNS</a> Table .....	1460
19.4. The <a href="#">INFORMATION_SCHEMA</a> <a href="#">STATISTICS</a> Table .....	1460
19.5. The <a href="#">INFORMATION_SCHEMA</a> <a href="#">USER_PRIVILEGES</a> Table .....	1461
19.6. The <a href="#">INFORMATION_SCHEMA</a> <a href="#">SCHEMA_PRIVILEGES</a> Table .....	1461
19.7. The <a href="#">INFORMATION_SCHEMA</a> <a href="#">TABLE_PRIVILEGES</a> Table .....	1462
19.8. The <a href="#">INFORMATION_SCHEMA</a> <a href="#">COLUMN_PRIVILEGES</a> Table .....	1462
19.9. The <a href="#">INFORMATION_SCHEMA</a> <a href="#">CHARACTER_SETS</a> Table .....	1463
19.10. The <a href="#">INFORMATION_SCHEMA</a> <a href="#">COLLATIONS</a> Table .....	1463
19.11. The <a href="#">INFORMATION_SCHEMA</a> <a href="#">COLLATION_CHARACTER_SET_APPLICABILITY</a> Table .....	1463
19.12. The <a href="#">INFORMATION_SCHEMA</a> <a href="#">TABLE_CONSTRAINTS</a> Table .....	1464
19.13. The <a href="#">INFORMATION_SCHEMA</a> <a href="#">KEY_COLUMN_USAGE</a> Table .....	1464
19.14. The <a href="#">INFORMATION_SCHEMA</a> <a href="#">ROUTINES</a> Table .....	1465
19.15. The <a href="#">INFORMATION_SCHEMA</a> <a href="#">VIEWS</a> Table .....	1466
19.16. The <a href="#">INFORMATION_SCHEMA</a> <a href="#">TRIGGERS</a> Table .....	1467
19.17. The <a href="#">INFORMATION_SCHEMA</a> <a href="#">PLUGINS</a> Table .....	1468
19.18. The <a href="#">INFORMATION_SCHEMA</a> <a href="#">ENGINES</a> Table .....	1469
19.19. The <a href="#">INFORMATION_SCHEMA</a> <a href="#">PARTITIONS</a> Table .....	1469
19.20. The <a href="#">INFORMATION_SCHEMA</a> <a href="#">EVENTS</a> Table .....	1471
19.21. The <a href="#">INFORMATION_SCHEMA</a> <a href="#">FILES</a> Table .....	1474
19.22. The <a href="#">INFORMATION_SCHEMA</a> <a href="#">PROCESSLIST</a> Table .....	1478
19.23. The <a href="#">INFORMATION_SCHEMA</a> <a href="#">REFERENTIAL_CONSTRAINTS</a> Table .....	1479
19.24. The <a href="#">INFORMATION_SCHEMA</a> <a href="#">GLOBAL_STATUS</a> and <a href="#">SESSION_STATUS</a> Tables .....	1480
19.25. The <a href="#">INFORMATION_SCHEMA</a> <a href="#">GLOBAL_VARIABLES</a> and <a href="#">SESSION_VARIABLES</a> Tables .....	1480
19.26. The <a href="#">INFORMATION_SCHEMA</a> <a href="#">PROFILING</a> Table .....	1480
19.27. Other <a href="#">INFORMATION_SCHEMA</a> Tables .....	1481
19.28. Extensions to <a href="#">SHOW</a> Statements .....	1481
20. Connectors and APIs .....	1484
20.1. MySQL Connector/ODBC .....	1486
20.1.1. Connector/ODBC Versions .....	1486
20.1.2. Connector/ODBC Introduction .....	1487
20.1.3. Connector/ODBC Installation .....	1490
20.1.4. Connector/ODBC Configuration .....	1507
20.1.5. Connector/ODBC Examples .....	1528
20.1.6. Connector/ODBC Reference .....	1550
20.1.7. Connector/ODBC Notes and Tips .....	1555
20.1.8. Connector/ODBC Support .....	1564
20.2. MySQL Connector/NET .....	1565
20.2.1. Connector/NET Versions .....	1566
20.2.2. Connector/NET Installation .....	1566
20.2.3. Visual Studio User Guide .....	1573
20.2.4. Connector/NET Programming .....	1604
20.2.5. Connector/NET Support .....	1630
20.2.6. Connector/NET FAQ .....	1631
20.3. MySQL Visual Studio Plugin .....	1631
20.3.1. Installing the MySQL Visual Studio Plugin .....	1631
20.3.2. Creating a connection to the MySQL server .....	1633
20.3.3. Using the MySQL Visual Studio Plugin .....	1634
20.3.4. Visual Studio Plugin Support .....	1640
20.4. MySQL Connector/J .....	1641
20.4.1. Connector/J Versions .....	1641
20.4.2. Connector/J Installation .....	1642
20.4.3. Connector/J Examples .....	1646
20.4.4. Connector/J (JDBC) Reference .....	1647
20.4.5. Connector/J Notes and Tips .....	1675
20.4.6. Connector/J Support .....	1694
20.5. MySQL Connector/MXJ .....	1696
20.5.1. Connector/MXJ Overview .....	1696
20.5.2. Connector/MXJ Versions .....	1697
20.5.3. Connector/MXJ Installation .....	1697
20.5.4. Connector/MXJ Configuration .....	1701

---

---

20.5.5. Connector/MXJ Reference .....	1704
20.5.6. Connector/MXJ Notes and Tips .....	1705
20.5.7. Connector/MXJ Support .....	1709
20.6. MySQL Connector/C++ .....	1710
20.6.1. MySQL Connector/C++ Binary Installation .....	1712
20.6.2. MySQL Connector/C++ Source Installation .....	1715
20.6.3. MySQL Connector/C++ Building Windows applications with Microsoft Visual Studio .....	1718
20.6.4. MySQL Connector/C++ Building Linux applications with NetBeans .....	1730
20.6.5. MySQL Connector/C++ Getting Started: Usage Examples .....	1735
20.6.6. MySQL Connector/C++ Debug Tracing .....	1740
20.6.7. MySQL Connector/C++ References .....	1741
20.6.8. MySQL Connector/C++ Known Bugs and Issues .....	1743
20.6.9. MySQL Connector/C++ Feature requests .....	1744
20.6.10. MySQL Connector/C++ Support .....	1744
20.6.11. MySQL Connector/C++ FAQ .....	1744
20.7. MySQL Connector/C .....	1745
20.7.1. Building MySQL Connector/C from the Source Code .....	1745
20.7.2. Testing MySQL Connector/C .....	1747
20.7.3. MySQL Connector/C FAQ .....	1748
20.8. MySQL Connector/OpenOffice.org .....	1748
20.8.1. Installation .....	1749
20.8.2. Getting Started: Connecting to MySQL .....	1750
20.8.3. Getting Started: Usage Examples .....	1752
20.8.4. References .....	1753
20.8.5. Known Bugs .....	1753
20.8.6. Contact .....	1753
20.9. libmysqld, the Embedded MySQL Server Library .....	1754
20.9.1. Compiling Programs with <code>libmysqld</code> .....	1754
20.9.2. Restrictions When Using the Embedded MySQL Server .....	1754
20.9.3. Options with the Embedded Server .....	1755
20.9.4. Embedded Server Examples .....	1755
20.9.5. Licensing the Embedded Server .....	1758
20.10. MySQL C API .....	1758
20.10.1. C API Data Types .....	1758
20.10.2. C API Function Overview .....	1762
20.10.3. C API Function Descriptions .....	1765
20.10.4. C API Prepared Statements .....	1805
20.10.5. C API Prepared Statement Data types .....	1806
20.10.6. C API Prepared Statement Function Overview .....	1810
20.10.7. C API Prepared Statement Function Descriptions .....	1813
20.10.8. C API Threaded Function Descriptions .....	1831
20.10.9. C API Embedded Server Function Descriptions .....	1832
20.10.10. Common Questions and Problems When Using the C API .....	1832
20.10.11. Controlling Automatic Reconnection Behavior .....	1834
20.10.12. C API Support for Multiple Statement Execution .....	1835
20.10.13. C API Prepared Statement Problems .....	1836
20.10.14. C API Prepared Statement Handling of Date and Time Values .....	1837
20.10.15. C API Support for Prepared <code>CALL</code> Statements .....	1837
20.10.16. Building Client Programs .....	1838
20.10.17. How to Make a Threaded Client .....	1838
20.11. MySQL PHP API .....	1839
20.11.1. MySQL .....	1840
20.11.2. MySQL Improved Extension ( <code>Mysqli</code> ) .....	1898
20.11.3. MySQL Functions (PDO_MYSQL) .....	2041
20.11.4. Connector/PHP .....	2042
20.11.5. Common Problems with MySQL and PHP .....	2042
20.11.6. Enabling Both <code>mysql</code> and <code>mysqli</code> in PHP .....	2043
20.12. MySQL Perl API .....	2043
20.13. MySQL C++ API .....	2044
20.14. MySQL Python API .....	2044
20.15. MySQL Ruby APIs .....	2044
20.15.1. The MySQL/Ruby API .....	2044
20.15.2. The Ruby/MySQL API .....	2044
20.16. MySQL Tcl API .....	2044
20.17. MySQL Eiffel Wrapper .....	2045
21. Extending MySQL .....	2046
21.1. MySQL Internals .....	2046
21.1.1. MySQL Threads .....	2046
21.1.2. MySQL Test Suite .....	2046
21.2. The MySQL Plugin Interface .....	2047

---

---

21.2.1. Characteristics of the Plugin Interface .....	2047
21.2.2. Full-Text Parser Plugins .....	2048
21.2.3. Writing Plugins .....	2049
21.3. Adding New Functions to MySQL .....	2060
21.3.1. Features of the User-Defined Function Interface .....	2061
21.3.2. Adding a New User-Defined Function .....	2061
21.3.3. Adding a New Native Function .....	2069
21.4. Adding New Procedures to MySQL .....	2070
21.4.1. <code>PROCEDURE ANALYSE</code> .....	2070
21.4.2. Writing a Procedure .....	2071
21.5. Debugging and Porting MySQL .....	2071
21.5.1. Debugging a MySQL Server .....	2072
21.5.2. Debugging a MySQL Client .....	2077
21.5.3. The DBUG Package .....	2077
21.5.4. Comments about RTS Threads .....	2078
21.5.5. Differences Between Thread Packages .....	2079
A. MySQL 5.1 Frequently Asked Questions .....	2080
A.1. MySQL 5.1 FAQ — General .....	2080
A.2. MySQL 5.1 FAQ — Storage Engines .....	2081
A.3. MySQL 5.1 FAQ — Server SQL Mode .....	2082
A.4. MySQL 5.1 FAQ — Stored Procedures and Functions .....	2083
A.5. MySQL 5.1 FAQ — Triggers .....	2086
A.6. MySQL 5.1 FAQ — Views .....	2088
A.7. MySQL 5.0 FAQ — <code>INFORMATION_SCHEMA</code> .....	2088
A.8. MySQL 5.1 FAQ — Migration .....	2089
A.9. MySQL 5.1 FAQ — Security .....	2090
A.10. MySQL 5.1 FAQ — MySQL Cluster .....	2091
A.11. MySQL 5.1 FAQ — MySQL Chinese, Japanese, and Korean Character Sets .....	2100
A.12. MySQL 5.1 FAQ — Connectors & APIs .....	2109
A.13. MySQL 5.1 FAQ — Replication .....	2109
A.14. MySQL 5.1 FAQ — MySQL, DRBD, and Heartbeat .....	2109
A.14.1. Distributed Replicated Block Device (DRBD) .....	2109
A.14.2. Linux Heartbeat .....	2110
A.14.3. DRBD Architecture .....	2111
A.14.4. DRBD and MySQL Replication .....	2112
A.14.5. DRBD and File Systems .....	2113
A.14.6. DRBD and LVM .....	2113
A.14.7. DRBD and Virtualization .....	2114
A.14.8. DRBD and Security .....	2114
A.14.9. DRBD and System Requirements .....	2114
A.14.10. DRBD and Support and Consulting .....	2115
B. Errors, Error Codes, and Common Problems .....	2117
B.1. Problems and Common Errors .....	2117
B.1.1. How to Determine What Is Causing a Problem .....	2117
B.1.2. Common Errors When Using MySQL Programs .....	2118
B.1.3. Installation-Related Issues .....	2129
B.1.4. Administration-Related Issues .....	2130
B.1.5. Query-Related Issues .....	2136
B.1.6. Optimizer-Related Issues .....	2141
B.1.7. Table Definition-Related Issues .....	2141
B.1.8. Known Issues in MySQL .....	2143
B.2. Types of Error Values .....	2166
B.3. Server Error Codes and Messages .....	2166
B.4. Client Error Codes and Messages .....	2202
C. MySQL Change History .....	2207
C.1. Changes in release 5.1.x-maria (Development) .....	2207
C.1.1. Changes in MySQL 5.1.27-maria (Not yet released) .....	2207
C.1.2. Changes in MySQL 5.1.26-maria (Not yet released) .....	2207
C.1.3. Changes in MySQL 5.1.25-maria (Not yet released) .....	2207
C.1.4. Changes in MySQL 5.1.24-maria (Not yet released) .....	2208
C.2. Changes in release 5.1.x (Production) .....	2208
C.2.1. Changes in MySQL 5.1.36 (Not yet released) .....	2208
C.2.2. Changes in MySQL 5.1.35 (Not yet released) .....	2210
C.2.3. Changes in MySQL 5.1.34 (02 April 2009) .....	2212
C.2.4. Changes in MySQL 5.1.33 (13 March 2009) .....	2213
C.2.5. Changes in MySQL 5.1.32 (14 February 2009) .....	2217
C.2.6. Release Notes for MySQL Enterprise 5.1.31sp1 [QSP] (19 March 2009) .....	2219
C.2.7. Changes in MySQL 5.1.31 (19 January 2009) .....	2220
C.2.8. Changes in MySQL 5.1.30 (14 November 2008 General Availability) .....	2226
C.2.9. Changes in MySQL 5.1.29 (11 October 2008) .....	2226

---

---

C.2.10. Changes in MySQL 5.1.28 (28 August 2008)	2229
C.2.11. Changes in MySQL 5.1.27 (Not released)	2233
C.2.12. Changes in MySQL 5.1.26 (30 June 2008)	2233
C.2.13. Changes in MySQL 5.1.25 (28 May 2008)	2234
C.2.14. Changes in MySQL 5.1.24 (08 April 2008)	2237
C.2.15. Changes in MySQL 5.1.23 (29 January 2008)	2249
C.2.16. Changes in MySQL 5.1.22 (24 September 2007 Release Candidate)	2270
C.2.17. Changes in MySQL 5.1.21 (16 August 2007)	2271
C.2.18. Changes in MySQL 5.1.20 (25 June 2007)	2281
C.2.19. Changes in MySQL 5.1.19 (25 May 2007)	2288
C.2.20. Changes in MySQL 5.1.18 (08 May 2007)	2292
C.2.21. Changes in MySQL 5.1.17 (04 April 2007)	2302
C.2.22. Changes in MySQL 5.1.16 (26 February 2007)	2309
C.2.23. Changes in MySQL 5.1.15 (25 January 2007)	2313
C.2.24. Changes in MySQL 5.1.14 (05 December 2006)	2321
C.2.25. Changes in MySQL 5.1.13 (Not released)	2325
C.2.26. Changes in MySQL 5.1.12 (24 October 2006)	2329
C.2.27. Changes in MySQL 5.1.11 (26 May 2006)	2354
C.2.28. Changes in MySQL 5.1.10 (Not released)	2357
C.2.29. Changes in MySQL 5.1.9 (12 April 2006)	2363
C.2.30. Changes in MySQL 5.1.8 (Not released)	2365
C.2.31. Changes in MySQL 5.1.7 (27 February 2006)	2372
C.2.32. Changes in MySQL 5.1.6 (01 February 2006)	2376
C.2.33. Changes in MySQL 5.1.5 (10 January 2006)	2379
C.2.34. Changes in MySQL 5.1.4 (21 December 2005)	2380
C.2.35. Changes in MySQL 5.1.3 (29 November 2005)	2382
C.2.36. Changes in MySQL 5.1.2 (Not released)	2383
C.2.37. Changes in MySQL 5.1.1 (Not released)	2383
C.3. MySQL Enterprise Monitor Change History	2383
C.3.1. Changes in MySQL Enterprise Monitor 2.1.0 (Not yet released)	2383
C.3.2. Changes in MySQL Enterprise Monitor 2.0.6 (Not yet released)	2387
C.3.3. Changes in MySQL Enterprise Monitor 2.0.5 (18th March 2009)	2387
C.3.4. Changes in MySQL Enterprise Monitor 2.0.4 (5th February 2009)	2391
C.3.5. Changes in MySQL Enterprise Monitor 2.0.3 (23rd January 2009)	2393
C.3.6. Changes in MySQL Enterprise Monitor 2.0.2 (14th January 2009)	2393
C.3.7. Changes in MySQL Enterprise Monitor 2.0.1 (15th December 2008)	2394
C.3.8. Changes in MySQL Enterprise Monitor 2.0.0 (11th December 2008)	2395
C.4. MySQL Connector/ODBC (MyODBC) Change History	2400
C.4.1. Changes in MySQL Connector/ODBC 5.1.6 (Not yet released)	2400
C.4.2. Changes in MySQL Connector/ODBC 5.1.5 (18 August 2008)	2401
C.4.3. Changes in MySQL Connector/ODBC 5.1.4 (15 April 2008)	2402
C.4.4. Changes in MySQL Connector/ODBC 5.1.3 (26 March 2008)	2402
C.4.5. Changes in MySQL Connector/ODBC 5.1.2 (13 February 2008)	2403
C.4.6. Changes in MySQL Connector/ODBC 5.1.1 (13 December 2007)	2404
C.4.7. Changes in MySQL Connector/ODBC 5.1.0 (10 September 2007)	2405
C.4.8. Changes in MySQL Connector/ODBC 5.0.12 (Never released)	2406
C.4.9. Changes in MySQL Connector/ODBC 5.0.11 (31 January 2007)	2406
C.4.10. Changes in MySQL Connector/ODBC 5.0.10 (14 December 2006)	2406
C.4.11. Changes in MySQL Connector/ODBC 5.0.9 (22 November 2006)	2407
C.4.12. Changes in MySQL Connector/ODBC 5.0.8 (17 November 2006)	2407
C.4.13. Changes in MySQL Connector/ODBC 5.0.7 (08 November 2006)	2408
C.4.14. Changes in MySQL Connector/ODBC 5.0.6 (03 November 2006)	2408
C.4.15. Changes in MySQL Connector/ODBC 5.0.5 (17 October 2006)	2409
C.4.16. Changes in Connector/ODBC 5.0.3 (Connector/ODBC 5.0 Alpha 3) (20 June 2006)	2409
C.4.17. Changes in Connector/ODBC 5.0.2 (Never released)	2409
C.4.18. Changes in Connector/ODBC 5.0.1 (Connector/ODBC 5.0 Alpha 2) (05 June 2006)	2409
C.4.19. Changes in MySQL Connector/ODBC 3.51.27 (20 November 2008)	2410
C.4.20. Changes in MySQL Connector/ODBC 3.51.26 (07 July 2008)	2411
C.4.21. Changes in MySQL Connector/ODBC 3.51.25 (11 April 2008)	2411
C.4.22. Changes in MySQL Connector/ODBC 3.51.24 (14 March 2008)	2411
C.4.23. Changes in MySQL Connector/ODBC 3.51.23 (09 January 2008)	2412
C.4.24. Changes in MySQL Connector/ODBC 3.51.22 (13 November 2007)	2412
C.4.25. Changes in MySQL Connector/ODBC 3.51.21 (08 October 2007)	2413
C.4.26. Changes in MySQL Connector/ODBC 3.51.20 (10 September 2007)	2413
C.4.27. Changes in MySQL Connector/ODBC 3.51.19 (10 August 2007)	2414
C.4.28. Changes in MySQL Connector/ODBC 3.51.18 (08 August 2007)	2414
C.4.29. Changes in MySQL Connector/ODBC 3.51.17 (14 July 2007)	2415
C.4.30. Changes in MySQL Connector/ODBC 3.51.16 (14 June 2007)	2416
C.4.31. Changes in MySQL Connector/ODBC 3.51.15 (07 May 2007)	2417
C.4.32. Changes in MySQL Connector/ODBC 3.51.14 (08 March 2007)	2417

---

---

C.4.33. Changes in MySQL Connector/ODBC 3.51.13 (Never released) .....	2418
C.4.34. Changes in MySQL Connector/ODBC 3.51.12 (11 February 2005) .....	2418
C.4.35. Changes in MySQL Connector/ODBC 3.51.11 (28 January 2005) .....	2418
C.5. MySQL Connector/NET Change History .....	2418
C.5.1. Changes in MySQL Connector/NET 6.0.4 (Not yet released beta) .....	2418
C.5.2. Changes in MySQL Connector/NET 6.0.3 (28 April 2009 beta) .....	2419
C.5.3. Changes in MySQL Connector/NET 6.0.2 (07 April 2009 beta) .....	2420
C.5.4. Changes in MySQL Connector/NET 6.0.1 (02 April 2009 beta) .....	2420
C.5.5. Changes in MySQL Connector/NET 6.0.0 (02 March 2009 alpha) .....	2420
C.5.6. Changes in MySQL Connector/NET 5.3.0 (Not yet released) .....	2420
C.5.7. Changes in MySQL Connector/NET 5.2.7 (Not yet released) .....	2420
C.5.8. Changes in MySQL Connector/NET 5.2.6 (28 April 2009) .....	2421
C.5.9. Changes in MySQL Connector/NET 5.2.5 (19 November 2008) .....	2422
C.5.10. Changes in MySQL Connector/NET 5.2.4 (13 November 2008) .....	2422
C.5.11. Changes in MySQL Connector/NET 5.2.3 (19 August 2008) .....	2423
C.5.12. Changes in MySQL Connector/NET 5.2.2 (12 May 2008) .....	2424
C.5.13. Changes in MySQL Connector/NET 5.2.1 (27 February 2008) .....	2425
C.5.14. Changes in MySQL Connector/NET 5.2.0 (11 February 2008) .....	2425
C.5.15. Changes in MySQL Connector/NET 5.1.8 (Not yet released) .....	2426
C.5.16. Changes in MySQL Connector/NET 5.1.7 (21 August 2008) .....	2426
C.5.17. Changes in MySQL Connector/NET 5.1.6 (12 May 2008) .....	2427
C.5.18. Changes in MySQL Connector/NET 5.1.5 (Not yet released) .....	2428
C.5.19. Changes in MySQL Connector/NET 5.1.4 (20 November 2007) .....	2428
C.5.20. Changes in MySQL Connector/NET 5.1.3 (21 September 2007 beta) .....	2429
C.5.21. Changes in MySQL Connector/NET 5.1.2 (18 June 2007) .....	2430
C.5.22. Changes in MySQL Connector/NET 5.1.1 (23 May 2007) .....	2430
C.5.23. Changes in MySQL Connector/NET 5.1.0 (01 May 2007) .....	2430
C.5.24. Changes in MySQL Connector/NET 5.0.10 (Not yet released) .....	2430
C.5.25. Changes in MySQL Connector/NET 5.0.9 (Not yet released) .....	2431
C.5.26. Changes in MySQL Connector/NET 5.0.8 (21 August 2007) .....	2432
C.5.27. Changes in MySQL Connector/NET 5.0.7 (18 May 2007) .....	2432
C.5.28. Changes in MySQL Connector/NET 5.0.6 (22 March 2007) .....	2433
C.5.29. Changes in MySQL Connector/NET 5.0.5 (07 March 2007) .....	2433
C.5.30. Changes in MySQL Connector/NET 5.0.4 (Not released) .....	2434
C.5.31. Changes in MySQL Connector/NET 5.0.3 (05 January 2007) .....	2434
C.5.32. Changes in MySQL Connector/NET 5.0.2 (06 November 2006) .....	2435
C.5.33. Changes in MySQL Connector/NET 5.0.1 (01 October 2006) .....	2436
C.5.34. Changes in MySQL Connector/NET 5.0.0 (08 August 2006) .....	2436
C.5.35. Changes in MySQL Connector/NET 1.0.11 (Not yet released) .....	2437
C.5.36. Changes in MySQL Connector/NET 1.0.10 (24 August 2007) .....	2437
C.5.37. Changes in MySQL Connector/NET 1.0.9 (02 February 2007) .....	2438
C.5.38. Changes in MySQL Connector/NET 1.0.8 (20 October 2006) .....	2439
C.5.39. Changes in MySQL Connector/NET 1.0.7 (21 November 2005) .....	2440
C.5.40. Changes in MySQL Connector/NET 1.0.6 (03 October 2005) .....	2440
C.5.41. Changes in MySQL Connector/NET 1.0.5 (29 August 2005) .....	2440
C.5.42. Changes in MySQL Connector/NET 1.0.4 (20 January 2005) .....	2441
C.5.43. Changes in MySQL Connector/NET 1.0.3 (12 October 2004 gamma) .....	2441
C.5.44. Changes in MySQL Connector/NET 1.0.2 (15 November 2004 gamma) .....	2442
C.5.45. Changes in MySQL Connector/NET 1.0.1 (27 October 2004 beta) .....	2442
C.5.46. Changes in MySQL Connector/NET 1.0.0 (01 September 2004) .....	2444
C.5.47. Changes in MySQL Connector/NET Version 0.9.0 (30 August 2004) .....	2444
C.5.48. Changes in MySQL Connector/NET Version 0.76 .....	2447
C.5.49. Changes in MySQL Connector/NET Version 0.75 .....	2447
C.5.50. Changes in MySQL Connector/NET Version 0.74 .....	2448
C.5.51. Changes in MySQL Connector/NET Version 0.71 .....	2450
C.5.52. Changes in MySQL Connector/NET Version 0.70 .....	2450
C.5.53. Changes in MySQL Connector/NET Version 0.68 .....	2451
C.5.54. Changes in MySQL Connector/NET Version 0.65 .....	2452
C.5.55. Changes in MySQL Connector/NET Version 0.60 .....	2452
C.5.56. Changes in MySQL Connector/NET Version 0.50 .....	2452
C.6. MySQL Visual Studio Plugin Change History .....	2452
C.6.1. Changes in MySQL Visual Studio Plugin 1.0.3 (Not yet released) .....	2452
C.6.2. Changes in MySQL Visual Studio Plugin 1.0.2 (Not yet released) .....	2453
C.6.3. Changes in MySQL Visual Studio Plugin 1.0.1 (4 October 2006) .....	2453
C.6.4. Changes in MySQL Visual Studio Plugin 1.0.0 (4 October 2006) .....	2453
C.7. MySQL Connector/J Change History .....	2453
C.7.1. Changes in MySQL Connector/J 5.1.x .....	2453
C.7.2. Changes in MySQL Connector/J 5.0.x .....	2462
C.7.3. Changes in MySQL Connector/J 3.1.x .....	2471
C.7.4. Changes in MySQL Connector/J 3.0.x .....	2488

---



---

C.7.5. Changes in MySQL Connector/J 2.0.x .....	2499
C.7.6. Changes in MySQL Connector/J 1.2b (04 July 1999) .....	2503
C.7.7. Changes in MySQL Connector/J 1.2.x and lower .....	2504
C.8. MySQL Connector/MXJ Change History .....	2507
C.8.1. Changes in MySQL Connector/MXJ 5.0.6 (04 May 2007) .....	2507
C.8.2. Changes in MySQL Connector/MXJ 5.0.5 (14 March 2007) .....	2508
C.8.3. Changes in MySQL Connector/MXJ 5.0.4 (28 January 2007) .....	2509
C.8.4. Changes in MySQL Connector/MXJ 5.0.3 (24 June 2006) .....	2509
C.8.5. Changes in MySQL Connector/MXJ 5.0.2 (15 June 2006) .....	2509
C.8.6. Changes in MySQL Connector/MXJ 5.0.1 (Never released) .....	2510
C.8.7. Changes in MySQL Connector/MXJ 5.0.0 (09 December 2005) .....	2510
C.9. MySQL Proxy Change History .....	2511
C.9.1. Changes in MySQL Proxy 0.7.0 (Not yet released) .....	2511
C.9.2. Changes in MySQL Proxy 0.6.1 (06 February 2008) .....	2511
C.9.3. Changes in MySQL Proxy 0.6.0 (11 September 2007) .....	2511
C.9.4. Changes in MySQL Proxy 0.5.1 (30 June 2007) .....	2512
C.9.5. Changes in MySQL Proxy 0.5.0 (19 June 2007) .....	2512
D. Restrictions and Limits .....	2514
D.1. Restrictions on Stored Routines, Triggers, and Events .....	2514
D.2. Restrictions on Server-Side Cursors .....	2517
D.3. Restrictions on Subqueries .....	2517
D.4. Restrictions on Views .....	2519
D.5. Restrictions on XA Transactions .....	2521
D.6. Restrictions on Character Sets .....	2521
D.7. Limits in MySQL .....	2521
D.7.1. Limits of Joins .....	2521
D.7.2. The Maximum Number of Columns Per Table .....	2522
D.7.3. Windows Platform Limitations .....	2523
Index .....	2524



---

## List of Figures

13.1. The MySQL architecture using pluggable storage engines .....	1019
13.2. <b>FEDERATED</b> table structure .....	1111
14.1. DRBD Architecture Overview .....	1123
14.2. DRBD Architecture Using Separate Network Interfaces .....	1132
14.3. Heartbeat Architecture .....	1135
14.4. <b>memcached</b> Architecture Overview .....	1150
14.5. Memory Allocation in <b>memcached</b> .....	1162
14.6. Typical <b>memcached</b> Application Flowchart .....	1164
15.1. MySQL Enterprise Monitor Architecture .....	1212
15.2. MySQL Enterprise Monitor: Installing Monitor on Windows: Language Selection .....	1219
15.3. MySQL Enterprise Monitor: Installing Monitor on Windows: Installation Directory .....	1220
15.4. MySQL Enterprise Monitor: Installing Monitor on Windows: Tomcat Server Options .....	1220
15.5. MySQL Enterprise Monitor: Installing Monitor on Windows: Repository Configuration .....	1221
15.6. MySQL Enterprise Monitor: Installing Monitor on OS X: Language Selection .....	1223
15.7. MySQL Enterprise Monitor: Installing Monitor on OS X: Java Selection .....	1223
15.8. MySQL Enterprise Monitor: Installing Monitor on OS X: Installation Directory .....	1223
15.9. MySQL Enterprise Monitor: Installing Monitor on OS X: Tomcat Server Options .....	1224
15.10. MySQL Enterprise Monitor: Installing Monitor on OS X: Repository Configuration .....	1225
15.11. MySQL Enterprise Monitor: Initial dashboard log-in .....	1230
15.12. MySQL Enterprise Monitor: Outgoing email settings .....	1233
15.13. MySQL Enterprise Monitor: Installing Agent on Windows: Language Selection .....	1235
15.14. MySQL Enterprise Monitor: Installing Agent on Windows: Installation Directory .....	1235
15.15. MySQL Enterprise Monitor: Installing Agent on Windows: Monitored Database Information .....	1236
15.16. MySQL Enterprise Monitor: Installing Agent on Windows: Query Analyzer Configuration .....	1237
15.17. MySQL Enterprise Monitor: Installing Agent on Windows: MySQL Enterprise Service Manager Options .....	1238
15.18. MySQL Enterprise Monitor: Installing Agent on Mac OS X: Language Selection .....	1239
15.19. MySQL Enterprise Monitor: Installing Agent on Mac OS X: Installation Directory .....	1240
15.20. MySQL Enterprise Monitor: Installing Agent on Mac OS X: Monitored Database Information .....	1241
15.21. MySQL Enterprise Monitor: Installing Agent on Mac OS X: Monitored Database Information .....	1242
15.22. MySQL Enterprise Monitor: Installing Agent on Mac OS X: Query Analyzer Configuration .....	1243
15.23. MySQL Enterprise Monitor: Installing Agent on Mac OS X: MySQL Enterprise Service Manager Options .....	1244
15.24. MySQL Enterprise Monitor: Server Update: Language Selection .....	1264
15.25. MySQL Enterprise Monitor: Server Update: Previous Installation .....	1265
15.26. MySQL Enterprise Monitor: Server Update: Backup of Previous Installation .....	1265
15.27. MySQL Enterprise Monitor: Server Update: Server Update: Completed installing files .....	1266
15.28. MySQL Enterprise Monitor: Server Update: Final Setup .....	1267
15.29. MySQL Enterprise Monitor: Historical Data Migration Availability .....	1276
15.30. MySQL Enterprise Monitor: Confirming Historical Data Migration .....	1276
15.31. MySQL Enterprise Monitor: Historical Data Migration Progress .....	1277
15.32. MySQL Enterprise Dashboard: The Graphs screen .....	1280
15.33. MySQL Enterprise Dashboard: The Heat Chart .....	1281
15.34. MySQL Enterprise Dashboard: The Heat Chart legend .....	1282
15.35. MySQL Enterprise Dashboard: Settings .....	1283
15.36. MySQL Enterprise Dashboard: User Preferences .....	1286
15.37. MySQL Enterprise Dashboard: Manage Servers .....	1287
15.38. MySQL Enterprise Dashboard: Server Renaming .....	1287
15.39. MySQL Enterprise Dashboard: Manage Users .....	1289
15.40. MySQL Enterprise Dashboard: Manage Notification Groups .....	1289
15.41. MySQL Enterprise Dashboard: Logs .....	1290
15.42. MySQL Enterprise Dashboard: Scheduling Dialog .....	1293
15.43. MySQL Enterprise Dashboard: Editing Rules .....	1295
15.44. MySQL Enterprise Dashboard: Events screen .....	1304
15.45. MySQL Enterprise Dashboard: Query Analyzer .....	1307
15.46. MySQL Enterprise Dashboard: Standard agent/monitor topology .....	1310
15.47. MySQL Enterprise Dashboard: Query Analyzer agent/monitor topology .....	1310
15.48. MySQL Enterprise Dashboard: Canonical Query Tab for a Query .....	1312
15.49. MySQL Enterprise Dashboard: Example Query Tab for a Query .....	1314
15.50. MySQL Enterprise Dashboard: Explain Query Tab for a Query .....	1315
15.51. MySQL Enterprise Dashboard: Query Analyzer Configuration .....	1317
15.52. MySQL Enterprise Dashboard: Replication groups .....	1319
16.1. Using replication to improve the performance during scaleout .....	1371
16.2. Using replication to replicate databases to separate replication slaves .....	1372
16.3. Using an additional replication host to improve performance .....	1374
16.4. Redundancy using replication, initial structure .....	1375

16.5. Redundancy using replication, after master failure .....	1376
20.1. Add Connection Context Menu .....	1574
20.2. Choose Data Source .....	1574
20.3. Add Connection Dialog .....	1575
20.4. New Data Connection .....	1575
20.5. Editing New Table .....	1576
20.6. Choose Table Name .....	1577
20.7. Newly Created Table .....	1578
20.8. Table Designer Main Menu .....	1578
20.9. Indexes Dialog .....	1579
20.10. Foreign Key Relationships Dialog .....	1580
20.11. Table Properties Menu Item .....	1580
20.12. Table Properties .....	1581
20.13. Editing View SQL .....	1582
20.14. View SQL Added .....	1582
20.15. View SQL Saved .....	1583
20.16. Edit Stored Procedure SQL .....	1583
20.17. Stored Procedure SQL Saved .....	1585
20.18. Add Entity Data Model .....	1587
20.19. Entity Data Model Wizard Screen 1 .....	1587
20.20. Entity Data Model Wizard Screen 2 .....	1588
20.21. Entity Data Model Wizard Screen 3 .....	1589
20.22. Entity Data Model Diagram .....	1590
20.23. Entity Data Source Configuration Wizard Screen 1 .....	1591
20.24. Entity Data Source Configuration Wizard Screen 2 .....	1592
20.25. Entity Data Source Configuration Wizard Screen 3 .....	1593
20.26. Data Sources .....	1594
20.27. Data Form Designer .....	1596
20.28. Adding Code to the Form .....	1596
20.29. The Populated Grid Control .....	1597
20.30. Save Button Enabled .....	1598
20.31. Adding Save Code to the Form .....	1598
20.32. The Design Tab .....	1599
20.33. Drop Down List .....	1600
20.34. Enable AutoPostBack .....	1600
20.35. Grid View Control .....	1601
20.36. Placed Grid View Control .....	1601
20.37. Source Code .....	1602
20.38. The Working Web Site .....	1603
20.39. World Database Application .....	1609
20.40. Windows Installer Welcome Screen .....	1713
20.41. Windows Installer Overview Screen .....	1713
20.42. Windows Installer Custom Setup Screen .....	1714
20.43. Creating a new project .....	1719
20.44. The New Project dialog box .....	1719
20.45. The Win32 Application Wizard .....	1720
20.46. Selecting the Release build .....	1721
20.47. Selecting Project Properties from the main menu .....	1721
20.48. Setting properties .....	1722
20.49. MySQL include directory .....	1723
20.50. Select Directory dialog .....	1724
20.51. Typical contents of MySQL lib/opt directory .....	1725
20.52. Additional Library Directories .....	1726
20.53. Additional Library Directories dialog .....	1726
20.54. ....	1727
20.55. Adding additional dependencies .....	1728
20.56. Setting the CPPCONN_PUBLIC_FUNC define .....	1729
20.57. The NetBeans IDE .....	1730
20.58. Setting the header include directory .....	1732
20.59. Setting the static library directories and file names .....	1732
20.60. Setting the dynamic library directory and file name .....	1733
20.61. The example application running .....	1734
20.62. Adding an extension .....	1749
20.63. Selecting the database .....	1750
20.64. Entering connection settings .....	1751
20.65. Setting up user authentication .....	1751
20.66. Entering user credentials .....	1752
20.67. Listing tables .....	1753
A.1. Active-Master MySQL server .....	2112

---

## List of Tables

1. Topic Quick Reference .....	2
2.1. Build ( <code>configure</code> ) Reference .....	85
4.1. <code>mysqld_safe</code> Option Reference .....	195
4.2. <code>mysql</code> Option Reference .....	209
4.3. <code>mysqladmin</code> Option Reference .....	227
4.4. <code>mysqlcheck</code> Option Reference .....	231
4.5. <code>mysqldump</code> Option Reference .....	236
4.6. <code>mysqlimport</code> Option Reference .....	248
4.7. <code>mysqlshow</code> Option Reference .....	252
4.8. <code>mysqlslap</code> Option Reference .....	255
4.9. <code>myisamchk</code> Option Reference .....	263
4.10. <code>mysqlaccess</code> Option Reference .....	276
4.11. <code>mysqlbinlog</code> Option Reference .....	279
4.12. <code>mysqldumpslow</code> Option Reference .....	288
4.13. <code>mysqlhotcopy</code> Option Reference .....	290
5.1. <code>mysqld</code> Option/Variable Summary .....	312
5.2. <code>mysqld</code> System Variable Summary .....	352
5.3. <code>mysqld</code> Session System Variable Summary .....	415
5.4. <code>mysqld</code> Security Option/Variable Summary .....	466
5.5. <code>mysqld</code> SSL Option/Variable Summary .....	499
13.1. MyISAM Features .....	1024
13.2. <code>mysqld</code> MyISAM Option/Variable Reference .....	1026
13.3. <code>mysqld</code> Option/Variable Reference .....	1032
13.4. InnoDB Features .....	1043
13.5. <code>mysqld</code> InnoDB Option/Variable Reference .....	1050
13.6. Memory Features .....	1108
13.7. Archive Features .....	1115
14.1. <code>memcached</code> Command Reference .....	1184
14.2. <code>memcached</code> Protocol Responses .....	1185
15.1. MySQL Enterprise Monitor: Wiki formatting .....	1300
16.1. <code>mysqld</code> Replication Option/Variable Summary .....	1343
16.2. <code>mysqld</code> Binary Logging Option/Variable Summary .....	1345
20.1. MySQL APIs and Interfaces .....	1485
20.2. MySQL Connector versions and MySQL Server versions .....	1485
20.3. Mapping of MySQL Error Numbers to SQLStates .....	1665
20.4. MySQL Configuration Options .....	1841
20.5. MySQL client constants .....	1842
20.6. MySQL fetch constants .....	1842
20.7. MySQLi Configuration Options .....	1901
20.8. Possible <code>mysqli_info</code> return values .....	1937
20.9. Valid options .....	1945
20.10. Supported flags .....	1952
20.11. Attribute values .....	1978
20.12. Type specification chars .....	1979
20.13. Return Values .....	1991
20.14. Object attributes .....	2015
20.15. Object properties .....	2017
20.16. Object properties .....	2019
20.17. Supported flags .....	2038

---

## List of Examples

20.1. Connector/J: Obtaining a connection from the <code>DriverManager</code> .....	1675
20.2. Connector/J: Using <code>java.sql.Statement</code> to execute a <code>SELECT</code> query .....	1676
20.3. Connector/J: Calling Stored Procedures .....	1677
20.4. Connector/J: Using <code>Connection.prepareStatement()</code> .....	1677
20.5. Connector/J: Registering output parameters .....	1678
20.6. Connector/J: Setting <code>CallableStatement</code> input parameters .....	1678
20.7. Connector/J: Retrieving results and output parameter values .....	1679
20.8. Connector/J: Retrieving <code>AUTO_INCREMENT</code> column values using <code>Statement.getGeneratedKeys()</code> ....	1679
20.9. Connector/J: Retrieving <code>AUTO_INCREMENT</code> column values using <code>SELECT LAST_INSERT_ID()</code> .....	1680
20.10. Connector/J: Retrieving <code>AUTO_INCREMENT</code> column values in <code>Updatable ResultSets</code> .....	1681
20.11. Connector/J: Using a connection pool with a J2EE application server .....	1683
20.12. Connector/J: Example of transaction with retry logic .....	1692
20.13. MySQL extension overview example .....	1843
20.14. <code>mysql_affected_rows</code> example .....	1844
20.15. <code>mysql_affected_rows</code> example using transactions .....	1844
20.16. <code>mysql_client_encoding</code> example .....	1846
20.17. <code>mysql_close</code> example .....	1847
20.18. <code>mysql_connect</code> example .....	1849
20.19. <code>mysql_connect</code> example using <code>hostname:port</code> syntax .....	1849
20.20. <code>mysql_connect</code> example using <code>"/path/to/socket"</code> syntax .....	1849
20.21. <code>mysql_create_db</code> alternative example .....	1850
20.22. <code>mysql_data_seek</code> example .....	1852
20.23. <code>mysql_db_name</code> example .....	1853
20.24. <code>mysql_db_query</code> alternative example .....	1854
20.25. <code>mysql_drop_db</code> alternative example .....	1855
20.26. <code>mysql_errno</code> example .....	1856
20.27. <code>mysql_error</code> example .....	1857
20.28. <code>mysql_escape_string</code> example .....	1858
20.29. Query with aliased duplicate field names .....	1859
20.30. <code>mysql_fetch_array</code> with <code>MYSQL_NUM</code> .....	1859
20.31. <code>mysql_fetch_array</code> with <code>MYSQL_ASSOC</code> .....	1859
20.32. <code>mysql_fetch_array</code> with <code>MYSQL_BOTH</code> .....	1860
20.33. An expanded <code>mysql_fetch_assoc</code> example .....	1861
20.34. <code>mysql_fetch_field</code> example .....	1863
20.35. A <code>mysql_fetch_lengths</code> example .....	1864
20.36. <code>mysql_fetch_object</code> example .....	1865
20.37. <code>mysql_fetch_object</code> example .....	1865
20.38. Fetching one row with <code>mysql_fetch_row</code> .....	1866
20.39. A <code>mysql_field_flags</code> example .....	1867
20.40. <code>mysql_field_len</code> example .....	1868
20.41. <code>mysql_field_name</code> example .....	1869
20.42. A <code>mysql_field_table</code> example .....	1871
20.43. <code>mysql_field_type</code> example .....	1872
20.44. A <code>mysql_free_result</code> example .....	1873
20.45. <code>mysql_get_client_info</code> example .....	1874
20.46. <code>mysql_get_host_info</code> example .....	1875
20.47. <code>mysql_get_proto_info</code> example .....	1875
20.48. <code>mysql_get_server_info</code> example .....	1876
20.49. Relevant MySQL Statements .....	1877
20.50. <code>mysql_insert_id</code> example .....	1878
20.51. <code>mysql_list_dbs</code> example .....	1879
20.52. Alternate to deprecated <code>mysql_list_fields</code> .....	1880
20.53. <code>mysql_list_processes</code> example .....	1881
20.54. <code>mysql_list_tables</code> alternative example .....	1883
20.55. A <code>mysql_num_fields</code> example .....	1884
20.56. <code>mysql_num_rows</code> example .....	1884
20.57. A <code>mysql_ping</code> example .....	1887
20.58. Invalid Query .....	1888
20.59. Valid Query .....	1888
20.60. Simple <code>mysql_real_escape_string</code> example .....	1889
20.61. An example SQL Injection Attack .....	1889
20.62. A "Best Practice" query .....	1890
20.63. <code>mysql_result</code> example .....	1892
20.64. <code>mysql_select_db</code> example .....	1892

---

20.65. <code>mysql_stat</code> example .....	1894
20.66. Alternative <code>mysql_stat</code> example .....	1894
20.67. <code>mysql_tablename</code> example .....	1896
20.68. <code>mysql_thread_id</code> example .....	1896
20.69. Object oriented style .....	1911
20.70. Procedural style .....	1912
20.71. Object oriented style .....	1913
20.72. Procedural style .....	1914
20.73. Object oriented style .....	1915
20.74. Procedural style .....	1915
20.75. Object oriented style .....	1917
20.76. Procedural style .....	1917
20.77. Object oriented style .....	1919
20.78. Procedural style .....	1919
20.79. <code>mysqli_connect_errno</code> example .....	1920
20.80. <code>mysqli_connect_error</code> example .....	1921
20.81. Object oriented style .....	1922
20.82. Procedural style .....	1922
20.83. Generating a Trace File .....	1923
20.84. Object oriented style .....	1925
20.85. Procedural style .....	1925
20.86. Object oriented style .....	1926
20.87. Procedural style .....	1926
20.88. Object oriented style .....	1928
20.89. Procedural style .....	1928
20.90. Object oriented style .....	1929
20.91. Procedural style .....	1929
20.92. <code>mysqli_get_client_info</code> .....	1930
20.93. <code>mysqli_get_client_version</code> .....	1931
20.94. Object oriented style .....	1932
20.95. Procedural style .....	1932
20.96. Object oriented style .....	1933
20.97. Procedural style .....	1933
20.98. Object oriented style .....	1934
20.99. Procedural style .....	1934
20.100. Object oriented style .....	1936
20.101. Procedural style .....	1936
20.102. Object oriented style .....	1937
20.103. Procedural style .....	1938
20.104. Object oriented style .....	1940
20.105. Procedural style .....	1940
20.106. Object oriented style .....	1941
20.107. Procedural style .....	1941
20.108. Object oriented style .....	1943
20.109. Procedural style .....	1944
20.110. Object oriented style .....	1947
20.111. Procedural style .....	1947
20.112. Object oriented style .....	1948
20.113. Procedural style .....	1949
20.114. Object oriented style .....	1950
20.115. Procedural style .....	1951
20.116. Object oriented style .....	1953
20.117. Procedural style .....	1953
20.118. Object oriented style .....	1954
20.119. Procedural style .....	1955
20.120. Object oriented style .....	1956
20.121. Procedural style .....	1957
20.122. Object oriented style .....	1958
20.123. Procedural style .....	1959
20.124. Object oriented style .....	1960
20.125. Procedural style .....	1961
20.126. Object oriented style .....	1962
20.127. Procedural style .....	1963
20.128. Object oriented style .....	1964
20.129. Procedural style .....	1964
20.130. Object oriented style .....	1966
20.131. Procedural style .....	1967
20.132. Object oriented style .....	1969
20.133. Procedural style .....	1970
20.134. Object oriented style .....	1971

---

---

20.135. Procedural style .....	1972
20.136. Object oriented style .....	1973
20.137. Procedural style .....	1973
20.138. Object oriented style .....	1976
20.139. Procedural style .....	1976
20.140. Object oriented style .....	1979
20.141. Procedural style .....	1980
20.142. Object oriented style .....	1981
20.143. Procedural style .....	1982
20.144. Object oriented style .....	1984
20.145. Procedural style .....	1984
20.146. Object oriented style .....	1985
20.147. Procedural style .....	1986
20.148. Object oriented style .....	1987
20.149. Procedural style .....	1988
20.150. Object oriented style .....	1989
20.151. Procedural style .....	1989
20.152. Object oriented style .....	1991
20.153. Procedural style .....	1992
20.154. Object oriented style .....	1994
20.155. Procedural style .....	1995
20.156. Object oriented style .....	1996
20.157. Procedural style .....	1996
20.158. Object oriented style .....	1998
20.159. Procedural style .....	1998
20.160. Object oriented style .....	2001
20.161. Procedural style .....	2001
20.162. Object oriented style .....	2002
20.163. Object oriented style .....	2003
20.164. Procedural style .....	2003
20.165. Object oriented style .....	2005
20.166. Procedural style .....	2005
20.167. Object oriented style .....	2007
20.168. Procedural style .....	2008
20.169. Object oriented style .....	2009
20.170. Procedural style .....	2010
20.171. Object oriented style .....	2012
20.172. Procedural style .....	2012
20.173. Object oriented style .....	2014
20.174. Procedural style .....	2014
20.175. Object oriented style .....	2016
20.176. Procedural style .....	2016
20.177. Object oriented style .....	2018
20.178. Procedural style .....	2018
20.179. Object oriented style .....	2020
20.180. Procedural style .....	2020
20.181. Object oriented style .....	2022
20.182. Procedural style .....	2022
20.183. Object oriented style .....	2023
20.184. Procedural style .....	2024
20.185. Object oriented style .....	2025
20.186. Procedural style .....	2025
20.187. Object oriented style .....	2027
20.188. Procedural style .....	2027
20.189. Object oriented style .....	2029
20.190. Procedural style .....	2029
20.191. Object oriented style .....	2031
20.192. Procedural style .....	2031
20.193. Object oriented style .....	2038
20.194. Forcing queries to be buffered in mysql .....	2041
20.195. PDO_MYSQL DSN examples .....	2042

---

# Preface, Notes, Licenses

This is the Reference Manual for the MySQL Database System, version 5.1, through release 5.1.36. It is not intended for use with older versions of the MySQL software due to the many functional and other differences between MySQL 5.1 and previous versions. If you are using an earlier release of the MySQL software, please refer to the [MySQL 5.0 Reference Manual](#), which covers the 5.0 series of MySQL software releases, or to [MySQL 3.23, 4.0, 4.1 Reference Manual](#), which covers the 3.23, 4.0, and 4.1 series of MySQL software releases. Differences between minor versions of MySQL 5.1 are noted in the present text with reference to release numbers (5.1.x).

If you are using MySQL 6.0, please refer to the [MySQL 6.0 Reference Manual](#).

## 1. MySQL Copyright Notice

Copyright © 2005-2008 MySQL AB, 2009 Sun Microsystems, Inc., 4150 Network Circle, Santa Clara, California 95054, U.S.A. All rights reserved. U.S. Government Rights - Commercial software. Government users are subject to the Sun Microsystems, Inc. standard license agreement and applicable provisions of the FAR and its supplements. Sun, Sun Microsystems, the Sun logo, Java, Solaris, StarOffice, MySQL and MySQL logo are trademarks or registered trademarks of Sun Microsystems, Inc. in the U.S. and other countries. UNIX is a registered trademark in the U.S. and other countries, exclusively licensed through X/Open Company, Ltd. Products covered by and information contained in this service manual are controlled by U.S. Export Control laws and may be subject to the export or import laws in other countries. Nuclear, missile, chemical biological weapons or nuclear maritime end uses or end users, whether direct or indirect, are strictly prohibited. Export or reexport to countries subject to U.S. embargo or to entities identified on U.S. export exclusion lists, including, but not limited to, the denied persons and specially designated nationals lists is strictly prohibited. DOCUMENTATION IS PROVIDED "AS IS" AND ALL EXPRESS OR IMPLIED CONDITIONS, REPRESENTATIONS AND WARRANTIES, INCLUDING ANY IMPLIED WARRANTY OF MERCHANTABILITY, FITNESS FOR A PARTICULAR PURPOSE OR NON-INFRINGEMENT, ARE DISCLAIMED, EXCEPT TO THE EXTENT THAT SUCH DISCLAIMERS ARE HELD TO BE LEGALLY INVALID.

Copyright © 2005-2008 MySQL AB, 2009 Sun Microsystems, Inc., 4150 Network Circle, Santa Clara, California 95054, Etats-Unis. Tous droits réservés. Sun, Sun Microsystems, le logo Sun, Java, Solaris, StarOffice, MySQL et MySQL logo sont des marques de fabrique ou des marques déposées de Sun Microsystems, Inc. aux Etats-Unis et dans d'autres pays. UNIX est une marque déposée aux Etats-Unis et dans d'autres pays et licenciée exclusivement par X/Open Company, Ltd. Les produits qui font l'objet de ce manuel d'entretien et les informations qu'il contient sont régis par la législation américaine en matière de contrôle des exportations et peuvent être soumis au droit d'autres pays dans le domaine des exportations et importations. Les utilisations finales, ou utilisateurs finaux, pour des armes nucléaires, des missiles, des armes biologiques et chimiques ou du nucléaire maritime, directement ou indirectement, sont strictement interdites. Les exportations ou réexportations vers des pays sous embargo des Etats-Unis, ou vers des entités figurant sur les listes d'exclusion d'exportation américaines, y compris, mais de manière non exclusive, la liste de personnes qui font objet d'un ordre de ne pas participer, d'une façon directe ou indirecte, aux exportations des produits ou des services qui sont régi par la législation américaine en matière de contrôle des exportations et la liste de ressortissants spécifiquement désignés, sont rigoureusement interdites. LA DOCUMENTATION EST FOURNIE "EN L'ETAT" ET TOUTES AUTRES CONDITIONS, DECLARATIONS ET GARANTIES EXPRESSES OU TACITES SONT FORMELLEMENT EXCLUES, DANS LA MESURE AUTORISEE PAR LA LOI APPLICABLE, Y COMPRIS NOTAMMENT TOUTE GARANTIE IMPLICITE RELATIVE A LA QUALITE MARCHANDE, A L'APTITUDE A UNE UTILISATION PARTICULIERE OU A L'ABSENCE DE CONTREFACON.

This documentation is NOT distributed under a GPL license. Use of this documentation is subject to the following terms: You may create a printed copy of this documentation solely for your own personal use. Conversion to other formats is allowed as long as the actual content is not altered or edited in any way. You shall not publish or distribute this documentation in any form or on any media, except if you distribute the documentation in a manner similar to how Sun disseminates it (that is, electronically for download on a Web site with the software) or on a CD-ROM or similar medium, provided however that the documentation is disseminated together with the software on the same medium. Any other use, such as any dissemination of printed copies or use of this documentation, in whole or in part, in another publication, requires the prior written consent from an authorized representative of Sun Microsystems, Inc. Sun Microsystems, Inc. and MySQL AB reserve any and all rights to this documentation not expressly granted above.

## 2. `regex` Library License

The `regex` library used for the `REGEXP` operator is covered by this license:

```
Copyright 1992, 1993, 1994 Henry Spencer. All rights reserved.
This software is not subject to any license of the American Telephone
and Telegraph Company or of the Regents of the University of California.

Permission is granted to anyone to use this software for any purpose on
any computer system, and to alter it and redistribute it, subject
to the following restrictions:

1. The author is not responsible for the consequences of use of this
   software, no matter how awful, even if they arise from flaws in it.

2. The origin of this software must not be misrepresented, either by
   explicit claim or by omission. Since few users ever read sources,
```



- credits must appear in the documentation.
3. Altered versions must be plainly marked as such, and must not be misrepresented as being the original software. Since few users ever read sources, credits must appear in the documentation.
  4. This notice may not be removed or altered.

### 3. libedit License

Each file in the `libedit` library is covered by one of the following three licenses:

```
/*-
 * Copyright (c) 1992, 1993
 * The Regents of the University of California. All rights reserved.
 *
 * This code is derived from software contributed to Berkeley by
 * Christos Zoulas of Cornell University.
 *
 * Redistribution and use in source and binary forms, with or without
 * modification, are permitted provided that the following conditions
 * are met:
 * 1. Redistributions of source code must retain the above copyright
 * notice, this list of conditions and the following disclaimer.
 * 2. Redistributions in binary form must reproduce the above copyright
 * notice, this list of conditions and the following disclaimer in the
 * documentation and/or other materials provided with the distribution.
 * 3. Neither the name of the University nor the names of its contributors
 * may be used to endorse or promote products derived from this software
 * without specific prior written permission.
 *
 * THIS SOFTWARE IS PROVIDED BY THE REGENTS AND CONTRIBUTORS ``AS IS'' AND
 * ANY EXPRESS OR IMPLIED WARRANTIES, INCLUDING, BUT NOT LIMITED TO, THE
 * IMPLIED WARRANTIES OF MERCHANTABILITY AND FITNESS FOR A PARTICULAR PURPOSE
 * ARE DISCLAIMED. IN NO EVENT SHALL THE REGENTS OR CONTRIBUTORS BE LIABLE
 * FOR ANY DIRECT, INDIRECT, INCIDENTAL, SPECIAL, EXEMPLARY, OR CONSEQUENTIAL
 * DAMAGES (INCLUDING, BUT NOT LIMITED TO, PROCUREMENT OF SUBSTITUTE GOODS
 * OR SERVICES; LOSS OF USE, DATA, OR PROFITS; OR BUSINESS INTERRUPTION)
 * HOWEVER CAUSED AND ON ANY THEORY OF LIABILITY, WHETHER IN CONTRACT, STRICT
 * LIABILITY, OR TORT (INCLUDING NEGLIGENCE OR OTHERWISE) ARISING IN ANY WAY
 * OUT OF THE USE OF THIS SOFTWARE, EVEN IF ADVISED OF THE POSSIBILITY OF
 * SUCH DAMAGE.
 */
```

```
/*-
 * Copyright (c) 1997 The NetBSD Foundation, Inc.
 * All rights reserved.
 *
 * This code is derived from software contributed to The NetBSD Foundation
 * by Jaromir Dolecek.
 *
 * Redistribution and use in source and binary forms, with or without
 * modification, are permitted provided that the following conditions
 * are met:
 * 1. Redistributions of source code must retain the above copyright
 * notice, this list of conditions and the following disclaimer.
 * 2. Redistributions in binary form must reproduce the above copyright
 * notice, this list of conditions and the following disclaimer in the
 * documentation and/or other materials provided with the distribution.
 *
 * THIS SOFTWARE IS PROVIDED BY THE NETBSD FOUNDATION, INC. AND CONTRIBUTORS
 * ``AS IS'' AND ANY EXPRESS OR IMPLIED WARRANTIES, INCLUDING, BUT NOT LIMITED
 * TO, THE IMPLIED WARRANTIES OF MERCHANTABILITY AND FITNESS FOR A PARTICULAR
 * PURPOSE ARE DISCLAIMED. IN NO EVENT SHALL THE FOUNDATION OR CONTRIBUTORS
 * BE LIABLE FOR ANY DIRECT, INDIRECT, INCIDENTAL, SPECIAL, EXEMPLARY, OR
 * CONSEQUENTIAL DAMAGES (INCLUDING, BUT NOT LIMITED TO, PROCUREMENT OF
 * SUBSTITUTE GOODS OR SERVICES; LOSS OF USE, DATA, OR PROFITS; OR BUSINESS
 * INTERRUPTION) HOWEVER CAUSED AND ON ANY THEORY OF LIABILITY, WHETHER IN
 * CONTRACT, STRICT LIABILITY, OR TORT (INCLUDING NEGLIGENCE OR OTHERWISE)
 * ARISING IN ANY WAY OUT OF THE USE OF THIS SOFTWARE, EVEN IF ADVISED OF THE
 * POSSIBILITY OF SUCH DAMAGE.
 */
```

```
/*-
 * Copyright (c) 2001 The NetBSD Foundation, Inc.
 * All rights reserved.
 *
 * This code is derived from software contributed to The NetBSD Foundation
 * by Anthony Mallet.
 *
 * Redistribution and use in source and binary forms, with or without
 * modification, are permitted provided that the following conditions
 * are met:
 * 1. Redistributions of source code must retain the above copyright
 * notice, this list of conditions and the following disclaimer.
 * 2. Redistributions in binary form must reproduce the above copyright
 * notice, this list of conditions and the following disclaimer in the
 * documentation and/or other materials provided with the distribution.
 *
 * THIS SOFTWARE IS PROVIDED BY THE NETBSD FOUNDATION, INC. AND CONTRIBUTORS
```



```
* ``AS IS'' AND ANY EXPRESS OR IMPLIED WARRANTIES, INCLUDING, BUT NOT LIMITED
* TO, THE IMPLIED WARRANTIES OF MERCHANTABILITY AND FITNESS FOR A PARTICULAR
* PURPOSE ARE DISCLAIMED. IN NO EVENT SHALL THE FOUNDATION OR CONTRIBUTORS
* BE LIABLE FOR ANY DIRECT, INDIRECT, INCIDENTAL, SPECIAL, EXEMPLARY, OR
* CONSEQUENTIAL DAMAGES (INCLUDING, BUT NOT LIMITED TO, PROCUREMENT OF
* SUBSTITUTE GOODS OR SERVICES; LOSS OF USE, DATA, OR PROFITS; OR BUSINESS
* INTERRUPTION) HOWEVER CAUSED AND ON ANY THEORY OF LIABILITY, WHETHER IN
* CONTRACT, STRICT LIABILITY, OR TORT (INCLUDING NEGLIGENCE OR OTHERWISE)
* ARISING IN ANY WAY OUT OF THE USE OF THIS SOFTWARE, EVEN IF ADVISED OF THE
* POSSIBILITY OF SUCH DAMAGE.
*/
```

## 4. getarg License

The `getarg` code used in MySQL Cluster is covered by this license:

```
/*
 * Copyright (c) 1997 - 2000 Kungliga Tekniska Högskolan
 * (Royal Institute of Technology, Stockholm, Sweden).
 * All rights reserved.
 *
 * Redistribution and use in source and binary forms, with or without
 * modification, are permitted provided that the following conditions
 * are met:
 *
 * 1. Redistributions of source code must retain the above copyright
 * notice, this list of conditions and the following disclaimer.
 *
 * 2. Redistributions in binary form must reproduce the above copyright
 * notice, this list of conditions and the following disclaimer in the
 * documentation and/or other materials provided with the distribution.
 *
 * 3. Neither the name of the Institute nor the names of its contributors
 * may be used to endorse or promote products derived from this software
 * without specific prior written permission.
 *
 * THIS SOFTWARE IS PROVIDED BY THE INSTITUTE AND CONTRIBUTORS ``AS IS'' AND
 * ANY EXPRESS OR IMPLIED WARRANTIES, INCLUDING, BUT NOT LIMITED TO, THE
 * IMPLIED WARRANTIES OF MERCHANTABILITY AND FITNESS FOR A PARTICULAR PURPOSE
 * ARE DISCLAIMED. IN NO EVENT SHALL THE INSTITUTE OR CONTRIBUTORS BE LIABLE
 * FOR ANY DIRECT, INDIRECT, INCIDENTAL, SPECIAL, EXEMPLARY, OR CONSEQUENTIAL
 * DAMAGES (INCLUDING, BUT NOT LIMITED TO, PROCUREMENT OF SUBSTITUTE GOODS
 * OR SERVICES; LOSS OF USE, DATA, OR PROFITS; OR BUSINESS INTERRUPTION)
 * HOWEVER CAUSED AND ON ANY THEORY OF LIABILITY, WHETHER IN CONTRACT, STRICT
 * LIABILITY, OR TORT (INCLUDING NEGLIGENCE OR OTHERWISE) ARISING IN ANY WAY
 * OUT OF THE USE OF THIS SOFTWARE, EVEN IF ADVISED OF THE POSSIBILITY OF
 * SUCH DAMAGE.
*/
```

---

# Chapter 1. General Information

The MySQL® software delivers a very fast, multi-threaded, multi-user, and robust SQL (Structured Query Language) database server. MySQL Server is intended for mission-critical, heavy-load production systems as well as for embedding into mass-deployed software. MySQL is a registered trademark of MySQL AB.

The MySQL software is Dual Licensed. Users can choose to use the MySQL software as an Open Source product under the terms of the GNU General Public License (<http://www.fsf.org/licenses/>) or can purchase a standard commercial license from MySQL AB. See <http://www.mysql.com/company/legal/licensing/> for more information on our licensing policies.

The following list describes some sections of particular interest in this manual:

- For a discussion about the capabilities of the MySQL Database Server, see [Section 1.3.3, “The Main Features of MySQL”](#).
- For future plans, see [Section 1.4, “MySQL Development Roadmap”](#).
- For installation instructions, see [Chapter 2, \*Installing and Upgrading MySQL\*](#). For information about upgrading MySQL, see [Section 2.12.1, “Upgrading MySQL”](#).
- For a tutorial introduction to the MySQL Database Server, see [Chapter 3, \*Tutorial\*](#).
- For information about configuring and administering MySQL Server, see [Chapter 5, \*MySQL Server Administration\*](#).
- For information about setting up replication servers, see [Chapter 16, \*Replication\*](#).
- For answers to a number of questions that are often asked concerning the MySQL Database Server and its capabilities, see [Appendix A, \*MySQL 5.1 Frequently Asked Questions\*](#).
- For a list of currently known bugs and misfeatures, see [Section B.1.8, “Known Issues in MySQL”](#).
- For a list of all the contributors to this project, see [Section 1.8, “Credits”](#).
- For a history of new features and bugfixes, see [Appendix C, \*MySQL Change History\*](#).
- For tips on porting the MySQL Database Software to new architectures or operating systems, see [MySQL Internals: Porting](#).
- For benchmarking information, see the [sql-bench](#) benchmarking directory in your MySQL distribution.

## Important

To report errors (often called “bugs”), please use the instructions at [Section 1.6, “How to Report Bugs or Problems”](#).

If you have found a sensitive security bug in MySQL Server, please let us know immediately by sending an email message to [<security@mysql.com>](mailto:security@mysql.com).

## 1.1. About This Manual

This is the Reference Manual for the MySQL Database System, version 5.1, through release 5.1.36. It is not intended for use with older versions of the MySQL software due to the many functional and other differences between MySQL 5.1 and previous versions. If you are using an earlier release of the MySQL software, please refer to the [MySQL 5.0 Reference Manual](#), which covers the 5.0 series of MySQL software releases, or to [MySQL 3.23, 4.0, 4.1 Reference Manual](#), which covers the 3.23, 4.0, and 4.1 series of MySQL software releases. Differences between minor versions of MySQL 5.1 are noted in the present text with reference to release numbers (5.1.x).

Because this manual serves as a reference, it does not provide general instruction on SQL or relational database concepts. It also does not teach you how to use your operating system or command-line interpreter.

The MySQL Database Software is under constant development, and the Reference Manual is updated frequently as well. The most recent version of the manual is available online in searchable form at <http://dev.mysql.com/doc/>. Other formats also are available there, including HTML, PDF, and Windows CHM versions.

The Reference Manual source files are written in DocBook XML format. The HTML version and other formats are produced automatically, primarily using the DocBook XSL stylesheets. For information about DocBook, see <http://docbook.org/>

The DocBook XML sources of this manual are available from <http://dev.mysql.com/tech-resources/sources.html>. You can check out a copy of the documentation repository with this command:

```
svn checkout http://svn.mysql.com/svnpublic/mysql/doc/
```

If you have questions about using MySQL, you can ask them using our mailing lists or forums. See [Section 1.5.1, “MySQL Mailing Lists”](#), and [Section 1.5.2, “MySQL Community Support at the MySQL Forums”](#). If you have suggestions concerning additions or corrections to the manual itself, please send them to the [Documentation Team](#).

This manual was originally written by David Axmark and Michael “Monty” Widenius. It is maintained by the MySQL Documentation Team, consisting of Paul DuBois, Stefan Hinz, Jon Stephens, Martin MC Brown, and Tony Bedford.

## 1.2. Typographical and Syntax Conventions

This manual uses certain typographical conventions:

- *Text in this style* is used for SQL statements; database, table, and column names; program listings and source code; and environment variables. Example: “To reload the grant tables, use the `FLUSH PRIVILEGES` statement.”
- *Text in this style* indicates input that you type in examples.
- *Text in this style* indicates the names of executable programs and scripts, examples being `mysql` (the MySQL command line client program) and `mysqld` (the MySQL server executable).
- *Text in this style* is used for variable input for which you should substitute a value of your own choosing.
- File names and directory names are written like this: “The global `my.cnf` file is located in the `/etc` directory.”
- Character sequences are written like this: “To specify a wildcard, use the ‘`%`’ character.”
- *Text in this style* is used for emphasis.
- **Text in this style** is used in table headings and to convey especially strong emphasis.

When commands are shown that are meant to be executed from within a particular program, the prompt shown preceding the command indicates which command to use. For example, `shell>` indicates a command that you execute from your login shell, and `mysql>` indicates a statement that you execute from the `mysql` client program:

```
shell> type a shell command here
root-shell> type a shell command as root here
mysql> type a mysql statement here
```

In some areas different systems may be distinguished from each other to show that commands should be executed in two different environments. For example, while working with replication the commands might be prefixed with `master` and `slave`:

```
master> type a mysql command on the replication master here
slave> type a mysql command on the replication slave here
```

The “shell” is your command interpreter. On Unix, this is typically a program such as `sh`, `csh`, or `bash`. On Windows, the equivalent program is `command.com` or `cmd.exe`, typically run in a console window.

When you enter a command or statement shown in an example, do not type the prompt shown in the example.

Database, table, and column names must often be substituted into statements. To indicate that such substitution is necessary, this manual uses `db_name`, `tbl_name`, and `col_name`. For example, you might see a statement like this:

```
mysql> SELECT col_name FROM db_name.tbl_name;
```

This means that if you were to enter a similar statement, you would supply your own database, table, and column names, perhaps like this:

```
mysql> SELECT author_name FROM biblio_db.author_list;
```

SQL keywords are not case sensitive and may be written in any lettercase. This manual uses uppercase.

In syntax descriptions, square brackets (“`[`” and “`]`”) indicate optional words or clauses. For example, in the following statement, `IF EXISTS` is optional:

```
DROP TABLE [IF EXISTS] tbl_name
```

When a syntax element consists of a number of alternatives, the alternatives are separated by vertical bars (“`|`”). When one member

from a set of choices *may* be chosen, the alternatives are listed within square brackets (“[” and “]”):

```
TRIM([[BOTH | LEADING | TRAILING] [remstr] FROM] str)
```

When one member from a set of choices *must* be chosen, the alternatives are listed within braces (“{” and “}”):

```
{DESCRIBE | DESC} tbl_name [col_name | wild]
```

An ellipsis (...) indicates the omission of a section of a statement, typically to provide a shorter version of more complex syntax. For example, `SELECT ... INTO OUTFILE` is shorthand for the form of `SELECT` statement that has an `INTO OUTFILE` clause following other parts of the statement.

An ellipsis can also indicate that the preceding syntax element of a statement may be repeated. In the following example, multiple `reset_option` values may be given, with each of those after the first preceded by commas:

```
RESET reset_option [,reset_option] ...
```

Commands for setting shell variables are shown using Bourne shell syntax. For example, the sequence to set the `CC` environment variable and run the `configure` command looks like this in Bourne shell syntax:

```
shell> CC=gcc ./configure
```

If you are using `csh` or `tcsh`, you must issue commands somewhat differently:

```
shell> setenv CC gcc
shell> ./configure
```

## 1.3. Overview of the MySQL Database Management System

### 1.3.1. What is MySQL?

MySQL, the most popular Open Source SQL database management system, is developed, distributed, and supported by MySQL AB. MySQL AB is a commercial company, founded by the MySQL developers. It is a second generation Open Source company that unites Open Source values and methodology with a successful business model.

The MySQL Web site (<http://www.mysql.com/>) provides the latest information about MySQL software and MySQL AB.

- MySQL is a database management system.

A database is a structured collection of data. It may be anything from a simple shopping list to a picture gallery or the vast amounts of information in a corporate network. To add, access, and process data stored in a computer database, you need a database management system such as MySQL Server. Since computers are very good at handling large amounts of data, database management systems play a central role in computing, as standalone utilities, or as parts of other applications.

- MySQL is a relational database management system.

A relational database stores data in separate tables rather than putting all the data in one big storeroom. This adds speed and flexibility. The SQL part of “MySQL” stands for “Structured Query Language.” SQL is the most common standardized language used to access databases and is defined by the ANSI/ISO SQL Standard. The SQL standard has been evolving since 1986 and several versions exist. In this manual, “SQL-92” refers to the standard released in 1992, “SQL:1999” refers to the standard released in 1999, and “SQL:2003” refers to the current version of the standard. We use the phrase “the SQL standard” to mean the current version of the SQL Standard at any time.

- MySQL software is Open Source.

Open Source means that it is possible for anyone to use and modify the software. Anybody can download the MySQL software from the Internet and use it without paying anything. If you wish, you may study the source code and change it to suit your needs. The MySQL software uses the GPL (GNU General Public License), <http://www.fsf.org/licenses/>, to define what you may and may not do with the software in different situations. If you feel uncomfortable with the GPL or need to embed MySQL code into a commercial application, you can buy a commercially licensed version from us. See the MySQL Licensing Overview for more information (<http://www.mysql.com/company/legal/licensing/>).

- The MySQL Database Server is very fast, reliable, and easy to use.

If that is what you are looking for, you should give it a try. MySQL Server also has a practical set of features developed in close cooperation with our users. You can find a performance comparison of MySQL Server with other database managers on our benchmark page. See [Section 7.1.4, “The MySQL Benchmark Suite”](#).

MySQL Server was originally developed to handle large databases much faster than existing solutions and has been successfully used in highly demanding production environments for several years. Although under constant development, MySQL Server today offers a rich and useful set of functions. Its connectivity, speed, and security make MySQL Server highly suited for accessing databases on the Internet.

- MySQL Server works in client/server or embedded systems.

The MySQL Database Software is a client/server system that consists of a multi-threaded SQL server that supports different backends, several different client programs and libraries, administrative tools, and a wide range of application programming interfaces (APIs).

We also provide MySQL Server as an embedded multi-threaded library that you can link into your application to get a smaller, faster, easier-to-manage standalone product.

- A large amount of contributed MySQL software is available.

It is very likely that your favorite application or language supports the MySQL Database Server.

The official way to pronounce “MySQL” is “My Ess Que Ell” (not “my sequel”), but we do not mind if you pronounce it as “my sequel” or in some other localized way.

## 1.3.2. History of MySQL

We started out with the intention of using the `mSQL` database system to connect to our tables using our own fast low-level (ISAM) routines. However, after some testing, we came to the conclusion that `mSQL` was not fast enough or flexible enough for our needs. This resulted in a new SQL interface to our database but with almost the same API interface as `mSQL`. This API was designed to allow third-party code that was written for use with `mSQL` to be ported easily for use with MySQL.

MySQL is named after co-founder Monty Widenius's daughter, My.

The name of the MySQL Dolphin (our logo) is “Sakila,” which was chosen by the founders of MySQL AB from a huge list of names suggested by users in our “Name the Dolphin” contest. The winning name was submitted by Ambrose Twebaze, an Open Source software developer from Swaziland, Africa. According to Ambrose, the feminine name Sakila has its roots in SiSwati, the local language of Swaziland. Sakila is also the name of a town in Arusha, Tanzania, near Ambrose's country of origin, Uganda.

## 1.3.3. The Main Features of MySQL

This section describes some of the important characteristics of the MySQL Database Software. See also [Section 1.4, “MySQL Development Roadmap”](#), for more information about current and upcoming features. In most respects, it applies to all versions of MySQL. For information about features as they are introduced into MySQL on a series-specific basis, see the “In a Nutshell” section of the appropriate Manual:

- MySQL 4.0 and 4.1: [MySQL 4.0 in a Nutshell](#), and [MySQL 4.1 in a Nutshell](#).
- MySQL 5.0: [MySQL 5.0 in a Nutshell](#).
- MySQL 5.1: [MySQL 5.1 in a Nutshell](#).
- MySQL 6.0: [MySQL 6.0 in a Nutshell](#).

Internals and Portability:

- Written in C and C++.
- Tested with a broad range of different compilers.
- Works on many different platforms. See [Section 2.1.1, “Operating Systems Supported by MySQL Community Server”](#).
- Uses GNU Automake, Autoconf, and Libtool for portability.
- The MySQL Server design is multi-layered with independent modules.
- Fully multi-threaded using kernel threads. It can easily use multiple CPUs if they are available.
- Provides transactional and non-transactional storage engines.

- Uses very fast B-tree disk tables ([MyISAM](#)) with index compression.
- Relatively easy to add other storage engines. This is useful if you want to provide an SQL interface for an in-house database.
- A very fast thread-based memory allocation system.
- Very fast joins using an optimized one-sweep multi-join.
- In-memory hash tables, which are used as temporary tables.
- SQL functions are implemented using a highly optimized class library and should be as fast as possible. Usually there is no memory allocation at all after query initialization.
- The MySQL code is tested with Purify (a commercial memory leakage detector) as well as with Valgrind, a GPL tool (<http://developer.kde.org/~sewardj/>).
- The server is available as a separate program for use in a client/server networked environment. It is also available as a library that can be embedded (linked) into standalone applications. Such applications can be used in isolation or in environments where no network is available.

#### Data Types:

- Many data types: signed/unsigned integers 1, 2, 3, 4, and 8 bytes long, [FLOAT](#), [DOUBLE](#), [CHAR](#), [VARCHAR](#), [TEXT](#), [BLOB](#), [DATE](#), [TIME](#), [DATETIME](#), [TIMESTAMP](#), [YEAR](#), [SET](#), [ENUM](#), and OpenGIS spatial types. See [Chapter 10, Data Types](#).
- Fixed-length and variable-length records.

#### Statements and Functions:

- Full operator and function support in the [SELECT](#) list and [WHERE](#) clause of queries. For example:

```
mysql> SELECT CONCAT(first_name, ' ', last_name)
-> FROM citizen
-> WHERE income/dependents > 10000 AND age > 30;
```

- Full support for SQL [GROUP BY](#) and [ORDER BY](#) clauses. Support for group functions ([COUNT\(\)](#), [COUNT\(DISTINCT ...\)](#), [AVG\(\)](#), [STD\(\)](#), [SUM\(\)](#), [MAX\(\)](#), [MIN\(\)](#), and [GROUP\\_CONCAT\(\)](#)).
- Support for [LEFT OUTER JOIN](#) and [RIGHT OUTER JOIN](#) with both standard SQL and ODBC syntax.
- Support for aliases on tables and columns as required by standard SQL.
- [DELETE](#), [INSERT](#), [REPLACE](#), and [UPDATE](#) return the number of rows that were changed (affected). It is possible to return the number of rows matched instead by setting a flag when connecting to the server.
- The MySQL-specific [SHOW](#) statement can be used to retrieve information about databases, storage engines, tables, and indexes. MySQL 5.0 adds support for the [INFORMATION\\_SCHEMA](#) database, implemented according to standard SQL.
- The [EXPLAIN](#) statement can be used to determine how the optimizer resolves a query.
- Function names do not clash with table or column names. For example, [ABS](#) is a valid column name. The only restriction is that for a function call, no spaces are allowed between the function name and the "(" that follows it. See [Section 8.3, "Reserved Words"](#).
- You can refer to tables from different databases in the same statement.

#### Security:

- A privilege and password system that is very flexible and secure, and that allows host-based verification.
- Passwords are secure because all password traffic is encrypted when you connect to a server.

#### Scalability and Limits:

- Handles large databases. We use MySQL Server with databases that contain 50 million records. We also know of users who use MySQL Server with 60,000 tables and about 5,000,000,000 rows.
- Up to 64 indexes per table are allowed (32 before MySQL 4.1.2). Each index may consist of 1 to 16 columns or parts of columns. The maximum index width is 1000 bytes (767 for `InnoDB`); before MySQL 4.1.2, the limit is 500 bytes. An index may use a prefix of a column for `CHAR`, `VARCHAR`, `BLOB`, or `TEXT` column types.

#### Connectivity:

- Clients can connect to MySQL Server using several protocols:
  - Clients can connect using TCP/IP sockets on any platform.
  - On Windows systems in the NT family (NT, 2000, XP, 2003, or Vista), clients can connect using named pipes if the server is started with the `--enable-named-pipe` option. In MySQL 4.1 and higher, Windows servers also support shared-memory connections if started with the `--shared-memory` option. Clients can connect through shared memory by using the `--protocol=memory` option.
  - On Unix systems, clients can connect using Unix domain socket files.
- MySQL client programs can be written in many languages. A client library written in C is available for clients written in C or C++, or for any language that provides C bindings.
- APIs for C, C++, Eiffel, Java, Perl, PHP, Python, Ruby, and Tcl are available, allowing MySQL clients to be written in many languages. See [Chapter 20, Connectors and APIs](#).
- The Connector/ODBC (MyODBC) interface provides MySQL support for client programs that use ODBC (Open Database Connectivity) connections. For example, you can use MS Access to connect to your MySQL server. Clients can be run on Windows or Unix. MyODBC source is available. All ODBC 2.5 functions are supported, as are many others. See [Section 20.1, “MySQL Connector/ODBC”](#).
- The Connector/J interface provides MySQL support for Java client programs that use JDBC connections. Clients can be run on Windows or Unix. Connector/J source is available. See [Section 20.4, “MySQL Connector/J”](#).
- MySQL Connector/NET enables developers to easily create .NET applications that require secure, high-performance data connectivity with MySQL. It implements the required ADO.NET interfaces and integrates into ADO.NET aware tools. Developers can build applications using their choice of .NET languages. MySQL Connector/NET is a fully managed ADO.NET driver written in 100% pure C#. See [Section 20.2, “MySQL Connector/NET”](#).

#### Localization:

- The server can provide error messages to clients in many languages. See [Section 9.3, “Setting the Error Message Language”](#).
- Full support for several different character sets, including `latin1` (cp1252), `german`, `big5`, `ujis`, and more. For example, the Scandinavian characters “ä”, “å” and “ö” are allowed in table and column names. Unicode support is available as of MySQL 4.1.
- All data is saved in the chosen character set.
- Sorting and comparisons are done according to the chosen character set and collation (using `latin1` and Swedish collation by default). It is possible to change this when the MySQL server is started. To see an example of very advanced sorting, look at the Czech sorting code. MySQL Server supports many different character sets that can be specified at compile time and runtime.
- As of MySQL 4.1, the server time zone can be changed dynamically, and individual clients can specify their own time zone. [Section 9.7, “MySQL Server Time Zone Support”](#).

#### MySQL Enterprise

For assistance in getting optimal performance from your MySQL server subscribe to MySQL Enterprise. For more information, see <http://www.mysql.com/products/enterprise/>.

#### Clients and Tools:

- MySQL AB provides several client and utility programs. These include both command-line programs such as `mysqldump` and `mysqladmin`, and graphical programs such as MySQL Administrator and MySQL Query Browser.



- MySQL Server has built-in support for SQL statements to check, optimize, and repair tables. These statements are available from the command line through the `mysqlcheck` client. MySQL also includes `myisamchk`, a very fast command-line utility for performing these operations on MyISAM tables. See [Chapter 4, MySQL Programs](#).
- MySQL programs can be invoked with the `--help` or `-?` option to obtain online assistance.

## 1.4. MySQL Development Roadmap

This section describes the general MySQL development roadmap, provides an overview about features that have been implemented in previous series and that are new in this current release series (5.1), and an overview about upcoming additions or changes in the next release series (6.0).

The maturity level of the release series covered in this manual (5.1) is general availability. Information about maturity levels can be found in [Section 2.1.2.1, “Choosing Which Version of MySQL to Install”](#).

Before upgrading from one release series to the next, please see the notes in [Section 2.12.1, “Upgrading MySQL”](#).

The most requested features and the versions in which they were implemented or are scheduled for implementation are summarized in the following table.

Feature	MySQL Series
Unions	4.0
Subqueries	4.1
R-trees	4.1 (for the MyISAM storage engine)
Stored procedures	5.0
Views	5.0
Cursors	5.0
XA transactions	5.0
Triggers	5.0 and 5.1
Event scheduler	5.1
Partitioning	5.1
Pluggable storage engine API	5.1
Plugin API	5.1
Row-based replication	5.1
Server log tables	5.1
Foreign keys	6.x (implemented in 3.23 for InnoDB)

### 1.4.1. What Is New in MySQL 5.1

The following features have been added to MySQL 5.1.

- **Partitioning.** This capability enables distributing portions of individual tables across a file system, according to rules which can be set when the table is created. In effect, different portions of a table are stored as separate tables in different locations, but from the user point of view, the partitioned table is still a single table. Syntactically, this implements a number of new extensions to the `CREATE TABLE`, `ALTER TABLE`, and `EXPLAIN . . . SELECT` statements. As of MySQL 5.1.6, queries against partitioned tables can take advantage of *partition pruning*. In some cases, this can result in query execution that is an order of magnitude faster than the same query against a non-partitioned version of the same table. See [Chapter 17, Partitioning](#), for further information on this functionality. (Author: Mikael Ronström)
- **Row-based replication.** Replication capabilities in MySQL originally were based on propagation of SQL statements from master to slave. This is called *statement-based replication*. As of MySQL 5.1.5, another basis for replication is available. This is called *row-based replication*. Instead of sending SQL statements to the slave, the master writes events to its binary log that indicate how individual table rows are effected. As of MySQL 5.1.8, a third option is available: *mixed*. This will use statement-based replication by default, and only switch to row-based replication in particular cases. See [Section 16.1.2, “Replication Formats”](#). (Authors: Lars Thalmann, Guilhem Bichot, Mats Kindahl)
- **Plugin API.** MySQL 5.1 adds support for a very flexible plugin API that enables loading and unloading of various components at runtime, without restarting the server. Although the work on this is not finished yet, *plugin full-text parsers* are a first step in this direction. This allows users to implement their own input filter on the indexed text, enabling full-text search capability on



arbitrary data such as PDF files or other document formats. A pre-parser full-text plugin performs the actual parsing and extraction of the text and hands it over to the built-in MySQL full-text search. See [Section 21.2, “The MySQL Plugin Interface”](#). (Author: Sergey Vojtovich)

- **Event scheduler.** MySQL Events are tasks that run according to a schedule. When you create an event, you are creating a named database object containing one or more SQL statements to be executed at one or more regular intervals, beginning and ending at a specific date and time. Conceptually, this is similar to the idea of the Unix `crontab` (also known as a “cron job”) or the Windows Task Scheduler. See [Section 18.4, “Using the Event Scheduler”](#). (Author: Andrey Hristov)
- **Server log tables.** Before MySQL 5.1, the server writes general query log and slow query log entries to log files. As of MySQL 5.1, the server's logging capabilities for these logs are more flexible. Log entries can be written to log files (as before) or to the `general_log` and `slow_log` tables in the `mysql` database. If logging is enabled, either or both destinations can be selected. The `--log-output` option controls the destination or destinations of log output. See [Section 5.2.1, “Selecting General Query and Slow Query Log Output Destinations”](#). (Author: Petr Chardin)
- **Upgrade program.** The `mysql_upgrade` program (available as of MySQL 5.1.7) checks all existing tables for incompatibilities with the current version of MySQL Server and repairs them if necessary. This program should be run for each MySQL upgrade. See [Section 4.4.8, “mysql\\_upgrade — Check Tables for MySQL Upgrade”](#). (Authors: Alexey Botchkov, Mikael Widenius)
- **MySQL Cluster.** MySQL Cluster is now released as a separate product, based on MySQL 5.1 but with the addition of the `NDBCLUSTER` storage engine. Clustering support is no longer available in mainline MySQL 5.1 releases. MySQL Cluster releases are identified by a 3-part NDB version number; currently, the MySQL Cluster NDB 6.2 and MySQL Cluster NDB 6.3 release series are available for production use.

Some of the changes in MySQL Cluster since MySQL 5.0 are listed here:

- **MySQL Cluster replication.** Replication between MySQL Clusters is now supported. It is now also possible to replicate between a MySQL Cluster and a non-cluster database. See [MySQL Cluster Replication](#).
- **MySQL Cluster disk data storage.** Formerly, the `NDBCLUSTER` storage engine was strictly in-memory; now, it is possible to store Cluster data (but not indexes) on disk. This allows MySQL Cluster to scale upward with fewer hardware (RAM) requirements than previously. In addition, the Disk Data implementation includes a new “no-steal” restoration algorithm for fast node restarts when storing very large amounts of data (terabyte range). See [MySQL Cluster Disk Data Tables](#), for more information.
- **Improved backups for MySQL Cluster.** A fault arising in a single data node during a Cluster backup no longer causes the entire backup to be aborted, as occurred in previous versions of MySQL Cluster.

Many other new features and improvements have been made to the `NDBCLUSTER` storage engine in MySQL Cluster NDB 6.2 and MySQL Cluster NDB 6.3; for more information about these, see [MySQL Cluster Development Roadmap](#).

- **Backup of tablespaces.** The `mysqldump` utility now supports an option for dumping tablespaces. Use `-Y` or `-all-tablespaces` to enable this functionality.
- **Improvements to `INFORMATION_SCHEMA`.** MySQL 5.1 provides much more information in its metadata database than was available in MySQL 5.0. New tables in the `INFORMATION_SCHEMA` database include `FILES`, `EVENTS`, `PARTITIONS`, `PROCESSLIST`, `ENGINES`, and `PLUGINS`.
- **XML functions with XPath support.** `ExtractValue()` returns the content of a fragment of XML matching a given XPath expression. `UpdateXML()` replaces the element selected from a fragment of XML by an XPath expression supplied by the user with a second XML fragment (also user-supplied), and returns the modified XML. See [Section 11.10, “XML Functions”](#). (Author: Alexander Barkov)
- **Load emulator.** The `mysqlslap` program is designed to emulate client load for a MySQL server and report the timing of each stage. It works as if multiple clients were accessing the server. See [Section 4.5.7, “mysqlslap — Load Emulation Client”](#). (Authors: Patrick Galbraith, Brian Aker)

## 1.4.2. What Is Planned for MySQL 6.0

### Note

This section remains subject to change as long as MySQL 6.0 development is in its early stages.

The following features are expected to be added to, or change in MySQL 6.0:

- A new transactional storage engine ([Falcon](#)).

- Support for additional Unicode character sets: `utf16`, `utf32`, and 4-byte `utf8`. These character sets support supplementary Unicode characters; that is, characters outside the Basic Multilingual Plane (BMP).
- `BACKUP DATABASE` and `RESTORE` statements for backup and restore operations.
- Improvements in the `INFORMATION_SCHEMA` database, with the addition of the `INFORMATION_SCHEMA.PARAMETERS` table, and new columns added to `INFORMATION_SCHEMA.ROUTINES`.
- Optimizer enhancements for faster subqueries and joins, including batched index access of table rows for sequences of disjoint ranges by the `MyISAM` and `InnoDB` storage engines.
- `RESET SLAVE` no longer changes replication connection parameters. Previously, it reset them to the values specified on the command line.
- The syntax for the `LOCK TABLES` statement is extended to support transactional table locks that do not commit transactions automatically. Following `LOCK TABLES ... IN SHARE MODE` or `LOCK TABLES ... IN EXCLUSIVE MODE`, you can access tables not mentioned in the `LOCK TABLES` statement. You can now also issue these extended `LOCK TABLES` statements many times in succession, adding additional tables to the locked set, and without unlocking any tables that were locked previously. When using `LOCK TABLES` with `IN SHARE MODE` or `IN EXCLUSIVE MODE`, tables are not unlocked until the transaction ends.

The behavior of `LOCK TABLES` when not using `IN SHARE MODE` or `IN EXCLUSIVE MODE` remains unchanged.

- Further enhancements to XML functionality, including a new `LOAD XML` statement.
- Support for extended comments for tables, columns, and indexes.

The following constructs are deprecated and have been removed for MySQL 6.0. Where alternatives are shown, applications should be updated to use them.

- The `table_type` system variable (use `storage_engine`).  
The `TYPE` table option to specify the storage engine for `CREATE TABLE` or `ALTER TABLE` (use `ENGINE`).  
The `SHOW TABLE TYPES` SQL statement (use `SHOW ENGINES`).
- The `log_bin_trust_routine_creators` variable (use `log_bin_trust_function_creators`).
- `TIMESTAMP(N)`: The ability to specify a display width of `N` (use without `N`).
- The `SHOW INNODB STATUS` and `SHOW MUTEX STATUS` SQL statements (use `SHOW ENGINE INNODB STATUS` for both of these).
- The `LOAD TABLE ... FROM MASTER` and `LOAD DATA FROM MASTER` SQL statements.
- The `SHOW PLUGIN` SQL statement (use `SHOW PLUGINS`).
- The `RESTORE TABLE` SQL statement.
- The `BACKUP TABLE` SQL statement.
- The `--master-xxx` server options to set replication parameters (use the `CHANGE MASTER TO` statement).

## 1.5. MySQL Information Sources

This section lists sources of additional information that you may find helpful, such as the MySQL mailing lists and user forums, and Internet Relay Chat.

### 1.5.1. MySQL Mailing Lists

This section introduces the MySQL mailing lists and provides guidelines as to how the lists should be used. When you subscribe to a mailing list, you receive all postings to the list as email messages. You can also send your own questions and answers to the list.

To subscribe to or unsubscribe from any of the mailing lists described in this section, visit <http://lists.mysql.com/>. For most of them, you can select the regular version of the list where you get individual messages, or a digest version where you get one large message per day.

Please *do not* send messages about subscribing or unsubscribing to any of the mailing lists, because such messages are distributed automatically to thousands of other users.

Your local site may have many subscribers to a MySQL mailing list. If so, the site may have a local mailing list, so that messages sent from [lists.mysql.com](http://lists.mysql.com) to your site are propagated to the local list. In such cases, please contact your system administrator to be added to or dropped from the local MySQL list.

If you wish to have traffic for a mailing list go to a separate mailbox in your mail program, set up a filter based on the message headers. You can use either the `List-ID:` or `Delivered-To:` headers to identify list messages.

The MySQL mailing lists are as follows:

- [announce](#)

This list is for announcements of new versions of MySQL and related programs. This is a low-volume list to which all MySQL users should subscribe.

- [mysql](#)

This is the main list for general MySQL discussion. Please note that some topics are better discussed on the more-specialized lists. If you post to the wrong list, you may not get an answer.

- [bugs](#)

This list is for people who want to stay informed about issues reported since the last release of MySQL or who want to be actively involved in the process of bug hunting and fixing. See [Section 1.6, “How to Report Bugs or Problems”](#).

- [internals](#)

This list is for people who work on the MySQL code. This is also the forum for discussions on MySQL development and for posting patches.

- [mysqldoc](#)

This list is for people who work on the MySQL documentation: people from MySQL AB, translators, and other community members.

- [benchmarks](#)

This list is for anyone interested in performance issues. Discussions concentrate on database performance (not limited to MySQL), but also include broader categories such as performance of the kernel, file system, disk system, and so on.

- [packagers](#)

This list is for discussions on packaging and distributing MySQL. This is the forum used by distribution maintainers to exchange ideas on packaging MySQL and on ensuring that MySQL looks and feels as similar as possible on all supported platforms and operating systems.

- [java](#)

This list is for discussions about the MySQL server and Java. It is mostly used to discuss JDBC drivers such as MySQL Connector/J.

- [win32](#)

This list is for all topics concerning the MySQL software on Microsoft operating systems, such as Windows 9x, Me, NT, 2000, XP, and 2003.

- [myodbc](#)

This list is for all topics concerning connecting to the MySQL server with ODBC.

- [gui-tools](#)

This list is for all topics concerning MySQL graphical user interface tools such as [MySQL Administrator](#) and [MySQL Query Browser](#).

- [cluster](#)

This list is for discussion of MySQL Cluster.

- [dotnet](#)

This list is for discussion of the MySQL server and the .NET platform. It is mostly related to MySQL Connector/Net.

- [plusplus](#)

This list is for all topics concerning programming with the C++ API for MySQL.

- [perl](#)

This list is for all topics concerning Perl support for MySQL with `DBD: :mysql`.

If you're unable to get an answer to your questions from a MySQL mailing list or forum, one option is to purchase support from Sun Microsystems, Inc. This puts you in direct contact with MySQL developers.

The following table shows some MySQL mailing lists in languages other than English. These lists are not operated by Sun Microsystems, Inc.

- [<mysql-france-subscribe@yahoogroups.com>](mailto:<mysql-france-subscribe@yahoogroups.com>)

A French mailing list.

- [<list@tinc.net>](mailto:<list@tinc.net>)

A Korean mailing list. To subscribe, email `subscribe mysql your@email.address` to this list.

- [<mysql-de-request@lists.4t2.com>](mailto:<mysql-de-request@lists.4t2.com>)

A German mailing list. To subscribe, email `subscribe mysql-de your@email.address` to this list. You can find information about this mailing list at <http://www.4t2.com/mysql/>.

- [<mysql-br-request@listas.linkway.com.br>](mailto:<mysql-br-request@listas.linkway.com.br>)

A Portuguese mailing list. To subscribe, email `subscribe mysql-br your@email.address` to this list.

- [<mysql-alta@elistas.net>](mailto:<mysql-alta@elistas.net>)

A Spanish mailing list. To subscribe, email `subscribe mysql your@email.address` to this list.

### 1.5.1.1. Guidelines for Using the Mailing Lists

Please do not post mail messages from your browser with HTML mode turned on. Many users do not read mail with a browser.

When you answer a question sent to a mailing list, if you consider your answer to have broad interest, you may want to post it to the list instead of replying directly to the individual who asked. Try to make your answer general enough that people other than the original poster may benefit from it. When you post to the list, please make sure that your answer is not a duplication of a previous answer.

Try to summarize the essential part of the question in your reply. Do not feel obliged to quote the entire original message.

When answers are sent to you individually and not to the mailing list, it is considered good etiquette to summarize the answers and send the summary to the mailing list so that others may have the benefit of responses you received that helped you solve your problem.

### 1.5.2. MySQL Community Support at the MySQL Forums

The forums at <http://forums.mysql.com> are an important community resource. Many forums are available, grouped into these general categories:

- Migration
- MySQL Usage
- MySQL Connectors
- Programming Languages

- Tools
- 3rd-Party Applications
- Storage Engines
- MySQL Technology
- SQL Standards
- Business

### 1.5.3. MySQL Community Support on Internet Relay Chat (IRC)

In addition to the various MySQL mailing lists and forums, you can find experienced community people on Internet Relay Chat (IRC). These are the best networks/channels currently known to us:

**freenode** (see <http://www.freenode.net/> for servers)

- `#mysql` is primarily for MySQL questions, but other database and general SQL questions are welcome. Questions about PHP, Perl, or C in combination with MySQL are also common.

If you are looking for IRC client software to connect to an IRC network, take a look at **xChat** (<http://www.xchat.org/>). X-Chat (GPL licensed) is available for Unix as well as for Windows platforms (a free Windows build of X-Chat is available at <http://www.silverex.org/download/>).

### 1.5.4. MySQL Enterprise

Sun Microsystems, Inc. offers technical support in the form of MySQL Enterprise. For organizations that rely on the MySQL DBMS for business-critical production applications, MySQL Enterprise is a commercial subscription offering which includes:

- MySQL Enterprise Server
- MySQL Enterprise Monitor
- Monthly Rapid Updates and Quarterly Service Packs
- MySQL Knowledge Base
- 24x7 Technical and Consultative Support

MySQL Enterprise is available in multiple tiers, giving you the flexibility to choose the level of service that best matches your needs. For more information, see [MySQL Enterprise](#).

## 1.6. How to Report Bugs or Problems

Before posting a bug report about a problem, please try to verify that it is a bug and that it has not been reported already:

- Start by searching the MySQL online manual at <http://dev.mysql.com/doc/>. We try to keep the manual up to date by updating it frequently with solutions to newly found problems. The change history (<http://dev.mysql.com/doc/mysql/en/news.html>) can be particularly useful since it is quite possible that a newer version contains a solution to your problem.
- If you get a parse error for an SQL statement, please check your syntax closely. If you cannot find something wrong with it, it is extremely likely that your current version of MySQL Server doesn't support the syntax you are using. If you are using the current version and the manual doesn't cover the syntax that you are using, MySQL Server doesn't support your statement. In this case, your options are to implement the syntax yourself or email [<licensing@mysql.com>](mailto:licensing@mysql.com) and ask for an offer to implement it.

If the manual covers the syntax you are using, but you have an older version of MySQL Server, you should check the MySQL change history to see when the syntax was implemented. In this case, you have the option of upgrading to a newer version of MySQL Server.

- For solutions to some common problems, see [Section B.1, “Problems and Common Errors”](#).
- Search the bugs database at <http://bugs.mysql.com/> to see whether the bug has been reported and fixed.

- Search the MySQL mailing list archives at <http://lists.mysql.com/>. See [Section 1.5.1, “MySQL Mailing Lists”](#).
- You can also use <http://www.mysql.com/search/> to search all the Web pages (including the manual) that are located at the MySQL Web site.

If you cannot find an answer in the manual, the bugs database, or the mailing list archives, check with your local MySQL expert. If you still cannot find an answer to your question, please use the following guidelines for reporting the bug.

The normal way to report bugs is to visit <http://bugs.mysql.com/>, which is the address for our bugs database. This database is public and can be browsed and searched by anyone. If you log in to the system, you can enter new reports. If you have no Web access, you can generate a bug report by using the `mysqlbug` script described at the end of this section.

Bugs posted in the bugs database at <http://bugs.mysql.com/> that are corrected for a given release are noted in the change history.

If you have found a sensitive security bug in MySQL, you can send email to [<security@mysql.com>](mailto:security@mysql.com).

To discuss problems with other users, you can use one of the MySQL mailing lists. [Section 1.5.1, “MySQL Mailing Lists”](#).

Writing a good bug report takes patience, but doing it right the first time saves time both for us and for yourself. A good bug report, containing a full test case for the bug, makes it very likely that we will fix the bug in the next release. This section helps you write your report correctly so that you do not waste your time doing things that may not help us much or at all. Please read this section carefully and make sure that all the information described here is included in your report.

Preferably, you should test the problem using the latest production or development version of MySQL Server before posting. Anyone should be able to repeat the bug by just using `mysql test < script_file` on your test case or by running the shell or Perl script that you include in the bug report. Any bug that we are able to repeat has a high chance of being fixed in the next MySQL release.

It is most helpful when a good description of the problem is included in the bug report. That is, give a good example of everything you did that led to the problem and describe, in exact detail, the problem itself. The best reports are those that include a full example showing how to reproduce the bug or problem. See [MySQL Internals: Porting](#).

Remember that it is possible for us to respond to a report containing too much information, but not to one containing too little. People often omit facts because they think they know the cause of a problem and assume that some details do not matter. A good principle to follow is that if you are in doubt about stating something, state it. It is faster and less troublesome to write a couple more lines in your report than to wait longer for the answer if we must ask you to provide information that was missing from the initial report.

The most common errors made in bug reports are (a) not including the version number of the MySQL distribution that you use, and (b) not fully describing the platform on which the MySQL server is installed (including the platform type and version number). These are highly relevant pieces of information, and in 99 cases out of 100, the bug report is useless without them. Very often we get questions like, “Why doesn’t this work for me?” Then we find that the feature requested wasn’t implemented in that MySQL version, or that a bug described in a report has been fixed in newer MySQL versions. Errors often are platform-dependent. In such cases, it is next to impossible for us to fix anything without knowing the operating system and the version number of the platform.

If you compiled MySQL from source, remember also to provide information about your compiler if it is related to the problem. Often people find bugs in compilers and think the problem is MySQL-related. Most compilers are under development all the time and become better version by version. To determine whether your problem depends on your compiler, we need to know what compiler you used. Note that every compiling problem should be regarded as a bug and reported accordingly.

If a program produces an error message, it is very important to include the message in your report. If we try to search for something from the archives, it is better that the error message reported exactly matches the one that the program produces. (Even the letter-case should be observed.) It is best to copy and paste the entire error message into your report. You should never try to reproduce the message from memory.

If you have a problem with Connector/ODBC (MyODBC), please try to generate a trace file and send it with your report. See the MyODBC section of [Chapter 20, Connectors and APIs](#).

If your report includes long query output lines from test cases that you run with the `mysql` command-line tool, you can make the output more readable by using the `--vertical` option or the `\G` statement terminator. The [EXPLAIN SELECT](#) example later in this section demonstrates the use of `\G`.

Please include the following information in your report:

- The version number of the MySQL distribution you are using (for example, MySQL 5.0.19). You can find out which version you are running by executing `mysqladmin version`. The `mysqladmin` program can be found in the `bin` directory under your MySQL installation directory.
- The manufacturer and model of the machine on which you experience the problem.

- The operating system name and version. If you work with Windows, you can usually get the name and version number by double-clicking your My Computer icon and pulling down the “Help/About Windows” menu. For most Unix-like operating systems, you can get this information by executing the command `uname -a`.
- Sometimes the amount of memory (real and virtual) is relevant. If in doubt, include these values.
- If you are using a source distribution of the MySQL software, include the name and version number of the compiler that you used. If you have a binary distribution, include the distribution name.
- If the problem occurs during compilation, include the exact error messages and also a few lines of context around the offending code in the file where the error occurs.
- If `mysqld` died, you should also report the statement that crashed `mysqld`. You can usually get this information by running `mysqld` with query logging enabled, and then looking in the log after `mysqld` crashes. See [MySQL Internals: Porting](#).
- If a database table is related to the problem, include the output from the `SHOW CREATE TABLE db_name.tbl_name` statement in the bug report. This is a very easy way to get the definition of any table in a database. The information helps us create a situation matching the one that you have experienced.
- The SQL mode in effect when the problem occurred can be significant, so please report the value of the `sql_mode` system variable. For stored procedure, stored function, and trigger objects, the relevant `sql_mode` value is the one in effect when the object was created. For a stored procedure or function, the `SHOW CREATE PROCEDURE` or `SHOW CREATE FUNCTION` statement shows the relevant SQL mode, or you can query `INFORMATION_SCHEMA` for the information:

```
SELECT ROUTINE_SCHEMA, ROUTINE_NAME, SQL_MODE
FROM INFORMATION_SCHEMA.ROUTINES;
```

For triggers, you can use this statement:

```
SELECT EVENT_OBJECT_SCHEMA, EVENT_OBJECT_TABLE, TRIGGER_NAME, SQL_MODE
FROM INFORMATION_SCHEMA.TRIGGERS;
```

- For performance-related bugs or problems with `SELECT` statements, you should always include the output of `EXPLAIN SELECT ...`, and at least the number of rows that the `SELECT` statement produces. You should also include the output from `SHOW CREATE TABLE tbl_name` for each table that is involved. The more information you provide about your situation, the more likely it is that someone can help you.

The following is an example of a very good bug report. The statements are run using the `mysql` command-line tool. Note the use of the `\G` statement terminator for statements that would otherwise provide very long output lines that are difficult to read.

```
mysql> SHOW VARIABLES;
mysql> SHOW COLUMNS FROM ...\G
<output from SHOW COLUMNS>
mysql> EXPLAIN SELECT ...\G
<output from EXPLAIN>
mysql> FLUSH STATUS;
mysql> SELECT ...;
<A short version of the output from SELECT,
including the time taken to run the query>
mysql> SHOW STATUS;
<output from SHOW STATUS>
```

- If a bug or problem occurs while running `mysqld`, try to provide an input script that reproduces the anomaly. This script should include any necessary source files. The more closely the script can reproduce your situation, the better. If you can make a reproducible test case, you should upload it to be attached to the bug report.
- If you cannot provide a script, you should at least include the output from `mysqladmin variables extended-status processlist` in your report to provide some information on how your system is performing.
- If you cannot produce a test case with only a few rows, or if the test table is too big to be included in the bug report (more than 10 rows), you should dump your tables using `mysqldump` and create a `README` file that describes your problem. Create a compressed archive of your files using `tar` and `gzip` or `zip`, and use FTP to transfer the archive to <ftp://ftp.mysql.com/pub/mysql/upload/>. Then enter the problem into our bugs database at <http://bugs.mysql.com/>.
  - If you believe that the MySQL server produces a strange result from a statement, include not only the result, but also your opinion of what the result should be, and an explanation describing the basis for your opinion.
  - When you provide an example of the problem, it is better to use the table names, variable names, and so forth that exist in your actual situation than to come up with new names. The problem could be related to the name of a table or variable. These cases are rare, perhaps, but it is better to be safe than sorry. After all, it should be easier for you to provide an example that uses your actual situation, and it is by all means better for us. If you have data that you do not want to be visible to others in the bug report, you can use FTP to transfer it to <ftp://ftp.mysql.com/pub/mysql/upload/>. If the information is really top secret and you do not want to show it even to us, go ahead and provide an example using other names, but please regard this as the last choice.



- Include all the options given to the relevant programs, if possible. For example, indicate the options that you use when you start the `mysqld` server, as well as the options that you use to run any MySQL client programs. The options to programs such as `mysqld` and `mysql`, and to the `configure` script, are often key to resolving problems and are very relevant. It is never a bad idea to include them. If your problem involves a program written in a language such as Perl or PHP, please include the language processor's version number, as well as the version for any modules that the program uses. For example, if you have a Perl script that uses the `DBI` and `DBD: :mysql` modules, include the version numbers for Perl, `DBI`, and `DBD: :mysql`.
- If your question is related to the privilege system, please include the output of `mysqlaccess`, the output of `mysqladmin reload`, and all the error messages you get when trying to connect. When you test your privileges, you should first run `mysqlaccess`. After this, execute `mysqladmin reload version` and try to connect with the program that gives you trouble. `mysqlaccess` can be found in the `bin` directory under your MySQL installation directory.
- If you have a patch for a bug, do include it. But do not assume that the patch is all we need, or that we can use it, if you do not provide some necessary information such as test cases showing the bug that your patch fixes. We might find problems with your patch or we might not understand it at all. If so, we cannot use it.

If we cannot verify the exact purpose of the patch, we will not use it. Test cases help us here. Show that the patch handles all the situations that may occur. If we find a borderline case (even a rare one) where the patch will not work, it may be useless.

- Guesses about what the bug is, why it occurs, or what it depends on are usually wrong. Even the MySQL team cannot guess such things without first using a debugger to determine the real cause of a bug.
- Indicate in your bug report that you have checked the reference manual and mail archive so that others know you have tried to solve the problem yourself.
- If the problem is that your data appears corrupt or you get errors when you access a particular table, you should first check your tables and then try to repair them with `CHECK TABLE` and `REPAIR TABLE` or with `myisamchk`. See [Chapter 5, MySQL Server Administration](#).

If you are running Windows, please verify the value of `lower_case_table_names` using the `SHOW VARIABLES LIKE 'lower_case_table_names'` statement. This variable affects how the server handles lettercase of database and table names. Its effect for a given value should be as described in [Section 8.2.2, "Identifier Case Sensitivity"](#).

- If you often get corrupted tables, you should try to find out when and why this happens. In this case, the error log in the MySQL data directory may contain some information about what happened. (This is the file with the `.err` suffix in the name.) See [Section 5.2.2, "The Error Log"](#). Please include any relevant information from this file in your bug report. Normally `mysqld` should *never* crash a table if nothing killed it in the middle of an update. If you can find the cause of `mysqld` dying, it is much easier for us to provide you with a fix for the problem. See [Section B.1.1, "How to Determine What Is Causing a Problem"](#).
- If possible, download and install the most recent version of MySQL Server and check whether it solves your problem. All versions of the MySQL software thoroughly tested and should work without problems. We believe in making everything as backward-compatible as possible, and you should be able to switch MySQL versions without difficulty. See [Section 2.1.2, "Choosing Which MySQL Distribution to Install"](#).

If you have no Web access and cannot report a bug by visiting <http://bugs.mysql.com/>, you can use the `mysqlbug` script to generate a bug report (or a report about any problem). `mysqlbug` helps you generate a report by determining much of the following information automatically, but if something important is missing, please include it with your message. `mysqlbug` can be found in the `scripts` directory (source distribution) and in the `bin` directory under your MySQL installation directory (binary distribution).

## 1.7. MySQL Standards Compliance

This section describes how MySQL relates to the ANSI/ISO SQL standards. MySQL Server has many extensions to the SQL standard, and here you can find out what they are and how to use them. You can also find information about functionality missing from MySQL Server, and how to work around some of the differences.

The SQL standard has been evolving since 1986 and several versions exist. In this manual, "SQL-92" refers to the standard released in 1992, "SQL:1999" refers to the standard released in 1999, "SQL:2003" refers to the standard released in 2003, and "SQL:2008" refers to the most recent version of the standard, released in 2008. We use the phrase "the SQL standard" or "standard SQL" to mean the current version of the SQL Standard at any time.

One of our main goals with the product is to continue to work toward compliance with the SQL standard, but without sacrificing speed or reliability. We are not afraid to add extensions to SQL or support for non-SQL features if this greatly increases the usability of MySQL Server for a large segment of our user base. The `HANDLER` interface is an example of this strategy. See [Section 12.2.4, "HANDLER Syntax"](#).

We continue to support transactional and non-transactional databases to satisfy both mission-critical 24/7 usage and heavy Web or logging usage.

MySQL Server was originally designed to work with medium-sized databases (10-100 million rows, or about 100MB per table) on small computer systems. Today MySQL Server handles terabyte-sized databases, but the code can also be compiled in a reduced version suitable for hand-held and embedded devices. The compact design of the MySQL server makes development in both directions possible without any conflicts in the source tree.

Currently, we are not targeting real-time support, although MySQL replication capabilities offer significant functionality.

MySQL supports high-availability database clustering using the `NDBCLUSTER` storage engine. See [MySQL Cluster NDB 6.X/7.X](#).

We are implementing XML functionality beginning in MySQL 5.1, which supports most of the W3C XPath standard. We plan to increase support for XML as part of future MySQL development. See [Section 11.10, “XML Functions”](#).

### 1.7.1. What Standards MySQL Follows

Our aim is to support the full ANSI/ISO SQL standard, but without making concessions to speed and quality of the code.

ODBC levels 0-3.51.

### 1.7.2. Selecting SQL Modes

The MySQL server can operate in different SQL modes, and can apply these modes differentially for different clients. This capability enables each application to tailor the server's operating mode to its own requirements.

SQL modes control aspects of server operation such as what SQL syntax MySQL should support and what kind of data validation checks it should perform. This makes it easier to use MySQL in different environments and to use MySQL together with other database servers.

You can set the default SQL mode by starting `mysqld` with the `--sql-mode="mode_value"` option. You can also change the mode at runtime by setting the `sql_mode` system variable with a `SET [GLOBAL|SESSION] sql_mode='mode_value'` statement.

For more information on setting the SQL mode, see [Section 5.1.7, “Server SQL Modes”](#).

### 1.7.3. Running MySQL in ANSI Mode

You can tell `mysqld` to run in ANSI mode with the `--ansi` startup option. Running the server in ANSI mode is the same as starting it with the following options:

```
--transaction-isolation=SERIALIZABLE --sql-mode=ANSI
```

You can achieve the same effect at runtime by executing these two statements:

```
SET GLOBAL TRANSACTION ISOLATION LEVEL SERIALIZABLE;
SET GLOBAL sql_mode = 'ANSI';
```

You can see that setting the `sql_mode` system variable to `'ANSI'` enables all SQL mode options that are relevant for ANSI mode as follows:

```
mysql> SET GLOBAL sql_mode='ANSI';
mysql> SELECT @@global.sql_mode;
-> 'REAL_AS_FLOAT,PIPES_AS_CONCAT,ANSI_QUOTES,IGNORE_SPACE,ANSI'
```

Note that running the server in ANSI mode with `--ansi` is not quite the same as setting the SQL mode to `'ANSI'`. The `--ansi` option affects the SQL mode and also sets the transaction isolation level. Setting the SQL mode to `'ANSI'` has no effect on the isolation level.

See [Section 5.1.2, “Server Command Options”](#), and [Section 1.7.2, “Selecting SQL Modes”](#).

### 1.7.4. MySQL Extensions to Standard SQL

MySQL Server supports some extensions that you probably won't find in other SQL DBMSs. Be warned that if you use them, your code won't be portable to other SQL servers. In some cases, you can write code that includes MySQL extensions, but is still portable, by using comments of the following form:

```
/*! MySQL-specific code */
```

In this case, MySQL Server parses and executes the code within the comment as it would any other SQL statement, but other SQL servers will ignore the extensions. For example, MySQL Server recognizes the `STRAIGHT_JOIN` keyword in the following state-

ment, but other servers will not:

```
SELECT /*! STRAIGHT_JOIN */ col1 FROM table1,table2 WHERE ...
```

If you add a version number after the “!” character, the syntax within the comment is executed only if the MySQL version is greater than or equal to the specified version number. The `TEMPORARY` keyword in the following comment is executed only by servers from MySQL 3.23.02 or higher:

```
CREATE /*!32302 TEMPORARY */ TABLE t (a INT);
```

The following descriptions list MySQL extensions, organized by category.

- Organization of data on disk

MySQL Server maps each database to a directory under the MySQL data directory, and maps tables within a database to file names in the database directory. This has a few implications:

- Database and table names are case sensitive in MySQL Server on operating systems that have case-sensitive file names (such as most Unix systems). See [Section 8.2.2, “Identifier Case Sensitivity”](#).
- You can use standard system commands to back up, rename, move, delete, and copy tables that are managed by the `MyISAM` storage engine. For example, it is possible to rename a `MyISAM` table by renaming the `.MYD`, `.MYI`, and `.frm` files to which the table corresponds. (Nevertheless, it is preferable to use `RENAME TABLE` or `ALTER TABLE ... RENAME` and let the server rename the files.)

Prior to MySQL 5.1.6, database and table names cannot contain path name separator characters (“/”, “\”).

- General language syntax

- By default, strings can be enclosed by either “” or ‘’, not just by ‘’. (If the `ANSI_QUOTES` SQL mode is enabled, strings can be enclosed only by ‘’ and the server interprets strings enclosed by “” as identifiers.)
- “\” is the escape character in strings.
- In SQL statements, you can access tables from different databases with the `db_name.tbl_name` syntax. Some SQL servers provide the same functionality but call this `User space`. MySQL Server doesn’t support tablespaces such as used in statements like this: `CREATE TABLE ralph.my_table ... IN my_tablespace`.

- SQL statement syntax

- The `ANALYZE TABLE`, `CHECK TABLE`, `OPTIMIZE TABLE`, and `REPAIR TABLE` statements.
- The `CREATE DATABASE`, `DROP DATABASE`, and `ALTER DATABASE` statements. See [Section 12.1.10, “CREATE DATABASE Syntax”](#), [Section 12.1.21, “DROP DATABASE Syntax”](#), and [Section 12.1.1, “ALTER DATABASE Syntax”](#).
- The `DO` statement.
- `EXPLAIN SELECT` to obtain a description of how tables are processed by the query optimizer.
- The `FLUSH` and `RESET` statements.
- The `SET` statement. See [Section 12.5.4, “SET Syntax”](#).
- The `SHOW` statement. See [Section 12.5.5, “SHOW Syntax”](#). As of MySQL 5.0, the information produced by many of the MySQL-specific `SHOW` statements can be obtained in more standard fashion by using `SELECT` to query `INFORMATION_SCHEMA`. See [Chapter 19, `INFORMATION\_SCHEMA` Tables](#).
- Use of `LOAD DATA INFILE`. In many cases, this syntax is compatible with Oracle’s `LOAD DATA INFILE`. See [Section 12.2.6, “LOAD DATA INFILE Syntax”](#).
- Use of `RENAME TABLE`. See [Section 12.1.33, “RENAME TABLE Syntax”](#).
- Use of `REPLACE` instead of `DELETE` plus `INSERT`. See [Section 12.2.7, “REPLACE Syntax”](#).
- Use of `CHANGE col_name`, `DROP col_name`, or `DROP INDEX, IGNORE` or `RENAME` in `ALTER TABLE` statements. Use of multiple `ADD`, `ALTER`, `DROP`, or `CHANGE` clauses in an `ALTER TABLE` statement. See [Section 12.1.7, “ALTER TABLE Syntax”](#).
- Use of index names, indexes on a prefix of a column, and use of `INDEX` or `KEY` in `CREATE TABLE` statements. See [Section 12.1.17, “CREATE TABLE Syntax”](#).

- Use of `TEMPORARY` or `IF NOT EXISTS` with `CREATE TABLE`.
- Use of `IF EXISTS` with `DROP TABLE` and `DROP DATABASE`.
- The capability of dropping multiple tables with a single `DROP TABLE` statement.
- The `ORDER BY` and `LIMIT` clauses of the `UPDATE` and `DELETE` statements.
- `INSERT INTO tbl_name SET col_name = ...` syntax.
- The `DELAYED` clause of the `INSERT` and `REPLACE` statements.
- The `LOW_PRIORITY` clause of the `INSERT`, `REPLACE`, `DELETE`, and `UPDATE` statements.
- Use of `INTO OUTFILE` or `INTO DUMPFILE` in `SELECT` statements. See [Section 12.2.8, “SELECT Syntax”](#).
- Options such as `STRAIGHT_JOIN` or `SQL_SMALL_RESULT` in `SELECT` statements.
- You don't need to name all selected columns in the `GROUP BY` clause. This gives better performance for some very specific, but quite normal queries. See [Section 11.12, “Functions and Modifiers for Use with GROUP BY Clauses”](#).
- You can specify `ASC` and `DESC` with `GROUP BY`, not just with `ORDER BY`.
- The ability to set variables in a statement with the `:=` assignment operator:

```
mysql> SELECT @a:=SUM(total),@b:=COUNT(*),@a/@b AS avg
-> FROM test_table;
mysql> SELECT @t1:=(@t2:=1)+@t3:=4,@t1,@t2,@t3;
```

- Data types
  - The `MEDIUMINT`, `SET`, and `ENUM` data types, and the various `BLOB` and `TEXT` data types.
  - The `AUTO_INCREMENT`, `BINARY`, `NULL`, `UNSIGNED`, and `ZEROFILL` data type attributes.
- Functions and operators
  - To make it easier for users who migrate from other SQL environments, MySQL Server supports aliases for many functions. For example, all string functions support both standard SQL syntax and ODBC syntax.
  - MySQL Server understands the `||` and `&&` operators to mean logical OR and AND, as in the C programming language. In MySQL Server, `||` and `OR` are synonyms, as are `&&` and `AND`. Because of this nice syntax, MySQL Server doesn't support the standard SQL `||` operator for string concatenation; use `CONCAT()` instead. Because `CONCAT()` takes any number of arguments, it is easy to convert use of the `||` operator to MySQL Server.
  - Use of `COUNT(DISTINCT value_list)` where `value_list` has more than one element.
  - String comparisons are case-insensitive by default, with sort ordering determined by the collation of the current character set, which is `latin1` (cp1252 West European) by default. If you don't like this, you should declare your columns with the `BINARY` attribute or use the `BINARY` cast, which causes comparisons to be done using the underlying character code values rather than a lexical ordering.
  - The `%` operator is a synonym for `MOD()`. That is, `N % M` is equivalent to `MOD(N,M)`. `%` is supported for C programmers and for compatibility with PostgreSQL.
  - The `=`, `<>`, `<=`, `<`, `>=`, `>`, `<<`, `>>`, `<=>`, `AND`, `OR`, or `LIKE` operators may be used in expressions in the output column list (to the left of the `FROM`) in `SELECT` statements. For example:
 

```
mysql> SELECT col1=1 AND col2=2 FROM my_table;
```
  - The `LAST_INSERT_ID()` function returns the most recent `AUTO_INCREMENT` value. See [Section 11.11.3, “Information Functions”](#).
  - `LIKE` is allowed on numeric values.
  - The `REGEXP` and `NOT REGEXP` extended regular expression operators.
  - `CONCAT()` or `CHAR()` with one argument or more than two arguments. (In MySQL Server, these functions can take a variable number of arguments.)

- The `BIT_COUNT()`, `CASE`, `ELT()`, `FROM_DAYS()`, `FORMAT()`, `IF()`, `PASSWORD()`, `ENCRYPT()`, `MD5()`, `ENCODE()`, `DECODE()`, `PERIOD_ADD()`, `PERIOD_DIFF()`, `TO_DAYS()`, and `WEEKDAY()` functions.
- Use of `TRIM()` to trim substrings. Standard SQL supports removal of single characters only.
- The `GROUP BY` functions `STD()`, `BIT_OR()`, `BIT_AND()`, `BIT_XOR()`, and `GROUP_CONCAT()`. See [Section 11.12, “Functions and Modifiers for Use with GROUP BY Clauses”](#).

For a prioritized list indicating when new extensions are added to MySQL Server, you should consult the online MySQL development roadmap at <http://dev.mysql.com/doc/mysql/en/roadmap.html>.

## 1.7.5. MySQL Differences from Standard SQL

We try to make MySQL Server follow the ANSI SQL standard and the ODBC SQL standard, but MySQL Server performs operations differently in some cases:

- There are several differences between the MySQL and standard SQL privilege systems. For example, in MySQL, privileges for a table are not automatically revoked when you delete a table. You must explicitly issue a `REVOKE` statement to revoke privileges for a table. For more information, see [Section 12.5.1.5, “REVOKE Syntax”](#).
- The `CAST()` function does not support cast to `REAL` or `BIGINT`. See [Section 11.9, “Cast Functions and Operators”](#).

### 1.7.5.1. SELECT INTO TABLE

MySQL Server doesn't support the `SELECT ... INTO TABLE` Sybase SQL extension. Instead, MySQL Server supports the `INSERT INTO ... SELECT` standard SQL syntax, which is basically the same thing. See [Section 12.2.5.1, “INSERT ... SELECT Syntax”](#). For example:

```
INSERT INTO tbl_temp2 (fld_id)
SELECT tbl_temp1.fld_order_id
FROM tbl_temp1 WHERE tbl_temp1.fld_order_id > 100;
```

Alternatively, you can use `SELECT ... INTO OUTFILE` or `CREATE TABLE ... SELECT`.

As of MySQL 5.0, you can use `SELECT ... INTO` with user-defined variables. The same syntax can also be used inside stored routines using cursors and local variables. See [Section 12.8.3.3, “SELECT ... INTO Statement”](#).

### 1.7.5.2. Transactions and Atomic Operations

MySQL Server (version 3.23-max and all versions 4.0 and above) supports transactions with the `InnoDB` transactional storage engine. `InnoDB` provides *full* ACID compliance. See [Chapter 13, Storage Engines](#). For information about `InnoDB` differences from standard SQL with regard to treatment of transaction errors, see [Section 13.6.12, “InnoDB Error Handling”](#).

The other non-transactional storage engines in MySQL Server (such as `MyISAM`) follow a different paradigm for data integrity called “atomic operations.” In transactional terms, `MyISAM` tables effectively always operate in `autocommit = 1` mode. Atomic operations often offer comparable integrity with higher performance.

Because MySQL Server supports both paradigms, you can decide whether your applications are best served by the speed of atomic operations or the use of transactional features. This choice can be made on a per-table basis.

As noted, the tradeoff for transactional versus non-transactional storage engines lies mostly in performance. Transactional tables have significantly higher memory and disk space requirements, and more CPU overhead. On the other hand, transactional storage engines such as `InnoDB` also offer many significant features. MySQL Server's modular design allows the concurrent use of different storage engines to suit different requirements and deliver optimum performance in all situations.

#### MySQL Enterprise

For expert advice on choosing and tuning storage engines, subscribe to the MySQL Enterprise Monitor. For more information, see <http://www.mysql.com/products/enterprise/advisors.html>.

But how do you use the features of MySQL Server to maintain rigorous integrity even with the non-transactional `MyISAM` tables, and how do these features compare with the transactional storage engines?

- If your applications are written in a way that is dependent on being able to call `ROLLBACK` rather than `COMMIT` in critical situations, transactions are more convenient. Transactions also ensure that unfinished updates or corrupting activities are not committed to the database; the server is given the opportunity to do an automatic rollback and your database is saved.

If you use non-transactional tables, MySQL Server in almost all cases allows you to resolve potential problems by including simple checks before updates and by running simple scripts that check the databases for inconsistencies and automatically repair or warn if such an inconsistency occurs. Note that just by using the MySQL log or even adding one extra log, you can normally fix tables perfectly with no data integrity loss.

- More often than not, critical transactional updates can be rewritten to be atomic. Generally speaking, all integrity problems that transactions solve can be done with `LOCK TABLES` or atomic updates, ensuring that there are no automatic aborts from the server, which is a common problem with transactional database systems.
- To be safe with MySQL Server, regardless of whether you use transactional tables, you only need to have backups and have binary logging turned on. When that is true, you can recover from any situation that you could with any other transactional database system. It is always good to have backups, regardless of which database system you use.

The transactional paradigm has its advantages and disadvantages. Many users and application developers depend on the ease with which they can code around problems where an abort appears to be necessary, or is necessary. However, even if you are new to the atomic operations paradigm, or more familiar with transactions, do consider the speed benefit that non-transactional tables can offer on the order of three to five times the speed of the fastest and most optimally tuned transactional tables.

In situations where integrity is of highest importance, MySQL Server offers transaction-level reliability and integrity even for non-transactional tables. If you lock tables with `LOCK TABLES`, all updates stall until integrity checks are made. If you obtain a `READ LOCAL` lock (as opposed to a write lock) for a table that allows concurrent inserts at the end of the table, reads are allowed, as are inserts by other clients. The newly inserted records are not be seen by the client that has the read lock until it releases the lock. With `INSERT DELAYED`, you can write inserts that go into a local queue until the locks are released, without having the client wait for the insert to complete. See [Section 7.3.3, “Concurrent Inserts”](#), and [Section 12.2.5.2, “INSERT DELAYED Syntax”](#).

“Atomic,” in the sense that we mean it, is nothing magical. It only means that you can be sure that while each specific update is running, no other user can interfere with it, and there can never be an automatic rollback (which can happen with transactional tables if you are not very careful). MySQL Server also guarantees that there are no dirty reads.

Following are some techniques for working with non-transactional tables:

- Loops that need transactions normally can be coded with the help of `LOCK TABLES`, and you don't need cursors to update records on the fly.
- To avoid using `ROLLBACK`, you can employ the following strategy:
  1. Use `LOCK TABLES` to lock all the tables you want to access.
  2. Test the conditions that must be true before performing the update.
  3. Update if the conditions are satisfied.
  4. Use `UNLOCK TABLES` to release your locks.

This is usually a much faster method than using transactions with possible rollbacks, although not always. The only situation this solution doesn't handle is when someone kills the threads in the middle of an update. In that case, all locks are released but some of the updates may not have been executed.

- You can also use functions to update records in a single operation. You can get a very efficient application by using the following techniques:
  - Modify columns relative to their current value.
  - Update only those columns that actually have changed.

For example, when we are updating customer information, we update only the customer data that has changed and test only that none of the changed data, or data that depends on the changed data, has changed compared to the original row. The test for changed data is done with the `WHERE` clause in the `UPDATE` statement. If the record wasn't updated, we give the client a message: “Some of the data you have changed has been changed by another user.” Then we show the old row versus the new row in a window so that the user can decide which version of the customer record to use.

This gives us something that is similar to column locking but is actually even better because we only update some of the columns, using values that are relative to their current values. This means that typical `UPDATE` statements look something like these:

```
UPDATE tablename SET pay_back=pay_back+125;

UPDATE customer
SET
  customer_date='current_date',
```



```

address='new address',
phone='new phone',
money_owed_to_us=money_owed_to_us-125
WHERE
customer_id=id AND address='old address' AND phone='old phone';

```

This is very efficient and works even if another client has changed the values in the `pay_back` or `money_owed_to_us` columns.

- In many cases, users have wanted `LOCK TABLES` or `ROLLBACK` for the purpose of managing unique identifiers. This can be handled much more efficiently without locking or rolling back by using an `AUTO_INCREMENT` column and either the `LAST_INSERT_ID()` SQL function or the `mysql_insert_id()` C API function. See [Section 11.11.3, “Information Functions”](#), and [Section 20.10.3.37, “mysql\\_insert\\_id\(\)”](#).

You can generally code around the need for row-level locking. Some situations really do need it, and `InnoDB` tables support row-level locking. Otherwise, with `MyISAM` tables, you can use a flag column in the table and do something like the following:

```
UPDATE tbl_name SET row_flag=1 WHERE id=ID;
```

MySQL returns `1` for the number of affected rows if the row was found and `row_flag` wasn't `1` in the original row. You can think of this as though MySQL Server changed the preceding statement to:

```
UPDATE tbl_name SET row_flag=1 WHERE id=ID AND row_flag <> 1;
```

### 1.7.5.3. Stored Routines and Triggers

Stored procedures and functions are implemented beginning with MySQL 5.0. See [Section 18.2, “Using Stored Routines \(Procedures and Functions\)”](#).

Basic trigger functionality is implemented beginning with MySQL 5.0.2, with further development planned for MySQL 5.1. See [Section 18.3, “Using Triggers”](#).

### 1.7.5.4. Foreign Keys

The `InnoDB` storage engine supports checking of foreign key constraints, including `CASCADE`, `ON DELETE`, and `ON UPDATE`. See [Section 13.6.4.4, “FOREIGN KEY Constraints”](#).

For storage engines other than `InnoDB`, MySQL Server parses the `FOREIGN KEY` syntax in `CREATE TABLE` statements, but does not use or store it. In the future, the implementation will be extended to store this information in the table specification file so that it may be retrieved by `mysqldump` and ODBC. At a later stage, foreign key constraints will be implemented for `MyISAM` tables as well.

Foreign key enforcement offers several benefits to database developers:

- Assuming proper design of the relationships, foreign key constraints make it more difficult for a programmer to introduce an inconsistency into the database.
- Centralized checking of constraints by the database server makes it unnecessary to perform these checks on the application side. This eliminates the possibility that different applications may not all check the constraints in the same way.
- Using cascading updates and deletes can simplify the application code.
- Properly designed foreign key rules aid in documenting relationships between tables.

Do keep in mind that these benefits come at the cost of additional overhead for the database server to perform the necessary checks. Additional checking by the server affects performance, which for some applications may be sufficiently undesirable as to be avoided if possible. (Some major commercial applications have coded the foreign key logic at the application level for this reason.)

MySQL gives database developers the choice of which approach to use. If you don't need foreign keys and want to avoid the overhead associated with enforcing referential integrity, you can choose another storage engine instead, such as `MyISAM`. (For example, the `MyISAM` storage engine offers very fast performance for applications that perform only `INSERT` and `SELECT` operations. In this case, the table has no holes in the middle and the inserts can be performed concurrently with retrievals. See [Section 7.3.3, “Concurrent Inserts”](#).)

If you choose not to take advantage of referential integrity checks, keep the following considerations in mind:



- In the absence of server-side foreign key relationship checking, the application itself must handle relationship issues. For example, it must take care to insert rows into tables in the proper order, and to avoid creating orphaned child records. It must also be able to recover from errors that occur in the middle of multiple-record insert operations.
- If `ON DELETE` is the only referential integrity capability an application needs, you can achieve a similar effect as of MySQL Server 4.0 by using multiple-table `DELETE` statements to delete rows from many tables with a single statement. See [Section 12.2.2, “DELETE Syntax”](#).
- A workaround for the lack of `ON DELETE` is to add the appropriate `DELETE` statements to your application when you delete records from a table that has a foreign key. In practice, this is often as quick as using foreign keys and is more portable.

Be aware that the use of foreign keys can sometimes lead to problems:

- Foreign key support addresses many referential integrity issues, but it is still necessary to design key relationships carefully to avoid circular rules or incorrect combinations of cascading deletes.
- It is not uncommon for a DBA to create a topology of relationships that makes it difficult to restore individual tables from a backup. (MySQL alleviates this difficulty by allowing you to temporarily disable foreign key checks when reloading a table that depends on other tables. See [Section 13.6.4.4, “FOREIGN KEY Constraints”](#). As of MySQL 4.1.1, `mysqldump` generates dump files that take advantage of this capability automatically when they are reloaded.)

Note that foreign keys in SQL are used to check and enforce referential integrity, not to join tables. If you want to get results from multiple tables from a `SELECT` statement, you do this by performing a join between them:

```
SELECT * FROM t1 INNER JOIN t2 ON t1.id = t2.id;
```

See [Section 12.2.8.1, “JOIN Syntax”](#), and [Section 3.6.6, “Using Foreign Keys”](#).

The `FOREIGN KEY` syntax without `ON DELETE . . .` is often used by ODBC applications to produce automatic `WHERE` clauses.

### 1.7.5.5. Views

Views (including updatable views) are implemented beginning with MySQL Server 5.0.1. See [Section 18.5, “Using Views”](#).

Views are useful for allowing users to access a set of relations (tables) as if it were a single table, and limiting their access to just that. Views can also be used to restrict access to rows (a subset of a particular table). For access control to columns, you can also use the sophisticated privilege system in MySQL Server. See [Section 5.4, “The MySQL Access Privilege System”](#).

In designing an implementation of views, our ambitious goal, as much as is possible within the confines of SQL, has been full compliance with “Codd’s Rule #6” for relational database systems: “All views that are theoretically updatable, should in practice also be updatable.”

### 1.7.5.6. '--' as the Start of a Comment

Standard SQL uses the C syntax `/* this is a comment */` for comments, and MySQL Server supports this syntax as well. MySQL also support extensions to this syntax that allow MySQL-specific SQL to be embedded in the comment, as described in [Section 8.5, “Comment Syntax”](#).

Standard SQL uses `--` as a start-comment sequence. MySQL Server uses `#` as the start comment character. MySQL Server 3.23.3 and up also supports a variant of the `--` comment style. That is, the `--` start-comment sequence must be followed by a space (or by a control character such as a newline). The space is required to prevent problems with automatically generated SQL queries that use constructs such as the following, where we automatically insert the value of the payment for `payment`:

```
UPDATE account SET credit=credit-payment
```

Consider about what happens if `payment` has a negative value such as `-1`:

```
UPDATE account SET credit=credit--1
```

`credit--1` is a legal expression in SQL, but `--` is interpreted as the start of a comment, part of the expression is discarded. The result is a statement that has a completely different meaning than intended:

```
UPDATE account SET credit=credit
```

The statement produces no change in value at all. This illustrates that allowing comments to start with `--` can have serious consequences.

Using our implementation requires a space following the “--” in order for it to be recognized as a start-comment sequence in MySQL Server 3.23.3 and newer. Therefore, `credit--1` is safe to use.

Another safe feature is that the `mysql` command-line client ignores lines that start with “--”.

The following information is relevant only if you are running a MySQL version earlier than 3.23.3:

If you have an SQL script in a text file that contains “--” comments, you should use the `replace` utility as follows to convert the comments to use “#” characters before executing the script:

```
shell> replace " --" " #" < text-file-with-funny-comments.sql \
| mysql db_name
```

That is safer than executing the script in the usual way:

```
shell> mysql db_name < text-file-with-funny-comments.sql
```

You can also edit the script file “in place” to change the “--” comments to “#” comments:

```
shell> replace " --" " #" -- text-file-with-funny-comments.sql
```

Change them back with this command:

```
shell> replace " #" " --" -- text-file-with-funny-comments.sql
```

See [Section 4.8.2, “replace — A String-Replacement Utility”](#).

## 1.7.6. How MySQL Deals with Constraints

MySQL allows you to work both with transactional tables that allow rollback and with non-transactional tables that do not. Because of this, constraint handling is a bit different in MySQL than in other DBMSs. We must handle the case when you have inserted or updated a lot of rows in a non-transactional table for which changes cannot be rolled back when an error occurs.

The basic philosophy is that MySQL Server tries to produce an error for anything that it can detect while parsing a statement to be executed, and tries to recover from any errors that occur while executing the statement. We do this in most cases, but not yet for all.

The options MySQL has when an error occurs are to stop the statement in the middle or to recover as well as possible from the problem and continue. By default, the server follows the latter course. This means, for example, that the server may coerce illegal values to the closest legal values.

Several SQL mode options are available to provide greater control over handling of bad data values and whether to continue statement execution or abort when errors occur. Using these options, you can configure MySQL Server to act in a more traditional fashion that is like other DBMSs that reject improper input. The SQL mode can be set globally at server startup to affect all clients. Individual clients can set the SQL mode at runtime, which enables each client to select the behavior most appropriate for its requirements. See [Section 5.1.7, “Server SQL Modes”](#).

### MySQL Enterprise

To be alerted when there is no form of server-enforced data integrity, subscribe to the MySQL Enterprise Monitor. For more information, see <http://www.mysql.com/products/enterprise/advisors.html>.

The following sections describe how MySQL Server handles different types of constraints.

### 1.7.6.1. PRIMARY KEY and UNIQUE Index Constraints

Normally, errors occur for data-change statements (such as `INSERT` or `UPDATE`) that would violate primary-key, unique-key, or foreign-key constraints. If you are using a transactional storage engine such as `InnoDB`, MySQL automatically rolls back the statement. If you are using a non-transactional storage engine, MySQL stops processing the statement at the row for which the error occurred and leaves any remaining rows unprocessed.

MySQL supports an `IGNORE` keyword for `INSERT`, `UPDATE`, and so forth. If you use it, MySQL ignores primary-key or unique-key violations and continues processing with the next row. See the section for the statement that you are using ([Section 12.2.5, “INSERT Syntax”](#), [Section 12.2.11, “UPDATE Syntax”](#), and so forth).

You can get information about the number of rows actually inserted or updated with the `mysql_info()` C API function. You can also use the `SHOW WARNINGS` statement. See [Section 20.10.3.35, “mysql\\_info\(\)”](#), and [Section 12.5.5.42, “SHOW WARNINGS Syntax”](#).

Currently, only `InnoDB` tables support foreign keys. See [Section 13.6.4.4, “FOREIGN KEY Constraints”](#). We plan to add foreign

key support by other storage engines in a future MySQL release. See [Section 1.4, “MySQL Development Roadmap”](#).

### 1.7.6.2. Constraints on Invalid Data

By default, MySQL is forgiving of illegal or improper data values and coerces them to legal values for data entry. However, you can change the server SQL mode to select more traditional treatment of bad values such that the server rejects them and aborts the statement in which they occur. See [Section 5.1.7, “Server SQL Modes”](#).

This section describes the default (forgiving) behavior of MySQL, as well as the strict SQL mode and how it differs.

If you are not using strict mode, then whenever you insert an “incorrect” value into a column, such as a `NULL` into a `NOT NULL` column or a too-large numeric value into a numeric column, MySQL sets the column to the “best possible value” instead of producing an error: The following rules describe in more detail how this works:

- If you try to store an out of range value into a numeric column, MySQL Server instead stores zero, the smallest possible value, or the largest possible value, whichever is closest to the invalid value.
- For strings, MySQL stores either the empty string or as much of the string as can be stored in the column.
- If you try to store a string that doesn't start with a number into a numeric column, MySQL Server stores 0.
- Invalid values for `ENUM` and `SET` columns are handled as described in [Section 1.7.6.3, “ENUM and SET Constraints”](#).
- MySQL allows you to store certain incorrect date values into `DATE` and `DATETIME` columns (such as `'2000-02-31'` or `'2000-02-00'`). The idea is that it is not the job of the SQL server to validate dates. If MySQL can store a date value and retrieve exactly the same value, MySQL stores it as given. If the date is totally wrong (outside the server's ability to store it), the special “zero” date value `'0000-00-00'` is stored in the column instead.
- If you try to store `NULL` into a column that doesn't take `NULL` values, an error occurs for single-row `INSERT` statements. For multiple-row `INSERT` statements or for `INSERT INTO ... SELECT` statements, MySQL Server stores the implicit default value for the column data type. In general, this is 0 for numeric types, the empty string (`' '`) for string types, and the “zero” value for date and time types. Implicit default values are discussed in [Section 10.1.4, “Data Type Default Values”](#).
- If an `INSERT` statement specifies no value for a column, MySQL inserts its default value if the column definition includes an explicit `DEFAULT` clause. If the definition has no such `DEFAULT` clause, MySQL inserts the implicit default value for the column data type.

The reason for using the preceding rules in non-strict mode is that we can't check these conditions until the statement has begun executing. We can't just roll back if we encounter a problem after updating a few rows, because the storage engine may not support rollback. The option of terminating the statement is not that good; in this case, the update would be “half done,” which is probably the worst possible scenario. In this case, it is better to “do the best you can” and then continue as if nothing happened.

In MySQL 5.0.2 and up, you can select stricter treatment of input values by using the `STRICT_TRANS_TABLES` or `STRICT_ALL_TABLES` SQL modes:

```
SET sql_mode = 'STRICT_TRANS_TABLES';
SET sql_mode = 'STRICT_ALL_TABLES';
```

`STRICT_TRANS_TABLES` enables strict mode for transactional storage engines, and also to some extent for non-transactional engines. It works like this:

- For transactional storage engines, bad data values occurring anywhere in a statement cause the statement to abort and roll back.
- For non-transactional storage engines, a statement aborts if the error occurs in the first row to be inserted or updated. (When the error occurs in the first row, the statement can be aborted to leave the table unchanged, just as for a transactional table.) Errors in rows after the first do not abort the statement, because the table has already been changed by the first row. Instead, bad data values are adjusted and result in warnings rather than errors. In other words, with `STRICT_TRANS_TABLES`, a wrong value causes MySQL to roll back all updates done so far, if that can be done without changing the table. But once the table has been changed, further errors result in adjustments and warnings.

For even stricter checking, enable `STRICT_ALL_TABLES`. This is the same as `STRICT_TRANS_TABLES` except that for non-transactional storage engines, errors abort the statement even for bad data in rows following the first row. This means that if an error occurs partway through a multiple-row insert or update for a non-transactional table, a partial update results. Earlier rows are inserted or updated, but those from the point of the error on are not. To avoid this for non-transactional tables, either use single-row statements or else use `STRICT_TRANS_TABLES` if conversion warnings rather than errors are acceptable. To avoid problems in the first place, do not use MySQL to check column content. It is safest (and often faster) to let the application ensure that it passes only legal values to the database.

With either of the strict mode options, you can cause errors to be treated as warnings by using `INSERT IGNORE` or `UPDATE IGNORE` rather than `INSERT` or `UPDATE` without `IGNORE`.

### 1.7.6.3. ENUM and SET Constraints

`ENUM` and `SET` columns provide an efficient way to define columns that can contain only a given set of values. See [Section 10.4.4, “The ENUM Type”](#), and [Section 10.4.5, “The SET Type”](#). However, before MySQL 5.0.2, `ENUM` and `SET` columns do not provide true constraints on entry of invalid data:

- `ENUM` columns always have a default value. If you specify no default value, then it is `NULL` for columns that can have `NULL`, otherwise it is the first enumeration value in the column definition.
- If you insert an incorrect value into an `ENUM` column or if you force a value into an `ENUM` column with `IGNORE`, it is set to the reserved enumeration value of `0`, which is displayed as an empty string in string context.
- If you insert an incorrect value into a `SET` column, the incorrect value is ignored. For example, if the column can contain the values `'a'`, `'b'`, and `'c'`, an attempt to assign `'a,x,b,y'` results in a value of `'a,b'`.

As of MySQL 5.0.2, you can configure the server to use strict SQL mode. See [Section 5.1.7, “Server SQL Modes”](#). With strict mode enabled, the definition of a `ENUM` or `SET` column does act as a constraint on values entered into the column. An error occurs for values that do not satisfy these conditions:

- An `ENUM` value must be one of those listed in the column definition, or the internal numeric equivalent thereof. The value cannot be the error value (that is, `0` or the empty string). For a column defined as `ENUM('a','b','c')`, values such as `'`, `'d'`, or `'ax'` are illegal and are rejected.
- A `SET` value must be the empty string or a value consisting only of the values listed in the column definition separated by commas. For a column defined as `SET('a','b','c')`, values such as `'d'` or `'a,b,c,d'` are illegal and are rejected.

Errors for invalid values can be suppressed in strict mode if you use `INSERT IGNORE` or `UPDATE IGNORE`. In this case, a warning is generated rather than an error. For `ENUM`, the value is inserted as the error member (`0`). For `SET`, the value is inserted as given except that any invalid substrings are deleted. For example, `'a,x,b,y'` results in a value of `'a,b'`.

## 1.8. Credits

This appendix lists the developers, contributors, and supporters that have helped to make MySQL what it is today.

### 1.8.1. Contributors to MySQL

Although Sun Microsystems, Inc. owns all copyrights in the [MySQL server](#) and the [MySQL manual](#), we wish to recognize those who have made contributions of one kind or another to the [MySQL distribution](#). Contributors are listed here, in somewhat random order:

- Gianmassimo Vigazzola <[qwertg@mbx.vol.it](mailto:qwertg@mbx.vol.it)> or <[qwertg@tin.it](mailto:qwertg@tin.it)>  
The initial port to Win32/NT.
- Per Eric Olsson  
For more or less constructive criticism and real testing of the dynamic record format.
- Irena Pancirov <[irena@mail.yacc.it](mailto:irena@mail.yacc.it)>  
Win32 port with Borland compiler. [mysqlshutdown.exe](#) and [mysqlwatch.exe](#)
- David J. Hughes

For the effort to make a shareware SQL database. At TcX, the predecessor of MySQL AB, we started with `mSQL`, but found that it couldn't satisfy our purposes so instead we wrote an SQL interface to our application builder Unireg. [mysqladmin](#) and [mysql](#) client are programs that were largely influenced by their `mSQL` counterparts. We have put a lot of effort into making the MySQL syntax a superset of `mSQL`. Many of the API's ideas are borrowed from `mSQL` to make it easy to port free `mSQL` programs to the MySQL API. The MySQL software doesn't contain any code from `mSQL`. Two files in the distribution ([client/insert\\_test.c](#) and [client/select\\_test.c](#)) are based on the corresponding (non-copyrighted) files in the `mSQL` distribution, but are modified as examples showing the changes necessary to convert code from `mSQL` to MySQL Server. (`mSQL` is copyrighted David J. Hughes.)

- Patrick Lynch  
For helping us acquire <http://www.mysql.com/>.
- Fred Lindberg  
For setting up qmail to handle the MySQL mailing list and for the incredible help we got in managing the MySQL mailing lists.
- Igor Romanenko <[igor@frog.kiev.ua](mailto:igor@frog.kiev.ua)>  
[mysqldump](#) (previously [msqldump](#), but ported and enhanced by Monty).
- Yuri Dario  
For keeping up and extending the MySQL OS/2 port.
- Tim Bunce  
Author of [mysqlhotcopy](#).
- Zarko Mocnik <[zarko.mocnik@dem.si](mailto:zarko.mocnik@dem.si)>  
Sorting for Slovenian language.
- "TAMITO" <[tommy@valley.ne.jp](mailto:tommy@valley.ne.jp)>  
The `_MB` character set macros and the `ujis` and `sjis` character sets.
- Joshua Chamas <[joshua@chamas.com](mailto:joshua@chamas.com)>  
Base for concurrent insert, extended date syntax, debugging on NT, and answering on the MySQL mailing list.
- Yves Carlier <[Yves.Carlier@rug.ac.be](mailto:Yves.Carlier@rug.ac.be)>  
[mysqlaccess](#), a program to show the access rights for a user.
- Rhys Jones <[rhys@wales.com](mailto:rhys@wales.com)> (And GWE Technologies Limited)  
For one of the early JDBC drivers.
- Dr Xiaokun Kelvin ZHU <[X.Zhu@brad.ac.uk](mailto:X.Zhu@brad.ac.uk)>  
Further development of one of the early JDBC drivers and other MySQL-related Java tools.
- James Cooper <[pixel@organic.com](mailto:pixel@organic.com)>  
For setting up a searchable mailing list archive at his site.
- Rick Mehalick <[Rick\\_Mehalick@i-o.com](mailto:Rick_Mehalick@i-o.com)>  
For [xmysql](#), a graphical X client for MySQL Server.
- Doug Sisk <[sisk@wix.com](mailto:sisk@wix.com)>  
For providing RPM packages of MySQL for Red Hat Linux.
- Diemand Alexander V. <[axeld@vial.ethz.ch](mailto:axeld@vial.ethz.ch)>  
For providing RPM packages of MySQL for Red Hat Linux-Alpha.
- Antoni Pamies Olive <[toni@readysoft.es](mailto:toni@readysoft.es)>  
For providing RPM versions of a lot of MySQL clients for Intel and SPARC.
- Jay Bloodworth <[jay@pathways.sde.state.sc.us](mailto:jay@pathways.sde.state.sc.us)>  
For providing RPM versions for MySQL 3.21.
- David Sacerdote <[davids@secnet.com](mailto:davids@secnet.com)>  
Ideas for secure checking of DNS host names.

- Wei-Jou Chen <jou@nematic.ieo.nctu.edu.tw>  
Some support for Chinese(BIG5) characters.
- Wei He <hewei@mail.ied.ac.cn>  
A lot of functionality for the Chinese(GBK) character set.
- Jan Pazdziora <adelton@fi.muni.cz>  
Czech sorting order.
- Zeev Suraski <bourbon@netvision.net.il>  
`FROM_UNIXTIME()` time formatting, `ENCRYPT()` functions, and `bison` advisor. Active mailing list member.
- Luuk de Boer <luuk@wxs.nl>  
Ported (and extended) the benchmark suite to `DBI/DBD`. Have been of great help with `crash-me` and running benchmarks. Some new date functions. The `mysql_setpermission` script.
- Alexis Mikhailov <root@medinf.chuvashia.su>  
User-defined functions (UDFs); `CREATE FUNCTION` and `DROP FUNCTION`.
- Andreas F. Bobak <bobak@relog.ch>  
The `AGGREGATE` extension to user-defined functions.
- Ross Wakelin <R.Wakelin@march.co.uk>  
Help to set up InstallShield for MySQL-Win32.
- Jethro Wright III <jetman@li.net>  
The `libmysql.dll` library.
- James Pereria <jpereira@iafrica.com>  
Mysqlmanager, a Win32 GUI tool for administering MySQL Servers.
- Curt Sampson <cjs@portal.ca>  
Porting of MIT-pthreads to NetBSD/Alpha and NetBSD 1.3/i386.
- Martin Ramsch <m.ramsch@computer.org>  
Examples in the MySQL Tutorial.
- Steve Harvey  
For making `mysqlaccess` more secure.
- Konark IA-64 Centre of Persistent Systems Private Limited  
<http://www.pspl.co.in/konark/>. Help with the Win64 port of the MySQL server.
- Albert Chin-A-Young.  
Configure updates for Tru64, large file support and better TCP wrappers support.
- John Birrell  
Emulation of `pthread_mutex()` for OS/2.
- Benjamin Pflugmann  
Extended `MERGE` tables to handle `INSERTS`. Active member on the MySQL mailing lists.
- Jocelyn Fournier  
Excellent spotting and reporting innumerable bugs (especially in the MySQL 4.1 subquery code).

- Marc Liyanage  
Maintaining the Mac OS X packages and providing invaluable feedback on how to create Mac OS X PKGs.
- Robert Rutherford  
Providing invaluable information and feedback about the QNX port.
- Previous developers of NDB Cluster  
Lots of people were involved in various ways summer students, master thesis students, employees. In total more than 100 people so too many to mention here. Notable name is Ataullah Dabaghi who up until 1999 contributed around a third of the code base. A special thanks also to developers of the AXE system which provided much of the architectural foundations for NDB Cluster with blocks, signals and crash tracing functionality. Also credit should be given to those who believed in the ideas enough to allocate of their budgets for its development from 1992 to present time.
- Google Inc.  
We wish to recognize Google Inc. for contributions to the MySQL distribution: Mark Callaghan's SMP Performance patches and other patches.

Other contributors, bugfinders, and testers: James H. Thompson, Maurizio Menghini, Wojciech Tryc, Luca Berra, Zarko Mocnik, Wim Bonis, Elmar Haneke, <jehamby@lightside>, <psmith@BayNetworks.com>, <duane@connect.com.au>, Ted Deppner <ted@psyber.com>, Mike Simons, Jaakko Hyvatti.

And lots of bug report/patches from the folks on the mailing list.

A big tribute goes to those that help us answer questions on the MySQL mailing lists:

- Daniel Koch <dkoch@amcity.com>  
Irix setup.
- Luuk de Boer <luuk@wxs.nl>  
Benchmark questions.
- Tim Sailer <tps@users.buoy.com>  
DBD::mysql questions.
- Boyd Lynn Gerber <gerberb@zenez.com>  
SCO-related questions.
- Richard Mehalick <RM186061@shellus.com>  
xmysql-related questions and basic installation questions.
- Zeev Suraski <bourbon@netvision.net.il>  
Apache module configuration questions (log & auth), PHP-related questions, SQL syntax-related questions and other general questions.
- Francisc Guasch <frankie@citel.upc.es>  
General questions.
- Jonathan J Smith <jsmith@wtp.net>  
Questions pertaining to OS-specifics with Linux, SQL syntax, and other things that might need some work.
- David Sklar <sklar@student.net>  
Using MySQL from PHP and Perl.
- Alistair MacDonald <A.MacDonald@uel.ac.uk>  
Is flexible and can handle Linux and perhaps HP-UX. Tries to get users to use [mysqlbug](#).



- John Lyon <jlyon@imag.net>  
Questions about installing MySQL on Linux systems, using either `.rpm` files or compiling from source.
- Lorvid Ltd. <lorvid@WOLFENET.com>  
Simple billing/license/support/copyright issues.
- Patrick Sherrill <patrick@coconet.com>  
ODBC and VisualC++ interface questions.
- Randy Harmon <rjharmon@uptimecomputers.com>  
DBD, Linux, some SQL syntax questions.

## 1.8.2. Documenters and translators

The following people have helped us with writing the MySQL documentation and translating the documentation or error messages in MySQL.

- Paul DuBois  
Ongoing help with making this manual correct and understandable. That includes rewriting Monty's and David's attempts at English into English as other people know it.
- Kim Aldale  
Helped to rewrite Monty's and David's early attempts at English into English.
- Michael J. Miller Jr. <mke@terrapin.turbolift.com>  
For the first MySQL manual. And a lot of spelling/language fixes for the FAQ (that turned into the MySQL manual a long time ago).
- Yan Cailin  
First translator of the MySQL Reference Manual into simplified Chinese in early 2000 on which the Big5 and HK coded (<http://mysql.hitstar.com/>) versions were based. [Personal home page at linuxdb.yeah.net](#).
- Jay Flaherty <fty@mediapulse.com>  
Big parts of the Perl DBI/DBD section in the manual.
- Paul Southworth <pauls@etext.org>, Ray Loyzaga <yar@cs.su.oz.au>  
Proof-reading of the Reference Manual.
- Therrien Gilbert <gilbert@ican.net>, Jean-Marc Pouyot <jmp@scalaire.fr>  
French error messages.
- Petr Snajdr, <snajdr@pvt.net>  
Czech error messages.
- Jaroslaw Lewandowski <jotel@itnet.com.pl>  
Polish error messages.
- Miguel Angel Fernandez Roiz  
Spanish error messages.
- Roy-Magne Mo <rmo@www.hivolda.no>  
Norwegian error messages and testing of MySQL 3.21.xx.
- Timur I. Bakeyev <root@timur.tatarstan.ru>

Russian error messages.

- [<brenno@dewinter.com>](mailto:brenno@dewinter.com) & Filippo Grassilli [<phil@hyppo.com>](mailto:phil@hyppo.com)

Italian error messages.

- Dirk Munzinger [<dirk@trinity.saar.de>](mailto:dirk@trinity.saar.de)

German error messages.

- Billik Stefan [<billik@sun.uniag.sk>](mailto:billik@sun.uniag.sk)

Slovak error messages.

- Stefan Saroiu [<tzoompy@cs.washington.edu>](mailto:tzoompy@cs.washington.edu)

Romanian error messages.

- Peter Feher

Hungarian error messages.

- Roberto M. Serqueira

Portuguese error messages.

- Carsten H. Pedersen

Danish error messages.

- Arjen Lentz

Dutch error messages, completing earlier partial translation (also work on consistency and spelling).

### 1.8.3. Libraries used by and included with MySQL

The following is a list of the creators of the libraries we have included with the MySQL server source to make it easy to compile and install MySQL. We are very thankful to all individuals that have created these and it has made our life much easier.

- Fred Fish

For his excellent C debugging and trace library. Monty has made a number of smaller improvements to the library (speed and additional options).

- Richard A. O'Keefe

For his public domain string library.

- Henry Spencer

For his regex library, used in `WHERE column REGEXP regexp`.

- Jean-loup Gailly and Mark Adler

For the zlib library (used on MySQL on Windows).

- Bjorn Benson

For his `safe_malloc` (memory checker) package which is used in when you build MySQL using one of the `BUILD/compile-*--debug` scripts, or manually set the `-DSAFE_MALLOC`.

- Free Software Foundation

The `readline` library (used by the `mysql` command-line client).

- The NetBSD foundation

The `libedit` package (optionally used by the `mysql` command-line client).

- [www.netlib.org](http://www.netlib.org)

MySQL incorporates work covered by the following copyright and permission notice:

The author of this software is David M. Gay.

Copyright (c) 1991, 2000, 2001 by Lucent Technologies.

Permission to use, copy, modify, and distribute this software for any purpose without fee is hereby granted, provided that this entire notice is included in all copies of any software which is or includes a copy or modification of this software and in all copies of the supporting documentation for such software.

THIS SOFTWARE IS BEING PROVIDED "AS IS", WITHOUT ANY EXPRESS OR IMPLIED WARRANTY. IN PARTICULAR, NEITHER THE AUTHOR NOR LUCENT MAKES ANY REPRESENTATION OR WARRANTY OF ANY KIND CONCERNING THE MERCHANTABILITY OF THIS SOFTWARE OR ITS FITNESS FOR ANY PARTICULAR PURPOSE.

## 1.8.4. Packages that support MySQL

The following is a list of creators/maintainers of some of the most important API/packages/applications that a lot of people use with MySQL.

We cannot list every possible package here because the list would then be way to hard to maintain. For other packages, please refer to the software portal at <http://solutions.mysql.com/software/>.

- Tim Bunce, Alligator Descartes  
For the `DBD` (Perl) interface.
- Andreas Koenig <[a.koenig@mind.de](mailto:a.koenig@mind.de)>  
For the Perl interface for MySQL Server.
- Jochen Wiedmann <[wiedmann@neckar-alb.de](mailto:wiedmann@neckar-alb.de)>  
For maintaining the Perl `DBD::mysql` module.
- Eugene Chan <[eugene@acenet.com.sg](mailto:eugene@acenet.com.sg)>  
For porting PHP for MySQL Server.
- Georg Richter  
MySQL 4.1 testing and bug hunting. New PHP 5.0 `mysql_i` extension (API) for use with MySQL 4.1 and up.
- Giovanni Maruzzelli <[maruzz@matrice.it](mailto:maruzz@matrice.it)>  
For porting iODBC (Unix ODBC).
- Xavier Leroy <[Xavier.Leroy@inria.fr](mailto:Xavier.Leroy@inria.fr)>  
The author of LinuxThreads (used by the MySQL Server on Linux).

## 1.8.5. Tools that were used to create MySQL

The following is a list of some of the tools we have used to create MySQL. We use this to express our thanks to those that has created them as without these we could not have made MySQL what it is today.

- Free Software Foundation  
From whom we got an excellent compiler (`gcc`), an excellent debugger (`gdb`) and the `libc` library (from which we have borrowed `strto.c` to get some code working in Linux).
- Free Software Foundation & The XEmacs development team  
For a really great editor/environment.

- Julian Seward

Author of [valgrind](#), an excellent memory checker tool that has helped us find a lot of otherwise hard to find bugs in MySQL.

- Dorothea Lütkehaus and Andreas Zeller

For [DDD](#) (The Data Display Debugger) which is an excellent graphical front end to [gdb](#).

## 1.8.6. Supporters of MySQL

Although Sun Microsystems, Inc. owns all copyrights in the [MySQL server](#) and the [MySQL manual](#), we wish to recognize the following companies, which helped us finance the development of the [MySQL server](#), such as by paying us for developing a new feature or giving us hardware for development of the [MySQL server](#).

- VA Linux / Andover.net

Funded replication.

- NuSphere

Editing of the MySQL manual.

- Stork Design studio

The MySQL Web site in use between 1998-2000.

- Intel

Contributed to development on Windows and Linux platforms.

- Compaq

Contributed to Development on Linux/Alpha.

- SWSoft

Development on the embedded [mysqld](#) version.

- FutureQuest

`--skip-show-database`

---

## Chapter 2. Installing and Upgrading MySQL

This chapter describes how to obtain and install MySQL. A summary of the procedure follows and later sections provide the details. If you plan to upgrade an existing version of MySQL to a newer version rather than install MySQL for the first time, see [Section 2.12.1, “Upgrading MySQL”](#), for information about upgrade procedures and about issues that you should consider before upgrading.

If you are interested in migrating to MySQL from another database system, you may wish to read [Section A.8, “MySQL 5.1 FAQ — Migration”](#), which contains answers to some common questions concerning migration issues.

1. **Determine whether MySQL runs and is supported on your platform.** Please note that not all platforms are equally suitable for running MySQL, and that not all platforms on which MySQL is known to run are officially supported by Sun Microsystems, Inc.:
  - For MySQL Enterprise Server, the officially supported platforms are listed at <http://www.mysql.com/support/supportedplatforms.html>.
  - MySQL Community Server runs on the platforms listed at [Section 2.1.1, “Operating Systems Supported by MySQL Community Server”](#).
2. **Choose which distribution to install.** Several versions of MySQL are available, and most are available in several distribution formats. You can choose from pre-packaged distributions containing binary (precompiled) programs or source code. When in doubt, use a binary distribution. We also provide public access to our current source tree for those who want to see our most recent developments and help us test new code. To determine which version and type of distribution you should use, see [Section 2.1.2, “Choosing Which MySQL Distribution to Install”](#).
3. **Download the distribution that you want to install.** For instructions, see [Section 2.1.3, “How to Get MySQL”](#). To verify the integrity of the distribution, use the instructions in [Section 2.1.4, “Verifying Package Integrity Using MD5 Checksums or GnuPG”](#).
4. **Install the distribution.** To install MySQL from a binary distribution, use the instructions in [Section 2.2, “Standard MySQL Installation Using a Binary Distribution”](#). To install MySQL from a source distribution or from the current development source tree, use the instructions in [Section 2.10, “MySQL Installation Using a Source Distribution”](#).

If you encounter installation difficulties, see [Section 2.13, “Operating System-Specific Notes”](#), for information on solving problems for particular platforms.

5. **Perform any necessary post-installation setup.** After installing MySQL, read [Section 2.11, “Post-Installation Setup and Testing”](#). This section contains important information about making sure the MySQL server is working properly. It also describes how to secure the initial MySQL user accounts, *which have no passwords* until you assign passwords. The section applies whether you install MySQL using a binary or source distribution.
6. If you want to run the MySQL benchmark scripts, Perl support for MySQL must be available. See [Section 2.15, “Perl Installation Notes”](#).

### 2.1. General Installation Issues

The MySQL installation procedure depends on whether you will install MySQL Enterprise Server or MySQL Community Server. The set of applicable platforms depends on which distribution you will install:

- For MySQL Enterprise Server, the officially supported platforms are listed at <http://www.mysql.com/support/supportedplatforms.html>.
- MySQL Community Server runs on the platforms listed at [Section 2.1.1, “Operating Systems Supported by MySQL Community Server”](#).

For MySQL Enterprise Server, install the main distribution plus any service packs or hotfixes that you wish to apply using the Enterprise Installer. For platforms that do not yet have an Enterprise Installer, use the Community Server instructions.

For MySQL Community Server, install the main distribution plus any hotfixes and updates:

- Download a binary release, or download a source release and build MySQL yourself from the source code.
- Retrieve MySQL from the Bazaar tree and build it from source. The Bazaar tree contains the latest developer code.

The immediately following sections contain the information necessary to choose, download, and verify your distribution. The instructions in later sections of the chapter describe how to install the distribution that you choose. For binary distributions, see the instructions at [Section 2.2, “Standard MySQL Installation Using a Binary Distribution”](#). To build MySQL from source, use the instructions at [Section 2.10, “MySQL Installation Using a Source Distribution”](#).

## 2.1.1. Operating Systems Supported by MySQL Community Server

This section lists the operating systems on which MySQL Community Server is known to run.

### Important

Sun Microsystems, Inc. does not necessarily provide official support for all the platforms listed in this section. For information about those platforms that are officially supported, see [MySQL Server Supported Platforms](#) on the MySQL Web site.

We use GNU Autoconf, so it is possible to port MySQL to all modern systems that have a C++ compiler and a working implementation of POSIX threads. (Thread support is needed for the server. To compile only the client code, the only requirement is a C++ compiler.)

MySQL has been reported to compile successfully on the following combinations of operating system and thread package.

- AIX 4.x, 5.x with native threads. See [Section 2.13.5.3, “IBM-AIX notes”](#).
- Amiga.
- FreeBSD 5.x and up with native threads.
- HP-UX 11.x with the native threads. See [Section 2.13.5.2, “HP-UX Version 11.x Notes”](#).
- Linux, builds on all fairly recent Linux distributions with `glibc` 2.3. See [Section 2.13.1, “Linux Notes”](#).
- Mac OS X. See [Section 2.13.2, “Mac OS X Notes”](#).
- NetBSD 1.3/1.4 Intel and NetBSD 1.3 Alpha. See [Section 2.13.4.2, “NetBSD Notes”](#).
- Novell NetWare 6.0 and 6.5. See [Section 2.8, “Installing MySQL on NetWare”](#).
- OpenBSD 2.5 and with native threads. OpenBSD earlier than 2.5 with the MIT-pthreads package. See [Section 2.13.4.3, “OpenBSD 2.5 Notes”](#).
- SCO OpenServer 5.0.X with a recent port of the FSU Pthreads package. See [Section 2.13.5.8, “SCO UNIX and OpenServer 5.0.x Notes”](#).
- SCO Openserver 6.0.x. See [Section 2.13.5.9, “SCO OpenServer 6.0.x Notes”](#).
- SCO UnixWare 7.1.x. See [Section 2.13.5.10, “SCO UnixWare 7.1.x and OpenUNIX 8.0.0 Notes”](#).
- SGI Irix 6.x with native threads. See [Section 2.13.5.7, “SGI Irix Notes”](#).
- Solaris 2.5 and above with native threads on SPARC and x86. See [Section 2.13.3, “Solaris Notes”](#).
- Tru64 Unix. See [Section 2.13.5.5, “Alpha-DEC-UNIX Notes \(Tru64\)”](#).
- Windows 2000, Windows XP, Windows Vista, Windows Server 2003, and Windows Server 2008. See [Section 2.3, “Installing MySQL on Windows”](#).

MySQL has also been known to run on other systems in the past. See [Section 2.13, “Operating System-Specific Notes”](#). Some porting effort might be required for current versions of MySQL on these systems.

Not all platforms are equally well-suited for running MySQL. How well a certain platform is suited for a high-load mission-critical MySQL server is determined by the following factors:

- General stability of the thread library. A platform may have an excellent reputation otherwise, but MySQL is only as stable as the thread library it calls, even if everything else is perfect.
- The capability of the kernel and the thread library to take advantage of symmetric multi-processor (SMP) systems. In other words, when a process creates a thread, it should be possible for that thread to run on a CPU different from the original process.

- The capability of the kernel and the thread library to run many threads that acquire and release a mutex over a short critical region frequently without excessive context switches. If the implementation of `pthread_mutex_lock()` is too anxious to yield CPU time, this hurts MySQL tremendously. If this issue is not taken care of, adding extra CPUs actually makes MySQL slower.
- General file system stability and performance.
- If your tables are large, performance is affected by the ability of the file system to deal with large files at all and to deal with them efficiently.
- Our level of expertise here at Sun Microsystems, Inc. with the platform. If we know a platform well, we enable platform-specific optimizations and fixes at compile time. We can also provide advice on configuring your system optimally for MySQL.
- The amount of testing we have done internally for similar configurations.
- The number of users that have run MySQL successfully on the platform in similar configurations. If this number is high, the likelihood of encountering platform-specific surprises is much smaller.

## 2.1.2. Choosing Which MySQL Distribution to Install

When preparing to install MySQL, you should decide which version to use. MySQL development occurs in several release series, and you can pick the one that best fits your needs. After deciding which version to install, you can choose a distribution format. Releases are available in binary or source format.

### 2.1.2.1. Choosing Which Version of MySQL to Install

The first decision to make is whether you want to use a production (stable) release or a development release. In the MySQL development process, multiple release series co-exist, each at a different stage of maturity:

- MySQL 5.4 and 6.0 are the current development release series.
- MySQL 5.1 is the current General Availability (Production) release series. New releases are issued for bugfixes only; no new features are being added that could affect stability.
- MySQL 5.0 is the previous stable (production-quality) release series.
- MySQL 4.1, 4.0, and 3.23 are old stable (production-quality) release series. MySQL 4.1 is now at the end of the product life-cycle. Active development and support for these versions has ended.

Extended support for MySQL 4.1 remains available. According to the [MySQL Lifecycle Policy](#), only Security and Severity Level 1 issues are still being fixed for MySQL 4.1.

We do not believe in a complete code freeze because this prevents us from making bugfixes and other fixes that must be done. By “somewhat frozen” we mean that we may add small things that should not affect anything that currently works in a production release. Naturally, relevant bugfixes from an earlier series propagate to later series.

Normally, if you are beginning to use MySQL for the first time or trying to port it to some system for which there is no binary distribution, we recommend going with the General Availability release series. Currently, this is MySQL 5.1. All MySQL releases, even those from development series, are checked with the MySQL benchmarks and an extensive test suite before being issued.

If you are running an older system and want to upgrade, but do not want to take the chance of having a non-seamless upgrade, you should upgrade to the latest version in the same release series you are using (where only the last part of the version number is newer than yours). We have tried to fix only fatal bugs and make only small, relatively “safe” changes to that version.

If you want to use new features not present in the production release series, you can use a version from a development series. Note that development releases are not as stable as production releases.

If you want to use the very latest sources containing all current patches and bugfixes, you can use one of our Bazaar repositories. These are not “releases” as such, but are available as previews of the code on which future releases are to be based.

The MySQL naming scheme uses release names that consist of three numbers and a suffix; for example, **mysql-5.0.12-beta**. The numbers within the release name are interpreted as follows:

- The first number (**5**) is the major version and describes the file format. All MySQL 5 releases have the same file format.
- The second number (**0**) is the release level. Taken together, the major version and release level constitute the release series



number.

- The third number (**12**) is the version number within the release series. This is incremented for each new release. Usually you want the latest version for the series you have chosen.

For each minor update, the last number in the version string is incremented. When there are major new features or minor incompatibilities with previous versions, the second number in the version string is incremented. When the file format changes, the first number is increased.

Release names also include a suffix to indicate the stability level of the release. Releases within a series progress through a set of suffixes to indicate how the stability level improves. The possible suffixes are:

- **alpha** indicates that the release is for preview purposes only. Known bugs should be documented in the News section (see [Appendix C, MySQL Change History](#)). Most alpha releases implement new commands and extensions. Active development that may involve major code changes can occur in an alpha release. However, we do conduct testing before issuing a release.
- **beta** indicates that the release is appropriate for use with new development. Within beta releases, the features and compatibility should remain consistent. However, beta releases may contain numerous and major unaddressed bugs.

All APIs, externally visible structures, and columns for SQL statements will not change during future beta, release candidate, or production releases.

- **rc** indicates a Release Candidate. Release candidates are believed to be stable, having passed all of MySQL's internal testing, and with all known fatal runtime bugs fixed. However, the release has not been in widespread use long enough to know for sure that all bugs have been identified. Only minor fixes are added. (A release candidate is what formerly was known as a gamma release.)
- If there is no suffix, it indicates that the release is a General Availability (GA) or Production release. GA releases are stable, having successfully passed through all earlier release stages and are believed to be reliable, free of serious bugs, and suitable for use in production systems. Only critical bugfixes are applied to the release.

MySQL uses a naming scheme that is slightly different from most other products. In general, it is usually safe to use any version that has been out for a couple of weeks without being replaced by a new version within the same release series.

All releases of MySQL are run through our standard tests and benchmarks to ensure that they are relatively safe to use. Because the standard tests are extended over time to check for all previously found bugs, the test suite keeps getting better.

All releases have been tested at least with these tools:

- An internal test suite

The `mysql-test` directory contains an extensive set of test cases. We run these tests for every server binary. See [Section 21.1.2, “MySQL Test Suite”](#), for more information about this test suite.

- The MySQL benchmark suite

This suite runs a range of common queries. It is also a test to determine whether the latest batch of optimizations actually made the code faster. See [Section 7.1.4, “The MySQL Benchmark Suite”](#).

- The `crash-me` test

This test tries to determine what features the database supports and what its capabilities and limitations are. See [Section 7.1.4, “The MySQL Benchmark Suite”](#).

We also test the newest MySQL version in our internal production environment, on at least one machine. We have more than 100GB of data to work with.

### 2.1.2.2. Choosing a Distribution Format

After choosing which version of MySQL to install, you should decide whether to use a binary distribution or a source distribution. In most cases, you should probably use a binary distribution, if one exists for your platform. Binary distributions are available in native format for many platforms, such as RPM files for Linux or PKG package installers for Mac OS X or Solaris. Distributions also are available as Zip archives or compressed `tar` files.

Reasons to choose a binary distribution include the following:

- Binary distributions generally are easier to install than source distributions.
- To satisfy different user requirements, we provide several servers in binary distributions. `mysqld` is an optimized server that is a smaller, faster binary. `mysqld-debug` is compiled with debugging support.

Each of these servers is compiled from the same source distribution, though with different configuration options. All native MySQL clients can connect to servers from either MySQL version.

Under some circumstances, you may be better off installing MySQL from a source distribution:

- You want to install MySQL at some explicit location. The standard binary distributions are ready to run at any installation location, but you might require even more flexibility to place MySQL components where you want.
- You want to configure `mysqld` to ensure that features are available that might not be included in the standard binary distributions. Here is a list of the most common extra options that you may want to use to ensure feature availability:
  - `--with-libwrap`
  - `--with-named-z-libs` (this is done for some of the binaries)
  - `--with-debug[=full]`
- You want to configure `mysqld` without some features that are included in the standard binary distributions. For example, distributions normally are compiled with support for all character sets. If you want a smaller MySQL server, you can recompile it with support for only the character sets you need.
- You have a special compiler (such as `pgcc`) or want to use compiler options that are better optimized for your processor. Binary distributions are compiled with options that should work on a variety of processors from the same processor family.
- You want to use the latest sources from one of the Bazaar repositories to have access to all current bugfixes. For example, if you have found a bug and reported it to the MySQL development team, the bugfix is committed to the source repository and you can access it there. The bugfix does not appear in a release until a release actually is issued.
- You want to read (or modify) the C and C++ code that makes up MySQL. For this purpose, you should get a source distribution, because the source code is always the ultimate manual.
- Source distributions contain more tests and examples than binary distributions.

### 2.1.2.3. How and When Updates Are Released

MySQL is evolving quite rapidly and we want to share new developments with other MySQL users. We try to produce a new release whenever we have new and useful features that others also seem to have a need for.

We also try to help users who request features that are easy to implement. We take note of what our licensed users want, and we especially take note of what our support customers want and try to help them in this regard.

No one is *required* to download a new release. The News section helps you determine whether the new release has something you really want. See [Appendix C, MySQL Change History](#).

We use the following policy when updating MySQL:

- Enterprise Server releases are meant to appear every 18 months, supplemented by quarterly service packs and monthly rapid updates. Community Server releases are meant to appear 2–3 times per year.
- Releases are issued within each series. Enterprise Server releases are numbered using even numbers (for example, 5.1.20). Community Server releases are numbered using odd numbers (for example, 5.1.21).
- Binary distributions for some platforms are made by us for major releases. Other people may make binary distributions for other systems, but probably less frequently.
- We make fixes available as soon as we have identified and corrected small or non-critical but annoying bugs. The fixes are available in source form immediately from our public Bazaar repositories, and are included in the next release.
- If by any chance a security vulnerability or critical bug is found in a release, our policy is to fix it in a new release as soon as possible. (We would like other companies to do this, too!)

### 2.1.2.4. MySQL Binaries Compiled by Sun Microsystems, Inc.

As a service of Sun Microsystems, Inc., we provide a set of binary distributions of MySQL that are compiled on systems at our site or on systems where supporters of MySQL kindly have given us access to their machines.

In addition to the binaries provided in platform-specific package formats, we offer binary distributions for a number of platforms in the form of compressed `tar` files (`.tar.gz` files). See [Section 2.2, “Standard MySQL Installation Using a Binary Distribution”](#).

The RPM distributions for MySQL 5.1 releases that we make available through our Web site are generated by MySQL AB.

For Windows distributions, see [Section 2.3, “Installing MySQL on Windows”](#).

These distributions are generated using the script `Build-tools/Do-compile`, which compiles the source code and creates the binary `tar.gz` archive using `scripts/make_binary_distribution`.

These binaries are configured and built with the following compilers and options. This information can also be obtained by looking at the variables `COMP_ENV_INFO` and `CONFIGURE_LINE` inside the script `bin/mysqlbug` of every binary `tar` file distribution.

Anyone who has more optimal options for any of the following `configure` commands can mail them to the MySQL [intern-als](#) mailing list. See [Section 1.5.1, “MySQL Mailing Lists”](#).

If you want to compile a debug version of MySQL, you should add `--with-debug` or `--with-debug=full` to the following `configure` commands and remove any `-fomit-frame-pointer` options.

The following binaries are built on our own development systems:

- Linux 2.4.xx x86 with `gcc` 2.95.3:

```
CFLAGS="-O2 -mcpu=pentiumpro" CXX=gcc CXXFLAGS="-O2 -mcpu=pentiumpro
-felide-constructors" ./configure --prefix=/usr/local/mysql
--with-extra-charsets=complex --enable-thread-safe-client
--enable-local-infile --enable-asmsembler --disable-shared
--with-client-ldflags=-all-static --with-mysqld-ldflags=-all-static
```

- Linux 2.4.x x86 with `icc` (Intel C++ Compiler 8.1 or later releases):

```
CC=icc CXX=icpc CFLAGS="-O3 -unroll2 -ip -mp -no-gcc -restrict"
CXXFLAGS="-O3 -unroll2 -ip -mp -no-gcc -restrict" ./configure
--prefix=/usr/local/mysql --localstatedir=/usr/local/mysql/data
--libexecdir=/usr/local/mysql/bin --with-extra-charsets=complex
--enable-thread-safe-client --enable-local-infile --enable-asmsembler
--disable-shared --with-client-ldflags=-all-static
--with-mysqld-ldflags=-all-static --with-embedded-server --with-innobd
```

Note that versions 8.1 and newer of the Intel compiler have separate drivers for 'pure' C (`icc`) and C++ (`icpc`); if you use `icc` version 8.0 or older for building MySQL, you will need to set `CXX=icc`.

- Linux 2.4.xx Intel Itanium 2 with `ecc` (Intel C++ Itanium Compiler 7.0):

```
CC=ecc CFLAGS="-O2 -tpp2 -ip -nolib_inline" CXX=ecc CXXFLAGS="-O2
-tpp2 -ip -nolib_inline" ./configure --prefix=/usr/local/mysql
--with-extra-charsets=complex --enable-thread-safe-client
--enable-local-infile
```

- Linux 2.4.xx Intel Itanium with `ecc` (Intel C++ Itanium Compiler 7.0):

```
CC=ecc CFLAGS=-tpp1 CXX=ecc CXXFLAGS=-tpp1 ./configure
--prefix=/usr/local/mysql --with-extra-charsets=complex
--enable-thread-safe-client --enable-local-infile
```

- Linux 2.4.xx alpha with `ccc` (Compaq C V6.2-505 / Compaq C++ V6.3-006):

```
CC=ccc CFLAGS="-fast -arch generic" CXX=cxx CXXFLAGS="-fast -arch
generic -noexceptions -nortti" ./configure --prefix=/usr/local/mysql
--with-extra-charsets=complex --enable-thread-safe-client
--enable-local-infile --with-mysqld-ldflags=-non_shared
--with-client-ldflags=-non_shared --disable-shared
```

- Linux 2.x.xx ppc with `gcc` 2.95.4:

```
CC=gcc CFLAGS="-O3 -fno-omit-frame-pointer" CXX=gcc CXXFLAGS="-O3
-fno-omit-frame-pointer -felide-constructors -fno-exceptions
-fno-rtti" ./configure --prefix=/usr/local/mysql
```

```
--localstatedir=/usr/local/mysql/data --libexecdir=/usr/local/mysql/bin
--with-extra-charsets=complex --enable-thread-safe-client
--enable-local-infile --disable-shared --with-embedded-server
--with-innodb
```

- Linux 2.4.xx s390 with [gcc 2.95.3](#):

```
CFLAGS="-O2" CXX=gcc CXXFLAGS="-O2 -felide-constructors" ./configure
--prefix=/usr/local/mysql --with-extra-charsets=complex
--enable-thread-safe-client --enable-local-infile --disable-shared
--with-client-ldflags=-all-static --with-mysqld-ldflags=-all-static
```

- Linux 2.4.xx x86\_64 (AMD64) with [gcc 3.2.1](#):

```
CXX=gcc ./configure --prefix=/usr/local/mysql
--with-extra-charsets=complex --enable-thread-safe-client
--enable-local-infile --disable-shared
```

- Sun Solaris 8 x86 with [gcc 3.2.3](#):

```
CC=gcc CFLAGS="-O3 -fno-omit-frame-pointer" CXX=gcc CXXFLAGS="-O3
-fno-omit-frame-pointer -felide-constructors -fno-exceptions
-fno-rtti" ./configure --prefix=/usr/local/mysql
--localstatedir=/usr/local/mysql/data --libexecdir=/usr/local/mysql/bin
--with-extra-charsets=complex --enable-thread-safe-client
--enable-local-infile --disable-shared --with-innodb
```

- Sun Solaris 8 SPARC with [gcc 3.2](#):

```
CC=gcc CFLAGS="-O3 -fno-omit-frame-pointer" CXX=gcc CXXFLAGS="-O3
-fno-omit-frame-pointer -felide-constructors -fno-exceptions
-fno-rtti" ./configure --prefix=/usr/local/mysql
--with-extra-charsets=complex --enable-thread-safe-client
--enable-local-infile --enable-asmsembler --with-named-z-libs=no
--with-named-curses-libs=-lcurses --disable-shared
```

- Sun Solaris 8 SPARC 64-bit with [gcc 3.2](#):

```
CC=gcc CFLAGS="-O3 -m64 -fno-omit-frame-pointer" CXX=gcc CXXFLAGS="-O3
-m64 -fno-omit-frame-pointer -felide-constructors -fno-exceptions
-fno-rtti" ./configure --prefix=/usr/local/mysql
--with-extra-charsets=complex --enable-thread-safe-client
--enable-local-infile --with-named-z-libs=no
--with-named-curses-libs=-lcurses --disable-shared
```

- Sun Solaris 9 SPARC with [gcc 2.95.3](#):

```
CC=gcc CFLAGS="-O3 -fno-omit-frame-pointer" CXX=gcc CXXFLAGS="-O3
-fno-omit-frame-pointer -felide-constructors -fno-exceptions
-fno-rtti" ./configure --prefix=/usr/local/mysql
--with-extra-charsets=complex --enable-thread-safe-client
--enable-local-infile --enable-asmsembler --with-named-curses-libs=-lcurses
--disable-shared
```

- Sun Solaris 9 SPARC with [cc-5.0](#) (Sun Forte 5.0):

```
CC=cc-5.0 CXX=CC ASFLAGS="-xarch=v9" CFLAGS="-Xa -xstrconst -mt
-D_FORTEC_ -xarch=v9" CXXFLAGS="-noex -mt -D_FORTEC_ -xarch=v9"
./configure --prefix=/usr/local/mysql --with-extra-charsets=complex
--enable-thread-safe-client --enable-local-infile --enable-asmsembler
--with-named-z-libs=no --enable-thread-safe-client --disable-shared
```

- IBM AIX 4.3.2 ppc with [gcc 3.2.3](#):

```
CFLAGS="-O2 -mcpu=powerpc -Wa,-many " CXX=gcc CXXFLAGS="-O2
-mcpu=powerpc -Wa,-many -felide-constructors -fno-exceptions
-fno-rtti" ./configure --prefix=/usr/local/mysql
--with-extra-charsets=complex --enable-thread-safe-client
--enable-local-infile --with-named-z-libs=no --disable-shared
```

- IBM AIX 4.3.3 ppc with [x1C\\_r](#) (IBM Visual Age C/C++ 6.0):

```
CC=x1c_r CFLAGS="-ma -O2 -qstrict -qoptimize=2 -qmaxmem=8192"
CXX=x1c_r CXXFLAGS="-ma -O2 -qstrict -qoptimize=2 -qmaxmem=8192"
./configure --prefix=/usr/local/mysql --localstatedir=/usr/local/mysql/data
--libexecdir=/usr/local/mysql/bin --with-extra-charsets=complex
--enable-thread-safe-client --enable-local-infile --with-named-z-libs=no
--disable-shared --with-innodb
```

- IBM AIX 5.1.0 ppc with [gcc 3.3](#):

```
CFLAGS="-O2 -mcpu=powerpc -Wa,-many" CXX=gcc CXXFLAGS="-O2 -mcpu=powerpc
-Wa,-many -felide-constructors -fno-exceptions -fno-rtti" ./configure
--prefix=/usr/local/mysql --with-extra-charsets=complex
--enable-thread-safe-client --enable-local-infile --with-named-z-libs=no
--disable-shared
```

- IBM AIX 5.2.0 ppc with [xlc\\_r](#) (IBM Visual Age C/C++ 6.0):

```
CC=xlc_r CFLAGS="-ma -O2 -qstrict -qoptimize=2 -qmaxmem=8192"
CXX=xlc_r CXXFLAGS="-ma -O2 -qstrict -qoptimize=2 -qmaxmem=8192"
./configure --prefix=/usr/local/mysql --localstatedir=/usr/local/mysql/data
--libexecdir=/usr/local/mysql/bin --with-extra-charsets=complex
--enable-thread-safe-client --enable-local-infile --with-named-z-libs=no
--disable-shared --with-embedded-server --with-innodb
```

- HP-UX 10.20 pa-risc1.1 with [gcc 3.1](#):

```
CFLAGS="-DHPUX -I/opt/dce/include -O3 -fPIC" CXX=gcc CXXFLAGS="-DHPUX
-I/opt/dce/include -felide-constructors -fno-exceptions -fno-rtti
-O3 -fPIC" ./configure --prefix=/usr/local/mysql
--with-extra-charsets=complex --enable-thread-safe-client
--enable-local-infile --with-pthread --with-named-thread-libs=-ldce
--with-lib-ccflags=-fPIC --disable-shared
```

- HP-UX 11.00 pa-risc with [aCC](#) (HP ANSI C++ B3910B A.03.50):

```
CC=cc CXX=aCC CFLAGS="+DAportable" CXXFLAGS="+DAportable" ./configure
--prefix=/usr/local/mysql --localstatedir=/usr/local/mysql/data
--libexecdir=/usr/local/mysql/bin --with-extra-charsets=complex
--enable-thread-safe-client --enable-local-infile --disable-shared
--with-embedded-server --with-innodb
```

- HP-UX 11.11 pa-risc2.0 64bit with [aCC](#) (HP ANSI C++ B3910B A.03.33):

```
CC=cc CXX=aCC CFLAGS="+DD64" CXXFLAGS="+DD64" ./configure
--prefix=/usr/local/mysql --with-extra-charsets=complex
--enable-thread-safe-client --enable-local-infile --disable-shared
```

- HP-UX 11.11 pa-risc2.0 32bit with [aCC](#) (HP ANSI C++ B3910B A.03.33):

```
CC=cc CXX=aCC CFLAGS="+DAportable" CXXFLAGS="+DAportable" ./configure
--prefix=/usr/local/mysql --localstatedir=/usr/local/mysql/data
--libexecdir=/usr/local/mysql/bin --with-extra-charsets=complex
--enable-thread-safe-client --enable-local-infile --disable-shared
--with-innodb
```

- HP-UX 11.22 ia64 64bit with [aCC](#) (HP aC++/ANSI C B3910B A.05.50):

```
CC=cc CXX=aCC CFLAGS="+DD64 +DSitanium2" CXXFLAGS="+DD64 +DSitanium2"
./configure --prefix=/usr/local/mysql --localstatedir=/usr/local/mysql/data
--libexecdir=/usr/local/mysql/bin --with-extra-charsets=complex
--enable-thread-safe-client --enable-local-infile --disable-shared
--with-embedded-server --with-innodb
```

- Apple Mac OS X 10.2 powerpc with [gcc 3.1](#):

```
CC=gcc CFLAGS="-O3 -fno-omit-frame-pointer" CXX=gcc CXXFLAGS="-O3
-fno-omit-frame-pointer -felide-constructors -fno-exceptions
-fno-rtti" ./configure --prefix=/usr/local/mysql
--with-extra-charsets=complex --enable-thread-safe-client
--enable-local-infile --disable-shared
```

- FreeBSD 4.7 i386 with [gcc 2.95.4](#):

```
CFLAGS=-DHAVE_BROKEN_REALPATH ./configure --prefix=/usr/local/mysql
--with-extra-charsets=complex --enable-thread-safe-client
--enable-local-infile --enable-asm --with-named-z-libs=not-used
--disable-shared
```

- FreeBSD 4.7 i386 using LinuxThreads with [gcc 2.95.4](#):

```
CFLAGS="-DHAVE_BROKEN_REALPATH -D_USE_UNIX98 -D_REENTRANT
-D_THREAD_SAFE -I/usr/local/include/pthread/linuxthreads"
```

```
CXXFLAGS="-DHAVE_BROKEN_REALPATH -D_USE_UNIX98 -D_REENTRANT
-D_THREAD_SAFE -I/usr/local/include/pthread/linuxthreads" ./configure
--prefix=/usr/local/mysql --localstatedir=/usr/local/mysql/data
--libexecdir=/usr/local/mysql/bin --enable-thread-safe-client
--enable-local-infile --enable-asm
--with-named-thread-libs="-DHAVE_GLIBC2_STYLE_GETHOSTBYNAME_R
-D_THREAD_SAFE -I /usr/local/include/pthread/linuxthreads
-L/usr/local/lib -llthread -llgcc_r" --disable-shared
--with-embedded-server --with-innodb
```

- QNX Neutrino 6.2.1 i386 with `gcc 2.95.3qnx-nto 20010315`:

```
CC=gcc CFLAGS="-O3 -fno-omit-frame-pointer" CXX=gcc CXXFLAGS="-O3
-fno-omit-frame-pointer -felide-constructors -fno-exceptions
-fno-rtti" ./configure --prefix=/usr/local/mysql
--with-extra-charsets=complex --enable-thread-safe-client
--enable-local-infile --disable-shared
```

The following binaries are built on third-party systems kindly provided to Sun Microsystems, Inc. by other users. These are provided only as a courtesy; we do not have full control over these systems, so we can provide only limited support for the binaries built on them.

- SCO Unix 3.2v5.0.7 i386 with `gcc 2.95.3`:

```
CFLAGS="-O3 -mpentium" LDFLAGS="--static" CXX=gcc CXXFLAGS="-O3 -mpentium
-felide-constructors" ./configure --prefix=/usr/local/mysql
--with-extra-charsets=complex --enable-thread-safe-client
--enable-local-infile --with-named-z-libs=no --enable-thread-safe-client
--disable-shared
```

- SCO UnixWare 7.1.4 i386 with `CC 3.2`:

```
CC=cc CFLAGS="-O" CXX=CC ./configure --prefix=/usr/local/mysql
--with-extra-charsets=complex --enable-thread-safe-client
--enable-local-infile --with-named-z-libs=no --enable-thread-safe-client
--disable-shared --with-readline
```

- SCO OpenServer 6.0.0 i386 with `CC 3.2`:

```
CC=cc CFLAGS="-O" CXX=CC ./configure --prefix=/usr/local/mysql
--with-extra-charsets=complex --enable-thread-safe-client
--enable-local-infile --with-named-z-libs=no --enable-thread-safe-client
--disable-shared --with-readline
```

- Compaq Tru64 OSF/1 V5.1 732 alpha with `cc/cxx` (Compaq C V6.3-029i / DIGITAL C++ V6.1-027):

```
CC="cc -pthread" CFLAGS="-O4 -ansi_alias -ansi_args -fast -inline
speed -speculate all" CXX="c++ -pthread" CXXFLAGS="-O4 -ansi_alias
-fast -inline speed -speculate all -noexceptions -nortti" ./configure
--prefix=/usr/local/mysql --with-extra-charsets=complex
--enable-thread-safe-client --enable-local-infile
--with-named-thread-libs="-lpthread -lmach -lexc -lc" --disable-shared
--with-mysqld-ldflags=-all-static
```

- SGI Irix 6.5 IP32 with `gcc 3.0.1`:

```
CC=gcc CFLAGS="-O3 -fno-omit-frame-pointer" CXXFLAGS="-O3
-fno-omit-frame-pointer -felide-constructors -fno-exceptions
-fno-rtti" ./configure --prefix=/usr/local/mysql
--with-extra-charsets=complex --enable-thread-safe-client
--enable-local-infile --disable-shared
```

- FreeBSD/sparc64 5.0 with `gcc 3.2.1`:

```
CFLAGS=-DHAVE_BROKEN_REALPATH ./configure --prefix=/usr/local/mysql
--localstatedir=/usr/local/mysql/data --libexecdir=/usr/local/mysql/bin
--with-extra-charsets=complex --enable-thread-safe-client
--enable-local-infile --disable-shared --with-innodb
```

The following compile options have been used for binary packages that we have provided in the past. These binaries no longer are being updated, but the compile options are listed here for reference purposes.

- Linux 2.2.xx SPARC with [egcs 1.1.2](#):

```
CC=gcc CFLAGS="-O3 -fno-omit-frame-pointer" CXX=gcc CXXFLAGS="-O3
-fno-omit-frame-pointer -felide-constructors -fno-exceptions
-fno-rtti" ./configure --prefix=/usr/local/mysql
--with-extra-charsets=complex --enable-thread-safe-client
--enable-local-infile --enable-asmbler --disable-shared
```

- Linux 2.2.x with x686 with [gcc 2.95.2](#):

```
CFLAGS="-O3 -mpentiumpro" CXX=gcc CXXFLAGS="-O3 -mpentiumpro
-felide-constructors -fno-exceptions -fno-rtti" ./configure
--prefix=/usr/local/mysql --enable-asmbler
--with-mysqld-ldflags=-all-static --disable-shared
--with-extra-charsets=complex
```

- SunOS 4.1.4 2 sun4c with [gcc 2.7.2.1](#):

```
CC=gcc CXX=gcc CXXFLAGS="-O3 -felide-constructors" ./configure
--prefix=/usr/local/mysql --disable-shared --with-extra-charsets=complex
--enable-asmbler
```

- SunOS 5.5.1 (and above) sun4u with [egcs 1.0.3a](#) or [2.90.27](#) or [gcc 2.95.2](#) and newer:

```
CC=gcc CFLAGS="-O3" CXX=gcc CXXFLAGS="-O3 -felide-constructors
-fno-exceptions -fno-rtti" ./configure --prefix=/usr/local/mysql
--with-low-memory --with-extra-charsets=complex --enable-asmbler
```

- SunOS 5.6 i86pc with [gcc 2.8.1](#):

```
CC=gcc CXX=gcc CXXFLAGS=-O3 ./configure --prefix=/usr/local/mysql
--with-low-memory --with-extra-charsets=complex
```

- BSDI BSD/OS 3.1 i386 with [gcc 2.7.2.1](#):

```
CC=gcc CXX=gcc CXXFLAGS=-O ./configure --prefix=/usr/local/mysql
--with-extra-charsets=complex
```

- BSDI BSD/OS 2.1 i386 with [gcc 2.7.2](#):

```
CC=gcc CXX=gcc CXXFLAGS=-O3 ./configure --prefix=/usr/local/mysql
--with-extra-charsets=complex
```

- AIX 4.2 with [gcc 2.7.2.2](#):

```
CC=gcc CXX=gcc CXXFLAGS=-O3 ./configure --prefix=/usr/local/mysql
--with-extra-charsets=complex
```

### 2.1.3. How to Get MySQL

Check our downloads page at <http://dev.mysql.com/downloads/> for information about the current version of MySQL and for downloading instructions. For a complete up-to-date list of MySQL download mirror sites, see <http://dev.mysql.com/downloads/mirrors.html>. You can also find information there about becoming a MySQL mirror site and how to report a bad or out-of-date mirror.

Our main mirror is located at <http://mirrors.sunsite.dk/mysql/>.

### 2.1.4. Verifying Package Integrity Using MD5 Checksums or [GnuPG](#)

After you have downloaded the MySQL package that suits your needs and before you attempt to install it, you should make sure that it is intact and has not been tampered with. There are three means of integrity checking:

- MD5 checksums
- Cryptographic signatures using [GnuPG](#), the GNU Privacy Guard
- For RPM packages, the built-in RPM integrity verification mechanism



The following sections describe how to use these methods.

If you notice that the MD5 checksum or GPG signatures do not match, first try to download the respective package one more time, perhaps from another mirror site. If you repeatedly cannot successfully verify the integrity of the package, please notify us about such incidents, including the full package name and the download site you have been using, at [<webmaster@mysql.com>](mailto:webmaster@mysql.com) or [<build@mysql.com>](mailto:build@mysql.com). Do not report downloading problems using the bug-reporting system.

### 2.1.4.1. Verifying the MD5 Checksum

After you have downloaded a MySQL package, you should make sure that its MD5 checksum matches the one provided on the MySQL download pages. Each package has an individual checksum that you can verify with the following command, where *package\_name* is the name of the package you downloaded:

```
shell> md5sum package_name
```

Example:

```
shell> md5sum mysql-standard-5.1.36-linux-i686.tar.gz
aaab65abbec64d5e907dcd41b8699945 mysql-standard-5.1.36-linux-i686.tar.gz
```

You should verify that the resulting checksum (the string of hexadecimal digits) matches the one displayed on the download page immediately below the respective package.

#### Note

Make sure to verify the checksum of the *archive file* (for example, the `.zip` or `.tar.gz` file) and not of the files that are contained inside of the archive.

Note that not all operating systems support the `md5sum` command. On some, it is simply called `md5`, and others do not ship it at all. On Linux, it is part of the **GNU Text Utilities** package, which is available for a wide range of platforms. You can download the source code from <http://www.gnu.org/software/textutils/> as well. If you have OpenSSL installed, you can use the command `openssl md5 package_name` instead. A Windows implementation of the `md5` command line utility is available from <http://www.fourmilab.ch/md5/>. `winMd5Sum` is a graphical MD5 checking tool that can be obtained from <http://www.nullriver.com/index/products/winmd5sum>.

### 2.1.4.2. Signature Checking Using GnuPG

Another method of verifying the integrity and authenticity of a package is to use cryptographic signatures. This is more reliable than using MD5 checksums, but requires more work.

We sign MySQL downloadable packages with **GnuPG** (GNU Privacy Guard). **GnuPG** is an Open Source alternative to the well-known Pretty Good Privacy (**PGP**) by Phil Zimmermann. See <http://www.gnupg.org/> for more information about **GnuPG** and how to obtain and install it on your system. Most Linux distributions ship with **GnuPG** installed by default. For more information about **GnuPG**, see <http://www.openpgp.org/>.

To verify the signature for a specific package, you first need to obtain a copy of our public GPG build key, which you can download from <http://keyserver.pgp.com/>. The key that you want to obtain is named `build@mysql.com`. Alternatively, you can cut and paste the key directly from the following text:

```
-----BEGIN PGP PUBLIC KEY BLOCK-----
Version: GnuPG v1.0.6 (GNU/Linux)
Comment: For info see http://www.gnupg.org

mQGiBD4+owwRBAC14GifufCyEDSIEpVew3SAFUdJbtoQHH/nJKZyQT7h9bPlUWC3
RODJrQReyCITRrdwyrKUGku2FmeVGwn2u2WmDMNABLnpPrWPKBdCk96+OmSLN9brZ
fw2vOUgCmV2hW0hyDHuvY1QA/BThQoADgJ8AW6/0Lo7V1W9/8VuHP0gQwCgvzV3
BqOxRznNCRcRxAuAuVztHRcEAJooQK1+iSiunZMYD1WufeXfshc57S/+yeJkegNW
hxwR9pRWArNYJdDRT+rF2RUe3vpquKNQU/hnEIHJRQqYHo8gTxxvXNQc7fJYLV
K2HtkrPbp72vwsEKMYhhr0eKCbtlGfls9krjJ6sBgACyP/Vb7hiPwxh6rDZ7ITne
kYpXBAcmWp8NJTKamEnPcia2ZoOHODANwpUkP43I7jsDmgtobzX9qnrAXw+uNDI
QJEXM6FSbi0LLtZcinLYsafwAPEOMDKpMqAK6IyisNtPvald81H0bPanWqcyefep
rv0sxxqUEMcM3o7wWgFN83POkDasDbs3pjwPhxvzh6//62zQJ7Q7TXlTUUwgUGFj
a2FmZSBzawduaW5nIGtleSAod3d3Lml15c3FsLmNvbSkgPGJlaWxkQG15c3FsLmNv
bT6IXQQTbEQAHQUCR6yUtAUJDTBYqAULBwoDBAMVawIDFgITBAheAAAJEIXxjTtQ
cuHlrpIAN38+B1BI815Dou9VXMIAsQEek4G3tAJ9+Cz69Y/Xwm6111lzteJrCAA32+
aYhMBBMRAGAMBQI+PqPRBYMJZgC7AAoJEE1Q4SqcypHyJOEAn1mxHiJft00bKXvu
cSo/pECUmpPiAJ41M9MRVj5VcdH/KN/KjrtW6tHFPYhMBBMRAGAMBQI+QoIDBYMJ
YiKJAAoJELblzU3GuiQ/lpEAOIhpp6BozKI8p6eaabzF5MLJH58pAKCu/RoofK8J
Eg2aLos+5zeYrB/LsohGBBARAGAGBQI/r0OvAAoJEK/FI0h4g3QP9pYAoNtSISDD
AAU2HaFyAY1LD/yUC4hKAJ0czMsBlBoOM/xPaJ6Ox9Q5Hmw2uThGBBARAGAGBQI/
tEN3AAoJEEJWWr6swc05mXsMANRag9X61YgulkbfbigDku4czTd9pAJ4q5W8KZ0+2
ujTrEPN55NdWtnXj4YhGBBARAGAGBQJDW7PqAAoJEIvYlM8wuUcf3QAnRCyqF0C
pMCTdIGc7bdO5I7C1MhTAJ0UTGx001d/VwvdDiKwJ45N2tNbyIhGBBMRAGAGBQJE
8TMnAAoJEPZJxPRgk1MMcNEAoIm2pp0sIcVh9Yo0YGAqORrTOL3AjwIbcy+e8HM
NSoNv5u1RnrVKie34hMBBARAGAGBQJBGcsBBYMGItmLAAoJEBhZ0B9ne6HsQo0A
na/LCTQ3P5kvJvDhg1DsEVTfnJxpAJ49WFjg/kIcaN5iPlJfabaAITZi3H4hMBBAR
AgAMBQJBGcs0BYMGItlYAAoJElHC9+vIE7aSiMAnRVTVVafMXvJhV6D5uHfWeeD
```

```

046TAJ4kjp2bHyd6DjCymq+BdEDz63axohMBBARAgAMBQJBGctiBYMGItkqAAoJ
EGtw7Nldw/RzCaoAmwW6+Rj1z14D/PIys5nW48Hq13hAJ0bLOBthv96g+7oUy9U
j09Uh411f4hMBBARAgAMBQJBOJmKBYMF1BFoAAoJEH0lygrBKafCY1UAoIb1r5D6
qMLMPM01krHk3MNBx5b5AJ4vryx5fw61JctC5GWJ+Y8ytXab34hMBBARAgAMBQJ
K1u6BYMFeJjSAAoJEOYbpIkV67mr8xMAoJMy+UJC0sqXMPsXh3BUsdcmtFS+AJ9+
Z15LpoOnA1dTT/K9i0DXGViK6ohMBBIRAgAMBQJAK1k6BYMHeKtSAAoJEDyHhZSU
+vhhJ1wAnA/gOdW0Thj080+dFtdbpKuImfXJAJ0TL53QKp92EzscZS491D2YkoE
qohMBBIRAgAMBQJAPf6qBYMHZqnSAAoJEPLXXGPjngWcst8AoLQ3MJWqtTMMNDb1
xSyzXhfGhRU8AJ4ukRzFmJqE1QH00ZM2WnCVNzOUThMBBIRAgAMBQJBDqgqBYMG
lpoIAAoJEDnKK/Q9aopf/N0AniE2fcCK01wDIwusuGV1C+JvnnWbAKDDoUSEYUnN
5qzRbrzWW5zBno/Nb4hMBBIRAgAMBQJCGK0U0BYMFI/9YAAoJEAQNwIV8g5+o4yQA
nA9QOQLV5POCddyUMqB/Fnctu09eAJ4sJbLKP/Z3SAiTpKrNo+XZRxaucqIhMBBMR
AgAMBQI+TU2EBYJMjV1cIAAoJEC27dr+tlMkzBQwAoJU+RuTVsn+TI+uWxUpt82/d
s5NkAJ9bnNodfFyMMK7GyMiv/TzifiTD+4hMBBMRAgAMBQJB14B2BYMFzSQWAAoJ
EGbv28jNgv0+P7wAn13uu8YkhwfNMJhWdpK2/qM/4QAQJ40drnKW2qJ5EEIjWtx
pwapgrzWihYhMBBMRAgAMBQJCGIEOBYMfjCN+AAoJEHbBAxyiMW6ho04An0Ith3KX
5/sixbjZR9AEjoePGTNKAJ945ldLiESaYaJx21G1LD9bbvOHQYhdBMBMRAgAdBQJH
rJTPBQKnmFioBqSHCGMEAxUDAgMWAgECF4AACgkQjHGN01By4fV0KCGsLpG2wP0
rc3s07Fync9g7mfairMAoIUefSNKRGTsTxvLeyH4DLzJW/QFihSEMBECADsFAKJ3
NFU0HQBPb3BzLi4uIHNob3VsZCBoYXZ1IGJLZW4gbG9jYwWhIEknkSAqc28qIHN0
dXBpZC4uLgAKCRA5yiv0PwqKX+9HAJ0WjTx/rqgouK4QC+OV/2IOU+jMQCfYSC8
JgsIeN8aiyuStDYrK0VWCIjwQwEQIATwUCRw8Av0gdAFNob3VsZCBoYXZ1IGJL
ZW4gYSBsb2NhbCbzaWduYXR1cmUsIG9yIHNvbnV0aGlzYyAtIFdURiB3YXMGsSB0
aGlua2luZz8ACgkQOcor9D1qil+g+wCfcFwo05qU14XTE9K8tH3Q+xGweYYAnjii
KxjtOXc01s+B1qXxbfZ9uqBsiQI1BBABAgAMBQJBGcuFbYMGItkHAAoJEKJj5s5m
oURoqC8QAIIStdobcJRhR-TAROOPOmsReyp46Jdp3iL1LoFDGcPfkZSBwWh8L+cJjh
dyC+IwwSeZ1D2h9S5tC4EnoE0khsS6wBpuAuih5s//coRqI1LiLkEdhTmNqu1kCH5m
imCzc5zXWZDWOHplR2InGsZMuh2QCwAkB4RTBM+r18cUXMLV4YHkyjIvAdhsIPP/
MKUj6rJNsUDmDq1G1Jd0jySjtCFjYAD1QYSD7zcd1vpqQLThnZBESvEoCqumEFOp
xemNU6xAB0CL+pUpB40pE6Un6Krr5h6yZxYZ/N5vzt0Y3B5UUMkgYDspjbulNvaU
TFiOxLU3gJvXc1+h0BSsxM7FwBZnuMA8LEA+UdQb76YcyuFbCRohmEUTiducLu84
E2BZ2NSBdyMROKSiNhvXsEwLH6TxmlgtJLynYsvPi4B4JxKbb+awnFPusL8W+gFz
jbygekdyqzYgKj3M79R3geaY7Q75Kx1UogiOKcbI5VZvg47OQCWeeERneJqAdx
EQ1wGA/ARhVOP/11LOQA7jg2P1xTtrBqgC2ufDB+v+jhXaCXxstKSW11Tbv/b0d6
454UaOUV7Risn39pE2zFvJvY7bwfiwbUJvYmYlM4rWJAE0JLIDtDRt2h8JahDobm
3CwKpadjw57S5v1c/mn+xV9yTgVx5YUFC/788L1HNKXfeVDq8zbaAiQI1BBMBAgAM
BQJCNwocBYMFBZpwaAoJENjCCglajFFpIT4P/25zvPp8ixqV85igs3rRqMbtBs+j
5EoEW6DjnlGhoi26yflnasC2frVasWG7i4JIm0U3WfLZERGDjR/nq1OCEqsp5gS3
43N7r4UpDkBsYh0WxH/ZtST51lFK3zd7XgtxvqKL981/OSgijh2W2SJ9Dgpjt0+T
iegg7igtJzw7Vax9z/LQH2xhRQKZR9yernwMSYaJ72i9SyWbK3k0+e95fGnlR5P
z1Gq320rYHgD7v9yOq2t1klsAxK6e3b7Z+RiJG6cAU8o8F0KgxjwZf4v8D1op7S+
IoRdB0Bap01koOKLyt3+g4/33/2UxsW50BtfgcvYNUvU4bZns1YSqAgDO0anBhg8
Ip5XP1DxH6J/3997793Jn/nk5o5jfd8nyfe/5TjflWN1put6tZ7frEki1w16pTNbv
V9C1eLUJMSXfDzYtUxMlP9DKNpsucCUEBKWRKLqnsHLkLYdsIeUJ8+ciKc+EWh
FxY+M172cXAAz5BuW9L8KHnzZzFz/ZJabIARQpFfjOwAnmhZJ9r++TEKRLER96
taUI9/8nVPvT6LnBpcM38Td6dJ639YvuH3ilAqmPPw50Yvg1IE4BUYD5r52Seqc
8XQowouG0uBx4vs7zgwFuYA/s9ebfGaiw+uJd/56K19116q5CghqB/yt1EceFEnF
CAJQc2SeRo6qzx22uQINBD4+ox0QCAdv4Y1/Fsx1jjCyU+emf2sXg3ap9awQ3+XF
pmg1hdrozTZYKceXpFPb+0ErbDVAjhgW15HjuAK+2Bvo7Ukd986jYd8uZENGJG
N3UNM1ep7JfsIeFyCGP901GVbZnSXLAUryZx1TRWgndov9YlHsN+zctT6GQBbMTV
NoPlwfonvK//rG5lXDJXXSHhSsqNxy7SIZUHMqUPFUNjvCg8Rv871GRt/h+Yt
7XUTMhoJrg+oBfDB1zh2FKKcy3ordfgGtGwpN+jMG7vgXjsPwiVt/m9Jgdu4Tmn/
WggP0eSD+nyRb7cxG5avJxyKoVnW3PbXnLJf0tcWeUvMprv8XkbAAMFB/4vCqpr
WiatF+w4AnGkbrCId+3LmZrZmtRKdOyUZgQg4JHUF5Bq7I91s80wMP0xnVlpJ9q
cW/AUbouXH3GRTu30r68ouhaSbi7nF/e+fnlW0dJ3VpD15CdRxeIvhyeEahNs5Yj
fOrZLOCyXMF0L74w+NxBNwDuno1RWw/qgAHCvBaDni25SJQRzxuwzxcS/jYua5B
Pk10ocbAexdM+2XSSWtCTg5gMeyLLUExqGLPbuNaMmUy1lZ4hYnSACGQoe33bq
z/KZ91/keR1DVk+zPm2vJUjcxHvx5Jh9C+67CqnYFXf21cYSSDSop1Q5611la
F7vRgY0/DXKNY1PUiEwEGBECAAwFAkes1PwFCQ0wWN8ACgkQjHGN01By4fW1zgCf
Qj3rkfcljYZOuL0n50J7PFuF7FoAnjwWghwVi9+Fm2B5RZvpo++BBkdp
=Xquv
-----END PGP PUBLIC KEY BLOCK-----

```

To import the build key into your personal public GPG keyring, use `gpg --import`. For example, if you have saved the key in a file named `mysql_pubkey.asc`, the import command looks like this:

```

shell> gpg --import mysql_pubkey.asc
gpg: key 5072E1F5: public key "MySQL Package signing key (www.mysql.com) <build@mysql.com>" imported
gpg: Total number processed: 1
gpg:             imported: 1
gpg: no ultimately trusted keys found

```

You can also download the key from the public keyserver using the public key id, `5072E1F5`:

```

shell> gpg --recv-keys 5072E1F5
gpg: requesting key 5072E1F5 from hkp server subkeys.gpg.net
gpg: key 5072E1F5: "MySQL Package signing key (www.mysql.com) <build@mysql.com>" 2 new signatures
gpg: no ultimately trusted keys found
gpg: Total number processed: 1
gpg:             new signatures: 2

```

If you want to import the key into your RPM configuration to validate RPM install packages, you should be able to import the key directly:

```
shell> rpm --import mysql_pubkey.asc
```

If you experience problems, try exporting the key from `gpg` and importing:

```
shell> gpg --export -a 5072e1f5 > 5072e1f5.asc
shell> rpm --import 5072e1f5.asc
```

Alternatively, `rpm` also supports loading the key directly from a URL, and you can use this manual page:

```
shell> rpm --import http://dev.mysql.com/doc/refman/5.1/en/checking-gpg-signature.html
```

After you have downloaded and imported the public build key, download your desired MySQL package and the corresponding signature, which also is available from the download page. The signature file has the same name as the distribution file with an `.asc` extension, as shown by the examples in the following table.

Distribution file	<code>mysql-standard-5.1.36-linux-i686.tar.gz</code>
Signature file	<code>mysql-standard-5.1.36-linux-i686.tar.gz.asc</code>

Make sure that both files are stored in the same directory and then run the following command to verify the signature for the distribution file:

```
shell> gpg --verify package_name.asc
```

Example:

```
shell> gpg --verify mysql-standard-5.1.36-linux-i686.tar.gz.asc
gpg: Signature made Tue 12 Jul 2005 23:35:41 EST using DSA key ID 5072E1F5
gpg: Good signature from "MySQL Package signing key (www.mysql.com) <build@mysql.com>"
```

The `Good signature` message indicates that everything is all right. You can ignore any `insecure memory` warning you might obtain.

See the GPG documentation for more information on how to work with public keys.

### 2.1.4.3. Signature Checking Using RPM

For RPM packages, there is no separate signature. RPM packages have a built-in GPG signature and MD5 checksum. You can verify a package by running the following command:

```
shell> rpm --checksig package_name.rpm
```

Example:

```
shell> rpm --checksig MySQL-server-5.1.36-0.glibc23.i386.rpm
MySQL-server-5.1.36-0.glibc23.i386.rpm: md5 gpg OK
```

#### Note

If you are using RPM 4.1 and it complains about `(GPG) NOT OK (MISSING KEYS: GPG#5072e1f5)`, even though you have imported the MySQL public build key into your own GPG keyring, you need to import the key into the RPM keyring first. RPM 4.1 no longer uses your personal GPG keyring (or GPG itself). Rather, it maintains its own keyring because it is a system-wide application and a user's GPG public keyring is a user-specific file. To import the MySQL public key into the RPM keyring, first obtain the key as described in [Section 2.1.4.2, "Signature Checking Using GnuPG"](#). Then use `rpm --import` to import the key. For example, if you have saved the public key in a file named `mysql_pubkey.asc`, import it using this command:

```
shell> rpm --import mysql_pubkey.asc
```

If you need to obtain the MySQL public key, see [Section 2.1.4.2, "Signature Checking Using GnuPG"](#).

## 2.1.5. Installation Layouts

This section describes the default layout of the directories created by installing binary or source distributions provided by Sun Microsystems, Inc. A distribution provided by another vendor might use a layout different from those shown here.

For MySQL 5.1 on Windows, the default installation directory is `C:\Program Files\MySQL\MySQL Server 5.1`. (Some Windows users prefer to install in `C:\mysql`, the directory that formerly was used as the default. However, the layout of the subdirectories remains the same.) The installation directory has the following subdirectories.

Directory	Contents of Directory
-----------	-----------------------

<code>bin</code>	Client programs and the <code>mysqld</code> server
<code>data</code>	Log files, databases
<code>Docs</code>	Manual in CHM format
<code>examples</code>	Example programs and scripts
<code>include</code>	Include (header) files
<code>lib</code>	Libraries
<code>scripts</code>	Utility scripts
<code>share</code>	Error message files

Installations created from our Linux RPM distributions result in files under the following system directories.

Directory	Contents of Directory
<code>/usr/bin</code>	Client programs and scripts
<code>/usr/sbin</code>	The <code>mysqld</code> server
<code>/var/lib/mysql</code>	Log files, databases
<code>/usr/share/info</code>	Manual in Info format
<code>/usr/share/man</code>	Unix manual pages
<code>/usr/include/mysql</code>	Include (header) files
<code>/usr/lib/mysql</code>	Libraries
<code>/usr/share/mysql</code>	Error message and character set files
<code>/usr/share/sql-bench</code>	Benchmarks

On Unix, a `tar` file binary distribution is installed by unpacking it at the installation location you choose (typically `/usr/local/mysql`) and creates the following directories in that location.

Directory	Contents of Directory
<code>bin</code>	Client programs and the <code>mysqld</code> server
<code>data</code>	Log files, databases
<code>docs</code>	Manual in Info format
<code>man</code>	Unix manual pages
<code>include</code>	Include (header) files
<code>lib</code>	Libraries
<code>scripts</code>	<code>mysql_install_db</code>
<code>share/mysql</code>	Error message files
<code>sql-bench</code>	Benchmarks

A source distribution is installed after you configure and compile it. By default, the installation step installs files under `/usr/local`, in the following subdirectories.

Directory	Contents of Directory
<code>bin</code>	Client programs and scripts
<code>include/mysql</code>	Include (header) files
<code>Docs</code>	Manual in Info, CHM formats
<code>man</code>	Unix manual pages
<code>lib/mysql</code>	Libraries
<code>libexec</code>	The <code>mysqld</code> server
<code>share/mysql</code>	Error message files
<code>sql-bench</code>	Benchmarks and <code>crash-me</code> test
<code>var</code>	Databases and log files

Within its installation directory, the layout of a source installation differs from that of a binary installation in the following ways:

- The `mysqld` server is installed in the `libexec` directory rather than in the `bin` directory.
- The data directory is `var` rather than `data`.
- `mysql_install_db` is installed in the `bin` directory rather than in the `scripts` directory.
- The header file and library directories are `include/mysql` and `lib/mysql` rather than `include` and `lib`.

You can create your own binary installation from a compiled source distribution by executing the `scripts/make_binary_distribution` script from the top directory of the source distribution.

## 2.2. Standard MySQL Installation Using a Binary Distribution

The next several sections cover the installation of MySQL on platforms where we offer packages using the native packaging format of the respective platform. (This is also known as performing a “binary install.”) However, binary distributions of MySQL are available for many other platforms as well. See [Section 2.9, “Installing MySQL from tar.gz Packages on Other Unix-Like Systems”](#), for generic installation instructions for these packages that apply to all platforms.

See [Section 2.1, “General Installation Issues”](#), for more information on what other binary distributions are available and how to obtain them.

## 2.3. Installing MySQL on Windows

A native Windows distribution of MySQL has been available since version 3.21 and represents a sizable percentage of the daily downloads of MySQL. This section describes the process for installing MySQL on Windows.

### Note

If you are upgrading MySQL from an existing installation older than MySQL 4.1.5, you must first perform the procedure described in [Section 2.3.14, “Upgrading MySQL on Windows”](#).

To run MySQL on Windows, you need the following:

- A Windows operating system such as Windows 2000, Windows XP, Windows Vista, Windows Server 2003, or Windows Server 2008.

A Windows operating system permits you to run the MySQL server as a service. See [Section 2.3.11, “Starting MySQL as a Windows Service”](#).

Generally, you should install MySQL on Windows using an account that has administrator rights. Otherwise, you may encounter problems with certain operations such as editing the `PATH` environment variable or accessing the [Service Control Manager](#). Once installed, MySQL does not need to be executed using a user with Administrator privileges.

- TCP/IP protocol support.
- Enough space on the hard drive to unpack, install, and create the databases in accordance with your requirements (generally a minimum of 200 megabytes is recommended.)

For a list of limitations within the Windows version of MySQL, see [Section D.7.3, “Windows Platform Limitations”](#).

There may also be other requirements, depending on how you plan to use MySQL:

- If you plan to connect to the MySQL server via ODBC, you need a Connector/ODBC driver. See [Section 20.1, “MySQL Connector/ODBC”](#).
- If you plan to use MySQL server with ADO.NET applications, you need the Connector/NET driver. See [Section 20.2, “MySQL Connector/NET”](#).
- If you need tables with a size larger than 4GB, install MySQL on an NTFS or newer file system. Don't forget to use `MAX_ROWS` and `AVG_ROW_LENGTH` when you create tables. See [Section 12.1.17, “CREATE TABLE Syntax”](#).

MySQL for Windows is available in several distribution formats:

- Binary distributions are available that contain a setup program that installs everything you need so that you can start the server immediately. Another binary distribution format contains an archive that you simply unpack in the installation location and then configure yourself. For details, see [Section 2.3.1, “Choosing An Installation Package”](#).
- The source distribution contains all the code and support files for building the executables using the Visual Studio compiler system.

Generally speaking, you should use a binary distribution that includes an installer. It is simpler to use than the others, and you need no additional tools to get MySQL up and running. The installer for the Windows version of MySQL, combined with a GUI Configuration Wizard, automatically installs MySQL, creates an option file, starts the server, and secures the default user accounts.

### Caution

Using virus scanning software such as Norton/Symantec Anti-Virus on directories containing MySQL data and temporary tables can cause issues, both in terms of the performance of MySQL and the virus-scanning software mis-identifying the contents of the files as containing spam. This is because of the fingerprinting mechanism used by the virus scanning software, and the way in which MySQL rapidly updates different files, which may be identified as a potential security risk.

After installing MySQL Server, it is recommended that you disable virus scanning on the main directory (`datadir`) being used to store your MySQL table data. There is usually a system built into the virus scanning software to allow certain directories to be specifically ignored during virus scanning.

In addition, by default, MySQL creates temporary files in the standard Windows temporary directory. To prevent the temporary files also being scanned, you should configure a separate temporary directory for MySQL temporary files and add this to the virus scanning exclusion list. To do this, add a configuration option for the `tmpdir` parameter to your `my.ini` configuration file. For more information, see [Section 2.3.7, “Creating an Option File”](#).

The following section describes how to install MySQL on Windows using a binary distribution. To use an installation package that does not include an installer, follow the procedure described in [Section 2.3.5, “Installing MySQL from a Noinstall Zip Archive”](#). To install using a source distribution, see [Section 2.10.6, “Installing MySQL from Source on Windows”](#).

MySQL distributions for Windows can be downloaded from <http://dev.mysql.com/downloads/>. See [Section 2.1.3, “How to Get MySQL”](#).

## 2.3.1. Choosing An Installation Package

For MySQL 5.1, there are three installation packages to choose from when installing MySQL on Windows:

- **The Essentials Package:** This package has a file name similar to `mysql-essential-5.1.36-win32.msi` and contains the minimum set of files needed to install MySQL on Windows, including the Configuration Wizard. This package does not include optional components such as the embedded server and benchmark suite.
- **The Complete Package:** This package has a file name similar to `mysql-5.1.36-win32.zip` and contains all files needed for a complete Windows installation, including the Configuration Wizard. This package includes optional components such as the embedded server and benchmark suite.
- **The Noinstall Archive:** This package has a file name similar to `mysql-noinstall-5.1.36-win32.zip` and contains all the files found in the Complete install package, with the exception of the Configuration Wizard. This package does not include an automated installer, and must be manually installed and configured.

The Essentials package is recommended for most users. It is provided as an `.msi` file for use with the Windows Installer. The Complete and Noinstall distributions are packaged as Zip archives. To use them, you must have a tool that can unpack `.zip` files.

Your choice of install package affects the installation process you must follow. If you choose to install either the Essentials or Complete install packages, see [Section 2.3.2, “Installing MySQL with the Automated Installer”](#). If you choose to install MySQL from the Noinstall archive, see [Section 2.3.5, “Installing MySQL from a Noinstall Zip Archive”](#).

## 2.3.2. Installing MySQL with the Automated Installer

New MySQL users can use the MySQL Installation Wizard and MySQL Configuration Wizard to install MySQL on Windows. These are designed to install and configure MySQL in such a way that new users can immediately get started using MySQL.

The MySQL Installation Wizard and MySQL Configuration Wizard are available in the Essentials and Complete install packages. They are recommended for most standard MySQL installations. Exceptions include users who need to install multiple instances of MySQL on a single server host and advanced users who want complete control of server configuration.



## 2.3.3. Using the MySQL Installation Wizard

MySQL Installation Wizard is an installer for the MySQL server that uses the latest installer technologies for Microsoft Windows. The MySQL Installation Wizard, in combination with the MySQL Configuration Wizard, allows a user to install and configure a MySQL server that is ready for use immediately after installation.

The MySQL Installation Wizard is the standard installer for all MySQL server distributions, version 4.1.5 and higher. Users of previous versions of MySQL need to shut down and remove their existing MySQL installations manually before installing MySQL with the MySQL Installation Wizard. See [Section 2.3.3.6, “Upgrading MySQL with the Installation Wizard”](#), for more information on upgrading from a previous version.

Microsoft has included an improved version of their Microsoft Windows Installer (MSI) in the recent versions of Windows. MSI has become the de-facto standard for application installations on Windows 2000, Windows XP, and Windows Server 2003. The MySQL Installation Wizard makes use of this technology to provide a smoother and more flexible installation process.

The Microsoft Windows Installer Engine was updated with the release of Windows XP; those using a previous version of Windows can reference [this Microsoft Knowledge Base article](#) for information on upgrading to the latest version of the Windows Installer Engine.

In addition, Microsoft has introduced the WiX (Windows Installer XML) toolkit recently. This is the first highly acknowledged Open Source project from Microsoft. We have switched to WiX because it is an Open Source project and it allows us to handle the complete Windows installation process in a flexible manner using scripts.

Improving the MySQL Installation Wizard depends on the support and feedback of users like you. If you find that the MySQL Installation Wizard is lacking some feature important to you, or if you discover a bug, please report it in our bugs database using the instructions given in [Section 1.6, “How to Report Bugs or Problems”](#).

### 2.3.3.1. Downloading and Starting the MySQL Installation Wizard

The MySQL installation packages can be downloaded from <http://dev.mysql.com/downloads/>. If the package you download is contained within a Zip archive, you need to extract the archive first.

#### Note

If you are installing on Windows Vista it is best to open a network port before beginning the installation. To do this, first ensure that you are logged in as an Administrator, go to the [Control Panel](#), and double click the [Windows Firewall](#) icon. Choose the [Allow a program through Windows Firewall](#) option and click the [ADD PORT](#) button. Enter [MySQL](#) into the [NAME](#) text box and [3306](#) (or the port of your choice) into the [PORT NUMBER](#) text box. Also ensure that the [TCP](#) protocol radio button is selected. If you wish, you can also limit access to the MySQL server by choosing the [CHANGE SCOPE](#) button. Confirm your choices by clicking the [OK](#) button. If you do not open a port prior to installation, you cannot configure the MySQL server immediately after installation. Additionally, when running the MySQL Installation Wizard on Windows Vista, ensure that you are logged in as a user with administrative rights.

The process for starting the wizard depends on the contents of the installation package you download. If there is a [setup.exe](#) file present, double-click it to start the installation process. If there is an [.msi](#) file present, double-click it to start the installation process.

### 2.3.3.2. Choosing an Install Type

There are three installation types available: **Typical**, **Complete**, and **Custom**.

The **Typical** installation type installs the MySQL server, the [mysql](#) command-line client, and the command-line utilities. The command-line clients and utilities include [mysqldump](#), [myisamchk](#), and several other tools to help you manage the MySQL server.

The **Complete** installation type installs all components included in the installation package. The full installation package includes components such as the embedded server library, the benchmark suite, support scripts, and documentation.

The **Custom** installation type gives you complete control over which packages you wish to install and the installation path that is used. See [Section 2.3.3.3, “The Custom Install Dialog”](#), for more information on performing a custom install.

If you choose the **Typical** or **Complete** installation types and click the [NEXT](#) button, you advance to the confirmation screen to verify your choices and begin the installation. If you choose the **Custom** installation type and click the [NEXT](#) button, you advance to the custom installation dialog, described in [Section 2.3.3.3, “The Custom Install Dialog”](#).

### 2.3.3.3. The Custom Install Dialog

If you wish to change the installation path or the specific components that are installed by the MySQL Installation Wizard, choose the **Custom** installation type.



A tree view on the left side of the custom install dialog lists all available components. Components that are not installed have a red X icon; components that are installed have a gray icon. To change whether a component is installed, click on that component's icon and choose a new option from the drop-down list that appears.

You can change the default installation path by clicking the CHANGE... button to the right of the displayed installation path.

After choosing your installation components and installation path, click the NEXT button to advance to the confirmation dialog.

### 2.3.3.4. The Confirmation Dialog

Once you choose an installation type and optionally choose your installation components, you advance to the confirmation dialog. Your installation type and installation path are displayed for you to review.

To install MySQL if you are satisfied with your settings, click the INSTALL button. To change your settings, click the BACK button. To exit the MySQL Installation Wizard without installing MySQL, click the CANCEL button.

After installation is complete, you have the option of registering with the MySQL web site. Registration gives you access to post in the MySQL forums at [forums.mysql.com](http://forums.mysql.com), along with the ability to report bugs at [bugs.mysql.com](http://bugs.mysql.com) and to subscribe to our newsletter. The final screen of the installer provides a summary of the installation and gives you the option to launch the MySQL Configuration Wizard, which you can use to create a configuration file, install the MySQL service, and configure security settings.

### 2.3.3.5. Changes Made by MySQL Installation Wizard

Once you click the INSTALL button, the MySQL Installation Wizard begins the installation process and makes certain changes to your system which are described in the sections that follow.

#### Changes to the Registry

The MySQL Installation Wizard creates one Windows registry key in a typical install situation, located in `HKEY_LOCAL_MACHINE\SOFTWARE\MySQL AB`.

The MySQL Installation Wizard creates a key named after the major version of the server that is being installed, such as `MySQL Server 5.1`. It contains two string values, `Location` and `Version`. The `Location` string contains the path to the installation directory. In a default installation it contains `C:\Program Files\MySQL\MySQL Server 5.1\`. The `Version` string contains the release number. For example, for an installation of MySQL Server 5.1.36, the key contains a value of `5.1.36`.

These registry keys are used to help external tools identify the installed location of the MySQL server, preventing a complete scan of the hard-disk to determine the installation path of the MySQL server. The registry keys are not required to run the server, and if you install MySQL using the `noinstall` Zip archive, the registry keys are not created.

#### Changes to the Start Menu

The MySQL Installation Wizard creates a new entry in the Windows **START** menu under a common MySQL menu heading named after the major version of MySQL that you have installed. For example, if you install MySQL 5.1, the MySQL Installation Wizard creates a MySQL Server 5.1 section in the **START** menu.

The following entries are created within the new **START** menu section:

- **MySQL Command Line Client:** This is a shortcut to the `mysql` command-line client and is configured to connect as the `root` user. The shortcut prompts for a `root` user password when you connect.
- **MySQL Server Instance Config Wizard:** This is a shortcut to the MySQL Configuration Wizard. Use this shortcut to configure a newly installed server, or to reconfigure an existing server.
- **MySQL Documentation:** This is a link to the MySQL server documentation that is stored locally in the MySQL server installation directory. This option is not available when the MySQL server is installed using the Essentials installation package.

#### Changes to the File System

The MySQL Installation Wizard by default installs the MySQL 5.1 server to `C:\Program Files\MySQL\MySQL Server 5.1`, where `Program Files` is the default location for applications in your system, and `5.1` is the major version of your MySQL server. This is the recommended location for the MySQL server, replacing the former default location `C:\mysql`.

By default, all MySQL applications are stored in a common directory at `C:\Program Files\MySQL`, where `Program Files` is the default location for applications in your Windows installation. A typical MySQL installation on a developer machine might look like this:

```
C:\Program Files\MySQL\MySQL Server 5.1
C:\Program Files\MySQL\MySQL Administrator 1.0
```

```
C:\Program Files\MySQL\MySQL Query Browser 1.0
```

This approach makes it easier to manage and maintain all MySQL applications installed on a particular system.

In MySQL 5.1.23 and earlier, the default location for the data files used by MySQL is located within the corresponding MySQL Server installation directory. For MySQL 5.1.24 and later, the default location of the data directory is the `AppData` directory configured for the user that installed the MySQL application.

### 2.3.3.6. Upgrading MySQL with the Installation Wizard

The MySQL Installation Wizard can perform server upgrades automatically using the upgrade capabilities of MSI. That means you do not need to remove a previous installation manually before installing a new release. The installer automatically shuts down and removes the previous MySQL service before installing the new version.

Automatic upgrades are available only when upgrading between installations that have the same major and minor version numbers. For example, you can upgrade automatically from MySQL 4.1.5 to MySQL 4.1.6, but not from MySQL 5.0 to MySQL 5.1.

See [Section 2.3.14, “Upgrading MySQL on Windows”](#).

### 2.3.4. MySQL Server Instance Configuration Wizard

The MySQL Server Instance Configuration Wizard helps automate the process of configuring your server. It creates a custom MySQL configuration file (`my.ini` or `my.cnf`) by asking you a series of questions and then applying your responses to a template to generate the configuration file that is tuned to your installation.

The MySQL Server Instance Configuration Wizard is included with the MySQL 5.1 server. The MySQL Server Instance Configuration Wizard is only available for Windows.

#### 2.3.4.1. Starting the MySQL Server Instance Configuration Wizard

The MySQL Server Instance Configuration Wizard is normally started as part of the installation process. You should only need to run the MySQL Server Instance Configuration Wizard again when you need to change the configuration parameters of your server.

If you chose not to open a port prior to installing MySQL on Windows Vista, you can choose to use the MySQL Server Configuration Wizard after installation. However, you must open a port in the Windows Firewall. To do this see the instructions given in [Section 2.3.3.1, “Downloading and Starting the MySQL Installation Wizard”](#). Rather than opening a port, you also have the option of adding MySQL as a program that bypasses the Windows Firewall. One or the other option is sufficient — you need not do both. Additionally, when running the MySQL Server Configuration Wizard on Windows Vista ensure that you are logged in as a user with administrative rights.



You can launch the MySQL Configuration Wizard by clicking the MySQL Server Instance Config Wizard entry in the MySQL section of the Windows START menu.

Alternatively, you can navigate to the `bin` directory of your MySQL installation and launch the `MySQLInstanceConfig.exe` file directly.

The MySQL Server Instance Configuration Wizard places the `my.ini` file in the installation directory for the MySQL server. This helps associate configuration files with particular server instances.

To ensure that the MySQL server knows where to look for the `my.ini` file, an argument similar to this is passed to the MySQL server as part of the service installation:

```
--defaults-file="C:\Program Files\MySQL\MySQL Server 5.1\my.ini"
```

Here, `C:\Program Files\MySQL\MySQL Server 5.1` is replaced with the installation path to the MySQL Server. The `--defaults-file` option instructs the MySQL server to read the specified file for configuration options when it starts.

Apart from making changes to the `my.ini` file by running the MySQL Server Instance Configuration Wizard again, you can modify it by opening it with a text editor and making any necessary changes. You can also modify the server configuration with the [MySQL Administrator](#) utility. For more information about server configuration, see [Section 5.1.2, “Server Command Options”](#).

MySQL clients and utilities such as the `mysql` and `mysqldump` command-line clients are not able to locate the `my.ini` file located in the server installation directory. To configure the client and utility applications, create a new `my.ini` file in the Windows installation directory (for example, `C:\WINDOWS`).

Under Windows Server 2003, Windows Server 2000, Windows XP, and Windows Vista MySQL Server Instance Configuration Wizard will configure MySQL to work as a Windows service. To start and stop MySQL you use the [Services](#) application that is supplied as part of the Windows Administrator Tools.

### 2.3.4.2. Choosing a Maintenance Option

If the MySQL Server Instance Configuration Wizard detects an existing configuration file, you have the option of either reconfiguring your existing server, or removing the server instance by deleting the configuration file and stopping and removing the MySQL service.

To reconfigure an existing server, choose the Re-configure Instance option and click the NEXT button. Any existing configuration file is not overwritten, but renamed (within the same directory) using a timestamp (Windows) or sequential number (Linux). To remove the existing server instance, choose the Remove Instance option and click the NEXT button.

If you choose the Remove Instance option, you advance to a confirmation window. Click the EXECUTE button. The MySQL Server Configuration Wizard stops and removes the MySQL service, and then deletes the configuration file. The server installation and its `data` folder are not removed.

If you choose the Re-configure Instance option, you advance to the `CONFIGURATION TYPE` dialog where you can choose the type of installation that you wish to configure.

### 2.3.4.3. Choosing a Configuration Type

When you start the MySQL Server Instance Configuration Wizard for a new MySQL installation, or choose the Re-configure Instance option for an existing installation, you advance to the `CONFIGURATION TYPE` dialog.



There are two configuration types available: Detailed Configuration and Standard Configuration. The Standard Configuration option is intended for new users who want to get started with MySQL quickly without having to make many decisions about server configuration. The Detailed Configuration option is intended for advanced users who want more fine-grained control over server configuration.

If you are new to MySQL and need a server configured as a single-user developer machine, the Standard Configuration should suit your needs. Choosing the Standard Configuration option causes the MySQL Configuration Wizard to set all configuration options automatically with the exception of Service Options and Security Options.

The Standard Configuration sets options that may be incompatible with systems where there are existing MySQL installations. If you have an existing MySQL installation on your system in addition to the installation you wish to configure, the Detailed Config-

uration option is recommended.

To complete the Standard Configuration, please refer to the sections on Service Options and Security Options in [Section 2.3.4.10, “The Service Options Dialog”](#), and [Section 2.3.4.11, “The Security Options Dialog”](#), respectively.

### 2.3.4.4. The Server Type Dialog

There are three different server types available to choose from. The server type that you choose affects the decisions that the MySQL Server Instance Configuration Wizard makes with regard to memory, disk, and processor usage.



- **Developer Machine:** Choose this option for a typical desktop workstation where MySQL is intended only for personal use. It is assumed that many other desktop applications are running. The MySQL server is configured to use minimal system resources.
- **Server Machine:** Choose this option for a server machine where the MySQL server is running alongside other server applications such as FTP, email, and Web servers. The MySQL server is configured to use a moderate portion of the system resources.
- **Dedicated MySQL Server Machine:** Choose this option for a server machine that is intended to run only the MySQL server. It is assumed that no other applications are running. The MySQL server is configured to use all available system resources.

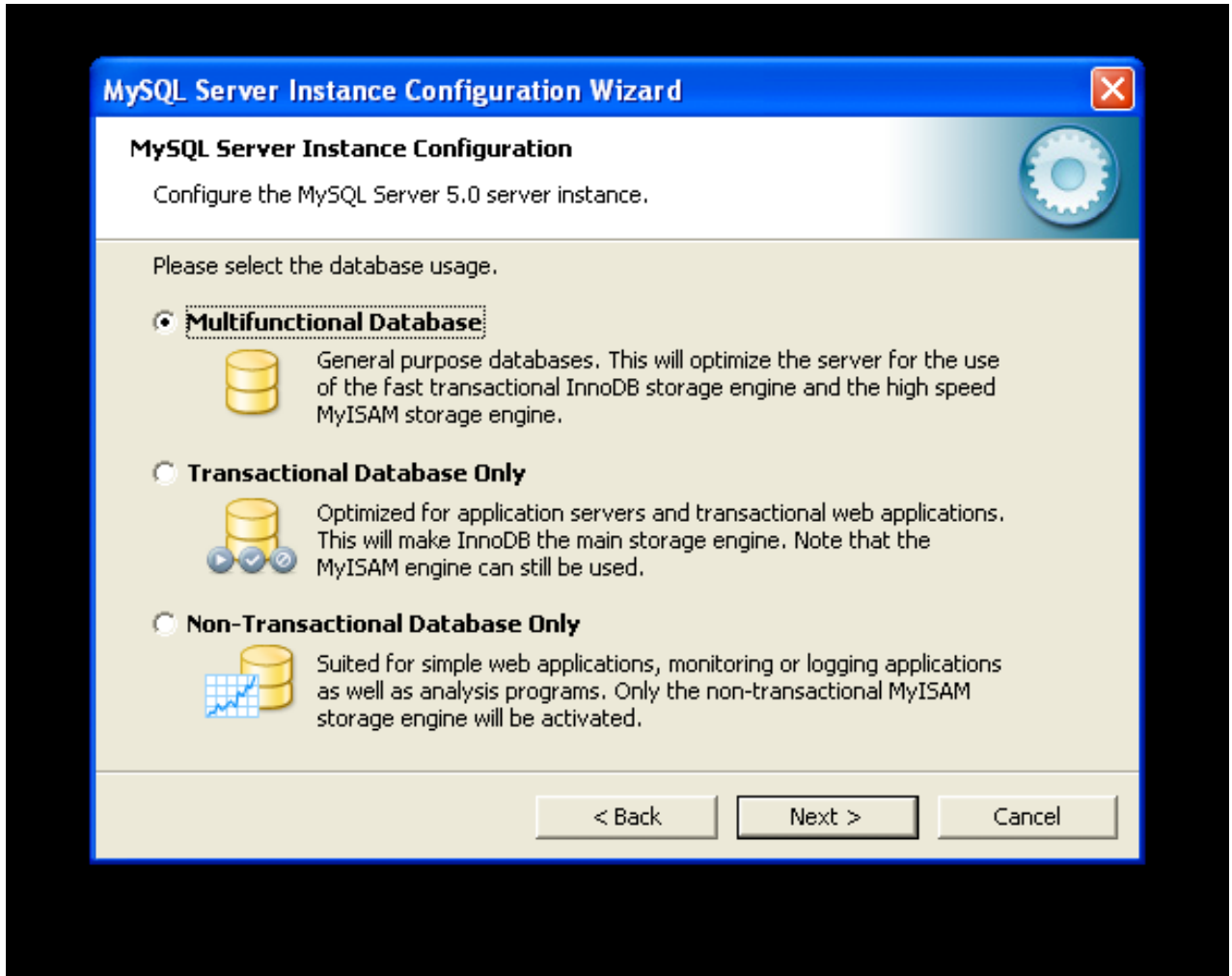
#### Note

By selecting one of the preconfigured configurations, the values and settings of various options in your `my.cnf` or `my.ini` will be altered accordingly. The default values and options as described in the reference manual may therefore be different to the options and values that were created during the execution of the configuration wizard.

### 2.3.4.5. The Database Usage Dialog

The `DATABASE USAGE` dialog allows you to indicate the storage engines that you expect to use when creating MySQL tables. The option you choose determines whether the `InnoDB` storage engine is available and what percentage of the server resources are

available to [InnoDB](#).



- **Multifunctional Database:** This option enables both the [InnoDB](#) and [MyISAM](#) storage engines and divides resources evenly between the two. This option is recommended for users who use both storage engines on a regular basis.
- **Transactional Database Only:** This option enables both the [InnoDB](#) and [MyISAM](#) storage engines, but dedicates most server resources to the [InnoDB](#) storage engine. This option is recommended for users who use [InnoDB](#) almost exclusively and make only minimal use of [MyISAM](#).
- **Non-Transactional Database Only:** This option disables the [InnoDB](#) storage engine completely and dedicates all server resources to the [MyISAM](#) storage engine. This option is recommended for users who do not use [InnoDB](#).

The Configuration Wizard uses a template to generate the server configuration file. The [DATABASE USAGE](#) dialog sets one of the following option strings:

```
Multifunctional Database:      MIXED
Transactional Database Only:  INNODB
Non-Transactional Database Only: MYISAM
```

When these options are processed through the default template (my-template.ini) the result is:

```
Multifunctional Database:
default-storage-engine=InnoDB
_myisam_pct=50

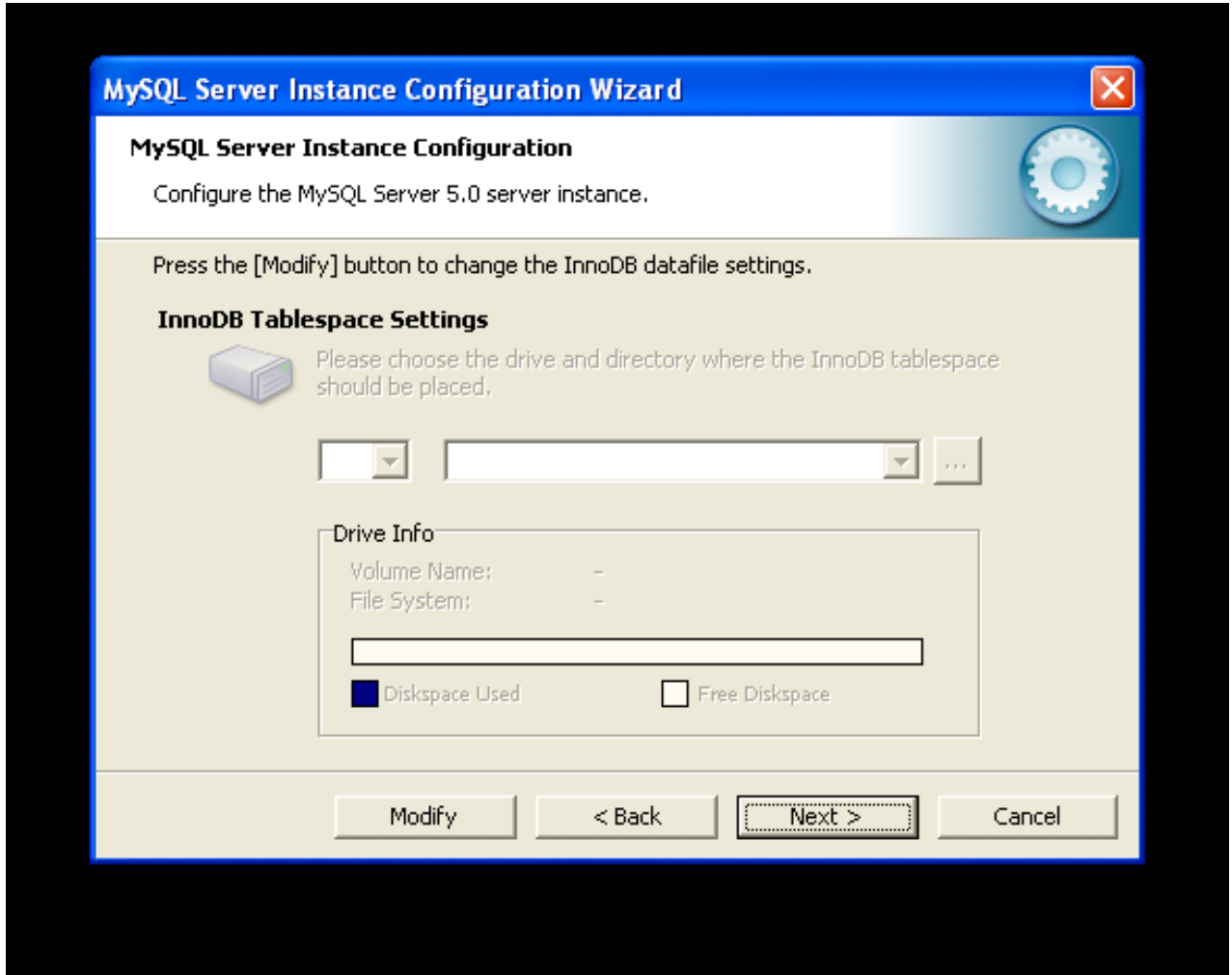
Transactional Database Only:
default-storage-engine=InnoDB
_myisam_pct=5

Non-Transactional Database Only:
default-storage-engine=MyISAM
_myisam_pct=100
skip-innodb
```

The `_myisam_pct` value is used to calculate the percentage of resources dedicated to `MyISAM`. The remaining resources are allocated to `InnoDB`.

### 2.3.4.6. The InnoDB Tablespace Dialog

Some users may want to locate the `InnoDB` tablespace files in a different location than the MySQL server data directory. Placing the tablespace files in a separate location can be desirable if your system has a higher capacity or higher performance storage device available, such as a RAID storage system.



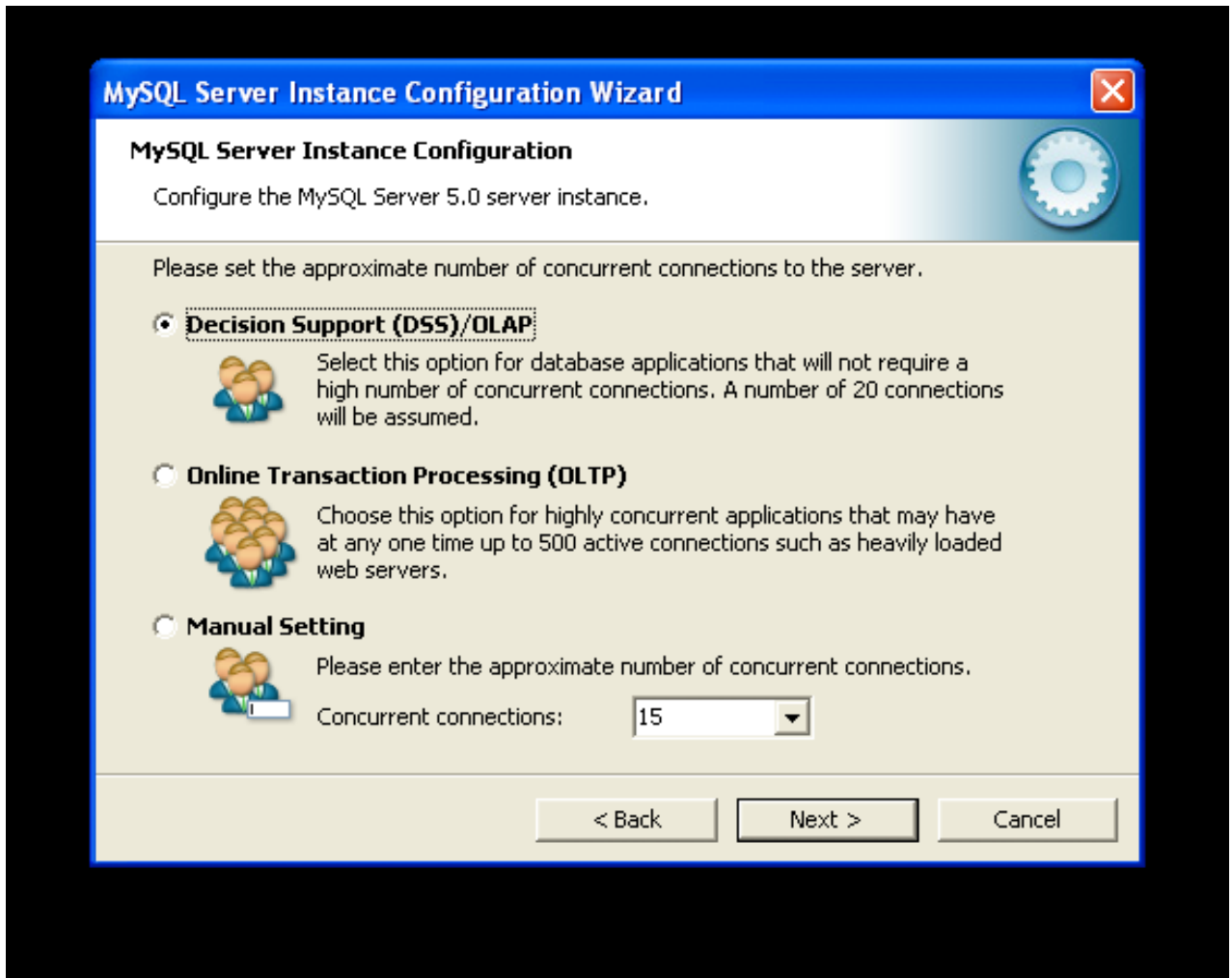
To change the default location for the `InnoDB` tablespace files, choose a new drive from the drop-down list of drive letters and choose a new path from the drop-down list of paths. To create a custom path, click the ... button.

If you are modifying the configuration of an existing server, you must click the `MODIFY` button before you change the path. In this situation you must move the existing tablespace files to the new location manually before starting the server.

### 2.3.4.7. The Concurrent Connections Dialog

To prevent the server from running out of resources, it is important to limit the number of concurrent connections to the MySQL server that can be established. The `CONCURRENT CONNECTIONS` dialog allows you to choose the expected usage of your server, and sets the limit for concurrent connections accordingly. It is also possible to set the concurrent connection limit manually.

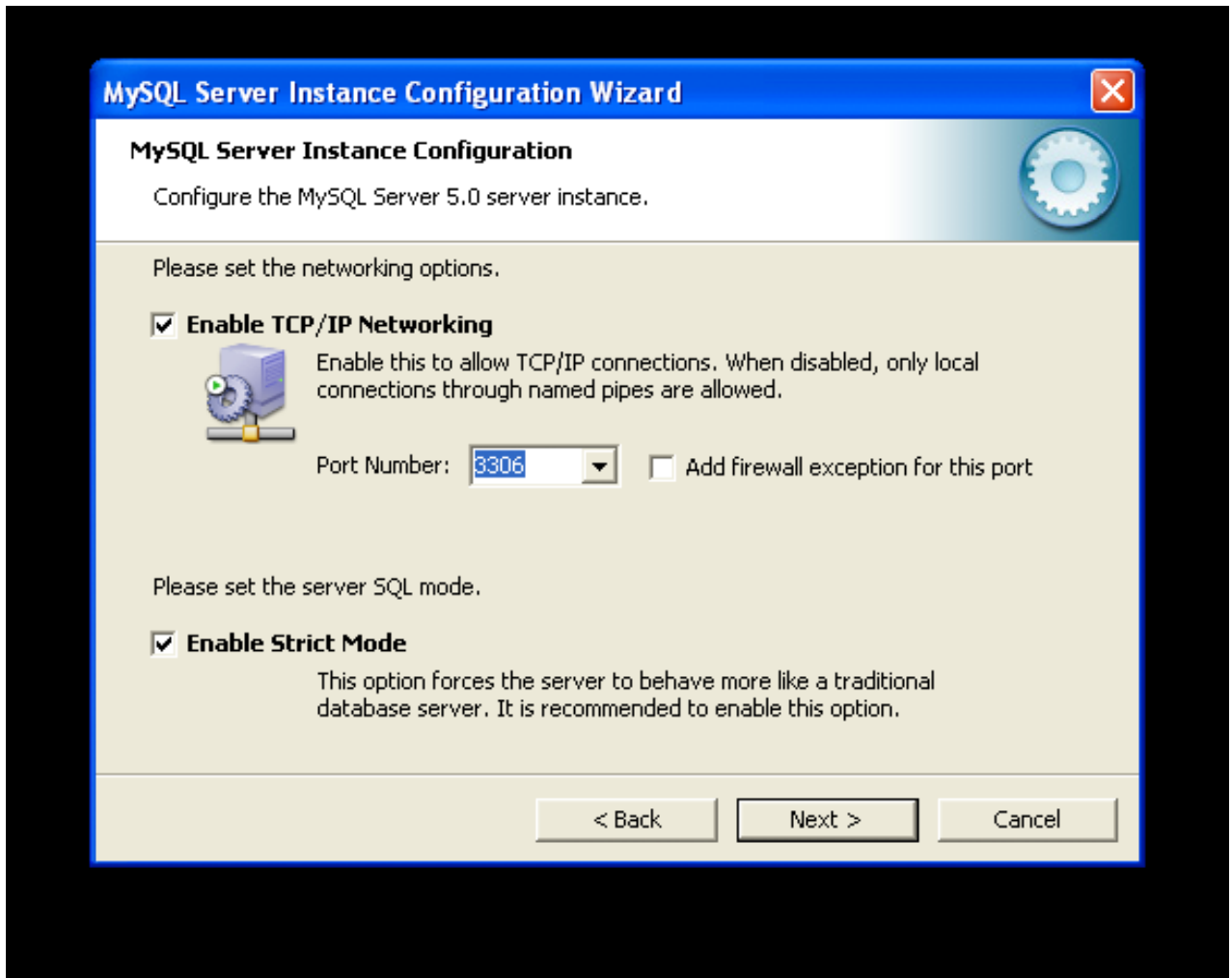




- **Decision Support (DSS)/OLAP:** Choose this option if your server does not require a large number of concurrent connections. The maximum number of connections is set at 100, with an average of 20 concurrent connections assumed.
- **Online Transaction Processing (OLTP):** Choose this option if your server requires a large number of concurrent connections. The maximum number of connections is set at 500.
- **Manual Setting:** Choose this option to set the maximum number of concurrent connections to the server manually. Choose the number of concurrent connections from the drop-down box provided, or enter the maximum number of connections into the drop-down box if the number you desire is not listed.

#### 2.3.4.8. The Networking and Strict Mode Options Dialog

Use the [NETWORKING OPTIONS](#) dialog to enable or disable TCP/IP networking and to configure the port number that is used to connect to the MySQL server.



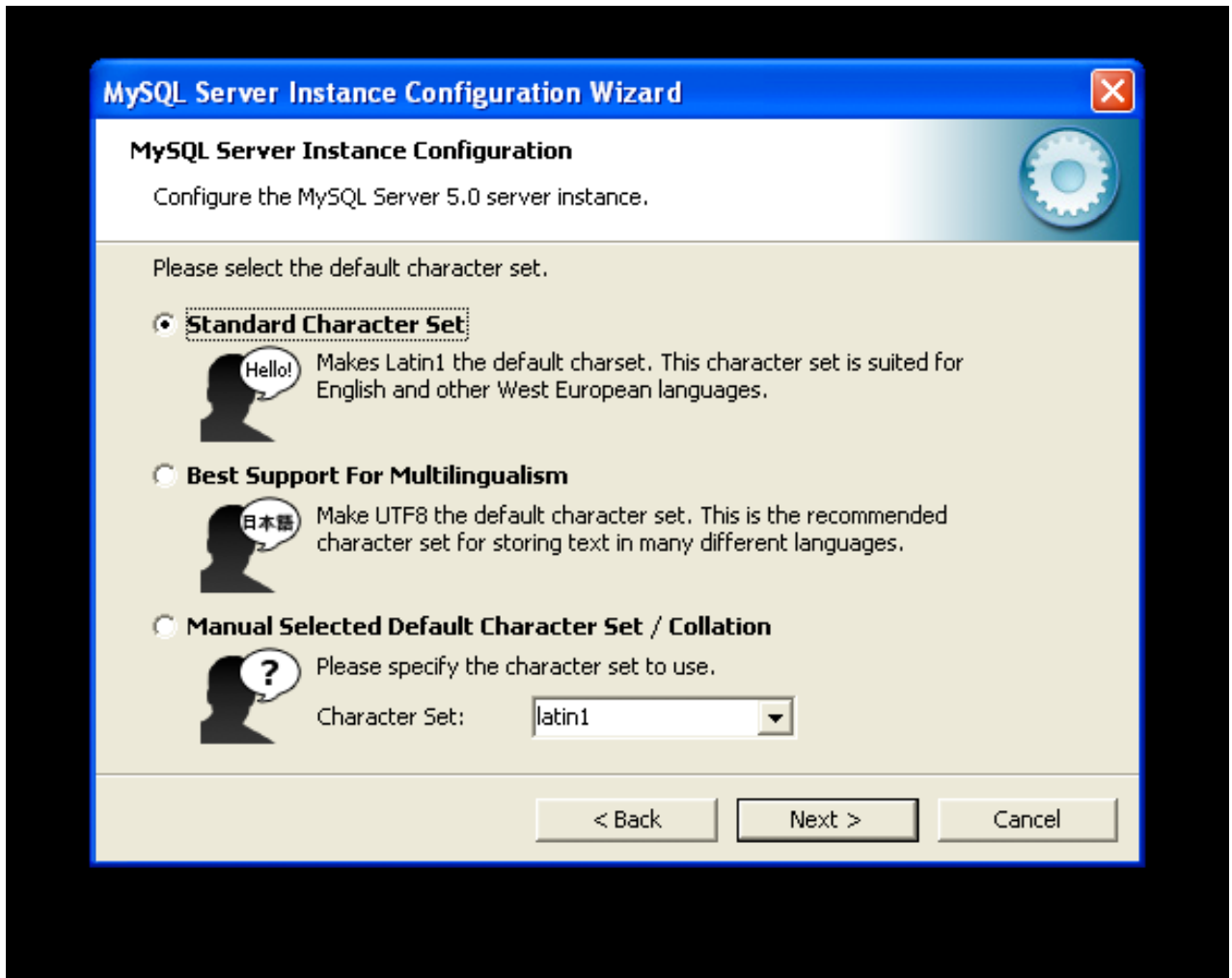
TCP/IP networking is enabled by default. To disable TCP/IP networking, uncheck the box next to the Enable TCP/IP Networking option.

Port 3306 is used by default. To change the port used to access MySQL, choose a new port number from the drop-down box or type a new port number directly into the drop-down box. If the port number you choose is in use, you are prompted to confirm your choice of port number.

Set the `SERVER SQL MODE` to either enable or disable strict mode. Enabling strict mode (default) makes MySQL behave more like other database management systems. *If you run applications that rely on MySQL's old "forgiving" behavior, make sure to either adapt those applications or to disable strict mode.* For more information about strict mode, see [Section 5.1.7, "Server SQL Modes"](#).

### 2.3.4.9. The Character Set Dialog

The MySQL server supports multiple character sets and it is possible to set a default server character set that is applied to all tables, columns, and databases unless overridden. Use the `CHARACTER SET` dialog to change the default character set of the MySQL server.



- **Standard Character Set:** Choose this option if you want to use `latin1` as the default server character set. `latin1` is used for English and many Western European languages.
- **Best Support For Multilingualism:** Choose this option if you want to use `utf8` as the default server character set. This is a Unicode character set that can store characters from many different languages.
- **Manual Selected Default Character Set / Collation:** Choose this option if you want to pick the server's default character set manually. Choose the desired character set from the provided drop-down list.

### 2.3.4.10. The Service Options Dialog

On Windows platforms, the MySQL server can be installed as a Windows service. When installed this way, the MySQL server can be started automatically during system startup, and even restarted automatically by Windows in the event of a service failure.

The MySQL Server Instance Configuration Wizard installs the MySQL server as a service by default, using the service name `MySQL`. If you do not wish to install the service, uncheck the box next to the Install As Windows Service option. You can change the service name by picking a new service name from the drop-down box provided or by entering a new service name into the drop-down box.

#### Note

Service names can include any legal character except forward (/) or backward (\) slashes, and must be less than 256 characters long.

#### Warning

If you are installing multiple versions of MySQL onto the same machine, you *must* choose a different service name for each version that you install. If you do not choose a different service for each installed version then the service manager information will be inconsistent and this will cause problems when you try to uninstall a previous version.

If you have already installed multiple versions using the same service name, you must manually edit the contents of the `HKEY_LOCAL_MACHINE\SYSTEM\CurrentControlSet\Services` parameters within the Windows registry to update the association of the service name with the correct server version.

Typically, when installing multiple versions you create a service name based on the version information. For example, you might install MySQL 5.x as `mysql5`, or specific versions such as MySQL 5.1.30 as `mysql50130`.

To install the MySQL server as a service but not have it started automatically at startup, uncheck the box next to the Launch the MySQL Server Automatically option.

### 2.3.4.11. The Security Options Dialog

It is strongly recommended that you set a `root` password for your MySQL server, and the MySQL Server Instance Configuration Wizard requires by default that you do so. If you do not wish to set a `root` password, uncheck the box next to the Modify Security Settings option.



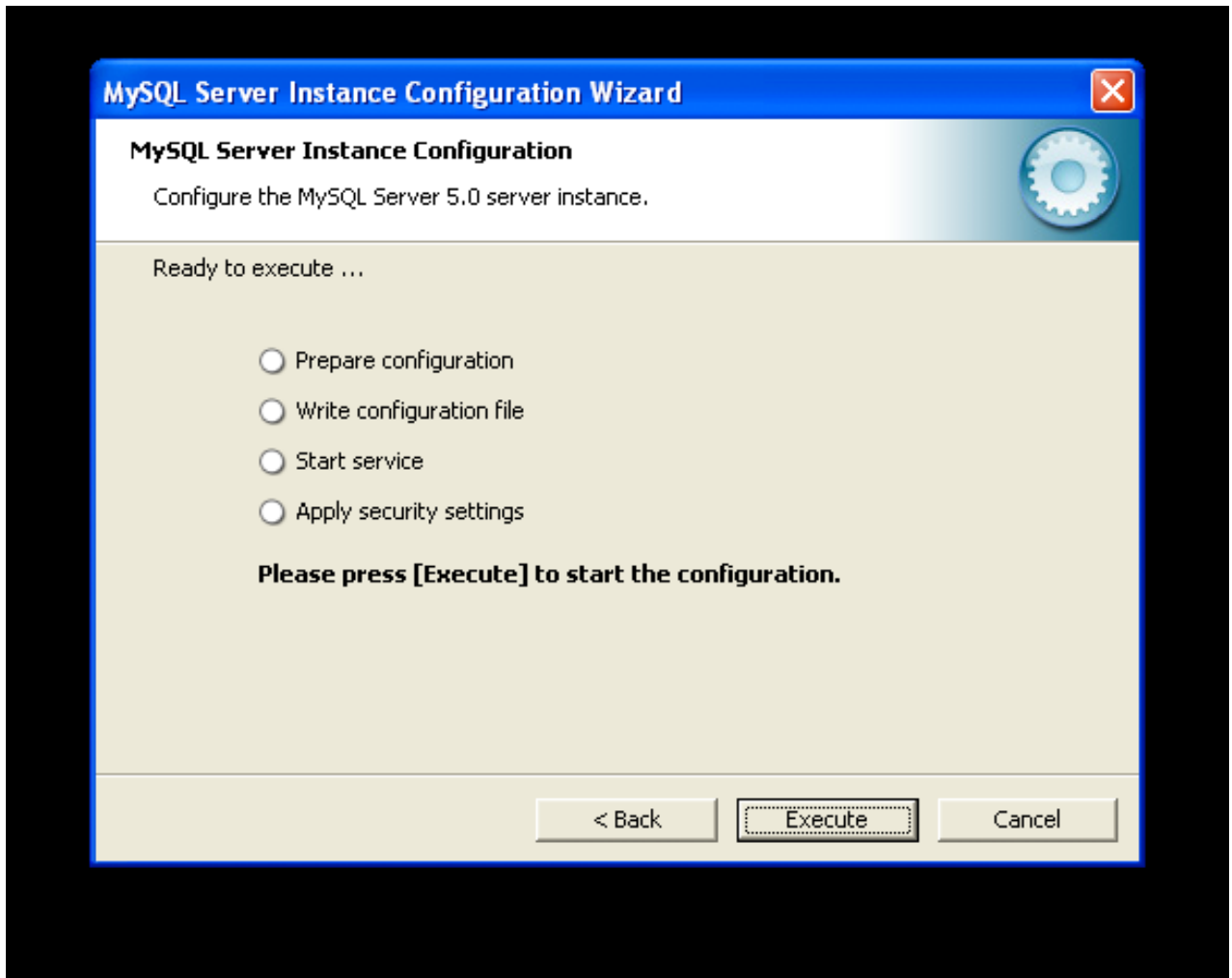
To set the `root` password, enter the desired password into both the New root password and Confirm boxes. If you are reconfiguring an existing server, you need to enter the existing `root` password into the Current root password box.

To prevent `root` logins from across the network, check the box next to the Root may only connect from localhost option. This increases the security of your `root` account.

To create an anonymous user account, check the box next to the Create An Anonymous Account option. Creating an anonymous account can decrease server security and cause login and permission difficulties. For this reason, it is not recommended.

### 2.3.4.12. The Confirmation Dialog

The final dialog in the MySQL Server Instance Configuration Wizard is the `CONFIRMATION DIALOG`. To start the configuration process, click the EXECUTE button. To return to a previous dialog, click the BACK button. To exit the MySQL Server Instance Configuration Wizard without configuring the server, click the CANCEL button.



After you click the EXECUTE button, the MySQL Server Instance Configuration Wizard performs a series of tasks and displays the progress onscreen as the tasks are performed.

The MySQL Server Instance Configuration Wizard first determines configuration file options based on your choices using a template prepared by MySQL developers and engineers. This template is named `my-template.ini` and is located in your server installation directory.

The MySQL Configuration Wizard then writes these options to the corresponding configuration file.

If you chose to create a service for the MySQL server, the MySQL Server Instance Configuration Wizard creates and starts the service. If you are reconfiguring an existing service, the MySQL Server Instance Configuration Wizard restarts the service to apply your configuration changes.

If you chose to set a `root` password, the MySQL Configuration Wizard connects to the server, sets your new `root` password, and applies any other security settings you may have selected.

After the MySQL Server Instance Configuration Wizard has completed its tasks, it displays a summary. Click the FINISH button to exit the MySQL Server Configuration Wizard.

### 2.3.5. Installing MySQL from a Noinstall Zip Archive

Users who are installing from the Noinstall package can use the instructions in this section to manually install MySQL. The process for installing MySQL from a Zip archive is as follows:

1. Extract the archive to the desired install directory
2. Create an option file
3. Choose a MySQL server type

4. Start the MySQL server
5. Secure the default user accounts

This process is described in the sections that follow.

### 2.3.6. Extracting the Install Archive

To install MySQL manually, do the following:

1. If you are upgrading from a previous version please refer to [Section 2.3.14, “Upgrading MySQL on Windows”](#), before beginning the upgrade process.
2. Make sure that you are logged in as a user with administrator privileges.
3. Choose an installation location. Traditionally, the MySQL server is installed in `C:\mysql`. The MySQL Installation Wizard installs MySQL under `C:\Program Files\MySQL`. If you do not install MySQL at `C:\mysql`, you must specify the path to the install directory during startup or in an option file. See [Section 2.3.7, “Creating an Option File”](#).
4. Extract the install archive to the chosen installation location using your preferred Zip archive tool. Some tools may extract the archive to a folder within your chosen installation location. If this occurs, you can move the contents of the subfolder into the chosen installation location.

### 2.3.7. Creating an Option File

If you need to specify startup options when you run the server, you can indicate them on the command line or place them in an option file. For options that are used every time the server starts, you may find it most convenient to use an option file to specify your MySQL configuration. This is particularly true under the following circumstances:

- The installation or data directory locations are different from the default locations (`C:\Program Files\MySQL\MySQL Server 5.1` and `C:\Program Files\MySQL\MySQL Server 5.1\data`).
- You need to tune the server settings, such as memory, cache, or InnoDB configuration information.

When the MySQL server starts on Windows, it looks for options in two files: the `my.ini` file in the Windows directory, and the `C:\my.cnf` file. The Windows directory typically is named something like `C:\WINDOWS`. You can determine its exact location from the value of the `WINDIR` environment variable using the following command:

```
C:\> echo %WINDIR%
```

MySQL looks for options first in the `my.ini` file, and then in the `my.cnf` file. However, to avoid confusion, it is best if you use only one file. If your PC uses a boot loader where `C:` is not the boot drive, your only option is to use the `my.ini` file. Whichever option file you use, it must be a plain text file.

You can also make use of the example option files included with your MySQL distribution; see [Section 4.2.3.2.2, “Preconfigured Option Files”](#).

An option file can be created and modified with any text editor, such as Notepad. For example, if MySQL is installed in `E:\mysql` and the data directory is in `E:\mydata\data`, you can create an option file containing a `[mysqld]` section to specify values for the `basedir` and `datadir` options:

```
[mysqld]
# set basedir to your installation path
basedir=E:/mysql
# set datadir to the location of your data directory
datadir=E:/mydata/data
```

Note that Windows path names are specified in option files using (forward) slashes rather than backslashes. If you do use backslashes, you must double them:

```
[mysqld]
# set basedir to your installation path
basedir=E:\\mysql
# set datadir to the location of your data directory
datadir=E:\\mydata\\data
```

**MySQL Enterprise**

For expert advice on the start-up options appropriate to your circumstances, subscribe to the MySQL Enterprise Monitor. For more information, see <http://www.mysql.com/products/enterprise/advisors.html>.

In MySQL 5.1.23 and earlier, the MySQL installer places the data directory directly under the directory where you install MySQL. On MySQL 5.1.24 and later, the data directory is located within the `AppData` directory for the user running MySQL.

If you would like to use a data directory in a different location, you should copy the entire contents of the `data` directory to the new location. For example, if you want to use `E:\mydata` as the data directory instead, you must do two things:

1. Move the entire `data` directory and all of its contents from the default location (for example `C:\Program Files\MySQL\MySQL Server 5.1\data`) to `E:\mydata`.
2. Use a `--datadir` option to specify the new data directory location each time you start the server.

## 2.3.8. Selecting a MySQL Server Type

The following table shows the available servers for Windows in MySQL 5.1.20 and earlier.

Binary	Description
<code>mysqld-nt</code>	Optimized binary with named-pipe support
<code>mysqld</code>	Optimized binary without named-pipe support
<code>mysqld-debug</code>	Like <code>mysqld-nt</code> , but compiled with full debugging and automatic memory allocation checking

The following table shows the available servers for Windows in MySQL 5.1.21 and later.

Binary	Description
<code>mysqld</code>	Optimized binary with named-pipe support
<code>mysqld-debug</code>	Like <code>mysqld</code> , but compiled with full debugging and automatic memory allocation checking

All of the preceding binaries are optimized for modern Intel processors, but should work on any Intel i386-class or higher processor.

Each of the servers in a distribution support the same set of storage engines. The `SHOW ENGINES` statement displays which engines a given server supports.

All Windows MySQL 5.1 servers have support for symbolic linking of database directories.

MySQL supports TCP/IP on all Windows platforms. MySQL servers on Windows support named pipes as indicated in the following list. However, the default is to use TCP/IP regardless of platform. (Named pipes are slower than TCP/IP in many Windows configurations.)

Use of named pipes is subject to these conditions:

- Named pipes are enabled only if you start the server with the `--enable-named-pipe` option. It is necessary to use this option explicitly because some users have experienced problems with shutting down the MySQL server when named pipes were used.
- For MySQL 5.1.20 and earlier, named-pipe connections are allowed only by the `mysqld-nt` and `mysqld-debug` servers. For MySQL 5.1.21 and later, the `mysqld` and `mysqld-debug` servers both contain support for named-pipe connections.

**Note**

Most of the examples in this manual use `mysqld` as the server name. If you choose to use a different server, such as `mysqld-nt` or `mysqld-debug`, make the appropriate substitutions in the commands that are shown in the examples.

## 2.3.9. Starting the Server for the First Time

This section gives a general overview of starting the MySQL server. The following sections provide more specific information for starting the MySQL server from the command line or as a Windows service.



The information here applies primarily if you installed MySQL using the `Noinstall` version, or if you wish to configure and test MySQL manually rather than with the GUI tools.

The examples in these sections assume that MySQL is installed under the default location of `C:\Program Files\MySQL\MySQL Server 5.1`. Adjust the path names shown in the examples if you have MySQL installed in a different location.

Clients have two options. They can use TCP/IP, or they can use a named pipe if the server supports named-pipe connections.

MySQL for Windows also supports shared-memory connections if the server is started with the `--shared-memory` option. Clients can connect through shared memory by using the `--protocol=MEMORY` option.

For information about which server binary to run, see [Section 2.3.8, “Selecting a MySQL Server Type”](#).

Testing is best done from a command prompt in a console window (or “DOS window”). In this way you can have the server display status messages in the window where they are easy to see. If something is wrong with your configuration, these messages make it easier for you to identify and fix any problems.

To start the server, enter this command:

```
C:\> "C:\Program Files\MySQL\MySQL Server 5.1\bin\mysqld" --console
```

For a server that includes `InnoDB` support, you should see the messages similar to those following as it starts (the path names and sizes may differ):

```
InnoDB: The first specified datafile c:\ibdata\ibdata1 did not exist:
InnoDB: a new database to be created!
InnoDB: Setting file c:\ibdata\ibdata1 size to 209715200
InnoDB: Database physically writes the file full: wait...
InnoDB: Log file c:\iblogs\ib_logfile0 did not exist: new to be created
InnoDB: Setting log file c:\iblogs\ib_logfile0 size to 31457280
InnoDB: Log file c:\iblogs\ib_logfile1 did not exist: new to be created
InnoDB: Setting log file c:\iblogs\ib_logfile1 size to 31457280
InnoDB: Log file c:\iblogs\ib_logfile2 did not exist: new to be created
InnoDB: Setting log file c:\iblogs\ib_logfile2 size to 31457280
InnoDB: Doublewrite buffer not found: creating new
InnoDB: Doublewrite buffer created
InnoDB: creating foreign key constraint system tables
InnoDB: foreign key constraint system tables created
011024 10:58:25 InnoDB: Started
```

When the server finishes its startup sequence, you should see something like this, which indicates that the server is ready to service client connections:

```
mysqld: ready for connections
Version: '5.1.36' socket: '' port: 3306
```

The server continues to write to the console any further diagnostic output it produces. You can open a new console window in which to run client programs.

If you omit the `--console` option, the server writes diagnostic output to the error log in the data directory (`C:\Program Files\MySQL\MySQL Server 5.1\data` by default). The error log is the file with the `.err` extension.

### Note

The accounts that are listed in the MySQL grant tables initially have no passwords. After starting the server, you should set up passwords for them using the instructions in [Section 2.11, “Post-Installation Setup and Testing”](#).

## 2.3.10. Starting MySQL from the Windows Command Line

The MySQL server can be started manually from the command line. This can be done on any version of Windows.

To start the `mysqld` server from the command line, you should start a console window (or “DOS window”) and enter this command:

```
C:\> "C:\Program Files\MySQL\MySQL Server 5.1\bin\mysqld"
```

The path to `mysqld` may vary depending on the install location of MySQL on your system.

You can stop the MySQL server by executing this command:

```
C:\> "C:\Program Files\MySQL\MySQL Server 5.1\bin\mysqladmin" -u root shutdown
```

**Note**

If the MySQL `root` user account has a password, you need to invoke `mysqladmin` with the `-p` option and supply the password when prompted.

This command invokes the MySQL administrative utility `mysqladmin` to connect to the server and tell it to shut down. The command connects as the MySQL `root` user, which is the default administrative account in the MySQL grant system. Note that users in the MySQL grant system are wholly independent from any login users under Windows.

If `mysqld` doesn't start, check the error log to see whether the server wrote any messages there to indicate the cause of the problem. The error log is located in the `C:\Program Files\MySQL\MySQL Server 5.1\data` directory. It is the file with a suffix of `.err`. You can also try to start the server as `mysqld --console`; in this case, you may get some useful information on the screen that may help solve the problem.

The last option is to start `mysqld` with the `--standalone` and `--debug` options. In this case, `mysqld` writes a log file `C:\mysqld.trace` that should contain the reason why `mysqld` doesn't start. See [MySQL Internals: Porting](#).

Use `mysqld --verbose --help` to display all the options that `mysqld` supports.

## 2.3.11. Starting MySQL as a Windows Service

On Windows, the recommended way to run MySQL is to install it as a Windows service, whereby MySQL starts and stops automatically when Windows starts and stops. A MySQL server installed as a service can also be controlled from the command line using [NET](#) commands, or with the graphical [Services](#) utility. Generally, to install MySQL as a Windows service you should be logged in using an account that has administrator rights.

The [Services](#) utility (the Windows [Service Control Manager](#)) can be found in the Windows Control Panel (under Administrative Tools on Windows 2000, XP, Vista and Server 2003). To avoid conflicts, it is advisable to close the [Services](#) utility while performing server installation or removal operations from the command line.

Before installing MySQL as a Windows service, you should first stop the current server if it is running by using the following command:

```
C:\> "C:\Program Files\MySQL\MySQL Server 5.1\bin\mysqladmin"
      -u root shutdown
```

**Note**

If the MySQL `root` user account has a password, you need to invoke `mysqladmin` with the `-p` option and supply the password when prompted.

This command invokes the MySQL administrative utility `mysqladmin` to connect to the server and tell it to shut down. The command connects as the MySQL `root` user, which is the default administrative account in the MySQL grant system. Note that users in the MySQL grant system are wholly independent from any login users under Windows.

Install the server as a service using this command:

```
C:\> "C:\Program Files\MySQL\MySQL Server 5.1\bin\mysqld" --install
```

The service-installation command does not start the server. Instructions for that are given later in this section.

To make it easier to invoke MySQL programs, you can add the path name of the MySQL `bin` directory to your Windows system [PATH](#) environment variable:

- On the Windows desktop, right-click on the My Computer icon, and select Properties.
- Next select the Advanced tab from the [SYSTEM PROPERTIES](#) menu that appears, and click the ENVIRONMENT VARIABLES button.
- Under **SYSTEM VARIABLES**, select Path, and then click the EDIT button. The [EDIT SYSTEM VARIABLE](#) dialogue should appear.
- Place your cursor at the end of the text appearing in the space marked **VARIABLE VALUE**. (Use the **End** key to ensure that your cursor is positioned at the very end of the text in this space.) Then enter the complete path name of your MySQL `bin` directory (for example, `C:\Program Files\MySQL\MySQL Server 5.1\bin`), Note that there should be a semicolon separating this path from any values present in this field. Dismiss this dialogue, and each dialogue in turn, by clicking OK until all of the dialogues that were opened have been dismissed. You should now be able to invoke any MySQL executable program by typing its name at the DOS prompt from any directory on the system, without having to supply the path. This includes the servers, the `mysql` client, and all MySQL command-line utilities such as `mysqladmin` and `mysqldump`.

You should not add the MySQL `bin` directory to your Windows [PATH](#) if you are running multiple MySQL servers on the same

machine.

### Warning

You must exercise great care when editing your system `PATH` by hand; accidental deletion or modification of any portion of the existing `PATH` value can leave you with a malfunctioning or even unusable system.

The following additional arguments can be used in MySQL 5.1 when installing the service:

- You can specify a service name immediately following the `--install` option. The default service name is `MySQL`.
- If a service name is given, it can be followed by a single option. By convention, this should be `--defaults-file=file_name` to specify the name of an option file from which the server should read options when it starts.

The use of a single option other than `--defaults-file` is possible but discouraged. `--defaults-file` is more flexible because it enables you to specify multiple startup options for the server by placing them in the named option file.

- You can also specify a `--local-service` option following the service name. This causes the server to run using the `LocalService` Windows account that has limited system privileges. This account is available only for Windows XP or newer. If both `--defaults-file` and `--local-service` are given following the service name, they can be in any order.

For a MySQL server that is installed as a Windows service, the following rules determine the service name and option files that the server uses:

- If the service-installation command specifies no service name or the default service name (`MySQL`) following the `--install` option, the server uses the a service name of `MySQL` and reads options from the `[mysqld]` group in the standard option files.
- If the service-installation command specifies a service name other than `MySQL` following the `--install` option, the server uses that service name. It reads options from the `[mysqld]` group and the group that has the same name as the service in the standard option files. This allows you to use the `[mysqld]` group for options that should be used by all MySQL services, and an option group with the service name for use by the server installed with that service name.
- If the service-installation command specifies a `--defaults-file` option after the service name, the server reads options only from the `[mysqld]` group of the named file and ignores the standard option files.

As a more complex example, consider the following command:

```
C:\> "C:\Program Files\MySQL\MySQL Server 5.1\bin\mysqld"
      --install MySQL --defaults-file=C:\my-opts.cnf
```

Here, the default service name (`MySQL`) is given after the `--install` option. If no `--defaults-file` option had been given, this command would have the effect of causing the server to read the `[mysqld]` group from the standard option files. However, because the `--defaults-file` option is present, the server reads options from the `[mysqld]` option group, and only from the named file.

You can also specify options as Start parameters in the Windows `Services` utility before you start the MySQL service.

Once a MySQL server has been installed as a service, Windows starts the service automatically whenever Windows starts. The service also can be started immediately from the `Services` utility, or by using a `NET START MySQL` command. The `NET` command is not case sensitive.

When run as a service, `mysqld` has no access to a console window, so no messages can be seen there. If `mysqld` does not start, check the error log to see whether the server wrote any messages there to indicate the cause of the problem. The error log is located in the MySQL data directory (for example, `C:\Program Files\MySQL\MySQL Server 5.1\data`). It is the file with a suffix of `.err`.

When a MySQL server has been installed as a service, and the service is running, Windows stops the service automatically when Windows shuts down. The server also can be stopped manually by using the `Services` utility, the `NET STOP MySQL` command, or the `mysqldadmin shutdown` command.

You also have the choice of installing the server as a manual service if you do not wish for the service to be started automatically during the boot process. To do this, use the `--install-manual` option rather than the `--install` option:

```
C:\> "C:\Program Files\MySQL\MySQL Server 5.1\bin\mysqld" --install-manual
```

To remove a server that is installed as a service, first stop it if it is running by executing `NET STOP MySQL`. Then use the `-remove` option to remove it:

```
C:\> "C:\Program Files\MySQL\MySQL Server 5.1\bin\mysqld" --remove
```

If `mysqld` is not running as a service, you can start it from the command line. For instructions, see [Section 2.3.10, “Starting MySQL from the Windows Command Line”](#).

Please see [Section 2.3.13, “Troubleshooting a MySQL Installation Under Windows”](#), if you encounter difficulties during installation.

## 2.3.12. Testing The MySQL Installation

You can test whether the MySQL server is working by executing any of the following commands:

```
C:\> "C:\Program Files\MySQL\MySQL Server 5.1\bin\mysqlshow"
C:\> "C:\Program Files\MySQL\MySQL Server 5.1\bin\mysqlshow" -u root mysql
C:\> "C:\Program Files\MySQL\MySQL Server 5.1\bin\mysqladmin" version status proc
C:\> "C:\Program Files\MySQL\MySQL Server 5.1\bin\mysql" test
```

If `mysqld` is slow to respond to TCP/IP connections from client programs, there is probably a problem with your DNS. In this case, start `mysqld` with the `--skip-name-resolve` option and use only `localhost` and IP numbers in the `Host` column of the MySQL grant tables.

You can force a MySQL client to use a named-pipe connection rather than TCP/IP by specifying the `--pipe` or `--protocol=PIPE` option, or by specifying `.` (period) as the host name. Use the `--socket` option to specify the name of the pipe if you do not want to use the default pipe name.

Note that if you have set a password for the `root` account, deleted the anonymous account, or created a new user account, then you must use the appropriate `-u` and `-p` options with the commands shown above in order to connect with the MySQL Server. See [Section 4.2.2, “Connecting to the MySQL Server”](#).

For more information about `mysqlshow`, see [Section 4.5.6, “mysqlshow — Display Database, Table, and Column Information”](#).

## 2.3.13. Troubleshooting a MySQL Installation Under Windows

When installing and running MySQL for the first time, you may encounter certain errors that prevent the MySQL server from starting. The purpose of this section is to help you diagnose and correct some of these errors.

Your first resource when troubleshooting server issues is the error log. The MySQL server uses the error log to record information relevant to the error that prevents the server from starting. The error log is located in the data directory specified in your `my.ini` file. The default data directory location is `C:\Program Files\MySQL\MySQL Server 5.1\data`. See [Section 5.2.2, “The Error Log”](#).

Another source of information regarding possible errors is the console messages displayed when the MySQL service is starting. Use the `NET START MySQL` command from the command line after installing `mysqld` as a service to see any error messages regarding the starting of the MySQL server as a service. See [Section 2.3.11, “Starting MySQL as a Windows Service”](#).

The following examples show other common error messages you may encounter when installing MySQL and starting the server for the first time:

- If the MySQL server cannot find the `mysql` privileges database or other critical files, you may see these messages:

```
System error 1067 has occurred.
Fatal error: Can't open privilege tables: Table 'mysql.host' doesn't exist
```

These messages often occur when the MySQL base or data directories are installed in different locations than the default locations (`C:\Program Files\MySQL\MySQL Server 5.1` and `C:\Program Files\MySQL\MySQL Server 5.1\data`, respectively).

This situation may occur when MySQL is upgraded and installed to a new location, but the configuration file is not updated to reflect the new location. In addition, there may be old and new configuration files that conflict. Be sure to delete or rename any old configuration files when upgrading MySQL.

If you have installed MySQL to a directory other than `C:\Program Files\MySQL\MySQL Server 5.1`, you need to ensure that the MySQL server is aware of this through the use of a configuration (`my.ini`) file. The `my.ini` file needs to be located in your Windows directory, typically `C:\WINDOWS`. You can determine its exact location from the value of the

WINDIR environment variable by issuing the following command from the command prompt:

```
C:\> echo %WINDIR%
```

An option file can be created and modified with any text editor, such as Notepad. For example, if MySQL is installed in `E:\mysql` and the data directory is `D:\MySQLdata`, you can create the option file and set up a `[mysqld]` section to specify values for the `basedir` and `datadir` options:

```
[mysqld]
# set basedir to your installation path
basedir=E:/mysql
# set datadir to the location of your data directory
datadir=D:/MySQLdata
```

Note that Windows path names are specified in option files using (forward) slashes rather than backslashes. If you do use backslashes, you must double them:

```
[mysqld]
# set basedir to your installation path
basedir=C:\\Program Files\\MySQL\\MySQL Server 5.1
# set datadir to the location of your data directory
datadir=D:\\MySQLdata
```

If you change the `datadir` value in your MySQL configuration file, you must move the contents of the existing MySQL data directory before restarting the MySQL server.

See [Section 2.3.7, “Creating an Option File”](#).

- If you reinstall or upgrade MySQL without first stopping and removing the existing MySQL service and install MySQL using the MySQL Configuration Wizard, you may see this error:

```
Error: Cannot create Windows service for MySql. Error: 0
```

This occurs when the Configuration Wizard tries to install the service and finds an existing service with the same name.

One solution to this problem is to choose a service name other than `mysql` when using the configuration wizard. This allows the new service to be installed correctly, but leaves the outdated service in place. Although this is harmless, it is best to remove old services that are no longer in use.

To permanently remove the old `mysql` service, execute the following command as a user with administrative privileges, on the command-line:

```
C:\> sc delete mysql
[SC] DeleteService SUCCESS
```

If the `sc` utility is not available for your version of Windows, download the `delsrv` utility from <http://www.microsoft.com/windows2000/techinfo/reskit/tools/existing/delsrv-o.asp> and use the `delsrv mysql` syntax.

## 2.3.14. Upgrading MySQL on Windows

This section lists some of the steps you should take when upgrading MySQL on Windows.

1. Review [Section 2.12.1, “Upgrading MySQL”](#), for additional information on upgrading MySQL that is not specific to Windows.
2. You should always back up your current MySQL installation before performing an upgrade. See [Section 6.1, “Database Backups”](#).
3. Download the latest Windows distribution of MySQL from <http://dev.mysql.com/downloads/>.
4. Before upgrading MySQL, you must stop the server. If the server is installed as a service, stop the service with the following command from the command prompt:

```
C:\> NET STOP MySQL
```

If you are not running the MySQL server as a service, use the following command to stop it:

```
C:\> "C:\Program Files\MySQL\MySQL Server 5.1\bin\mysqladmin" -u root shutdown
```

**Note**

If the MySQL `root` user account has a password, you need to invoke `mysqladmin` with the `-p` option and supply the password when prompted.

- When upgrading to MySQL 5.1 from a version previous to 4.1.5, or when upgrading from a version of MySQL installed from a Zip archive to a version of MySQL installed with the MySQL Installation Wizard, you must manually remove the previous installation and MySQL service (if the server is installed as a service).

To remove the MySQL service, use the following command:

```
C:\> C:\mysql\bin\mysqld --remove
```

**If you do not remove the existing service, the MySQL Installation Wizard may fail to properly install the new MySQL service.**

- When upgrading from MySQL 5.1.23 to MySQL 5.1.24, the change in the default location of the data directory from a directory within the MySQL installation to the `AppData` folder means that you must manually copy the data files from your old installation to the new location.
- If you are using the MySQL Installation Wizard, start the wizard as described in Section 2.3.3, “Using the MySQL Installation Wizard”.
- If you are installing MySQL from a Zip archive, extract the archive. You may either overwrite your existing MySQL installation (usually located at `C:\mysql`), or install it into a different directory, such as `C:\mysql5`. Overwriting the existing installation is recommended.
- If you were running MySQL as a Windows service and you had to remove the service earlier in this procedure, reinstall the service. (See Section 2.3.11, “Starting MySQL as a Windows Service”.)
- Restart the server. For example, use `NET START MySQL` if you run MySQL as a service, or invoke `mysqld` directly otherwise.
- If you encounter errors, see Section 2.3.13, “Troubleshooting a MySQL Installation Under Windows”.

## 2.3.15. MySQL on Windows Compared to MySQL on Unix

MySQL for Windows has proven itself to be very stable. The Windows version of MySQL has the same features as the corresponding Unix version, with the following exceptions:

- **Limited number of ports**

Windows systems have about 4,000 ports available for client connections, and after a connection on a port closes, it takes two to four minutes before the port can be reused. In situations where clients connect to and disconnect from the server at a high rate, it is possible for all available ports to be used up before closed ports become available again. If this happens, the MySQL server appears to be unresponsive even though it is running. Note that ports may be used by other applications running on the machine as well, in which case the number of ports available to MySQL is lower.

For more information about this problem, see <http://support.microsoft.com/default.aspx?scid=kb;en-us;196271>.

- **Concurrent reads**

MySQL depends on the `pread()` and `pwrite()` system calls to be able to mix `INSERT` and `SELECT`. Currently, we use mutexes to emulate `pread()` and `pwrite()`. We intend to replace the file level interface with a virtual interface in the future so that we can use the `readfile()/writefile()` interface to get more speed. The current implementation limits the number of open files that MySQL 5.1 can use to 2,048, which means that you cannot run as many concurrent threads on Windows as on Unix.

- **Blocking read**

MySQL uses a blocking read for each connection. That has the following implications if named-pipe connections are enabled:

- A connection is not disconnected automatically after eight hours, as happens with the Unix version of MySQL.
- If a connection hangs, it is not possible to break it without killing MySQL.
- `mysqladmin kill` does not work on a sleeping connection.

- `mysqladmin shutdown` cannot abort as long as there are sleeping connections.

We plan to fix this problem in the future.

- **ALTER TABLE**

While you are executing an `ALTER TABLE` statement, the table is locked from being used by other threads. This has to do with the fact that on Windows, you can't delete a file that is in use by another thread. In the future, we may find some way to work around this problem.

- **DROP TABLE**

`DROP TABLE` on a table that is in use by a `MERGE` table does not work on Windows because the `MERGE` handler does the table mapping hidden from the upper layer of MySQL. Because Windows does not allow dropping files that are open, you first must flush all `MERGE` tables (with `FLUSH TABLES`) or drop the `MERGE` table before dropping the table.

- **DATA DIRECTORY and INDEX DIRECTORY**

The `DATA DIRECTORY` and `INDEX DIRECTORY` options for `CREATE TABLE` are ignored on Windows, because Windows doesn't support symbolic links. These options also are ignored on systems that have a non-functional `realpath()` call.

- **DROP DATABASE**

You cannot drop a database that is in use by some thread.

- **Case-insensitive names**

File names are not case sensitive on Windows, so MySQL database and table names are also not case sensitive on Windows. The only restriction is that database and table names must be specified using the same case throughout a given statement. See [Section 8.2.2, "Identifier Case Sensitivity"](#).

- **Directory and file names**

On Windows, MySQL Server supports only directory and file names that are compatible with the current ANSI code pages. For example, the following Japanese directory name will not work in the Western locale (code page 1252):

```
datadir="C:/维基百科关于中文维基百科"
```

The same limitation applies to directory and file names referred to in SQL statements, such as the data file path name in `LOAD DATA INFILE`.

- **The “\” path name separator character**

Path name components in Windows are separated by the “\” character, which is also the escape character in MySQL. If you are using `LOAD DATA INFILE` or `SELECT ... INTO OUTFILE`, use Unix-style file names with “/” characters:

```
mysql> LOAD DATA INFILE 'C:/tmp/skr.txt' INTO TABLE skr;
mysql> SELECT * INTO OUTFILE 'C:/tmp/skr.txt' FROM skr;
```

Alternatively, you must double the “\” character:

```
mysql> LOAD DATA INFILE 'C:\\tmp\\skr.txt' INTO TABLE skr;
mysql> SELECT * INTO OUTFILE 'C:\\tmp\\skr.txt' FROM skr;
```

- **Problems with pipes**

Pipes do not work reliably from the Windows command-line prompt. If the pipe includes the character `^Z / CHAR(24)`, Windows thinks that it has encountered end-of-file and aborts the program.

This is mainly a problem when you try to apply a binary log as follows:

```
C:\> mysqlbinlog binary_log_file | mysql --user=root
```

If you have a problem applying the log and suspect that it is because of a `^Z / CHAR(24)` character, you can use the following workaround:

```
C:\> mysqlbinlog binary_log_file --result-file=/tmp/bin.sql
C:\> mysql --user=root --execute "source /tmp/bin.sql"
```



The latter command also can be used to reliably read in any SQL file that may contain binary data.

- **Access denied for user error**

If MySQL cannot resolve your host name properly, you may get the following error when you attempt to run a MySQL client program to connect to a server running on the same machine:

```
Access denied for user 'some_user'@'unknown'
to database 'mysql'
```

To fix this problem, you should create a file named `\windows\hosts` containing the following information:

```
127.0.0.1    localhost
```

Here are some open issues for anyone who might want to help us improve MySQL on Windows:

- Add macros to use the faster thread-safe increment/decrement methods provided by Windows.

## 2.4. Installing MySQL from RPM Packages on Linux

The recommended way to install MySQL on RPM-based Linux distributions is by using the RPM packages. The RPMs that we provide to the community should work on all versions of Linux that support RPM packages and use `glibc 2.3`. To obtain RPM packages, see [Section 2.1.3, “How to Get MySQL”](#).

For non-RPM Linux distributions, you can install MySQL using a `.tar.gz` package. See [Section 2.9, “Installing MySQL from tar.gz Packages on Other Unix-Like Systems”](#).

We do provide some platform-specific RPMs; the difference between a platform-specific RPM and a generic RPM is that a platform-specific RPM is built on the targeted platform and is linked dynamically whereas a generic RPM is linked statically with `LinuxThreads`.

### Note

RPM distributions of MySQL often are provided by other vendors. Be aware that they may differ in features and capabilities from those built by us, and that the instructions in this manual do not necessarily apply to installing them. The vendor's instructions should be consulted instead.

If you have problems with an RPM file (for example, if you receive the error `Sorry, the host 'xxxx' could not be looked up`), see [Section 2.13.1.2, “Linux Binary Distribution Notes”](#).

In most cases, you need to install only the `MySQL-server` and `MySQL-client` packages to get a functional MySQL installation. The other packages are not required for a standard installation.

**RPMs for MySQL Cluster.** Beginning with MySQL 5.1.24, standard MySQL server RPMs built by MySQL no longer provide support for the `NDBCLUSTER` storage engine. MySQL Cluster users wanting to upgrade MySQL 5.1.23 or earlier installations from RPMs built by MySQL should upgrade to MySQL Cluster NDB 6.2 or MySQL Cluster NDB 6.3; RPMs that should work with most Linux distributions are available for both of these release series.

### Important

When upgrading a MySQL Cluster RPM installation, you must upgrade *all* installed RPMs, including the `Server` and `Client` RPMs.

For more information about installing MySQL Cluster from RPMs, see [MySQL Cluster Multi-Computer Installation](#).

For upgrades, if your installation was originally produced by installing multiple RPM packages, it is best to upgrade all the packages, not just some. For example, if you previously installed the server and client RPMs, do not upgrade just the server RPM.

If you get a dependency failure when trying to install MySQL packages (for example, `error: removing these packages would break dependencies: libmysqlclient.so.10 is needed by ...`), you should also install the `MySQL-shared-compat` package, which includes both the shared libraries for backward compatibility (`libmysqlclient.so.12` for MySQL 4.0 and `libmysqlclient.so.10` for MySQL 3.23).

Some Linux distributions still ship with MySQL 3.23 and they usually link applications dynamically to save disk space. If these shared libraries are in a separate package (for example, `MySQL-shared`), it is sufficient to simply leave this package installed and just upgrade the MySQL server and client packages (which are statically linked and do not depend on the shared libraries). For distributions that include the shared libraries in the same package as the MySQL server (for example, Red Hat Linux), you could

either install our 3.23 `MySQL-shared` RPM, or use the `MySQL-shared-compat` package instead. (Do not install both.)

The RPM packages shown in the following list are available. The names shown here use a suffix of `.glibc23.i386.rpm`, but particular packages can have different suffixes, as described later.

- `MySQL-server-VERSION.glibc23.i386.rpm`

The MySQL server. You need this unless you only want to connect to a MySQL server running on another machine.

- `MySQL-client-VERSION.glibc23.i386.rpm`

The standard MySQL client programs. You probably always want to install this package.

- `MySQL-devel-VERSION.glibc23.i386.rpm`

The libraries and include files that are needed if you want to compile other MySQL clients, such as the Perl modules.

- `MySQL-debuginfo-VERSION.glibc23.i386.rpm`

This package contains debugging information. `debuginfo` RPMs are never needed to use MySQL software; this is true both for the server and for client programs. However, they contain additional information that might be needed by a debugger to analyze a crash.

- `MySQL-shared-VERSION.glibc23.i386.rpm`

This package contains the shared libraries (`libmysqlclient.so*`) that certain languages and applications need to dynamically load and use MySQL. It contains single-threaded and thread-safe libraries. If you install this package, do not install the `MySQL-shared-compat` package.

- `MySQL-shared-compat-VERSION.glibc23.i386.rpm`

This package includes the shared libraries for MySQL 3.23, 4.0, and so on, up to the current release. It contains single-threaded and thread-safe libraries. Install this package instead of `MySQL-shared` if you have applications installed that are dynamically linked against older versions of MySQL but you want to upgrade to the current version without breaking the library dependencies.

- `MySQL-embedded-VERSION.glibc23.i386.rpm`

The embedded MySQL server library.

- `MySQL-ndb-management-VERSION.glibc23.i386.rpm`,  
`MySQL-ndb-storage-VERSION.glibc23.i386.rpm`, `MySQL-ndb-tools-VERSION.glibc23.i386.rpm`,  
`MySQL-ndb-extra-VERSION.glibc23.i386.rpm`

Packages that contain additional files for MySQL Cluster installations.

### Note

The `MySQL-ndb-tools` RPM requires a working installation of perl. Prior to MySQL 5.1.18, the `DBI` and `HTML::Template` packages were also required. See [Section 2.15, “Perl Installation Notes”](#), and `ndb_size.pl`, for more information.

- `MySQL-test-VERSION.glibc23.i386.rpm`

This package includes the MySQL test suite.

- `MySQL-VERSION.src.rpm`

This contains the source code for all of the previous packages. It can also be used to rebuild the RPMs on other architectures (for example, Alpha or SPARC).

The suffix of RPM package names (following the `VERSION` value) has the following syntax:

```
.PLATFORM.CPU.rpm
```

The `PLATFORM` and `CPU` values indicate the type of system for which the package is built. `PLATFORM` indicates the platform and `CPU` indicates the processor type or family.

All packages are dynamically linked against `glibc 2.3`. The `PLATFORM` value indicates whether the package is platform independent or intended for a specific platform, as shown in the following table.

<code>glibc23</code>	Platform independent, should run on any Linux distribution that supports <code>glibc 2.3</code>
<code>rhel3, rhel4</code>	Red Hat Enterprise Linux 3 or 4
<code>sles9, sles10</code>	SuSE Linux Enterprise Server 9 or 10

In MySQL 5.1, only `glibc23` packages are available currently.

The `CPU` value indicates the processor type or family for which the package is built.

<code>i386</code>	x86 processor, 386 and up
<code>i586</code>	x86 processor, Pentium and up
<code>x86_64</code>	64-bit x86 processor
<code>ia64</code>	Itanium (IA-64) processor

To see all files in an RPM package (for example, a `MySQL-server` RPM), run a command like this:

```
shell> rpm -qpl MySQL-server-VERSION.glibc23.i386.rpm
```

To perform a standard minimal installation, install the server and client RPMs:

```
shell> rpm -i MySQL-server-VERSION.glibc23.i386.rpm
shell> rpm -i MySQL-client-VERSION.glibc23.i386.rpm
```

To install only the client programs, install just the client RPM:

```
shell> rpm -i MySQL-client-VERSION.glibc23.i386.rpm
```

RPM provides a feature to verify the integrity and authenticity of packages before installing them. If you would like to learn more about this feature, see [Section 2.1.4, “Verifying Package Integrity Using MD5 Checksums or GnuPG”](#).

The server RPM places data under the `/var/lib/mysql` directory. The RPM also creates a login account for a user named `mysql` (if one does not exist) to use for running the MySQL server, and creates the appropriate entries in `/etc/init.d/` to start the server automatically at boot time. (This means that if you have performed a previous installation and have made changes to its startup script, you may want to make a copy of the script so that you don't lose it when you install a newer RPM.) See [Section 2.11.2.2, “Starting and Stopping MySQL Automatically”](#), for more information on how MySQL can be started automatically on system startup.

If you want to install the MySQL RPM on older Linux distributions that do not support initialization scripts in `/etc/init.d` (directly or via a symlink), you should create a symbolic link that points to the location where your initialization scripts actually are installed. For example, if that location is `/etc/rc.d/init.d`, use these commands before installing the RPM to create `/etc/init.d` as a symbolic link that points there:

```
shell> cd /etc
shell> ln -s rc.d/init.d .
```

However, all current major Linux distributions should support the new directory layout that uses `/etc/init.d`, because it is required for LSB (Linux Standard Base) compliance.

If the RPM files that you install include `MySQL-server`, the `mysqld` server should be up and running after installation. You should be able to start using MySQL.

If something goes wrong, you can find more information in the binary installation section. See [Section 2.9, “Installing MySQL from tar.gz Packages on Other Unix-Like Systems”](#).

### Note

The accounts that are listed in the MySQL grant tables initially have no passwords. After starting the server, you should set up passwords for them using the instructions in [Section 2.11, “Post-Installation Setup and Testing”](#).

During RPM installation, a user named `mysql` and a group named `mysql` are created on the system. This is done using the `useradd`, `groupadd`, and `usermod` commands. Those commands require appropriate administrative privileges, which is ensured for locally managed users and groups (as listed in the `/etc/passwd` and `/etc/group` files) by the RPM installation process being run by `root`.

For non-local user management (LDAP, NIS, and so forth), the administrative tools may require additional authentication (such as

a password), and will fail if the installing user does not provide this authentication. Even if they fail, the RPM installation will not abort but succeed, and this is intentional. If they failed, some of the intended transfer of ownership may be missing, and it is recommended that the system administrator then manually ensures some appropriate user and group exists and manually transfers ownership following the actions in the RPM spec file.

## 2.5. Installing MySQL on Mac OS X

You can install MySQL on Mac OS X 10.3.x (“Panther”) or newer using a Mac OS X binary package in PKG format instead of the binary tarball distribution. Please note that older versions of Mac OS X (for example, 10.1.x or 10.2.x) are **not** supported by this package.

The package is located inside a disk image (`.dmg`) file that you first need to mount by double-clicking its icon in the Finder. It should then mount the image and display its contents.

To obtain MySQL, see [Section 2.1.3, “How to Get MySQL”](#).

### Note

Before proceeding with the installation, be sure to shut down all running MySQL server instances by either using the MySQL Manager Application (on Mac OS X Server) or via `mysqladmin shutdown` on the command line.

To actually install the MySQL PKG file, double-click on the package icon. This launches the Mac OS X Package Installer, which guides you through the installation of MySQL.

Due to a bug in the Mac OS X package installer, you may see this error message in the destination disk selection dialog:

```
You cannot install this software on this disk. (null)
```

If this error occurs, simply click the [Go Back](#) button once to return to the previous screen. Then click [Continue](#) to advance to the destination disk selection again, and you should be able to choose the destination disk correctly. We have reported this bug to Apple and it is investigating this problem.

The Mac OS X PKG of MySQL installs itself into `/usr/local/mysql-VERSION` and also installs a symbolic link, `/usr/local/mysql`, that points to the new location. If a directory named `/usr/local/mysql` exists, it is renamed to `/usr/local/mysql.bak` first. Additionally, the installer creates the grant tables in the `mysql` database by executing `mysql_install_db`.

The installation layout is similar to that of a `tar` file binary distribution; all MySQL binaries are located in the directory `/usr/local/mysql/bin`. The MySQL socket file is created as `/tmp/mysql.sock` by default. See [Section 2.1.5, “Installation Layouts”](#).

MySQL installation requires a Mac OS X user account named `mysql`. A user account with this name should exist by default on Mac OS X 10.2 and up.

If you are running Mac OS X Server, a version of MySQL should already be installed. The following table shows the versions of MySQL that ship with Mac OS X Server versions.

Mac OS X Server Version	MySQL Version
10.2-10.2.2	3.23.51
10.2.3-10.2.6	3.23.53
10.3	4.0.14
10.3.2	4.0.16
10.4.0	4.1.10a

This manual section covers the installation of the official MySQL Mac OS X PKG only. Make sure to read Apple's help information about installing MySQL: Run the “Help View” application, select “Mac OS X Server” help, do a search for “MySQL,” and read the item entitled “Installing MySQL.”

If you previously used Marc Liyanage's MySQL packages for Mac OS X from <http://www.entropy.ch>, you can simply follow the update instructions for packages using the binary installation layout as given on his pages.

If you are upgrading from Marc's 3.23.x versions or from the Mac OS X Server version of MySQL to the official MySQL PKG, you also need to convert the existing MySQL privilege tables to the current format, because some new security privileges have been added. See [Section 4.4.8, “mysql\\_upgrade — Check Tables for MySQL Upgrade”](#).

If you want MySQL to start automatically during system startup, you also need to install the MySQL Startup Item. It is part of the

Mac OS X installation disk images as a separate installation package. Simply double-click the `MySQLStartupItem.pkg` icon and follow the instructions to install it. The Startup Item need be installed only once. There is no need to install it each time you upgrade the MySQL package later.

The Startup Item for MySQL is installed into `/Library/StartupItems/MySQLCOM`. (Before MySQL 4.1.2, the location was `/Library/StartupItems/MySQL`, but that collided with the MySQL Startup Item installed by Mac OS X Server.) Startup Item installation adds a variable `MySQLCOM=-YES-` to the system configuration file `/etc/hostconfig`. If you want to disable the automatic startup of MySQL, simply change this variable to `MySQLCOM=-NO-`.

On Mac OS X Server, the default MySQL installation uses the variable `MySQL` in the `/etc/hostconfig` file. The MySQL Startup Item installer disables this variable by setting it to `MySQL=-NO-`. This avoids boot time conflicts with the `MySQLCOM` variable used by the MySQL Startup Item. However, it does not shut down a running MySQL server. You should do that yourself.

After the installation, you can start up MySQL by running the following commands in a terminal window. You must have administrator privileges to perform this task.

If you have installed the Startup Item, use this command:

```
shell> sudo /Library/StartupItems/MySQLCOM/MySQLCOM start
(Enter your password, if necessary)
(Press Control-D or enter "exit" to exit the shell)
```

If you don't use the Startup Item, enter the following command sequence:

```
shell> cd /usr/local/mysql
shell> sudo ./bin/mysqld_safe
(Enter your password, if necessary)
(Press Control-Z)
shell> bg
(Press Control-D or enter "exit" to exit the shell)
```

You should be able to connect to the MySQL server, for example, by running `/usr/local/mysql/bin/mysql`.

### Note

The accounts that are listed in the MySQL grant tables initially have no passwords. After starting the server, you should set up passwords for them using the instructions in [Section 2.11, "Post-Installation Setup and Testing"](#).

You might want to add aliases to your shell's resource file to make it easier to access commonly used programs such as `mysql` and `mysqladmin` from the command line. The syntax for `bash` is:

```
alias mysql=/usr/local/mysql/bin/mysql
alias mysqladmin=/usr/local/mysql/bin/mysqladmin
```

For `tcsh`, use:

```
alias mysql /usr/local/mysql/bin/mysql
alias mysqladmin /usr/local/mysql/bin/mysqladmin
```

Even better, add `/usr/local/mysql/bin` to your `PATH` environment variable. You can do this by modifying the appropriate startup file for your shell. For more information, see [Section 4.2.1, "Invoking MySQL Programs"](#).

If you are upgrading an existing installation, note that installing a new MySQL PKG does not remove the directory of an older installation. Unfortunately, the Mac OS X Installer does not yet offer the functionality required to properly upgrade previously installed packages.

To use your existing databases with the new installation, you'll need to copy the contents of the old data directory to the new data directory. Make sure that neither the old server nor the new one is running when you do this. After you have copied over the MySQL database files from the previous installation and have successfully started the new server, you should consider removing the old installation files to save disk space. Additionally, you should also remove older versions of the Package Receipt directories located in `/Library/Receipts/mysql-VERSION.pkg`.

## 2.6. Installing MySQL on Solaris

To obtain a binary MySQL distribution for Solaris in tarball or PKG format, <http://dev.mysql.com/downloads/mysql/5.1.html>.

If you install MySQL using a binary tarball distribution on Solaris, you may run into trouble even before you get the MySQL distribution unpacked, as the Solaris `tar` cannot handle long file names. This means that you may see errors when you try to unpack MySQL.

If this occurs, you must use GNU `tar` (`gtar`) to unpack the distribution.

You can install MySQL on Solaris using a binary package in PKG format instead of the binary tarball distribution. Before installing using the binary PKG format, you should create the `mysql` user and group, for example:

```
groupadd mysql
useradd -g mysql mysql
```

Some basic PKG-handling commands follow:

- To add a package:

```
pkgadd -d package_name.pkg
```

- To remove a package:

```
pkgrm package_name
```

- To get a full list of installed packages:

```
pkginfo
```

- To get detailed information for a package:

```
pkginfo -l package_name
```

- To list the files belonging to a package:

```
pkgchk -v package_name
```

- To get packaging information for an arbitrary file:

```
pkgchk -l -p file_name
```

For additional information about installing MySQL on Solaris, see [Section 2.13.3, “Solaris Notes”](#).

## 2.7. Installing MySQL on i5/OS

The i5/OS POWER MySQL package was created in cooperation with IBM. MySQL works within the Portable Application Solution Environment (PASE) on the System i series of hardware and will also provide database services for the Zend Core for i5/OS.

MySQL for i5/OS is provided as a save file (`.savf`) package that can be downloaded and installed directly without any additional installation steps required.

MySQL is only supported on i5/OS V5R4 or later releases. The i5/OS PASE must be installed for MySQL to operate. You must be able to login as a user in `*SECOFR` class.

You should the installation notes and tips for i5/OS before starting installation. See [i5/OS Installation Notes](#).

### Note

The installation package will use an existing configuration if you have previously installed MySQL (which is identified by looking for the file `/etc/my.cnf`). The values for the data directory (`DATADIR`) and owner of the MySQL files (`USRPRF`) specified during the installation will be ignored, and the values determined from the `/etc/my.cnf` will be used instead.

If you want to change these parameters during a new install, you should temporarily rename `/etc/my.cnf`, install MySQL using the new parameters you want to use, and then merge your previous `/etc/my.cnf` configuration settings with the new `/etc/my.cnf` file that is created during installation.

To install MySQL on i5/OS, follow these steps:

1. Create a user profile `MYSQL`. The `MYSQL` user profile will own all the MySQL files and databases and be the active user used when the MySQL server is running. The profile should be disabled so that you cannot log in as the MySQL user. To create a user profile, use `CRTUSRPRF`:

```
CRTUSRPRF USRPRF(MYSQL) STATUS(*DISABLED) TEXT('MySQL user id')
```

2. On the System i machine, create a save file that will be used to receive the downloaded installation save file. The file should be located within the General Purpose Library (QGPL):

```
CRTSAVF FILE(QGPL/MYSQLINST)
```

3. Download the MySQL installation save file in 32-bit (`mysql-5.0.42-i5os-power-32bit.savf`) or 64-bit (`mysql-5.0.42-i5os-power-64bit.savf`) from [MySQL Downloads](#).
4. You need to FTP the downloaded `.savf` file directly into the `QGPL/MYSQLINST` file on the System i server. You can do this through FTP using the following steps after logging in to the System i machine:

```
ftp> bin
ftp> cd qgpl
ftp> put mysql-5.0.42-i5os-power.savf mysqlinst
```

5. Log into the System i server using a user in the `*SECOFR` class, such as the `QSECOFR` user ID.
6. You need to restore the installation library stored in the `.savf` save file:

```
RSTLIB MYSQLINST DEV(*SAVF) SAVF(QGPL/MYSQLINST)
```

7. You need to execute the installation command, `MYSQLINST/INSMYSQL`. You can specify three parameter settings during installation:
  - `DIR('/opt/mysql')` sets the installation location for the MySQL files. The directory will be created if it does not already exist.
  - `DATADIR('/QOpenSys/mysal/data')` sets the location of the directory that will be used to store the database files and binary logs. The default setting is `/QOpenSys/mysql/data`. Note that if the installer detects an existing installation (due to the existence of `/etc/my.cnf`), then this parameter will be ignored.
  - `USRPRF(MYSQL)` sets the user profile that will own the files that are installed. The profile will be created if it does not already exist.

MySQL can be installed anywhere, for this example we will assume MySQL has been installed into `/opt/mysql`. The `MYSQL` user profile that was created earlier in this sequence should be used for the profile:

```
MYSQLINST/INSMYSQL DIR('/opt/mysql') DATADIR('/opt/mysql/data') USRPRF(MYSQL)
```

If you are updating an installation over an existing MySQL installation, you should use the same parameter values that were used when MySQL was originally installed.

The installation copies all the necessary files into a directory matching the package version (for example `mysql-5.0.42-i5os-power-32bit`), sets the ownership on those files, sets up the MySQL environment and creates the MySQL configuration file (in `/etc/my.cnf`) completing all the steps in a typical binary installation process automatically. If this is a new installation of MySQL, or if the installer detects that this is a new version (because the `/etc/my.cnf` file does not exist), then the initial core MySQL databases will also be created during installation.

8. Once the installation has completed, you can delete the installation file:

```
DLTLIB LIB(MYSQLINST)
```

To start MySQL:

1. Log into the System i server using a user within the `*SECOFR` class, such as the `QSECOFR` user ID.

### Note

You should start `mysqld_safe` using a user that in the PASE environment has the `id=0` (the equivalent of the standard Unix `root` user). If you do not use a user with this ID then the system will be unable to change the user when executing `mysqld` as set using `--user` option. If this happens, `mysqld` may be unable to read the files located within the MySQL data directory and the execution will fail.

2. Enter the PASE environment using `call qp2term`.
3. Start the MySQL server by changing to the installation directory and running `mysqld_safe`, specifying the user name used to install the server. The installer conveniently installs a symbolic link to the installation directory (`mysql-`



5.0.42-i5os-power-32bit) as /opt/mysql/mysql:

```
> cd /opt/mysql/mysql
> bin/mysqld_safe --user=mysql &
```

You should see a message similar to the following:

```
Starting mysqld daemon with databases »
from /opt/mysql/mysql-enterprise-5.0.42-i5os-power-32bit/data
```

If you are having problems starting MySQL server, see [Section 2.11.2.3, “Starting and Troubleshooting the MySQL Server”](#).

To stop MySQL:

1. Log into the System i server using the \*SECOFR class, such as the QSECOFR user ID.
2. Enter the PASE environment using `call qp2term`.
3. Stop the MySQL server by changing into the installation directory and running `mysqladmin`, specifying the user name used to install the server:

```
> cd /opt/mysql/mysql
> bin/mysqladmin -u root shutdown
```

If the session that you started and stopped MySQL are the same, you may get the log output from `mysqld`:

```
STOPPING server from pid file »
/opt/mysql/mysql-enterprise-5.0.42-i5os-power-32bit/data/I5DBX.RCHLAND.IBM.COM.pid
070718 10:34:20 mysqld ended
```

If the sessions used to start and stop MySQL are different, you will not receive any confirmation of the shutdown.

#### Note and tips

- A problem has been identified with the installation process on DBCS systems. If you are having problems install MySQL on a DBCS system, you need to change your job's coded character set identifier (CSSID) to 37 (EBCDIC) before executing the install command, `INSMYSQL`. To do this, determine your existing CSSID (using `DSPJOB` and selecting option 2), execute `CHGJOB CSSID(37)`, run `INSMYSQL` to install MySQL and then execute `CHGJOB` again with your original CSSID.
- If you want to use the Perl scripts that are included with MySQL, you need to download the iSeries Tools for Developers (5799-PTL). See <http://www-03.ibm.com/servers/enable/site/porting/tools/>.

## 2.8. Installing MySQL on NetWare

Porting MySQL to NetWare was an effort spearheaded by Novell. Novell customers should be pleased to note that NetWare 6.5 ships with bundled MySQL binaries, complete with an automatic commercial use license for all servers running that version of NetWare.

MySQL for NetWare is compiled using a combination of Metrowerks CodeWarrior for NetWare and special cross-compilation versions of the GNU autotools.

The latest binary packages for NetWare can be obtained at <http://dev.mysql.com/downloads/>. See [Section 2.1.3, “How to Get MySQL”](#).

To host MySQL, the NetWare server must meet these requirements:

- The latest Support Pack of [NetWare 6.5](#) must be installed.
- The system must meet Novell's minimum requirements to run the respective version of NetWare.
- MySQL data and the program binaries must be installed on an NSS volume; traditional volumes are not supported.

To install MySQL for NetWare, use the following procedure:

1. If you are upgrading from a prior installation, stop the MySQL server. This is done from the server console, using the following command:

```
SERVER: mysqladmin -u root shutdown
```

### Note

If the MySQL `root` user account has a password, you need to invoke `mysqladmin` with the `-p` option and supply the password when prompted.

2. Log on to the target server from a client machine with access to the location where you are installing MySQL.
3. Extract the binary package Zip file onto the server. Be sure to allow the paths in the Zip file to be used. It is safe to simply extract the file to `SYS:\`.

If you are upgrading from a prior installation, you may need to copy the data directory (for example, `SYS:MYSQL\DATA`), as well as `my.cnf`, if you have customized it. You can then delete the old copy of MySQL.

4. You might want to rename the directory to something more consistent and easy to use. The examples in this manual use `SYS:MYSQL` to refer to the installation directory.

Note that MySQL installation on NetWare does not detect if a version of MySQL is already installed outside the NetWare release. Therefore, if you have installed the latest MySQL version from the Web (for example, MySQL 4.1 or later) in `SYS:MYSQL`, you must rename the folder before upgrading the NetWare server; otherwise, files in `SYS:MYSQL` are overwritten by the MySQL version present in NetWare Support Pack.

5. At the server console, add a search path for the directory containing the MySQL NLMs. For example:

```
SERVER: SEARCH ADD SYS:MYSQL\BIN
```

6. Initialize the data directory and the grant tables, if necessary, by executing `mysql_install_db` at the server console.
7. Start the MySQL server using `mysqld_safe` at the server console.
8. To finish the installation, you should also add the following commands to `autoexec.ncf`. For example, if your MySQL installation is in `SYS:MYSQL` and you want MySQL to start automatically, you could add these lines:

```
#Starts the MySQL 5.1.x database server
SEARCH ADD SYS:MYSQL\BIN
MYSQLD_SAFE
```

If you are running MySQL on NetWare 6.0, we strongly suggest that you use the `--skip-external-locking` option on the command line:

```
#Starts the MySQL 5.1.x database server
SEARCH ADD SYS:MYSQL\BIN
MYSQLD_SAFE --skip-external-locking
```

It is also necessary to use `CHECK TABLE` and `REPAIR TABLE` instead of `myisamchk`, because `myisamchk` makes use of external locking. External locking is known to have problems on NetWare 6.0; the problem has been eliminated in NetWare 6.5. Note that the use of MySQL on Netware 6.0 is not officially supported.

`mysqld_safe` on NetWare provides a screen presence. When you unload (shut down) the `mysqld_safe` NLM, the screen does not go away by default. Instead, it prompts for user input:

```
*<NLM has terminated; Press any key to close the screen>*
```

If you want NetWare to close the screen automatically instead, use the `--autoclose` option to `mysqld_safe`. For example:

```
#Starts the MySQL 5.1.x database server
SEARCH ADD SYS:MYSQL\BIN
MYSQLD_SAFE --autoclose
```

The behavior of `mysqld_safe` on NetWare is described further in [Section 4.3.2, “mysqld\\_safe — MySQL Server Startup Script”](#).

9. When installing MySQL, either for the first time or upgrading from a previous version, download and install the latest and appropriate Perl module and PHP extensions for NetWare:

- Perl: <http://forge.novell.com/modules/xfcontent/downloads.php/perl/Modules/>
- PHP: <http://forge.novell.com/modules/xfcontent/downloads.php/php/Modules/>

If there was an existing installation of MySQL on the NetWare server, be sure to check for existing MySQL startup commands in `autoexec.ncf`, and edit or delete them as necessary.

### Note

The accounts that are listed in the MySQL grant tables initially have no passwords. After starting the server, you should set up passwords for them using the instructions in [Section 2.11, “Post-Installation Setup and Testing”](#).

## 2.9. Installing MySQL from `tar.gz` Packages on Other Unix-Like Systems

This section covers the installation of MySQL binary distributions that are provided for various platforms in the form of compressed `tar` files (files with a `.tar.gz` extension). See [Section 2.1.2.4, “MySQL Binaries Compiled by Sun Microsystems, Inc.”](#), for a detailed list.

To obtain MySQL, see [Section 2.1.3, “How to Get MySQL”](#).

MySQL `tar` file binary distributions have names of the form `mysql-VERSION-OS.tar.gz`, where `VERSION` is a number (for example, `5.1.36`), and `OS` indicates the type of operating system for which the distribution is intended (for example, `pc-linux-i686`).

In addition to these generic packages, we also offer binaries in platform-specific package formats for selected platforms. See [Section 2.2, “Standard MySQL Installation Using a Binary Distribution”](#), for more information on how to install these.

You need the following tools to install a MySQL `tar` file binary distribution:

- GNU `gunzip` to uncompress the distribution.
- A reasonable `tar` to unpack the distribution. GNU `tar` is known to work. Some operating systems come with a preinstalled version of `tar` that is known to have problems. For example, the `tar` provided with early versions of Mac OS X, SunOS 4.x and Solaris 8 and earlier are known to have problems with long file names. On Mac OS X, you can use the preinstalled `gnutar` program. On other systems with a deficient `tar`, you should install GNU `tar` first.

If you run into problems and need to file a bug report, please use the instructions in [Section 1.6, “How to Report Bugs or Problems”](#).

The basic commands that you must execute to install and use a MySQL binary distribution are:

```
shell> groupadd mysql
shell> useradd -g mysql mysql
shell> cd /usr/local
shell> gunzip < /path/to/mysql-VERSION-OS.tar.gz | tar xvf -
shell> ln -s full-path-to-mysql-VERSION-OS mysql
shell> cd mysql
shell> chown -R mysql .
shell> chgrp -R mysql .
shell> scripts/mysql_install_db --user=mysql
shell> chown -R root .
shell> chown -R mysql data
shell> bin/mysqld_safe --user=mysql &
```

### Note

This procedure does not set up any passwords for MySQL accounts. After following the procedure, proceed to [Section 2.11, “Post-Installation Setup and Testing”](#).

A more detailed version of the preceding description for installing a binary distribution follows:

1. Add a login user and group for `mysqld` to run as:

```
shell> groupadd mysql
shell> useradd -g mysql mysql
```

These commands add the `mysql` group and the `mysql` user. The syntax for `useradd` and `groupadd` may differ slightly on different versions of Unix, or they may have different names such as `adduser` and `addgroup`.

You might want to call the user and group something else instead of `mysql`. If so, substitute the appropriate name in the following steps.

- Pick the directory under which you want to unpack the distribution and change location into it. In the following example, we unpack the distribution under `/usr/local`. (The instructions, therefore, assume that you have permission to create files and directories in `/usr/local`. If that directory is protected, you must perform the installation as `root`.)

```
shell> cd /usr/local
```

- Obtain a distribution file using the instructions in [Section 2.1.3, “How to Get MySQL”](#). For a given release, binary distributions for all platforms are built from the same MySQL source distribution.
- Unpack the distribution, which creates the installation directory. Then create a symbolic link to that directory:

```
shell> gunzip < /path/to/mysql-VERSION-OS.tar.gz | tar xvf -
shell> ln -s full-path-to-mysql-VERSION-OS mysql
```

The `tar` command creates a directory named `mysql-VERSION-OS`. The `ln` command makes a symbolic link to that directory. This lets you refer more easily to the installation directory as `/usr/local/mysql`.

With GNU `tar`, no separate invocation of `gunzip` is necessary. You can replace the first line with the following alternative command to uncompress and extract the distribution:

```
shell> tar zxvf /path/to/mysql-VERSION-OS.tar.gz
```

- Change location into the installation directory:

```
shell> cd mysql
```

You will find several files and subdirectories in the `mysql` directory. The most important for installation purposes are the `bin` and `scripts` subdirectories:

- The `bin` directory contains client programs and the server. You should add the full path name of this directory to your `PATH` environment variable so that your shell finds the MySQL programs properly. See [Section 2.14, “Environment Variables”](#).
  - The `scripts` directory contains the `mysql_install_db` script used to initialize the `mysql` database containing the grant tables that store the server access permissions.
- Ensure that the distribution contents are accessible to `mysql`. If you unpacked the distribution as `mysql`, no further action is required. If you unpacked the distribution as `root`, its contents will be owned by `root`. Change its ownership to `mysql` by executing the following commands as `root` in the installation directory:

```
shell> chown -R mysql .
shell> chgrp -R mysql .
```

The first command changes the owner attribute of the files to the `mysql` user. The second changes the group attribute to the `mysql` group.

- If you have not installed MySQL before, you must create the MySQL data directory and initialize the grant tables:

```
shell> scripts/mysql_install_db --user=mysql
```

If you run the command as `root`, include the `--user` option as shown. If you run the command while logged in as that user, you can omit the `--user` option.

The command should create the data directory and its contents with `mysql` as the owner.

After creating or updating the grant tables, you need to restart the server manually.

- Most of the MySQL installation can be owned by `root` if you like. The exception is that the data directory must be owned by `mysql`. To accomplish this, run the following commands as `root` in the installation directory:

```
shell> chown -R root .
shell> chown -R mysql data
```

9. If you want MySQL to start automatically when you boot your machine, you can copy `support-files/mysql.server` to the location where your system has its startup files. More information can be found in the `support-files/mysql.server` script itself and in [Section 2.11.2.2, “Starting and Stopping MySQL Automatically”](#).
10. You can set up new accounts using the `bin/mysql_setpermission` script if you install the `DBI` and `DBD:mysql` Perl modules. See [Section 4.6.14, “mysql\\_setpermission — Interactively Set Permissions in Grant Tables”](#). For Perl module installation instructions, see [Section 2.15, “Perl Installation Notes”](#).
11. If you would like to use `mysqlaccess` and have the MySQL distribution in some non-standard location, you must change the location where `mysqlaccess` expects to find the `mysql` client. Edit the `bin/mysqlaccess` script at approximately line 18. Search for a line that looks like this:

```
$MYSQL = '/usr/local/bin/mysql'; # path to mysql executable
```

Change the path to reflect the location where `mysql` actually is stored on your system. If you do not do this, a [Broken pipe](#) error will occur when you run `mysqlaccess`.

After everything has been unpacked and installed, you should test your distribution. To start the MySQL server, use the following command:

```
shell> bin/mysqld_safe --user=mysql &
```

If you run the command as `root`, you must use the `--user` option as shown. The value of the option is the name of the login account that you created in the first step to use for running the server. If you run the command while logged in as `mysql`, you can omit the `--user` option.

If the command fails immediately and prints `mysqld ended`, you can find some information in the `host_name.err` file in the data directory.

More information about `mysqld_safe` is given in [Section 4.3.2, “mysqld\\_safe — MySQL Server Startup Script”](#).

### Note

The accounts that are listed in the MySQL grant tables initially have no passwords. After starting the server, you should set up passwords for them using the instructions in [Section 2.11, “Post-Installation Setup and Testing”](#).

## 2.10. MySQL Installation Using a Source Distribution

Before you proceed with an installation from source, first check whether our binary is available for your platform and whether it works for you. We put a great deal of effort into ensuring that our binaries are built with the best possible options.

To obtain a source distribution for MySQL, [Section 2.1.3, “How to Get MySQL”](#). If you want to build MySQL from source on Windows, see [Section 2.10.6, “Installing MySQL from Source on Windows”](#).

MySQL source distributions are provided as compressed `tar` archives and have names of the form `mysql-VERSION.tar.gz`, where `VERSION` is a number like `5.1.36`.

You need the following tools to build and install MySQL from source:

- GNU `gunzip` to uncompress the distribution.
- A reasonable `tar` to unpack the distribution. GNU `tar` is known to work. Some operating systems come with a preinstalled version of `tar` that is known to have problems. For example, the `tar` provided with early versions of Mac OS X, SunOS 4.x and Solaris 8 and earlier are known to have problems with long file names. On Mac OS X, you can use the preinstalled `gnutar` program. On other systems with a deficient `tar`, you should install GNU `tar` first.
- A working ANSI C++ compiler. `gcc 2.95.2` or later, `SGI C++`, and `SunPro C++` are some of the compilers that are known to work. `libg++` is not needed when using `gcc`. `gcc 2.7.x` has a bug that makes it impossible to compile some perfectly legal C++ files, such as `sql/sql_base.cc`. If you have only `gcc 2.7.x`, you must upgrade your `gcc` to be able to compile MySQL. `gcc 2.8.1` is also known to have problems on some platforms, so it should be avoided if a newer compiler exists for the platform. `gcc 2.95.2` or later is recommended.
- A good `make` program. GNU `make` is always recommended and is sometimes required. (BSD `make` fails, and vendor-provided `make` implementations may fail as well.) If you have problems, we recommend GNU `make 3.75` or newer.
- `libtool 1.5.24` or later is also recommended.

If you are using a version of `gcc` recent enough to understand the `-fno-exceptions` option, it is *very important* that you use this option. Otherwise, you may compile a binary that crashes randomly. We also recommend that you use `-felide-constructors` and `-fno-rtti` along with `-fno-exceptions`. When in doubt, do the following:

```
CFLAGS="-O3" CXX=gcc CXXFLAGS="-O3 -felide-constructors \
-fno-exceptions -fno-rtti" ./configure \
--prefix=/usr/local/mysql --enable-assembly \
--with-mysqld-ldflags=-all-static
```

On most systems, this gives you a fast and stable binary.

If you run into problems and need to file a bug report, please use the instructions in [Section 1.6, “How to Report Bugs or Problems”](#).

## 2.10.1. Source Installation Overview

The basic commands that you must execute to install a MySQL source distribution are:

```
shell> groupadd mysql
shell> useradd -g mysql mysql
shell> gunzip < mysql-VERSION.tar.gz | tar -xvf -
shell> cd mysql-VERSION
shell> ./configure --prefix=/usr/local/mysql
shell> make
shell> make install
shell> cp support-files/my-medium.cnf /etc/my.cnf
shell> cd /usr/local/mysql
shell> chown -R mysql .
shell> chgrp -R mysql .
shell> bin/mysql_install_db --user=mysql
shell> chown -R root .
shell> chown -R mysql var
shell> bin/mysqld_safe --user=mysql &
```

If you start from a source RPM, do the following:

```
shell> rpmbuild --rebuild --clean MySQL-VERSION.src.rpm
```

This makes a binary RPM that you can install. For older versions of RPM, you may have to replace the command `rpmbuild` with `rpm` instead.

### Note

This procedure does not set up any passwords for MySQL accounts. After following the procedure, proceed to [Section 2.11, “Post-Installation Setup and Testing”](#), for post-installation setup and testing.

A more detailed version of the preceding description for installing MySQL from a source distribution follows:

1. Add a login user and group for `mysqld` to run as:

```
shell> groupadd mysql
shell> useradd -g mysql mysql
```

These commands add the `mysql` group and the `mysql` user. The syntax for `useradd` and `groupadd` may differ slightly on different versions of Unix, or they may have different names such as `adduser` and `addgroup`.

You might want to call the user and group something else instead of `mysql`. If so, substitute the appropriate name in the following steps.

2. Perform the following steps as the `mysql` user, except as noted.
3. Pick the directory under which you want to unpack the distribution and change location into it.
4. Obtain a distribution file using the instructions in [Section 2.1.3, “How to Get MySQL”](#).
5. Unpack the distribution into the current directory:

```
shell> gunzip < /path/to/mysql-VERSION.tar.gz | tar xvf -
```

This command creates a directory named `mysql-VERSION`.

With GNU `tar`, no separate invocation of `gunzip` is necessary. You can use the following alternative command to uncom-

press and extract the distribution:

```
shell> tar zxvf /path/to/mysql-VERSION-OS.tar.gz
```

6. Change location into the top-level directory of the unpacked distribution:

```
shell> cd mysql-VERSION
```

Note that currently you must configure and build MySQL from this top-level directory. You cannot build it in a different directory.

7. Configure the release and compile everything:

```
shell> ./configure --prefix=/usr/local/mysql
shell> make
```

When you run `configure`, you might want to specify other options. Run `./configure --help` for a list of options. [Section 2.10.2, “Typical configure Options”](#), discusses some of the more useful options.

If `configure` fails and you are going to send mail to a MySQL mailing list to ask for assistance, please include any lines from `config.log` that you think can help solve the problem. Also include the last couple of lines of output from `configure`. To file a bug report, please use the instructions in [Section 1.6, “How to Report Bugs or Problems”](#).

If the compile fails, see [Section 2.10.4, “Dealing with Problems Compiling MySQL”](#), for help.

8. Install the distribution:

```
shell> make install
```

You might need to run this command as `root`.

If you want to set up an option file, use one of those present in the `support-files` directory as a template. For example:

```
shell> cp support-files/my-medium.cnf /etc/my.cnf
```

You might need to run this command as `root`.

If you want to configure support for `InnoDB` tables, you should edit the `/etc/my.cnf` file, remove the `#` character before the option lines that start with `innodb_ . . .`, and modify the option values to be what you want. See [Section 4.2.3.2, “Using Option Files”](#), and [Section 13.6.2, “InnoDB Configuration”](#).

9. Change location into the installation directory:

```
shell> cd /usr/local/mysql
```

10. If you ran the `make install` command as `root`, the installed files will be owned by `root`. Ensure that the installation is accessible to `mysql` by executing the following commands as `root` in the installation directory:

```
shell> chown -R mysql .
shell> chgrp -R mysql .
```

The first command changes the owner attribute of the files to the `mysql` user. The second changes the group attribute to the `mysql` group.

11. If you have not installed MySQL before, you must create the MySQL data directory and initialize the grant tables:

```
shell> bin/mysql_install_db --user=mysql
```

If you run the command as `root`, include the `--user` option as shown. If you run the command while logged in as `mysql`, you can omit the `--user` option.

The command should create the data directory and its contents with `mysql` as the owner.

After using `mysql_install_db` to create the grant tables for MySQL, you must restart the server manually. The `mysqld_safe` command to do this is shown in a later step.

12. Most of the MySQL installation can be owned by `root` if you like. The exception is that the data directory must be owned by `mysql`. To accomplish this, run the following commands as `root` in the installation directory:



```
shell> chown -R root .
shell> chown -R mysql var
```

13. If you want MySQL to start automatically when you boot your machine, you can copy `support-files/mysql.server` to the location where your system has its startup files. More information can be found in the `support-files/mysql.server` script itself; see also [Section 2.11.2.2, “Starting and Stopping MySQL Automatically”](#).
14. You can set up new accounts using the `bin/mysql_setpermission` script if you install the `DBI` and `DBD::mysql` Perl modules. See [Section 4.6.14, “mysql\\_setpermission — Interactively Set Permissions in Grant Tables”](#). For Perl module installation instructions, see [Section 2.15, “Perl Installation Notes”](#).

After everything has been installed, you should test your distribution. To start the MySQL server, use the following command:

```
shell> /usr/local/mysql/bin/mysqld_safe --user=mysql &
```

If you run the command as `root`, you should use the `--user` option as shown. The value of the option is the name of the login account that you created in the first step to use for running the server. If you run the command while logged in as that user, you can omit the `--user` option.

If the command fails immediately and prints `mysqld ended`, you can find some information in the `host_name.err` file in the data directory.

More information about `mysqld_safe` is given in [Section 4.3.2, “mysqld\\_safe — MySQL Server Startup Script”](#).

### Note

The accounts that are listed in the MySQL grant tables initially have no passwords. After starting the server, you should set up passwords for them using the instructions in [Section 2.11, “Post-Installation Setup and Testing”](#).

## 2.10.2. Typical `configure` Options

The `configure` script gives you a great deal of control over how you configure a MySQL source distribution. Typically you do this using options on the `configure` command line. You can also affect `configure` using certain environment variables. See [Section 2.14, “Environment Variables”](#). For a full list of options supported by `configure`, run this command:

```
shell> ./configure --help
```

A list of the available `configure` options is provided in the table below.

**Table 2.1. Build (`configure`) Reference**

Formats	Description	Default	Introduced	Removed
<code>--bindir=DIR</code>	User executables	EPREFIX/bin		
<code>--build=BUILD</code>	Configure for building on BUILD	guessed		
<code>--cache-file=FILE</code>	Cache test results in FILE	disabled		
<code>-C</code>	Alias for <code>--cache-file=config.cache'</code>			
<code>--config-cache</code>				
<code>--datadir=DIR</code>	Read-only architecture-independent data	PREFIX/share		
<code>--disable-FEATURE</code>	Do not include FEATURE			
<code>--disable-dependency-tracking</code>	Disable dependency tracking			
<code>--disable-grant-options</code>	Disable GRANT options			
<code>--disable-largefile</code>	Omit support for large files			
<code>--disable-libtool-lock</code>	Disable libtool lock			
<code>--disable-thread-safe-client</code>	Compile the client without threads		5.1.7	
<code>--enable-FEATURE</code>	Enable FEATURE			
<code>--enable-asmbler</code>	Use assembler versions of some string functions if available			
<code>--enable-dependency-tracking</code>	Do not reject slow dependency extractors			

Formats	Description	Default	Introduced	Removed
--enable-fast-install	Optimize for fast installation	yes		
--enable-local-infile	Enable LOAD DATA LOCAL INFILE	disabled		
--enable-shared	Build shared libraries	yes		
--enable-static	Build static libraries	yes		
--enable-thread-safe-client	Compile the client with threads			
--exec-prefix=EPREFIX	Install architecture-dependent files in EPREFIX			
-h	Display this help and exit			
--help				
--help=short	Display options specific to this package			
--help=recursive	Display the short help of all the included packages			
--host=HOST	Cross-compile to build programs to run on HOST			
--includedir=DIR	C header files	PREFIX/include		
--infodir=DIR	Info documentation	PREFIX/info		
--libdir=DIR	Object code libraries	EPREFIX/lib		
--libexecdir=DIR	Program executables	EPREFIX/libexec		
--localstatedir=DIR	Modifiable single-machine data	PREFIX/var		
--mandir=DIR	man documentation	PREFIX/man		
-n	Do not create output files			
--no-create				
--oldincludedir=DIR	C header files for non-gcc	/usr/include		
--prefix=PREFIX	Install architecture-independent files in PREFIX			
--program-prefix=PREFIX	Prepend PREFIX to installed program names			
--program-suffix=SUFFIX	Append SUFFIX to installed program names			
-program-transform-name=PROGRAM	run sed PROGRAM on installed program names			
-q	Do not print `checking...' messages			
--quiet				
--sbindir=DIR	System admin executables	EPREFIX/sbin		
--sharedstatedir=DIR	Modifiable architecture-independent data	PREFIX/com		
--srcdir=DIR	Find the sources in DIR	configure directory or ..		
--sysconfdir=DIR	Read-only single-machine data	PREFIX/etc		
--target=TARGET	Configure for building compilers for TARGET			
-V	Display version information and exit			
--version				
--with-PACKAGE	Use PACKAGE			
--with-archive-storage-engine	Enable the Archive Storage Engine	no		
--with-atomic-ops	Implement atomic operations using pthread rwlocks or atomic CPU instructions for multi-processor		5.1.12	
--with-berkeley-db	Use BerkeleyDB located in DIR	no		
--with-berkeley-db-includes	Find Berkeley DB headers in DIR			

Formats	Description	Default	Introduced	Removed
--with-berkeley-db-libs	Find Berkeley DB libraries in DIR			
--with-big-tables	Support tables with more than 4 G rows even on 32 bit platforms			
--with-blackhole-storage-engine	Enable the Blackhole Storage Engine	no		
--with-charset	Default character set			
--with-client-ldflags	Extra linking arguments for clients			
--with-collation	Default collation			
--with-comment	Comment about compilation environment			
--with-csv-storage-engine	Enable the CSV Storage Engine	yes		
--with-darwin-mwcc	Use Metrowerks CodeWarrior wrappers on OS X/Darwin			
--with-debug	Add debug code		5.1.7	
--with-debug=full	Add debug code (adds memory checker, very slow)			
--with-embedded-privilege-control	Build parts to check user's privileges (only affects embedded library)			
--with-embedded-server	Build the embedded server			
--with-error-inject	Enable error injection in MySQL Server		5.1.11	
--with-example-storage-engine	Enable the Example Storage Engine	no		
--with-extra-charsets	Use charsets in addition to default			
--with-fast-mutexes	Compile with fast mutexes	enabled	5.1.5	
--with-federated-storage-engine	Enable federated storage engine	no	5.1.3	5.1.9
--with-gnu-ld	Assume the C compiler uses GNU ld	no		
--with-innodb	Enable innobase storage engine	no	5.1.3	5.1.9
--with-lib-ccflags	Extra CC options for libraries			
--with-libwrap=DIR	Compile in libwrap (tcp_wrappers) support			
--with-low-memory	Try to use less memory to compile to avoid memory limitations			
--with-machine-type	Set the machine type, like "powerpc"			
--with-max-indexes=N	Sets the maximum number of indexes per table	64		
--with-mysqld-ldflags	Extra linking arguments for mysqld			
--with-mysqld-libs	Extra libraries to link with for mysqld			
--with-mysqld-user	What user the mysqld daemon shall be run as			
--with-mysqlmanager	Build the mysqlmanager binary	Build if server is built		
--with-named-curses-libs	Use specified curses libraries			
--with-named-thread-libs	Use specified thread libraries			
--with-ndb-ccflags	Extra CC options for ndb compile			
--with-ndb-docs	Include the NDB Cluster ndbapi and mgmapi documentation			
--with-ndb-port	Port for NDB Cluster management server			
--with-ndb-port-base	Port for NDB Cluster management server			
--with-ndb-sci=DIR	Provide MySQL with a custom location of sci library			
--with-ndb-test	Include the NDB Cluster ndbapi test programs			
--with-ndbcluster	Include the NDB Cluster table hand-	no		

Formats	Description	Default	Introduced	Removed
	ler			
--with-openssl=DIR	Include the OpenSSL support			
--with-openssl-includes	Find OpenSSL headers in DIR			
--with-openssl-libs	Find OpenSSL libraries in DIR			
--with-other-libc=DIR	Link against libc and other standard libraries installed in the specified non-standard location			
--with-pic	Try to use only PIC/non-PIC objects	Use both		
--with-plugin-PLUGIN	Forces the named plugin to be linked into mysqld statically		5.1.11	
--with-plugins	Plugins to include in mysqld	none	5.1.11	
--with-pstack	Use the pstack backtrace library			
--with-pthread	Force use of pthread library			
--with-row-based-replication	Include row-based replication		5.1.5	5.1.6
--with-server-suffix	Append value to the version string			
--with-ssl=DIR	Include SSL support		5.1.11	
--with-system-type	Set the system type, like "sun-solaris10"			
--with-tags	Include additional configurations	automatic		
--with-tcp-port	Which port to use for MySQL services	3306		
--with-unix-socket-path	Where to put the unix-domain socket			
--with-yassl	Include the yaSSL support			
--with-zlib-dir=no bundled DIR	Provide MySQL with a custom location of compression library			
--without-PACKAGE	Do not use PACKAGE			
--without-bench	Skip building of the benchmark suite			
--without-debug	Build a production version without debugging code			
--without-docs	Skip building of the documentation			
--without-extra-tools	Skip building utilities in the tools directory			
--without-geometry	Do not build geometry-related parts			
--without-libedit	Use system libedit instead of bundled copy			
--without-man	Skip building of the man pages			
--without-ndb-binlog	Disable ndb binlog		5.1.6	
--without-ndb-debug	Disable special ndb debug features			
--without-plugin-PLUGIN	Exclude PLUGIN		5.1.11	
--without-query-cache	Do not build query cache			
--without-readline	Use system readline instead of bundled copy			
--without-row-based-replication	Don't include row-based replication		5.1.7	5.1.14
--without-server	Only build the client			
--without-uca	Skip building of the national Unicode collations			

Some of the `configure` options available are described here. For options that may be of use if you have difficulties building MySQL, see [Section 2.10.4, "Dealing with Problems Compiling MySQL"](#).

- To compile just the MySQL client libraries and client programs and not the server, use the `--without-server` option:

```
shell> ./configure --without-server
```

If you have no C++ compiler, some client programs such as `mysql` cannot be compiled because they require C++. In this case, you can remove the code in `configure` that tests for the C++ compiler and then run `./configure` with the `--without-server` option. The compile step should still try to build all clients, but you can ignore any warnings about files such as `mysql.cc`. (If `make` stops, try `make -k` to tell it to continue with the rest of the build even if errors occur.)

- If you want to build the embedded MySQL library (`libmysqld.a`), use the `--with-embedded-server` option.
- If you don't want your log files and database directories located under `/usr/local/var`, use a `configure` command something like one of these:

```
shell> ./configure --prefix=/usr/local/mysql
shell> ./configure --prefix=/usr/local \
    --localstatedir=/usr/local/mysql/data
```

The first command changes the installation prefix so that everything is installed under `/usr/local/mysql` rather than the default of `/usr/local`. The second command preserves the default installation prefix, but overrides the default location for database directories (normally `/usr/local/var`) and changes it to `/usr/local/mysql/data`.

You can also specify the installation directory and data directory locations at server startup time by using the `--basedir` and `--datadir` options. These can be given on the command line or in an MySQL option file, although it is more common to use an option file. See [Section 4.2.3.2, "Using Option Files"](#).

- If you are using Unix and you want the MySQL socket file location to be somewhere other than the default location (normally in the directory `/tmp` or `/var/run`), use a `configure` command like this:

```
shell> ./configure \
    --with-unix-socket-path=/usr/local/mysql/tmp/mysql.sock
```

The socket file name must be an absolute path name. You can also change the location of `mysql.sock` at server startup by using a MySQL option file. See [Section B.1.4.5, "How to Protect or Change the MySQL Unix Socket File"](#).

- If you want to compile statically linked programs (for example, to make a binary distribution, to get better performance, or to work around problems with some Red Hat Linux distributions), run `configure` like this:

```
shell> ./configure --with-client-ldflags=-all-static \
    --with-mysqld-ldflags=-all-static
```

- If you are using `gcc` and don't have `libg++` or `libstdc++` installed, you can tell `configure` to use `gcc` as your C++ compiler:

```
shell> CC=gcc CXX=gcc ./configure
```

When you use `gcc` as your C++ compiler, it does not attempt to link in `libg++` or `libstdc++`. This may be a good thing to do even if you have those libraries installed. Some versions of them have caused strange problems for MySQL users in the past.

The following list indicates some compilers and environment variable settings that are commonly used with each one.

- `gcc 2.7.2`:

```
CC=gcc CXX=gcc CXXFLAGS="-O3 -felide-constructors"
```

- `gcc 2.95.2`:

```
CFLAGS="-O3 -mpentiumpro" CXX=gcc CXXFLAGS="-O3 -mpentiumpro \
-felide-constructors -fno-exceptions -fno-rtti"
```

- `pgcc 2.90.29` or newer:

```
CFLAGS="-O3 -mpentiumpro -mstack-align-double" CXX=gcc \
CXXFLAGS="-O3 -mpentiumpro -mstack-align-double \
-felide-constructors -fno-exceptions -fno-rtti"
```

In most cases, you can get a reasonably optimized MySQL binary by using the options from the preceding list and adding the following options to the `configure` line:

```
--prefix=/usr/local/mysql --enable-asm --enable-asm \
--with-mysqld-ldflags=-all-static
```

The full `configure` line would, in other words, be something like the following for all recent `gcc` versions:

```
CFLAGS="-O3 -mpentiumpro" CXX=gcc CXXFLAGS="-O3 -mpentiumpro \  
-felide-constructors -fno-exceptions -fno-rtti" ./configure \  
--prefix=/usr/local/mysql --enable-asm \ \  
--with-mysqld-ldflags=-all-static
```

The binaries we provide on the MySQL Web site at <http://dev.mysql.com/downloads/> are all compiled with full optimization and should be perfect for most users. See [Section 2.1.2.4, “MySQL Binaries Compiled by Sun Microsystems, Inc.”](#). There are some configuration settings you can tweak to build an even faster binary, but these are only for advanced users. See [Section 7.5.1, “How Compiling and Linking Affects the Speed of MySQL”](#).

If the build fails and produces errors about your compiler or linker not being able to create the shared library `libmysqlclient.so.N` (where `N` is a version number), you can work around this problem by giving the `--disable-shared` option to `configure`. In this case, `configure` does not build a shared `libmysqlclient.so.N` library.

- By default, MySQL uses the `latin1` (cp1252 West European) character set. To change the default set, use the `--with-charset` option:

```
shell> ./configure --with-charset=CHARSET
```

`CHARSET` may be one of `binary`, `armscii8`, `ascii`, `big5`, `cp1250`, `cp1251`, `cp1256`, `cp1257`, `cp850`, `cp852`, `cp866`, `cp932`, `dec8`, `eucljms`, `euclkr`, `gb2312`, `gbk`, `geostd8`, `greek`, `hebrew`, `hp8`, `keybcs2`, `koi8r`, `koi8u`, `latin1`, `latin2`, `latin5`, `latin7`, `macce`, `macroman`, `sjis`, `swe7`, `tis620`, `ucs2`, `ujis`, `utf8`. See [Section 9.2, “The Character Set Used for Data and Sorting”](#). (Additional character sets might be available. Check the output from `./configure --help` for the current list.)

The default collation may also be specified. MySQL uses the `latin1_swedish_ci` collation by default. To change this, use the `--with-collation` option:

```
shell> ./configure --with-collation=COLLATION
```

To change both the character set and the collation, use both the `--with-charset` and `--with-collation` options. The collation must be a legal collation for the character set. (Use the `SHOW COLLATION` statement to determine which collations are available for each character set.)

### Warning

If you change character sets after having created any tables, you must run `myisamchk -r -q -set-collation=collation_name` on every *MyISAM* table. Your indexes may be sorted incorrectly otherwise. This can happen if you install MySQL, create some tables, and then reconfigure MySQL to use a different character set and reinstall it.

With the `configure` option `--with-extra-charsets=LIST`, you can define which additional character sets should be compiled into the server. `LIST` is one of the following:

- A list of character set names separated by spaces
- `complex` to include all character sets that can't be dynamically loaded
- `all` to include all character sets into the binaries

Clients that want to convert characters between the server and the client should use the `SET NAMES` statement. See [Section 5.1.4, “Session System Variables”](#), and [Section 9.1.4, “Connection Character Sets and Collations”](#).

- To configure MySQL with debugging code, use the `--with-debug` option:

```
shell> ./configure --with-debug
```

This causes a safe memory allocator to be included that can find some errors and that provides output about what is happening. See [MySQL Internals: Porting](#).

As of MySQL 5.1.12, using `--with-debug` to configure MySQL with debugging support enables you to use the `--debug="d,parser_debug"` option when you start the server. This causes the Bison parser that is used to process SQL statements to dump a parser trace to the server's standard error output. Typically, this output is written to the error log.

- If your client programs are using threads, you must compile a thread-safe version of the MySQL client library with the `--`

`--enable-thread-safe-client` configure option. This creates a `libmysqlclient_r` library with which you should link your threaded applications. See [Section 20.10.17](#), “How to Make a Threaded Client”.

- Some features require that the server be built with compression library support, such as the `COMPRESS()` and `UNCOMPRESS()` functions, and compression of the client/server protocol. The `--with-zlib-dir=no|bundled|DIR` option provides control for compression library support. The value `no` explicitly disables compression support. `bundled` causes the `zlib` library bundled in the MySQL sources to be used. A `DIR` path name specifies where to find the compression library sources.
- It is possible to build MySQL with large table support using the `--with-big-tables` option.

This option causes the variables that store table row counts to be declared as `unsigned long long` rather than `unsigned long`. This enables tables to hold up to approximately  $1.844\text{E}+19$  ( $(2^{32})^2$ ) rows rather than  $2^{32}$  ( $\sim 4.295\text{E}+09$ ) rows. Previously it was necessary to pass `-DBIG_TABLES` to the compiler manually in order to enable this feature.

- Run `configure` with the `--disable-grant-options` option to cause the `--bootstrap`, `--skip-grant-tables`, and `--init-file` options for `mysqld` to be disabled. For Windows, the `configure.js` script recognizes the `DISABLE_GRANT_OPTIONS` flag, which has the same effect. The capability is available as of MySQL 5.1.15.
- This option allows MySQL Community Server features to be enabled. Additional options may be required for individual features, such as `--enable-profiling` to enable statement profiling. This option was added in MySQL 5.1.24. It is enabled by default as of MySQL 5.1.28; to disable it, use `--disable-community-features`.
- When given with `--enable-community-features`, the `--enable-profiling` option enables the statement profiling capability exposed by the `SHOW PROFILE` and `SHOW PROFILES` statements. (See [Section 12.5.5.33](#), “`SHOW PROFILES` Syntax”.) This option was added in MySQL 5.1.24. It is enabled by default as of MySQL 5.1.28; to disable it, use `--disable-profiling`.
- See [Section 2.13](#), “Operating System-Specific Notes”, for options that pertain to particular operating systems.
- See [Section 5.5.7.2](#), “Using SSL Connections”, for options that pertain to configuring MySQL to support secure (encrypted) connections.
- Several `configure` options apply to plugin selection and building:

```
--with-plugins=PLUGIN[ ,PLUGIN]...
--with-plugins=GROUP
--with-plugin-PLUGIN
--without-plugin-PLUGIN
```

`PLUGIN` is an individual plugin name such as `csv` or `archive`.

As shorthand, `GROUP` is a configuration group name such as `none` (select no plugins) or `all` (select all plugins).

You can build a plugin as static (compiled into the server) or dynamic (built as a dynamic library that must be installed using the `INSTALL PLUGIN` statement before it can be used). Some plugins might not support static or dynamic build.

`configure --help` shows the following information pertaining to plugins:

- The plugin-related options
- The names of all available plugins
- For each plugin, a description of its purpose, which build types it supports (static or dynamic), and which plugin groups it is a part of.

`--with-plugins` can take a list of one or more plugin names separated by commas, or a plugin group name. The named plugins are configured to be built as static plugins.

`--with-plugin-PLUGIN` configures the given plugin to be built as a static plugin.

`--without-plugin-PLUGIN` disables the given plugin from being built.

If a plugin is named both with a `--with` and `--without` option, the result is undefined.

For any plugin that is not explicitly selected or disabled, it is selected to be built dynamically if it supports dynamic build, and not built if it does not support dynamic build. (Thus, in the case that no plugin options are given, all plugins that support dynamic build are selected to be built as dynamic plugins. Plugins that do not support dynamic build are not built.)



## 2.10.3. Installing from the Development Source Tree

### Caution

You should read this section only if you are interested in helping us test our new code. If you just want to get MySQL up and running on your system, you should use a standard release distribution (either a binary or source distribution).

To obtain the most recent development source tree, you first need to download and install Bazaar. You can obtain Bazaar from the [Bazaar VCS Website](#). Bazaar is supported by any platform that supports Python, and is therefore compatible with any Linux, Unix, Windows or Mac OS X host. Instructions for downloading and installing Bazaar on the different platforms are available on the Bazaar website.

All MySQL projects are hosted on [Launchpad](#). MySQL projects, including MySQL server, MySQL Workbench and others are available from the [Sun/MySQL Engineering](#) page. For the repositories related only to MySQL server, see the [MySQL Server](#) page.

To build under Unix/Linux, you must have the following tools installed:

- GNU `make`, available from <http://www.gnu.org/software/make/>. Although some platforms come with their own `make` implementations, it is highly recommended that you use GNU `make`. It may already be available on your system as `gmake`.
- `autoconf` 2.58 (or newer), available from <http://www.gnu.org/software/autoconf/>.
- `automake` 1.8.1, available from <http://www.gnu.org/software/automake/>.
- `libtool` 1.5, available from <http://www.gnu.org/software/libtool/>.
- `m4`, available from <http://www.gnu.org/software/m4/>.
- `bison`, available from <http://www.gnu.org/software/bison/>. You should use the latest version of `bison` where possible. Version 1.75 and version 2.1 are known to work. There have been reported problems with `bison` 1.875. If you experience problems, upgrade to a later, rather than earlier, version. Versions of `bison` older than 1.75 may report this error:

```
sql_yacc.yy:#####: fatal error: maximum table size (32767) exceeded
```

The maximum table size is not actually exceeded; the error is caused by bugs in older versions of `bison`.

To build under Windows you will need a copy of Microsoft Visual C++ 2005 Express Edition, Visual Studio .Net 2003 (7.1), or Visual Studio 2005 (8.0) compiler system.

Once you have the necessary tools installed, you first need to create a local branch of the MySQL source code on your machine:

1. To obtain a copy of the MySQL source code, you must create a new Bazaar branch. If you do not already have a Bazaar repository directory set up, you need to initialize a new directory:

```
shell> mkdir mysql-server
shell> bazaar init-repo --trees mysql-server
```

Once you have an initialized directory, you can `branch` from the public MySQL server repositories. To create a branch of a specific version:

```
shell> cd mysql-server
shell> bazaar branch lp:mysql-server/5.1 mysql-5.1
```

The initial download will take some time to complete, depending on the speed of your connection. Please be patient. Once you have downloaded the first tree, additional trees should take significantly less time to download.

When building from the Bazaar branch, you may want to create a copy of your active branch so that you can make configuration and other changes without affecting the original branch contents. You can achieve this by branching from the original branch:

```
shell> bazaar branch mysql-5.1 mysql-5.1-build
```

Once you have the local branch, you can start to build MySQL server from the source code. On Windows, the build process is different from Unix/Linux. To continue building MySQL on Windows, see [Section 2.10.6, "Installing MySQL from Source on Windows"](#).

On Unix/Linux you need to use the `autoconf` system to create the `configure` script so that you can configure the build environment before building.

1. The following example shows the typical commands required to configure a source tree. The first `cd` command changes location into the top-level directory of the tree; replace `mysql-5.1` with the appropriate directory name.

### Note

For MySQL 5.1.12 and earlier, you must separately configure the `INNODB` storage engine. You can do this by running the following command from the main source directory:

```
shell> (cd storage/innobase; autoreconf --force --install)
```

```
shell> cd mysql-5.1
shell> autoreconf --force --install
shell> ./configure # Add your favorite options here
shell> make
```

Or you can use `BUILD/autorun.sh` as a shortcut for the following sequence of commands:

```
shell> aclocal; autoheader
shell> libtoolize --automake --force
shell> automake --force --add-missing; autoconf
```

The command line that changes directory into the `storage/innobase` directory is used to configure the `InnoDB` storage engine. You can omit this line if you do not require `InnoDB` support.

### Note

Beginning with MySQL 5.1, code specific to storage engines has been moved under a `storage` directory. For example, `InnoDB` code is now found in `storage/innobase` and `NDBCLUSTER` code is in `storage/ndb`.

If you get some strange errors during this stage, verify that you have the correct version of the `libtool` installed.

A collection of our standard configuration scripts is located in the `BUILD/` subdirectory. For example, you may find it more convenient to use the `BUILD/compile-pentium-debug` script than the preceding set of shell commands. To compile on a different architecture, modify the script by removing flags that are Pentium-specific, or use another script that may be more appropriate. These scripts are provided on an “as-is” basis. They are not officially maintained and their contents may change from release to release.

2. When the build is done, run `make install`. Be careful with this on a production machine; the command may overwrite your live release installation. If you have another installation of MySQL, we recommend that you run `./configure` with different values for the `--prefix`, `--with-tcp-port`, and `--with-unix-socket-path` options than those used for your production server.
3. Play hard with your new installation and try to make the new features crash. Start by running `make test`. See [Section 21.1.2, “MySQL Test Suite”](#).
4. If you have gotten to the `make` stage, but the distribution does not compile, please enter the problem into our bugs database using the instructions given in [Section 1.6, “How to Report Bugs or Problems”](#). If you have installed the latest versions of the required GNU tools, and they crash trying to process our configuration files, please report that also. However, if you execute `aclocal` and get a `command not found` error or a similar problem, do not report it. Instead, make sure that all the necessary tools are installed and that your `PATH` variable is set correctly so that your shell can find them.
5. After initially copying the repository with `bzr` to obtain the source tree, you should use `pull` option to periodically update your local copy. To do this any time after you have set up the repository, use this command:

```
shell> bzr pull
```

6. You can examine the changeset comments for the tree by using the `log` option to `bzr`:

```
shell> bzr log
```

You can also browse changesets, comments, and source code online. To browse this information for MySQL 5.1, go to <http://launchpad.net/mysql-server/>.

If you see diffs or code that you have a question about, do not hesitate to send email to the MySQL `internals` mailing list. See [Section 1.5.1, “MySQL Mailing Lists”](#). Also, if you think you have a better idea on how to do something, send an email message to the list with a patch.

## 2.10.4. Dealing with Problems Compiling MySQL

All MySQL programs compile cleanly for us with no warnings on Solaris or Linux using `gcc`. On other systems, warnings may occur due to differences in system include files. See [Section 2.10.5, “MIT-pthreads Notes”](#), for warnings that may occur when using MIT-pthreads. For other problems, check the following list.

The solution to many problems involves reconfiguring. If you do need to reconfigure, take note of the following:

- If `configure` is run after it has previously been run, it may use information that was gathered during its previous invocation. This information is stored in `config.cache`. When `configure` starts up, it looks for that file and reads its contents if it exists, on the assumption that the information is still correct. That assumption is invalid when you reconfigure.
- Each time you run `configure`, you must run `make` again to recompile. However, you may want to remove old object files from previous builds first because they were compiled using different configuration options.

To prevent old configuration information or object files from being used, run these commands before re-running `configure`:

```
shell> rm config.cache
shell> make clean
```

Alternatively, you can run `make distclean`.

The following list describes some of the problems when compiling MySQL that have been found to occur most often:

- If you get errors such as the ones shown here when compiling `sql_yacc.cc`, you probably have run out of memory or swap space:

```
Internal compiler error: program cclplus got fatal signal 11
Out of virtual memory
Virtual memory exhausted
```

The problem is that `gcc` requires a huge amount of memory to compile `sql_yacc.cc` with inline functions. Try running `configure` with the `--with-low-memory` option:

```
shell> ./configure --with-low-memory
```

This option causes `-fno-inline` to be added to the compile line if you are using `gcc` and `-O0` if you are using something else. You should try the `--with-low-memory` option even if you have so much memory and swap space that you think you can't possibly have run out. This problem has been observed to occur even on systems with generous hardware configurations, and the `--with-low-memory` option usually fixes it.

- By default, `configure` picks `c++` as the compiler name and GNU `c++` links with `-lg++`. If you are using `gcc`, that behavior can cause problems during configuration such as this:

```
configure: error: installation or configuration problem:
C++ compiler cannot create executables.
```

You might also observe problems during compilation related to `g++`, `libg++`, or `libstdc++`.

One cause of these problems is that you may not have `g++`, or you may have `g++` but not `libg++`, or `libstdc++`. Take a look at the `config.log` file. It should contain the exact reason why your C++ compiler didn't work. To work around these problems, you can use `gcc` as your C++ compiler. Try setting the environment variable `CXX` to `"gcc -O3"`. For example:

```
shell> CXX="gcc -O3" ./configure
```

This works because `gcc` compiles C++ source files as well as `g++` does, but does not link in `libg++` or `libstdc++` by default.

Another way to fix these problems is to install `g++`, `libg++`, and `libstdc++`. However, we recommend that you not use `libg++` or `libstdc++` with MySQL because this only increases the binary size of `mysqld` without providing any benefits. Some versions of these libraries have also caused strange problems for MySQL users in the past.

- If your compile fails with errors such as any of the following, you must upgrade your version of `make` to GNU `make`:

```
making all in mit-pthreads
make: Fatal error in reader: Makefile, line 18:
Badly formed macro assignment
```

Or:

```
make: file `Makefile' line 18: Must be a separator (:
```

Or:

```
pthread.h: No such file or directory
```

Solaris and FreeBSD are known to have troublesome `make` programs.

GNU `make` 3.75 is known to work.

- If you want to define flags to be used by your C or C++ compilers, do so by adding the flags to the `CFLAGS` and `CXXFLAGS` environment variables. You can also specify the compiler names this way using `CC` and `CXX`. For example:

```
shell> CC=gcc
shell> CFLAGS=-O3
shell> CXX=gcc
shell> CXXFLAGS=-O3
shell> export CC CFLAGS CXX CXXFLAGS
```

See Section 2.1.2.4, “MySQL Binaries Compiled by Sun Microsystems, Inc.”, for a list of flag definitions that have been found to be useful on various systems.

- If you get errors such as those shown here when compiling `mysqld`, `configure` did not correctly detect the type of the last argument to `accept()`, `getsockname()`, or `getpeername()`:

```
cxx: Error: mysqld.cc, line 645: In this statement, the referenced
      type of the pointer value 'length' is 'unsigned long',
      which is not compatible with 'int'.
new_sock = accept(sock, (struct sockaddr *)&cAddr, &length);
```

To fix this, edit the `config.h` file (which is generated by `configure`). Look for these lines:

```
/* Define as the base type of the last arg to accept */
#define SOCKET_SIZE_TYPE XXX
```

Change `XXX` to `size_t` or `int`, depending on your operating system. (You must do this each time you run `configure` because `configure` regenerates `config.h`.)

- The `sql_yacc.cc` file is generated from `sql_yacc.yy`. Normally, the build process does not need to create `sql_yacc.cc` because MySQL comes with a pre-generated copy. However, if you do need to re-create it, you might encounter this error:

```
"sql_yacc.yy", line xxx fatal: default action causes potential...
```

This is a sign that your version of `yacc` is deficient. You probably need to install `bison` (the GNU version of `yacc`) and use that instead.

- On Debian Linux 3.0, you need to install `gawk` instead of the default `mawk`.
- If you need to debug `mysqld` or a MySQL client, run `configure` with the `--with-debug` option, and then recompile and link your clients with the new client library. See [MySQL Internals: Porting](#).
- If you get a compilation error on Linux (for example, SuSE Linux 8.1 or Red Hat Linux 7.3) similar to the following one, you probably do not have `g++` installed:

```
libmysql.c:1329: warning: passing arg 5 of `gethostbyname_r' from
incompatible pointer type
libmysql.c:1329: too few arguments to function `gethostbyname_r'
libmysql.c:1329: warning: assignment makes pointer from integer
without a cast
make[2]: *** [libmysql.lo] Error 1
```

By default, the `configure` script attempts to determine the correct number of arguments by using `g++` (the GNU C++ compiler). This test yields incorrect results if `g++` is not installed. There are two ways to work around this problem:

- Make sure that the GNU C++ `g++` is installed. On some Linux distributions, the required package is called `gpp`; on others, it is named `gcc-c++`.
- Use `gcc` as your C++ compiler by setting the `CXX` environment variable to `gcc`:

```
export CXX="gcc"
```

You must run `configure` again after making either of those changes.

## 2.10.5. MIT-pthreads Notes

This section describes some of the issues involved in using MIT-pthreads.

On Linux, you should *not* use MIT-pthreads. Use the installed LinuxThreads implementation instead. See [Section 2.13.1, “Linux Notes”](#).

If your system does not provide native thread support, you should build MySQL using the MIT-pthreads package. This includes older FreeBSD systems, SunOS 4.x, Solaris 2.4 and earlier, and some others. See [Section 2.1.1, “Operating Systems Supported by MySQL Community Server”](#).

MIT-pthreads is not part of the MySQL 5.1 source distribution. If you require this package, you need to download it separately from [http://dev.mysql.com/Downloads/Contrib/pthreads-1\\_60\\_beta6-mysql.tar.gz](http://dev.mysql.com/Downloads/Contrib/pthreads-1_60_beta6-mysql.tar.gz)

After downloading, extract this source archive into the top level of the MySQL source directory. It creates a new subdirectory named `mit-pthreads`.

- On most systems, you can force MIT-pthreads to be used by running `configure` with the `--with-mit-threads` option:

```
shell> ./configure --with-mit-threads
```

Building in a non-source directory is not supported when using MIT-pthreads because we want to minimize our changes to this code.

- The checks that determine whether to use MIT-pthreads occur only during the part of the configuration process that deals with the server code. If you have configured the distribution using `--without-server` to build only the client code, clients do not know whether MIT-pthreads is being used and use Unix socket file connections by default. Because Unix socket files do not work under MIT-pthreads on some platforms, this means you need to use `-h` or `--host` with a value other than `localhost` when you run client programs.
- When MySQL is compiled using MIT-pthreads, system locking is disabled by default for performance reasons. You can tell the server to use system locking with the `--external-locking` option. This is needed only if you want to be able to run two MySQL servers against the same data files, but that is not recommended, anyway.
- Sometimes the pthread `bind()` command fails to bind to a socket without any error message (at least on Solaris). The result is that all connections to the server fail. For example:

```
shell> mysqladmin version
mysqladmin: connect to server at '' failed;
error: 'Can't connect to mysql server on localhost (146)'
```

The solution to this problem is to kill the `mysqld` server and restart it. This has happened to us only when we have forcibly stopped the server and restarted it immediately.

- With MIT-pthreads, the `sleep()` system call isn't interruptible with `SIGINT` (break). This is noticeable only when you run `mysqladmin --sleep`. You must wait for the `sleep()` call to terminate before the interrupt is served and the process stops.
- When linking, you might receive warning messages like these (at least on Solaris); they can be ignored:

```
ld: warning: symbol `__iob' has differing sizes:
  (file /my/local/pthreads/lib/libpthread.a(findfp.o) value=0x4;
file /usr/lib/libc.so value=0x140);
/my/local/pthreads/lib/libpthread.a(findfp.o) definition taken
ld: warning: symbol `__iob' has differing sizes:
  (file /my/local/pthreads/lib/libpthread.a(findfp.o) value=0x4;
file /usr/lib/libc.so value=0x140);
/my/local/pthreads/lib/libpthread.a(findfp.o) definition taken
```

- Some other warnings also can be ignored:

```
implicit declaration of function `int strtoll(...)'
implicit declaration of function `int strtoul(...)'
```

- We have not been able to make `readline` work with MIT-pthreads. (This is not necessary, but may be of interest to some.)

## 2.10.6. Installing MySQL from Source on Windows

These instructions describe how to build binaries from source for MySQL 5.1 on Windows. Instructions are provided for building binaries from a standard source distribution or from the Bazaar tree that contains the latest development source.

### Note

The instructions here are strictly for users who want to test MySQL on Microsoft Windows from the latest source distribution or from the Bazaar tree. For production use, we do not advise using a MySQL server built by yourself from source. Normally, it is best to use precompiled binary distributions of MySQL that are built specifically for optimal performance on Windows by Sun Microsystems, Inc. Instructions for installing binary distributions are available in [Section 2.3, “Installing MySQL on Windows”](#).

To build MySQL on Windows from source, you must satisfy the following system, compiler, and resource requirements:

- Windows 2000, Windows XP, or newer version.

Windows Vista is supported when using Visual Studio 2005 provided you have installed the following updates:

- [Microsoft Visual Studio 2005 Professional Edition - ENU Service Pack 1 \(KB926601\)](#)
- [Security Update for Microsoft Visual Studio 2005 Professional Edition - ENU \(KB937061\)](#)
- [Update for Microsoft Visual Studio 2005 Professional Edition - ENU \(KB932232\)](#)
- CMake, which can be downloaded from <http://www.cmake.org>. After installing, modify your path to include the `cmake` binary.
- Microsoft Visual C++ 2005 Express Edition, Visual Studio .Net 2003 (7.1), or Visual Studio 2005 (8.0) compiler system.
- If you are using Visual C++ 2005 Express Edition, you must also install an appropriate Platform SDK. More information and links to downloads for various Windows platforms is available from <http://www.microsoft.com/downloads/details.aspx?familyid=0baf2b35-c656-4969-ace8-e4c0c0716adb>.
- If you are compiling from a Bazaar tree or making changes to the parser, you need `bison` for Windows, which can be downloaded from <http://gnuwin32.sourceforge.net/packages/bison.htm>. Download the package labeled “Complete package, excluding sources”. After installing the package, modify your path to include the `bison` binary and ensure that this binary is accessible from Visual Studio.
- Cygwin might be necessary if you want to run the test script or package the compiled binaries and support files into a Zip archive. (Cygwin is needed only to test or package the distribution, not to build it.) Cygwin is available from <http://cygwin.com>.
- 3GB to 5GB of disk space.

The exact system requirements can be found here: <http://msdn.microsoft.com/vstudio/Previous/2003/sysreqs/default.aspx> and <http://msdn.microsoft.com/vstudio/products/sysreqs/default.aspx>

You also need a MySQL source distribution for Windows, which can be obtained two ways:

- Obtain a source distribution packaged by Sun Microsystems, Inc. These are available from <http://dev.mysql.com/downloads/>.
- Package a source distribution yourself from the latest Bazaar developer source tree. For instructions on pulling the latest source files, see [Section 2.10.3, “Installing from the Development Source Tree”](#).

If you find something not working as expected, or you have suggestions about ways to improve the current build process on Windows, please send a message to the `win32` mailing list. See [Section 1.5.1, “MySQL Mailing Lists”](#).

### 2.10.6.1. Building MySQL from Source Using CMake and Visual Studio

You can build MySQL on Windows by using a combination of `cmake` and Microsoft Visual Studio .NET 2003 (7.1), Microsoft Visual Studio 2005 (8.0) or Microsoft Visual C++ 2005 Express Edition. You must have the appropriate Microsoft Platform SDK installed.

**Note**

To compile from the source code on Windows you must use the standard source distribution (for example, `mysql-5.0.45.tar.gz`). You build from the same distribution as used to build MySQL on Unix, Linux and other platforms. Do *not* use the Windows Source distributions as they do not contain the necessary configuration script and other files.

Follow this procedure to build MySQL:

1. If you are installing from a packaged source distribution, create a work directory (for example, `C:\workdir`), and unpack the source distribution there using WinZip or another Windows tool that can read `.zip` files. This directory is the work directory in the following instructions.
2. Using a command shell, navigate to the work directory and run the following command:

```
C:\workdir>win\configure.js options
```

If you have associated the `.js` file extension with an application such as a text editor, then you may need to use the following command to force `configure.js` to be executed as a script:

```
C:\workdir>cscript win\configure.js options
```

These options are available for `configure.js`:

- `WITH_INNOBASE_STORAGE_ENGINE`: Enable the InnoDB storage engine.
- `WITH_PARTITION_STORAGE_ENGINE`: Enable user-defined partitioning.
- `WITH_ARCHIVE_STORAGE_ENGINE`: Enable the ARCHIVE storage engine.
- `WITH_BLACKHOLE_STORAGE_ENGINE`: Enable the BLACKHOLE storage engine.
- `WITH_EXAMPLE_STORAGE_ENGINE`: Enable the EXAMPLE storage engine.
- `WITH_FEDERATED_STORAGE_ENGINE`: Enable the FEDERATED storage engine.
- `WITH_NDBCLUSTER_STORAGE_ENGINE` (*experimental*): Enable the NDBCLUSTER storage engine in the MySQL server; cause binaries for the MySQL Cluster management and data node, management client, and other programs to be built.

This option is supported only in MySQL Cluster NDB 7.0 (NDBCLUSTER storage engine versions 6.4.0 and later) using the MySQL Cluster sources. It cannot be used to enable clustering support in other MySQL source trees or distributions.

- `MYSQL_SERVER_SUFFIX=suffix`: Server suffix, default none.
- `COMPILATION_COMMENT=comment`: Server comment, default "Source distribution".
- `MYSQL_TCP_PORT=port`: Server port, default 3306.
- `DISABLE_GRANT_OPTIONS`: Disables the `--bootstrap`, `--skip-grant-tables`, and `--init-file` options for `mysqld`. This option is available as of MySQL 5.1.15.

For example (type the command on one line):

```
C:\workdir>win\configure.js WITH_INNOBASE_STORAGE_ENGINE
WITH_PARTITION_STORAGE_ENGINE MYSQL_SERVER_SUFFIX=-pro
```

3. From the work directory, execute the `win\build-vs8.bat` or `win\build-vs71.bat` file, depending on the version of Visual Studio you have installed. The script invokes CMake, which generates the `mysql.sln` solution file.

You can also use `win\build-vs8_x64.bat` to build the 64-bit version of MySQL. However, you cannot build the 64-bit version with Visual Studio Express Edition. You must use Visual Studio 2005 (8.0) or higher.

4. From the work directory, open the generated `mysql.sln` file with Visual Studio and select the proper configuration using the `CONFIGURATION` menu. The menu provides Debug, Release, RelwithDebInfo, MinRelInfo options. Then select `SOLUTION > Build` to build the solution.

Remember the configuration that you use in this step. It is important later when you run the test script because that script needs to know which configuration you used.



5. Test the server. The server built using the preceding instructions expects that the MySQL base directory and data directory are `C:\mysql` and `C:\mysql\data` by default. If you want to test your server using the source tree root directory and its data directory as the base directory and data directory, you need to tell the server their path names. You can either do this on the command line with the `--basedir` and `--datadir` options, or by placing appropriate options in an option file. (See [Section 4.2.3.2, “Using Option Files”](#).) If you have an existing data directory elsewhere that you want to use, you can specify its path name instead.

When the server is running in standalone fashion or as a service based on your configuration, try to connect to it from the `mysql` interactive command-line utility.

You can also run the standard test script, `mysql-test-run.pl`. This script is written in Perl, so you'll need either Cygwin or ActiveState Perl to run it. You may also need to install the modules required by the script. To run the test script, change location into the `mysql-test` directory under the work directory, set the `MTR_VS_CONFIG` environment variable to the configuration you selected earlier (or use the `--vs-config` option), and invoke `mysql-test-run.pl`. For example (using Cygwin and the `bash` shell):

```
shell> cd mysql-test
shell> export MTR_VS_CONFIG=debug
shell> ./mysql-test-run.pl --force --timer
shell> ./mysql-test-run.pl --force --timer --ps-protocol
```

When you are satisfied that the programs you have built are working correctly, stop the server. Now you can install the distribution. One way to do this is to use the `make_win_bin_dist` script in the `scripts` directory of the MySQL source distribution (see [Section 4.4.2, “make\\_win\\_bin\\_dist — Package MySQL Distribution as ZIP Archive”](#)). This is a shell script, so you must have Cygwin installed if you want to use it. It creates a Zip archive of the built executables and support files that you can unpack in the location at which you want to install MySQL.

It is also possible to install MySQL by copying directories and files directly:

1. Create the directories where you want to install MySQL. For example, to install into `C:\mysql`, use these commands:

```
C:\> mkdir C:\mysql
C:\> mkdir C:\mysql\bin
C:\> mkdir C:\mysql\data
C:\> mkdir C:\mysql\share
C:\> mkdir C:\mysql\scripts
```

If you want to compile other clients and link them to MySQL, you should also create several additional directories:

```
C:\> mkdir C:\mysql\include
C:\> mkdir C:\mysql\lib
C:\> mkdir C:\mysql\lib\debug
C:\> mkdir C:\mysql\lib\opt
```

If you want to benchmark MySQL, create this directory:

```
C:\> mkdir C:\mysql\sql-bench
```

Benchmarking requires Perl support. See [Section 2.15, “Perl Installation Notes”](#).

2. From the work directory, copy into the `C:\mysql` directory the following directories:

```
C:\> cd \workdir
C:\workdir> copy client_release\*.exe C:\mysql\bin
C:\workdir> copy client_debug\mysqld.exe C:\mysql\bin\mysqld-debug.exe
C:\workdir> xcopy scripts\*. * C:\mysql\scripts /E
C:\workdir> xcopy share\*. * C:\mysql\share /E
```

If you want to compile other clients and link them to MySQL, you should also copy several libraries and header files:

```
C:\workdir> copy lib_debug\mysqlclient.lib C:\mysql\lib\debug
C:\workdir> copy lib_debug\libmysql.* C:\mysql\lib\debug
C:\workdir> copy lib_debug\zlib.* C:\mysql\lib\debug
C:\workdir> copy lib_release\mysqlclient.lib C:\mysql\lib\opt
C:\workdir> copy lib_release\libmysql.* C:\mysql\lib\opt
C:\workdir> copy lib_release\zlib.* C:\mysql\lib\opt
C:\workdir> copy include\*.h C:\mysql\include
C:\workdir> copy libmysql\libmysql.def C:\mysql\include
```

If you want to benchmark MySQL, you should also do this:

```
C:\workdir> xcopy sql-bench\*. * C:\mysql\bench /E
```

After installation, set up and start the server in the same way as for binary Windows distributions. See [Section 2.3, “Installing MySQL on Windows”](#).

## 2.10.7. Compiling MySQL Clients on Windows

In your source files, you should include `my_global.h` before `mysql.h`:

```
#include <my_global.h>
#include <mysql.h>
```

`my_global.h` includes any other files needed for Windows compatibility (such as `windows.h`) if you compile your program on Windows.

You can either link your code with the dynamic `libmysql.lib` library, which is just a wrapper to load in `libmysql.dll` on demand, or link with the static `mysqlclient.lib` library.

The MySQL client libraries are compiled as threaded libraries, so you should also compile your code to be multi-threaded.

## 2.11. Post-Installation Setup and Testing

After installing MySQL, there are some issues that you should address. For example, on Unix, you should initialize the data directory and create the MySQL grant tables. On all platforms, an important security concern is that the initial accounts in the grant tables have no passwords. You should assign passwords to prevent unauthorized access to the MySQL server. Optionally, you can create time zone tables to enable recognition of named time zones.

The following sections include post-installation procedures that are specific to Windows systems and to Unix systems. Another section, [Section 2.11.2.3, “Starting and Troubleshooting the MySQL Server”](#), applies to all platforms; it describes what to do if you have trouble getting the server to start. [Section 2.11.3, “Securing the Initial MySQL Accounts”](#), also applies to all platforms. You should follow its instructions to make sure that you have properly protected your MySQL accounts by assigning passwords to them.

When you are ready to create additional user accounts, you can find information on the MySQL access control system and account management in [Section 5.4, “The MySQL Access Privilege System”](#), and [Section 5.5, “MySQL User Account Management”](#).

### 2.11.1. Windows Post-Installation Procedures

On Windows, the data directory and the grant tables do not have to be created. MySQL Windows distributions include the grant tables with a set of preinitialized accounts in the `mysql` database under the data directory. It is unnecessary to run the `mysql_install_db` script that is used on Unix. Regarding passwords, if you installed MySQL using the Windows Installation Wizard, you may have already assigned passwords to the accounts. (See [Section 2.3.3, “Using the MySQL Installation Wizard”](#).) Otherwise, use the password-assignment procedure given in [Section 2.11.3, “Securing the Initial MySQL Accounts”](#).

Before setting up passwords, you might want to try running some client programs to make sure that you can connect to the server and that it is operating properly. Make sure that the server is running (see [Section 2.3.9, “Starting the Server for the First Time”](#)), and then issue the following commands to verify that you can retrieve information from the server. The output should be similar to what is shown here:

```
C:\> C:\mysql\bin\mysqlshow
+-----+
| Databases |
+-----+
| information_schema |
| mysql |
| test |
+-----+

C:\> C:\mysql\bin\mysqlshow mysql
Database: mysql
+-----+
| Tables |
+-----+
| columns_priv |
| db |
| event |
| func |
| general_log |
| help_category |
| help_keyword |
| help_relation |
| help_topic |
| host |
| plugin |
| proc |
| procs_priv |
| servers |
| slow_log |
| tables_priv |
```

```

time_zone
time_zone_leap_second
time_zone_name
time_zone_transition
time_zone_transition_type
user
+-----+
C:\> C:\mysql\bin\mysql -e "SELECT Host,Db,User FROM db" mysql
+-----+-----+-----+
| host | db   | user |
+-----+-----+-----+
| %    | test% |      |
+-----+-----+-----+

```

You may need to specify a different directory from the one shown; if you used the Windows Installation Wizard, then the default directory is `C:\Program Files\MySQL\MySQL Server 5.1`, and the `mysql` and `mysqlshow` client programs are in `C:\Program Files\MySQL\MySQL Server 5.1\bin`. See [Section 2.3.3, “Using the MySQL Installation Wizard”](#), for more information.

If you have already secured the initial MySQL accounts, you may need to use the `-u` and `-p` options to supply a user name and password to the `mysqlshow` and `mysql` client programs; otherwise the programs may fail with an error, or you may not be able to view all databases. For example, if you have assigned the password “secretpass” to the MySQL `root` account, then you can invoke `mysqlshow` and `mysql` as shown here:

```

C:\> C:\mysql\bin\mysqlshow -uroot -psecretpass
+-----+
| Databases |
+-----+
| information_schema |
| mysql              |
| test               |
+-----+

C:\> C:\mysql\bin\mysqlshow -uroot -psecretpass mysql
Database: mysql
+-----+
| Tables |
+-----+
| columns_priv |
| db           |
| event        |
| func         |
| general_log  |
| help_category |
| help_keyword |
| help_relation |
| help_topic   |
| host         |
| plugin       |
| proc         |
| procs_priv   |
| servers      |
| slow_log     |
| tables_priv  |
| time_zone    |
| time_zone_leap_second |
| time_zone_name |
| time_zone_transition |
| time_zone_transition_type |
| user         |
+-----+

C:\> C:\mysql\bin\mysql -uroot -psecretpass -e "SELECT Host,Db,User FROM db" mysql
+-----+-----+-----+
| host | db   | user |
+-----+-----+-----+
| %    | test% |      |
+-----+-----+-----+

```

For more information about these programs, see [Section 4.5.6, “mysqlshow — Display Database, Table, and Column Information”](#), and [Section 4.5.1, “mysql — The MySQL Command-Line Tool”](#).

If you are running a version of Windows that supports services and you want the MySQL server to run automatically when Windows starts, see [Section 2.3.11, “Starting MySQL as a Windows Service”](#).

## 2.11.2. Unix Post-Installation Procedures

After installing MySQL on Unix, you need to initialize the grant tables, start the server, and make sure that the server works satisfactorily. You may also wish to arrange for the server to be started and stopped automatically when your system starts and stops. You should also assign passwords to the accounts in the grant tables.

On Unix, the grant tables are set up by the `mysql_install_db` program. For some installation methods, this program is run for you automatically:

- If you install MySQL on Linux using RPM distributions, the server RPM runs `mysql_install_db`.
- If you install MySQL on Mac OS X using a PKG distribution, the installer runs `mysql_install_db`.

Otherwise, you'll need to run `mysql_install_db` yourself.

The following procedure describes how to initialize the grant tables (if that has not previously been done) and then start the server. It also suggests some commands that you can use to test whether the server is accessible and working properly. For information about starting and stopping the server automatically, see [Section 2.11.2.2, “Starting and Stopping MySQL Automatically”](#).

After you complete the procedure and have the server running, you should assign passwords to the accounts created by `mysql_install_db`. Instructions for doing so are given in [Section 2.11.3, “Securing the Initial MySQL Accounts”](#).

In the examples shown here, the server runs under the user ID of the `mysql` login account. This assumes that such an account exists. Either create the account if it does not exist, or substitute the name of a different existing login account that you plan to use for running the server.

1. Change location into the top-level directory of your MySQL installation, represented here by `BASEDIR`:

```
shell> cd BASEDIR
```

`BASEDIR` is likely to be something like `/usr/local/mysql` or `/usr/local`. The following steps assume that you are located in this directory.

2. If necessary, run the `mysql_install_db` program to set up the initial MySQL grant tables containing the privileges that determine how users are allowed to connect to the server. You'll need to do this if you used a distribution type for which the installation procedure doesn't run the program for you.

Typically, `mysql_install_db` needs to be run only the first time you install MySQL, so you can skip this step if you are upgrading an existing installation. However, `mysql_install_db` does not overwrite any existing privilege tables, so it should be safe to run in any circumstances.

To initialize the grant tables, use one of the following commands, depending on whether `mysql_install_db` is located in the `bin` or `scripts` directory:

```
shell> bin/mysql_install_db --user=mysql
shell> scripts/mysql_install_db --user=mysql
```

It might be necessary to specify other options such as `--basedir` or `--datadir` if `mysql_install_db` does not use the correct locations for the installation directory or data directory. For example:

```
shell> bin/mysql_install_db --user=mysql \
      --basedir=/opt/mysql/mysql \
      --datadir=/opt/mysql/mysql/data
```

The `mysql_install_db` script creates the server's data directory. Under the data directory, it creates directories for the `mysql` database that holds all database privileges and the `test` database that you can use to test MySQL. The script also creates privilege table entries for `root` and anonymous-user accounts. The accounts have no passwords initially. A description of their initial privileges is given in [Section 2.11.3, “Securing the Initial MySQL Accounts”](#). Briefly, these privileges allow the MySQL `root` user to do anything, and allow anybody to create or use databases with a name of `test` or starting with `test_`.

It is important to make sure that the database directories and files are owned by the `mysql` login account so that the server has read and write access to them when you run it later. To ensure this, the `--user` option should be used as shown if you run `mysql_install_db` as `root`. Otherwise, you should execute the script while logged in as `mysql`, in which case you can omit the `--user` option from the command.

`mysql_install_db` creates several tables in the `mysql` database, including `user`, `db`, `host`, `tables_priv`, `columns_priv`, `func`, and others. See [Section 5.4, “The MySQL Access Privilege System”](#), for a complete listing and description of these tables.

If you don't want to have the `test` database, you can remove it with `mysqladmin -u root drop test` after starting the server.

If you have trouble with `mysql_install_db` at this point, see [Section 2.11.2.1, “Problems Running mysql\\_install\\_db”](#).

3. Start the MySQL server:

```
shell> bin/mysqld_safe --user=mysql &
```

It is important that the MySQL server be run using an unprivileged (non-`root`) login account. To ensure this, the `--user` option should be used as shown if you run `mysqld_safe` as system `root`. Otherwise, you should execute the script while logged in to the system as `mysql`, in which case you can omit the `--user` option from the command.

Further instructions for running MySQL as an unprivileged user are given in [Section 5.3.5, “How to Run MySQL as a Normal User”](#).

If you neglected to create the grant tables before proceeding to this step, the following message appears in the error log file when you start the server:

```
mysqld: Can't find file: 'host.frm'
```

If you have other problems starting the server, see [Section 2.11.2.3, “Starting and Troubleshooting the MySQL Server”](#).

4. Use `mysqladmin` to verify that the server is running. The following commands provide simple tests to check whether the server is up and responding to connections:

```
shell> bin/mysqladmin version
shell> bin/mysqladmin variables
```

The output from `mysqladmin version` varies slightly depending on your platform and version of MySQL, but should be similar to that shown here:

```
shell> bin/mysqladmin version
mysqladmin Ver 14.12 Distrib 5.1.36, for pc-linux-gnu on i686
...
Server version          5.1.36
Protocol version        10
Connection              Localhost via UNIX socket
UNIX socket             /var/lib/mysql/mysql.sock
Uptime:                 14 days 5 hours 5 min 21 sec

Threads: 1  Questions: 366  Slow queries: 0
Opens: 0  Flush tables: 1  Open tables: 19
Queries per second avg: 0.000
```

To see what else you can do with `mysqladmin`, invoke it with the `--help` option.

5. Verify that you can shut down the server:

```
shell> bin/mysqladmin -u root shutdown
```

6. Verify that you can start the server again. Do this by using `mysqld_safe` or by invoking `mysqld` directly. For example:

```
shell> bin/mysqld_safe --user=mysql --log &
```

If `mysqld_safe` fails, see [Section 2.11.2.3, “Starting and Troubleshooting the MySQL Server”](#).

7. Run some simple tests to verify that you can retrieve information from the server. The output should be similar to what is shown here:

```
shell> bin/mysqlshow
+-----+
| Databases |
+-----+
| mysql    |
| test     |
+-----+

shell> bin/mysqlshow mysql
Database: mysql
+-----+
| Tables |
+-----+
| columns_priv |
| db           |
| func         |
| help_category |
| help_keyword |
| help_relation |
| help_topic   |
| host         |
| proc         |
| procs_priv   |
```

```

tables_priv
time_zone
time_zone_leap_second
time_zone_name
time_zone_transition
time_zone_transition_type
user
+-----+
shell> bin/mysql -e "SELECT Host,Db,User FROM db" mysql
+-----+-----+-----+
| host | db | user |
+-----+-----+-----+
| % | test |  |
| % | test_% |  |
+-----+-----+-----+

```

- There is a benchmark suite in the `sql-bench` directory (under the MySQL installation directory) that you can use to compare how MySQL performs on different platforms. The benchmark suite is written in Perl. It requires the Perl DBI module that provides a database-independent interface to the various databases, and some other additional Perl modules:

```

DBI
DBD:mysql
Data:Dumper
Data:ShowTable

```

These modules can be obtained from CPAN (<http://www.cpan.org/>). See also [Section 2.15.1, “Installing Perl on Unix”](#).

The `sql-bench/Results` directory contains the results from many runs against different databases and platforms. To run all tests, execute these commands:

```

shell> cd sql-bench
shell> perl run-all-tests

```

If you don't have the `sql-bench` directory, you probably installed MySQL using RPM files other than the source RPM. (The source RPM includes the `sql-bench` benchmark directory.) In this case, you must first install the benchmark suite before you can use it. There are separate benchmark RPM files named `mysql-bench-VERSION.i386.rpm` that contain benchmark code and data.

If you have a source distribution, there are also tests in its `tests` subdirectory that you can run. For example, to run `auto_increment.tst`, execute this command from the top-level directory of your source distribution:

```

shell> mysql -vfv test < ./tests/auto_increment.tst

```

The expected result of the test can be found in the `./tests/auto_increment.res` file.

- At this point, you should have the server running. However, none of the initial MySQL accounts have a password, so you should assign passwords using the instructions found in [Section 2.11.3, “Securing the Initial MySQL Accounts”](#).

The MySQL 5.1 installation procedure creates time zone tables in the `mysql` database. However, you must populate the tables manually using the instructions in [Section 9.7, “MySQL Server Time Zone Support”](#).

### 2.11.2.1. Problems Running `mysql_install_db`

The purpose of the `mysql_install_db` script is to generate new MySQL privilege tables. It does not overwrite existing MySQL privilege tables, and it does not affect any other data.

If you want to re-create your privilege tables, first stop the `mysqld` server if it is running. Then rename the `mysql` directory under the data directory to save it, and then run `mysql_install_db`. Suppose that your current directory is the MySQL installation directory and that `mysql_install_db` is located in the `bin` directory and the data directory is named `data`. To rename the `mysql` database and re-run `mysql_install_db`, use these commands.

```

shell> mv data/mysql data/mysql.old
shell> bin/mysql_install_db --user=mysql

```

When you run `mysql_install_db`, you might encounter the following problems:

- `mysql_install_db` fails to install the grant tables**

You may find that `mysql_install_db` fails to install the grant tables and terminates after displaying the following messages:

```
Starting mysqld daemon with databases from XXXXXX
mysqld ended
```

In this case, you should examine the error log file very carefully. The log should be located in the directory `XXXXXX` named by the error message and should indicate why `mysqld` didn't start. If you do not understand what happened, include the log when you post a bug report. See [Section 1.6, “How to Report Bugs or Problems”](#).

- **There is a `mysqld` process running**

This indicates that the server is running, in which case the grant tables have probably been created already. If so, there is no need to run `mysql_install_db` at all because it needs to be run only once (when you install MySQL the first time).

- **Installing a second `mysqld` server does not work when one server is running**

This can happen when you have an existing MySQL installation, but want to put a new installation in a different location. For example, you might have a production installation, but you want to create a second installation for testing purposes. Generally the problem that occurs when you try to run a second server is that it tries to use a network interface that is in use by the first server. In this case, you should see one of the following error messages:

```
Can't start server: Bind on TCP/IP port:
Address already in use
Can't start server: Bind on unix socket...
```

For instructions on setting up multiple servers, see [Section 5.6, “Running Multiple MySQL Servers on the Same Machine”](#).

- **You do not have write access to the `/tmp` directory**

If you do not have write access to create temporary files or a Unix socket file in the default location (the `/tmp` directory), an error occurs when you run `mysql_install_db` or the `mysqld` server.

You can specify different locations for the temporary directory and Unix socket file by executing these commands prior to starting `mysql_install_db` or `mysqld`, where `some_tmp_dir` is the full path name to some directory for which you have write permission:

```
shell> TMPDIR=/some_tmp_dir/
shell> MYSQL_UNIX_PORT=/some_tmp_dir/mysql.sock
shell> export TMPDIR MYSQL_UNIX_PORT
```

Then you should be able to run `mysql_install_db` and start the server with these commands:

```
shell> bin/mysql_install_db --user=mysql
shell> bin/mysqld_safe --user=mysql &
```

If `mysql_install_db` is located in the `scripts` directory, modify the first command to `scripts/mysql_install_db`.

See [Section B.1.4.5, “How to Protect or Change the MySQL Unix Socket File”](#), and [Section 2.14, “Environment Variables”](#).

There are some alternatives to running the `mysql_install_db` script provided in the MySQL distribution:

- If you want the initial privileges to be different from the standard defaults, you can modify `mysql_install_db` before you run it. However, it is preferable to use `GRANT` and `REVOKE` to change the privileges *after* the grant tables have been set up. In other words, you can run `mysql_install_db`, and then use `mysql -u root mysql` to connect to the server as the MySQL `root` user so that you can issue the necessary `GRANT` and `REVOKE` statements.

If you want to install MySQL on several machines with the same privileges, you can put the `GRANT` and `REVOKE` statements in a file and execute the file as a script using `mysql` after running `mysql_install_db`. For example:

```
shell> bin/mysql_install_db --user=mysql
shell> bin/mysql -u root < your_script_file
```

By doing this, you can avoid having to issue the statements manually on each machine.

- It is possible to re-create the grant tables completely after they have previously been created. You might want to do this if you're just learning how to use `GRANT` and `REVOKE` and have made so many modifications after running `mysql_install_db` that you want to wipe out the tables and start over.

To re-create the grant tables, remove all the `.frm`, `.MYI`, and `.MYD` files in the `mysql` database directory. Then run the



`mysql_install_db` script again.

- You can start `mysqld` manually using the `--skip-grant-tables` option and add the privilege information yourself using `mysql`:

```
shell> bin/mysqld_safe --user=mysql --skip-grant-tables &
shell> bin/mysql mysql
```

From `mysql`, manually execute the SQL commands contained in `mysql_install_db`. Make sure that you run `mysqladmin flush-privileges` or `mysqladmin reload` afterward to tell the server to reload the grant tables.

Note that by not using `mysql_install_db`, you not only have to populate the grant tables manually, you also have to create them first.

## 2.11.2.2. Starting and Stopping MySQL Automatically

Generally, you start the `mysqld` server in one of these ways:

- By invoking `mysqld` directly. This works on any platform.
- By running the MySQL server as a Windows service. The service can be set to start the server automatically when Windows starts, or as a manual service that you start on request. For instructions, see [Section 2.3.11, “Starting MySQL as a Windows Service”](#).
- By invoking `mysqld_safe`, which tries to determine the proper options for `mysqld` and then runs it with those options. This script is used on Unix and Unix-like systems. See [Section 4.3.2, “mysqld\\_safe — MySQL Server Startup Script”](#).
- By invoking `mysql.server`. This script is used primarily at system startup and shutdown on systems that use System V-style run directories, where it usually is installed under the name `mysql`. The `mysql.server` script starts the server by invoking `mysqld_safe`. See [Section 4.3.3, “mysql.server — MySQL Server Startup Script”](#).
- On Mac OS X, you can install a separate MySQL Startup Item package to enable the automatic startup of MySQL on system startup. The Startup Item starts the server by invoking `mysql.server`. See [Section 2.5, “Installing MySQL on Mac OS X”](#), for details.

The `mysqld_safe` and `mysql.server` scripts and the Mac OS X Startup Item can be used to start the server manually, or automatically at system startup time. `mysql.server` and the Startup Item also can be used to stop the server.

To start or stop the server manually using the `mysql.server` script, invoke it with `start` or `stop` arguments:

```
shell> mysql.server start
shell> mysql.server stop
```

Before `mysql.server` starts the server, it changes location to the MySQL installation directory, and then invokes `mysqld_safe`. If you want the server to run as some specific user, add an appropriate `user` option to the `[mysqld]` group of the `/etc/my.cnf` option file, as shown later in this section. (It is possible that you will need to edit `mysql.server` if you've installed a binary distribution of MySQL in a non-standard location. Modify it to `cd` into the proper directory before it runs `mysqld_safe`. If you do this, your modified version of `mysql.server` may be overwritten if you upgrade MySQL in the future, so you should make a copy of your edited version that you can reinstall.)

`mysql.server stop` stops the server by sending a signal to it. You can also stop the server manually by executing `mysqladmin shutdown`.

To start and stop MySQL automatically on your server, you need to add start and stop commands to the appropriate places in your `/etc/rc*` files.

If you use the Linux server RPM package (`MySQL-server-VERSION.rpm`), the `mysql.server` script is installed in the `/etc/init.d` directory with the name `mysql`. You need not install it manually. See [Section 2.4, “Installing MySQL from RPM Packages on Linux”](#), for more information on the Linux RPM packages.

Some vendors provide RPM packages that install a startup script under a different name such as `mysqld`.

If you install MySQL from a source distribution or using a binary distribution format that does not install `mysql.server` automatically, you can install it manually. The script can be found in the `support-files` directory under the MySQL installation directory or in a MySQL source tree.

To install `mysql.server` manually, copy it to the `/etc/init.d` directory with the name `mysql`, and then make it executable.

Do this by changing location into the appropriate directory where `mysql.server` is located and executing these commands:

```
shell> cp mysql.server /etc/init.d/mysql
shell> chmod +x /etc/init.d/mysql
```

Older Red Hat systems use the `/etc/rc.d/init.d` directory rather than `/etc/init.d`. Adjust the preceding commands accordingly. Alternatively, first create `/etc/init.d` as a symbolic link that points to `/etc/rc.d/init.d`:

```
shell> cd /etc
shell> ln -s rc.d/init.d .
```

After installing the script, the commands needed to activate it to run at system startup depend on your operating system. On Linux, you can use `chkconfig`:

```
shell> chkconfig --add mysql
```

On some Linux systems, the following command also seems to be necessary to fully enable the `mysql` script:

```
shell> chkconfig --level 345 mysql on
```

On FreeBSD, startup scripts generally should go in `/usr/local/etc/rc.d/`. The `rc(8)` manual page states that scripts in this directory are executed only if their basename matches the `*.sh` shell file name pattern. Any other files or directories present within the directory are silently ignored. In other words, on FreeBSD, you should install the `mysql.server` script as `/usr/local/etc/rc.d/mysql.server.sh` to enable automatic startup.

As an alternative to the preceding setup, some operating systems also use `/etc/rc.local` or `/etc/init.d/boot.local` to start additional services on startup. To start up MySQL using this method, you could append a command like the one following to the appropriate startup file:

```
/bin/sh -c 'cd /usr/local/mysql; ./bin/mysqld_safe --user=mysql &'
```

For other systems, consult your operating system documentation to see how to install startup scripts.

You can add options for `mysql.server` in a global `/etc/my.cnf` file. A typical `/etc/my.cnf` file might look like this:

```
[mysqld]
datadir=/usr/local/mysql/var
socket=/var/tmp/mysql.sock
port=3306
user=mysql

[mysql.server]
basedir=/usr/local/mysql
```

The `mysql.server` script supports the following options: `basedir`, `datadir`, and `pid-file`. If specified, they *must* be placed in an option file, not on the command line. `mysql.server` supports only `start` and `stop` as command-line arguments.

The following table shows which option groups the server and each startup script read from option files.

Script	Option Groups
<code>mysqld</code>	<code>[mysqld]</code> , <code>[server]</code> , <code>[mysqld-major_version]</code>
<code>mysqld_safe</code>	<code>[mysqld]</code> , <code>[server]</code> , <code>[mysqld_safe]</code>
<code>mysql.server</code>	<code>[mysqld]</code> , <code>[mysql.server]</code> , <code>[server]</code>

`[mysqld-major_version]` means that groups with names like `[mysqld-5.0]` and `[mysqld-5.1]` are read by servers having versions 5.0.x, 5.1.x, and so forth. This feature can be used to specify options that can be read only by servers within a given release series.

For backward compatibility, `mysql.server` also reads the `[mysql_server]` group and `mysqld_safe` also reads the `[safe_mysqld]` group. However, you should update your option files to use the `[mysql.server]` and `[mysqld_safe]` groups instead when using MySQL 5.1.

See [Section 4.2.3.2, “Using Option Files”](#).

### 2.11.2.3. Starting and Troubleshooting the MySQL Server

This section provides troubleshooting suggestions for problems starting the server on Unix. If you are using Windows, see [Section 2.3.13, “Troubleshooting a MySQL Installation Under Windows”](#).

If you have problems starting the server, here are some things to try:

- Check the error log to see why the server does not start.
- Specify any special options needed by the storage engines you are using.
- Make sure that the server knows where to find the data directory.
- Make sure that the server can access the data directory. The ownership and permissions of the data directory and its contents must be set such that the server can read and modify them.
- Verify that the network interfaces the server wants to use are available.

Some storage engines have options that control their behavior. You can create a `my.cnf` file and specify startup options for the engines that you plan to use. If you are going to use storage engines that support transactional tables (`InnoDB`, `NDB`), be sure that you have them configured the way you want before starting the server:

**MySQL Enterprise**

For expert advice on start-up options appropriate to your circumstances, subscribe to The MySQL Enterprise Monitor. For more information, see <http://www.mysql.com/products/enterprise/advisors.html>.

- If you are using `InnoDB` tables, see [Section 13.6.2, “InnoDB Configuration”](#).
- If you are using MySQL Cluster, see [MySQL Cluster Configuration](#).

Storage engines will use default option values if you specify none, but it is recommended that you review the available options and specify explicit values for those for which the defaults are not appropriate for your installation.

When the `mysqld` server starts, it changes location to the data directory. This is where it expects to find databases and where it expects to write log files. The server also writes the pid (process ID) file in the data directory.

The data directory location is hardwired in when the server is compiled. This is where the server looks for the data directory by default. If the data directory is located somewhere else on your system, the server will not work properly. You can determine what the default path settings are by invoking `mysqld` with the `--verbose` and `--help` options.

If the default locations don't match the MySQL installation layout on your system, you can override them by specifying options to `mysqld` or `mysqld_safe` on the command line or in an option file.

To specify the location of the data directory explicitly, use the `--datadir` option. However, normally you can tell `mysqld` the location of the base directory under which MySQL is installed and it looks for the data directory there. You can do this with the `--basedir` option.

To check the effect of specifying path options, invoke `mysqld` with those options followed by the `--verbose` and `--help` options. For example, if you change location into the directory where `mysqld` is installed and then run the following command, it shows the effect of starting the server with a base directory of `/usr/local`:

```
shell> ./mysqld --basedir=/usr/local --verbose --help
```

You can specify other options such as `--datadir` as well, but `--verbose` and `--help` must be the last options.

Once you determine the path settings you want, start the server without `--verbose` and `--help`.

If `mysqld` is currently running, you can find out what path settings it is using by executing this command:

```
shell> mysqladmin variables
```

Or:

```
shell> mysqladmin -h host_name variables
```

`host_name` is the name of the MySQL server host.

If you get `Errcode 13` (which means `Permission denied`) when starting `mysqld`, this means that the privileges of the data directory or its contents do not allow the server access. In this case, you change the permissions for the involved files and directories so that the server has the right to use them. You can also start the server as `root`, but this raises security issues and should be avoided.

On Unix, change location into the data directory and check the ownership of the data directory and its contents to make sure the server has access. For example, if the data directory is `/usr/local/mysql/var`, use this command:

```
shell> ls -la /usr/local/mysql/var
```

If the data directory or its files or subdirectories are not owned by the login account that you use for running the server, change their ownership to that account. If the account is named `mysql`, use these commands:

```
shell> chown -R mysql /usr/local/mysql/var
shell> chgrp -R mysql /usr/local/mysql/var
```

If the server fails to start up correctly, check the error log. Log files are located in the data directory (typically `C:\Program Files\MySQL\MySQL Server 5.1\data` on Windows, `/usr/local/mysql/data` for a Unix binary distribution, and `/usr/local/var` for a Unix source distribution). Look in the data directory for files with names of the form `host_name.err` and `host_name.log`, where `host_name` is the name of your server host. Then examine the last few lines of these files. On Unix, you can use `tail` to display them:

```
shell> tail host_name.err
shell> tail host_name.log
```

The error log should contain information that indicates why the server couldn't start.

If either of the following errors occur, it means that some other program (perhaps another `mysqld` server) is using the TCP/IP port or Unix socket file that `mysqld` is trying to use:

```
Can't start server: Bind on TCP/IP port: Address already in use
Can't start server: Bind on unix socket...
```

Use `ps` to determine whether you have another `mysqld` server running. If so, shut down the server before starting `mysqld` again. (If another server is running, and you really want to run multiple servers, you can find information about how to do so in [Section 5.6, "Running Multiple MySQL Servers on the Same Machine"](#).)

If no other server is running, try to execute the command `telnet your_host_name tcp_ip_port_number`. (The default MySQL port number is 3306.) Then press Enter a couple of times. If you don't get an error message like `telnet: Unable to connect to remote host: Connection refused`, some other program is using the TCP/IP port that `mysqld` is trying to use. You'll need to track down what program this is and disable it, or else tell `mysqld` to listen to a different port with the `-port` option. In this case, you'll also need to specify the port number for client programs when connecting to the server via TCP/IP.

Another reason the port might be inaccessible is that you have a firewall running that blocks connections to it. If so, modify the firewall settings to allow access to the port.

If the server starts but you can't connect to it, you should make sure that you have an entry in `/etc/hosts` that looks like this:

```
127.0.0.1 localhost
```

This problem occurs only on systems that do not have a working thread library and for which MySQL must be configured to use MIT-pthreads.

If you cannot get `mysqld` to start, you can try to make a trace file to find the problem by using the `--debug` option. See [MySQL Internals: Porting](#).

### 2.11.3. Securing the Initial MySQL Accounts

Part of the MySQL installation process is to set up the `mysql` database that contains the grant tables:

- Windows distributions contain preinitialized grant tables that are installed automatically.
- On Unix, the grant tables are populated by the `mysql_install_db` program. Some installation methods run this program for you. Others require that you execute it manually. For details, see [Section 2.11.2, "Unix Post-Installation Procedures"](#).

The grant tables define the initial MySQL user accounts and their access privileges. These accounts are set up as follows:

- Accounts with the user name `root` are created. These are superuser accounts that can do anything. The initial `root` account passwords are empty, so anyone can connect to the MySQL server as `root` — *without a password* — and be granted all privileges.

- On Windows, one `root` account is created; this account allows connecting from the local host only. The Windows installer will optionally create an account allowing for connections from any host only if the user selects the **ENABLE ROOT ACCESS FROM REMOTE MACHINES** option during installation.
- On Unix, both `root` accounts are for connections from the local host. Connections must be made from the local host by specifying a host name of `localhost` for one of the accounts, or the actual host name or IP number for the other.
- Two anonymous-user accounts are created, each with an empty user name. The anonymous accounts have no password, so anyone can use them to connect to the MySQL server.
- On Windows, one anonymous account is for connections from the local host. It has no global privileges. (Before MySQL 5.1.16, it has all global privileges, just like the `root` accounts.) The other is for connections from any host and has all privileges for the `test` database and for other databases with names that start with `test_`.
- On Unix, both anonymous accounts are for connections from the local host. Connections must be made from the local host by specifying a host name of `localhost` for one of the accounts, or the actual host name or IP number for the other. These accounts have all privileges for the `test` database and for other databases with names that start with `test_`.

As noted, none of the initial accounts have passwords. This means that your MySQL installation is unprotected until you do something about it:

- If you want to prevent clients from connecting as anonymous users without a password, you should either assign a password to each anonymous account or else remove the accounts.
- You should assign a password to each MySQL `root` account.

The following instructions describe how to set up passwords for the initial MySQL accounts, first for the anonymous accounts and then for the `root` accounts. Replace “*newpwd*” in the examples with the actual password that you want to use. The instructions also cover how to remove the anonymous accounts, should you prefer not to allow anonymous access at all.

You might want to defer setting the passwords until later, so that you don't need to specify them while you perform additional setup or testing. However, be sure to set them before using your installation for production purposes.

### Anonymous Account Password Assignment

To assign passwords to the anonymous accounts, connect to the server as `root` and then use either `SET PASSWORD` or `UPDATE`. In either case, be sure to encrypt the password using the `PASSWORD()` function.

To use `SET PASSWORD` on Windows, do this:

```
shell> mysql -u root
mysql> SET PASSWORD FOR '@'localhost' = PASSWORD('newpwd');
mysql> SET PASSWORD FOR '@'%' = PASSWORD('newpwd');
```

To use `SET PASSWORD` on Unix, do this:

```
shell> mysql -u root
mysql> SET PASSWORD FOR '@'localhost' = PASSWORD('newpwd');
mysql> SET PASSWORD FOR '@'host_name' = PASSWORD('newpwd');
```

In the second `SET PASSWORD` statement, replace `host_name` with the name of the server host. This is the name that is specified in the `Host` column of the non-`localhost` record for `root` in the `user` table. If you don't know what host name this is, issue the following statement before using `SET PASSWORD`:

```
mysql> SELECT Host, User FROM mysql.user;
```

Look for the record that has `root` in the `User` column and something other than `localhost` in the `Host` column. Then use that `Host` value in the second `SET PASSWORD` statement.

### Anonymous Account Removal

If you prefer to remove the anonymous accounts instead, do so as follows:

```
shell> mysql -u root
mysql> DROP USER '';
```

The `DROP` statement applies both to Windows and to Unix. On Windows, if you want to remove only the anonymous account that

has the same privileges as `root`, do this instead:

```
shell> mysql -u root
mysql> DROP USER '@localhost';
```

That account allows anonymous access but has full privileges, so removing it improves security.

### `root` Account Password Assignment

You can assign passwords to the `root` accounts in several ways. The following discussion demonstrates three methods:

- Use the `SET PASSWORD` statement
- Use the `mysqladmin` command-line client program
- Use the `UPDATE` statement

To assign passwords using `SET PASSWORD`, connect to the server as `root` and issue `SET PASSWORD` statements. Be sure to encrypt the password using the `PASSWORD()` function.

For Windows, do this:

```
shell> mysql -u root
mysql> SET PASSWORD FOR 'root'@'localhost' = PASSWORD('newpwd');
mysql> SET PASSWORD FOR 'root'@'%' = PASSWORD('newpwd');
```

For Unix, do this:

```
shell> mysql -u root
mysql> SET PASSWORD FOR 'root'@'localhost' = PASSWORD('newpwd');
mysql> SET PASSWORD FOR 'root'@'host_name' = PASSWORD('newpwd');
```

In the second `SET PASSWORD` statement, replace `host_name` with the name of the server host. This is the same host name that you used when you assigned the anonymous account passwords.

If the `user` table contains an account with `User` and `Host` values of `'root'` and `'127.0.0.1'`, use an additional `SET PASSWORD` statement to set that account's password:

```
mysql> SET PASSWORD FOR 'root'@'127.0.0.1' = PASSWORD('newpwd');
```

To assign passwords to the `root` accounts using `mysqladmin`, execute the following commands:

```
shell> mysqladmin -u root password "newpwd"
shell> mysqladmin -u root -h host_name password "newpwd"
```

These commands apply both to Windows and to Unix. In the second command, replace `host_name` with the name of the server host. The double quotes around the password are not always necessary, but you should use them if the password contains spaces or other characters that are special to your command interpreter.

The `mysqladmin` method of setting the `root` account passwords does not set the password for the `'root'@'127.0.0.1'` account. To do so, use `SET PASSWORD` as shown earlier.

You can also use `UPDATE` to modify the `user` table directly. The following `UPDATE` statement assigns a password to all `root` accounts:

```
shell> mysql -u root
mysql> UPDATE mysql.user SET Password = PASSWORD('newpwd')
-> WHERE User = 'root';
mysql> FLUSH PRIVILEGES;
```

The `UPDATE` statement applies both to Windows and to Unix.

After the passwords have been set, you must supply the appropriate password whenever you connect to the server. For example, if you want to use `mysqladmin` to shut down the server, you can do so using this command:

```
shell> mysqladmin -u root -p shutdown
Enter password: (enter root password here)
```

### ■ Note

If you forget your `root` password after setting it up, [Section B.1.4.1, “How to Reset the Root Password”](#), covers the procedure for resetting it.

To set up additional accounts, you can use the `GRANT` statement. For instructions, see [Section 5.5.2, “Adding User Accounts”](#).

## 2.12. Upgrading or Downgrading MySQL

### 2.12.1. Upgrading MySQL

As a general rule, to upgrade from one release series to another, you should go to the next series rather than skipping a series. To upgrade from a release series previous to MySQL 5.0, upgrade to each successive release series in turn until you have reached MySQL 5.0, and then proceed with the upgrade to MySQL 5.1. For example, if you currently are running MySQL 4.0 and wish to upgrade to a newer series, upgrade to MySQL 4.1 first before upgrading to 5.0, and so forth. For information on upgrading to MySQL 5.0, see the *MySQL 5.0 Reference Manual*; for earlier releases, see the *MySQL 3.23, 4.0, 4.1 Reference Manual*.

To upgrade from MySQL 5.0 to 5.1, use the items in the following checklist as a guide:

- Before any upgrade, back up your databases, including the `mysql` database that contains the grant tables. See [Section 6.1, “Database Backups”](#).
- Read *all* the notes in [Section 2.12.1.1, “Upgrading from MySQL 5.0 to 5.1”](#). These notes enable you to identify upgrade issues that apply to your current MySQL installation. Some incompatibilities discussed in that section require your attention *before* upgrading. Others should be dealt with *after* upgrading.
- Read [Appendix C, \*MySQL Change History\*](#) as well, which provides information about features that are new in MySQL 5.1 or differ from those found in MySQL 5.0.
- After you upgrade to a new version of MySQL, run `mysql_upgrade` (see [Section 4.4.8, “mysql\\_upgrade — Check Tables for MySQL Upgrade”](#)). This program checks your tables, and attempts to repair them if necessary. It also updates your grant tables to make sure that they have the current structure so that you can take advantage of any new capabilities. (Some releases of MySQL introduce changes to the structure of the grant tables to add new privileges or features.)
- If you are running MySQL Server on Windows, see [Section 2.3.14, “Upgrading MySQL on Windows”](#).
- If you are using replication, see [Section 16.3.3, “Upgrading a Replication Setup”](#), for information on upgrading your replication setup.
- If you are upgrading an installation originally produced by installing multiple RPM packages, it is best to upgrade all the packages, not just some. For example, if you previously installed the server and client RPMs, do not upgrade just the server RPM.
- As of MySQL 5.1.9, the `mysqld-max` server is included in binary distributions. There is no separate MySQL-Max distribution. As of MySQL 5.1.12, there is no `mysqld-max` server at all in binary distributions. They contain a server that includes the features previously included in `mysqld-max`.
- If you have created a user-defined function (UDF) with a given name and upgrade MySQL to a version that implements a new built-in function with the same name, the UDF becomes inaccessible. To correct this, use `DROP FUNCTION` to drop the UDF, and then use `CREATE FUNCTION` to re-create the UDF with a different non-conflicting name. The same is true if the new version of MySQL implements a built-in function with the same name as an existing stored function. See [Section 8.2.4, “Function Name Parsing and Resolution”](#), for the rules describing how the server interprets references to different kinds of functions.

You can always move the MySQL format files and data files between different versions on systems with the same architecture as long as you stay within versions for the same release series of MySQL.

If you are cautious about using new versions, you can always rename your old `mysqld` before installing a newer one. For example, if you are using MySQL 5.0.13 and want to upgrade to 5.1.10, rename your current server from `mysqld` to `mysqld-5.0.13`. If your new `mysqld` then does something unexpected, you can simply shut it down and restart with your old `mysqld`.

If, after an upgrade, you experience problems with recompiled client programs, such as `Commands out of sync` or unexpected core dumps, you probably have used old header or library files when compiling your programs. In this case, you should check the date for your `mysql.h` file and `libmysqlclient.a` library to verify that they are from the new MySQL distribution. If not, recompile your programs with the new headers and libraries.

If problems occur, such as that the new `mysqld` server does not start or that you cannot connect without a password, verify that you do not have an old `my.cnf` file from your previous installation. You can check this with the `--print-defaults` option (for example, `mysqld --print-defaults`). If this command displays anything other than the program name, you have an active `my.cnf` file that affects server or client operation.



It is a good idea to rebuild and reinstall the Perl `DBD::mysql` module whenever you install a new release of MySQL. The same applies to other MySQL interfaces as well, such as PHP `mysql` extensions and the Python `MySQLdb` module.

### 2.12.1.1. Upgrading from MySQL 5.0 to 5.1

After upgrading a 5.0 installation to 5.0.10 or above, it is *necessary* to upgrade your grant tables. Otherwise, creating stored procedures and functions might not work. To perform this upgrade, run `mysql_upgrade`.

#### Note

It is good practice to back up your data before installing any new version of software. Although MySQL works very hard to ensure a high level of quality, you should protect your data by making a backup.

To upgrade to 5.1 from any previous version, MySQL recommends that you dump your tables with `mysqldump` before upgrading and reload the dump file after upgrading.

In general, you should do the following when upgrading from MySQL 5.0 to 5.1:

- Read *all* the items in the following sections to see whether any of them might affect your applications:
  - [Section 2.12.1, “Upgrading MySQL”](#), has general update information.
  - The items in the change lists found later in this section enable you to identify upgrade issues that apply to your current MySQL installation.
  - The MySQL 5.1 change history describes significant new features you can use in 5.1 or that differ from those found in MySQL 5.0. Some of these changes may result in incompatibilities. See [Section C.2, “Changes in release 5.1.x \(Production\)”](#).
- Note particularly any changes that are marked **Known issue** or **Incompatible change**. These incompatibilities with earlier versions of MySQL may require your attention *before you upgrade*.

Our aim is to avoid these changes, but occasionally they are necessary to correct problems that would be worse than an incompatibility between releases. If any upgrade issue applicable to your installation involves an incompatibility that requires special handling, follow the instructions given in the incompatibility description. Often this will involve a dump and reload, or use of a statement such as `CHECK TABLE` or `REPAIR TABLE`.

For dump and reload instructions, see [Section 2.12.4, “Rebuilding or Repairing Tables or Indexes”](#). Any procedure that involves `REPAIR TABLE` with the `USE_FRM` option *must* be done before upgrading. Use of this statement with a version of MySQL different from the one used to create the table (that is, using it after upgrading) may damage the table. See [Section 12.5.2.6, “REPAIR TABLE Syntax”](#).

- After you upgrade to a new version of MySQL, run `mysql_upgrade` (see [Section 4.4.8, “mysql\\_upgrade — Check Tables for MySQL Upgrade”](#)). This program checks your tables, and attempts to repair them if necessary. It also updates your grant tables to make sure that they have the current structure so that you can take advantage of any new capabilities. (Some releases of MySQL introduce changes to the structure of the grant tables to add new privileges or features.)
- Check [Section 2.12.3, “Checking Whether Table Indexes Must Be Rebuilt”](#), to see whether changes to character sets or collations were made that affect your table indexes. If so, you will need to rebuild the affected indexes using the instructions in [Section 2.12.4, “Rebuilding or Repairing Tables or Indexes”](#).
- If you are running MySQL Server on Windows, see [Section 2.3.14, “Upgrading MySQL on Windows”](#).
- If you are using replication, see [Section 16.3.3, “Upgrading a Replication Setup”](#), for information on upgrading your replication setup.

#### MySQL Enterprise

MySQL Enterprise subscribers will find more information about upgrading in the Knowledge Base articles found at [Upgrading](#). Access to the MySQL Knowledge Base collection of articles is one of the advantages of subscribing to MySQL Enterprise. For more information, see <http://www.mysql.com/products/enterprise/advisors.html>.

The following lists describe changes that may affect applications and that you should watch out for when upgrading to MySQL 5.1.

#### Configuration Changes:

- Before MySQL 5.1.11, to build MySQL from source with SSL support enabled, you would invoke `configure` with either the `--with-openssl` or `--with-yassl` option. In MySQL 5.1.11, those options both have been replaced by the `--`

`--with-ssl` option. By default, `--with-ssl` causes the bundled yaSSL library to be used. To select OpenSSL instead, give the option as `--with-ssl=path`, where `path` is the directory where the OpenSSL header files and libraries are located.

### Server Changes:

- **Known issue:** Dumps performed by using `mysqldump` to generate a dump file before the upgrade and reloading the file after upgrading are subject to the following problem:

Before MySQL 5.0.40, `mysqldump` displays `SPATIAL` index definitions using prefix lengths for the indexed columns. These prefix lengths are accepted in MySQL 5.0, but not as of MySQL 5.1. If you use `mysqldump` from versions of MySQL older than 5.0.40, any table containing `SPATIAL` indexes will cause an error when the dump file is reloaded into MySQL 5.1 or higher.

For example, a table definition might look like this when dumped in MySQL 5.0:

```
CREATE TABLE `t` (
  `g` geometry NOT NULL,
  SPATIAL KEY `g` (`g`(32))
) ENGINE=MyISAM DEFAULT CHARSET=latin1
```

The `SPATIAL` index definition will not be accepted in MySQL 5.1. To work around this, edit the dump file to remove the prefix:

```
CREATE TABLE `t` (
  `g` geometry NOT NULL,
  SPATIAL KEY `g` (`g`)
) ENGINE=MyISAM DEFAULT CHARSET=latin1
```

Dump files can be large, so it may be preferable to dump table definitions and data separately to make it easier to edit the definitions:

```
shell> mysqldump --no-data other_args > definitions.sql
shell> mysqldump --no-create-info other_args > data.sql
```

Then edit `definitions.sql` before reloading `definitions.sql` and `data.sql`, in that order.

If you upgrade to a version of MySQL 5.0 higher than 5.0.40 before upgrading to MySQL 5.1, this problem does not occur.

- **Known issue:** Before MySQL 5.1.30, the `CHECK TABLE ... FOR UPGRADE` statement did not check for incompatible collation changes made in MySQL 5.1.24. (This also affects `mysqlcheck` and `mysql_upgrade`, which cause that statement to be executed.)

Prior to the fix made in 5.1.30, a binary upgrade (performed without dumping tables with `mysqldump` before the upgrade and reloading the dump file after the upgrade) would corrupt tables. After the fix, `CHECK TABLE ... FOR UPGRADE` properly detects the problem and warns about tables that need repair.

However, the fix is not backward compatible and can result in a downgrading problem under these circumstances:

1. Perform a binary upgrade to a version of MySQL that includes the fix.
2. Run `CHECK TABLE ... FOR UPGRADE` (or `mysqlcheck` or `mysql_upgrade`) to upgrade tables.
3. Perform a binary downgrade to a version of MySQL that does not include the fix.

The solution is to dump tables with `mysqldump` before the downgrade and reload the dump file after the downgrade. Alternatively, drop and recreate affected indexes.

- **Known issue:** MySQL introduces encoding for table names that have non-ASCII characters (see [Section 8.2.3, “Mapping of Identifiers to File Names”](#)). After a binary upgrade from MySQL 5.0 to 5.1 or higher, the server recognizes names that have non-ASCII characters and adds a `#mysql150#` prefix to them.

As of MySQL 5.1.31, `mysql_upgrade` encodes these names by executing the following command:

```
mysqlcheck --all-databases --check-upgrade --fix-db-names --fix-table-names
```

Prior to MySQL 5.1.31, `mysql_upgrade` does not execute this command, so you should execute it manually if you have database or table names that contain non-alphanumeric characters.

Prior to MySQL 5.1.23, the `mysqlcheck` command does not perform the name encoding for views. To work around this

problem, drop each affected view and recreate it.

`mysqlcheck` cannot fix names that contain literal instances of the `@` character that is used for encoding special characters. If you have databases or tables that contain this character, use `mysqldump` to dump them before upgrading to MySQL 5.1, and then reload the dump file after upgrading.

- **Known issue:** When upgrading from MySQL 5.0 to versions of 5.1 prior to 5.1.23, running `mysqlcheck` (or `mysql_upgrade`, which runs `mysqlcheck`) to upgrade tables fails for names that must be written as quoted identifiers. To work around this problem, rename each affected table to a name that does not require quoting:

```
RENAME TABLE `tab`le_a` TO table_a;
RENAME TABLE `table b` TO table_b;
```

After renaming the tables, run the `mysql_upgrade` program. Then rename the tables back to their original names:

```
RENAME TABLE table_a TO `tab`le_a`;
RENAME TABLE table_b TO `table b`;
```

- **Known issue:** In connection with view creation, the server created `arc` directories inside database directories and maintained useless copies of `.frm` files there. Creation and renaming procedures of those copies as well as creation of `arc` directories has been discontinued in MySQL 5.1.29.

This change does cause a problem when downgrading to older server versions which manifests itself under these circumstances:

1. Create a view `v_orig` in MySQL 5.1.29 or higher.
2. Rename the view to `v_new` and then back to `v_orig`.
3. Downgrade to an older 5.1.x server and run `mysql_upgrade`.
4. Try to rename `v_orig` to `v_new` again. This operation fails.

As a workaround to avoid this problem, use either of these approaches:

- Dump your data using `mysqldump` before downgrading and reload the dump file after downgrading.
- Instead of renaming a view after the downgrade, drop it and recreate it.
- **Incompatible change:** Character set or collation changes were made in MySQL 5.1.21, 5.1.23, and 5.1.24 that may require table indexes to be rebuilt. For details, see [Section 2.12.3, “Checking Whether Table Indexes Must Be Rebuilt”](#).
- **Incompatible change:** From MySQL 5.1.24 to 5.1.31, the `UPDATE` statement was changed such that assigning `NULL` to a `NOT NULL` column caused an error even when strict SQL mode was not enabled. The original behavior before MySQL 5.1.24 was that such assignments caused an error only in strict SQL mode, and otherwise set the column to the implicit default value for the column data type and generated a warning. (For information about implicit default values, see [Section 10.1.4, “Data Type Default Values”](#).)

The change caused compatibility problems for applications that relied on the original behavior. It also caused replication problems between servers that had the original behavior and those that did not, for applications that assigned `NULL` to `NOT NULL` columns in `UPDATE` statements without strict SQL mode enabled. The change was reverted in MySQL 5.1.32 so that `UPDATE` again had the original behavior. Problems can still occur if you replicate between servers that have the modified `UPDATE` behavior and those that do not.

- **Incompatible change:** As of MySQL 5.1.29, the default binary logging mode has been changed from `MIXED` to `STATEMENT` for compatibility with MySQL 5.0.
- **Incompatible change:** In MySQL 5.1.25, a change was made to the way that the server handles prepared statements. This affects prepared statements processed at the SQL level (using the `PREPARE` statement) and those processed using the binary client-server protocol (using the `mysql_stmt_prepare()` C API function).

Previously, changes to metadata of tables or views referred to in a prepared statement could cause a server crash when the statement was next executed, or perhaps an error at execute time with a crash occurring later. For example, this could happen after dropping a table and recreating it with a different definition.

Now metadata changes to tables or views referred to by prepared statements are detected and cause automatic reparation of the statement when it is next executed. Metadata changes occur for DDL statements such as those that create, drop, alter, rename, or truncate tables, or that analyze, optimize, or repair tables. Reparation also occurs after referenced tables or views are flushed from the table definition cache, either implicitly to make room for new entries in the cache, or explicitly due to `FLUSH TABLES`.

Reparation is automatic, but to the extent that it occurs, performance of prepared statements is diminished.

Table content changes (for example, with `INSERT` or `UPDATE`) do not cause reparation, nor do `SELECT` statements.

An incompatibility with previous versions of MySQL is that a prepared statement may now return a different set of columns or different column types from one execution to the next. For example, if the prepared statement is `SELECT * FROM t1`, altering `t1` to contain a different number of columns causes the next execution to return a number of columns different from the previous execution.

Older versions of the client library cannot handle this change in behavior. For applications that use prepared statements with the new server, an upgrade to the new client library is strongly recommended.

Along with this change to statement reparation, the default value of the `table_definition_cache` system variable has been increased from 128 to 256. The purpose of this increase is to lessen the chance that prepared statements will need reparation due to referred-to tables/views having been flushed from the cache to make room for new entries.

A new status variable, `Com_stmt_reprepare`, has been introduced to track the number of reparations.

- **Incompatible change:** As of MySQL 5.1.23, within a stored routine, it is no longer allowable to declare a cursor for a `SHOW` or `DESCRIBE` statement. This happened to work in some instances, but is no longer supported. In many cases, a workaround for this change is to use the cursor with a `SELECT` query to read from an `INFORMATION_SCHEMA` table that produces the same information as the `SHOW` statement.
- **Incompatible change:** `SHOW CREATE VIEW` displays view definitions using an `AS alias_name` clause for each column. If a column is created from an expression, the default alias is the expression text, which can be quite long. As of MySQL 5.1.23, aliases for column names in `CREATE VIEW` statements are checked against the maximum column length of 64 characters (not the maximum alias length of 256 characters). As a result, views created from the output of `SHOW CREATE VIEW` fail if any column alias exceeds 64 characters. This can cause problems for replication or loading dump files. For additional information and workarounds, see [Section D.4, “Restrictions on Views”](#).
- **Incompatible change:** MySQL 5.1 implements support for a plugin API that allows the loading and unloading of components at runtime, without restarting the server. [Section 21.2, “The MySQL Plugin Interface”](#). The plugin API requires the `mysql.plugin` table. After upgrading from an older version of MySQL, you should run the `mysql_upgrade` command to create this table. See [Section 4.4.8, “mysql\\_upgrade — Check Tables for MySQL Upgrade”](#).

Plugins are installed in the directory named by the `plugin_dir` system variable. This variable also controls the location from which the server loads user-defined functions (UDFs), which is a change from earlier versions of MySQL. That is, all UDF library files now must be installed in the plugin directory. When upgrading from an older version of MySQL, you must migrate your UDF files to the plugin directory.

- **Incompatible change:** The `table_cache` system variable has been renamed to `table_open_cache`. Any scripts that refer to `table_cache` must be updated to use the new name.
- **Incompatible change:** Several issues were identified for stored programs (stored procedures and functions, triggers, and events) and views containing non-ASCII symbols. These issues involved conversion errors due to incomplete character set information when translating these objects to and from stored format.

To address these problems, the representation for these objects was changed in MySQL 5.1.21. However, the fixes affect *all* stored programs and views. (For example, you will see warnings about “no creation context.”) To avoid warnings from the server about the use of old definitions from any release prior to 5.1.21, you should dump stored programs and views with `mysqldump` after upgrading to 5.1.21 or higher, and then reload them to recreate them with new definitions. Invoke `mysqldump` with a `--default-character-set` option that names the non-ASCII character set that was used for the definitions when the objects were originally defined.

- **Incompatible change:** As of MySQL 5.1.20, `mysqld_safe` supports error logging to `syslog` on systems that support the `logger` command. The new `--syslog` and `--skip-syslog` options can be used instead of the `--log-error` option to control logging behavior, as described in [Section 4.3.2, “mysqld\\_safe — MySQL Server Startup Script”](#).

In 5.1.21 and up, the default is `--skip-syslog`, which is compatible with the default behavior of writing an error log file for releases prior to 5.1.20.

**In 5.1.20 only, the following conditions apply:** 1) The default is to use `syslog`, which is not compatible with releases prior to 5.1.20. 2) Logging to `syslog` may fail to operate correctly in some cases. For these reasons, avoid using MySQL 5.1.20.

- **Incompatible change:** As of MySQL 5.1.15, `InnoDB` rolls back only the last statement on a transaction timeout. A new option, `--innodb_rollback_on_timeout`, causes `InnoDB` to abort and roll back the entire transaction if a transaction timeout occurs (the same behavior as in MySQL 4.1).
- **Incompatible change:** As of MySQL 5.1.15, the following conditions apply to enabling the `read_only` system variable:
  - If you attempt to enable `read_only` while you have any explicit locks (acquired with `LOCK TABLES` or have a pending transaction, an error will occur.

- If other clients hold explicit table locks or have pending transactions, the attempt to enable `read_only` blocks until the locks are released and the transactions end. While the attempt to enable `read_only` is pending, requests by other clients for table locks or to begin transactions also block until `read_only` has been set.
- `read_only` can be enabled while you hold a global read lock (acquired with `FLUSH TABLES WITH READ LOCK`) because that does not involve table locks.

Previously, the attempt to enable `read_only` would return immediately even if explicit locks or transactions were pending, so some data changes could occur for statements executing in the server at the same time.

- **Incompatible change:** The number of function names affected by `IGNORE_SPACE` was reduced significantly in MySQL 5.1.13, from about 200 to about 30. (For details about `IGNORE_SPACE`, see [Section 8.2.4, “Function Name Parsing and Resolution”](#).) This change improves the consistency of parser operation. However, it also introduces the possibility of incompatibility for old SQL code that relies on the following conditions:
  - `IGNORE_SPACE` is disabled.
  - The presence or absence of whitespace following a function name is used to distinguish between a built-in function and stored function that have the same name (for example, `PI()` versus `PI ()`).

For functions that are no longer affected by `IGNORE_SPACE` as of MySQL 5.1.13, that strategy no longer works. Either of the following approaches can be used if you have code that is subject to the preceding incompatibility:

- If a stored function has a name that conflicts with a built-in function, refer to the stored function with a schema name qualifier, regardless of whether whitespace is present. For example, write `schema_name.PI()` or `schema_name.PI ()`.
- Alternatively, rename the stored function to use a non-conflicting name and change invocations of the function to use the new name.
- **Incompatible change:** For `utf8` columns, the full-text parser incorrectly considered several non-word punctuation and whitespace characters as word characters, causing some searches to return incorrect results. The fix involves a change to the full-text parser in MySQL 5.1.12, so as of 5.1.12, any tables that have `FULLTEXT` indexes on `utf8` columns must be repaired with `REPAIR TABLE`:

```
REPAIR TABLE tbl_name QUICK;
```

- **Incompatible change:** Storage engines can be pluggable at runtime, so the distinction between disabled and invalid storage engines no longer applies. As of MySQL 5.1.12, this affects the `NO_ENGINE_SUBSTITUTION` SQL mode, as described in [Section 5.1.7, “Server SQL Modes”](#).
- **Incompatible change:** The structure of `FULLTEXT` indexes has been changed in MySQL 5.1.6. After upgrading to MySQL 5.1.6 or greater, any tables that have `FULLTEXT` indexes must be repaired with `REPAIR TABLE`:

```
REPAIR TABLE tbl_name QUICK;
```

- **Incompatible change:** In MySQL 5.1.6, when log tables were implemented, the default log destination for the general query and slow query log was `TABLE`. As of MySQL 5.1.21, this default has been changed to `FILE`, which is compatible with MySQL 5.0, but incompatible with earlier releases of MySQL 5.1. If you are upgrading from MySQL 5.0 to 5.1.21 or higher, no logging option changes should be necessary. However, if you are upgrading from 5.1.6 through 5.1.20 to 5.1.21 or higher and were using `TABLE` logging, use the `--log-output=TABLE` option explicitly to preserve your server's table-logging behavior.
- **Incompatible change:** For `ENUM` columns that had enumeration values containing commas, the commas were mapped to `0xff` internally. However, this rendered the commas indistinguishable from true `0xff` characters in the values. This no longer occurs. However, the fix requires that you dump and reload any tables that have `ENUM` columns containing true `0xff` in their values: Dump the tables using `mysqldump` with the current server before upgrading from a version of MySQL 5.1 older than 5.1.15 to version 5.1.15 or newer.
- As of MySQL 5.1.12, the `lc_time_names` system variable specifies the locale that controls the language used to display day and month names and abbreviations. This variable affects the output from the `DATE_FORMAT()`, `DAYNAME()` and `MONTHNAME()` functions. See [Section 9.8, “MySQL Server Locale Support”](#).
- As of MySQL 5.1.9, `mysqld_safe` no longer implicitly invokes `mysqld-max` if it exists. Instead, it invokes `mysqld` unless a `--mysqld` or `--mysqld-version` option is given to specify another server explicitly. If you previously relied on the implicit invocation of `mysqld-max`, you should use an appropriate option now. As of MySQL 5.1.12, there is no longer any separate `mysqld-max` server, so no change should be necessary.

## SQL Changes:



- **Known issue:** Prior to MySQL 5.1.17, the parser accepted invalid code in SQL condition handlers, leading to server crashes or unexpected execution behavior in stored programs. Specifically, the parser allowed a condition handler to refer to labels for blocks that enclose the handler declaration. This was incorrect because block label scope does not include the code for handlers declared within the labeled block.

As of 5.1.17, the parser rejects this invalid construct, but if you perform a binary upgrade (without dumping and reloading your databases), existing handlers that contain the construct still are invalid and should be rewritten *even if they appear to function as you expect*.

To find affected handlers, use `mysqldump` to dump all stored procedures and functions, triggers, and events. Then attempt to reload them into an upgraded server. Handlers that contain illegal label references will be rejected.

For more information about condition handlers and writing them to avoid invalid jumps, see [Section 12.8.4.2, “DECLARE for Handlers”](#).

- **Incompatible change:** The parser accepted statements that contained `/* ... */` that were not properly closed with `*/`, such as `SELECT 1 /* + 2`. As of MySQL 5.1.23, statements that contain unclosed `/*`-comments now are rejected with a syntax error.

This fix has the potential to cause incompatibilities. Because of [Bug#26302](#), which caused the trailing `*/` to be truncated from comments in views, stored routines, triggers, and events, it is possible that objects of those types may have been stored with definitions that now will be rejected as syntactically invalid. Such objects should be dropped and re-created so that their definitions do not contain truncated comments.

- **Incompatible change:** Multiple-table `DELETE` statements containing ambiguous aliases could have unintended side effects such as deleting rows from the wrong table. Example:

```
DELETE FROM t1 AS a2 USING t1 AS a1 INNER JOIN t2 AS a2;
```

As of MySQL 5.1.23, alias declarations can be declared only in the `table_references` part. Elsewhere in the statement, alias references are allowed but not alias declarations. Statements containing aliases that are no longer allowed must be rewritten.

- **Incompatible change:** As of MySQL 5.1.8, `TYPE = engine_name` is still accepted as a synonym for the `ENGINE = engine_name` table option but generates a warning. You should note that this option is not available in MySQL 5.1.7, and **is removed altogether as of MySQL 6.0 and produces a syntax error**.

`TYPE` has been deprecated since MySQL 4.0.

- **Incompatible change:** The namespace for triggers changed in MySQL 5.0.10. Previously, trigger names had to be unique per table. Now they must be unique within the schema (database). An implication of this change is that `DROP TRIGGER` syntax now uses a schema name instead of a table name (schema name is optional and, if omitted, the current schema will be used).

When upgrading from a version of MySQL 5 older than 5.0.10 to MySQL 5.0.10 or newer, you must drop all triggers and re-create them or `DROP TRIGGER` will not work after the upgrade. Here is a suggested procedure for doing this:

1. Upgrade to MySQL 5.0.10 or later to be able to access trigger information in the `INFORMATION_SCHEMA.TRIGGERS` table. (This should work even for pre-5.0.10 triggers.)
2. Dump all trigger definitions using the following `SELECT` statement:

```
SELECT CONCAT('CREATE TRIGGER ', t.TRIGGER_SCHEMA, '.', t.TRIGGER_NAME,
             ' ', t.ACTION_TIMING, ' ', t.EVENT_MANIPULATION, ' ON ',
             t.EVENT_OBJECT_SCHEMA, '.', t.EVENT_OBJECT_TABLE,
             ' FOR EACH ROW ', t.ACTION_STATEMENT, '///')
INTO OUTFILE '/tmp/triggers.sql'
FROM INFORMATION_SCHEMA.TRIGGERS AS t;
```

The statement uses `INTO OUTFILE`, so you must have the `FILE` privilege. The file will be created on the server host. Use a different file name if you like. To be 100% safe, inspect the trigger definitions in the `triggers.sql` file, and perhaps make a backup of the file.

3. Stop the server and drop all triggers by removing all `.TRG` files in your database directories. Change location to your data directory and issue this command:

```
shell> rm */*.TRG
```

4. Start the server and re-create all triggers using the `triggers.sql` file:

```
mysql> delimiter // ;
mysql> source /tmp/triggers.sql //
```

5. Check that all triggers were successfully created using the `SHOW TRIGGERS` statement.
- **Incompatible change:** MySQL 5.1.6 introduces the `TRIGGER` privilege. Previously, the `SUPER` privilege was needed to create or drop triggers. Now those operations require the `TRIGGER` privilege. This is a security improvement because you no longer need to grant users the `SUPER` privilege to enable them to create triggers. However, the requirement that the account named in a trigger's `DEFINER` clause must have the `SUPER` privilege has changed to a requirement for the `TRIGGER` privilege. When upgrading from a previous version of MySQL 5.0 or 5.1 to MySQL 5.1.6 or newer, be sure to update your grant tables by running `mysql_upgrade`. This will assign the `TRIGGER` privilege to all accounts that had the `SUPER` privilege. If you fail to update the grant tables, triggers may fail when activated. After updating the grant tables, you can revoke the `SUPER` privilege from those accounts that no longer otherwise require it.
  - Some keywords are reserved in MySQL 5.1 that were not reserved in MySQL 5.0. See [Section 8.3, “Reserved Words”](#).
  - The `LOAD DATA FROM MASTER` and `LOAD TABLE FROM MASTER` statements are deprecated. See [Section 12.6.2.2, “LOAD DATA FROM MASTER Syntax”](#), for recommended alternatives.
  - The `INSTALL PLUGIN` and `UNINSTALL PLUGIN` statements that are used for the plugin API are new. So is the `WITH PARSER` clause for `FULLTEXT` index creation that associates a parser plugin with a full-text index. [Section 21.2, “The MySQL Plugin Interface”](#).

#### C API Changes:

- **Incompatible change:** As of MySQL 5.1.7, the `mysql_stmt_attr_get()` C API function returns a boolean rather than an unsigned int for `STMT_ATTR_UPDATE_MAX_LENGTH`. ([Bug#16144](#))

## 2.12.2. Downgrading MySQL

This section describes what you should do to downgrade to an older MySQL version in the unlikely case that the previous version worked better than the new one.

If you are downgrading within the same release series (for example, from 5.0.13 to 5.0.12) the general rule is that you just have to install the new binaries on top of the old ones. There is no need to do anything with the databases. As always, however, it is always a good idea to make a backup.

The following items form a checklist of things you should do whenever you perform a downgrade:

- Read the upgrading section for the release series from which you are downgrading to be sure that it does not have any features you really need. See [Section 2.12.1, “Upgrading MySQL”](#).
- If there is a downgrading section for that version, you should read that as well.
- To see which new features were added between the version to which you are downgrading and your current version, see the change logs ([Appendix C, MySQL Change History](#)).
- Check [Section 2.12.3, “Checking Whether Table Indexes Must Be Rebuilt”](#), to see whether changes to character sets or collations were made between your current version of MySQL and the version to which you are downgrading. If so and these changes affect your table indexes, you will need to rebuild the affected indexes using the instructions in [Section 2.12.4, “Rebuilding or Repairing Tables or Indexes”](#).

In most cases, you can move the MySQL format files and data files between different versions on the same architecture as long as you stay within versions for the same release series of MySQL.

If you downgrade from one release series to another, there may be incompatibilities in table storage formats. In this case, use `mysqldump` to dump your tables before downgrading. After downgrading, reload the dump file using `mysql` or `mysqlimport` to re-create your tables. For examples, see [Section 2.12.5, “Copying MySQL Databases to Another Machine”](#).

A typical symptom of a downward-incompatible table format change when you downgrade is that you cannot open tables. In that case, use the following procedure:

1. Stop the older MySQL server that you are downgrading to.
2. Restart the newer MySQL server you are downgrading from.
3. Dump any tables that were inaccessible to the older server by using `mysqldump` to create a dump file.



4. Stop the newer MySQL server and restart the older one.
5. Reload the dump file into the older server. Your tables should be accessible.

It might also be the case that the structure of the system tables in the `mysql` database has changed and that downgrading introduces some loss of functionality or requires some adjustments. Here are some examples:

- Trigger creation requires the `TRIGGER` privilege as of MySQL 5.1. In MySQL 5.0, there is no `TRIGGER` privilege and `SUPER` is required instead. If you downgrade from MySQL 5.1 to 5.0, you will need to give the `SUPER` privilege to those accounts that had the `TRIGGER` privilege in 5.1.
- Triggers were added in MySQL 5.0, so if you downgrade from 5.0 to 4.1, you cannot use triggers at all.

### 2.12.2.1. Downgrading to MySQL 5.0

When downgrading to MySQL 5.0 from MySQL 5.1 or a later version, you should keep in mind the following issues relating to features found in MySQL 5.1 and later, but not in MySQL 5.0:

- **Partitioning.** MySQL 5.0 does not support user-defined partitioning. If a table was created as a partitioned table in 5.1 (or if an table created in a previous version of MySQL was altered to include partitions after an upgrade to 5.1), the table is accessible after downgrade only if you do one of the following:
  - Export the table using `mysqldump` and then drop it in MySQL 5.1; import the table again following the downgrade to MySQL 5.0.
  - Prior to the downgrade, remove the table's partitioning using `ALTER TABLE table_name REMOVE PARTITIONING`.
- **Event Scheduler.** MySQL 5.0 does not support scheduled events. If your databases contain scheduled event definitions, you should prevent them from being dumped when you use `mysqldump` by using the `--skip-events` option. (See [Section 4.5.4, “mysqldump — A Database Backup Program”](#).)
- **Stored routines.** MySQL 5.1.21 added a number of new columns to the `mysql.proc` table in which stored routine definitions are stored. If you are downgrading from MySQL 5.1.21 or later to MySQL 5.0, you cannot import the MySQL 5.1 routine definitions into MySQL 5.0.46 or earlier using the dump of `mysql.proc` created by `mysqldump` (such as when using the `-all-databases` option). Instead, you should run `mysqldump --routines` prior to performing the downgrade and run the stored routines DDL statements following the downgrade.  
  
See [Bug#11986](#), [Bug#30029](#), and [Bug#30660](#), for more information.
- **Triggers.** Trigger creation requires the `TRIGGER` privilege as of MySQL 5.1. In MySQL 5.0, there is no `TRIGGER` privilege and `SUPER` is required instead. If you downgrade from MySQL 5.1 to 5.0, you will need to give the `SUPER` privilege to those accounts that had the `TRIGGER` privilege in 5.1.

### 2.12.3. Checking Whether Table Indexes Must Be Rebuilt

A binary upgrade or downgrade is one that installs one version of MySQL “in place” over an existing version, without dumping and reloading tables:

1. Stop the server for the existing version if it is running.
2. Install a different version of MySQL. This is an upgrade if the new version is higher than the original version, a downgrade if the version is lower.
3. Start the server for the new version.

In many cases, the tables from the previous version of MySQL can be used without change by the new version. However, sometimes modifications are made to the handling of character sets or collations that change the character sort order, which causes the ordering of entries in any index that uses an affected character set or collation to be incorrect. Such changes result in several possible problems:

- Comparison results that differ from previous results

- Inability to find some index values due to misordered index entries
- Misordered `ORDER BY` results
- Tables that `CHECK TABLE` reports as being in need of repair

The solution to these problems is to rebuild any indexes that use an affected character set or collation, either by dropping and recreating the indexes, or by dumping and reloading the entire table. For information about rebuilding indexes, see [Section 2.12.4, “Rebuilding or Repairing Tables or Indexes”](#).

To check whether a table has indexes that must be rebuilt, consult the following list. It indicates which versions of MySQL introduced character set or collation changes that require indexes to be rebuilt. Each entry indicates the version in which the change occurred and the character sets or collations that the change affects. If the change is associated with a particular bug report, the bug number is given.

The list applies both for binary upgrades and downgrades. For example, [Bug#29461](#) was fixed in MySQL 5.0.48, so it applies to upgrades from versions older than 5.0.48 to 5.0.48 or newer, and also to downgrades from 5.0.48 or newer to versions older than 5.0.58.

If you have tables with indexes that are affected, rebuild the indexes using the instructions given in [Section 2.12.4, “Rebuilding or Repairing Tables or Indexes”](#).

In many cases, you can use `CHECK TABLE ... FOR UPGRADE` to identify tables for which index rebuilding is required. (It will report: `Table upgrade required. Please do "REPAIR TABLE `tbl_name`" to fix it!`) In these cases, you can also use `mysqlcheck --check-upgrade` or `mysql_upgrade`, which execute `CHECK TABLE`. However, the use of `CHECK TABLE` applies only after upgrades, not downgrades. Also, `CHECK TABLE` is not applicable to all storage engines. For details about which storage engines `CHECK TABLE` supports, see [Section 12.5.2.3, “CHECK TABLE Syntax”](#).

Changes that cause index rebuilding to be necessary:

- MySQL 5.0.48 ([Bug#29461](#))  
Affects indexes for columns that use any of these character sets: `uucjpm`s, `uuc_kr`, `gb2312`, `latin7`, `macce`, `ujis`  
Affected tables can be detected by `CHECK TABLE ... FOR UPGRADE` as of MySQL 5.1.29, 6.0.8 (see [Bug#39585](#)).
- MySQL 5.0.48 ([Bug#27562](#))  
Affects indexes that use the `ascii_general_ci` collation for columns that contain any of these characters: ``` GRAVE ACCENT, `[` LEFT SQUARE BRACKET, `\` REVERSE SOLIDUS, `]` RIGHT SQUARE BRACKET, `~` TILDE  
Affected tables can be detected by `CHECK TABLE ... FOR UPGRADE` as of MySQL 5.1.29, 6.0.8 (see [Bug#39585](#)).
- MySQL 5.1.21 ([Bug#29461](#))  
Affects indexes for columns that use any of these character sets: `uucjpm`s, `uuc_kr`, `gb2312`, `latin7`, `macce`, `ujis`  
Affected tables can be detected by `CHECK TABLE ... FOR UPGRADE` as of MySQL 5.1.29, 6.0.8 (see [Bug#39585](#)).
- MySQL 5.1.23 ([Bug#27562](#))  
Affects indexes that use the `ascii_general_ci` collation for columns that contain any of these characters: ``` GRAVE ACCENT, `[` LEFT SQUARE BRACKET, `\` REVERSE SOLIDUS, `]` RIGHT SQUARE BRACKET, `~` TILDE  
Affected tables can be detected by `CHECK TABLE ... FOR UPGRADE` as of MySQL 5.1.29, 6.0.8 (see [Bug#39585](#)).
- MySQL 5.1.24 ([Bug#27877](#))  
Affects indexes that use the `utf8_general_ci` or `ucs2_general_ci` collation for columns that contain `ß` LATIN SMALL LETTER SHARP S (German).  
Affected tables can be detected by `CHECK TABLE ... FOR UPGRADE` as of MySQL 5.1.30, 6.0.8 (see [Bug#40053](#)).
- \* MySQL 6.0.1 (WL#3664)  
Affects indexes that use the `latin2_czech_cs` collation.  
Affected tables can be detected by `CHECK TABLE ... FOR UPGRADE` as of MySQL 6.0.9 (see [Bug#40054](#)).
- MySQL 6.0.5 ([Bug#33452](#))

Affects indexes that use the `latin2_czech_cs` collation.

Affected tables can be detected by `CHECK TABLE ... FOR UPGRADE` as of MySQL 6.0.9 (see [Bug#40054](#)).

- MySQL 6.0.5 ([Bug#27877](#))

Affects indexes that use the `utf8_general_ci` or `ucs2_general_ci` collation for columns that contain 'ß' LATIN SMALL LETTER SHARP S (German).

Affected tables can be detected by `CHECK TABLE ... FOR UPGRADE` as of MySQL 6.0.8 (see [Bug#40053](#)).

- MySQL 6.0.6 ([Bug#25420](#))

Affects indexes for columns that use the following collations, if the columns contain the indicated characters:  
`big5_chinese_ci`: '~' TILDE or `` GRAVE ACCENT; `cp866_general_ci`: j LATIN SMALL LETTER J;  
`gb2312_chinese_ci`: '~' TILDE; `gbk_chinese_ci`: '~' TILDE

Affected tables can be detected by `CHECK TABLE ... FOR UPGRADE` as of MySQL 6.0.9 (see [Bug#40054](#)).

## 2.12.4. Rebuilding or Repairing Tables or Indexes

This section describes how to rebuild a table. This can be necessitated by changes to MySQL such as how data types are handled or changes to character set handling. For example, an error in a collation might have been corrected, necessitating a table rebuild to rebuild the indexes for character columns that use the collation. It might also be that a table repair or upgrade should be done as indicated by a table check operation such as that performed by `CHECK TABLE`, `mysqlcheck`, or `mysql_upgrade`.

Methods for rebuilding a table include dumping and reloading it, or using `ALTER TABLE` or `REPAIR TABLE`.

### Note

If you are rebuilding tables because a different version of MySQL will not handle them after a binary upgrade or downgrade, you must use the dump-and-reload method. Dump the tables *before* upgrading or downgrading (using your original version of MySQL), and reload the tables *after* upgrading or downgrading (after installing the new version).

If you use the dump-and-reload method of rebuilding tables only for the purpose of rebuilding indexes, you can perform the dump either before or after upgrading or downgrading. Reloading still must be done afterward.

To re-create a table by dumping and reloading it, use `mysqldump` to create a dump file and `mysql` to reload the file:

```
shell> mysqldump db_name t1 > dump.sql
shell> mysql db_name < dump.sql
```

To recreate all the tables in a single database, specify the database name without any following table name:

```
shell> mysqldump db_name > dump.sql
shell> mysql db_name < dump.sql
```

To recreate all tables in all databases, use the `--all-databases` option:

```
shell> mysqldump --all-databases > dump.sql
shell> mysql < dump.sql
```

To rebuild a table with `ALTER TABLE`, use a statement that “changes” the table to use the storage engine that it already has. For example, if `t1` is a `MyISAM` table, use this statement:

```
mysql> ALTER TABLE t1 ENGINE = MyISAM;
```

If you are not sure which storage engine to specify in the `ALTER TABLE` statement, use `SHOW CREATE TABLE` to display the table definition.

If you must rebuild a table because a table checking operation indicates that the table is corrupt or needs an upgrade, you can use `REPAIR TABLE` if that statement supports the table's storage engine. For example, to repair a `MyISAM` table, use this statement:

```
mysql> REPAIR TABLE t1;
```

For storage engines such as `InnoDB` that `REPAIR TABLE` does not support, use `mysqldump` to create a dump file and `mysql`

to reload the file, as described earlier.

For specifics about which storage engines `REPAIR TABLE` supports, see [Section 12.5.2.6, “REPAIR TABLE Syntax”](#).

## 2.12.5. Copying MySQL Databases to Another Machine

You can copy the `.frm`, `.MYI`, and `.MYD` files for `MyISAM` tables between different architectures that support the same floating-point format. (MySQL takes care of any byte-swapping issues.) See [Section 13.4, “The MyISAM Storage Engine”](#).

In cases where you need to transfer databases between different architectures, you can use `mysqldump` to create a file containing SQL statements. You can then transfer the file to the other machine and feed it as input to the `mysql` client.

Use `mysqldump --help` to see what options are available.

The easiest (although not the fastest) way to move a database between two machines is to run the following commands on the machine on which the database is located:

```
shell> mysqladmin -h 'other_hostname' create db_name
shell> mysqldump db_name | mysql -h 'other_hostname' db_name
```

If you want to copy a database from a remote machine over a slow network, you can use these commands:

```
shell> mysqladmin create db_name
shell> mysqldump -h 'other_hostname' --compress db_name | mysql db_name
```

You can also store the dump in a file, transfer the file to the target machine, and then load the file into the database there. For example, you can dump a database to a compressed file on the source machine like this:

```
shell> mysqldump --quick db_name | gzip > db_name.gz
```

Transfer the file containing the database contents to the target machine and run these commands there:

```
shell> mysqladmin create db_name
shell> gunzip < db_name.gz | mysql db_name
```

You can also use `mysqldump` and `mysqlimport` to transfer the database. For large tables, this is much faster than simply using `mysqldump`. In the following commands, `DUMPDIR` represents the full path name of the directory you use to store the output from `mysqldump`.

First, create the directory for the output files and dump the database:

```
shell> mkdir DUMPDIR
shell> mysqldump --tab=DUMPDIR db_name
```

Then transfer the files in the `DUMPDIR` directory to some corresponding directory on the target machine and load the files into MySQL there:

```
shell> mysqladmin create db_name           # create database
shell> cat DUMPDIR/*.sql | mysql db_name   # create tables in database
shell> mysqlimport db_name DUMPDIR/*.txt   # load data into tables
```

Do not forget to copy the `mysql` database because that is where the grant tables are stored. You might have to run commands as the MySQL `root` user on the new machine until you have the `mysql` database in place.

After you import the `mysql` database on the new machine, execute `mysqladmin flush-privileges` so that the server reloads the grant table information.

## 2.13. Operating System-Specific Notes

### 2.13.1. Linux Notes

This section discusses issues that have been found to occur on Linux. The first few subsections describe general operating system-related issues, problems that can occur when using binary or source distributions, and post-installation issues. The remaining subsections discuss problems that occur with Linux on specific platforms.

Note that most of these problems occur on older versions of Linux. If you are running a recent version, you may see none of them.

#### 2.13.1.1. Linux Operating System Notes

MySQL needs at least Linux version 2.0.

### Warning

We have seen some strange problems with Linux 2.2.14 and MySQL on SMP systems. We also have reports from some MySQL users that they have encountered serious stability problems using MySQL with kernel 2.2.14. If you are using this kernel, you should upgrade to 2.2.19 (or newer) or to a 2.4 kernel. If you have a multiple-CPU box, you should seriously consider using 2.4 because it gives you a significant speed boost. Your system should be more stable.

When using LinuxThreads, you should see a minimum of three `mysqld` processes running. These are in fact threads. There is one thread for the LinuxThreads manager, one thread to handle connections, and one thread to handle alarms and signals.

## 2.13.1.2. Linux Binary Distribution Notes

The Linux-Intel binary and RPM releases of MySQL are configured for the highest possible speed. We are always trying to use the fastest stable compiler available.

The binary release is linked with `-static`, which means you do not normally need to worry about which version of the system libraries you have. You need not install LinuxThreads, either. A program linked with `-static` is slightly larger than a dynamically linked program, but also slightly faster (3-5%). However, one problem with a statically linked program is that you can't use user-defined functions (UDFs). If you are going to write or use UDFs (this is something for C or C++ programmers only), you must compile MySQL yourself using dynamic linking.

A known issue with binary distributions is that on older Linux systems that use `libc` (such as Red Hat 4.x or Slackware), you get some (non-fatal) issues with host name resolution. If your system uses `libc` rather than `glibc2`, you probably will encounter some difficulties with host name resolution and `getpwnam()`. This happens because `glibc` (unfortunately) depends on some external libraries to implement host name resolution and `getpwent()`, even when compiled with `-static`. These problems manifest themselves in two ways:

- You may see the following error message when you run `mysql_install_db`:

```
Sorry, the host 'xxxx' could not be looked up
```

You can deal with this by executing `mysql_install_db --force`, which does not execute the `resolveip` test in `mysql_install_db`. The downside is that you cannot use host names in the grant tables: except for `localhost`, you must use IP numbers instead. If you are using an old version of MySQL that does not support `--force`, you must manually remove the `resolveip` test in `mysql_install_db` using a text editor.

- You also may see the following error when you try to run `mysqld` with the `--user` option:

```
getpwnam: No such file or directory
```

To work around this problem, start `mysqld` by using the `su` command rather than by specifying the `--user` option. This causes the system itself to change the user ID of the `mysqld` process so that `mysqld` need not do so.

Another solution, which solves both problems, is not to use a binary distribution. Obtain a MySQL source distribution (in RPM or `tar.gz` format) and install that instead.

On some Linux 2.2 versions, you may get the error `Resource temporarily unavailable` when clients make a great many new connections to a `mysqld` server over TCP/IP. The problem is that Linux has a delay between the time that you close a TCP/IP socket and the time that the system actually frees it. There is room for only a finite number of TCP/IP slots, so you encounter the resource-unavailable error if clients attempt too many new TCP/IP connections over a short period of time. For example, you may see the error when you run the MySQL `test-connect` benchmark over TCP/IP.

We have inquired about this problem a few times on different Linux mailing lists but have never been able to find a suitable resolution. The only known "fix" is for clients to use persistent connections, or, if you are running the database server and clients on the same machine, to use Unix socket file connections rather than TCP/IP connections.

## 2.13.1.3. Linux Source Distribution Notes

The following notes regarding `glibc` apply only to the situation when you build MySQL yourself. If you are running Linux on an x86 machine, in most cases it is much better for you to use our binary. We link our binaries against the best patched version of `glibc` we can find and with the best compiler options, in an attempt to make it suitable for a high-load server. For a typical user, even for setups with a lot of concurrent connections or tables exceeding the 2GB limit, our binary is the best choice in most cases. After reading the following text, if you are in doubt about what to do, try our binary first to determine whether it meets your needs. If you discover that it is not good enough, you may want to try your own build. In that case, we would appreciate a note about it so that we can build a better binary next time.

MySQL uses LinuxThreads on Linux. If you are using an old Linux version that doesn't have `glibc2`, you must install LinuxThreads before trying to compile MySQL. You can obtain LinuxThreads from <http://dev.mysql.com/downloads/os-linux.html>.

Note that `glibc` versions before and including version 2.1.1 have a fatal bug in `pthread_mutex_timedwait()` handling, which is used when `INSERT DELAYED` statements are issued. We recommend that you not use `INSERT DELAYED` before upgrading `glibc`.

Note that Linux kernel and the LinuxThread library can by default handle a maximum of 1,024 threads. If you plan to have more than 1,000 concurrent connections, you need to make some changes to LinuxThreads, as follows:

- Increase `PTHREAD_THREADS_MAX` in `sysdeps/unix/sysv/linux/bits/local_lim.h` to 4096 and decrease `STACK_SIZE` in `linuxthreads/internals.h` to 256KB. The paths are relative to the root of `glibc`. (Note that MySQL is not stable with 600-1000 connections if `STACK_SIZE` is the default of 2MB.)
- Recompile LinuxThreads to produce a new `libpthread.a` library, and relink MySQL against it.

There is another issue that greatly hurts MySQL performance, especially on SMP systems. The mutex implementation in LinuxThreads in `glibc 2.1` is very poor for programs with many threads that hold the mutex only for a short time. This produces a paradoxical result: If you link MySQL against an unmodified LinuxThreads, removing processors from an SMP actually improves MySQL performance in many cases. We have made a patch available for `glibc 2.1.3` to correct this behavior (<http://dev.mysql.com/Downloads/Linux/linuxthreads-2.1-patch>).

With `glibc 2.2.2`, MySQL uses the adaptive mutex, which is much better than even the patched one in `glibc 2.1.3`. Be warned, however, that under some conditions, the current mutex code in `glibc 2.2.2` overspins, which hurts MySQL performance. The likelihood that this condition occurs can be reduced by re-nicing the `mysqld` process to the highest priority. We have also been able to correct the overspin behavior with a patch, available at <http://dev.mysql.com/Downloads/Linux/linuxthreads-2.2.2.patch>. It combines the correction of overspin, maximum number of threads, and stack spacing all in one. You need to apply it in the `linuxthreads` directory with `patch -p0 </tmp/linuxthreads-2.2.2.patch`. We hope it is included in some form in future releases of `glibc 2.2`. In any case, if you link against `glibc 2.2.2`, you still need to correct `STACK_SIZE` and `PTHREAD_THREADS_MAX`. We hope that the defaults is corrected to some more acceptable values for high-load MySQL setup in the future, so that the commands needed to produce your own build can be reduced to `./configure; make; make install`.

We recommend that you use these patches to build a special static version of `libpthread.a` and use it only for statically linking against MySQL. We know that these patches are safe for MySQL and significantly improve its performance, but we cannot say anything about their effects on other applications. If you link other applications that require LinuxThreads against the patched static version of the library, or build a patched shared version and install it on your system, you do so at your own risk.

If you experience any strange problems during the installation of MySQL, or with some common utilities hanging, it is very likely that they are either library or compiler related. If this is the case, using our binary resolves them.

If you link your own MySQL client programs, you may see the following error at runtime:

```
ld.so.1: fatal: libmysqlclient.so.#:
open failed: No such file or directory
```

This problem can be avoided by one of the following methods:

- Link clients with the `-Wl,r/full/path/to/libmysqlclient.so` flag rather than with `-Lpath`.
- Copy `libmysqlclient.so` to `/usr/lib`.
- Add the path name of the directory where `libmysqlclient.so` is located to the `LD_RUN_PATH` environment variable before running your client.

If you are using the Fujitsu compiler (`fcc/FCC`), you may have some problems compiling MySQL because the Linux header files are very `gcc` oriented. The following `configure` line should work with `fcc/FCC`:

```
CC=fcc CFLAGS="-O -K fast -K lib -K omitfp -Kpreex -D_GNU_SOURCE \
-DCONST=const -DNO_STRTOLL_PROTO" \
CXX=fcc CXXFLAGS="-O -K fast -K lib \
-K omitfp -K preex --no_exceptions --no_rtti -D_GNU_SOURCE \
-DCONST=const -Dalloca=__builtin_alloca -DNO_STRTOLL_PROTO \
'-D_EXTERN_INLINE=static __inline'" \
./configure \
--prefix=/usr/local/mysql --enable-assembler \
--with-mysqld-ldflags=-all-static --disable-shared \
--with-low-memory
```



### 2.13.1.4. Linux Post-Installation Notes

`mysql.server` can be found in the `support-files` directory under the MySQL installation directory or in a MySQL source tree. You can install it as `/etc/init.d/mysql` for automatic MySQL startup and shutdown. See [Section 2.11.2.2, “Starting and Stopping MySQL Automatically”](#).

If MySQL cannot open enough files or connections, it may be that you have not configured Linux to handle enough files.

In Linux 2.2 and onward, you can check the number of allocated file handles as follows:

```
shell> cat /proc/sys/fs/file-max
shell> cat /proc/sys/fs/dquot-max
shell> cat /proc/sys/fs/super-max
```

If you have more than 16MB of memory, you should add something like the following to your init scripts (for example, `/etc/init.d/boot.local` on SuSE Linux):

```
echo 65536 > /proc/sys/fs/file-max
echo 8192 > /proc/sys/fs/dquot-max
echo 1024 > /proc/sys/fs/super-max
```

You can also run the `echo` commands from the command line as `root`, but these settings are lost the next time your computer restarts.

Alternatively, you can set these parameters on startup by using the `sysctl` tool, which is used by many Linux distributions (including SuSE Linux 8.0 and later). Put the following values into a file named `/etc/sysctl.conf`:

```
# Increase some values for MySQL
fs.file-max = 65536
fs.dquot-max = 8192
fs.super-max = 1024
```

You should also add the following to `/etc/my.cnf`:

```
[mysqld_safe]
open-files-limit=8192
```

This should allow the server a limit of 8,192 for the combined number of connections and open files.

The `STACK_SIZE` constant in LinuxThreads controls the spacing of thread stacks in the address space. It needs to be large enough so that there is plenty of room for each individual thread stack, but small enough to keep the stack of some threads from running into the global `mysqld` data. Unfortunately, as we have experimentally discovered, the Linux implementation of `mmap()` successfully unmaps a mapped region if you ask it to map out an address currently in use, zeroing out the data on the entire page instead of returning an error. So, the safety of `mysqld` or any other threaded application depends on the “gentlemanly” behavior of the code that creates threads. The user must take measures to make sure that the number of running threads at any given time is sufficiently low for thread stacks to stay away from the global heap. With `mysqld`, you should enforce this behavior by setting a reasonable value for the `max_connections` variable.

If you build MySQL yourself, you can patch LinuxThreads for better stack use. See [Section 2.13.1.3, “Linux Source Distribution Notes”](#). If you do not want to patch LinuxThreads, you should set `max_connections` to a value no higher than 500. It should be even less if you have a large key buffer, large heap tables, or some other things that make `mysqld` allocate a lot of memory, or if you are running a 2.2 kernel with a 2GB patch. If you are using our binary or RPM version, you can safely set `max_connections` at 1500, assuming no large key buffer or heap tables with lots of data. The more you reduce `STACK_SIZE` in LinuxThreads the more threads you can safely create. We recommend values between 128KB and 256KB.

If you use a lot of concurrent connections, you may suffer from a “feature” in the 2.2 kernel that attempts to prevent fork bomb attacks by penalizing a process for forking or cloning a child. This causes MySQL not to scale well as you increase the number of concurrent clients. On single-CPU systems, we have seen this manifest as very slow thread creation; it may take a long time to connect to MySQL (as long as one minute), and it may take just as long to shut it down. On multiple-CPU systems, we have observed a gradual drop in query speed as the number of clients increases. In the process of trying to find a solution, we have received a kernel patch from one of our users who claimed it helped for his site. This patch is available at <http://dev.mysql.com/Downloads/Patches/linux-fork.patch>. We have done rather extensive testing of this patch on both development and production systems. It has significantly improved MySQL performance without causing any problems and we recommend it to our users who still run high-load servers on 2.2 kernels.

This issue has been fixed in the 2.4 kernel, so if you are not satisfied with the current performance of your system, rather than patching your 2.2 kernel, it might be easier to upgrade to 2.4. On SMP systems, upgrading also gives you a nice SMP boost in addition to fixing the fairness bug.

We have tested MySQL on the 2.4 kernel on a two-CPU machine and found MySQL scales *much* better. There was virtually no slowdown on query throughput all the way up to 1,000 clients, and the MySQL scaling factor (computed as the ratio of maximum



throughput to the throughput for one client) was 180%. We have observed similar results on a four-CPU system: Virtually no slow-down as the number of clients was increased up to 1,000, and a 300% scaling factor. Based on these results, for a high-load SMP server using a 2.2 kernel, we definitely recommend upgrading to the 2.4 kernel at this point.

We have discovered that it is essential to run the `mysqld` process with the highest possible priority on the 2.4 kernel to achieve maximum performance. This can be done by adding a `renice -20 $$` command to `mysqld_safe`. In our testing on a four-CPU machine, increasing the priority resulted in a 60% throughput increase with 400 clients.

We are currently also trying to collect more information on how well MySQL performs with a 2.4 kernel on four-way and eight-way systems. If you have access such a system and have done some benchmarks, please send an email message to [<benchmarks@mysql.com>](mailto:benchmarks@mysql.com) with the results. We will review them for inclusion in the manual.

If you see a dead `mysqld` server process with `ps`, this usually means that you have found a bug in MySQL or you have a corrupted table. See [Section B.1.4.2, “What to Do If MySQL Keeps Crashing”](#).

To get a core dump on Linux if `mysqld` dies with a `SIGSEGV` signal, you can start `mysqld` with the `--core-file` option. Note that you also probably need to raise the core file size by adding `ulimit -c 1000000` to `mysqld_safe` or starting `mysqld_safe` with `--core-file-size=1000000`. See [Section 4.3.2, “mysqld\\_safe — MySQL Server Startup Script”](#).

### 2.13.1.5. Linux x86 Notes

MySQL requires `libc` 5.4.12 or newer. It is known to work with `libc` 5.4.46. `glibc` 2.0.6 and later should also work. There have been some problems with the `glibc` RPMs from Red Hat, so if you have problems, check whether there are any updates. The `glibc` 2.0.7-19 and 2.0.7-29 RPMs are known to work.

If you are using Red Hat 8.0 or a new `glibc` 2.2.x library, you may see `mysqld` die in `gethostbyaddr()`. This happens because the new `glibc` library requires a stack size greater than 128KB for this call. To fix the problem, start `mysqld` with the `-thread-stack=192K` option. (Use `-O thread_stack=192K` before MySQL 4.) This stack size is the default on MySQL 4.0.10 and above, so you should not see the problem.

If you are using `gcc` 3.0 and above to compile MySQL, you must install the `libstdc++v3` library before compiling MySQL; if you don't do this, you get an error about a missing `__cxa_pure_virtual` symbol during linking.

On some older Linux distributions, `configure` may produce an error like this:

```
Syntax error in sched.h. Change _P to __P in the
/usr/include/sched.h file.
See the Installation chapter in the Reference Manual.
```

Just do what the error message says. Add an extra underscore to the `_P` macro name that has only one underscore, and then try again.

You may get some warnings when compiling. Those shown here can be ignored:

```
mysqld.cc -o objs-thread/mysqld.o
mysqld.cc: In function `void init_signals()':
mysqld.cc:315: warning: assignment of negative value `-1' to
`long unsigned int'
mysqld.cc: In function `void * signal_hand(void *)':
mysqld.cc:346: warning: assignment of negative value `-1' to
`long unsigned int'
```

If `mysqld` always dumps core when it starts, the problem may be that you have an old `/lib/libc.a`. Try renaming it, and then remove `sql/mysqld` and do a new `make install` and try again. This problem has been reported on some Slackware installations.

If you get the following error when linking `mysqld`, it means that your `libg++.a` is not installed correctly:

```
/usr/lib/libc.a(putc.o): In function `_IO_putc':
putc.o(.text+0x0): multiple definition of `_IO_putc'
```

You can avoid using `libg++.a` by running `configure` like this:

```
shell> CXX=gcc ./configure
```

### 2.13.1.6. Linux SPARC Notes

In some implementations, `readdir_r()` is broken. The symptom is that the `SHOW DATABASES` statement always returns an empty set. This can be fixed by removing `HAVE_READDIR_R` from `config.h` after configuring and before compiling.

### 2.13.1.7. Linux Alpha Notes

We have tested MySQL 5.1 on Alpha with our benchmarks and test suite, and it appears to work well.

We currently build the MySQL binary packages on SuSE Linux 7.0 for AXP, kernel 2.4.4-SMP, Compaq C compiler (V6.2-505) and Compaq C++ compiler (V6.3-006) on a Compaq DS20 machine with an Alpha EV6 processor.

You can find the preceding compilers at <http://www.support.compaq.com/alpha-tools/>. By using these compilers rather than `gcc`, we get about 9-14% better MySQL performance.

For MySQL on Alpha, we use the `-arch generic` flag to our compile options, which ensures that the binary runs on all Alpha processors. We also compile statically to avoid library problems. The `configure` command looks like this:

```
CC=ccc CFLAGS="-fast -arch generic" CXX=cxx \
CXXFLAGS="-fast -arch generic -noexceptions -nortti" \
./configure --prefix=/usr/local/mysql --disable-shared \
--with-extra-charsets=complex --enable-thread-safe-client \
--with-mysqld-ldflags=-non_shared --with-client-ldflags=-non_shared
```

Some known problems when running MySQL on Linux-Alpha:

- Debugging threaded applications like MySQL does not work with `gdb 4.18`. You should use `gdb 5.1` instead.
- If you try linking `mysqld` statically when using `gcc`, the resulting image dumps core at startup time. In other words, *do not* use `--with-mysqld-ldflags=-all-static` with `gcc`.

### 2.13.1.8. Linux PowerPC Notes

MySQL should work on MkLinux with the newest `glibc` package (tested with `glibc 2.0.7`).

### 2.13.1.9. Linux MIPS Notes

To get MySQL to work on Qube2 (Linux Mips), you need the newest `glibc` libraries. `glibc-2.0.7-29C2` is known to work. You must also use `gcc 2.95.2` or newer).

### 2.13.1.10. Linux IA-64 Notes

To get MySQL to compile on Linux IA-64, we use the following `configure` command for building with `gcc 2.96`:

```
CC=gcc \
CFLAGS="-O3 -fno-omit-frame-pointer" \
CXX=gcc \
CXXFLAGS="-O3 -fno-omit-frame-pointer -felide-constructors \
-fno-exceptions -fno-rtti" \
./configure --prefix=/usr/local/mysql \
--with-comment=Official MySQL binary" \
--with-extra-charsets=complex
```

On IA-64, the MySQL client binaries use shared libraries. This means that if you install our binary distribution at a location other than `/usr/local/mysql`, you need to add the path of the directory where you have `libmysqlclient.so` installed either to the `/etc/ld.so.conf` file or to the value of your `LD_LIBRARY_PATH` environment variable.

See [Section B.1.3.1, "Problems Linking to the MySQL Client Library"](#).

### 2.13.1.11. SELinux Notes

RHEL4 comes with SELinux, which supports tighter access control for processes. If SELinux is enabled (`SELINUX` in `/etc/selinux/config` is set to `enforcing`, `SELINUXTYPE` is set to either `targeted` or `strict`), you might encounter problems installing MySQL AB RPM packages.

Red Hat has an update that solves this. It involves an update of the "security policy" specification to handle the install structure of the RPMs provided by MySQL AB. For further information, see [https://bugzilla.redhat.com/bugzilla/show\\_bug.cgi?id=167551](https://bugzilla.redhat.com/bugzilla/show_bug.cgi?id=167551) and <http://rhn.redhat.com/errata/RHBA-2006-0049.html>.

The preceding discussion applies only to RHEL4. The patch is unnecessary for RHEL5.

## 2.13.2. Mac OS X Notes

On Mac OS X, `tar` cannot handle long file names. If you need to unpack a `.tar.gz` distribution, use `gnutar` instead.

### 2.13.2.1. Mac OS X 10.x (Darwin)

MySQL should work without major problems on Mac OS X 10.x (Darwin).

Known issues:

- If you have problems with performance under heavy load, try using the `--skip-thread-priority` option to `mysqld`. This runs all threads with the same priority. On Mac OS X, this gives better performance, at least until Apple fixes its thread scheduler.
- The connection times (`wait_timeout`, `interactive_timeout` and `net_read_timeout`) values are not honored.

This is probably a signal handling problem in the thread library where the signal doesn't break a pending read and we hope that a future update to the thread libraries will fix this.

Our binary for Mac OS X is compiled on Darwin 6.3 with the following `configure` line:

```
CC=gcc CFLAGS="-O3 -fno-omit-frame-pointer" CXX=gcc \
CXXFLAGS="-O3 -fno-omit-frame-pointer -felide-constructors \
-fno-exceptions -fno-rtti" \
./configure --prefix=/usr/local/mysql \
--with-extra-charsets=complex --enable-thread-safe-client \
--enable-local-infile --disable-shared
```

See [Section 2.5, "Installing MySQL on Mac OS X"](#).

### 2.13.2.2. Mac OS X Server 1.2 (Rhapsody)

For current versions of Mac OS X Server, no operating system changes are necessary before compiling MySQL. Compiling for the Server platform is the same as for the client version of Mac OS X.

For older versions (Mac OS X Server 1.2, a.k.a. Rhapsody), you must first install a pthread package before trying to configure MySQL.

See [Section 2.5, "Installing MySQL on Mac OS X"](#).

### 2.13.3. Solaris Notes

For information about installing MySQL on Solaris using PKG distributions, see [Section 2.6, "Installing MySQL on Solaris"](#).

On Solaris, you may run into trouble even before you get the MySQL distribution unpacked, as the Solaris `tar` cannot handle long file names. This means that you may see errors when you try to unpack MySQL.

If this occurs, you must use GNU `tar` (`gtar`) to unpack the distribution.

Sun native threads work only on Solaris 2.5 and higher. For Solaris 2.4 and earlier, MySQL automatically uses MIT-pthreads. See [Section 2.10.5, "MIT-pthreads Notes"](#).

If you get the following error from `configure`, it means that you have something wrong with your compiler installation:

```
checking for restartable system calls... configure: error can not
run test programs while cross compiling
```

In this case, you should upgrade your compiler to a newer version. You may also be able to solve this problem by inserting the following row into the `config.cache` file:

```
ac_cv_sys_restartable_syscalls=${ac_cv_sys_restartable_syscalls='no'}
```

If you are using Solaris on a SPARC, the recommended compiler is `gcc` 2.95.2 or 3.2. You can find this at <http://gcc.gnu.org/>. Note that `gcc` 2.8.1 does not work reliably on SPARC.

The recommended `configure` line when using `gcc` 2.95.2 is:

```
CC=gcc CFLAGS="-O3" \
CXX=gcc CXXFLAGS="-O3 -felide-constructors -fno-exceptions -fno-rtti" \
./configure --prefix=/usr/local/mysql --with-low-memory \
--enable-assembler
```

If you have an UltraSPARC system, you can get 4% better performance by adding `-mcpu=v8 -Wa,-xarch=v8plusa` to the `CFLAGS` and `CXXFLAGS` environment variables.

If you have Sun's Forte 5.0 (or newer) compiler, you can run `configure` like this:

```
CC=cc CFLAGS="-Xa -fast -native -xstrconst -mt" \
CXX=CC CXXFLAGS="-noex -mt" \
./configure --prefix=/usr/local/mysql --enable-asmbler
```

To create a 64-bit binary with Sun's Forte compiler, use the following configuration options:

```
CC=cc CFLAGS="-Xa -fast -native -xstrconst -mt -xarch=v9" \
CXX=CC CXXFLAGS="-noex -mt -xarch=v9" ASFLAGS="-xarch=v9" \
./configure --prefix=/usr/local/mysql --enable-asmbler
```

To create a 64-bit Solaris binary using `gcc`, add `-m64` to `CFLAGS` and `CXXFLAGS` and remove `--enable-asmbler` from the `configure` line.

In the MySQL benchmarks, we obtained a 4% speed increase on UltraSPARC when using Forte 5.0 in 32-bit mode, as compared to using `gcc` 3.2 with the `-mcpu` flag.

If you create a 64-bit `mysqld` binary, it is 4% slower than the 32-bit binary, but can handle more threads and memory.

When using Solaris 10 for `x86_64`, you should mount any file systems on which you intend to store `InnoDB` files with the `for-cedirectio` option. (By default mounting is done without this option.) Failing to do so will cause a significant drop in performance when using the `InnoDB` storage engine on this platform.

If you get a problem with `fdatasync` or `sched_yield`, you can fix this by adding `LIBS=-lrt` to the `configure` line

For compilers older than WorkShop 5.3, you might have to edit the `configure` script. Change this line:

```
#if !defined(__STDC__) || __STDC__ != 1
```

To this:

```
#if !defined(__STDC__)
```

If you turn on `__STDC__` with the `-Xc` option, the Sun compiler can't compile with the Solaris `pthread.h` header file. This is a Sun bug (broken compiler or broken include file).

If `mysqld` issues the following error message when you run it, you have tried to compile MySQL with the Sun compiler without enabling the `-mt` multi-thread option:

```
libc internal error: _rmutex_unlock: rmutex not held
```

Add `-mt` to `CFLAGS` and `CXXFLAGS` and recompile.

If you are using the SFW version of `gcc` (which comes with Solaris 8), you must add `/opt/sfw/lib` to the environment variable `LD_LIBRARY_PATH` before running `configure`.

If you are using the `gcc` available from `sunfreeware.com`, you may have many problems. To avoid this, you should recompile `gcc` and GNU `binutils` on the machine where you are running them.

If you get the following error when compiling MySQL with `gcc`, it means that your `gcc` is not configured for your version of Solaris:

```
shell> gcc -O3 -g -O2 -DDEBUG_OFF -o thr_alarm ...
./thr_alarm.c: In function `signal_hand':
./thr_alarm.c:556: too many arguments to function `sigwait'
```

The proper thing to do in this case is to get the newest version of `gcc` and compile it with your current `gcc` compiler. At least for Solaris 2.5, almost all binary versions of `gcc` have old, unusable include files that break all programs that use threads, and possibly other programs as well.

Solaris does not provide static versions of all system libraries (`libpthreads` and `libdl`), so you cannot compile MySQL with `--static`. If you try to do so, you get one of the following errors:

```
ld: fatal: library -ldl: not found
undefined reference to `dlopen'
cannot find -lrt
```

If you link your own MySQL client programs, you may see the following error at runtime:

```
ld.so.1: fatal: libmysqlclient.so.#: 
```

```
open failed: No such file or directory
```

This problem can be avoided by one of the following methods:

- Link clients with the `-Wl,r/full/path/to/libmysqlclient.so` flag rather than with `-Lpath`).
- Copy `libmysqlclient.so` to `/usr/lib`.
- Add the path name of the directory where `libmysqlclient.so` is located to the `LD_RUN_PATH` environment variable before running your client.

If you have problems with `configure` trying to link with `-lz` when you don't have `zlib` installed, you have two options:

- If you want to be able to use the compressed communication protocol, you need to get and install `zlib` from [ftp.gnu.org](http://ftp.gnu.org).
- Run `configure` with the `--with-named-z-libs=no` option when building MySQL.

If you are using `gcc` and have problems with loading user-defined functions (UDFs) into MySQL, try adding `-lgcc` to the link line for the UDF.

If you would like MySQL to start automatically, you can copy `support-files/mysql.server` to `/etc/init.d` and create a symbolic link to it named `/etc/rc3.d/S99mysql.server`.

If too many processes try to connect very rapidly to `mysqld`, you should see this error in the MySQL log:

```
Error in accept: Protocol error
```

You might try starting the server with the `--back_log=50` option as a workaround for this. (Use `-O back_log=50` before MySQL 4.)

Solaris doesn't support core files for `setuid()` applications, so you can't get a core file from `mysqld` if you are using the `-user` option.

### 2.13.3.1. Solaris 2.7/2.8 Notes

Normally, you can use a Solaris 2.6 binary on Solaris 2.7 and 2.8. Most of the Solaris 2.6 issues also apply for Solaris 2.7 and 2.8.

MySQL should be able to detect new versions of Solaris automatically and enable workarounds for the following problems.

Solaris 2.7 / 2.8 has some bugs in the include files. You may see the following error when you use `gcc`:

```
/usr/include/widec.h:42: warning: `getwc' redefined
/usr/include/wchar.h:326: warning: this is the location of the previous
definition
```

If this occurs, you can fix the problem by copying `/usr/include/widec.h` to `.../lib/gcc-lib/os/gcc-version/include` and changing line 41 from this:

```
#if !defined(lint) && !defined(__lint)
```

To this:

```
#if !defined(lint) && !defined(__lint) && !defined(getwc)
```

Alternatively, you can edit `/usr/include/widec.h` directly. Either way, after you make the fix, you should remove `config.cache` and run `configure` again.

If you get the following errors when you run `make`, it is because `configure` didn't detect the `curses.h` file (probably because of the error in `/usr/include/widec.h`):

```
In file included from mysql.cc:50:
/usr/include/term.h:1060: syntax error before `;'
/usr/include/term.h:1081: syntax error before `;'
```

The solution to this problem is to do one of the following:

- Configure with `CFLAGS=-DHAVE_CURSES_H CXXFLAGS=-DHAVE_CURSES_H ./configure`.
- Edit `/usr/include/widec.h` as indicated in the preceding discussion and re-run `configure`.
- Remove the `#define HAVE_TERM` line from the `config.h` file and run `make` again.

If your linker cannot find `-lz` when linking client programs, the problem is probably that your `libz.so` file is installed in `/usr/local/lib`. You can fix this problem by one of the following methods:

- Add `/usr/local/lib` to `LD_LIBRARY_PATH`.
- Add a link to `libz.so` from `/lib`.
- If you are using Solaris 8, you can install the optional `zlib` from your Solaris 8 CD distribution.
- Run `configure` with the `--with-named-z-libs=no` option when building MySQL.

### 2.13.3.2. Solaris x86 Notes

On Solaris 8 on x86, `mysqld` dumps core if you remove the debug symbols using `strip`.

If you are using `gcc` on Solaris x86 and you experience problems with core dumps under load, you should use the following `configure` command:

```
CC=gcc CFLAGS="-O3 -fomit-frame-pointer -DHAVE_CURSES_H" \
CXX=gcc \
CXXFLAGS="-O3 -fomit-frame-pointer -felide-constructors \
-fno-exceptions -fno-rtti -DHAVE_CURSES_H" \
./configure --prefix=/usr/local/mysql
```

This avoids problems with the `libstdc++` library and with C++ exceptions.

If this doesn't help, you should compile a debug version and run it with a trace file or under `gdb`. See [MySQL Internals: Porting](#).

## 2.13.4. BSD Notes

This section provides information about using MySQL on variants of BSD Unix.

### 2.13.4.1. FreeBSD Notes

FreeBSD 4.x or newer is recommended for running MySQL, because the thread package is much more integrated. To get a secure and stable system, you should use only FreeBSD kernels that are marked `-RELEASE`.

The easiest (and preferred) way to install MySQL is to use the `mysql-server` and `mysql-client` ports available at <http://www.freebsd.org/>. Using these ports gives you the following benefits:

- A working MySQL with all optimizations enabled that are known to work on your version of FreeBSD.
- Automatic configuration and build.
- Startup scripts installed in `/usr/local/etc/rc.d`.
- The ability to use `pkg_info -L` to see which files are installed.
- The ability to use `pkg_delete` to remove MySQL if you no longer want it on your machine.

It is recommended you use MIT-pthreads on FreeBSD 2.x, and native threads on FreeBSD 3 and up. It is possible to run with native threads on some late 2.2.x versions, but you may encounter problems shutting down `mysqld`.

Unfortunately, certain function calls on FreeBSD are not yet fully thread-safe. Most notably, this includes the `gethostbyname()` function, which is used by MySQL to convert host names into IP addresses. Under certain circumstances, the `mysqld` process suddenly causes 100% CPU load and is unresponsive. If you encounter this problem, try to start MySQL using the `-skip-name-resolve` option.

Alternatively, you can link MySQL on FreeBSD 4.x against the LinuxThreads library, which avoids a few of the problems that the native FreeBSD thread implementation has. For a very good comparison of LinuxThreads versus native threads, see Jeremy Za-

wodny's article *FreeBSD or Linux for your MySQL Server?* at <http://jeremy.zawodny.com/blog/archives/000697.html>.

Known problem when using LinuxThreads on FreeBSD is:

- The connection times (`wait_timeout`, `interactive_timeout` and `net_read_timeout`) values are not honored. The symptom is that persistent connections can hang for a very long time without getting closed down and that a 'kill' for a thread will not take affect until the thread does it a new command

This is probably a signal handling problem in the thread library where the signal doesn't break a pending read. This is supposed to be fixed in FreeBSD 5.0

The MySQL build process requires GNU make (`gmake`) to work. If GNU `make` is not available, you must install it first before compiling MySQL.

The recommended way to compile and install MySQL on FreeBSD with `gcc` (2.95.2 and up) is:

```
CC=gcc CFLAGS="-O2 -fno-strength-reduce" \
CXX=gcc CXXFLAGS="-O2 -fno-rtti -fno-exceptions \
-felide-constructors -fno-strength-reduce" \
./configure --prefix=/usr/local/mysql --enable-asm
gmake
gmake install
cd /usr/local/mysql
bin/mysql_install_db --user=mysql
bin/mysqld_safe &
```

If you notice that `configure` uses MIT-pthreads, you should read the MIT-pthreads notes. See [Section 2.10.5, "MIT-pthreads Notes"](#).

If you get an error from `make install` that it can't find `/usr/include/pthreads`, `configure` didn't detect that you need MIT-pthreads. To fix this problem, remove `config.cache`, and then re-run `configure` with the `-with-mit-threads` option.

Be sure that your name resolver setup is correct. Otherwise, you may experience resolver delays or failures when connecting to `mysqld`. Also make sure that the `localhost` entry in the `/etc/hosts` file is correct. The file should start with a line similar to this:

```
127.0.0.1 localhost localhost.your.domain
```

FreeBSD is known to have a very low default file handle limit. See [Section B.1.2.18, "'FILE' NOT FOUND and Similar Errors"](#). Start the server by using the `--open-files-limit` option for `mysqld_safe`, or raise the limits for the `mysqld` user in `/etc/login.conf` and rebuild it with `cap_mkdb /etc/login.conf`. Also be sure that you set the appropriate class for this user in the password file if you are not using the default (use `chpass mysqld-user-name`). See [Section 4.3.2, "mysqld\\_safe — MySQL Server Startup Script"](#).

FreeBSD limits the size of a process to 512MB, even if you have much more RAM available on the system. So you may get an error such as this:

```
Out of memory (Needed 16391 bytes)
```

In current versions of FreeBSD (at least 4.x and greater), you may increase this limit by adding the following entries to the `/boot/loader.conf` file and rebooting the machine (these are not settings that can be changed at run time with the `sysctl` command):

```
kern.maxdsiz="1073741824" # 1GB
kern.dfldsiz="1073741824" # 1GB
kern.maxssiz="134217728" # 128MB
```

For older versions of FreeBSD, you must recompile your kernel to change the maximum data segment size for a process. In this case, you should look at the `MAXDSIZ` option in the `LINT` config file for more information.

If you get problems with the current date in MySQL, setting the `TZ` variable should help. See [Section 2.14, "Environment Variables"](#).

### 2.13.4.2. NetBSD Notes

To compile on NetBSD, you need GNU `make`. Otherwise, the build process fails when `make` tries to run `lint` on C++ files.

### 2.13.4.3. OpenBSD 2.5 Notes



On OpenBSD 2.5, you can compile MySQL with native threads with the following options:

```
CFLAGS=-pthread CXXFLAGS=-pthread ./configure --with-mit-threads=no
```

#### 2.13.4.4. BSD/OS Version 2.x Notes

If you get the following error when compiling MySQL, your `ulimit` value for virtual memory is too low:

```
item_func.h: In method
`Item_func_ge::Item_func_ge(const Item_func_ge &)':
item_func.h:28: virtual memory exhausted
make[2]: *** [item_func.o] Error 1
```

Try using `ulimit -v 80000` and run `make` again. If this doesn't work and you are using `bash`, try switching to `csch` or `sh`; some BSDI users have reported problems with `bash` and `ulimit`.

If you are using `gcc`, you may also use have to use the `--with-low-memory` flag for `configure` to be able to compile `sql_yacc.cc`.

If you get problems with the current date in MySQL, setting the `TZ` variable should help. See [Section 2.14, "Environment Variables"](#).

#### 2.13.4.5. BSD/OS Version 3.x Notes

Upgrade to BSD/OS 3.1. If that is not possible, install BSDIpatch M300-038.

Use the following command when configuring MySQL:

```
env CXX=shlicc++ CC=shlicc2 \
./configure \
--prefix=/usr/local/mysql \
--localstatedir=/var/mysql \
--without-perl \
--with-unix-socket-path=/var/mysql/mysql.sock
```

The following is also known to work:

```
env CC=gcc CXX=gcc CXXFLAGS=-O3 \
./configure \
--prefix=/usr/local/mysql \
--with-unix-socket-path=/var/mysql/mysql.sock
```

You can change the directory locations if you wish, or just use the defaults by not specifying any locations.

If you have problems with performance under heavy load, try using the `--skip-thread-priority` option to `mysqld`. This runs all threads with the same priority. On BSDI 3.1, this gives better performance, at least until BSDI fixes its thread scheduler.

If you get the error `virtual memory exhausted` while compiling, you should try using `ulimit -v 80000` and running `make` again. If this doesn't work and you are using `bash`, try switching to `csch` or `sh`; some BSDI users have reported problems with `bash` and `ulimit`.

#### 2.13.4.6. BSD/OS Version 4.x Notes

BSDI 4.x has some thread-related bugs. If you want to use MySQL on this, you should install all thread-related patches. At least M400-023 should be installed.

On some BSDI 4.x systems, you may get problems with shared libraries. The symptom is that you can't execute any client programs, for example, `mysqladmin`. In this case, you need to reconfigure not to use shared libraries with the `-disable-shared` option to configure.

Some customers have had problems on BSDI 4.0.1 that the `mysqld` binary after a while can't open tables. This occurs because some library/system-related bug causes `mysqld` to change current directory without having asked for that to happen.

The fix is to either upgrade MySQL to at least version 3.23.34 or, after running `configure`, remove the line `#define HAVE_REALPATH` from `config.h` before running `make`.

Note that this means that you can't symbolically link a database directories to another database directory or symbolic link a table to another database on BSDI. (Making a symbolic link to another disk is okay).

### 2.13.5. Other Unix Notes

### 2.13.5.1. HP-UX Version 10.20 Notes

If you install MySQL using a binary tarball distribution on HP-UX, you may run into trouble even before you get the MySQL distribution unpacked, as the HP-UX `tar` cannot handle long file names. This means that you may see errors when you try to unpack MySQL.

If this occurs, you must use GNU `tar` (`gtar`) to unpack the distribution.

There are a couple of small problems when compiling MySQL on HP-UX. We recommend that you use `gcc` instead of the HP-UX native compiler, because `gcc` produces better code.

We recommend using `gcc` 2.95 on HP-UX. Don't use high optimization flags (such as `-O6`) because they may not be safe on HP-UX.

The following `configure` line should work with `gcc` 2.95:

```
CFLAGS="-I/opt/dce/include -fpic" \
CXXFLAGS="-I/opt/dce/include -felide-constructors -fno-exceptions \
-fno-rtti" \
CXX=gcc \
./configure --with-pthread \
--with-named-thread-libs='-ldce' \
--prefix=/usr/local/mysql --disable-shared
```

The following `configure` line should work with `gcc` 3.1:

```
CFLAGS="-DHPUX -I/opt/dce/include -O3 -fPIC" CXX=gcc \
CXXFLAGS="-DHPUX -I/opt/dce/include -felide-constructors \
-fno-exceptions -fno-rtti -O3 -fPIC" \
./configure --prefix=/usr/local/mysql \
--with-extra-charsets=complex --enable-thread-safe-client \
--enable-local-infile --with-pthread \
--with-named-thread-libs=-ldce --with-lib-ccflags=-fPIC \
--disable-shared
```

### 2.13.5.2. HP-UX Version 11.x Notes

If you install MySQL using a binary tarball distribution on HP-UX, you may run into trouble even before you get the MySQL distribution unpacked, as the HP-UX `tar` cannot handle long file names. This means that you may see errors when you try to unpack MySQL.

If this occurs, you must use GNU `tar` (`gtar`) to unpack the distribution.

Because of some critical bugs in the standard HP-UX libraries, you should install the following patches before trying to run MySQL on HP-UX 11.0:

```
PHKL_22840 Streams cumulative
PHNE_22397 ARPA cumulative
```

This solves the problem of getting `EWOULDBLOCK` from `recv()` and `EBADF` from `accept()` in threaded applications.

If you are using `gcc` 2.95.1 on an unpatched HP-UX 11.x system, you may get the following error:

```
In file included from /usr/include/unistd.h:11,
                 from ../include/global.h:125,
                 from mysql_priv.h:15,
                 from item.cc:19:
/usr/include/sys/unistd.h:184: declaration of C function ...
/usr/include/sys/pthread.h:440: previous declaration ...
In file included from item.h:306,
                 from mysql_priv.h:158,
                 from item.cc:19:
```

The problem is that HP-UX does not define `pthread_atfork()` consistently. It has conflicting prototypes in `/usr/include/sys/unistd.h:184` and `/usr/include/sys/pthread.h:440`.

One solution is to copy `/usr/include/sys/unistd.h` into `mysql/include` and edit `unistd.h` and change it to match the definition in `pthread.h`. Look for this line:

```
extern int pthread_atfork(void (*prepare)(), void (*parent)(),
                        void (*child)());
```

Change it to look like this:

```
extern int pthread_atfork(void (*prepare)(void), void (*parent)(void),
```

```
void (*child)(void));
```

After making the change, the following `configure` line should work:

```
CFLAGS="-fomit-frame-pointer -O3 -fpic" CXX=gcc \
CXXFLAGS="-felide-constructors -fno-exceptions -fno-rtti -O3" \
./configure --prefix=/usr/local/mysql --disable-shared
```

If you are using HP-UX compiler, you can use the following command (which has been tested with `cc` B.11.11.04):

```
CC=cc CXX=aCC CFLAGS=+DD64 CXXFLAGS=+DD64 ./configure \
--with-extra-character-set=complex
```

You can ignore any errors of the following type:

```
aCC: warning 901: unknown option: '-3': use +help for online
documentation
```

If you get the following error from `configure`, verify that you don't have the path to the K&R compiler before the path to the HP-UX C and C++ compiler:

```
checking for cc option to accept ANSI C... no
configure: error: MySQL requires an ANSI C compiler (and a C++ compiler).
Try gcc. See the Installation chapter in the Reference Manual.
```

Another reason for not being able to compile is that you didn't define the `+DD64` flags as just described.

Another possibility for HP-UX 11 is to use the MySQL binaries provided at <http://dev.mysql.com/downloads/>, which we have built and tested ourselves. We have also received reports that the HP-UX 10.20 binaries supplied by MySQL can be run successfully on HP-UX 11. If you encounter problems, you should be sure to check your HP-UX patch level.

### 2.13.5.3. IBM-AIX notes

Automatic detection of `xlc` is missing from Autoconf, so a number of variables need to be set before running `configure`. The following example uses the IBM compiler:

```
export CC="xlc_r -ma -O3 -qstrict -goptimize=3 -qmaxmem=8192 "
export CXX="xlc_r -ma -O3 -qstrict -goptimize=3 -qmaxmem=8192"
export CFLAGS="-I /usr/local/include"
export LDFLAGS="-L /usr/local/lib"
export CPPFLAGS=$CFLAGS
export CXXFLAGS=$CFLAGS

./configure --prefix=/usr/local \
--localstatedir=/var/mysql \
--sbindir='/usr/local/bin' \
--libexecdir='/usr/local/bin' \
--enable-thread-safe-client \
--enable-large-files
```

The preceding options are used to compile the MySQL distribution that can be found at <http://www-frec.bull.com/>.

If you change the `-O3` to `-O2` in the preceding `configure` line, you must also remove the `-qstrict` option. This is a limitation in the IBM C compiler.

If you are using `gcc` to compile MySQL, you *must* use the `-fno-exceptions` flag, because the exception handling in `gcc` is not thread-safe! There are also some known problems with IBM's assembler that may cause it to generate bad code when used with `gcc`.

We recommend the following `configure` line with `gcc` 2.95 on AIX:

```
CC="gcc -pipe -mcpu=power -Wa,-many" \
CXX="gcc -pipe -mcpu=power -Wa,-many" \
CXXFLAGS="-felide-constructors -fno-exceptions -fno-rtti" \
./configure --prefix=/usr/local/mysql --with-low-memory
```

The `-Wa, -many` option is necessary for the compile to be successful. IBM is aware of this problem but is in no hurry to fix it because of the workaround that is available. We don't know if the `-fno-exceptions` is required with `gcc` 2.95, but because MySQL doesn't use exceptions and the option generates faster code, we recommend that you should always use it with `gcc`.

If you get a problem with assembler code, try changing the `-mcpu=xxx` option to match your CPU. Typically `power2`, `power`, or `powerpc` may need to be used. Alternatively, you might need to use `604` or `604e`. We are not positive but suspect that `power` would likely be safe most of the time, even on a `power2` machine.

If you don't know what your CPU is, execute a `uname -m` command. It produces a string that looks like `000514676700`, with a format of `xyyyyyymmss` where `xx` and `ss` are always `00`, `yyyyyy` is a unique system ID and `mm` is the ID of the CPU Planar. A chart of these values can be found at [http://www16.boulder.ibm.com/pseries/en\\_US/cmds/aixcmds5/uname.htm](http://www16.boulder.ibm.com/pseries/en_US/cmds/aixcmds5/uname.htm).

This gives you a machine type and a machine model you can use to determine what type of CPU you have.

If you have problems with signals (MySQL dies unexpectedly under high load), you may have found an OS bug with threads and signals. In this case, you can tell MySQL not to use signals by configuring as follows:

```
CFLAGS=-DDONT_USE_THR_ALARM CXX=gcc \
CXXFLAGS="-felide-constructors -fno-exceptions -fno-rtti \
-DDONT_USE_THR_ALARM" \
./configure --prefix=/usr/local/mysql --with-debug \
--with-low-memory
```

This doesn't affect the performance of MySQL, but has the side effect that you can't kill clients that are "sleeping" on a connection with `mysqladmin kill` or `mysqladmin shutdown`. Instead, the client dies when it issues its next command.

On some versions of AIX, linking with `libbind.a` makes `getservbyname()` dump core. This is an AIX bug and should be reported to IBM.

For AIX 4.2.1 and `gcc`, you have to make the following changes.

After configuring, edit `config.h` and `include/my_config.h` and change the line that says this:

```
#define HAVE_SNPRINTF 1
```

to this:

```
#undef HAVE_SNPRINTF
```

And finally, in `mysqld.cc`, you need to add a prototype for `initgroups()`.

```
#ifdef _AIX41
extern "C" int initgroups(const char *,int);
#endif
```

For 32-bit binaries, if you need to allocate a lot of memory to the `mysqld` process, it is not enough to just use `ulimit -d unlimited`. You may also have to modify `mysqld_safe` to add a line something like this:

```
export LDR_CNTRL='MAXDATA=0x80000000'
```

You can find more information about using a lot of memory at [http://publib16.boulder.ibm.com/pseries/en\\_US/aixprg/gd/genprog/lrg\\_prg\\_support.htm](http://publib16.boulder.ibm.com/pseries/en_US/aixprg/gd/genprog/lrg_prg_support.htm).

Users of AIX 4.3 should use `gmake` instead of the `make` utility included with AIX.

As of AIX 4.1, the C compiler has been unbundled from AIX as a separate product. We recommend using `gcc` 3.3.2, which can be obtained here: <ftp://ftp.software.ibm.com/aix/freeSoftware/aixtoolbox/RPMS/ppc/gcc/>

The steps for compiling MySQL on AIX with `gcc` 3.3.2 are similar to those for using `gcc` 2.95 (in particular, the need to edit `config.h` and `my_config.h` after running `configure`). However, before running `configure`, you should also patch the `curses.h` file as follows:

```
/opt/freeware/lib/gcc-lib/powerpc-ibm-aix5.2.0.0/3.3.2/include/curses.h.ORIG
Mon Dec 26 02:17:28 2005
--- /opt/freeware/lib/gcc-lib/powerpc-ibm-aix5.2.0.0/3.3.2/include/curses.h
Mon Dec 26 02:40:13 2005
*****
*** 2023,2029 ****

    #endif /* _AIX32_CURSES */
! #if defined(__USE_FIXED_PROTOTYPES__) || defined(__cplusplus) || defined
(__STRICT_ANSI__)
    extern int delwin (WINDOW *);
    extern int endwin (void);
    extern int getcurx (WINDOW *);
--- 2023,2029 ----

    #endif /* _AIX32_CURSES */
! #if 0 && (defined(__USE_FIXED_PROTOTYPES__) || defined(__cplusplus)
|| defined
(__STRICT_ANSI__))
    extern int delwin (WINDOW *);
    extern int endwin (void);
```

```
extern int getcurx (WINDOW *);
```

### 2.13.5.4. SunOS 4 Notes

On SunOS 4, MIT-pthreads is needed to compile MySQL. This in turn means you need GNU [make](#).

Some SunOS 4 systems have problems with dynamic libraries and [libtool](#). You can use the following [configure](#) line to avoid this problem:

```
./configure --disable-shared --with-mysqld-ldflags=-all-static
```

When compiling [readline](#), you may get warnings about duplicate defines. These can be ignored.

When compiling [mysqld](#), there are some [implicit declaration of function](#) warnings. These can be ignored.

### 2.13.5.5. Alpha-DEC-UNIX Notes (Tru64)

If you are using [egcs](#) 1.1.2 on Digital Unix, you should upgrade to [gcc](#) 2.95.2, because [egcs](#) on DEC has some serious bugs!

When compiling threaded programs under Digital Unix, the documentation recommends using the [-pthread](#) option for [cc](#) and [cxx](#) and the [-lmach](#) [-lexc](#) libraries (in addition to [-lpthread](#)). You should run [configure](#) something like this:

```
CC="cc -pthread" CXX="cxx -pthread -O" \  
./configure --with-named-thread-libs="-lpthread -lmach -lexc -lc"
```

When compiling [mysqld](#), you may see a couple of warnings like this:

```
mysqld.cc: In function void handle_connections():  
mysqld.cc:626: passing long unsigned int *' as argument 3 of  
accept(int,sockaddr *, int *)'
```

You can safely ignore these warnings. They occur because [configure](#) can detect only errors, not warnings.

If you start the server directly from the command line, you may have problems with it dying when you log out. (When you log out, your outstanding processes receive a [SIGHUP](#) signal.) If so, try starting the server like this:

```
nohup mysqld [options] &
```

[nohup](#) causes the command following it to ignore any [SIGHUP](#) signal sent from the terminal. Alternatively, start the server by running [mysqld\\_safe](#), which invokes [mysqld](#) using [nohup](#) for you. See [Section 4.3.2](#), "[mysqld\\_safe — MySQL Server Startup Script](#)".

If you get a problem when compiling [mysys/get\\_opt.c](#), just remove the [#define](#) [\\_NO\\_PROTO](#) line from the start of that file.

If you are using Compaq's CC compiler, the following [configure](#) line should work:

```
CC="cc -pthread"  
CFLAGS="-O4 -ansi_alias -ansi_args -fast -inline speed \  
-speculate all -arch host"  
CXX="cxx -pthread"  
CXXFLAGS="-O4 -ansi_alias -ansi_args -fast -inline speed \  
-speculate all -arch host -noexceptions -nortti"  
export CC CFLAGS CXX CXXFLAGS  
./configure \  
--prefix=/usr/local/mysql \  
--with-low-memory \  
--enable-large-files \  
--enable-shared=yes \  
--with-named-thread-libs="-lpthread -lmach -lexc -lc"  
gnumake
```

If you get a problem with [libtool](#) when compiling with shared libraries as just shown, when linking [mysql](#), you should be able to get around this by issuing these commands:

```
cd mysql  
/bin/sh ../libtool --mode=link cxx -pthread -O3 -DDEBUG_OFF \  
-O4 -ansi_alias -ansi_args -fast -inline speed \  
-speculate all \ -arch host -DUNDEF_HAVE_GETHOSTBYNAME_R \  
-o mysql mysql.o readline.o sql_string.o completion_hash.o \  
../readline/libreadline.a -lcurses \  
../libmysql/.libs/libmysqlclient.so -lm  
cd ..  
gnumake  
gnumake install
```

```
scripts/mysql_install_db
```

### 2.13.5.6. Alpha-DEC-OSF/1 Notes

If you have problems compiling and have DEC `CC` and `gcc` installed, try running `configure` like this:

```
CC=cc CFLAGS=-O CXX=gcc CXXFLAGS=-O3 \
./configure --prefix=/usr/local/mysql
```

If you get problems with the `c_asm.h` file, you can create and use a 'dummy' `c_asm.h` file with:

```
touch include/c_asm.h
CC=gcc CFLAGS=-I./include \
CXX=gcc CXXFLAGS=-O3 \
./configure --prefix=/usr/local/mysql
```

Note that the following problems with the `ld` program can be fixed by downloading the latest DEC (Compaq) patch kit from: <http://ftp.support.compaq.com/public/unix/>.

On OSF/1 V4.0D and compiler "DEC C V5.6-071 on Digital Unix V4.0 (Rev. 878)," the compiler had some strange behavior (undefined `asm` symbols). `/bin/ld` also appears to be broken (problems with `_exit` undefined errors occurring while linking `mysqld`). On this system, we have managed to compile MySQL with the following `configure` line, after replacing `/bin/ld` with the version from OSF 4.0C:

```
CC=gcc CXX=gcc CXXFLAGS=-O3 ./configure --prefix=/usr/local/mysql
```

With the Digital compiler "C++ V6.1-029," the following should work:

```
CC=cc -pthread
CFLAGS=-O4 -ansi_alias -ansi_args -fast -inline speed \
    -speculate all -arch host
CXX=cxx -pthread
CXXFLAGS=-O4 -ansi_alias -ansi_args -fast -inline speed \
    -speculate all -arch host -noexceptions -nortti
export CC CFLAGS CXX CXXFLAGS
./configure --prefix=/usr/mysql/mysql \
    --with-mysqld-ldflags=-all-static --disable-shared \
    --with-named-thread-libs="-lmach -lexc -lc"
```

In some versions of OSF/1, the `alloca()` function is broken. Fix this by removing the line in `config.h` that defines `'HAVE_ALLOCA'`.

The `alloca()` function also may have an incorrect prototype in `/usr/include/alloca.h`. This warning resulting from this can be ignored.

`configure` uses the following thread libraries automatically: `--with-named-thread-libs="-lpthread -lmach -lexc -lc"`.

When using `gcc`, you can also try running `configure` like this:

```
CFLAGS=-D_PTHREAD_USE_D4 CXX=gcc CXXFLAGS=-O3 ./configure ...
```

If you have problems with signals (MySQL dies unexpectedly under high load), you may have found an OS bug with threads and signals. In this case, you can tell MySQL not to use signals by configuring with:

```
CFLAGS=-DDONT_USE_THR_ALARM \
CXXFLAGS=-DDONT_USE_THR_ALARM \
./configure ...
```

This does not affect the performance of MySQL, but has the side effect that you can't kill clients that are "sleeping" on a connection with `mysqladmin kill` or `mysqladmin shutdown`. Instead, the client dies when it issues its next command.

With `gcc 2.95.2`, you may encounter the following compile error:

```
sql_acl.cc:1456: Internal compiler error in `scan_region',
at except.c:2566
Please submit a full bug report.
```

To fix this, you should change to the `sql` directory and do a cut-and-paste of the last `gcc` line, but change `-O3` to `-O0` (or add `-O0` immediately after `gcc` if you don't have any `-O` option on your compile line). After this is done, you can just change back to the top-level directory and run `make` again.

### 2.13.5.7. SGI Irix Notes

As of MySQL 5.0, we don't provide binaries for Irix any more.

If you are using Irix 6.5.3 or newer, `mysqld` is able to create threads only if you run it as a user that has `CAP_SCHED_MGT` privileges (such as `root`) or give the `mysqld` server this privilege with the following shell command:

```
chcap "CAP_SCHED_MGT+epi" /opt/mysql/libexec/mysqld
```

You may have to undefine some symbols in `config.h` after running `configure` and before compiling.

In some Irix implementations, the `alloca()` function is broken. If the `mysqld` server dies on some `SELECT` statements, remove the lines from `config.h` that define `HAVE_ALLOC` and `HAVE_ALLOCA_H`. If `mysqladmin create` doesn't work, remove the line from `config.h` that defines `HAVE_READDIR_R`. You may have to remove the `HAVE_TERM_H` line as well.

SGI recommends that you install all the patches on this page as a set: [http://support.sgi.com/surfzone/patches/patchset/6.2\\_indigo.rps.html](http://support.sgi.com/surfzone/patches/patchset/6.2_indigo.rps.html)

At the very minimum, you should install the latest kernel rollup, the latest `rld` rollup, and the latest `libc` rollup.

You definitely need all the POSIX patches on this page, for pthreads support:

[http://support.sgi.com/surfzone/patches/patchset/6.2\\_posix.rps.html](http://support.sgi.com/surfzone/patches/patchset/6.2_posix.rps.html)

If you get the something like the following error when compiling `mysql.cc`:

```
"/usr/include/curses.h", line 82: error(1084):
invalid combination of type
```

Type the following in the top-level directory of your MySQL source tree:

```
extra/replace bool curses_bool < /usr/include/curses.h > include/curses.h
make
```

There have also been reports of scheduling problems. If only one thread is running, performance is slow. Avoid this by starting another client. This may lead to a two-to-tenfold increase in execution speed thereafter for the other thread. This is a poorly understood problem with Irix threads; you may have to improvise to find solutions until this can be fixed.

If you are compiling with `gcc`, you can use the following `configure` command:

```
CC=gcc CXX=gcc CXXFLAGS=-O3 \
./configure --prefix=/usr/local/mysql --enable-thread-safe-client \
--with-named-thread-libs=lpthread
```

On Irix 6.5.11 with native Irix C and C++ compilers ver. 7.3.1.2, the following is reported to work

```
CC=cc CXX=CC CFLAGS='-O3 -n32 -TARG:platform=IP22 -I/usr/local/include \
-L/usr/local/lib' CXXFLAGS='-O3 -n32 -TARG:platform=IP22 \
-I/usr/local/include -L/usr/local/lib' \
./configure --prefix=/usr/local/mysql --with-innodb \
--with-libwrap=/usr/local \
--with-named-curses-libs=/usr/local/lib/libncurses.a
```

### 2.13.5.8. SCO UNIX and OpenServer 5.0.x Notes

The current port is tested only on `sco3.2v5.0.5`, `sco3.2v5.0.6`, and `sco3.2v5.0.7` systems. There has also been progress on a port to `sco3.2v4.2`. Open Server 5.0.8 (Legend) has native threads and allows files greater than 2GB. The current maximum file size is 2GB.

We have been able to compile MySQL with the following `configure` command on OpenServer with `gcc` 2.95.3.

```
CC=gcc CFLAGS="-D_FILE_OFFSET_BITS=64 -O3" \
CXX=gcc CXXFLAGS="-D_FILE_OFFSET_BITS=64 -O3" \
./configure --prefix=/usr/local/mysql \
--enable-thread-safe-client --with-innodb \
--with-openssl --with-vio --with-extra-charsets=complex
```

`gcc` is available at <ftp://ftp.sco.com/pub/openserver5/opensrc/gnutools-5.0.7Kj>.

This development system requires the OpenServer Execution Environment Supplement `oss646B` on OpenServer 5.0.6 and `oss656B` and The OpenSource libraries found in `gwxlibs`. All OpenSource tools are in the `opensrc` directory. They are available at



<ftp://ftp.sco.com/pub/openserver5/opensrc/>.

We recommend using the latest production release of MySQL.

SCO provides operating system patches at <ftp://ftp.sco.com/pub/openserver5> for OpenServer 5.0.[0-6] and <ftp://ftp.sco.com/pub/openserverv5/507> for OpenServer 5.0.7.

SCO provides information about security fixes at <ftp://ftp.sco.com/pub/security/OpenServer> for OpenServer 5.0.x.

The maximum file size on an OpenServer 5.0.x system is 2GB.

The total memory which can be allocated for streams buffers, clists, and lock records cannot exceed 60MB on OpenServer 5.0.x.

Streams buffers are allocated in units of 4096 byte pages, clists are 70 bytes each, and lock records are 64 bytes each, so:

```
(NSTRPAGES × 4096) + (NCLIST × 70) + (MAX_FLCKREC × 64) <= 62914560
```

Follow this procedure to configure the Database Services option. If you are unsure whether an application requires this, see the documentation provided with the application.

1. Log in as `root`.
2. Enable the SUDS driver by editing the `/etc/conf/sdevice.d/suds` file. Change the `N` in the second field to a `Y`.
3. Use `mkdev aio` or the Hardware/Kernel Manager to enable support for asynchronous I/O and relink the kernel. To allow users to lock down memory for use with this type of I/O, update the `aiomemlock(F)` file. This file should be updated to include the names of users that can use AIO and the maximum amounts of memory they can lock down.
4. Many applications use `setuid` binaries so that you need to specify only a single user. See the documentation provided with the application to determine whether this is the case for your application.

After you complete this process, reboot the system to create a new kernel incorporating these changes.

By default, the entries in `/etc/conf/cf.d/mtune` are set as follows:

Value	Default	Min	Max
-----	-----	---	---
NBUF	0	24	450000
NHBUF	0	32	524288
NMPBUF	0	12	512
MAX_INODE	0	100	64000
MAX_FILE	0	100	64000
CTBUFSIZE	128	0	256
MAX_PROC	0	50	16000
MAX_REGION	0	500	160000
NCLIST	170	120	16640
MAXUP	100	15	16000
NOFILES	110	60	11000
NHINODE	128	64	8192
NAUTOUP	10	0	60
NGROUPS	8	0	128
BDFLUSHR	30	1	300
MAX_FLCKREC	0	50	16000
PUTBUFSZ	8000	2000	20000
MAXSLICE	100	25	100
ULIMIT	4194303	2048	4194303
* Streams Parameters			
NSTREAM	64	1	32768
NSTRPUSH	9	9	9
NMUXLINK	192	1	4096
STRMSGSZ	16384	4096	524288
STRCTLSZ	1024	1024	1024
STRMAXBLK	524288	4096	524288
NSTRPAGES	500	0	8000
STRSPLITFRAC	80	50	100
NLOG	3	3	3
NUMSP	64	1	256
NUMTIM	16	1	8192
NUMTRW	16	1	8192
* Semaphore Parameters			
SEMAP	10	10	8192
SEMMNI	10	10	8192
SEMMNS	60	60	8192
SEMMNU	30	10	8192
SEMMSL	25	25	150
SEMOPM	10	10	1024
SEMUME	10	10	25
SEMVMX	32767	32767	32767
SEMAEM	16384	16384	16384
* Shared Memory Parameters			
SHMMAX	524288	131072	2147483647
SHMMIN	1	1	1
SHMMNI	100	100	2000

FILE	0	100	64000
NMOUNT	0	4	256
NPROC	0	50	16000
NREGION	0	500	160000

We recommend setting these values as follows:

- `NOFILES` should be 4096 or 2048.
- `MAXUP` should be 2048.

To make changes to the kernel, use the `idtune name parameter` command. `idtune` modifies the `/etc/conf/cf.d/stune` file for you. For example, to change `SEMMS` to `200`, execute this command as `root`:

```
# /etc/conf/bin/idtune SEMMS 200
```

Then rebuild and reboot the kernel by issuing this command:

```
# /etc/conf/bin/idbuild -B && init 6
```

We recommend tuning the system, but the proper parameter values to use depend on the number of users accessing the application or database and size the of the database (that is, the used buffer pool). The following kernel parameters can be set with `idtune`:

- `SHMMAX` (recommended setting: 128MB) and `SHMSEG` (recommended setting: 15). These parameters have an influence on the MySQL database engine to create user buffer pools.
- `NOFILES` and `MAXUP` should be set to at least 2048.
- `MAXPROC` should be set to at least 3000/4000 (depends on number of users) or more.
- We also recommend using the following formulas to calculate values for `SEMMSL`, `SEMMS`, and `SEMNU`:

```
SEMMSL = 13
```

13 is what has been found to be the best for both Progress and MySQL.

```
SEMMS = SEMMSL × number of db servers to be run on the system
```

Set `SEMMS` to the value of `SEMMSL` multiplied by the number of database servers (maximum) that you are running on the system at one time.

```
SEMNU = SEMMS
```

Set the value of `SEMNU` to equal the value of `SEMMS`. You could probably set this to 75% of `SEMMS`, but this is a conservative estimate.

You need to at least install the SCO OpenServer Linker and Application Development Libraries or the OpenServer Development System to use `gcc`. You cannot use the GCC Dev system without installing one of these.

You should get the FSU Pthreads package and install it first. This can be found at <http://moss.csc.ncsu.edu/~mueller/ftp/pub/PART/pthreads.tar.gz>. You can also get a precompiled package from <ftp://ftp.zenez.com/pub/zenez/prgms/FSU-threads-3.14.tar.gz>.

FSU Pthreads can be compiled with SCO Unix 4.2 with `tcpip`, or using OpenServer 3.0 or Open Desktop 3.0 (OS 3.0 ODT 3.0) with the SCO Development System installed using a good port of GCC 2.5.x. For ODT or OS 3.0, you need a good port of GCC 2.5.x. There are a lot of problems without a good port. The port for this product requires the SCO Unix Development system. Without it, you are missing the libraries and the linker that is needed. You also need `SCO-3.2v4.2-includes.tar.gz`. This file contains the changes to the SCO Development include files that are needed to get MySQL to build. You need to replace the existing system include files with these modified header files. They can be obtained from <ftp://ftp.zenez.com/pub/zenez/prgms/SCO-3.2v4.2-includes.tar.gz>.

To build FSU Pthreads on your system, all you should need to do is run GNU `make`. The `Makefile` in `FSU-threads-3.14.tar.gz` is set up to make FSU-threads.

You can run `./configure` in the `threads/src` directory and select the SCO OpenServer option. This command copies `Makefile.SCO5` to `Makefile`. Then run `make`.

To install in the default `/usr/include` directory, log in as `root`, and then `cd` to the `thread/src` directory and run `make install`.

Remember that you must use GNU `make` to build MySQL.

### Note

If you don't start `mysqld_safe` as `root`, you should get only the default 110 open files per process. `mysqld` writes a note about this in the log file.

With SCO 3.2V4.2, you should use FSU Pthreads version 3.14 or newer. The following `configure` command should work:

```
CFLAGS="-D_XOPEN_XPG4" CXX=gcc CXXFLAGS="-D_XOPEN_XPG4" \
./configure \
--prefix=/usr/local/mysql \
--with-named-thread-libs="-lgthreads -lsocket -lgen -lgthreads" \
--with-named-curses-libs="-lcurses"
```

You may have problems with some include files. In this case, you can find new SCO-specific include files at <ftp://ftp.zenez.com/pub/zenez/prgms/SCO-3.2v4.2-includes.tar.gz>.

You should unpack this file in the `include` directory of your MySQL source tree.

SCO development notes:

- MySQL should automatically detect FSU Pthreads and link `mysqld` with `-lgthreads -lsocket -lgthreads`.
- The SCO development libraries are re-entrant in FSU Pthreads. SCO claims that its library functions are re-entrant, so they must be re-entrant with FSU Pthreads. FSU Pthreads on OpenServer tries to use the SCO scheme to make re-entrant libraries.
- FSU Pthreads (at least the version at <ftp://ftp.zenez.com>) comes linked with GNU `malloc`. If you encounter problems with memory usage, make sure that `gmalloc.o` is included in `libgthreads.a` and `libgthreads.so`.
- In FSU Pthreads, the following system calls are pthreads-aware: `read()`, `write()`, `getmsg()`, `connect()`, `accept()`, `select()`, and `wait()`.
- The CSSA-2001-SCO.35.2 (the patch is listed in custom as `erg711905-dscr_remap` security patch (version 2.0.0)) breaks FSU threads and makes `mysqld` unstable. You have to remove this one if you want to run `mysqld` on an OpenServer 5.0.6 machine.
- If you use SCO OpenServer 5, you may need to recompile FSU pthreads with `-DDRAFT7` in `CFLAGS`. Otherwise, `InnoDB` may hang at a `mysqld` startup.
- SCO provides operating system patches at <ftp://ftp.sco.com/pub/openserver5> for OpenServer 5.0.x.
- SCO provides security fixes and `libsocket.so.2` at <ftp://ftp.sco.com/pub/security/OpenServer> and <ftp://ftp.sco.com/pub/security/sse> for OpenServer 5.0.x.
- Pre-OSR506 security fixes. Also, the `telnetd` fix at <ftp://stage.caldera.com/pub/security/openserver/> or <ftp://stage.caldera.com/pub/security/openserver/CSSA-2001-SCO.10/> as both `libsocket.so.2` and `libresolv.so.1` with instructions for installing on pre-OSR506 systems.

It is probably a good idea to install these patches before trying to compile/use MySQL.

Beginning with Legend/OpenServer 6.0.0, there are native threads and no 2GB file size limit.

### 2.13.5.9. SCO OpenServer 6.0.x Notes

OpenServer 6 includes these key improvements:

- Larger file support up to 1 TB
- Multiprocessor support increased from 4 to 32 processors
- Increased memory support up to 64GB
- Extending the power of UnixWare into OpenServer 6
- Dramatic performance improvement

OpenServer 6.0.0 commands are organized as follows:

- `/bin` is for commands that behave exactly the same as on OpenServer 5.0.x.
- `/u95/bin` is for commands that have better standards conformance, for example Large File System (LFS) support.
- `/udk/bin` is for commands that behave the same as on UnixWare 7.1.4. The default is for the LFS support.

The following is a guide to setting `PATH` on OpenServer 6. If the user wants the traditional OpenServer 5.0.x then `PATH` should be `/bin` first. If the user wants LFS support, the path should be `/u95/bin:/bin`. If the user wants UnixWare 7 support first, the path would be `/udk/bin:/u95/bin:/bin:`.

We recommend using the latest production release of MySQL. Should you choose to use an older release of MySQL on OpenServer 6.0.x, you must use a version of MySQL at least as recent as 3.22.13 to get fixes for some portability and OS problems.

MySQL distribution files with names of the following form are `tar` archives of media are tar archives of media images suitable for installation with the SCO Software Manager (`/etc/custom`) on SCO OpenServer 6:

```
mysql-PRODUCT-5.1.36-sco-osr6-i686.VOLS.tar
```

A distribution where `PRODUCT` is `pro-cert` is the Commercially licensed MySQL Pro Certified server. A distribution where `PRODUCT` is `pro-gpl-cert` is the MySQL Pro Certified server licensed under the terms of the General Public License (GPL).

Select whichever distribution you wish to install and, after download, extract the `tar` archive into an empty directory. For example:

```
shell> mkdir /tmp/mysql-pro
shell> cd /tmp/mysql-pro
shell> tar xf /tmp/mysql-pro-cert-5.1.36-sco-osr6-i686.VOLS.tar
```

Prior to installation, back up your data in accordance with the procedures outlined in [Section 2.12.1, "Upgrading MySQL"](#).

Remove any previously installed `pkgadd` version of MySQL:

```
shell> pkginfo mysql 2>&1 > /dev/null && pkgrm mysql
```

Install MySQL Pro from media images using the SCO Software Manager:

```
shell> /etc/custom -p SCO:MySQL -i -z /tmp/mysql-pro
```

Alternatively, the SCO Software Manager can be displayed graphically by clicking on the [Software Manager](#) icon on the desktop, selecting [Software](#) -> [Install New](#), selecting the host, selecting [Media Images](#) for the Media Device, and entering `/tmp/mysql-pro` as the Image Directory.

After installation, run `mkdev mysql` as the `root` user to configure your newly installed MySQL Pro Certified server.

### Note

The installation procedure for VOLS packages does not create the `mysql` user and group that the package uses by default. You should either create the `mysql` user and group, or else select a different user and group using an option in `mkdev mysql`.

If you wish to configure your MySQL Pro server to interface with the Apache Web server via PHP, download and install the PHP update from SCO at <ftp://ftp.sco.com/pub/updates/OpenServer/SCOSA-2006.17/>.

We have been able to compile MySQL with the following `configure` command on OpenServer 6.0.x:

```
CC=cc CFLAGS="-D_FILE_OFFSET_BITS=64 -O3" \
CXX=CC CXXFLAGS="-D_FILE_OFFSET_BITS=64 -O3" \
./configure --prefix=/usr/local/mysql \
--enable-thread-safe-client \
--with-extra-charsets=complex \
--build=i686-unknown-sysv5SCO_SV6.0.0
```

If you use `gcc`, you must use `gcc 2.95.3` or newer.

```
CC=gcc CXX=g++ ... ./configure ...
```

SCO provides OpenServer 6 operating system patches at <ftp://ftp.sco.com/pub/openserver6>.

SCO provides information about security fixes at <ftp://ftp.sco.com/pub/security/OpenServer>.

By default, the maximum file size on a OpenServer 6.0.0 system is 1TB. Some operating system utilities have a limitation of 2GB. The maximum possible file size on UnixWare 7 is 1TB with VXFS or HTFS.

OpenServer 6 can be configured for large file support (file sizes greater than 2GB) by tuning the UNIX kernel.

By default, the entries in `/etc/conf/cf.d/mtune` are set as follows:

Value	Default	Min	Max
SVMMLIM	0x9000000	0x1000000	0x7FFFFFFF
HVMMLIM	0x9000000	0x1000000	0x7FFFFFFF

To make changes to the kernel, use the `idtune name parameter` command. `idtune` modifies the `/etc/conf/cf.d/stune` file for you. We recommend setting the kernel values by executing the following commands as `root`:

```
# /etc/conf/bin/idtune SDATLIM 0x7FFFFFFF
# /etc/conf/bin/idtune HDATLIM 0x7FFFFFFF
# /etc/conf/bin/idtune SVMMLIM 0x7FFFFFFF
# /etc/conf/bin/idtune HVMMLIM 0x7FFFFFFF
# /etc/conf/bin/idtune SFNOLIM 2048
# /etc/conf/bin/idtune HFNOLIM 2048
```

Then rebuild and reboot the kernel by issuing this command:

```
# /etc/conf/bin/idbuild -B && init 6
```

We recommend tuning the system, but the proper parameter values to use depend on the number of users accessing the application or database and size of the database (that is, the used buffer pool). The following kernel parameters can be set with `idtune`:

- `SHMMAX` (recommended setting: 128MB) and `SHMSEG` (recommended setting: 15). These parameters have an influence on the MySQL database engine to create user buffer pools.
- `SFNOLIM` and `HFNOLIM` should be at maximum 2048.
- `NPROC` should be set to at least 3000/4000 (depends on number of users).
- We also recommend using the following formulas to calculate values for `SEMMSL`, `SEMMNS`, and `SEMMNU`:

```
SEMMSL = 13
```

13 is what has been found to be the best for both Progress and MySQL.

```
SEMMNS = SEMMSL × number of db servers to be run on the system
```

Set `SEMMNS` to the value of `SEMMSL` multiplied by the number of database servers (maximum) that you are running on the system at one time.

```
SEMMNU = SEMMNS
```

Set the value of `SEMMNU` to equal the value of `SEMMNS`. You could probably set this to 75% of `SEMMNS`, but this is a conservative estimate.

### 2.13.5.10. SCO UnixWare 7.1.x and OpenUNIX 8.0.0 Notes

We recommend using the latest production release of MySQL. Should you choose to use an older release of MySQL on UnixWare 7.1.x, you must use a version of MySQL at least as recent as 3.22.13 to get fixes for some portability and OS problems.

We have been able to compile MySQL with the following `configure` command on UnixWare 7.1.x:

```
CC="cc" CFLAGS="-I/usr/local/include" \
CXX="CC" CXXFLAGS="-I/usr/local/include" \
./configure --prefix=/usr/local/mysql \
--enable-thread-safe-client \
--with-innodb --with-openssl --with-extra-charsets=complex
```

If you want to use `gcc`, you must use `gcc` 2.95.3 or newer.

```
CC=gcc CXX=g++ ... ./configure ...
```

SCO provides operating system patches at <ftp://ftp.sco.com/pub/unixware7> for UnixWare 7.1.1, <ftp://ftp.sco.com/pub/unixware7/713/> for UnixWare 7.1.3, <ftp://ftp.sco.com/pub/unixware7/714/> for UnixWare 7.1.4, and <ftp://ftp.sco.com/pub/openunix8> for OpenUNIX 8.0.0.

SCO provides information about security fixes at <ftp://ftp.sco.com/pub/security/OpenUNIX> for OpenUNIX and <ftp://ftp.sco.com/pub/security/UnixWare> for UnixWare.

The UnixWare 7 file size limit is 1 TB with VXFS. Some OS utilities have a limitation of 2GB.

On UnixWare 7.1.4 you do not need to do anything to get large file support, but to enable large file support on prior versions of UnixWare 7.1.x, run `fsadm`.

```
# fsadm -Fvxfs -o largefiles /
# fsadm / * Note
# ulimit unlimited
# /etc/conf/bin/idtune SFSZLIM 0x7FFFFFFF ** Note
# /etc/conf/bin/idtune HFSZLIM 0x7FFFFFFF ** Note
# /etc/conf/bin/idbuild -B

* This should report "largefiles".
** 0x7FFFFFFF represents infinity for these values.
```

Reboot the system using `shutdown`.

By default, the entries in `/etc/conf/cf.d/mtune` are set as follows:

Value	Default	Min	Max
SVMLLIM	0x9000000	0x1000000	0x7FFFFFFF
HVMLLIM	0x9000000	0x1000000	0x7FFFFFFF

To make changes to the kernel, use the `idtune name parameter` command. `idtune` modifies the `/etc/conf/cf.d/stune` file for you. We recommend setting the kernel values by executing the following commands as `root`:

```
# /etc/conf/bin/idtune SDATLIM 0x7FFFFFFF
# /etc/conf/bin/idtune HDATLIM 0x7FFFFFFF
# /etc/conf/bin/idtune SVMLLIM 0x7FFFFFFF
# /etc/conf/bin/idtune HVMLLIM 0x7FFFFFFF
# /etc/conf/bin/idtune SFNOLIM 2048
# /etc/conf/bin/idtune HFNOLIM 2048
```

Then rebuild and reboot the kernel by issuing this command:

```
# /etc/conf/bin/idbuild -B && init 6
```

We recommend tuning the system, but the proper parameter values to use depend on the number of users accessing the application or database and size of the database (that is, the used buffer pool). The following kernel parameters can be set with `idtune`:

- `SHMMAX` (recommended setting: 128MB) and `SHMSEG` (recommended setting: 15). These parameters have an influence on the MySQL database engine to create user buffer pools.
- `SFNOLIM` and `HFNOLIM` should be at maximum 2048.
- `NPROC` should be set to at least 3000/4000 (depends on number of users).
- We also recommend using the following formulas to calculate values for `SEMMSL`, `SEMMNS`, and `SEMMNU`:

```
SEMMSL = 13
```

13 is what has been found to be the best for both Progress and MySQL.

```
SEMMNS = SEMMSL × number of db servers to be run on the system
```

Set `SEMMNS` to the value of `SEMMSL` multiplied by the number of database servers (maximum) that you are running on the system at one time.

```
SEMMNU = SEMMNS
```

Set the value of `SEMMNU` to equal the value of `SEMMNS`. You could probably set this to 75% of `SEMMNS`, but this is a conservative estimate.

## 2.14. Environment Variables

This section lists all the environment variables that are used directly or indirectly by MySQL. Most of these can also be found in other places in this manual.

Note that any options on the command line take precedence over values specified in option files and environment variables, and values in option files take precedence over values in environment variables.

In many cases, it is preferable to use an option file instead of environment variables to modify the behavior of MySQL. See [Section 4.2.3.2, “Using Option Files”](#).

Variable	Description
CXX	The name of your C++ compiler (for running <code>configure</code> ).
CC	The name of your C compiler (for running <code>configure</code> ).
CFLAGS	Flags for your C compiler (for running <code>configure</code> ).
CXXFLAGS	Flags for your C++ compiler (for running <code>configure</code> ).
DBI_USER	The default user name for Perl DBI.
DBI_TRACE	Trace options for Perl DBI.
HOME	The default path for the <code>mysql</code> history file is <code>\$HOME/.mysql_history</code> .
LD_RUN_PATH	Used to specify the location of <code>libmysqlclient.so</code> .
MYSQL_DEBUG	Debug trace options when debugging.
MYSQL_GROUP_SUFFIX	Option group suffix value (like specifying <code>--defaults-group-suffix</code> ).
MYSQL_HISTFILE	The path to the <code>mysql</code> history file. If this variable is set, its value overrides the default for <code>\$HOME/.mysql_history</code> .
MYSQL_HOME	The path to the directory in which the server-specific <code>my.cnf</code> file resides (as of MySQL 5.0.3).
MYSQL_HOST	The default host name used by the <code>mysql</code> command-line client.
MYSQL_PS1	The command prompt to use in the <code>mysql</code> command-line client.
MYSQL_PWD	The default password when connecting to <code>mysqld</code> . Note that using this is insecure. See <a href="#">Section 5.5.6.2, “End-User Guidelines for Password Security”</a> .
MYSQL_TCP_PORT	The default TCP/IP port number.
MYSQL_UNIX_PORT	The default Unix socket file name; used for connections to <code>localhost</code> .
PATH	Used by the shell to find MySQL programs.
TMPDIR	The directory where temporary files are created.
TZ	This should be set to your local time zone. See <a href="#">Section B.1.4.6, “Time Zone Problems”</a> .
UMASK	The user-file creation mode when creating files. See note following table.
UMASK_DIR	The user-directory creation mode when creating directories. See note following table.
USER	The default user name on Windows and NetWare used when connecting to <code>mysqld</code> .

The `UMASK` and `UMASK_DIR` variables, despite their names, are used as modes, not masks:

- If `UMASK` is set, `mysqld` uses `( $UMASK | 0600 )` as the mode for file creation, so that newly created files have a mode in the range from 0600 to 0666 (all values octal).
- If `UMASK_DIR` is set, `mysqld` uses `( $UMASK_DIR | 0700 )` as the base mode for directory creation, which then is AND-ed with `( ~$UMASK & 0666 )`, so that newly created directories have a mode in the range from 0700 to 0777 (all values octal). The AND operation may remove read and write permissions from the directory mode, but not execute permissions.

MySQL assumes that the value for `UMASK` or `UMASK_DIR` is in octal if it starts with a zero.

## 2.15. Perl Installation Notes

Perl support for MySQL is provided by means of the `DBI/DBD` client interface. The interface requires Perl 5.6.0, and 5.6.1 or later is preferred. `DBI` *does not work* if you have an older version of Perl.

If you want to use transactions with Perl DBI, you need to have `DBD: :mysql 2.0900`. If you are using the MySQL 4.1 or newer client library, you must use `DBD: :mysql 2.9003` or newer. Support for server-side prepared statements requires `DBD: :mysql`



3.0009 or newer.

Perl support is not included with MySQL distributions. You can obtain the necessary modules from <http://search.cpan.org> for Unix, or by using the ActiveState [ppm](#) program on Windows. The following sections describe how to do this.

Perl support for MySQL must be installed if you want to run the MySQL benchmark scripts; see [Section 7.1.4, “The MySQL Benchmark Suite”](#). It is also required for the MySQL Cluster [ndb\\_size.pl](#) utility; see [ndb\\_size.pl](#).

## 2.15.1. Installing Perl on Unix

MySQL Perl support requires that you have installed MySQL client programming support (libraries and header files). Most installation methods install the necessary files. However, if you installed MySQL from RPM files on Linux, be sure that you've installed the developer RPM. The client programs are in the client RPM, but client programming support is in the developer RPM.

If you want to install Perl support, the files you need can be obtained from the CPAN (Comprehensive Perl Archive Network) at <http://search.cpan.org>.

The easiest way to install Perl modules on Unix is to use the [CPAN](#) module. For example:

```
shell> perl -MCPAN -e shell
cpan> install DBI
cpan> install DBD:mysql
```

The `DBD:mysql` installation runs a number of tests. These tests attempt to connect to the local MySQL server using the default user name and password. (The default user name is your login name on Unix, and `ODBC` on Windows. The default password is “no password.”) If you cannot connect to the server with those values (for example, if your account has a password), the tests fail. You can use `force install DBD:mysql` to ignore the failed tests.

`DBI` requires the `Data:Dumper` module. It may be installed; if not, you should install it before installing `DBI`.

It is also possible to download the module distributions in the form of compressed `tar` archives and build the modules manually. For example, to unpack and build a `DBI` distribution, use a procedure such as this:

1. Unpack the distribution into the current directory:

```
shell> gunzip < DBI-VERSION.tar.gz | tar xvf -
```

This command creates a directory named `DBI-VERSION`.

2. Change location into the top-level directory of the unpacked distribution:

```
shell> cd DBI-VERSION
```

3. Build the distribution and compile everything:

```
shell> perl Makefile.PL
shell> make
shell> make test
shell> make install
```

The `make test` command is important because it verifies that the module is working. Note that when you run that command during the `DBD:mysql` installation to exercise the interface code, the MySQL server must be running or the test fails.

It is a good idea to rebuild and reinstall the `DBD:mysql` distribution whenever you install a new release of MySQL, particularly if you notice symptoms such as that all your `DBI` scripts fail after you upgrade MySQL.

If you do not have access rights to install Perl modules in the system directory or if you want to install local Perl modules, the following reference may be useful: <http://servers.digitaldaze.com/extensions/perl/modules.html#modules>

Look under the heading “Installing New Modules that Require Locally Installed Modules.”

## 2.15.2. Installing ActiveState Perl on Windows

On Windows, you should do the following to install the MySQL `DBD` module with ActiveState Perl:

1. Get ActiveState Perl from <http://www.activestate.com/Products/ActivePerl/> and install it.
2. Open a console window (a “DOS window”).

- If necessary, set the `HTTP_proxy` variable. For example, you might try a setting like this:

```
set HTTP_proxy=my.proxy.com:3128
```

- Start the PPM program:

```
C:\> C:\perl\bin\ppm.pl
```

- If you have not previously done so, install `DBI`:

```
ppm> install DBI
```

- If this succeeds, run the following command:

```
ppm> install DBD-mysql
```

This procedure should work with ActiveState Perl 5.6 or newer.

If you cannot get the procedure to work, you should install the MyODBC driver instead and connect to the MySQL server through ODBC:

```
use DBI;
$dbh= DBI->connect("DBI:ODBC:$dsn", $user, $password) ||
die "Got error $DBI::errstr when connecting to $dsn\n";
```

### 2.15.3. Problems Using the Perl `DBI/DBD` Interface

If Perl reports that it cannot find the `../mysql/mysql.so` module, the problem is probably that Perl cannot locate the `libmysqlclient.so` shared library. You should be able to fix this problem by one of the following methods:

- Compile the `DBD:mysql` distribution with `perl Makefile.PL -static -config` rather than `perl Makefile.PL`.
- Copy `libmysqlclient.so` to the directory where your other shared libraries are located (probably `/usr/lib` or `/lib`).
- Modify the `-L` options used to compile `DBD:mysql` to reflect the actual location of `libmysqlclient.so`.
- On Linux, you can add the path name of the directory where `libmysqlclient.so` is located to the `/etc/ld.so.conf` file.
- Add the path name of the directory where `libmysqlclient.so` is located to the `LD_RUN_PATH` environment variable. Some systems use `LD_LIBRARY_PATH` instead.

Note that you may also need to modify the `-L` options if there are other libraries that the linker fails to find. For example, if the linker cannot find `libc` because it is in `/lib` and the link command specifies `-L/usr/lib`, change the `-L` option to `-L/lib` or add `-L/lib` to the existing link command.

If you get the following errors from `DBD:mysql`, you are probably using `gcc` (or using an old binary compiled with `gcc`):

```
/usr/bin/perl: can't resolve symbol '__moddi3'
/usr/bin/perl: can't resolve symbol '__divdi3'
```

Add `-L/usr/lib/gcc-lib/... -lgcc` to the link command when the `mysql.so` library gets built (check the output from `make` for `mysql.so` when you compile the Perl client). The `-L` option should specify the path name of the directory where `libgcc.a` is located on your system.

Another cause of this problem may be that Perl and MySQL are not both compiled with `gcc`. In this case, you can solve the mismatch by compiling both with `gcc`.

You may see the following error from `DBD:mysql` when you run the tests:

```
t/00base.....install_driver(mysql) failed:
Can't load '../blib/arch/auto/DBD/mysql/mysql.so' for module DBD:mysql:
../blib/arch/auto/DBD/mysql/mysql.so: undefined symbol:
uncompress at /usr/lib/perl5/5.00503/i586-linux/DynaLoader.pm line 169.
```

This means that you need to include the `-lz` compression library on the link line. That can be done by changing the following line in the file `lib/DBD/mysql/Install.pm`:

```
$sysliblist .= " -lm";
```

Change that line to:

```
$sysliblist .= " -lm -lz";
```

After this, you *must* run `make realclean` and then proceed with the installation from the beginning.

If you want to install DBI on SCO, you have to edit the `Makefile` in `DBI-xxx` and each subdirectory. Note that the following assumes `gcc 2.95.2` or newer:

```
OLD:                                NEW:
CC = cc                             CC = gcc
CCCDLFLAGS = -KPIC -Wl,-Bexport     CCCDLFLAGS = -fpic
CCDLFLAGS = -wl,-Bexport            CCDLFLAGS =

LD = ld                              LD = gcc -G -fpic
LDDLFLAGS = -G -L/usr/local/lib     LDDLFLAGS = -L/usr/local/lib
LDLFLAGS = -belf -L/usr/local/lib   LDLFLAGS = -L/usr/local/lib

LD = ld                              LD = gcc -G -fpic
OPTIMISE = -Od                       OPTIMISE = -O1

OLD:
CCCFLAGS = -belf -dy -w0 -U M_XENIX -DPERL_SCO5 -I/usr/local/include
NEW:
CCFLAGS = -U M_XENIX -DPERL_SCO5 -I/usr/local/include
```

These changes are necessary because the Perl dynaloader does not load the `DBI` modules if they were compiled with `icc` or `cc`.

If you want to use the Perl module on a system that does not support dynamic linking (such as SCO), you can generate a static version of Perl that includes `DBI` and `DBD:mysql`. The way this works is that you generate a version of Perl with the `DBI` code linked in and install it on top of your current Perl. Then you use that to build a version of Perl that additionally has the `DBD` code linked in, and install that.

On SCO, you must have the following environment variables set:

```
LD_LIBRARY_PATH=/lib:/usr/lib:/usr/local/lib:/usr/progressive/lib
```

Or:

```
LD_LIBRARY_PATH=/usr/lib:/lib:/usr/local/lib:/usr/ccs/lib:\
/usr/progressive/lib:/usr/skunk/lib
LIBPATH=/usr/lib:/lib:/usr/local/lib:/usr/ccs/lib:\
/usr/progressive/lib:/usr/skunk/lib
MANPATH=scohelp:/usr/man:/usr/local1/man:/usr/local/man:\
/usr/skunk/man:
```

First, create a Perl that includes a statically linked `DBI` module by running these commands in the directory where your `DBI` distribution is located:

```
shell> perl Makefile.PL -static -config
shell> make
shell> make install
shell> make perl
```

Then you must install the new Perl. The output of `make perl` indicates the exact `make` command you need to execute to perform the installation. On SCO, this is `make -f Makefile.apperl inst_perl MAP_TARGET=perl`.

Next, use the just-created Perl to create another Perl that also includes a statically linked `DBD:mysql` by running these commands in the directory where your `DBD:mysql` distribution is located:

```
shell> perl Makefile.PL -static -config
shell> make
shell> make install
shell> make perl
```

Finally, you should install this new Perl. Again, the output of `make perl` indicates the command to use.

---

## Chapter 3. Tutorial

This chapter provides a tutorial introduction to MySQL by showing how to use the `mysql` client program to create and use a simple database. `mysql` (sometimes referred to as the “terminal monitor” or just “monitor”) is an interactive program that allows you to connect to a MySQL server, run queries, and view the results. `mysql` may also be used in batch mode: you place your queries in a file beforehand, then tell `mysql` to execute the contents of the file. Both ways of using `mysql` are covered here.

To see a list of options provided by `mysql`, invoke it with the `--help` option:

```
shell> mysql --help
```

This chapter assumes that `mysql` is installed on your machine and that a MySQL server is available to which you can connect. If this is not true, contact your MySQL administrator. (If you are the administrator, you need to consult the relevant portions of this manual, such as [Chapter 5, MySQL Server Administration](#).)

This chapter describes the entire process of setting up and using a database. If you are interested only in accessing an existing database, you may want to skip over the sections that describe how to create the database and the tables it contains.

Because this chapter is tutorial in nature, many details are necessarily omitted. Consult the relevant sections of the manual for more information on the topics covered here.

### 3.1. Connecting to and Disconnecting from the Server

To connect to the server, you will usually need to provide a MySQL user name when you invoke `mysql` and, most likely, a password. If the server runs on a machine other than the one where you log in, you will also need to specify a host name. Contact your administrator to find out what connection parameters you should use to connect (that is, what host, user name, and password to use). Once you know the proper parameters, you should be able to connect like this:

```
shell> mysql -h host -u user -p
Enter password: *****
```

`host` and `user` represent the host name where your MySQL server is running and the user name of your MySQL account. Substitute appropriate values for your setup. The `*****` represents your password; enter it when `mysql` displays the `Enter password:` prompt.

If that works, you should see some introductory information followed by a `mysql>` prompt:

```
shell> mysql -h host -u user -p
Enter password: *****
Welcome to the MySQL monitor.  Commands end with ; or \g.
Your MySQL connection id is 25338 to server version: 5.1.36-standard

Type 'help;' or '\h' for help. Type '\c' to clear the buffer.

mysql>
```

The `mysql>` prompt tells you that `mysql` is ready for you to enter commands.

If you are logging in on the same machine that MySQL is running on, you can omit the host, and simply use the following:

```
shell> mysql -u user -p
```

If, when you attempt to log in, you get an error message such as `ERROR 2002 (HY000): CAN'T CONNECT TO LOCAL MYSQL SERVER THROUGH SOCKET '/TMP/MYSQL.SOCK' (2)`, it means that the MySQL server daemon (Unix) or service (Windows) is not running. Consult the administrator or see the section of [Chapter 2, Installing and Upgrading MySQL](#) that is appropriate to your operating system.

For help with other problems often encountered when trying to log in, see [Section B.1.2, “Common Errors When Using MySQL Programs”](#).

Some MySQL installations allow users to connect as the anonymous (unnamed) user to the server running on the local host. If this is the case on your machine, you should be able to connect to that server by invoking `mysql` without any options:

```
shell> mysql
```

After you have connected successfully, you can disconnect any time by typing `QUIT` (or `\q`) at the `mysql>` prompt:

```
mysql> QUIT
Bye
```

On Unix, you can also disconnect by pressing Control-D.

Most examples in the following sections assume that you are connected to the server. They indicate this by the `mysql>` prompt.

## 3.2. Entering Queries

Make sure that you are connected to the server, as discussed in the previous section. Doing so does not in itself select any database to work with, but that is okay. At this point, it is more important to find out a little about how to issue queries than to jump right in creating tables, loading data into them, and retrieving data from them. This section describes the basic principles of entering commands, using several queries you can try out to familiarize yourself with how `mysql` works.

Here is a simple command that asks the server to tell you its version number and the current date. Type it in as shown here following the `mysql>` prompt and press Enter:

```
mysql> SELECT VERSION(), CURRENT_DATE;
+-----+-----+
| VERSION() | CURRENT_DATE |
+-----+-----+
| 5.1.2-alpha-log | 2005-10-11 |
+-----+-----+
1 row in set (0.01 sec)
mysql>
```

This query illustrates several things about `mysql`:

- A command normally consists of an SQL statement followed by a semicolon. (There are some exceptions where a semicolon may be omitted. `QUIT`, mentioned earlier, is one of them. We'll get to others later.)
- When you issue a command, `mysql` sends it to the server for execution and displays the results, then prints another `mysql>` prompt to indicate that it is ready for another command.
- `mysql` displays query output in tabular form (rows and columns). The first row contains labels for the columns. The rows following are the query results. Normally, column labels are the names of the columns you fetch from database tables. If you're retrieving the value of an expression rather than a table column (as in the example just shown), `mysql` labels the column using the expression itself.
- `mysql` shows how many rows were returned and how long the query took to execute, which gives you a rough idea of server performance. These values are imprecise because they represent wall clock time (not CPU or machine time), and because they are affected by factors such as server load and network latency. (For brevity, the "rows in set" line is sometimes not shown in the remaining examples in this chapter.)

Keywords may be entered in any lettercase. The following queries are equivalent:

```
mysql> SELECT VERSION(), CURRENT_DATE;
mysql> select version(), current_date;
mysql> SeLeCt vErSiOn(), cUrReNt_DaTe;
```

Here is another query. It demonstrates that you can use `mysql` as a simple calculator:

```
mysql> SELECT SIN(PI()/4), (4+1)*5;
+-----+-----+
| SIN(PI()/4) | (4+1)*5 |
+-----+-----+
| 0.70710678118655 | 25 |
+-----+-----+
1 row in set (0.02 sec)
```

The queries shown thus far have been relatively short, single-line statements. You can even enter multiple statements on a single line. Just end each one with a semicolon:

```
mysql> SELECT VERSION(); SELECT NOW();
+-----+
| VERSION() |
+-----+
| 5.1.2-alpha-log |
+-----+
1 row in set (0.00 sec)

+-----+
| NOW() |
+-----+
| 2005-10-11 15:15:00 |
+-----+
1 row in set (0.00 sec)
```

A command need not be given all on a single line, so lengthy commands that require several lines are not a problem. `mysql` determines where your statement ends by looking for the terminating semicolon, not by looking for the end of the input line. (In other words, `mysql` accepts free-format input: it collects input lines but does not execute them until it sees the semicolon.)

Here is a simple multiple-line statement:

```
mysql> SELECT
-> USER()
-> ,
-> CURRENT_DATE;
+-----+-----+
| USER() | CURRENT_DATE |
+-----+-----+
| jon@localhost | 2005-10-11 |
+-----+-----+
```

In this example, notice how the prompt changes from `mysql>` to `->` after you enter the first line of a multiple-line query. This is how `mysql` indicates that it has not yet seen a complete statement and is waiting for the rest. The prompt is your friend, because it provides valuable feedback. If you use that feedback, you can always be aware of what `mysql` is waiting for.

If you decide you do not want to execute a command that you are in the process of entering, cancel it by typing `\c`:

```
mysql> SELECT
-> USER()
-> \c
mysql>
```

Here, too, notice the prompt. It switches back to `mysql>` after you type `\c`, providing feedback to indicate that `mysql` is ready for a new command.

The following table shows each of the prompts you may see and summarizes what they mean about the state that `mysql` is in.

Prompt	Meaning
<code>mysql&gt;</code>	Ready for new command.
<code>-&gt;</code>	Waiting for next line of multiple-line command.
<code>'&gt;</code>	Waiting for next line, waiting for completion of a string that began with a single quote (“'”).
<code>"&gt;</code>	Waiting for next line, waiting for completion of a string that began with a double quote (“”).
<code>`&gt;</code>	Waiting for next line, waiting for completion of an identifier that began with a backtick (“`”).
<code>/*&gt;</code>	Waiting for next line, waiting for completion of a comment that began with <code>/*</code> .

Multiple-line statements commonly occur by accident when you intend to issue a command on a single line, but forget the terminating semicolon. In this case, `mysql` waits for more input:

```
mysql> SELECT USER()
->
```

If this happens to you (you think you've entered a statement but the only response is a `->` prompt), most likely `mysql` is waiting for the semicolon. If you don't notice what the prompt is telling you, you might sit there for a while before realizing what you need to do. Enter a semicolon to complete the statement, and `mysql` executes it:

```
mysql> SELECT USER()
-> ;
+-----+-----+
| USER() |
+-----+-----+
| jon@localhost |
+-----+-----+
```

The `'>` and `">` prompts occur during string collection (another way of saying that MySQL is waiting for completion of a string). In MySQL, you can write strings surrounded by either `'` or `"` characters (for example, `'hello'` or `"goodbye"`), and `mysql` lets you enter strings that span multiple lines. When you see a `'>` or `">` prompt, it means that you have entered a line containing a string that begins with a `'` or `"` quote character, but have not yet entered the matching quote that terminates the string. This often indicates that you have inadvertently left out a quote character. For example:

```
mysql> SELECT * FROM my_table WHERE name = 'Smith AND age < 30;
'>
```

If you enter this `SELECT` statement, then press **Enter** and wait for the result, nothing happens. Instead of wondering why this query takes so long, notice the clue provided by the `'>` prompt. It tells you that `mysql` expects to see the rest of an unterminated

string. (Do you see the error in the statement? The string `'Smith` is missing the second single quote mark.)

At this point, what do you do? The simplest thing is to cancel the command. However, you cannot just type `\c` in this case, because `mysql` interprets it as part of the string that it is collecting. Instead, enter the closing quote character (so `mysql` knows you've finished the string), then type `\c`:

```
mysql> SELECT * FROM my_table WHERE name = 'Smith AND age < 30;
'> '\c
mysql>
```

The prompt changes back to `mysql>`, indicating that `mysql` is ready for a new command.

The ``>` prompt is similar to the `'>` and `">` prompts, but indicates that you have begun but not completed a backtick-quoted identifier.

It is important to know what the `'>`, `">`, and ``>` prompts signify, because if you mistakenly enter an unterminated string, any further lines you type appear to be ignored by `mysql` — including a line containing `QUIT`. This can be quite confusing, especially if you do not know that you need to supply the terminating quote before you can cancel the current command.

### 3.3. Creating and Using a Database

Once you know how to enter commands, you are ready to access a database.

Suppose that you have several pets in your home (your menagerie) and you would like to keep track of various types of information about them. You can do so by creating tables to hold your data and loading them with the desired information. Then you can answer different sorts of questions about your animals by retrieving data from the tables. This section shows you how to:

- Create a database
- Create a table
- Load data into the table
- Retrieve data from the table in various ways
- Use multiple tables

The menagerie database is simple (deliberately), but it is not difficult to think of real-world situations in which a similar type of database might be used. For example, a database like this could be used by a farmer to keep track of livestock, or by a veterinarian to keep track of patient records. A menagerie distribution containing some of the queries and sample data used in the following sections can be obtained from the MySQL Web site. It is available in both compressed `tar` file and Zip formats at <http://dev.mysql.com/doc/>.

Use the `SHOW` statement to find out what databases currently exist on the server:

```
mysql> SHOW DATABASES;
+-----+
| Database |
+-----+
| mysql   |
| test    |
| tmp     |
+-----+
```

The `mysql` database describes user access privileges. The `test` database often is available as a workspace for users to try things out.

The list of databases displayed by the statement may be different on your machine; `SHOW DATABASES` does not show databases that you have no privileges for if you do not have the `SHOW DATABASES` privilege. See [Section 12.5.5.15, “SHOW DATABASES Syntax”](#).

If the `test` database exists, try to access it:

```
mysql> USE test
Database changed
```

Note that `USE`, like `QUIT`, does not require a semicolon. (You can terminate such statements with a semicolon if you like; it does no harm.) The `USE` statement is special in another way, too: it must be given on a single line.

You can use the `test` database (if you have access to it) for the examples that follow, but anything you create in that database can be removed by anyone else with access to it. For this reason, you should probably ask your MySQL administrator for permission to



use a database of your own. Suppose that you want to call yours `menagerie`. The administrator needs to execute a command like this:

```
mysql> GRANT ALL ON menagerie.* TO 'your_mysql_name'@'your_client_host';
```

where `your_mysql_name` is the MySQL user name assigned to you and `your_client_host` is the host from which you connect to the server.

### 3.3.1. Creating and Selecting a Database

If the administrator creates your database for you when setting up your permissions, you can begin using it. Otherwise, you need to create it yourself:

```
mysql> CREATE DATABASE menagerie;
```

Under Unix, database names are case sensitive (unlike SQL keywords), so you must always refer to your database as `menagerie`, not as `Menagerie`, `MENAGERIE`, or some other variant. This is also true for table names. (Under Windows, this restriction does not apply, although you must refer to databases and tables using the same lettercase throughout a given query. However, for a variety of reasons, our recommended best practice is always to use the same lettercase that was used when the database was created.)

#### Note

If you get an error such as `ERROR 1044 (42000): ACCESS DENIED FOR USER 'MONTY'@'LOCALHOST' TO DATABASE 'MENAGERIE'` when attempting to create a database, this means that your user account does not have the necessary privileges to do so. Discuss this with the administrator or see [Section 5.4, “The MySQL Access Privilege System”](#).

Creating a database does not select it for use; you must do that explicitly. To make `menagerie` the current database, use this command:

```
mysql> USE menagerie
Database changed
```

Your database needs to be created only once, but you must select it for use each time you begin a `mysql` session. You can do this by issuing a `USE` statement as shown in the example. Alternatively, you can select the database on the command line when you invoke `mysql`. Just specify its name after any connection parameters that you might need to provide. For example:

```
shell> mysql -h host -u user -p menagerie
Enter password: *****
```

Note that `menagerie` in the command just shown is **not** your password. If you want to supply your password on the command line after the `-p` option, you must do so with no intervening space (for example, as `-pmypassword`, not as `-p mypassword`). However, putting your password on the command line is not recommended, because doing so exposes it to snooping by other users logged in on your machine.

### 3.3.2. Creating a Table

Creating the database is the easy part, but at this point it is empty, as `SHOW TABLES` tells you:

```
mysql> SHOW TABLES;
Empty set (0.00 sec)
```

The harder part is deciding what the structure of your database should be: what tables you need and what columns should be in each of them.

You want a table that contains a record for each of your pets. This can be called the `pet` table, and it should contain, as a bare minimum, each animal's name. Because the name by itself is not very interesting, the table should contain other information. For example, if more than one person in your family keeps pets, you might want to list each animal's owner. You might also want to record some basic descriptive information such as species and sex.

How about age? That might be of interest, but it is not a good thing to store in a database. Age changes as time passes, which means you'd have to update your records often. Instead, it is better to store a fixed value such as date of birth. Then, whenever you need age, you can calculate it as the difference between the current date and the birth date. MySQL provides functions for doing date arithmetic, so this is not difficult. Storing birth date rather than age has other advantages, too:

- You can use the database for tasks such as generating reminders for upcoming pet birthdays. (If you think this type of query is somewhat silly, note that it is the same question you might ask in the context of a business database to identify clients to whom you need to send out birthday greetings in the current week or month, for that computer-assisted personal touch.)

- You can calculate age in relation to dates other than the current date. For example, if you store death date in the database, you can easily calculate how old a pet was when it died.

You can probably think of other types of information that would be useful in the `pet` table, but the ones identified so far are sufficient: name, owner, species, sex, birth, and death.

Use a `CREATE TABLE` statement to specify the layout of your table:

```
mysql> CREATE TABLE pet (name VARCHAR(20), owner VARCHAR(20),
-> species VARCHAR(20), sex CHAR(1), birth DATE, death DATE);
```

`VARCHAR` is a good choice for the `name`, `owner`, and `species` columns because the column values vary in length. The lengths in those column definitions need not all be the same, and need not be `20`. You can normally pick any length from `1` to `65535`, whatever seems most reasonable to you. If you make a poor choice and it turns out later that you need a longer field, MySQL provides an `ALTER TABLE` statement.

Several types of values can be chosen to represent sex in animal records, such as `'m'` and `'f'`, or perhaps `'male'` and `'female'`. It is simplest to use the single characters `'m'` and `'f'`.

The use of the `DATE` data type for the `birth` and `death` columns is a fairly obvious choice.

Once you have created a table, `SHOW TABLES` should produce some output:

```
mysql> SHOW TABLES;
+-----+
| Tables in menagerie |
+-----+
| pet |
+-----+
```

To verify that your table was created the way you expected, use a `DESCRIBE` statement:

```
mysql> DESCRIBE pet;
+-----+-----+-----+-----+-----+-----+
| Field | Type | Null | Key | Default | Extra |
+-----+-----+-----+-----+-----+-----+
| name  | varchar(20) | YES | | NULL | |
| owner | varchar(20) | YES | | NULL | |
| species | varchar(20) | YES | | NULL | |
| sex   | char(1) | YES | | NULL | |
| birth | date | YES | | NULL | |
| death | date | YES | | NULL | |
+-----+-----+-----+-----+-----+-----+
```

You can use `DESCRIBE` any time, for example, if you forget the names of the columns in your table or what types they have.

For more information about MySQL data types, see [Chapter 10, Data Types](#).

### 3.3.3. Loading Data into a Table

After creating your table, you need to populate it. The `LOAD DATA` and `INSERT` statements are useful for this.

Suppose that your pet records can be described as shown here. (Observe that MySQL expects dates in `'YYYY-MM-DD'` format; this may be different from what you are used to.)

name	owner	species	sex	birth	death
Fluffy	Harold	cat	f	1993-02-04	
Claws	Gwen	cat	m	1994-03-17	
Buffy	Harold	dog	f	1989-05-13	
Fang	Benny	dog	m	1990-08-27	
Bowser	Diane	dog	m	1979-08-31	1995-07-29
Chirpy	Gwen	bird	f	1998-09-11	
Whistler	Gwen	bird		1997-12-09	
Slim	Benny	snake	m	1996-04-29	

Because you are beginning with an empty table, an easy way to populate it is to create a text file containing a row for each of your animals, then load the contents of the file into the table with a single statement.

You could create a text file `pet.txt` containing one record per line, with values separated by tabs, and given in the order in which the columns were listed in the `CREATE TABLE` statement. For missing values (such as unknown sexes or death dates for animals that are still living), you can use `NULL` values. To represent these in your text file, use `\N` (backslash, capital-N). For example, the record for Whistler the bird would look like this (where the whitespace between values is a single tab character):

```
Whistler      Gwen      bird      \N      1997-12-09      \N
```

To load the text file `pet.txt` into the `pet` table, use this command:

```
mysql> LOAD DATA LOCAL INFILE '/path/pet.txt' INTO TABLE pet;
```

Note that if you created the file on Windows with an editor that uses `\r\n` as a line terminator, you should use:

```
mysql> LOAD DATA LOCAL INFILE '/path/pet.txt' INTO TABLE pet
-> LINES TERMINATED BY '\r\n';
```

(On an Apple machine running OS X, you would likely want to use `LINES TERMINATED BY '\r'`.)

You can specify the column value separator and end of line marker explicitly in the `LOAD DATA` statement if you wish, but the defaults are tab and linefeed. These are sufficient for the statement to read the file `pet.txt` properly.

If the statement fails, it is likely that your MySQL installation does not have local file capability enabled by default. See [Section 5.3.4, “Security Issues with LOAD DATA LOCAL”](#), for information on how to change this.

When you want to add new records one at a time, the `INSERT` statement is useful. In its simplest form, you supply values for each column, in the order in which the columns were listed in the `CREATE TABLE` statement. Suppose that Diane gets a new hamster named “Puffball.” You could add a new record using an `INSERT` statement like this:

```
mysql> INSERT INTO pet
-> VALUES ('Puffball','Diane','hamster','f','1999-03-30',NULL);
```

Note that string and date values are specified as quoted strings here. Also, with `INSERT`, you can insert `NULL` directly to represent a missing value. You do not use `\N` like you do with `LOAD DATA`.

From this example, you should be able to see that there would be a lot more typing involved to load your records initially using several `INSERT` statements rather than a single `LOAD DATA` statement.

### 3.3.4. Retrieving Information from a Table

The `SELECT` statement is used to pull information from a table. The general form of the statement is:

```
SELECT what_to_select
FROM which_table
WHERE conditions_to_satisfy;
```

*what\_to\_select* indicates what you want to see. This can be a list of columns, or `*` to indicate “all columns.” *which\_table* indicates the table from which you want to retrieve data. The `WHERE` clause is optional. If it is present, *conditions\_to\_satisfy* specifies one or more conditions that rows must satisfy to qualify for retrieval.

#### 3.3.4.1. Selecting All Data

The simplest form of `SELECT` retrieves everything from a table:

```
mysql> SELECT * FROM pet;
```

name	owner	species	sex	birth	death
Fluffy	Harold	cat	f	1993-02-04	NULL
Claws	Gwen	cat	m	1994-03-17	NULL
Buff	Harold	dog	f	1989-05-13	NULL
Fang	Benny	dog	m	1990-08-27	NULL
Bowser	Diane	dog	m	1979-08-31	1995-07-29
Chirpy	Gwen	bird	f	1998-09-11	NULL
Whistler	Gwen	bird	NULL	1997-12-09	NULL
Slim	Benny	snake	m	1996-04-29	NULL
Puffball	Diane	hamster	f	1999-03-30	NULL

This form of `SELECT` is useful if you want to review your entire table, for example, after you've just loaded it with your initial data set. For example, you may happen to think that the birth date for Bowser doesn't seem quite right. Consulting your original pedigree papers, you find that the correct birth year should be 1989, not 1979.

There are at least two ways to fix this:

- Edit the file `pet.txt` to correct the error, then empty the table and reload it using `DELETE` and `LOAD DATA`:

```
mysql> DELETE FROM pet;
mysql> LOAD DATA LOCAL INFILE 'pet.txt' INTO TABLE pet;
```

However, if you do this, you must also re-enter the record for Puffball.

- Fix only the erroneous record with an `UPDATE` statement:

```
mysql> UPDATE pet SET birth = '1989-08-31' WHERE name = 'Bowser';
```

The `UPDATE` changes only the record in question and does not require you to reload the table.

### 3.3.4.2. Selecting Particular Rows

As shown in the preceding section, it is easy to retrieve an entire table. Just omit the `WHERE` clause from the `SELECT` statement. But typically you don't want to see the entire table, particularly when it becomes large. Instead, you're usually more interested in answering a particular question, in which case you specify some constraints on the information you want. Let's look at some selection queries in terms of questions about your pets that they answer.

You can select only particular rows from your table. For example, if you want to verify the change that you made to Bowser's birth date, select Bowser's record like this:

```
mysql> SELECT * FROM pet WHERE name = 'Bowser';
+-----+-----+-----+-----+-----+-----+
| name | owner | species | sex | birth | death |
+-----+-----+-----+-----+-----+-----+
| Bowser | Diane | dog | m | 1989-08-31 | 1995-07-29 |
+-----+-----+-----+-----+-----+-----+
```

The output confirms that the year is correctly recorded as 1989, not 1979.

String comparisons normally are case-insensitive, so you can specify the name as `'bowser'`, `'BOWSER'`, and so forth. The query result is the same.

You can specify conditions on any column, not just `name`. For example, if you want to know which animals were born during or after 1998, test the `birth` column:

```
mysql> SELECT * FROM pet WHERE birth >= '1998-1-1';
+-----+-----+-----+-----+-----+-----+
| name | owner | species | sex | birth | death |
+-----+-----+-----+-----+-----+-----+
| Chirpy | Gwen | bird | f | 1998-09-11 | NULL |
| Puffball | Diane | hamster | f | 1999-03-30 | NULL |
+-----+-----+-----+-----+-----+-----+
```

You can combine conditions, for example, to locate female dogs:

```
mysql> SELECT * FROM pet WHERE species = 'dog' AND sex = 'f';
+-----+-----+-----+-----+-----+-----+
| name | owner | species | sex | birth | death |
+-----+-----+-----+-----+-----+-----+
| Buffy | Harold | dog | f | 1989-05-13 | NULL |
+-----+-----+-----+-----+-----+-----+
```

The preceding query uses the `AND` logical operator. There is also an `OR` operator:

```
mysql> SELECT * FROM pet WHERE species = 'snake' OR species = 'bird';
+-----+-----+-----+-----+-----+-----+
| name | owner | species | sex | birth | death |
+-----+-----+-----+-----+-----+-----+
| Chirpy | Gwen | bird | f | 1998-09-11 | NULL |
| Whistler | Gwen | bird | NULL | 1997-12-09 | NULL |
| Slim | Benny | snake | m | 1996-04-29 | NULL |
+-----+-----+-----+-----+-----+-----+
```

`AND` and `OR` may be intermixed, although `AND` has higher precedence than `OR`. If you use both operators, it is a good idea to use parentheses to indicate explicitly how conditions should be grouped:

```
mysql> SELECT * FROM pet WHERE (species = 'cat' AND sex = 'm')
-> OR (species = 'dog' AND sex = 'f');
```

name	owner	species	sex	birth	death
Claws	Gwen	cat	m	1994-03-17	NULL
Buffy	Harold	dog	f	1989-05-13	NULL

### 3.3.4.3. Selecting Particular Columns

If you do not want to see entire rows from your table, just name the columns in which you are interested, separated by commas. For example, if you want to know when your animals were born, select the `name` and `birth` columns:

```
mysql> SELECT name, birth FROM pet;
+-----+-----+
| name  | birth      |
+-----+-----+
| Fluffy| 1993-02-04 |
| Claws | 1994-03-17 |
| Buffy | 1989-05-13 |
| Fang  | 1990-08-27 |
| Bowser| 1989-08-31 |
| Chirpy| 1998-09-11 |
| Whistler| 1997-12-09 |
| Slim  | 1996-04-29 |
| Puffball| 1999-03-30 |
+-----+-----+
```

To find out who owns pets, use this query:

```
mysql> SELECT owner FROM pet;
+-----+
| owner |
+-----+
| Harold|
| Gwen  |
| Harold|
| Benny |
| Diane |
| Gwen  |
| Gwen  |
| Benny |
| Diane |
+-----+
```

Notice that the query simply retrieves the `owner` column from each record, and some of them appear more than once. To minimize the output, retrieve each unique output record just once by adding the keyword `DISTINCT`:

```
mysql> SELECT DISTINCT owner FROM pet;
+-----+
| owner |
+-----+
| Benny |
| Diane |
| Gwen  |
| Harold|
+-----+
```

You can use a `WHERE` clause to combine row selection with column selection. For example, to get birth dates for dogs and cats only, use this query:

```
mysql> SELECT name, species, birth FROM pet
-> WHERE species = 'dog' OR species = 'cat';
+-----+-----+-----+
| name  | species | birth      |
+-----+-----+-----+
| Fluffy| cat     | 1993-02-04 |
| Claws | cat     | 1994-03-17 |
| Buffy | dog     | 1989-05-13 |
| Fang  | dog     | 1990-08-27 |
| Bowser| dog     | 1989-08-31 |
+-----+-----+-----+
```

### 3.3.4.4. Sorting Rows

You may have noticed in the preceding examples that the result rows are displayed in no particular order. It is often easier to examine query output when the rows are sorted in some meaningful way. To sort a result, use an `ORDER BY` clause.

Here are animal birthdays, sorted by date:

```
mysql> SELECT name, birth FROM pet ORDER BY birth;
+-----+-----+
| name  | birth      |
+-----+-----+
| Buffy | 1989-05-13 |
+-----+-----+
```

```

+-----+-----+
| Bowser | 1989-08-31 |
| Fang   | 1990-08-27 |
| Fluffy | 1993-02-04 |
| Claws  | 1994-03-17 |
| Slim   | 1996-04-29 |
| Whistler | 1997-12-09 |
| Chirpy | 1998-09-11 |
| Puffball | 1999-03-30 |
+-----+-----+

```

On character type columns, sorting — like all other comparison operations — is normally performed in a case-insensitive fashion. This means that the order is undefined for columns that are identical except for their case. You can force a case-sensitive sort for a column by using `BINARY` like so: `ORDER BY BINARY col_name`.

The default sort order is ascending, with smallest values first. To sort in reverse (descending) order, add the `DESC` keyword to the name of the column you are sorting by:

```

mysql> SELECT name, birth FROM pet ORDER BY birth DESC;
+-----+-----+
| name | birth |
+-----+-----+
| Puffball | 1999-03-30 |
| Chirpy | 1998-09-11 |
| Whistler | 1997-12-09 |
| Slim | 1996-04-29 |
| Claws | 1994-03-17 |
| Fluffy | 1993-02-04 |
| Fang | 1990-08-27 |
| Bowser | 1989-08-31 |
| Buffy | 1989-05-13 |
+-----+-----+

```

You can sort on multiple columns, and you can sort different columns in different directions. For example, to sort by type of animal in ascending order, then by birth date within animal type in descending order (youngest animals first), use the following query:

```

mysql> SELECT name, species, birth FROM pet
-> ORDER BY species, birth DESC;
+-----+-----+-----+
| name | species | birth |
+-----+-----+-----+
| Chirpy | bird | 1998-09-11 |
| Whistler | bird | 1997-12-09 |
| Claws | cat | 1994-03-17 |
| Fluffy | cat | 1993-02-04 |
| Fang | dog | 1990-08-27 |
| Bowser | dog | 1989-08-31 |
| Buffy | dog | 1989-05-13 |
| Puffball | hamster | 1999-03-30 |
| Slim | snake | 1996-04-29 |
+-----+-----+-----+

```

Note that the `DESC` keyword applies only to the column name immediately preceding it (`birth`); it does not affect the `species` column sort order.

### 3.3.4.5. Date Calculations

MySQL provides several functions that you can use to perform calculations on dates, for example, to calculate ages or extract parts of dates.

To determine how many years old each of your pets is, compute the difference in the year part of the current date and the birth date, then subtract one if the current date occurs earlier in the calendar year than the birth date. The following query shows, for each pet, the birth date, the current date, and the age in years.

```

mysql> SELECT name, birth, CURDATE(),
-> (YEAR(CURDATE())-YEAR(birth))
-> - (RIGHT(CURDATE(),5)<RIGHT(birth,5))
-> AS age
-> FROM pet;
+-----+-----+-----+-----+
| name | birth | CURDATE() | age |
+-----+-----+-----+-----+
| Fluffy | 1993-02-04 | 2003-08-19 | 10 |
| Claws | 1994-03-17 | 2003-08-19 | 9 |
| Buffy | 1989-05-13 | 2003-08-19 | 14 |
| Fang | 1990-08-27 | 2003-08-19 | 12 |
| Bowser | 1989-08-31 | 2003-08-19 | 13 |
| Chirpy | 1998-09-11 | 2003-08-19 | 4 |
| Whistler | 1997-12-09 | 2003-08-19 | 5 |
| Slim | 1996-04-29 | 2003-08-19 | 7 |
| Puffball | 1999-03-30 | 2003-08-19 | 4 |
+-----+-----+-----+-----+

```

Here, `YEAR()` pulls out the year part of a date and `RIGHT()` pulls off the rightmost five characters that represent the `MM-DD`

(calendar year) part of the date. The part of the expression that compares the `MM-DD` values evaluates to 1 or 0, which adjusts the year difference down a year if `CURDATE()` occurs earlier in the year than `birth`. The full expression is somewhat ungainly, so an *alias* (`age`) is used to make the output column label more meaningful.

The query works, but the result could be scanned more easily if the rows were presented in some order. This can be done by adding an `ORDER BY name` clause to sort the output by name:

```
mysql> SELECT name, birth, CURDATE(),
-> (YEAR(CURDATE())-YEAR(birth))
-> - (RIGHT(CURDATE(),5)<RIGHT(birth,5))
-> AS age
-> FROM pet ORDER BY name;
```

name	birth	CURDATE()	age
Bowser	1989-08-31	2003-08-19	13
Buffy	1989-05-13	2003-08-19	14
Chirpy	1998-09-11	2003-08-19	4
Claws	1994-03-17	2003-08-19	9
Fang	1990-08-27	2003-08-19	12
Fluffy	1993-02-04	2003-08-19	10
Puffball	1999-03-30	2003-08-19	4
Slim	1996-04-29	2003-08-19	7
Whistler	1997-12-09	2003-08-19	5

To sort the output by `age` rather than `name`, just use a different `ORDER BY` clause:

```
mysql> SELECT name, birth, CURDATE(),
-> (YEAR(CURDATE())-YEAR(birth))
-> - (RIGHT(CURDATE(),5)<RIGHT(birth,5))
-> AS age
-> FROM pet ORDER BY age;
```

name	birth	CURDATE()	age
Chirpy	1998-09-11	2003-08-19	4
Puffball	1999-03-30	2003-08-19	4
Whistler	1997-12-09	2003-08-19	5
Slim	1996-04-29	2003-08-19	7
Claws	1994-03-17	2003-08-19	9
Fluffy	1993-02-04	2003-08-19	10
Fang	1990-08-27	2003-08-19	12
Bowser	1989-08-31	2003-08-19	13
Buffy	1989-05-13	2003-08-19	14

A similar query can be used to determine age at death for animals that have died. You determine which animals these are by checking whether the `death` value is `NULL`. Then, for those with non-`NULL` values, compute the difference between the `death` and `birth` values:

```
mysql> SELECT name, birth, death,
-> (YEAR(death)-YEAR(birth)) - (RIGHT(death,5)<RIGHT(birth,5))
-> AS age
-> FROM pet WHERE death IS NOT NULL ORDER BY age;
```

name	birth	death	age
Bowser	1989-08-31	1995-07-29	5

The query uses `death IS NOT NULL` rather than `death <> NULL` because `NULL` is a special value that cannot be compared using the usual comparison operators. This is discussed later. See [Section 3.3.4.6, “Working with NULL Values”](#).

What if you want to know which animals have birthdays next month? For this type of calculation, year and day are irrelevant; you simply want to extract the month part of the `birth` column. MySQL provides several functions for extracting parts of dates, such as `YEAR()`, `MONTH()`, and `DAYOFMONTH()`. `MONTH()` is the appropriate function here. To see how it works, run a simple query that displays the value of both `birth` and `MONTH(birth)`:

```
mysql> SELECT name, birth, MONTH(birth) FROM pet;
```

name	birth	MONTH(birth)
Fluffy	1993-02-04	2
Claws	1994-03-17	3
Buffy	1989-05-13	5
Fang	1990-08-27	8
Bowser	1989-08-31	8
Chirpy	1998-09-11	9
Whistler	1997-12-09	12
Slim	1996-04-29	4
Puffball	1999-03-30	3

Finding animals with birthdays in the upcoming month is also simple. Suppose that the current month is April. Then the month



value is 4 and you can look for animals born in May (month 5) like this:

```
mysql> SELECT name, birth FROM pet WHERE MONTH(birth) = 5;
+-----+-----+
| name  | birth |
+-----+-----+
| Buffy | 1989-05-13 |
+-----+-----+
```

There is a small complication if the current month is December. You cannot merely add one to the month number (12) and look for animals born in month 13, because there is no such month. Instead, you look for animals born in January (month 1).

You can write the query so that it works no matter what the current month is, so that you do not have to use the number for a particular month. `DATE_ADD()` allows you to add a time interval to a given date. If you add a month to the value of `CURDATE()`, then extract the month part with `MONTH()`, the result produces the month in which to look for birthdays:

```
mysql> SELECT name, birth FROM pet
-> WHERE MONTH(birth) = MONTH(DATE_ADD(CURDATE(), INTERVAL 1 MONTH));
```

A different way to accomplish the same task is to add 1 to get the next month after the current one after using the modulo function (`MOD`) to wrap the month value to 0 if it is currently 12:

```
mysql> SELECT name, birth FROM pet
-> WHERE MONTH(birth) = MOD(MONTH(CURDATE()), 12) + 1;
```

Note that `MONTH()` returns a number between 1 and 12. And `MOD(something, 12)` returns a number between 0 and 11. So the addition has to be after the `MOD()`, otherwise we would go from November (11) to January (1).

### 3.3.4.6. Working with NULL Values

The `NULL` value can be surprising until you get used to it. Conceptually, `NULL` means “a missing unknown value” and it is treated somewhat differently from other values. To test for `NULL`, you cannot use the arithmetic comparison operators such as `=`, `<`, or `<>`. To demonstrate this for yourself, try the following query:

```
mysql> SELECT 1 = NULL, 1 <> NULL, 1 < NULL, 1 > NULL;
+-----+-----+-----+-----+
| 1 = NULL | 1 <> NULL | 1 < NULL | 1 > NULL |
+-----+-----+-----+-----+
| NULL    | NULL     | NULL     | NULL     |
+-----+-----+-----+-----+
```

Clearly you get no meaningful results from these comparisons. Use the `IS NULL` and `IS NOT NULL` operators instead:

```
mysql> SELECT 1 IS NULL, 1 IS NOT NULL;
+-----+-----+
| 1 IS NULL | 1 IS NOT NULL |
+-----+-----+
| 0        | 1            |
+-----+-----+
```

Note that in MySQL, 0 or `NULL` means false and anything else means true. The default truth value from a boolean operation is 1.

This special treatment of `NULL` is why, in the previous section, it was necessary to determine which animals are no longer alive using `death IS NOT NULL` instead of `death <> NULL`.

Two `NULL` values are regarded as equal in a `GROUP BY`.

When doing an `ORDER BY`, `NULL` values are presented first if you do `ORDER BY ... ASC` and last if you do `ORDER BY ... DESC`.

A common error when working with `NULL` is to assume that it is not possible to insert a zero or an empty string into a column defined as `NOT NULL`, but this is not the case. These are in fact values, whereas `NULL` means “not having a value.” You can test this easily enough by using `IS [NOT] NULL` as shown:

```
mysql> SELECT 0 IS NULL, 0 IS NOT NULL, '' IS NULL, '' IS NOT NULL;
+-----+-----+-----+-----+
| 0 IS NULL | 0 IS NOT NULL | '' IS NULL | '' IS NOT NULL |
+-----+-----+-----+-----+
| 0        | 1            | 0        | 1            |
+-----+-----+-----+-----+
```

Thus it is entirely possible to insert a zero or empty string into a `NOT NULL` column, as these are in fact `NOT NULL`. See [Section B.1.5.3, “Problems with NULL Values”](#).

### 3.3.4.7. Pattern Matching

MySQL provides standard SQL pattern matching as well as a form of pattern matching based on extended regular expressions similar to those used by Unix utilities such as `vi`, `grep`, and `sed`.

SQL pattern matching allows you to use “`_`” to match any single character and “`%`” to match an arbitrary number of characters (including zero characters). In MySQL, SQL patterns are case-insensitive by default. Some examples are shown here. Note that you do not use `=` or `<>` when you use SQL patterns; use the `LIKE` or `NOT LIKE` comparison operators instead.

To find names beginning with “`b`”:

```
mysql> SELECT * FROM pet WHERE name LIKE 'b%';
```

name	owner	species	sex	birth	death
Buffy	Harold	dog	f	1989-05-13	NULL
Bowser	Diane	dog	m	1989-08-31	1995-07-29

To find names ending with “`fy`”:

```
mysql> SELECT * FROM pet WHERE name LIKE '%fy';
```

name	owner	species	sex	birth	death
Fluffy	Harold	cat	f	1993-02-04	NULL
Buffy	Harold	dog	f	1989-05-13	NULL

To find names containing a “`w`”:

```
mysql> SELECT * FROM pet WHERE name LIKE '%w%';
```

name	owner	species	sex	birth	death
Claws	Gwen	cat	m	1994-03-17	NULL
Bowser	Diane	dog	m	1989-08-31	1995-07-29
Whistler	Gwen	bird	NULL	1997-12-09	NULL

To find names containing exactly five characters, use five instances of the “`_`” pattern character:

```
mysql> SELECT * FROM pet WHERE name LIKE '_____';
```

name	owner	species	sex	birth	death
Claws	Gwen	cat	m	1994-03-17	NULL
Buffy	Harold	dog	f	1989-05-13	NULL

The other type of pattern matching provided by MySQL uses extended regular expressions. When you test for a match for this type of pattern, use the `REGEXP` and `NOT REGEXP` operators (or `RLIKE` and `NOT RLIKE`, which are synonyms).

Some characteristics of extended regular expressions are:

- “`.`” matches any single character.
- A character class “[`...`]” matches any character within the brackets. For example, “[`abc`]” matches “`a`”, “`b`”, or “`c`”. To name a range of characters, use a dash. “[`a-z`]” matches any letter, whereas “[`0-9`]” matches any digit.
- “`*`” matches zero or more instances of the thing preceding it. For example, “`x*`” matches any number of “`x`” characters, “[`0-9`]\*” matches any number of digits, and “`.*`” matches any number of anything.
- A `REGEXP` pattern match succeeds if the pattern matches anywhere in the value being tested. (This differs from a `LIKE` pattern match, which succeeds only if the pattern matches the entire value.)
- To anchor a pattern so that it must match the beginning or end of the value being tested, use “`^`” at the beginning or “`$`” at the end of the pattern.

To demonstrate how extended regular expressions work, the `LIKE` queries shown previously are rewritten here to use `REGEXP`.

To find names beginning with “`b`”, use “`^`” to match the beginning of the name:

```
mysql> SELECT * FROM pet WHERE name REGEXP '^b';
```

name	owner	species	sex	birth	death
Buffy	Harold	dog	f	1989-05-13	NULL
Bowser	Diane	dog	m	1989-08-31	1995-07-29

If you really want to force a `REGEXP` comparison to be case sensitive, use the `BINARY` keyword to make one of the strings a binary string. This query matches only lowercase “b” at the beginning of a name:

```
mysql> SELECT * FROM pet WHERE name REGEXP BINARY '^b';
```

To find names ending with “fy”, use “\$” to match the end of the name:

```
mysql> SELECT * FROM pet WHERE name REGEXP 'fy$';
```

name	owner	species	sex	birth	death
Fluffy	Harold	cat	f	1993-02-04	NULL
Buffy	Harold	dog	f	1989-05-13	NULL

To find names containing a “w”, use this query:

```
mysql> SELECT * FROM pet WHERE name REGEXP 'w';
```

name	owner	species	sex	birth	death
Claws	Gwen	cat	m	1994-03-17	NULL
Bowser	Diane	dog	m	1989-08-31	1995-07-29
Whistler	Gwen	bird	NULL	1997-12-09	NULL

Because a regular expression pattern matches if it occurs anywhere in the value, it is not necessary in the previous query to put a wildcard on either side of the pattern to get it to match the entire value like it would be if you used an SQL pattern.

To find names containing exactly five characters, use “^” and “\$” to match the beginning and end of the name, and five instances of “.” in between:

```
mysql> SELECT * FROM pet WHERE name REGEXP '^.....$';
```

name	owner	species	sex	birth	death
Claws	Gwen	cat	m	1994-03-17	NULL
Buffy	Harold	dog	f	1989-05-13	NULL

You could also write the previous query using the `{n}` (“repeat-*n*-times”) operator:

```
mysql> SELECT * FROM pet WHERE name REGEXP '^.{5}$';
```

name	owner	species	sex	birth	death
Claws	Gwen	cat	m	1994-03-17	NULL
Buffy	Harold	dog	f	1989-05-13	NULL

Section 11.4.2, “Regular Expressions”, provides more information about the syntax for regular expressions.

### 3.3.4.8. Counting Rows

Databases are often used to answer the question, “How often does a certain type of data occur in a table?” For example, you might want to know how many pets you have, or how many pets each owner has, or you might want to perform various kinds of census operations on your animals.

Counting the total number of animals you have is the same question as “How many rows are in the `pet` table?” because there is one record per pet. `COUNT(*)` counts the number of rows, so the query to count your animals looks like this:

```
mysql> SELECT COUNT(*) FROM pet;
```

COUNT(*)
9

Earlier, you retrieved the names of the people who owned pets. You can use `COUNT()` if you want to find out how many pets each owner has:

```
mysql> SELECT owner, COUNT(*) FROM pet GROUP BY owner;
```

owner	COUNT(*)
Benny	2
Diane	2
Gwen	3
Harold	2

Note the use of `GROUP BY` to group all records for each `owner`. Without it, all you get is an error message:

```
mysql> SELECT owner, COUNT(*) FROM pet;
ERROR 1140 (42000): Mixing of GROUP columns (MIN(),MAX(),COUNT(),...)
with no GROUP columns is illegal if there is no GROUP BY clause
```

`COUNT()` and `GROUP BY` are useful for characterizing your data in various ways. The following examples show different ways to perform animal census operations.

Number of animals per species:

```
mysql> SELECT species, COUNT(*) FROM pet GROUP BY species;
```

species	COUNT(*)
bird	2
cat	2
dog	3
hamster	1
snake	1

Number of animals per sex:

```
mysql> SELECT sex, COUNT(*) FROM pet GROUP BY sex;
```

sex	COUNT(*)
NULL	1
f	4
m	4

(In this output, `NULL` indicates that the sex is unknown.)

Number of animals per combination of species and sex:

```
mysql> SELECT species, sex, COUNT(*) FROM pet GROUP BY species, sex;
```

species	sex	COUNT(*)
bird	NULL	1
bird	f	1
cat	f	1
cat	m	1
dog	f	1
dog	m	2
hamster	f	1
snake	m	1

You need not retrieve an entire table when you use `COUNT()`. For example, the previous query, when performed just on dogs and cats, looks like this:

```
mysql> SELECT species, sex, COUNT(*) FROM pet
-> WHERE species = 'dog' OR species = 'cat'
-> GROUP BY species, sex;
```

species	sex	COUNT(*)
cat	f	1
cat	m	1
dog	f	1
dog	m	2

Or, if you wanted the number of animals per sex only for animals whose sex is known:

```
mysql> SELECT species, sex, COUNT(*) FROM pet
-> WHERE sex IS NOT NULL
-> GROUP BY species, sex;
```

species	sex	COUNT(*)
bird	f	1

cat	f	1
cat	m	1
dog	f	1
dog	m	2
hamster	f	1
snake	m	1

### 3.3.4.9. Using More Than one Table

The `pet` table keeps track of which pets you have. If you want to record other information about them, such as events in their lives like visits to the vet or when litters are born, you need another table. What should this table look like? It needs:

- To contain the pet name so that you know which animal each event pertains to.
- A date so that you know when the event occurred.
- A field to describe the event.
- An event type field, if you want to be able to categorize events.

Given these considerations, the `CREATE TABLE` statement for the `event` table might look like this:

```
mysql> CREATE TABLE event (name VARCHAR(20), date DATE,
-> type VARCHAR(15), remark VARCHAR(255));
```

As with the `pet` table, it is easiest to load the initial records by creating a tab-delimited text file containing the following information.

name	date	type	remark
Fluffy	1995-05-15	litter	4 kittens, 3 female, 1 male
Buffy	1993-06-23	litter	5 puppies, 2 female, 3 male
Buffy	1994-06-19	litter	3 puppies, 3 female
Chirpy	1999-03-21	vet	needed beak straightened
Slim	1997-08-03	vet	broken rib
Bowser	1991-10-12	kennel	
Fang	1991-10-12	kennel	
Fang	1998-08-28	birthday	Gave him a new chew toy
Claws	1998-03-17	birthday	Gave him a new flea collar
Whistler	1998-12-09	birthday	First birthday

Load the records like this:

```
mysql> LOAD DATA LOCAL INFILE 'event.txt' INTO TABLE event;
```

Based on what you have learned from the queries that you have run on the `pet` table, you should be able to perform retrievals on the records in the `event` table; the principles are the same. But when is the `event` table by itself insufficient to answer questions you might ask?

Suppose that you want to find out the ages at which each pet had its litters. We saw earlier how to calculate ages from two dates. The litter date of the mother is in the `event` table, but to calculate her age on that date you need her birth date, which is stored in the `pet` table. This means the query requires both tables:

```
mysql> SELECT pet.name,
-> (YEAR(date)-YEAR(birth)) - (RIGHT(date,5)<RIGHT(birth,5)) AS age,
-> remark
-> FROM pet INNER JOIN event
-> ON pet.name = event.name
-> WHERE event.type = 'litter';
```

name	age	remark
Fluffy	2	4 kittens, 3 female, 1 male
Buffy	4	5 puppies, 2 female, 3 male
Buffy	5	3 puppies, 3 female

There are several things to note about this query:

- The `FROM` clause joins two tables because the query needs to pull information from both of them.
- When combining (joining) information from multiple tables, you need to specify how records in one table can be matched to records in the other. This is easy because they both have a `name` column. The query uses an `ON` clause to match up records in the two tables based on the `name` values.

The query uses an `INNER JOIN` to combine the tables. An `INNER JOIN` allows for rows from either table to appear in the result if and only if both tables meet the conditions specified in the `ON` clause. In this example, the `ON` clause specifies that the `name` column in the `pet` table must match the `name` column in the `event` table. If a name appears in one table but not the other, the row will not appear in the result because the condition in the `ON` clause fails.

- Because the `name` column occurs in both tables, you must be specific about which table you mean when referring to the column. This is done by prepending the table name to the column name.

You need not have two different tables to perform a join. Sometimes it is useful to join a table to itself, if you want to compare records in a table to other records in that same table. For example, to find breeding pairs among your pets, you can join the `pet` table with itself to produce candidate pairs of males and females of like species:

```
mysql> SELECT p1.name, p1.sex, p2.name, p2.sex, p1.species
-> FROM pet AS p1 INNER JOIN pet AS p2
-> ON p1.species = p2.species AND p1.sex = 'f' AND p2.sex = 'm';
```

name	sex	name	sex	species
Fluffy	f	Claws	m	cat
Buffy	f	Fang	m	dog
Buffy	f	Bowser	m	dog

In this query, we specify aliases for the table name to refer to the columns and keep straight which instance of the table each column reference is associated with.

## 3.4. Getting Information About Databases and Tables

What if you forget the name of a database or table, or what the structure of a given table is (for example, what its columns are called)? MySQL addresses this problem through several statements that provide information about the databases and tables it supports.

You have previously seen `SHOW DATABASES`, which lists the databases managed by the server. To find out which database is currently selected, use the `DATABASE()` function:

```
mysql> SELECT DATABASE();
```

DATABASE()
menagerie

If you have not yet selected any database, the result is `NULL`.

To find out what tables the default database contains (for example, when you are not sure about the name of a table), use this command:

```
mysql> SHOW TABLES;
```

Tables_in_menagerie
event
pet

The name of the column in the output produced by this statement is always `Tables_in_db_name`, where `db_name` is the name of the database. See [Section 12.5.5.39, “SHOW TABLES Syntax”](#), for more information.

If you want to find out about the structure of a table, the `DESCRIBE` command is useful; it displays information about each of a table's columns:

```
mysql> DESCRIBE pet;
```

Field	Type	Null	Key	Default	Extra
name	varchar(20)	YES		NULL	

owner	varchar(20)	YES		NULL	
species	varchar(20)	YES		NULL	
sex	char(1)	YES		NULL	
birth	date	YES		NULL	
death	date	YES		NULL	

**Field** indicates the column name, **Type** is the data type for the column, **NULL** indicates whether the column can contain **NULL** values, **Key** indicates whether the column is indexed, and **Default** specifies the column's default value. **Extra** displays special information about columns: If a column was created with the **AUTO\_INCREMENT** option, the value will be **auto\_increment** rather than empty.

**DESC** is a short form of **DESCRIBE**. See [Section 12.3.1, “DESCRIBE Syntax”](#), for more information.

You can obtain the **CREATE TABLE** statement necessary to create an existing table using the **SHOW CREATE TABLE** statement. See [Section 12.5.5.12, “SHOW CREATE TABLE Syntax”](#).

If you have indexes on a table, **SHOW INDEX FROM tbl\_name** produces information about them. See [Section 12.5.5.23, “SHOW INDEX Syntax”](#), for more about this statement.

## 3.5. Using `mysql` in Batch Mode

In the previous sections, you used `mysql` interactively to enter queries and view the results. You can also run `mysql` in batch mode. To do this, put the commands you want to run in a file, then tell `mysql` to read its input from the file:

```
shell> mysql < batch-file
```

If you are running `mysql` under Windows and have some special characters in the file that cause problems, you can do this:

```
C:\> mysql -e "source batch-file"
```

If you need to specify connection parameters on the command line, the command might look like this:

```
shell> mysql -h host -u user -p < batch-file
Enter password: *****
```

When you use `mysql` this way, you are creating a script file, then executing the script.

If you want the script to continue even if some of the statements in it produce errors, you should use the `--force` command-line option.

Why use a script? Here are a few reasons:

- If you run a query repeatedly (say, every day or every week), making it a script allows you to avoid retyping it each time you execute it.
- You can generate new queries from existing ones that are similar by copying and editing script files.
- Batch mode can also be useful while you're developing a query, particularly for multiple-line commands or multiple-statement sequences of commands. If you make a mistake, you don't have to retype everything. Just edit your script to correct the error, then tell `mysql` to execute it again.
- If you have a query that produces a lot of output, you can run the output through a pager rather than watching it scroll off the top of your screen:

```
shell> mysql < batch-file | more
```

- You can catch the output in a file for further processing:

```
shell> mysql < batch-file > mysql.out
```

- You can distribute your script to other people so that they can also run the commands.
- Some situations do not allow for interactive use, for example, when you run a query from a `cron` job. In this case, you must use batch mode.

The default output format is different (more concise) when you run `mysql` in batch mode than when you use it interactively. For example, the output of `SELECT DISTINCT species FROM pet` looks like this when `mysql` is run interactively:



```
+-----+
| species |
+-----+
| bird   |
| cat   |
| dog   |
| hamster |
| snake |
+-----+
```

In batch mode, the output looks like this instead:

```
species
bird
cat
dog
hamster
snake
```

If you want to get the interactive output format in batch mode, use `mysql -t`. To echo to the output the commands that are executed, use `mysql -vvv`.

You can also use scripts from the `mysql` prompt by using the `source` command or `\.` command:

```
mysql> source filename;
mysql> \. filename
```

See [Section 4.5.1.4, “Executing SQL Statements from a Text File”](#), for more information.

## 3.6. Examples of Common Queries

Here are examples of how to solve some common problems with MySQL.

Some of the examples use the table `shop` to hold the price of each article (item number) for certain traders (dealers). Supposing that each trader has a single fixed price per article, then (`article, dealer`) is a primary key for the records.

Start the command-line tool `mysql` and select a database:

```
shell> mysql your-database-name
```

(In most MySQL installations, you can use the database named `test`).

You can create and populate the example table with these statements:

```
CREATE TABLE shop (
  article INT(4) UNSIGNED ZEROFILL DEFAULT '0000' NOT NULL,
  dealer CHAR(20) DEFAULT '' NOT NULL,
  price DOUBLE(16,2) DEFAULT '0.00' NOT NULL,
  PRIMARY KEY(article, dealer));
INSERT INTO shop VALUES
(1, 'A', 3.45), (1, 'B', 3.99), (2, 'A', 10.99), (3, 'B', 1.45),
(3, 'C', 1.69), (3, 'D', 1.25), (4, 'D', 19.95);
```

After issuing the statements, the table should have the following contents:

```
SELECT * FROM shop;
```

```
+-----+-----+-----+
| article | dealer | price |
+-----+-----+-----+
| 0001   | A     | 3.45  |
| 0001   | B     | 3.99  |
| 0002   | A     | 10.99 |
| 0003   | B     | 1.45  |
| 0003   | C     | 1.69  |
| 0003   | D     | 1.25  |
| 0004   | D     | 19.95 |
+-----+-----+-----+
```

### 3.6.1. The Maximum Value for a Column

“What is the highest item number?”

```
SELECT MAX(article) AS article FROM shop;
```

```
+-----+
| article |
+-----+
```

```
+-----+
|      4      |
+-----+
```

### 3.6.2. The Row Holding the Maximum of a Certain Column

*Task: Find the number, dealer, and price of the most expensive article.*

This is easily done with a subquery:

```
SELECT article, dealer, price
FROM shop
WHERE price=(SELECT MAX(price) FROM shop);
```

```
+-----+-----+-----+
| article | dealer | price |
+-----+-----+-----+
|    0004 | D      | 19.95 |
+-----+-----+-----+
```

Other solutions are to use a [LEFT JOIN](#) or to sort all rows descending by price and get only the first row using the MySQL-specific [LIMIT](#) clause:

```
SELECT s1.article, s1.dealer, s1.price
FROM shop s1
LEFT JOIN shop s2 ON s1.price < s2.price
WHERE s2.article IS NULL;
```

```
SELECT article, dealer, price
FROM shop
ORDER BY price DESC
LIMIT 1;
```

#### Note

If there were several most expensive articles, each with a price of 19.95, the [LIMIT](#) solution would show only one of them.

### 3.6.3. Maximum of Column per Group

*Task: Find the highest price per article.*

```
SELECT article, MAX(price) AS price
FROM shop
GROUP BY article;
```

```
+-----+-----+
| article | price |
+-----+-----+
|    0001 | 3.99  |
|    0002 | 10.99 |
|    0003 | 1.69  |
|    0004 | 19.95 |
+-----+-----+
```

### 3.6.4. The Rows Holding the Group-wise Maximum of a Certain Field

*Task: For each article, find the dealer or dealers with the most expensive price.*

This problem can be solved with a subquery like this one:

```
SELECT article, dealer, price
FROM shop s1
WHERE price=(SELECT MAX(s2.price)
             FROM shop s2
             WHERE s1.article = s2.article);
```

```
+-----+-----+-----+
| article | dealer | price |
+-----+-----+-----+
|    0001 | B      | 3.99  |
|    0002 | A      | 10.99 |
|    0003 | C      | 1.69  |
|    0004 | D      | 19.95 |
+-----+-----+-----+
```

The preceding example uses a correlated subquery, which can be inefficient (see [Section 12.2.9.7, “Correlated Subqueries”](#)). Other possibilities for solving the problem are to use an uncorrelated subquery in the [FROM](#) clause or a [LEFT JOIN](#):

```

SELECT s1.article, dealer, s1.price
FROM shop s1
JOIN (
  SELECT article, MAX(price) AS price
  FROM shop
  GROUP BY article) AS s2
  ON s1.article = s2.article AND s1.price = s2.price;

SELECT s1.article, s1.dealer, s1.price
FROM shop s1
LEFT JOIN shop s2 ON s1.article = s2.article AND s1.price < s2.price
WHERE s2.article IS NULL;

```

The `LEFT JOIN` works on the basis that when `s1.price` is at its maximum value, there is no `s2.price` with a greater value and the `s2` rows values will be `NULL`. See [Section 12.2.8.1, “JOIN Syntax”](#).

### 3.6.5. Using User-Defined Variables

You can employ MySQL user variables to remember results without having to store them in temporary variables in the client. (See [Section 8.4, “User-Defined Variables”](#).)

For example, to find the articles with the highest and lowest price you can do this:

```

mysql> SELECT @min_price:=MIN(price),@max_price:=MAX(price) FROM shop;
mysql> SELECT * FROM shop WHERE price=@min_price OR price=@max_price;
+-----+-----+-----+
| article | dealer | price |
+-----+-----+-----+
| 0003    | D      | 1.25  |
| 0004    | D      | 19.95 |
+-----+-----+-----+

```

#### Note

It is also possible to store the name of a database object such as a table or a column in a user variable and then to use this variable in an SQL statement; however, this requires the use of a prepared statement. See [Section 12.7, “SQL Syntax for Prepared Statements”](#), for more information.

### 3.6.6. Using Foreign Keys

In MySQL, `InnoDB` tables support checking of foreign key constraints. See [Section 13.6, “The InnoDB Storage Engine”](#), and [Section 1.7.5.4, “Foreign Keys”](#).

A foreign key constraint is not required merely to join two tables. For storage engines other than `InnoDB`, it is possible when defining a column to use a `REFERENCES tbl_name(col_name)` clause, which has no actual effect, and *serves only as a memo or comment to you that the column which you are currently defining is intended to refer to a column in another table*. It is extremely important to realize when using this syntax that:

- MySQL does not perform any sort of `CHECK` to make sure that `col_name` actually exists in `tbl_name` (or even that `tbl_name` itself exists).
- MySQL does not perform any sort of action on `tbl_name` such as deleting rows in response to actions taken on rows in the table which you are defining; in other words, this syntax induces no `ON DELETE` or `ON UPDATE` behavior whatsoever. (Although you can write an `ON DELETE` or `ON UPDATE` clause as part of the `REFERENCES` clause, it is also ignored.)
- This syntax creates a *column*; it does **not** create any sort of index or key.

You can use a column so created as a join column, as shown here:

```

CREATE TABLE person (
  id SMALLINT UNSIGNED NOT NULL AUTO_INCREMENT,
  name CHAR(60) NOT NULL,
  PRIMARY KEY (id)
);

CREATE TABLE shirt (
  id SMALLINT UNSIGNED NOT NULL AUTO_INCREMENT,
  style ENUM('t-shirt', 'polo', 'dress') NOT NULL,
  color ENUM('red', 'blue', 'orange', 'white', 'black') NOT NULL,
  owner SMALLINT UNSIGNED NOT NULL REFERENCES person(id),
  PRIMARY KEY (id)
);

INSERT INTO person VALUES (NULL, 'Antonio Paz');

SELECT @last := LAST_INSERT_ID();

```

```

INSERT INTO shirt VALUES
(NULL, 'polo', 'blue', @last),
(NULL, 'dress', 'white', @last),
(NULL, 't-shirt', 'blue', @last);

INSERT INTO person VALUES (NULL, 'Lilliana Angelovska');

SELECT @last := LAST_INSERT_ID();

INSERT INTO shirt VALUES
(NULL, 'dress', 'orange', @last),
(NULL, 'polo', 'red', @last),
(NULL, 'dress', 'blue', @last),
(NULL, 't-shirt', 'white', @last);

SELECT * FROM person;
+-----+-----+
| id | name |
+-----+-----+
| 1 | Antonio Paz |
| 2 | Lilliana Angelovska |
+-----+-----+

SELECT * FROM shirt;
+-----+-----+-----+-----+
| id | style | color | owner |
+-----+-----+-----+-----+
| 1 | polo | blue | 1 |
| 2 | dress | white | 1 |
| 3 | t-shirt | blue | 1 |
| 4 | dress | orange | 2 |
| 5 | polo | red | 2 |
| 6 | dress | blue | 2 |
| 7 | t-shirt | white | 2 |
+-----+-----+-----+-----+

SELECT s.* FROM person p INNER JOIN shirt s
ON s.owner = p.id
WHERE p.name LIKE 'Lilliana%'
AND s.color <> 'white';

+-----+-----+-----+-----+
| id | style | color | owner |
+-----+-----+-----+-----+
| 4 | dress | orange | 2 |
| 5 | polo | red | 2 |
| 6 | dress | blue | 2 |
+-----+-----+-----+-----+

```

When used in this fashion, the [REFERENCES](#) clause is not displayed in the output of `SHOW CREATE TABLE` or `DESCRIBE`:

```

SHOW CREATE TABLE shirt\G
***** 1. row *****
Table: shirt
Create Table: CREATE TABLE `shirt` (
  `id` smallint(5) unsigned NOT NULL auto_increment,
  `style` enum('t-shirt','polo','dress') NOT NULL,
  `color` enum('red','blue','orange','white','black') NOT NULL,
  `owner` smallint(5) unsigned NOT NULL,
  PRIMARY KEY (`id`)
) ENGINE=MyISAM DEFAULT CHARSET=latin1

```

The use of [REFERENCES](#) in this way as a comment or “reminder” in a column definition works with [MyISAM](#) tables.

### 3.6.7. Searching on Two Keys

An [OR](#) using a single key is well optimized, as is the handling of [AND](#).

The one tricky case is that of searching on two different keys combined with [OR](#):

```

SELECT field1_index, field2_index FROM test_table
WHERE field1_index = '1' OR field2_index = '1'

```

This case is optimized. See [Section 7.2.6, “Index Merge Optimization”](#).

You can also solve the problem efficiently by using a [UNION](#) that combines the output of two separate `SELECT` statements. See [Section 12.2.8.3, “UNION Syntax”](#).

Each `SELECT` searches only one key and can be optimized:

```

SELECT field1_index, field2_index
FROM test_table WHERE field1_index = '1'
UNION
SELECT field1_index, field2_index
FROM test_table WHERE field2_index = '1';

```

### 3.6.8. Calculating Visits Per Day

The following example shows how you can use the bit group functions to calculate the number of days per month a user has visited a Web page.

```
CREATE TABLE t1 (year YEAR(4), month INT(2) UNSIGNED ZEROFILL,
                 day INT(2) UNSIGNED ZEROFILL);
INSERT INTO t1 VALUES(2000,1,1),(2000,1,20),(2000,1,30),(2000,2,2),
(2000,2,23),(2000,2,23);
```

The example table contains year-month-day values representing visits by users to the page. To determine how many different days in each month these visits occur, use this query:

```
SELECT year,month,BIT_COUNT(BIT_OR(1<<day)) AS days FROM t1
GROUP BY year,month;
```

Which returns:

year	month	days
2000	01	3
2000	02	2

The query calculates how many different days appear in the table for each year/month combination, with automatic removal of duplicate entries.

### 3.6.9. Using `AUTO_INCREMENT`

The `AUTO_INCREMENT` attribute can be used to generate a unique identity for new rows:

```
CREATE TABLE animals (
  id MEDIUMINT NOT NULL AUTO_INCREMENT,
  name CHAR(30) NOT NULL,
  PRIMARY KEY (id)
);
INSERT INTO animals (name) VALUES
('dog'),('cat'),('penguin'),
('lax'),('whale'),('ostrich');
SELECT * FROM animals;
```

Which returns:

id	name
1	dog
2	cat
3	penguin
4	lax
5	whale
6	ostrich

You can retrieve the most recent `AUTO_INCREMENT` value with the `LAST_INSERT_ID()` SQL function or the `mysql_insert_id()` C API function. These functions are connection-specific, so their return values are not affected by another connection which is also performing inserts.

#### Note

For a multiple-row insert, `LAST_INSERT_ID()` and `mysql_insert_id()` actually return the `AUTO_INCREMENT` key from the *first* of the inserted rows. This allows multiple-row inserts to be reproduced correctly on other servers in a replication setup.

For `MyISAM` tables you can specify `AUTO_INCREMENT` on a secondary column in a multiple-column index. In this case, the generated value for the `AUTO_INCREMENT` column is calculated as `MAX(auto_increment_column) + 1 WHERE prefix=given-prefix`. This is useful when you want to put data into ordered groups.

```
CREATE TABLE animals (
  grp ENUM('fish','mammal','bird') NOT NULL,
  id MEDIUMINT NOT NULL AUTO_INCREMENT,
```

```

name CHAR(30) NOT NULL,
PRIMARY KEY (grp,id)
);

INSERT INTO animals (grp,name) VALUES
('mammal','dog'),('mammal','cat'),
('bird','penguin'),('fish','lax'),('mammal','whale'),
('bird','ostrich');

SELECT * FROM animals ORDER BY grp,id;

```

Which returns:

grp	id	name
fish	1	lax
mammal	1	dog
mammal	2	cat
mammal	3	whale
bird	1	penguin
bird	2	ostrich

Note that in this case (when the `AUTO_INCREMENT` column is part of a multiple-column index), `AUTO_INCREMENT` values are reused if you delete the row with the biggest `AUTO_INCREMENT` value in any group. This happens even for `MyISAM` tables, for which `AUTO_INCREMENT` values normally are not reused.

If the `AUTO_INCREMENT` column is part of multiple indexes, MySQL will generate sequence values using the index that begins with the `AUTO_INCREMENT` column, if there is one. For example, if the `animals` table contained indexes `PRIMARY KEY (grp, id)` and `INDEX (id)`, MySQL would ignore the `PRIMARY KEY` for generating sequence values. As a result, the table would contain a single sequence, not a sequence per `grp` value.

To start with an `AUTO_INCREMENT` value other than 1, you can set that value with `CREATE TABLE` or `ALTER TABLE`, like this:

```
mysql> ALTER TABLE tbl AUTO_INCREMENT = 100;
```

More information about `AUTO_INCREMENT` is available here:

- How to assign the `AUTO_INCREMENT` attribute to a column: [Section 12.1.17, “CREATE TABLE Syntax”](#), and [Section 12.1.7, “ALTER TABLE Syntax”](#).
- How `AUTO_INCREMENT` behaves depending on the SQL mode: [Section 5.1.7, “Server SQL Modes”](#).
- Find the row that contains the most recent `AUTO_INCREMENT` value: [Section 11.2.3, “Comparison Functions and Operators”](#).
- Set the `AUTO_INCREMENT` value to be used: [Section 5.1.4, “Session System Variables”](#).
- `AUTO_INCREMENT` and replication: [Section 16.3.1, “Replication Features and Issues”](#).
- Server-system variables related to `AUTO_INCREMENT` (`auto_increment_increment` and `auto_increment_offset`) that can be used for replication: [Section 5.1.3, “Server System Variables”](#).

## 3.7. Queries from the Twin Project

At the places the early MySQL was developed (Analytikerna and Lentus), the founders did systems and field work for a big research project. This project was a collaboration between the Institute of Environmental Medicine at Karolinska Institutet Stockholm and the Section on Clinical Research in Aging and Psychology at the University of Southern California.

The project involved lots of data collection from all twins in Sweden older than 65 Years (see <http://ki.se/ki/jsp/polopoly.jsp?d=9610&l=en>).

Large parts of the project were administered with a Web interface written using Perl and MySQL.

### 3.7.1. Find All Non-distributed Twins

The following query was used to determine what twins should be studied further after a initial screening. The time for this was around MySQL 3.19 in 1997.

```
SELECT
```

```

CONCAT(pl.id, pl.tvab) + 0 AS tvid,
CONCAT(pl.christian_name, ' ', pl.surname) AS Name,
pl.postal_code AS Code,
pl.city AS City,
pg.abrev AS Area,
IF(td.participation = 'Aborted', 'A', ' ') AS A,
pl.dead AS dead1,
l.event AS event1,
td.suspect AS tsuspect1,
id.suspect AS isuspect1,
td.severe AS tsevere1,
id.severe AS isevere1,
p2.dead AS dead2,
l2.event AS event2,
h2.nurse AS nurse2,
h2.doctor AS doctor2,
td2.suspect AS tsuspect2,
id2.suspect AS isuspect2,
td2.severe AS tsevere2,
id2.severe AS isevere2,
l.finish_date
FROM
  twin_project AS tp
  /* For Twin 1 */
  LEFT JOIN twin_data AS td ON tp.id = td.id
    AND tp.tvab = td.tvab
  LEFT JOIN informant_data AS id ON tp.id = id.id
    AND tp.tvab = id.tvab
  LEFT JOIN harmony AS h ON tp.id = h.id
    AND tp.tvab = h.tvab
  LEFT JOIN lentus AS l ON tp.id = l.id
    AND tp.tvab = l.tvab
  /* For Twin 2 */
  LEFT JOIN twin_data AS td2 ON p2.id = td2.id
    AND p2.tvab = td2.tvab
  LEFT JOIN informant_data AS id2 ON p2.id = id2.id
    AND p2.tvab = id2.tvab
  LEFT JOIN harmony AS h2 ON p2.id = h2.id
    AND p2.tvab = h2.tvab
  LEFT JOIN lentus AS l2 ON p2.id = l2.id
    AND p2.tvab = l2.tvab,
  person_data AS p1,
  person_data AS p2,
  postal_groups AS pg
WHERE
  /* p1 gets main twin and p2 gets his/her twin. */
  /* ptvab is a field inverted from tvab */
  p1.id = tp.id AND p1.tvab = tp.tvab AND
  p2.id = p1.id AND p2.ptvab = p1.tvab AND
  /* Just the screening survey */
  tp.survey_no = 5 AND
  /* Skip if partner died before 65 but allow emigration (dead=9) */
  (p2.dead = 0 OR p2.dead = 9 OR
   (p2.dead = 1 AND
    (p2.death_date = 0 OR
     ((TO_DAYS(p2.death_date) - TO_DAYS(p2.birthday)) / 365)
     >= 65))))
AND
  (
  /* Twin is suspect */
  (td.future_contact = 'Yes' AND td.suspect = 2) OR
  /* Twin is suspect - Informant is Blessed */
  (td.future_contact = 'Yes' AND td.suspect = 1
   AND id.suspect = 1) OR
  /* No twin - Informant is Blessed */
  (ISNULL(td.suspect) AND id.suspect = 1
   AND id.future_contact = 'Yes') OR
  /* Twin broken off - Informant is Blessed */
  (td.participation = 'Aborted'
   AND id.suspect = 1 AND id.future_contact = 'Yes') OR
  /* Twin broken off - No inform - Have partner */
  (td.participation = 'Aborted' AND ISNULL(id.suspect)
   AND p2.dead = 0))
AND
  l.event = 'Finished'
  /* Get at area code */
  AND SUBSTRING(pl.postal_code, 1, 2) = pg.code
  /* Not already distributed */
  AND (h.nurse IS NULL OR h.nurse=00 OR h.doctor=00)
  /* Has not refused or been aborted */
  AND NOT (h.status = 'Refused' OR h.status = 'Aborted'
  OR h.status = 'Died' OR h.status = 'Other')
ORDER BY
  tvid;

```

Some explanations:

- `CONCAT(pl.id, pl.tvab) + 0 AS tvid`

We want to sort on the concatenated `id` and `tvab` in numerical order. Adding `0` to the result causes MySQL to treat the result as a number.



- column `id`

This identifies a pair of twins. It is an index in all tables.

- column `tvab`

This identifies a twin in a pair. It has a value of 1 or 2.

- column `ptvab`

This is an inverse of `tvab`. When `tvab` is 1 this is 2, and vice versa. It exists to save typing and to make it easier for MySQL to optimize the query.

This query demonstrates, among other things, how to do lookups on a table from the same table with a join (`p1` and `p2`). In the example, this is used to check whether a twin's partner died before the age of 65. If so, the row is not returned.

All of the above exist in all tables with twin-related information. We have an index on both `id`, `tvab` (all tables), and `id`, `ptvab` (`person_data`) to make queries faster.

When we did this work, our production machine was a 200MHz UltraSPARC, and on that old hardware this query returned about 150-200 rows in less than one second. The main table had 70k Rows.

### 3.7.2. Show a Table of Twin Pair Status

Each twin has a status code called `event`. The query shown here is used to select all twin pairs combined by event. This indicates in how many pairs both twins are finished, in how many pairs one twin is finished and the other refused, and so on.

```
SELECT
    t1.event,
    t2.event,
    COUNT(*)
FROM
    lentus AS t1,
    lentus AS t2,
    twin_project AS tp
WHERE
    /* We are looking at one pair at a time */
    t1.id = tp.id
    AND t1.tvab=tp.tvab
    AND t1.id = t2.id
    /* Just the screening survey */
    AND tp.survey_no = 5
    /* This makes each pair only appear once */
    AND t1.tvab='1' AND t2.tvab='2'
GROUP BY
    t1.event, t2.event;
```

## 3.8. Using MySQL with Apache

There are programs that let you authenticate your users from a MySQL database and also let you write your log files into a MySQL table.

You can change the Apache logging format to be easily readable by MySQL by putting the following into the Apache configuration file:

```
LogFormat \
    "%h",%{Y%m%d%H%M%S}t,%>s,\"%b\", \"%{Content-Type}o\", \
    \"%U\", \"%{Referer}i\", \"%{User-Agent}i\""
```

To load a log file in that format into MySQL, you can use a statement something like this:

```
LOAD DATA INFILE '/local/access_log' INTO TABLE tbl_name
FIELDS TERMINATED BY ',' OPTIONALLY ENCLOSED BY '"' ESCAPED BY '\\'
```

The named table should be created to have columns that correspond to those that the `LogFormat` line writes to the log file.

---

# Chapter 4. MySQL Programs

This chapter provides a brief overview of the command-line programs provided by MySQL AB. It also discusses the general syntax for specifying options when you run these programs. Most programs have options that are specific to their own operation, but the option syntax is similar for all of them. Finally, the chapter provides more detailed descriptions of individual programs, including which options they recognize.

## 4.1. Overview of MySQL Programs

There are many different programs in a MySQL installation. This section provides a brief overview of them. Later sections provide a more detailed description of each one, with the exception of MySQL Cluster programs. Each program's description indicates its invocation syntax and the options that it supports. [MySQL Cluster NDB 6.X/7.X](#), describes programs specific to MySQL Cluster.

Most MySQL distributions include all of these programs, except for those programs that are platform-specific. (For example, the server startup scripts are not used on Windows.) The exception is that RPM distributions are more specialized. There is one RPM for the server, another for client programs, and so forth. If you appear to be missing one or more programs, see [Chapter 2, \*Installing and Upgrading MySQL\*](#), for information on types of distributions and what they contain. It may be that you have a distribution that does not include all programs and you need to install an additional package.

Each MySQL program takes many different options. Most programs provide a `--help` option that you can use to get a description of the program's different options. For example, try `mysql --help`.

You can override default option values for MySQL programs by specifying options on the command line or in an option file. See [Section 4.2, "Using MySQL Programs"](#), for general information on invoking programs and specifying program options.

The MySQL server, `mysqld`, is the main program that does most of the work in a MySQL installation. The server is accompanied by several related scripts that assist you in starting and stopping the server:

- `mysqld`  
The SQL daemon (that is, the MySQL server). To use client programs, `mysqld` must be running, because clients gain access to databases by connecting to the server. See [Section 4.3.1, "mysqld — The MySQL Server"](#).
- `mysqld_safe`  
A server startup script. `mysqld_safe` attempts to start `mysqld`. See [Section 4.3.2, "mysqld\\_safe — MySQL Server Startup Script"](#).
- `mysql.server`  
A server startup script. This script is used on systems that use System V-style run directories containing scripts that start system services for particular run levels. It invokes `mysqld_safe` to start the MySQL server. See [Section 4.3.3, "mysql.server — MySQL Server Startup Script"](#).
- `mysqld_multi`  
A server startup script that can start or stop multiple servers installed on the system. See [Section 4.3.4, "mysqld\\_multi — Manage Multiple MySQL Servers"](#). An alternative to `mysqld_multi` is `mysqlmanager`, the MySQL Instance Manager. See [Section 4.6.10, "mysqlmanager — The MySQL Instance Manager"](#).

There are several programs that perform setup operations during MySQL installation or upgrading:

- `comp_err`  
This program is used during the MySQL build/installation process. It compiles error message files from the error source files. See [Section 4.4.1, "comp\\_err — Compile MySQL Error Message File"](#).
- `make_binary_distribution`  
This program makes a binary release of a compiled MySQL. This could be sent by FTP to `/pub/mysql/upload/` on `ftp.mysql.com` for the convenience of other MySQL users.
- `make_win_bin_dist`  
This program is used on Windows. It packages a MySQL distribution for installation after the source distribution has been built. See [Section 4.4.2, "make\\_win\\_bin\\_dist — Package MySQL Distribution as ZIP Archive"](#).

- `mysql_fix_privilege_tables`

This program is used after a MySQL upgrade operation. It updates the grant tables with any changes that have been made in newer versions of MySQL. See [Section 4.4.4, “mysql\\_fix\\_privilege\\_tables — Upgrade MySQL System Tables”](#).

Note: As of MySQL 5.1.7, this program has been superseded by `mysql_upgrade` and should no longer be used.

- `mysql_install_db`

This script creates the MySQL database and initializes the grant tables with default privileges. It is usually executed only once, when first installing MySQL on a system. See [Section 4.4.5, “mysql\\_install\\_db — Initialize MySQL Data Directory”](#), [Section 2.11.2, “Unix Post-Installation Procedures”](#), and [Section 4.4.5, “mysql\\_install\\_db — Initialize MySQL Data Directory”](#).

- `mysql_secure_installation`

This program enables you to improve the security of your MySQL installation. SQL. See [Section 4.4.6, “mysql\\_secure\\_installation — Improve MySQL Installation Security”](#).

- `mysql_tzinfo_to_sql`

This program loads the time zone tables in the `mysql` database using the contents of the host system `zoneinfo` database (the set of files describing time zones). SQL. See [Section 4.4.7, “mysql\\_tzinfo\\_to\\_sql — Load the Time Zone Tables”](#).

- `mysql_upgrade`

This program is used after a MySQL upgrade operation. It checks tables for incompatibilities and repairs them if necessary, and updates the grant tables with any changes that have been made in newer versions of MySQL. See [Section 4.4.8, “mysql\\_upgrade — Check Tables for MySQL Upgrade”](#).

#### MySQL client programs:

- `mysql`

The command-line tool for interactively entering SQL statements or executing them from a file in batch mode. See [Section 4.5.1, “mysql — The MySQL Command-Line Tool”](#).

- `mysqladmin`

A client that performs administrative operations, such as creating or dropping databases, reloading the grant tables, flushing tables to disk, and reopening log files. `mysqladmin` can also be used to retrieve version, process, and status information from the server. See [Section 4.5.2, “mysqladmin — Client for Administering a MySQL Server”](#).

- `mysqlcheck`

A table-maintenance client that checks, repairs, analyzes, and optimizes tables. See [Section 4.5.3, “mysqlcheck — A Table Maintenance Program”](#).

- `mysqldump`

A client that dumps a MySQL database into a file as SQL, text, or XML. See [Section 4.5.4, “mysqldump — A Database Backup Program”](#).

- `mysqlimport`

A client that imports text files into their respective tables using `LOAD DATA INFILE`. See [Section 4.5.5, “mysqlimport — A Data Import Program”](#).

- `mysqlshow`

A client that displays information about databases, tables, columns, and indexes. See [Section 4.5.6, “mysqlshow — Display Database, Table, and Column Information”](#).

- `mysqlslap`

A client that is designed to emulate client load for a MySQL server and report the timing of each stage. It works as if multiple clients are accessing the server. See [Section 4.5.7, “mysqlslap — Load Emulation Client”](#).

#### MySQL administrative and utility programs:

- `innochecksum`

An offline InnoDB offline file checksum utility. See [Section 4.6.1, “innochecksum — Offline InnoDB File Checksum Utility”](#).
- `myisam_ftdump`

A utility that displays information about full-text indexes in MyISAM tables. See [Section 4.6.2, “myisam\\_ftdump — Display Full-Text Index information”](#).
- `myisamchk`

A utility to describe, check, optimize, and repair MyISAM tables. See [Section 4.6.3, “myisamchk — MyISAM Table-Maintenance Utility”](#).
- `myisamlog`, `isamlog`

A utility that processes the contents of a MyISAM log file. See [Section 4.6.4, “myisamlog — Display MyISAM Log File Contents”](#).
- `myisampack`

A utility that compresses MyISAM tables to produce smaller read-only tables. See [Section 4.6.5, “myisampack — Generate Compressed, Read-Only MyISAM Tables”](#).
- `mysqlaccess`

A script that checks the access privileges for a host name, user name, and database combination. See [Section 4.6.6, “mysqlaccess — Client for Checking Access Privileges”](#).
- `mysqlbinlog`

A utility for reading statements from a binary log. The log of executed statements contained in the binary log files can be used to help recover from a crash. See [Section 4.6.7, “mysqlbinlog — Utility for Processing Binary Log Files”](#).
- `mysqldumpslow`

A utility to read and summarize the contents of a slow query log. See [Section 4.6.8, “mysqldumpslow — Summarize Slow Query Log Files”](#).
- `mysqlhotcopy`

A utility that quickly makes backups of MyISAM tables while the server is running. See [Section 4.6.9, “mysqlhotcopy — A Database Backup Program”](#).
- `mysqlmanager`

The MySQL Instance Manager, a program for monitoring and managing MySQL servers. See [Section 4.6.10, “mysqlmanager — The MySQL Instance Manager”](#).

**Important**

MySQL Instance Manager has been deprecated and will be removed in MySQL 6.0.
- `mysql_convert_table_format`

A utility that converts tables in a database to use a given storage engine. See [Section 4.6.11, “mysql\\_convert\\_table\\_format — Convert Tables to Use a Given Storage Engine”](#).
- `mysql_find_rows`

A utility that reads files containing SQL statements (such as update logs) and extracts statements that match a given regular expression. See [Section 4.6.12, “mysql\\_find\\_rows — Extract SQL Statements from Files”](#).
- `mysql_fix_extensions`

A utility that converts the extensions for MyISAM table files to lowercase. This can be useful after transferring the files from a system with case-insensitive file names to a system with case-sensitive file names. See [Section 4.6.13, “mysql\\_fix\\_extensions — Normalize Table File Name Extensions”](#).
- `mysql_setpermission`

A utility for interactively setting permissions in the MySQL grant tables. See [Section 4.6.14, “mysql\\_setpermission — Interactively Set Permissions in Grant Tables”](#).

- `mysql_waitpid`

A utility that kills the process with a given process ID. See [Section 4.6.15, “mysql\\_waitpid — Kill Process and Wait for Its Termination”](#).

- `mysql_zap`

A utility that kills processes that match a pattern. See [Section 4.6.16, “mysql\\_zap — Kill Processes That Match a Pattern”](#).

MySQL program-development utilities:

- `msql2mysql`

A shell script that converts `mSQL` programs to MySQL. It doesn't handle every case, but it gives a good start when converting. See [Section 4.7.1, “msql2mysql — Convert mSQL Programs for Use with MySQL”](#).

- `mysql_config`

A shell script that produces the option values needed when compiling MySQL programs. See [Section 4.7.2, “mysql\\_config — Get Compile Options for Compiling Clients”](#).

- `my_print_defaults`

A utility that shows which options are present in option groups of option files. See [Section 4.7.3, “my\\_print\\_defaults — Display Options from Option Files”](#).

- `resolve_stack_dump`

A utility program that resolves a numeric stack trace dump to symbols. See [Section 4.7.4, “resolve\\_stack\\_dump — Resolve Numeric Stack Trace Dump to Symbols”](#).

Miscellaneous utilities:

- `perror`

A utility that displays the meaning of system or MySQL error codes. See [Section 4.8.1, “perror — Explain Error Codes”](#).

- `replace`

A utility program that performs string replacement in the input text. See [Section 4.8.2, “replace — A String-Replacement Utility”](#).

- `resolveip`

A utility program that resolves a host name to an IP address or vice versa. See [Section 4.8.3, “resolveip — Resolve Host name to IP Address or Vice Versa”](#).

MySQL AB also provides several GUI tools for administering and otherwise working with MySQL Server:

- **MySQL Administrator:** This tool is used for administering MySQL servers, databases, tables, and user accounts.
- **MySQL Query Browser:** This graphical tool is provided by MySQL AB for creating, executing, and optimizing queries on MySQL databases.
- **MySQL Migration Toolkit:** This tool helps you migrate schemas and data from other relational database management systems for use with MySQL.

These GUI programs are available at <http://dev.mysql.com/downloads/>. Each has its own manual that you can access at <http://dev.mysql.com/doc/>.

MySQL client programs that communicate with the server using the MySQL client/server library use the following environment

variables.

<code>MYSQL_UNIX_PORT</code>	The default Unix socket file; used for connections to <code>localhost</code>
<code>MYSQL_TCP_PORT</code>	The default port number; used for TCP/IP connections
<code>MYSQL_PWD</code>	The default password
<code>MYSQL_DEBUG</code>	Debug trace options when debugging
<code>TMPDIR</code>	The directory where temporary tables and files are created

For a full list of environment variables used by MySQL programs, see [Section 2.14, “Environment Variables”](#).

Use of `MYSQL_PWD` is insecure. See [Section 5.5.6.2, “End-User Guidelines for Password Security”](#).

## 4.2. Using MySQL Programs

### 4.2.1. Invoking MySQL Programs

To invoke a MySQL program from the command line (that is, from your shell or command prompt), enter the program name followed by any options or other arguments needed to instruct the program what you want it to do. The following commands show some sample program invocations. “`shell>`” represents the prompt for your command interpreter; it is not part of what you type. The particular prompt you see depends on your command interpreter. Typical prompts are `$` for `sh` or `bash`, `%` for `csh` or `tcsh`, and `C:\>` for the Windows `command.com` or `cmd.exe` command interpreters.

```
shell> mysql --user=root test
shell> mysqladmin extended-status variables
shell> mysqlshow --help
shell> mysqldump -u root personnel
```

Arguments that begin with a single or double dash (“-”, “--”) specify program options. Options typically indicate the type of connection a program should make to the server or affect its operational mode. Option syntax is described in [Section 4.2.3, “Specifying Program Options”](#).

Non-option arguments (arguments with no leading dash) provide additional information to the program. For example, the `mysql` program interprets the first non-option argument as a database name, so the command `mysql --user=root test` indicates that you want to use the `test` database.

Later sections that describe individual programs indicate which options a program supports and describe the meaning of any additional non-option arguments.

Some options are common to a number of programs. The most frequently used of these are the `--host` (or `-h`), `--user` (or `-u`), and `--password` (or `-p`) options that specify connection parameters. They indicate the host where the MySQL server is running, and the user name and password of your MySQL account. All MySQL client programs understand these options; they allow you to specify which server to connect to and the account to use on that server. Other connection options are `--port` (or `-P`) to specify a TCP/IP port number and `--socket` (or `-S`) to specify a Unix socket file on Unix (or named pipe name on Windows). For more information on options that specify connection options, see [Section 4.2.2, “Connecting to the MySQL Server”](#).

You may find it necessary to invoke MySQL programs using the path name to the `bin` directory in which they are installed. This is likely to be the case if you get a “program not found” error whenever you attempt to run a MySQL program from any directory other than the `bin` directory. To make it more convenient to use MySQL, you can add the path name of the `bin` directory to your `PATH` environment variable setting. That enables you to run a program by typing only its name, not its entire path name. For example, if `mysql` is installed in `/usr/local/mysql/bin`, you can run the program by invoking it as `mysql`, and it is not necessary to invoke it as `/usr/local/mysql/bin/mysql`.

Consult the documentation for your command interpreter for instructions on setting your `PATH` variable. The syntax for setting environment variables is interpreter-specific. (Some information is given in [Section 4.2.4, “Setting Environment Variables”](#).) After modifying your `PATH` setting, open a new console window on Windows or log in again on Unix so that the setting goes into effect.

### 4.2.2. Connecting to the MySQL Server

For a client program to be able to connect to the MySQL server, it must use the proper connection parameters, such as the name of the host where the server is running and the user name and password of your MySQL account. Each connection parameter has a default value, but you can override them as necessary using program options specified either on the command line or in an option file.

The examples here use the `mysql` client program, but the principles apply to other clients such as `mysqldump`, `mysqladmin`, or `mysqlshow`.

This command invokes `mysql` without specifying any connection parameters explicitly:

```
shell> mysql
```

Because there are no parameter options, the default values apply:

- The default host name is `localhost`. On Unix, this has a special meaning, as described later.
- The default user name is `ODBC` on Windows or your Unix login name on Unix.
- No password is sent if neither `-p` nor `--password` is given.
- For `mysql`, the first non-option argument is taken as the name of the default database. If there is no such option, `mysql` does not select a default database.

To specify the host name and user name explicitly, as well as a password, supply appropriate options on the command line:

```
shell> mysql --host=localhost --user=myname --password=mypass mydb
shell> mysql -h localhost -u myname -pmypass mydb
```

For password options, the password value is optional:

- If you use a `-p` or `--password` option and specify the password value, there must be *no space* between `-p` or `--password=` and the password following it.
- If you use a `-p` or `--password` option but do not specify the password value, the client program prompts you to enter the password. The password is not displayed as you enter it. This is more secure than giving the password on the command line. Other users on your system may be able to see a password specified on the command line by executing a command such as `ps auxw`. See [Section 5.5.6.2, “End-User Guidelines for Password Security”](#).

As just mentioned, including the password value on the command line can be a security risk. To avoid this problem, specify the `--password` or `-p` option without any following password value:

```
shell> mysql --host=localhost --user=myname --password mydb
shell> mysql -h localhost -u myname -p mydb
```

When the password option has no password value, the client program prints a prompt and waits for you to enter the password. (In these examples, `mydb` is *not* interpreted as a password because it is separated from the preceding password option by a space.)

On some systems, the library routine that MySQL uses to prompt for a password automatically limits the password to eight characters. That is a problem with the system library, not with MySQL. Internally, MySQL does not have any limit for the length of the password. To work around the problem, change your MySQL password to a value that is eight or fewer characters long, or put your password in an option file.

On Unix, MySQL programs treat the host name `localhost` specially, in a way that is likely different from what you expect compared to other network-based programs. For connections to `localhost`, MySQL programs attempt to connect to the local server by using a Unix socket file. This occurs even if a `--port` or `-P` option is given to specify a port number. To ensure that the client makes a TCP/IP connection to the local server, use `--host` or `-h` to specify a host name value of `127.0.0.1`, or the IP address or name of the local server. You can also specify the connection protocol explicitly, even for `localhost`, by using the `--protocol=TCP` option. For example:

```
shell> mysql --host=127.0.0.1
shell> mysql --protocol=TCP
```

The `--protocol` option enables you to establish a particular type of connection even when the other options would normally default to some other protocol.

On Windows, you can force a MySQL client to use a named-pipe connection by specifying the `--pipe` or `--protocol=PIPE` option, or by specifying `.` (period) as the host name. If named-pipe connections are not enabled, an error occurs. Use the `--socket` option to specify the name of the pipe if you do not want to use the default pipe name.

Connections to remote servers always use TCP/IP. This command connects to the server running on `remote.example.com` using the default port number (3306):

```
shell> mysql --host=remote.example.com
```

To specify a port number explicitly, use the `--port` or `-P` option:



```
shell> mysql --host=remote.example.com --port=13306
```

You can specify a port number for connections to a local server, too. However, as indicated previously, connections to `localhost` on Unix will use a socket file by default. You will need to force a TCP/IP connection as already described or any option that specifies a port number will be ignored.

For this command, the program uses a socket file on Unix and the `--port` option is ignored:

```
shell> mysql --port=13306 --host=localhost
```

To cause the port number to be used, invoke the program in either of these ways:

```
shell> mysql --port=13306 --host=127.0.0.1
shell> mysql --port=13306 --protocol=TCP
```

The following list summarizes the options that can be used to control how client programs connect to the server:

- `--host=host_name, -h host_name`

The host where the server is running. The default value is `localhost`.

- `--password[=pass_val], -p[pass_val]`

The password of the MySQL account. As described earlier, the password value is optional, but if given, there must be *no space* between `-p` or `--password=` and the password following it. The default is to send no password.

- `--pipe, -W`

On Windows, connect to the server via a named pipe. This option applies for connections to a local server only. The server must have been started with the `--enable-named-pipe` option to enable named-pipe connections.

- `--port=port_num, -P port_num`

The port number to use for the connection, for connections made via TCP/IP. The default port number is 3306.

- `--protocol={TCP|SOCKET|PIPE|MEMORY}`

This option explicitly specifies a protocol to use for connecting to the server. It is useful when the other connection parameters normally would cause a protocol to be used other than the one you want. For example, connections on Unix to `localhost` are made via a Unix socket file by default:

```
shell> mysql --host=localhost
```

To force a TCP/IP connection to be used instead, specify a `--protocol` option:

```
shell> mysql --host=localhost --protocol=TCP
```

The following table shows the allowable `--protocol` option values and indicates the platforms on which each value may be used. The values are not case sensitive.

<code>--protocol</code> Value	Connection Protocol	Allowable Operating Systems
TCP	TCP/IP connection to local or remote server	All
SOCKET	Unix socket file connection to local server	Unix only
PIPE	Named-pipe connection to local server	Windows only
MEMORY	Shared-memory connection to local server	Windows only

- `--shared-memory-base-name=name`

On Windows, the shared-memory name to use, for connections made via shared memory to a local server. The default value is `MYSQL`. The shared-memory name is case sensitive.

The server must be started with the `--shared-memory` option to enable shared-memory connections.

- `--socket=file_name, -S file_name`

On Unix, the name of the Unix socket file to use, for connections made via a named pipe to a local server. The default Unix socket file name is `/tmp/mysql.sock`.

On Windows, the name of the named pipe to use, for connections to a local server. The default Windows pipe name is `MySQL`. The pipe name is not case sensitive.

The server must be started with the `--enable-named-pipe` option to enable named-pipe connections.

- `--ssl*`

Options that begin with `--ssl` are used for establishing a secure connection to the server via SSL, if the server is configured with SSL support. For details, see [Section 5.5.7.3, “SSL Command Options”](#).

- `--user=user_name, -u user_name`

The user name of the MySQL account you want to use. The default user name is `ODBC` on Windows or your Unix login name on Unix.

It is possible to specify different default values to be used when you make a connection so that you need not enter them on the command line each time you invoke a client program. This can be done in a couple of ways:

- You can specify connection parameters in the `[client]` section of an option file. The relevant section of the file might look like this:

```
[client]
host=host_name
user=user_name
password=your_pass
```

[Section 4.2.3.2, “Using Option Files”](#), discusses option files further.

- You can specify some connection parameters using environment variables. The host can be specified for `mysql` using `MYSQL_HOST`. The MySQL user name can be specified using `USER` (this is for Windows and NetWare only). The password can be specified using `MYSQL_PWD`, although this is insecure; see [Section 5.5.6.2, “End-User Guidelines for Password Security”](#). For a list of variables, see [Section 2.14, “Environment Variables”](#).

### 4.2.3. Specifying Program Options

There are several ways to specify options for MySQL programs:

- List the options on the command line following the program name. This is most common for options that apply to a specific invocation of the program.
- List the options in an option file that the program reads when it starts. This is common for options that you want the program to use each time it runs.
- List the options in environment variables (see [Section 4.2.4, “Setting Environment Variables”](#)). This method is useful for options that you want to apply each time the program runs. In practice, option files are used more commonly for this purpose, but [Section 5.6.2, “Running Multiple Servers on Unix”](#), discusses one situation in which environment variables can be very helpful. It describes a handy technique that uses such variables to specify the TCP/IP port number and Unix socket file for the server and for client programs.

MySQL programs determine which options are given first by examining environment variables, then by reading option files, and then by checking the command line. This means that environment variables have the lowest precedence and command-line options the highest.

Because options are processed in order, if an option is specified multiple times, the last occurrence takes precedence. The following command causes `mysql` to connect to the server running on `localhost`:

```
shell> mysql -h example.com -h localhost
```

If conflicting or related options are given, later options take precedence over earlier options. The following command runs `mysql` in “no column names” mode:

```
shell> mysql --column-names --skip-column-names
```

An option can be specified by writing it in full or as any unambiguous prefix. For example, the `--compress` option can be given to `mysqldump` as `--compr`, but not as `--comp` because the latter is ambiguous:

```
shell> mysqldump --comp
mysqldump: ambiguous option '--comp' (compatible, compress)
```

Be aware that the use of option prefixes can cause problems in the event that new options are implemented for a program. A prefix that is unambiguous now might become ambiguous in the future.

You can take advantage of the way that MySQL programs process options by specifying default values for a program's options in an option file. That enables you to avoid typing them each time you run the program, but also allows you to override the defaults if necessary by using command-line options.

### 4.2.3.1. Using Options on the Command Line

Program options specified on the command line follow these rules:

- Options are given after the command name.
- An option argument begins with one dash or two dashes, depending on whether it is a short form or long form of the option name. Many options have both short and long forms. For example, `-?` and `--help` are the short and long forms of the option that instructs a MySQL program to display its help message.
- Option names are case sensitive. `-v` and `-V` are both legal and have different meanings. (They are the corresponding short forms of the `--verbose` and `--version` options.)
- Some options take a value following the option name. For example, `-h localhost` or `--host=localhost` indicate the MySQL server host to a client program. The option value tells the program the name of the host where the MySQL server is running.
- For a long option that takes a value, separate the option name and the value by an “=” sign. For a short option that takes a value, the option value can immediately follow the option letter, or there can be a space between: `-hlocalhost` and `-h localhost` are equivalent. An exception to this rule is the option for specifying your MySQL password. This option can be given in long form as `--password=pass_val` or as `--password`. In the latter case (with no password value given), the program prompts you for the password. The password option also may be given in short form as `-ppass_val` or as `-p`. However, for the short form, if the password value is given, it must follow the option letter with *no intervening space*. The reason for this is that if a space follows the option letter, the program has no way to tell whether a following argument is supposed to be the password value or some other kind of argument. Consequently, the following two commands have two completely different meanings:

```
shell> mysql -ptest
shell> mysql -p test
```

The first command instructs `mysql` to use a password value of `test`, but specifies no default database. The second instructs `mysql` to prompt for the password value and to use `test` as the default database.

- Within option names, dash (“-”) and underscore (“\_”) may be used interchangeably. For example, `--skip-grant-tables` and `--skip_grant_tables` are equivalent. (However, the leading dashes cannot be given as underscores.)

Another option that may occasionally be useful with `mysql` is the `--execute` or `-e` option, which can be used to pass SQL statements to the server. When this option is used, `mysql` executes the statements and exits. The statements must be enclosed by quotation marks. For example, you can use the following command to obtain a list of user accounts:

```
shell> mysql -u root -p --execute="SELECT User, Host FROM user" mysql
Enter password: *****
+-----+-----+
| User | Host |
+-----+-----+
| root | gigan |
|      | gigan |
|      | localhost |
| jon  | localhost |
| root | localhost |
+-----+-----+
shell>
```

Note that the long form (`--execute`) is followed by an equals sign (=).

If you wish to use quoted values within a statement, you will either need to escape the inner quotes, or use a different type of quotes within the statement from those used to quote the statement itself. The capabilities of your command processor dictate your choices

for whether you can use single or double quotation marks and the syntax for escaping quote characters. For example, if your command processor supports quoting with single or double quotes, you can double quotes around the statement, and single quotes for any quoted values within the statement.

In the preceding example, the name of the `mysql` database was passed as a separate argument. However, the same statement could have been executed using this command, which specifies no default database:

```
mysql> mysql -u root -p --execute="SELECT User, Host FROM mysql.user"
```

Multiple SQL statements may be passed on the command line, separated by semicolons:

```
shell> mysql -u root -p -e "SELECT VERSION();SELECT NOW()"
Enter password: *****
+-----+
| VERSION() |
+-----+
| 5.1.5-alpha-log |
+-----+
+-----+
| NOW() |
+-----+
| 2006-01-05 21:19:04 |
+-----+
```

The `--execute` or `-e` option may also be used to pass commands in an analogous fashion to the `ndb_mgm` management client for MySQL Cluster. See [Safe Shutdown and Restart of MySQL Cluster](#), for an example.

#### 4.2.3.1.1. Program Option Modifiers

Some options control behavior that can be turned on or off. For example, the `mysql` client supports a `--column-names` option that determines whether or not to display a row of column names at the beginning of query results. By default, this option is enabled. However, you may want to disable it in some instances, such as when sending the output of `mysql` into another program that expects to see only data and not an initial header line.

To disable column names, you can specify the option using any of these forms:

```
--disable-column-names
--skip-column-names
--column-names=0
```

The `--disable` and `--skip` prefixes and the `=0` suffix all have the same effect: They turn the option off.

The “enabled” form of the option may be specified in any of these ways:

```
--column-names
--enable-column-names
--column-names=1
```

If an option is prefixed by `--loose`, a program does not exit with an error if it does not recognize the option, but instead issues only a warning:

```
shell> mysql --loose-no-such-option
mysql: WARNING: unknown option '--no-such-option'
```

The `--loose` prefix can be useful when you run programs from multiple installations of MySQL on the same machine and list options in an option file. An option that may not be recognized by all versions of a program can be given using the `--loose` prefix (or `loose` in an option file). Versions of the program that recognize the option process it normally, and versions that do not recognize it issue a warning and ignore it.

`mysqld` enables a limit to be placed on how large client programs can set dynamic system variables. To do this, use a `--maximum` prefix with the variable name. For example, `--maximum-query_cache_size=4M` prevents any client from making the query cache size larger than 4MB.

#### 4.2.3.2. Using Option Files

Most MySQL programs can read startup options from option files (also sometimes called configuration files). Option files provide a convenient way to specify commonly used options so that they need not be entered on the command line each time you run a program. For the MySQL server, MySQL provides a number of [preconfigured option files](#).

To determine whether a program reads option files, invoke it with the `--help` option. (For `mysqld`, use `--verbose` and `--help`.) If the program reads option files, the help message indicates which files it looks for and which option groups it recognizes.

**Note**

Option files used with MySQL Cluster programs are covered in [MySQL Cluster Configuration](#).

On Windows, MySQL programs read startup options from the following files.

File Name	Purpose
<i>WINDIR</i> \my.ini, <i>WINDIR</i> \my.cnf	Global options
C:\my.ini, C:\my.cnf	Global options
<i>INSTALLDIR</i> \my.ini, <i>INSTALLDIR</i> \my.cnf	Global options
defaults-extra-file	The file specified with <code>--defaults-extra-file=path</code> , if any

*WINDIR* represents the location of your Windows directory. This is commonly `C:\WINDOWS`. You can determine its exact location from the value of the *WINDIR* environment variable using the following command:

```
C:\> echo %WINDIR%
```

*INSTALLDIR* represents the MySQL installation directory. This is typically `C:\PROGRAMDIR\MySQL\MySQL 5.1 Server` where *PROGRAMDIR* represents the programs directory (usually [Program Files](#) on English-language versions of Windows), when MySQL 5.1 has been installed using the installation and configuration wizards. See [The Location of the my.ini File](#).

On Unix, MySQL programs read startup options from the following files.

File Name	Purpose
/etc/my.cnf	Global options
/etc/mysql/my.cnf	Global options (as of MySQL 5.1.15)
<i>SYSCONFDIR</i> /my.cnf	Global options
<i>\$MYSQL_HOME</i> /my.cnf	Server-specific options
defaults-extra-file	The file specified with <code>--defaults-extra-file=path</code> , if any
~/.my.cnf	User-specific options

*SYSCONFDIR* represents the directory specified with the `--sysconfdir` option to `configure` when MySQL was built. By default, this is the `etc` directory located under the compiled-in installation directory. This location is used as of MySQL 5.1.10. (From 5.1.10 to 5.1.22, it was read last, after `~/.my.cnf`.)

*MYSQL\_HOME* is an environment variable containing the path to the directory in which the server-specific `my.cnf` file resides.

If *MYSQL\_HOME* is not set and you start the server using the `mysqld_safe` program, `mysqld_safe` attempts to set *MYSQL\_HOME* as follows:

- Let *BASEDIR* and *DATADIR* represent the path names of the MySQL base directory and data directory, respectively.
- If there is a `my.cnf` file in *DATADIR* but not in *BASEDIR*, `mysqld_safe` sets *MYSQL\_HOME* to *DATADIR*.
- Otherwise, if *MYSQL\_HOME* is not set and there is no `my.cnf` file in *DATADIR*, `mysqld_safe` sets *MYSQL\_HOME* to *BASEDIR*.

In MySQL 5.1, use of *DATADIR* as the location for `my.cnf` is deprecated.

Typically, *DATADIR* is `/usr/local/mysql/data` for a binary installation or `/usr/local/var` for a source installation. Note that this is the data directory location that was specified at configuration time, not the one specified with the `--datadir` option when `mysqld` starts. Use of `--datadir` at runtime has no effect on where the server looks for option files, because it looks for them before processing any options.

MySQL looks for option files in the order just described and reads any that exist. If an option file that you want to use does not exist, create it with a plain text editor.

If multiple instances of a given option are found, the last instance takes precedence. There is one exception: For `mysqld`, the *first* instance of the `--user` option is used as a security precaution, to prevent a user specified in an option file from being overridden

on the command line.

### Note

On Unix platforms, MySQL ignores configuration files that are world-writable. This is intentional as a security measure.

Any long option that may be given on the command line when running a MySQL program can be given in an option file as well. To get the list of available options for a program, run it with the `--help` option.

The syntax for specifying options in an option file is similar to command-line syntax, except that you omit the leading two dashes and you specify only one option per line. For example, `--quick` and `--host=localhost` on the command line should be specified as `quick` and `host=localhost` on separate lines in an option file. To specify an option of the form `--loose-opt_name` in an option file, write it as `loose-opt_name`.

Empty lines in option files are ignored. Non-empty lines can take any of the following forms:

- `#comment, ;comment`

Comment lines start with “#” or “;”. A “#” comment can start in the middle of a line as well.

- `[group]`

`group` is the name of the program or group for which you want to set options. After a group line, any option-setting lines apply to the named group until the end of the option file or another group line is given.

- `opt_name`

This is equivalent to `--opt_name` on the command line.

- `opt_name=value`

This is equivalent to `--opt_name=value` on the command line. In an option file, you can have spaces around the “=” character, something that is not true on the command line. You can enclose the value within single quotes or double quotes, which is useful if the value contains a “#” comment character or whitespace.

For options that take a numeric value, the value can be given with a suffix of `K`, `M`, or `G` (either uppercase or lowercase) to indicate a multiplier of  $1024$ ,  $1024^2$  or  $1024^3$ . For example, the following command tells `mysqladmin` to ping the server 1024 times, sleeping 10 seconds between each ping:

```
mysql> mysqladmin --count=1K --sleep=10 ping
```

Leading and trailing blanks are automatically deleted from option names and values. You may use the escape sequences “\b”, “\t”, “\n”, “\r”, “\\”, and “\s” in option values to represent the backspace, tab, newline, carriage return, backslash, and space characters.

Because the “\\” escape sequence represents a single backslash, you must write each “\” as “\\”. Alternatively, you can specify the value using “/” rather than “\” as the path name separator.

If an option group name is the same as a program name, options in the group apply specifically to that program. For example, the `[mysqld]` and `[mysql]` groups apply to the `mysqld` server and the `mysql` client program, respectively.

The `[client]` option group is read by all client programs (but *not* by `mysqld`). This allows you to specify options that apply to all clients. For example, `[client]` is the perfect group to use to specify the password that you use to connect to the server. (But make sure that the option file is readable and writable only by yourself, so that other people cannot find out your password.) Be sure not to put an option in the `[client]` group unless it is recognized by *all* client programs that you use. Programs that do not understand the option quit after displaying an error message if you try to run them.

Here is a typical global option file:

```
[client]
port=3306
socket=/tmp/mysql.sock

[mysqld]
port=3306
socket=/tmp/mysql.sock
key_buffer_size=16M
max_allowed_packet=8M

[mysqldump]
quick
```

The preceding option file uses `var_name=value` syntax for the lines that set the `key_buffer_size` and `max_allowed_packet` variables.

Here is a typical user option file:

```
[client]
# The following password will be sent to all standard MySQL clients
password="my_password"

[mysql]
no-auto-rehash
connect_timeout=2

[mysqlhotcopy]
interactive-timeout
```

If you want to create option groups that should be read by `mysqld` servers from a specific MySQL release series only, you can do this by using groups with names of `[mysqld-5.0]`, `[mysqld-5.1]`, and so forth. The following group indicates that the `--new` option should be used only by MySQL servers with 5.1.x version numbers:

```
[mysqld-5.1]
new
```

It is possible to use `!include` directives in option files to include other option files and `!includedir` to search specific directories for option files. For example, to include the `/home/mydir/myopt.cnf` file, use the following directive:

```
!include /home/mydir/myopt.cnf
```

To search the `/home/mydir` directory and read option files found there, use this directive:

```
!includedir /home/mydir
```

There is no guarantee about the order in which the option files in the directory will be read.

### Note

Currently, any files to be found and included using the `!includedir` directive on Unix operating systems *must* have file names ending in `.cnf`. On Windows, this directive checks for files with the `.ini` or `.cnf` extension.

Write the contents of an included option file like any other option file. That is, it should contain groups of options, each preceded by a `[group]` line that indicates the program to which the options apply.

While an included file is being processed, only those options in groups that the current program is looking for are used. Other groups are ignored. Suppose that a `my.cnf` file contains this line:

```
!include /home/mydir/myopt.cnf
```

And suppose that `/home/mydir/myopt.cnf` looks like this:

```
[mysqladmin]
force

[mysqld]
key_buffer_size=16M
```

If `my.cnf` is processed by `mysqld`, only the `[mysqld]` group in `/home/mydir/myopt.cnf` is used. If the file is processed by `mysqladmin`, only the `[mysqladmin]` group is used. If the file is processed by any other program, no options in `/home/mydir/myopt.cnf` are used.

The `!includedir` directive is processed similarly except that all option files in the named directory are read.

#### 4.2.3.2.1. Command-Line Options that Affect Option-File Handling

Most MySQL programs that support option files handle the following options. They affect option-file handling, so they must be given on the command line and not in an option file. To work properly, each of these options must immediately follow the command name, with the exception that `--print-defaults` may be used immediately after `--defaults-file` or `--defaults-extra-file`. Also, when specifying file names, you should avoid the use of the “~” shell metacharacter because it might not be interpreted as you expect.

- `--defaults-extra-file=file_name`



Read this option file after the global option file but (on Unix) before the user option file. *file\_name* is the full path name to the file. If the file does not exist or is otherwise inaccessible, the program will exit with an error.

- `--defaults-file=file_name`

Use only the given option file. *file\_name* is the full path name to the file. If the file does not exist or is otherwise inaccessible, the program will exit with an error.

- `--defaults-group-suffix=str`

If this option is given, the program reads not only its usual option groups, but also groups with the usual names and a suffix of *str*. For example, the `mysql` client normally reads the `[client]` and `[mysql]` groups. If the `--defaults-group-suffix=_other` option is given, `mysql` also reads the `[client_other]` and `[mysql_other]` groups.

- `--no-defaults`

Do not read any option files. If a program does not start because it is reading unknown options from an option file, `--no-defaults` can be used to prevent the program from reading them.

- `--print-defaults`

Print the program name and all options that it gets from option files.

#### 4.2.3.2.2. Preconfigured Option Files

MySQL provides a number of preconfigured option files that can be used as a basis for tuning the MySQL server. Look for files such as `my-small.cnf`, `my-medium.cnf`, `my-large.cnf`, and `my-huge.cnf`, which are sample option files for small, medium, large, and very large systems. On Windows, the extension is `.ini` rather than `.cnf` extension.

#### Note

On Windows, the `.cnf` or `.ini` option file extension might not be displayed.

For a binary distribution, look for the files in or under your installation directory. If you have a source distribution, look in the `support-files` directory. You can rename a copy of a sample file and place it in the appropriate location for use as a base configuration file. Regarding names and appropriate location, see the general information provided in [Section 4.2.3.2, “Using Option Files”](#).

#### 4.2.3.3. Using Options to Set Program Variables

Many MySQL programs have internal variables that can be set at runtime using the `SET` statement. See [Section 12.5.4, “SET Syntax”](#), and [Section 5.1.5, “Using System Variables”](#).

Most of these program variables also can be set at server startup by using the same syntax that applies to specifying program options. For example, `mysql` has a `max_allowed_packet` variable that controls the maximum size of its communication buffer. To set the `max_allowed_packet` variable for `mysql` to a value of 16MB, use either of the following commands:

```
shell> mysql --max_allowed_packet=16777216
shell> mysql --max_allowed_packet=16M
```

The first command specifies the value in bytes. The second specifies the value in megabytes. For variables that take a numeric value, the value can be given with a suffix of `K`, `M`, or `G` (either uppercase or lowercase) to indicate a multiplier of  $1024$ ,  $1024^2$  or  $1024^3$ . (For example, when used to set `max_allowed_packet`, the suffixes indicate units of kilobytes, megabytes, or gigabytes.)

In an option file, variable settings are given without the leading dashes:

```
[mysql]
max_allowed_packet=16777216
```

Or:

```
[mysql]
max_allowed_packet=16M
```

If you like, underscores in a variable name can be specified as dashes. The following option groups are equivalent. Both set the size of the server's key buffer to 512MB:

```
[mysqld]
key_buffer_size=512M

[mysqld]
key-buffer-size=512M
```

A variable can be specified by writing it in full or as any unambiguous prefix. For example, the `max_allowed_packet` variable can be set for `mysql` as `--max_a`, but not as `--max` because the latter is ambiguous:

```
shell> mysql --max=1000000
mysql: ambiguous option '--max=1000000' (max_allowed_packet, max_join_size)
```

Be aware that the use of variable prefixes can cause problems in the event that new variables are implemented for a program. A prefix that is unambiguous now might become ambiguous in the future.

Suffixes for specifying a value multiplier can be used when setting a variable at server startup, but not to set the value with `SET` at runtime. On the other hand, with `SET` you can assign a variable's value using an expression, which is not true when you set a variable at server startup. For example, the first of the following lines is legal at server startup, but the second is not:

```
shell> mysql --max_allowed_packet=16M
shell> mysql --max_allowed_packet=16*1024*1024
```

Conversely, the second of the following lines is legal at runtime, but the first is not:

```
mysql> SET GLOBAL max_allowed_packet=16M;
mysql> SET GLOBAL max_allowed_packet=16*1024*1024;
```

### Note

Before MySQL 4.0.2, the only syntax for setting program variables was `--set-variable=option=value` (or `set-variable=option=value` in option files). Underscores cannot be given as dashes, and the variable name must be specified in full. This syntax still is recognized, but is now deprecated.

#### 4.2.3.4. Option Defaults, Options Expecting Values, and the = Sign

By convention, long forms of options that assign a value are written with an equals (=) sign, like this:

```
shell> mysql --host=tonfisk --user=jon
```

For options that require a value (that is, not having a default value), the equals sign is not required, and so the following is also valid:

```
shell> mysql --host tonfisk --user jon
```

In both cases, the `mysql` client attempts to connect to a MySQL server running on the host named “tonfisk” using an account with the user name “jon”.

Due to this behavior, problems can occasionally arise when no value is provided for an option that expects one. Consider the following example, where a user connects to a MySQL server running on host `tonfisk` as user `jon`:

```
shell> mysql --host 85.224.35.45 --user jon
Welcome to the MySQL monitor.  Commands end with ; or \g.
Your MySQL connection id is 3
Server version: 5.1.36 Source distribution

Type 'help;' or '\h' for help. Type '\c' to clear the buffer.

mysql> SELECT CURRENT_USER();
+-----+
| CURRENT_USER() |
+-----+
| jon@%          |
+-----+
1 row in set (0.00 sec)
```

Omitting the required value for one of these option yields an error, such as the one shown here:

```
shell> mysql --host 85.224.35.45 --user
MYSQL: OPTION '--USER' REQUIRES AN ARGUMENT
```

In this case, `mysql` was unable to find a value following the `--user` option because nothing came after it on the command line. However, if you omit the value for an option that is *not* the last option to be used, you obtain a different error that you may not be expecting:

```
shell> mysql --host --user jon
ERROR 2005 (HY000): UNKNOWN MySQL SERVER HOST '--USER' (1)
```

Because `mysql` assumes that any string following `--host` on the command line is a host name, `--host --user` is interpreted as `--host=--user`, and the client attempts to connect to a MySQL server running on a host named “--user”.

Options having default values always require an equals sign when assigning a value; failing to do so causes an error. For example, the MySQL server `--log-error` option has the default value `host_name.err`, where `host_name` is the name of the host on which MySQL is running. Assume that you are running MySQL on a computer whose host name is “tonfisk”, and consider the following invocation of `mysqld_safe`:

```
shell> mysqld_safe &
[1] 11699
shell> 080112 12:53:40 mysqld_safe Logging to '/usr/local/mysql/var/tonfisk.err'.
080112 12:53:40 mysqld_safe Starting mysqld daemon with databases from /usr/local/mysql/var
shell>
```

After shutting down the server, restart it as follows:

```
shell> mysqld_safe --log-error &
[1] 11699
shell> 080112 12:53:40 mysqld_safe Logging to '/usr/local/mysql/var/tonfisk.err'.
080112 12:53:40 mysqld_safe Starting mysqld daemon with databases from /usr/local/mysql/var
shell>
```

The result is the same, since `--log-error` is not followed by anything else on the command line, and it supplies its own default value. (The `&` character tells the operating system to run MySQL in the background; it is ignored by MySQL itself.) Now suppose that you wish to log errors to a file named `my-errors.err`. You might try starting the server with `--log-error my-errors`, but this does not have the intended effect, as shown here:

```
shell> mysqld_safe --log-error my-errors &
[1] 31357
shell> 080111 22:53:31 mysqld_safe Logging to '/usr/local/mysql/var/tonfisk.err'.
080111 22:53:32 mysqld_safe Starting mysqld daemon with databases from /usr/local/mysql/var
080111 22:53:34 mysqld_safe mysqld from pid file /usr/local/mysql/var/tonfisk.pid ended

[1]+  Done                  ./mysqld_safe --log-error my-errors
```

The server attempted to start using `/usr/local/mysql/var/tonfisk.err` as the error log, but then shut down. Examining the last few lines of this file shows the reason:

```
shell> tail /usr/local/mysql/var/tonfisk.err
080111 22:53:32 InnoDB: Started; log sequence number 0 46409
/usr/local/mysql/libexec/mysqld: TOO MANY ARGUMENTS (FIRST EXTRA IS 'MY-ERRORS').
USE --VERBOSE --HELP TO GET A LIST OF AVAILABLE OPTIONS
080111 22:53:32 [ERROR] ABORTING

080111 22:53:32 InnoDB: Starting shutdown...
080111 22:53:34 InnoDB: Shutdown completed; log sequence number 0 46409
080111 22:53:34 [Note] /usr/local/mysql/libexec/mysqld: Shutdown complete

080111 22:53:34 mysqld_safe mysqld from pid file /usr/local/mysql/var/tonfisk.pid ended
```

Because the `--log-error` option supplies a default value, you must use an equals sign to assign a different value to it, as shown here:

```
shell> mysqld_safe --log-error=my-errors &
[1] 31437
shell> 080111 22:54:15 mysqld_safe Logging to '/usr/local/mysql/var/my-errors.err'.
080111 22:54:15 mysqld_safe Starting mysqld daemon with databases from /usr/local/mysql/var

shell>
```

Now the server has been started successfully, and is logging errors to the file `/usr/local/mysql/var/my-errors.err`.

Similar issues can arise when specifying option values in option files. For example, consider a `my.cnf` file that contains the following:

```
[mysql]
host
user
```

When the `mysql` client reads this file, these entries are parsed as `--host --user` or `--host=--user`, with the result shown here:

```
shell> mysql
ERROR 2005 (HY000): UNKNOWN MySQL SERVER HOST '--USER' (1)
```

However, in option files, an equals sign is not assumed. Suppose the `my.cnf` file is as shown here:

```
[mysql]
user jon
```

Trying to start `mysql` in this case causes a different error:

```
shell> mysql
MYSQL: UNKNOWN OPTION '--USER JON'
```

A similar error would occur if you were to write `host tonfisk` in the option file rather than `host=tonfisk`. Instead, you must use the equals sign:

```
[mysql]
user=jon
```

```
shell> mysql
Welcome to the MySQL monitor.  Commands end with ; or \g.
Your MySQL connection id is 5
Server version: 5.1.36 Source distribution

Type 'help;' or '\h' for help. Type '\c' to clear the buffer.

mysql> SELECT USER();
+-----+
| USER() |
+-----+
| jon@localhost |
+-----+
1 row in set (0.00 sec)
```

This is not the same behavior as with the command line, where the equals sign is not required:

```
shell> mysql --user jon --host tonfisk
Welcome to the MySQL monitor.  Commands end with ; or \g.
Your MySQL connection id is 6
Server version: 5.1.36 Source distribution

Type 'help;' or '\h' for help. Type '\c' to clear the buffer.

mysql> SELECT USER();
+-----+
| USER() |
+-----+
| jon@tonfisk |
+-----+
1 row in set (0.00 sec)
```

## 4.2.4. Setting Environment Variables

Environment variables can be set at the command prompt to affect the current invocation of your command processor, or set permanently to affect future invocations. To set a variable permanently, you can set it in a startup file or by using the interface provided by your system for this purpose. Consult the documentation for your command interpreter for specific details. [Section 2.14, “Environment Variables”](#), lists all environment variables that affect MySQL program operation.

To specify a value for an environment variable, use the syntax appropriate for your command processor. For example, on Windows or NetWare, you can set the `USER` variable to specify your MySQL account name. To do so, use this syntax:

```
SET USER=your_name
```

The syntax on Unix depends on your shell. Suppose that you want to specify the TCP/IP port number using the `MYSQL_TCP_PORT` variable. Typical syntax (such as for `sh`, `bash`, `zsh`, and so on) is as follows:

```
MYSQL_TCP_PORT=3306
export MYSQL_TCP_PORT
```

The first command sets the variable, and the `export` command exports the variable to the shell environment so that its value becomes accessible to MySQL and other processes.

For `csh` and `tcsh`, use `setenv` to make the shell variable available to the environment:

```
setenv MYSQL_TCP_PORT 3306
```

The commands to set environment variables can be executed at your command prompt to take effect immediately, but the settings persist only until you log out. To have the settings take effect each time you log in, use the interface provided by your system or place the appropriate command or commands in a startup file that your command interpreter reads each time it starts.

On Windows, you can set environment variables using the System Control Panel (under Advanced).

On Unix, typical shell startup files are `.bashrc` or `.bash_profile` for `bash`, or `.tcshrc` for `tcsh`.

Suppose that your MySQL programs are installed in `/usr/local/mysql/bin` and that you want to make it easy to invoke these programs. To do this, set the value of the `PATH` environment variable to include that directory. For example, if your shell is `bash`, add the following line to your `.bashrc` file:

```
PATH=${PATH}:/usr/local/mysql/bin
```

`bash` uses different startup files for login and non-login shells, so you might want to add the setting to `.bashrc` for login shells and to `.bash_profile` for non-login shells to make sure that `PATH` is set regardless.

If your shell is `tcsh`, add the following line to your `.tcshrc` file:

```
setenv PATH ${PATH}:/usr/local/mysql/bin
```

If the appropriate startup file does not exist in your home directory, create it with a text editor.

After modifying your `PATH` setting, open a new console window on Windows or log in again on Unix so that the setting goes into effect.

## 4.3. MySQL Server and Server-Startup Programs

This section describes `mysqld`, the MySQL server, and several programs that are used to start the server.

### 4.3.1. `mysqld` — The MySQL Server

`mysqld`, also known as MySQL Server, is the main program that does most of the work in a MySQL installation. MySQL Server manages access to the MySQL data directory that contains databases and tables. The data directory is also the default location for other information such as log files and status files.

When MySQL server starts, it listens for network connections from client programs and manages access to databases on behalf of those clients.

The `mysqld` program has many options that can be specified at startup. For a complete list of options, run this command:

```
shell> mysqld --verbose --help
```

MySQL Server also has a set of system variables that affect its operation as it runs. System variables can be set at server startup, and many of them can be changed at runtime to effect dynamic server reconfiguration. MySQL Server also has a set of status variables that provide information about its operation. You can monitor these status variables to access runtime performance characteristics.

For a full description of MySQL Server command options, system variables, and status variables, see [Section 5.1, “The MySQL Server”](#). For information about installing MySQL and setting up the initial configuration, see [Chapter 2, \*Installing and Upgrading MySQL\*](#).

### 4.3.2. `mysqld_safe` — MySQL Server Startup Script

`mysqld_safe` is the recommended way to start a `mysqld` server on Unix and NetWare. `mysqld_safe` adds some safety features such as restarting the server when an error occurs and logging runtime information to an error log file. Descriptions of error logging and NetWare-specific behaviors are given later in this section.

#### Note

In MySQL 5.1.20 (only), the default error logging behavior with `mysqld_safe` is to write errors to `syslog` on systems that support the `logger` program. This differs from the default behavior of writing an error log file for other versions.

**In 5.1.20, logging to `syslog` may fail to operate correctly in some cases, so we recommend that you use `-skip-syslog` to use the default log file or `--log-error=file_name` to specify a log file name explicitly.**

`mysqld_safe` tries to start an executable named `mysqld`. To override the default behavior and specify explicitly the name of the server you want to run, specify a `--mysqld` or `--mysqld-version` option to `mysqld_safe`. You can also use `--ledir` to indicate the directory where `mysqld_safe` should look for the server.

Many of the options to `mysqld_safe` are the same as the options to `mysqld`. See [Section 5.1.2, “Server Command Options”](#).

Options unknown to `mysqld_safe` are passed to `mysqld` if they are specified on the command line, but ignored if they are specified in the `[mysqld_safe]` group of an option file. See [Section 4.2.3.2, “Using Option Files”](#).

`mysqld_safe` reads all options from the `[mysqld]`, `[server]`, and `[mysqld_safe]` sections in option files. For example, if you specify a `[mysqld]` section like this, `mysqld_safe` will find and use the `--log-error` option:

```
[mysqld]
log-error=error.log
```

For backward compatibility, `mysqld_safe` also reads `[safe_mysqld]` sections, although you should rename such sections to `[mysqld_safe]` in MySQL 5.1 installations.

**Table 4.1. `mysqld_safe` Option Reference**

Format	Config File	Description	Introduction	Deprecated	Removed
<code>--autoclose</code>	<code>autoclose</code>	On NetWare, <code>mysqld_safe</code> provides a screen presence			
<code>--basedir=path</code>	<code>basedir</code>	The path to the MySQL installation directory			
<code>- - core-file-size=size</code>	<code>core-file-size</code>	The size of the core file that <code>mysqld</code> should be able to create			
<code>--datadir=path</code>	<code>datadir</code>	The path to the data directory			
<code>- -de- faults-ex- tra-file=path</code>	<code>defaults-extra-file</code>	The name of an option file to be read in addition to the usual option files			
<code>- -de- faults- file=file_name</code>	<code>defaults-file</code>	The name of an option file to be read instead of the usual option files			
<code>--help</code>		Display a help message and exit			
<code>--ledir=path</code>	<code>ledir</code>	Use this option to indicate the path name to the directory where the server is located			
<code>- - log-er- ror=file_name</code>	<code>log-error</code>	Write the error log to the given file			
<code>- - mysqld=prog_name</code>	<code>mysqld</code>	The name of the server program (in the <code>ledir</code> directory) that you want to start			
<code>- - mysqld-ver- sion=suffix</code>	<code>mysqld-version</code>	This option is similar to the <code>--mysqld</code> option, but you specify only the suffix for the server program name			
<code>--nice=priority</code>	<code>nice</code>	Use the <code>nice</code> program to set the server's scheduling priority to the given value			
<code>--no-defaults</code>	<code>no-defaults</code>	Do not read any option files			
<code>- - open- files-limit=count</code>	<code>open-files-limit</code>	The number of files that <code>mysqld</code> should be able to open			
<code>--pid-file</code>	<code>pid-file</code>	The path name of the process ID file			
<code>--port=number</code>	<code>port</code>	The port number that the server should use when listening for TCP/IP connections			
<code>--skip-kill-mysqld</code>	<code>skip-kill-mysqld</code>	Do not try to kill stray <code>mysqld</code> processes			
<code>--skip-syslog</code>	<code>skip-syslog</code>	Do not write error messages to <code>syslog</code> ; use error log file	5.1.20		
<code>--socket=path</code>	<code>socket</code>	The Unix socket file that the server should use when listening for local connections			
<code>--syslog</code>	<code>syslog</code>	Write error messages to <code>syslog</code>	5.1.20		
<code>- - timezone=timezo- ne</code>	<code>timezone</code>	Set the TZ time zone environment variable to the given option value			
<code>-</code>	<code>user</code>	Run the <code>mysqld</code> server as the user having the name			

Format	Config File	Description	Introduc- tion	Deprec- ated	Removed
- user={user_name  user_id}		user_name or the numeric user ID user_id			

`mysqld_safe` supports the options in the following list. It also reads option files and supports the options for processing them described at [Section 4.2.3.2.1, “Command-Line Options that Affect Option-File Handling”](#).

- `--help`

Display a help message and exit.

- `--autoclose`

(NetWare only) On NetWare, `mysqld_safe` provides a screen presence. When you unload (shut down) the `mysqld_safe` NLM, the screen does not by default go away. Instead, it prompts for user input:

```
*<NLM has terminated; Press any key to close the screen>*
```

If you want NetWare to close the screen automatically instead, use the `--autoclose` option to `mysqld_safe`.

- `--basedir=path`

The path to the MySQL installation directory.

- `--core-file-size=size`

The size of the core file that `mysqld` should be able to create. The option value is passed to `ulimit -c`.

- `--datadir=path`

The path to the data directory.

- `--defaults-extra-file=path`

The name of an option file to be read in addition to the usual option files. This must be the first option on the command line if it is used. If the file does not exist or is otherwise inaccessible, the server will exit with an error.

- `--defaults-file=file_name`

The name of an option file to be read instead of the usual option files. This must be the first option on the command line if it is used.

- `--ledir=path`

If `mysqld_safe` cannot find the server, use this option to indicate the path name to the directory where the server is located.

- `--log-error=file_name`

Write the error log to the given file. See [Section 5.2.2, “The Error Log”](#).

- `--mysqld=prog_name`

The name of the server program (in the `ledir` directory) that you want to start. This option is needed if you use the MySQL binary distribution but have the data directory outside of the binary distribution. If `mysqld_safe` cannot find the server, use the `--ledir` option to indicate the path name to the directory where the server is located.

- `--mysqld-version=suffix`

This option is similar to the `--mysqld` option, but you specify only the suffix for the server program name. The basename is assumed to be `mysqld`. For example, if you use `--mysqld-version=debug`, `mysqld_safe` starts the `mysqld-debug` program in the `ledir` directory. If the argument to `--mysqld-version` is empty, `mysqld_safe` uses `mysqld` in the `ledir` directory.

- `--nice=priority`

Use the `nice` program to set the server's scheduling priority to the given value.



- `--no-defaults`

Do not read any option files. This must be the first option on the command line if it is used.

- `--open-files-limit=count`

The number of files that `mysqld` should be able to open. The option value is passed to `ulimit -n`. Note that you need to start `mysqld_safe` as `root` for this to work properly!

- `--pid-file=file_name`

The path name of the process ID file.

- `--port=port_num`

The port number that the server should use when listening for TCP/IP connections. The port number must be 1024 or higher unless the server is started by the `root` system user.

- `--skip-kill-mysqld`

Do not try to kill stray `mysqld` processes at startup. This option works only on Linux.

- `--socket=path`

The Unix socket file that the server should use when listening for local connections.

- `--syslog, --skip-syslog`

`--syslog` causes error messages to be sent to `syslog` on systems that support the `logger` program. `--skip-syslog` suppresses the use of `syslog`; messages are written to an error log file. These options were added in MySQL 5.1.20.

- `--syslog-tag=tag`

For logging to `syslog`, messages from `mysqld_safe` and `mysqld` are written with a tag of `mysqld_safe` and `mysqld`, respectively. To specify a suffix for the tag, use `--syslog-tag=tag`, which modifies the tags to be `mysqld_safe-tag` and `mysqld-tag`. This option was added in MySQL 5.1.21.

- `--timezone=timezone`

Set the `TZ` time zone environment variable to the given option value. Consult your operating system documentation for legal time zone specification formats.

- `--user={user_name|user_id}`

Run the `mysqld` server as the user having the name `user_name` or the numeric user ID `user_id`. (“User” in this context refers to a system login account, not a MySQL user listed in the grant tables.)

If you execute `mysqld_safe` with the `--defaults-file` or `--defaults-extra-file` option to name an option file, the option must be the first one given on the command line or the option file will not be used. For example, this command will not use the named option file:

```
mysql> mysqld_safe --port=port_num --defaults-file=file_name
```

Instead, use the following command:

```
mysql> mysqld_safe --defaults-file=file_name --port=port_num
```

The `mysqld_safe` script is written so that it normally can start a server that was installed from either a source or a binary distribution of MySQL, even though these types of distributions typically install the server in slightly different locations. (See [Section 2.1.5, “Installation Layouts”](#).) `mysqld_safe` expects one of the following conditions to be true:

- The server and databases can be found relative to the working directory (the directory from which `mysqld_safe` is invoked). For binary distributions, `mysqld_safe` looks under its working directory for `bin` and `data` directories. For source distributions, it looks for `libexec` and `var` directories. This condition should be met if you execute `mysqld_safe` from your MySQL installation directory (for example, `/usr/local/mysql` for a binary distribution).
- If the server and databases cannot be found relative to the working directory, `mysqld_safe` attempts to locate them by absolute path names. Typical locations are `/usr/local/libexec` and `/usr/local/var`. The actual locations are determined from the values configured into the distribution at the time it was built. They should be correct if MySQL is installed in the

location specified at configuration time.

Because `mysqld_safe` tries to find the server and databases relative to its own working directory, you can install a binary distribution of MySQL anywhere, as long as you run `mysqld_safe` from the MySQL installation directory:

```
shell> cd mysql_installation_directory
shell> bin/mysqld_safe &
```

If `mysqld_safe` fails, even when invoked from the MySQL installation directory, you can specify the `--ledir` and `--datadir` options to indicate the directories in which the server and databases are located on your system.

When you use `mysqld_safe` to start `mysqld`, `mysqld_safe` arranges for error (and notice) messages from itself and from `mysqld` to go to the same destination.

As of MySQL 5.1.20, there are several `mysqld_safe` options for controlling the destination of these messages:

- `--syslog`: Write error messages to `syslog` on systems that support the `logger` program.
- `--skip-syslog`: Do not write error messages to `syslog`. Messages are written to the default error log file (`host_name.err` in the data directory), or to a named file if the `--log-error` option is given.
- `--log-error=file_name`: Write error messages to the named error file.

If none of these options is given, the default is `--skip-syslog`.

#### Note

In MySQL 5.1.20 *only*, the default is `--syslog`. This differs from logging behavior for other versions of MySQL, for which the default is to write messages to the default error log file.

If `--syslog` and `--log-error` are both given, a warning is issued and `--log-error` takes precedence.

When `mysqld_safe` writes a message, notices go to the logging destination (`syslog` or the error log file) and `stdout`. Errors go to the logging destination and `stderr`.

Before MySQL 5.1.20, error logging is controlled only with the `--log-error` option. If it is given, messages go to the named error file. Otherwise, messages go to the default error file.

Normally, you should not edit the `mysqld_safe` script. Instead, configure `mysqld_safe` by using command-line options or options in the `[mysqld_safe]` section of a `my.cnf` option file. In rare cases, it might be necessary to edit `mysqld_safe` to get it to start the server properly. However, if you do this, your modified version of `mysqld_safe` might be overwritten if you upgrade MySQL in the future, so you should make a copy of your edited version that you can reinstall.

On NetWare, `mysqld_safe` is a NetWare Loadable Module (NLM) that is ported from the original Unix shell script. It starts the server as follows:

1. Runs a number of system and option checks.
2. Runs a check on `MyISAM` tables.
3. Provides a screen presence for the MySQL server.
4. Starts `mysqld`, monitors it, and restarts it if it terminates in error.
5. Sends error messages from `mysqld` to the `host_name.err` file in the data directory.
6. Sends `mysqld_safe` screen output to the `host_name.safe` file in the data directory.

### 4.3.3. `mysql.server` — MySQL Server Startup Script

MySQL distributions on Unix include a script named `mysql.server`. It can be used on systems such as Linux and Solaris that use System V-style run directories to start and stop system services. It is also used by the Mac OS X Startup Item for MySQL.

`mysql.server` can be found in the `support-files` directory under your MySQL installation directory or in a MySQL source distribution.

If you use the Linux server RPM package (`MySQL-server-VERSION.rpm`), the `mysql.server` script will be installed in the `/etc/init.d` directory with the name `mysql`. You need not install it manually. See [Section 2.4, “Installing MySQL from RPM Packages on Linux”](#), for more information on the Linux RPM packages.

Some vendors provide RPM packages that install a startup script under a different name such as `mysqld`.

If you install MySQL from a source distribution or using a binary distribution format that does not install `mysql.server` automatically, you can install it manually. Instructions are provided in [Section 2.11.2.2, “Starting and Stopping MySQL Automatically”](#).

`mysql.server` reads options from the `[mysql.server]` and `[mysqld]` sections of option files. For backward compatibility, it also reads `[mysql_server]` sections, although you should rename such sections to `[mysql.server]` when using MySQL 5.1.

`mysql.server` supports the following options:

- `--basedir=path`  
The path to the MySQL installation directory.
- `--datadir=path`  
The path to the MySQL data directory.
- `--pid-file=file_name`  
The path name of the file in which the server should write its process ID.
- `--service-startup-timeout=file_name`  
How long in seconds to wait for confirmation of server startup. If the server does not start within this time, `mysql.server` exits with an error. The default value is 900. A value of 0 means not to wait at all for startup. Negative values mean to wait forever (no timeout). This option was added in MySQL 5.1.17. Before that, a value of 900 is always used.
- `--use-mysqld_safe`  
Use `mysqld_safe` to start the server. This is the default.
- `--use-manager`  
Use Instance Manager to start the server.
- `--user=user_name`  
The login user name to use for running `mysqld`.

#### 4.3.4. `mysqld_multi` — Manage Multiple MySQL Servers

`mysqld_multi` is designed to manage several `mysqld` processes that listen for connections on different Unix socket files and TCP/IP ports. It can start or stop servers, or report their current status. The MySQL Instance Manager is an alternative means of managing multiple servers (see [Section 4.6.10, “mysqlmanager — The MySQL Instance Manager”](#)).

`mysqld_multi` searches for groups named `[mysqldN]` in `my.cnf` (or in the file named by the `--config-file` option). `N` can be any positive integer. This number is referred to in the following discussion as the option group number, or `GNR`. Group numbers distinguish option groups from one another and are used as arguments to `mysqld_multi` to specify which servers you want to start, stop, or obtain a status report for. Options listed in these groups are the same that you would use in the `[mysqld]` group used for starting `mysqld`. (See, for example, [Section 2.11.2.2, “Starting and Stopping MySQL Automatically”](#).) However, when using multiple servers, it is necessary that each one use its own value for options such as the Unix socket file and TCP/IP port number. For more information on which options must be unique per server in a multiple-server environment, see [Section 5.6, “Running Multiple MySQL Servers on the Same Machine”](#).

To invoke `mysqld_multi`, use the following syntax:

```
shell> mysqld_multi [options] {start|stop|report} [GNR[,GNR] ...]
```

`start`, `stop`, and `report` indicate which operation to perform. You can perform the designated operation for a single server or multiple servers, depending on the `GNR` list that follows the option name. If there is no list, `mysqld_multi` performs the operation for all servers in the option file.

Each *GNR* value represents an option group number or range of group numbers. The value should be the number at the end of the group name in the option file. For example, the *GNR* for a group named `[mysqld17]` is `17`. To specify a range of numbers, separate the first and last numbers by a dash. The *GNR* value `10-13` represents groups `[mysqld10]` through `[mysqld13]`. Multiple groups or group ranges can be specified on the command line, separated by commas. There must be no whitespace characters (spaces or tabs) in the *GNR* list; anything after a whitespace character is ignored.

This command starts a single server using option group `[mysqld17]`:

```
shell> mysqld_multi start 17
```

This command stops several servers, using option groups `[mysqld8]` and `[mysqld10]` through `[mysqld13]`:

```
shell> mysqld_multi stop 8,10-13
```

For an example of how you might set up an option file, use this command:

```
shell> mysqld_multi --example
```

As of MySQL 5.1.18, `mysqld_multi` searches for option files as follows:

- With `--no-defaults`, no option files are read.
- With `--defaults-file=file_name`, only the named file is read.
- Otherwise, option files in the standard list of locations are read, including any file named by the `--defaults-extra-file=file_name` option, if one is given. (If the option is given multiple times, the last value is used.)

Option files read are searched for `[mysqld_multi]` and `[mysqldN]` option groups.

Before MySQL 5.1.18, the preceding options are not recognized. Files in the standard locations are read, and any file named by the `--config-file=file_name` option, if one is given. A file named by `--config-file` is read only for `[mysqldN]` option groups, not the `[mysqld_multi]` group.

`mysqld_multi` supports the following options:

- `--help`

Display a help message and exit.

- `--config-file=file_name`

As of MySQL 5.1.18, this option is deprecated. If given, it is treated the same way as `--defaults-extra-file`, described earlier.

Before MySQL 5.1.18, this option specifies the name of an extra option file. It affects where `mysqld_multi` looks for `[mysqldN]` option groups. Without this option, all options are read from the usual `my.cnf` file. The option does not affect where `mysqld_multi` reads its own options, which are always taken from the `[mysqld_multi]` group in the usual `my.cnf` file.

- `--example`

Display a sample option file.

- `--log=file_name`

Specify the name of the log file. If the file exists, log output is appended to it.

- `--mysqladmin=prog_name`

The `mysqladmin` binary to be used to stop servers.

- `--mysqld=prog_name`

The `mysqld` binary to be used. Note that you can specify `mysqld_safe` as the value for this option also. If you use `mysqld_safe` to start the server, you can include the `mysqld` or `ledir` options in the corresponding `[mysqldN]` option group. These options indicate the name of the server that `mysqld_safe` should start and the path name of the directory where

the server is located. (See the descriptions for these options in [Section 4.3.2, “mysqld\\_safe — MySQL Server Startup Script”](#).) Example:

```
[mysqld38]
mysqld = mysqld-debug
ledir = /opt/local/mysql/libexec
```

- `--no-log`  
Print log information to `stdout` rather than to the log file. By default, output goes to the log file.
- `--password=password`  
The password of the MySQL account to use when invoking `mysqladmin`. Note that the password value is not optional for this option, unlike for other MySQL programs.
- `--silent`  
Silent mode; disable warnings.
- `--tcp-ip`  
Connect to each MySQL server via the TCP/IP port instead of the Unix socket file. (If a socket file is missing, the server might still be running, but accessible only via the TCP/IP port.) By default, connections are made using the Unix socket file. This option affects `stop` and `report` operations.
- `--user=user_name`  
The user name of the MySQL account to use when invoking `mysqladmin`.
- `--verbose`  
Be more verbose.
- `--version`  
Display version information and exit.

Some notes about `mysqld_multi`:

- **Most important:** Before using `mysqld_multi` be sure that you understand the meanings of the options that are passed to the `mysqld` servers and *why* you would want to have separate `mysqld` processes. Beware of the dangers of using multiple `mysqld` servers with the same data directory. Use separate data directories, unless you *know* what you are doing. Starting multiple servers with the same data directory does *not* give you extra performance in a threaded system. See [Section 5.6, “Running Multiple MySQL Servers on the Same Machine”](#).

### Important

Make sure that the data directory for each server is fully accessible to the Unix account that the specific `mysqld` process is started as. *Do not* use the Unix `root` account for this, unless you *know* what you are doing. See [Section 5.3.5, “How to Run MySQL as a Normal User”](#).

- Make sure that the MySQL account used for stopping the `mysqld` servers (with the `mysqladmin` program) has the same user name and password for each server. Also, make sure that the account has the `SHUTDOWN` privilege. If the servers that you want to manage have different user names or passwords for the administrative accounts, you might want to create an account on each server that has the same user name and password. For example, you might set up a common `multi_admin` account by executing the following commands for each server:

```
shell> mysql -u root -S /tmp/mysql.sock -p
Enter password:
mysql> GRANT SHUTDOWN ON *.*
-> TO 'multi_admin'@'localhost' IDENTIFIED BY 'multipass';
```

See [Section 5.4, “The MySQL Access Privilege System”](#). You have to do this for each `mysqld` server. Change the connection parameters appropriately when connecting to each one. Note that the host name part of the account name must allow you to connect as `multi_admin` from the host where you want to run `mysqld_multi`.

- The Unix socket file and the TCP/IP port number must be different for every `mysqld`. (Alternatively, if the host has multiple network addresses, you can use `--bind-address` to cause different servers to listen to different interfaces.)

- The `--pid-file` option is very important if you are using `mysqld_safe` to start `mysqld` (for example, `--mysqld=mysqld_safe`). Every `mysqld` should have its own process ID file. The advantage of using `mysqld_safe` instead of `mysqld` is that `mysqld_safe` monitors its `mysqld` process and restarts it if the process terminates due to a signal sent using `kill -9` or for other reasons, such as a segmentation fault. Please note that the `mysqld_safe` script might require that you start it from a certain place. This means that you might have to change location to a certain directory before running `mysqld_multi`. If you have problems starting, please see the `mysqld_safe` script. Check especially the lines:

```
-----
MY_PWD=`pwd`
# Check if we are starting this relative (for the binary release)
if test -d $MY_PWD/data/mysql -a \
  -f ./share/mysql/english/errmsg.sys -a \
  -x ./bin/mysqld
-----
```

The test performed by these lines should be successful, or you might encounter problems. See [Section 4.3.2, “mysqld\\_safe — MySQL Server Startup Script”](#).

- You might want to use the `--user` option for `mysqld`, but to do this you need to run the `mysqld_multi` script as the Unix `root` user. Having the option in the option file doesn't matter; you just get a warning if you are not the superuser and the `mysqld` processes are started under your own Unix account.

The following example shows how you might set up an option file for use with `mysqld_multi`. The order in which the `mysqld` programs are started or stopped depends on the order in which they appear in the option file. Group numbers need not form an unbroken sequence. The first and fifth `[mysqldN]` groups were intentionally omitted from the example to illustrate that you can have “gaps” in the option file. This gives you more flexibility.

```
# This file should probably be in your home dir (-/.my.cnf)
# or /etc/my.cnf
# Version 2.1 by Jani Tolonen

[mysqld_multi]
mysqld      = /usr/local/bin/mysqld_safe
mysqldadmin = /usr/local/bin/mysqldadmin
user        = multi_admin
password    = multipass

[mysqld2]
socket      = /tmp/mysql.sock2
port        = 3307
pid-file    = /usr/local/mysql/var2/hostname.pid2
datadir     = /usr/local/mysql/var2
language    = /usr/local/share/mysql/english
user        = john

[mysqld3]
socket      = /tmp/mysql.sock3
port        = 3308
pid-file    = /usr/local/mysql/var3/hostname.pid3
datadir     = /usr/local/mysql/var3
language    = /usr/local/share/mysql/swedish
user        = monty

[mysqld4]
socket      = /tmp/mysql.sock4
port        = 3309
pid-file    = /usr/local/mysql/var4/hostname.pid4
datadir     = /usr/local/mysql/var4
language    = /usr/local/share/mysql/estonia
user        = tonu

[mysqld6]
socket      = /tmp/mysql.sock6
port        = 3311
pid-file    = /usr/local/mysql/var6/hostname.pid6
datadir     = /usr/local/mysql/var6
language    = /usr/local/share/mysql/japanese
user        = jani
```

See [Section 4.2.3.2, “Using Option Files”](#).

## 4.4. MySQL Installation-Related Programs

The programs in this section are used when installing or upgrading MySQL.

### 4.4.1. `comp_err` — Compile MySQL Error Message File

`comp_err` creates the `errmsg.sys` file that is used by `mysqld` to determine the error messages to display for different error codes. `comp_err` normally is run automatically when MySQL is built. It compiles the `errmsg.sys` file from the plaintext file located at `sql/share/errmsg.txt` in MySQL source distributions.

`comp_err` also generates `mysqld_error.h`, `mysqld_ename.h`, and `sql_state.h` header files.

For more information about how error messages are defined, see the MySQL Internals Manual.

Invoke `comp_err` like this:

```
shell> comp_err [options]
```

`comp_err` supports the options described in the following list.

- `--help, -?`  
Display a help message and exit.
- `--charset=path, -C path`  
The character set directory. The default is `../sql/share/charsets`.
- `--debug=debug_options, -# debug_options`  
Write a debugging log. A typical `debug_options` string is `'d:t:O,file_name'`. The default is `'d:t:O,/tmp/comp_err.trace'`.
- `--debug-info, -T`  
Print some debugging information when the program exits.
- `--header_file=file_name, -H file_name`  
The name of the error header file. The default is `mysqld_error.h`.
- `--in_file=file_name, -F file_name`  
The name of the input file. The default is `../sql/share/errmsg.txt`.
- `--name_file=file_name, -N file_name`  
The name of the error name file. The default is `mysqld_ename.h`.
- `--out_dir=path, -D path`  
The name of the output base directory. The default is `../sql/share/`.
- `--out_file=file_name, -O file_name`  
The name of the output file. The default is `errmsg.sys`.
- `--statefile=file_name, -S file_name`  
The name for the SQLSTATE header file. The default is `sql_state.h`.
- `--version, -V`  
Display version information and exit.

#### 4.4.2. `make_win_bin_dist` — Package MySQL Distribution as ZIP Archive

This script is used on Windows after building a MySQL distribution from source to create executable programs. It packages the binaries and support files into a ZIP archive that can be unpacked at the location where you want to install MySQL.

`make_win_bin_dist` is a shell script, so you must have Cygwin installed to use it.

This program's use is subject to change. Currently, you invoke it as follows from the root directory of your source distribution:

```
shell> make_win_bin_dist [options] package_basename [copy_def ...]
```

The `package_basename` argument provides the basename for the resulting ZIP archive. This name will be the name of the directory that results from unpacking the archive.



Because you might want to include files of directories from other builds, you can instruct this script do copy them in for you, via `copy_def` arguments, which of which is of the form `relative_dest_name=source_name`.

Example:

```
bin/mysqld-max.exe=../my-max-build/sql/release/mysqld.exe
```

If you specify a directory, the entire directory will be copied.

`make_win_bin_dist` supports the following options:

- `--debug`  
Pack the debug binaries and produce an error if they were not built.
- `--embedded`  
Pack the embedded server and produce an error if it was not built. The default is to pack it if it was built.
- `--exe-suffix=suffix`  
Add a suffix to the basename of the `mysql` binary. For example, a suffix of `-abc` produces a binary named `mysqld-abc.exe`.
- `--no-debug`  
Don't pack the debug binaries even if they were built.
- `--no-embedded`  
Don't pack the embedded server even if it was built.
- `--only-debug`  
Use this option when the target for this build was `Debug`, and you just want to replace the normal binaries with debug versions (that is, do not use separate `debug` directories).

### 4.4.3. `mysqlbug` — Generate Bug Report

This program enables you to generate a bug report and send it to MySQL AB. It is a shell script and runs on Unix.

The normal way to report bugs is to visit <http://bugs.mysql.com/>, which is the address for our bugs database. This database is public and can be browsed and searched by anyone. If you log in to the system, you can enter new reports. If you have no Web access, you can generate a bug report by using the `mysqlbug` script.

`mysqlbug` helps you generate a report by determining much of the following information automatically, but if something important is missing, please include it with your message. `mysqlbug` can be found in the `scripts` directory (source distribution) and in the `bin` directory under your MySQL installation directory (binary distribution).

Invoke `mysqlbug` without arguments:

```
shell> mysqlbug
```

The script will place you in an editor with a copy of the report to be sent. Edit the lines near the beginning that indicate the nature of the problem. Then write the file to save your changes, quit the editor, and `mysqlbug` will send the report by email.

### 4.4.4. `mysql_fix_privilege_tables` — Upgrade MySQL System Tables

Some releases of MySQL introduce changes to the structure of the system tables in the `mysql` database to add new privileges or support new features. When you update to a new version of MySQL, you should update your system tables as well to make sure that their structure is up to date. Otherwise, there might be capabilities that you cannot take advantage of.

`mysql_fix_privilege_tables` is an older script that previously was used to upgrade the system tables in the `mysql` database after a MySQL upgrade.

#### ■ Note

As of MySQL 5.1.7, `mysql_fix_privilege_tables` is superseded by `mysql_upgrade`, which should be used instead. See [Section 4.4.8, “mysql\\_upgrade — Check Tables for MySQL Upgrade”](#).

Before running `mysql_fix_privilege_tables`, make a backup of your `mysql` database.

On Unix or Unix-like systems, update the system tables by running the `mysql_fix_privilege_tables` script:

```
shell> mysql_fix_privilege_tables
```

You must run this script while the server is running. It attempts to connect to the server running on the local host as `root`. If your `root` account requires a password, indicate the password on the command line like this:

```
shell> mysql_fix_privilege_tables --password=root_password
```

The `mysql_fix_privilege_tables` script performs any actions necessary to convert your system tables to the current format. You might see some `Duplicate column name` warnings as it runs; you can ignore them.

After running the script, stop the server and restart it so that any changes made to the system tables take effect.

On Windows systems, MySQL distributions include a `mysql_fix_privilege_tables.sql` SQL script that you can run using the `mysql` client. For example, if your MySQL installation is located at `C:\Program Files\MySQL\MySQL Server 5.1`, the commands look like this:

```
C:\> cd "C:\Program Files\MySQL\MySQL Server 5.1"
C:\> bin\mysql -u root -p mysql
mysql> SOURCE share/mysql_fix_privilege_tables.sql
```

### Note

Prior to version 5.1.17, this script is found in the `scripts` directory.

The `mysql` command will prompt you for the `root` password; enter it when prompted.

If your installation is located in some other directory, adjust the path names appropriately.

As with the Unix procedure, you might see some `Duplicate column name` warnings as `mysql` processes the statements in the `mysql_fix_privilege_tables.sql` script; you can ignore them.

After running the script, stop the server and restart it.

## 4.4.5. `mysql_install_db` — Initialize MySQL Data Directory

`mysql_install_db` initializes the MySQL data directory and creates the system tables that it contains, if they do not exist.

To invoke `mysql_install_db`, use the following syntax:

```
shell> mysql_install_db [options]
```

Because the MySQL server, `mysqld`, needs to access the data directory when it runs later, you should either run `mysql_install_db` from the same account that will be used for running `mysqld` or run it as `root` and use the `--user` option to indicate the user name that `mysqld` will run as. It might be necessary to specify other options such as `--basedir` or `--datadir` if `mysql_install_db` does not use the correct locations for the installation directory or data directory. For example:

```
shell> bin/mysql_install_db --user=mysql \
    --basedir=/opt/mysql/mysql \
    --datadir=/opt/mysql/mysql/data
```

`mysql_install_db` needs to invoke `mysqld` with the `--bootstrap` and `--skip-grant-tables` options (see [Section 2.10.2, “Typical configure Options”](#)). If MySQL was configured with the `--disable-grant-options` option, `--bootstrap` and `--skip-grant-tables` will be disabled. To handle this, set the `MYSQLD_BOOTSTRAP` environment variable to the full path name of a server that has all options enabled. `mysql_install_db` will use that server.

`mysql_install_db` supports the options in the following list. It also reads option files and supports the options for processing them described at [Section 4.2.3.2.1, “Command-Line Options that Affect Option-File Handling”](#).

- `--basedir=path`

The path to the MySQL installation directory.

- `--force`

Causes `mysql_install_db` to run even if DNS does not work. In that case, grant table entries that normally use host names will use IP addresses.

- `--datadir=path, --ldata=path`

The path to the MySQL data directory.

- `--rpm`

For internal use. This option is used by RPM files during the MySQL installation process.

- `--skip-name-resolve`

Use IP addresses rather than host names when creating grant table entries. This option can be useful if your DNS does not work.

- `--srcdir=path`

For internal use. The directory under which `mysql_install_db` looks for support files such as the error message file and the file for populating the help tables. This option was added in MySQL 5.1.14.

- `--user=user_name`

The login user name to use for running `mysqld`. Files and directories created by `mysqld` will be owned by this user. You must be `root` to use this option. By default, `mysqld` runs using your current login name and files and directories that it creates will be owned by you.

- `--verbose`

Verbose mode. Print more information about what the program does.

- `--windows`

For internal use. This option is used for creating Windows distributions.

#### 4.4.6. `mysql_secure_installation` — Improve MySQL Installation Security

This program enables you to improve the security of your MySQL installation in the following ways:

- You can set a password for `root` accounts.
- You can remove `root` accounts that are accessible from outside the local host.
- You can remove anonymous-user accounts.
- You can remove the `test` database, which by default can be accessed by anonymous users.

Invoke `mysql_secure_installation` without arguments:

```
shell> mysql_secure_installation
```

The script will prompt you to determine which actions to perform.

#### 4.4.7. `mysql_tzinfo_to_sql` — Load the Time Zone Tables

The `mysql_tzinfo_to_sql` program loads the time zone tables in the `mysql` database. It is used on systems that have a `zoneinfo` database (the set of files describing time zones). Examples of such systems are Linux, FreeBSD, Sun Solaris, and Mac OS X. One likely location for these files is the `/usr/share/zoneinfo` directory (`/usr/share/lib/zoneinfo` on Solaris). If your system does not have a `zoneinfo` database, you can use the downloadable package described in [Section 9.7, “MySQL Server Time Zone Support”](#).

`mysql_tzinfo_to_sql` can be invoked several ways:

```
shell> mysql_tzinfo_to_sql tz_dir
shell> mysql_tzinfo_to_sql tz_file tz_name
shell> mysql_tzinfo_to_sql --leap tz_file
```

For the first invocation syntax, pass the zoneinfo directory path name to `mysql_tzinfo_to_sql` and send the output into the `mysql` program. For example:

```
shell> mysql_tzinfo_to_sql /usr/share/zoneinfo | mysql -u root mysql
```

`mysql_tzinfo_to_sql` reads your system's time zone files and generates SQL statements from them. `mysql` processes those statements to load the time zone tables.

The second syntax causes `mysql_tzinfo_to_sql` to load a single time zone file `tz_file` that corresponds to a time zone name `tz_name`:

```
shell> mysql_tzinfo_to_sql tz_file tz_name | mysql -u root mysql
```

If your time zone needs to account for leap seconds, invoke `mysql_tzinfo_to_sql` using the third syntax, which initializes the leap second information. `tz_file` is the name of your time zone file:

```
shell> mysql_tzinfo_to_sql --leap tz_file | mysql -u root mysql
```

After running `mysql_tzinfo_to_sql`, it is best to restart the server so that it does not continue to use any previously cached time zone data.

## 4.4.8. `mysql_upgrade` — Check Tables for MySQL Upgrade

`mysql_upgrade` examines all tables in all databases for incompatibilities with the current version of MySQL Server. `mysql_upgrade` also upgrades the system tables so that you can take advantage of new privileges or capabilities that might have been added.

`mysql_upgrade` should be executed each time you upgrade MySQL. It supersedes the older `mysql_fix_privilege_tables` script, which should no longer be used.

If a table is found to have a possible incompatibility, `mysql_upgrade` performs a table check. If any problems are found, a table repair is attempted. If the table cannot be repaired, see [Section 2.12.4, “Rebuilding or Repairing Tables or Indexes”](#) for manual table repair strategies.

### Caution

You should always back up your current MySQL installation *before* performing an upgrade. See [Section 6.1, “Database Backups”](#).

Some upgrade incompatibilities may require special handling before you upgrade your MySQL installation and run `mysql_upgrade`. See [Section 2.12.1, “Upgrading MySQL”](#), for instructions on determining whether any such incompatibilities apply to your installation and how to handle them.

To use `mysql_upgrade`, make sure that the server is running, and then invoke it like this:

```
shell> mysql_upgrade [options]
```

After running `mysql_upgrade`, stop the server and restart it so that any changes made to the system tables take effect.

`mysql_upgrade` executes the following commands to check and repair tables and to upgrade the system tables:

```
mysqlcheck --all-databases --check-upgrade --auto-repair
mysql < fix_priv_tables
mysqlcheck --all-databases --check-upgrade --fix-db-names --fix-table-names
```

Notes about the preceding commands:

- Because `mysql_upgrade` invokes `mysqlcheck` with the `--all-databases` option, it processes all tables in all databases, which might take a long time to complete. Each table is locked and therefore unavailable to other sessions while it is being processed. Check and repair operations can be time-consuming, particularly for large tables.
- For details about what checks the `--check-upgrade` option entails, see the description of the `FOR UPGRADE` option of the `CHECK TABLE` statement (see [Section 12.5.2.3, “CHECK TABLE Syntax”](#)).

- `fix_priv_tables` represents a script generated internally by `mysql_upgrade` that contains SQL statements to upgrade the tables in the `mysql` database.
- Prior to MySQL 5.1.31, `mysql_upgrade` does not run the second `mysqlcheck` command, which is necessary to re-encode database or table names that contain non-alphanumeric characters. (They still appear after the upgrade with the `#mysql50#` prefix described in [Section 8.2.3, “Mapping of Identifiers to File Names”](#).) If you have such database or table names, execute the second `mysqlcheck` command manually after executing `mysql_upgrade`.

All checked and repaired tables are marked with the current MySQL version number. This ensures that next time you run `mysql_upgrade` with the same version of the server, it can tell whether there is any need to check or repair the table again.

`mysql_upgrade` also saves the MySQL version number in a file named `mysql_upgrade_info` in the data directory. This is used to quickly check whether all tables have been checked for this release so that table-checking can be skipped. To ignore this file and perform the check regardless, use the `--force` option.

If you install MySQL from RPM packages on Linux, you must install the server and client RPMs. `mysql_upgrade` is included in the server RPM but requires the client RPM because the latter includes `mysqlcheck`. (See [Section 2.4, “Installing MySQL from RPM Packages on Linux”](#).)

In MySQL 5.1.7, `mysql_upgrade` was added as a shell script and worked only for Unix systems. As of MySQL 5.1.10, `mysql_upgrade` is an executable binary and is available on all systems.

`mysql_upgrade` supports the options in the following list. It also reads option files (the `[mysql_upgrade]` and `[client]` groups) and supports the options for processing them described at [Section 4.2.3.2.1, “Command-Line Options that Affect Option-File Handling”](#). Other options are passed to `mysqlcheck`. For example, it might be necessary to specify the `--password[=password]` option.

- `--help`  
Display a short help message and exit.
- `--basedir=path`  
The path to the MySQL installation directory.
- `--datadir=path`  
The path to the data directory.
- `--debug-check`  
Print some debugging information when the program exits. This option was added in MySQL 5.1.21.
- `--debug-info, -T`  
Print debugging information and memory and CPU usage statistics when the program exits. This option was added in MySQL 5.1.21.
- `--force`  
Ignore the `mysql_upgrade_info` file and force execution of `mysqlcheck` even if `mysql_upgrade` has already been executed for the current version of MySQL.
- `--tmpdir=path, -t path`  
The path name of the directory to use for creating temporary files. This option was added in MySQL 5.1.25.
- `--user=user_name, -u user_name`  
The MySQL user name to use when connecting to the server. The default user name is `root`.
- `--verbose`  
Verbose mode. Print more information about what the program does.

## 4.5. MySQL Client Programs

## 4.5.1. `mysql` — The MySQL Command-Line Tool

`mysql` is a simple SQL shell (with GNU `readline` capabilities). It supports interactive and non-interactive use. When used interactively, query results are presented in an ASCII-table format. When used non-interactively (for example, as a filter), the result is presented in tab-separated format. The output format can be changed using command options.

If you have problems due to insufficient memory for large result sets, use the `--quick` option. This forces `mysql` to retrieve results from the server a row at a time rather than retrieving the entire result set and buffering it in memory before displaying it. This is done by returning the result set using the `mysql_use_result()` C API function in the client/server library rather than `mysql_store_result()`.

Using `mysql` is very easy. Invoke it from the prompt of your command interpreter as follows:

```
shell> mysql db_name
```

Or:

```
shell> mysql --user=user_name --password=your_password db_name
```

Then type an SQL statement, end it with “;”, \g, or \G and press Enter.

As of MySQL 5.1.10, typing Control-C causes `mysql` to attempt to kill the current statement. If this cannot be done, or Control-C is typed again before the statement is killed, `mysql` exits. Previously, Control-C caused `mysql` to exit in all cases.

You can execute SQL statements in a script file (batch file) like this:

```
shell> mysql db_name < script.sql > output.tab
```

### 4.5.1.1. `mysql` Options

Table 4.2. `mysql` Option Reference

Format	Config File	Description	Introduc- tion	Deprec- ated	Removed
<code>--auto-rehash</code>	<code>auto-rehash</code>	Enable automatic rehashing			
<code>--batch</code>	<code>batch</code>	Don't use history file			
<code>-character-sets-dir=name</code>	<code>character-sets-dir</code>	Set the default character set			
<code>--column-names</code>	<code>column-names</code>	Write column names in results			
<code>-column-type-info</code>	<code>column-type-info</code>	Display result set metadata	5.1.14		
<code>--comments</code>	<code>comments</code>	Whether to retain or strip comments in statements sent to the server	5.1.23		
<code>--compress</code>	<code>compress</code>	Compress all information sent between the client and the server			
<code>-connect_timeout=value</code>	<code>connect_timeout</code>	The number of seconds before connection timeout			
<code>-database=dbname</code>	<code>database</code>	The database to use			
<code>-debug[=debug_options]</code>	<code>debug</code>	Write a debugging log			
<code>--debug-check</code>	<code>debug-check</code>	Print debugging information when the program exits	5.1.21		
<code>--debug-info</code>	<code>debug-info</code>	Print debugging information, memory and CPU statistics when the program exits			
<code>-default-character-set</code>	<code>default-character-set</code>	Use <code>charset_name</code> as the default character set			

Format	Config File	Description	Introduc- tion	Deprec- ated	Removed
fault-charac- ter- set=charset_name					
--delimiter=str	delimiter	Set the statement delimiter			
- -ex- ecute=statement	execute	Execute the statement and quit			
--force	force	Continue even if an SQL error occurs			
--help		Display help message and exit			
--host=host_name	host	Connect to the MySQL server on the given host			
--html	html	Produce HTML output			
--ignore-spaces	ignore-spaces	Ignore spaces after function names			
--line-numbers	line-numbers	Write line numbers for errors			
- -loc- al-infile[={0 1}]	local-infile	Enable or disable for LOCAL capability for LOAD DATA INFILE			
- - max_allowed_pac- ket=value	max_allowed_pac- ket	The maximum packet length to send to or receive from the server			
- - max_join_size=va- lue	max_join_size	The automatic limit for rows in a join when using --safe-updates			
- - named-commands	named-commands	Enable named mysql commands			
- - net_buffer_length =value	net_buffer_length	The buffer size for TCP/IP and socket communication			
--no-auto-rehash		Disable automatic rehashing			
--no-beep	no-beep	Do not beep when errors occur			
- - no- named-commands	no- named-commands	Disable named mysql commands			
--no-pager	no-pager	Deprecated form of --skip-pager			
--no-tee	no-tee	Do not copy output to a file			
--one-database	one-database	Ignore statements except those for the default database named on the command line			
- - pager[=command]	pager	Use the given command for paging query output			
- -pass- word[=password]	password	The password to use when connecting to the server			
--port=port_num	port	The TCP/IP port number to use for the connection			
- - prompt=format_st r	prompt	Set the prompt to the specified format			
--protocol=type	protocol	The connection protocol to use			
--quick	quick	Do not cache each query result			
--raw	raw	Write column values without escape conversion			
--reconnect	reconnect	If the connection to the server is lost, automatically			



Format	Config File	Description	Introduc- tion	Deprec- ated	Removed
		try to reconnect			
--safe-updates	safe-updates	Allow only UPDATE and DELETE statements that specify key values			
--secure-auth	secure-auth	Do not send passwords to the server in old (pre-4.1.1) format			
- -se- lect_limit=value	select_limit	The automatic limit for SELECT statements when using --safe-updates			
--show-warnings	show-warnings	Show warnings after each statement if there are any			
--sigint-ignore	sigint-ignore	Ignore SIGINT signals (typically the result of typing Control-C)			
--silent	silent	Silent mode			
--skip-auto-rehash	skip-auto-rehash	Disable automatic rehashing			
- - skip- column-names	skip- column-names	Do not write column names in results			
- - skip-line-numbers	skip-line-numbers	Skip line numbers for errors			
- - skip- named-commands	skip- named-commands	Disable named mysql commands			
--skip-pager	skip-pager	Disable paging			
--skip-reconnect	skip-reconnect	Disable reconnecting			
--socket=path	socket	For connections to localhost			
- -ssl-ca=file_name	ssl-ca	The path to a file that contains a list of trusted SSL CAs			
- - ssl- capath=directory_ name	ssl-capath	The path to a directory that contains trusted SSL CA certificates in PEM format			
- - ssl- cert=file_name	ssl-cert	The name of the SSL certificate file to use for establishing a secure connection			
- - ssl- cipher=cipher_list	ssl-cipher	A list of allowable ciphers to use for SSL encryption			
- - ssl-key=file_name	ssl-key	The name of the SSL key file to use for establishing a secure connection			
- - ssl-veri- fy-server-cert	ssl-veri- fy-server-cert	The server's Common Name value in its certificate is verified against the host name used when connecting to the server			
--table	table	Display output in tabular format			
--tee=file_name	tee	Append a copy of output to the given file			
--unbuffered	unbuffered	Flush the buffer after each query			
--user=user_name	user	The MySQL user name to use when connecting to the server			
--verbose		Verbose mode			
--version		Display version information and exit			

Format	Config File	Description	Introduc- tion	Deprec- ated	Removed
<code>--vertical</code>	<code>vertical</code>	Print query output rows vertically (one line per column value)			
<code>--wait</code>	<code>wait</code>	If the connection cannot be established, wait and retry instead of aborting			
<code>--xml</code>	<code>xml</code>	Produce XML output			

`mysql` supports the options in the following list. It also reads option files and supports the options for processing them described at Section 4.2.3.2.1, “Command-Line Options that Affect Option-File Handling”.

- `--help, -?`  
Display a help message and exit.
- `--auto-rehash`  
Enable automatic rehashing. This option is on by default, which enables database, table, and column name completion. Use `--disable-auto-rehash` to disable rehashing. That causes `mysql` to start faster, but you must issue the `rehash` command if you want to use name completion.  
  
To complete a name, enter the first part and press Tab. If the name is unambiguous, `mysql` completes it. Otherwise, you can press Tab again to see the possible names that begin with what you have typed so far. Completion does not occur if there is no default database.
- `--batch, -B`  
Print results using tab as the column separator, with each row on a new line. With this option, `mysql` does not use the history file.  
  
Batch mode results in non-tabular output format and escaping of special characters. Escaping may be disabled by using raw mode; see the description for the `--raw` option.
- `--character-sets-dir=path`  
The directory where character sets are installed. See Section 9.2, “The Character Set Used for Data and Sorting”.
- `--column-names`  
Write column names in results.
- `--column-type-info, -m`  
Display result set metadata. This option was added in MySQL 5.1.14. (Before that, use `--debug-info`.) The `-m` short option was added in MySQL 5.1.21.
- `--comments, -c`  
Whether to preserve comments in statements sent to the server. The default is `--skip-comments` (discard comments), enable with `--comments` (preserve comments). This option was added in MySQL 5.1.23.
- `--compress, -C`  
Compress all information sent between the client and the server if both support compression.
- `--database=db_name, -D db_name`  
The database to use. This is useful primarily in an option file.
- `--debug[=debug_options], -# [debug_options]`  
Write a debugging log. A typical `debug_options` string is `'d:t:o,file_name'`. The default is `'d:t:o,/tmp/mysql.trace'`.
- `--debug-check`  
Print some debugging information when the program exits. This option was added in MySQL 5.1.21.
- `--debug-info, -T`

Before MySQL 5.1.14, this option prints debugging information and memory and CPU usage statistics when the program exits, and also causes display of result set metadata during execution. As of MySQL 5.1.14, use `--column-type-info` to display result set metadata.

- `--default-character-set=charset_name`

Use `charset_name` as the default character set. See [Section 9.2, “The Character Set Used for Data and Sorting”](#).

- `--delimiter=str`

Set the statement delimiter. The default is the semicolon character (“;”).

- `--disable-named-commands`

Disable named commands. Use the `\*` form only, or use named commands only at the beginning of a line ending with a semicolon (“;”). `mysql` starts with this option *enabled* by default. However, even with this option, long-format commands still work from the first line. See [Section 4.5.1.2, “mysql Commands”](#).

- `--execute=statement, -e statement`

Execute the statement and quit. The default output format is like that produced with `--batch`. See [Section 4.2.3.1, “Using Options on the Command Line”](#), for some examples.

- `--force, -f`

Continue even if an SQL error occurs.

- `--host=host_name, -h host_name`

Connect to the MySQL server on the given host.

- `--html, -H`

Produce HTML output.

- `--ignore-spaces, -i`

Ignore spaces after function names. The effect of this is described in the discussion for the `IGNORE_SPACE` SQL mode (see [Section 5.1.7, “Server SQL Modes”](#)).

- `--line-numbers`

Write line numbers for errors. Disable this with `--skip-line-numbers`.

- `--local-infile[={0|1}]`

Enable or disable `LOCAL` capability for `LOAD DATA INFILE`. With no value, the option enables `LOCAL`. The option may be given as `--local-infile=0` or `--local-infile=1` to explicitly disable or enable `LOCAL`. Enabling `LOCAL` has no effect if the server does not also support it.

#### MySQL Enterprise

For expert advice on the security implications of enabling `LOCAL`, subscribe to the MySQL Enterprise Monitor. For more information, see <http://www.mysql.com/products/enterprise/advisors.html>.

- `--named-commands, -G`

Enable named `mysql` commands. Long-format commands are allowed, not just short-format commands. For example, `quit` and `\q` both are recognized. Use `--skip-named-commands` to disable named commands. See [Section 4.5.1.2, “mysql Commands”](#).

- `--no-auto-rehash, -A`

Deprecated form of `--skip-auto-rehash`. Use `--disable-auto-rehash` instead. See the description for `--auto-rehash`.

- `--no-beep, -b`

Do not beep when errors occur.

- `--no-named-commands, -g`

Deprecated, use `--disable-named-commands` instead.

- `--no-pager`

Deprecated form of `--skip-pager`. See the `--pager` option.

- `--no-tee`

Do not copy output to a file. [Section 4.5.1.2, “mysql Commands”](#), discusses tee files further.

- `--one-database, -o`

Ignore statements except those for the default database named on the command line. This is useful for skipping updates to other databases in the binary log.

- `--pager[=command]`

Use the given command for paging query output. If the command is omitted, the default pager is the value of your `PAGER` environment variable. Valid pagers are `less`, `more`, `cat [> filename]`, and so forth. This option works only on Unix. It does not work in batch mode. To disable paging, use `--skip-pager`. [Section 4.5.1.2, “mysql Commands”](#), discusses output paging further.

- `--password[=password], -p[password]`

The password to use when connecting to the server. If you use the short option form (`-p`), you *cannot* have a space between the option and the password. If you omit the `password` value following the `--password` or `-p` option on the command line, you are prompted for one.

Specifying a password on the command line should be considered insecure. See [Section 5.5.6.2, “End-User Guidelines for Password Security”](#).

- `--pipe, -W`

On Windows, connect to the server via a named pipe. This option applies only for connections to a local server, and only if the server supports named-pipe connections.

- `--port=port_num, -P port_num`

The TCP/IP port number to use for the connection.

- `--prompt=format_str`

Set the prompt to the specified format. The default is `mysql>`. The special sequences that the prompt can contain are described in [Section 4.5.1.2, “mysql Commands”](#).

- `--protocol={TCP|SOCKET|PIPE|MEMORY}`

The connection protocol to use for connecting to the server. It is useful when the other connection parameters normally would cause a protocol to be used other than the one you want. For details on the allowable values, see [Section 4.2.2, “Connecting to the MySQL Server”](#).

- `--quick, -q`

Do not cache each query result, print each row as it is received. This may slow down the server if the output is suspended. With this option, `mysql` does not use the history file.

- `--raw, -r`

For tabular output, the “boxing” around columns enables one column value to be distinguished from another. For non-tabular output (such as is produced in batch mode or when the `--batch` or `--silent` option is given), special characters are escaped in the output so they can be identified easily. Newline, tab, `NUL`, and backslash are written as `\n`, `\t`, `\0`, and `\\`. The `--raw` option disables this character escaping.

The following example demonstrates tabular versus non-tabular output and the use of raw mode to disable escaping:

```
% mysql
mysql> SELECT CHAR(92);
+-----+
| CHAR(92) |
+-----+
| \       |
+-----+
```

```
% mysql -s
mysql> SELECT CHAR(92);
CHAR(92)
\\

% mysql -s -r
mysql> SELECT CHAR(92);
CHAR(92)
\
```

- `--reconnect`

If the connection to the server is lost, automatically try to reconnect. A single reconnect attempt is made each time the connection is lost. To suppress reconnection behavior, use `--skip-reconnect`.

- `--safe-updates`, `--i-am-a-dummy`, `-U`

Allow only those `UPDATE` and `DELETE` statements that specify which rows to modify by using key values. If you have set this option in an option file, you can override it by using `--safe-updates` on the command line. See [Section 4.5.1.5, “mysql Tips”](#), for more information about this option.

- `--secure-auth`

Do not send passwords to the server in old (pre-4.1.1) format. This prevents connections except for servers that use the newer password format.

### MySQL Enterprise

For expert advice on database security, subscribe to the MySQL Enterprise Monitor. For more information, see <http://www.mysql.com/products/enterprise/advisors.html>.

- `--show-warnings`

Cause warnings to be shown after each statement if there are any. This option applies to interactive and batch mode.

- `--sigint-ignore`

Ignore `SIGINT` signals (typically the result of typing Control-C).

- `--silent`, `-s`

Silent mode. Produce less output. This option can be given multiple times to produce less and less output.

This option results in non-tabular output format and escaping of special characters. Escaping may be disabled by using raw mode; see the description for the `--raw` option.

- `--skip-column-names`, `-N`

Do not write column names in results. The short format, `-N` is deprecated, use the long format instead.

- `--skip-line-numbers`, `-L`

Do not write line numbers for errors. Useful when you want to compare result files that include error messages. The short format, `-L` is deprecated, use the long format instead.

- `--socket=path`, `-S path`

For connections to `localhost`, the Unix socket file to use, or, on Windows, the name of the named pipe to use.

- `--ssl*`

Options that begin with `--ssl` specify whether to connect to the server via SSL and indicate where to find SSL keys and certificates. See [Section 5.5.7.3, “SSL Command Options”](#).

- `--table`, `-t`

Display output in table format. This is the default for interactive use, but can be used to produce table output in batch mode.

- `--tee=file_name`

Append a copy of output to the given file. This option does not work in batch mode. [Section 4.5.1.2, “mysql Commands”](#), discusses tee files further.

- `--unbuffered`, `-n`

Flush the buffer after each query.

- `--user=user_name, -u user_name`

The MySQL user name to use when connecting to the server.

- `--verbose, -v`

Verbose mode. Produce more output about what the program does. This option can be given multiple times to produce more and more output. (For example, `-v -v -v` produces table output format even in batch mode.)

- `--version, -V`

Display version information and exit.

- `--vertical, -E`

Print query output rows vertically (one line per column value). Without this option, you can specify vertical output for individual statements by terminating them with `\G`.

- `--wait, -w`

If the connection cannot be established, wait and retry instead of aborting.

- `--xml, -X`

Produce XML output.

### Note

Prior to MySQL 5.1.12, there was no differentiation in the output when using this option between columns containing the `NULL` value and columns containing the string literal `'NULL'`; both were represented as

```
<field name="column_name">NULL</field>
```

Beginning with MySQL 5.1.12, the output when `--xml` is used with `mysql` matches that of `mysqldump --xml`. See [Section 4.5.4, “mysqldump — A Database Backup Program”](#) for details.

Beginning with MySQL 5.1.18, the XML output also uses an XML namespace, as shown here:

```
shell> mysql --xml -uroot -e "SHOW VARIABLES LIKE 'version%'"
<?xml version="1.0"?>

<resultset statement="SHOW VARIABLES LIKE 'version%'" xmlns:xsi="http://www.w3.org/2001/XMLSchema-instance">
<row>
<field name="Variable_name">version</field>
<field name="Value">5.0.40-debug</field>
</row>

<row>
<field name="Variable_name">version_comment</field>
<field name="Value">Source distribution</field>
</row>

<row>
<field name="Variable_name">version_compile_machine</field>
<field name="Value">i686</field>
</row>

<row>
<field name="Variable_name">version_compile_os</field>
<field name="Value">suse-linux-gnu</field>
</row>
</resultset>
```

(See [Bug#25946](#).)

You can also set the following variables by using `--var_name=value`. The `--set-variable` format is deprecated.

- `connect_timeout`

The number of seconds before connection timeout. (Default value is 0.)

- `max_allowed_packet`

The maximum packet length to send to or receive from the server. (Default value is 16MB.)

- `max_join_size`

The automatic limit for rows in a join when using `--safe-updates`. (Default value is 1,000,000.)

- `net_buffer_length`

The buffer size for TCP/IP and socket communication. (Default value is 16KB.)

- `select_limit`

The automatic limit for `SELECT` statements when using `--safe-updates`. (Default value is 1,000.)

On Unix, the `mysql` client writes a record of executed statements to a history file. By default, this file is named `.mysql_history` and is created in your home directory. To specify a different file, set the value of the `MYSQL_HISTFILE` environment variable.

The `.mysql_history` should be protected with a restrictive access mode because sensitive information might be written to it, such as the text of SQL statements that contain passwords. See [Section 5.5.6.2, “End-User Guidelines for Password Security”](#).

If you do not want to maintain a history file, first remove `.mysql_history` if it exists, and then use either of the following techniques:

- Set the `MYSQL_HISTFILE` variable to `/dev/null`. To cause this setting to take effect each time you log in, put the setting in one of your shell's startup files.
- Create `.mysql_history` as a symbolic link to `/dev/null`:

```
shell> ln -s /dev/null $HOME/.mysql_history
```

You need do this only once.

#### 4.5.1.2. `mysql` Commands

`mysql` sends each SQL statement that you issue to the server to be executed. There is also a set of commands that `mysql` itself interprets. For a list of these commands, type `help` or `\h` at the `mysql>` prompt:

```
mysql> help
List of all MySQL commands:
Note that all text commands must be first on line and end with ';'
?          (?) Synonym for 'help'.
clear      (c) Clear command.
connect    (r) Reconnect to the server. Optional arguments are db and host.
delimiter (\d) Set statement delimiter.
edit       (e) Edit command with $EDITOR.
ego        (G) Send command to mysql server, display result vertically.
exit       (q) Exit mysql. Same as quit.
go         (g) Send command to mysql server.
help       (h) Display this help.
nopager    (n) Disable pager, print to stdout.
notee      (t) Don't write into outfile.
pager      (P) Set PAGER [to_pager]. Print the query results via PAGER.
print      (p) Print current command.
prompt     (R) Change your mysql prompt.
quit       (q) Quit mysql.
rehash     (#) Rebuild completion hash.
source     (.) Execute an SQL script file. Takes a file name as an argument.
status     (s) Get status information from the server.
system     (!) Execute a system shell command.
tee        (T) Set outfile [to_outfile]. Append everything into given
         outfile.
use        (u) Use another database. Takes database name as argument.
charset    (C) Switch to another charset. Might be needed for processing
         binlog with multi-byte charsets.
warnings   (W) Show warnings after every statement.
nowarning  (w) Don't show warnings after every statement.

For server side help, type 'help contents'
```

Each command has both a long and short form. The long form is not case sensitive; the short form is. The long form can be followed by an optional semicolon terminator, but the short form should not.



The use of short-form commands within multi-line `/* ... */` comments is not supported.

- `help [arg], \h [arg], \? [arg], ? [arg]`

Displays a help message listing the available `mysql` commands.

If you provide an argument to the `help` command, `mysql` uses it as a search string to access server-side help from the contents of the MySQL Reference Manual. For more information, see [Section 4.5.1.3, “mysql Server-Side Help”](#).

- `charset charset_name, \C charset_name`

The `charset` command changes the default character set and issues a `SET NAMES` statement. This enables the character set to remain synchronized on the client and server if `mysql` is run with auto-reconnect enabled (which is not recommended), because the specified character set is used for reconnects. This command was added in MySQL 5.1.7.

- `clear, \c`

Clears the current input. Use this if you change your mind about executing the statement that you are entering.

- `connect [db_name host_name], \r [db_name host_name]`

Reconnects to the server. The optional database name and host name arguments may be given to specify the default database or the host where the server is running. If omitted, the current values are used.

- `delimiter str, \d str`

The `delimiter` command changes the string that `mysql` interprets as the separator between SQL statements. The default is the semicolon character (“;”).

The delimiter can be specified as an unquoted or quoted argument. Quoting can be done with either single quote (‘) or double quote (”) characters. To include a quote within a quoted string, either quote the string with the other quote character or escape the quote with a backslash (“\”) character. Backslash should be avoided outside of quoted strings because it is the escape character for MySQL. For an unquoted argument, the delimiter is read up to the first space or end of line. For a quoted argument, the delimiter is read up to the matching quote on the line.

When the delimiter recognized by `mysql` is set to something other than the default of “;”, instances of that character are sent to the server without interpretation. However, the server itself still interprets “;” as a statement delimiter and processes statements accordingly. This behavior on the server side comes into play for multiple-statement execution (see [Section 20.10.12, “C API Support for Multiple Statement Execution”](#)), and for parsing the body of stored procedures and functions, triggers, and events (see [Section 18.1, “Defining Stored Programs”](#)).

- `edit, \e`

Edits the current input statement. `mysql` checks the values of the `EDITOR` and `VISUAL` environment variables to determine which editor to use. The default editor is `vi` if neither variable is set.

The `edit` command works only in Unix.

- `ego, \G`

Sends the current statement to the server to be executed and displays the result using vertical format.

- `exit, \q`

Exits `mysql`.

- `go, \g`

Sends the current statement to the server to be executed.

- `nopager, \n`

Disables output paging. See the description for `pager`.

The `nopager` command works only in Unix.

- `notee, \t`

Disables output copying to the tee file. See the description for `tee`.

- `nowarning, \w`

Enables display of warnings after each statement.

- `pager [command], \P [command]`

By using the `--pager` option when you invoke `mysql`, it is possible to browse or search query results in interactive mode with Unix programs such as `less`, `more`, or any other similar program. If you specify no value for the option, `mysql` checks the value of the `PAGER` environment variable and sets the pager to that.

Output paging can be enabled interactively with the `pager` command and disabled with `nopager`. The command takes an optional argument; if given, the paging program is set to that. With no argument, the pager is set to the pager that was set on the command line, or `stdout` if no pager was specified.

Output paging works only in Unix because it uses the `popen()` function, which does not exist on Windows. For Windows, the `tee` option can be used instead to save query output, although it is not as convenient as `pager` for browsing output in some situations.

- `print, \p`

Prints the current input statement without executing it.

- `prompt [str], \R [str]`

Reconfigures the `mysql` prompt to the given string. The special character sequences that can be used in the prompt are described later in this section.

If you specify the `prompt` command with no argument, `mysql` resets the prompt to the default of `mysql>`.

- `quit, \q`

Exits `mysql`.

- `refresh, \#`

Rebuilds the completion hash that enables database, table, and column name completion while you are entering statements. (See the description for the `--auto-refresh` option.)

- `source file_name, \. file_name`

Reads the named file and executes the statements contained therein. On Windows, you can specify path name separators as `/` or `\\`.

- `status, \s`

The `status` command provides some information about the connection and the server you are using. If you are running in `--safe-updates` mode, `status` also prints the values for the `mysql` variables that affect your queries.

- `system command, \! command`

Executes the given command using your default command interpreter.

The `system` command works only in Unix.

- `tee [file_name], \T [file_name]`

By using the `--tee` option when you invoke `mysql`, you can log statements and their output. All the data displayed on the screen is appended into a given file. This can be very useful for debugging purposes also. `mysql` flushes results to the file after each statement, just before it prints its next prompt.

You can enable this feature interactively with the `tee` command. Without a parameter, the previous file is used. The `tee` file can be disabled with the `notee` command. Executing `tee` again re-enables logging.

- `use db_name, \u db_name`

Uses `db_name` as the default database.

- `warnings, \W`

Enables display of warnings after each statement (if there are any).

Here are a few tips about the `pager` command:

- You can use it to write to a file and the results go only to the file:

```
mysql> pager cat > /tmp/log.txt
```

You can also pass any options for the program that you want to use as your pager:

```
mysql> pager less -n -i -S
```

- In the preceding example, note the `-S` option. You may find it very useful for browsing wide query results. Sometimes a very wide result set is difficult to read on the screen. The `-S` option to `less` can make the result set much more readable because you can scroll it horizontally using the left-arrow and right-arrow keys. You can also use `-S` interactively within `less` to switch the horizontal-browse mode on and off. For more information, read the `less` manual page:

```
shell> man less
```

- The `-F` and `-X` options may be used with `less` to cause it to exit if output fits on one screen, which is convenient when no scrolling is necessary:

```
mysql> pager less -n -i -S -F -X
```

- You can specify very complex pager commands for handling query output:

```
mysql> pager cat | tee /dr1/tmp/res.txt \  
| tee /dr2/tmp/res2.txt | less -n -i -S
```

In this example, the command would send query results to two files in two different directories on two different file systems mounted on `/dr1` and `/dr2`, yet still display the results onscreen via `less`.

You can also combine the `tee` and `pager` functions. Have a `tee` file enabled and `pager` set to `less`, and you are able to browse the results using the `less` program and still have everything appended into a file the same time. The difference between the Unix `tee` used with the `pager` command and the `mysql` built-in `tee` command is that the built-in `tee` works even if you do not have the Unix `tee` available. The built-in `tee` also logs everything that is printed on the screen, whereas the Unix `tee` used with `pager` does not log quite that much. Additionally, `tee` file logging can be turned on and off interactively from within `mysql`. This is useful when you want to log some queries to a file, but not others.

The `prompt` command reconfigures the default `mysql>` prompt. The string for defining the prompt can contain the following special sequences.

Option	Description
<code>\c</code>	A counter that increments for each statement you issue
<code>\D</code>	The full current date
<code>\d</code>	The default database
<code>\h</code>	The server host
<code>\l</code>	The current delimiter (new in 5.1.12)
<code>\m</code>	Minutes of the current time
<code>\n</code>	A newline character
<code>\O</code>	The current month in three-letter format (Jan, Feb, ...)
<code>\o</code>	The current month in numeric format
<code>\P</code>	am/pm
<code>\p</code>	The current TCP/IP port or socket file
<code>\R</code>	The current time, in 24-hour military time (0-23)
<code>\r</code>	The current time, standard 12-hour time (1-12)
<code>\S</code>	Semicolon
<code>\s</code>	Seconds of the current time
<code>\t</code>	A tab character
<code>\U</code>	Your full <code>user_name@host_name</code> account name
<code>\u</code>	Your user name
<code>\v</code>	The server version
<code>\w</code>	The current day of the week in three-letter format (Mon, Tue, ...)

<code>\Y</code>	The current year, four digits
<code>\y</code>	The current year, two digits
<code>\_</code>	A space
<code>\</code>	A space (a space follows the backslash)
<code>\'</code>	Single quote
<code>\"</code>	Double quote
<code>\\</code>	A literal “\” backslash character
<code>\x</code>	<code>x</code> , for any “ <code>x</code> ” not listed above

You can set the prompt in several ways:

- *Use an environment variable.* You can set the `MYSQL_PS1` environment variable to a prompt string. For example:

```
shell> export MYSQL_PS1="(\\u@\\h) [\\d]> "
```

- *Use a command-line option.* You can set the `--prompt` option on the command line to `mysql`. For example:

```
shell> mysql --prompt="(\\u@\\h) [\\d]> "
(user@host) [database]>
```

- *Use an option file.* You can set the `prompt` option in the `[mysql]` group of any MySQL option file, such as `/etc/my.cnf` or the `.my.cnf` file in your home directory. For example:

```
[mysql]
prompt=(\\u@\\h) [\\d]>\\_
```

In this example, note that the backslashes are doubled. If you set the prompt using the `prompt` option in an option file, it is advisable to double the backslashes when using the special prompt options. There is some overlap in the set of allowable prompt options and the set of special escape sequences that are recognized in option files. (These sequences are listed in [Section 4.2.3.2, “Using Option Files”](#).) The overlap may cause you problems if you use single backslashes. For example, `\s` is interpreted as a space rather than as the current seconds value. The following example shows how to define a prompt within an option file to include the current time in `HH:MM:SS>` format:

```
[mysql]
prompt="\\r:\\m:\\s> "
```

- *Set the prompt interactively.* You can change your prompt interactively by using the `prompt` (or `\R`) command. For example:

```
mysql> prompt (\\u@\\h) [\\d]>\\_
PROMPT set to '(\\u@\\h) [\\d]>\\_'
(user@host) [database]>
(user@host) [database]> prompt
Returning to default PROMPT of mysql>
mysql>
```

### 4.5.1.3. `mysql` Server-Side Help

```
mysql> help search_string
```

If you provide an argument to the `help` command, `mysql` uses it as a search string to access server-side help from the contents of the MySQL Reference Manual. The proper operation of this command requires that the help tables in the `mysql` database be initialized with help topic information (see [Section 5.1.8, “Server-Side Help”](#)).

If there is no match for the search string, the search fails:

```
mysql> help me
Nothing found
Please try to run 'help contents' for a list of all accessible topics
```

Use `help contents` to see a list of the help categories:

```
mysql> help contents
You asked for help about help category: "Contents"
For more information, type 'help <item>', where <item> is one of the
```

```
following categories:
Account Management
Administration
Data Definition
Data Manipulation
Data Types
Functions
Functions and Modifiers for Use with GROUP BY
Geographic Features
Language Structure
Plugins
Storage Engines
Stored Routines
Table Maintenance
Transactions
Triggers
```

If the search string matches multiple items, `mysql` shows a list of matching topics:

```
mysql> help logs
Many help items for your request exist.
To make a more specific request, please type 'help <item>',
where <item> is one of the following topics:
SHOW
SHOW BINARY LOGS
SHOW ENGINE
SHOW LOGS
```

Use a topic as the search string to see the help entry for that topic:

```
mysql> help show binary logs
Name: 'SHOW BINARY LOGS'
Description:
Syntax:
SHOW BINARY LOGS
SHOW MASTER LOGS

Lists the binary log files on the server. This statement is used as
part of the procedure described in [purge-binary-logs], that shows how
to determine which logs can be purged.

mysql> SHOW BINARY LOGS;
+-----+-----+
| Log_name          | File_size |
+-----+-----+
| binlog.000015     | 724935   |
| binlog.000016     | 733481   |
+-----+-----+
```

#### 4.5.1.4. Executing SQL Statements from a Text File

The `mysql` client typically is used interactively, like this:

```
shell> mysql db_name
```

However, it is also possible to put your SQL statements in a file and then tell `mysql` to read its input from that file. To do so, create a text file `text_file` that contains the statements you wish to execute. Then invoke `mysql` as shown here:

```
shell> mysql db_name < text_file
```

If you place a `USE db_name` statement as the first statement in the file, it is unnecessary to specify the database name on the command line:

```
shell> mysql < text_file
```

If you are already running `mysql`, you can execute an SQL script file using the `source` command or `\.` command:

```
mysql> source file_name
mysql> \. file_name
```

Sometimes you may want your script to display progress information to the user. For this you can insert statements like this:

```
SELECT '<info_to_display>' AS ' ';
```

The statement shown outputs `<info_to_display>`.

As of MySQL 5.1.23, `mysql` ignores Unicode byte order mark (BOM) characters at the beginning of input files. Previously, it read them and sent them to the server, resulting in a syntax error. Presence of a BOM does not cause `mysql` to change its default character set. To do that, invoke `mysql` with an option such as `--default-character-set=utf8`.

For more information about batch mode, see [Section 3.5, “Using `mysql` in Batch Mode”](#).

## 4.5.1.5. `mysql` Tips

This section describes some techniques that can help you use `mysql` more effectively.

### 4.5.1.5.1. Displaying Query Results Vertically

Some query results are much more readable when displayed vertically, instead of in the usual horizontal table format. Queries can be displayed vertically by terminating the query with `\G` instead of a semicolon. For example, longer text values that include newlines often are much easier to read with vertical output:

```
mysql> SELECT * FROM mails WHERE LENGTH(txt) < 300 LIMIT 300,1\G
***** 1. row *****
msg_nro: 3068
date: 2000-03-01 23:29:50
time_zone: +0200
mail_from: Monty
reply: monty@no.spam.com
mail_to: "Thimble Smith" <tim@no.spam.com>
subj: UTF-8
txt: >>>> "Thimble" == Thimble Smith writes:

Thimble> Hi. I think this is a good idea. Is anyone familiar
Thimble> with UTF-8 or Unicode? Otherwise, I'll put this on my
Thimble> TODO list and see what happens.

Yes, please do that.

Regards,
Monty
file: inbox-jani-1
hash: 190402944
1 row in set (0.09 sec)
```

### 4.5.1.5.2. Using the `--safe-updates` Option

For beginners, a useful startup option is `--safe-updates` (or `--i-am-a-dummy`, which has the same effect). It is helpful for cases when you might have issued a `DELETE FROM tbl_name` statement but forgotten the `WHERE` clause. Normally, such a statement deletes all rows from the table. With `--safe-updates`, you can delete rows only by specifying the key values that identify them. This helps prevent accidents.

When you use the `--safe-updates` option, `mysql` issues the following statement when it connects to the MySQL server:

```
SET sql_safe_updates=1, sql_select_limit=1000, sql_max_join_size=1000000;
```

See [Section 5.1.4, “Session System Variables”](#).

The `SET` statement has the following effects:

- You are not allowed to execute an `UPDATE` or `DELETE` statement unless you specify a key constraint in the `WHERE` clause or provide a `LIMIT` clause (or both). For example:

```
UPDATE tbl_name SET not_key_column=val WHERE key_column=val;
UPDATE tbl_name SET not_key_column=val LIMIT 1;
```

- The server limits all large `SELECT` results to 1,000 rows unless the statement includes a `LIMIT` clause.
- The server aborts multiple-table `SELECT` statements that probably need to examine more than 1,000,000 row combinations.

To specify limits different from 1,000 and 1,000,000, you can override the defaults by using the `--select_limit` and `--max_join_size` options:

```
shell> mysql --safe-updates --select_limit=500 --max_join_size=10000
```

### 4.5.1.5.3. Disabling `mysql` Auto-Reconnect

If the `mysql` client loses its connection to the server while sending a statement, it immediately and automatically tries to reconnect once to the server and send the statement again. However, even if `mysql` succeeds in reconnecting, your first connection has ended and all your previous session objects and settings are lost: temporary tables, the autocommit mode, and user-defined and session variables. Also, any current transaction rolls back. This behavior may be dangerous for you, as in the following example where the

server was shut down and restarted between the first and second statements without you knowing it:

```
mysql> SET @a=1;
Query OK, 0 rows affected (0.05 sec)

mysql> INSERT INTO t VALUES(@a);
ERROR 2006: MySQL server has gone away
No connection. Trying to reconnect...
Connection id: 1
Current database: test

Query OK, 1 row affected (1.30 sec)

mysql> SELECT * FROM t;
+-----+
| a     |
+-----+
| NULL |
+-----+
1 row in set (0.05 sec)
```

The `@a` user variable has been lost with the connection, and after the reconnection it is undefined. If it is important to have `mysql` terminate with an error if the connection has been lost, you can start the `mysql` client with the `--skip-reconnect` option.

For more information about auto-reconnect and its effect on state information when a reconnection occurs, see [Section 20.10.11, “Controlling Automatic Reconnection Behavior”](#).

## 4.5.2. `mysqladmin` — Client for Administering a MySQL Server

`mysqladmin` is a client for performing administrative operations. You can use it to check the server's configuration and current status, to create and drop databases, and more.

Invoke `mysqladmin` like this:

```
shell> mysqladmin [options] command [command-arg] [command [command-arg]] ...
```

`mysqladmin` supports the commands described in the following list. Some of the commands take an argument following the command name.

- `create db_name`  
Create a new database named `db_name`.
  - `debug`  
Tell the server to write debug information to the error log.  
  
Beginning with MySQL 5.1.12, this includes information about the Event Scheduler. See [Section 18.4.5, “Event Scheduler Status”](#).
  - `drop db_name`  
Delete the database named `db_name` and all its tables.
  - `extended-status`  
Display the server status variables and their values.
- MySQL Enterprise**  
For expert advice on using server status variables, subscribe to the MySQL Enterprise Monitor. For more information, see <http://www.mysql.com/products/enterprise/advisors.html>.
- `flush-hosts`  
Flush all information in the host cache.
  - `flush-logs`  
Flush all logs.
  - `flush-privileges`  
Reload the grant tables (same as `reload`).



- `flush-status`

Clear status variables.

- `flush-tables`

Flush all tables.

- `flush-threads`

Flush the thread cache.

- `kill id,id,...`

Kill server threads. If multiple thread ID values are given, there must be no spaces in the list.

- `old-password new-password`

This is like the `password` command but stores the password using the old (pre-4.1) password-hashing format. (See [Section 5.5.6.3](#), “Password Hashing in MySQL”.)

#### MySQL Enterprise

For expert advice on the security implications of using the `old-password` command, subscribe to the MySQL Enterprise Monitor. For more information, see <http://www.mysql.com/products/enterprise/advisors.html>.

- `password new-password`

Set a new password. This changes the password to `new-password` for the account that you use with `mysqladmin` for connecting to the server. Thus, the next time you invoke `mysqladmin` (or any other client program) using the same account, you will need to specify the new password.

If the `new-password` value contains spaces or other characters that are special to your command interpreter, you need to enclose it within quotes. On Windows, be sure to use double quotes rather than single quotes; single quotes are not stripped from the password, but rather are interpreted as part of the password. For example:

```
shell> mysqladmin password "my new password"
```

#### Caution

Do not use this command used if the server was started with the `--skip-grant-tables` option. No password change will be applied. This is true even if you precede the `password` command with `flush-privileges` on the same command line to re-enable the grant tables because the flush operation occurs after you connect. However, you can use `mysqladmin flush-privileges` to re-enable the grant table and then use a separate `mysqladmin password` command to change the password.

- `ping`

Check whether the server is alive. The return status from `mysqladmin` is 0 if the server is running, 1 if it is not. This is 0 even in case of an error such as `Access denied`, because this means that the server is running but refused the connection, which is different from the server not running.

- `processlist`

Show a list of active server threads. This is like the output of the `SHOW PROCESSLIST` statement. If the `--verbose` option is given, the output is like that of `SHOW FULL PROCESSLIST`. (See [Section 12.5.5.31](#), “`SHOW PROCESSLIST Syntax`”.)

- `reload`

Reload the grant tables.

- `refresh`

Flush all tables and close and open log files.

- `shutdown`

Stop the server.

- `start-slave`

Start replication on a slave server.

- `status`

Display a short server status message.

- `stop-slave`

Stop replication on a slave server.

- `variables`

Display the server system variables and their values.

### MySQL Enterprise

For expert advice on using server system variables, subscribe to the MySQL Enterprise Monitor. For more information, see <http://www.mysql.com/products/enterprise/advisors.html>.

- `version`

Display version information from the server.

All commands can be shortened to any unique prefix. For example:

```
shell> mysqladmin proc stat
+-----+-----+-----+-----+-----+-----+-----+-----+
| Id | User | Host | db | Command | Time | State | Info |
+-----+-----+-----+-----+-----+-----+-----+-----+
| 51 | monty | localhost | | Query | 0 | | show processlist |
+-----+-----+-----+-----+-----+-----+-----+-----+
Uptime: 1473624 Threads: 1 Questions: 39487
Slow queries: 0 Opens: 541 Flush tables: 1
Open tables: 19 Queries per second avg: 0.0268
```

The `mysqladmin status` command result displays the following values:

- `Uptime`

The number of seconds the MySQL server has been running.

- `Threads`

The number of active threads (clients).

- `Questions`

The number of questions (queries) from clients since the server was started.

- `Slow queries`

The number of queries that have taken more than `long_query_time` seconds. See [Section 5.2.5, “The Slow Query Log”](#).

- `Opens`

The number of tables the server has opened.

- `Flush tables`

The number of `flush-*`, `refresh`, and `reload` commands the server has executed.

- `Open tables`

The number of tables that currently are open.

- `Memory in use`

The amount of memory allocated directly by `mysqld`. This value is displayed only when MySQL has been compiled with `--with-debug=full`.

- `Maximum memory used`

The maximum amount of memory allocated directly by `mysqld`. This value is displayed only when MySQL has been compiled with `--with-debug=full`.

If you execute `mysqladmin shutdown` when connecting to a local server using a Unix socket file, `mysqladmin` waits until the server's process ID file has been removed, to ensure that the server has stopped properly.

**Table 4.3. `mysqladmin` Option Reference**

Format	Config File	Description	Introduc- tion	Deprec- ated	Removed
<code>--compress</code>	<code>compress</code>	Compress all information sent between the client and the server			
<code>-connect_timeout=seconds</code>	<code>connect_timeout</code>	The number of seconds before connection timeout			
<code>--count=#</code>	<code>count</code>	The number of iterations to make for repeated command execution			
<code>-debug[=debug_options]</code>	<code>debug</code>	Write a debugging log			
<code>--debug-check</code>	<code>debug-check</code>	Print debugging information when the program exits	5.1.21		
<code>--debug-info</code>	<code>debug-info</code>	Print debugging information, memory and CPU statistics when the program exits	5.1.14		
<code>-default-character-set=charset_name</code>	<code>default-character-set</code>	Use <code>charset_name</code> as the default character set			
<code>--force</code>	<code>force</code>	Continue even if an SQL error occurs			
<code>--help</code>		Display help message and exit			
<code>--host=host_name</code>	<code>host</code>	Connect to the MySQL server on the given host			
<code>--no-beep</code>	<code>no-beep</code>	Do not beep when errors occur	5.1.17		
<code>-password[=password]</code>	<code>password</code>	The password to use when connecting to the server			
<code>--pipe</code>		On Windows, connect to server via a named pipe			
<code>--port=port_num</code>	<code>port</code>	The TCP/IP port number to use for the connection			
<code>--protocol=type</code>	<code>protocol</code>	The connection protocol to use			
<code>--relative</code>	<code>relative</code>	Show the difference between the current and previous values when used with the <code>--sleep</code> option			
<code>-shutdown_timeout=seconds</code>	<code>shutdown_timeout</code>	The maximum number of seconds to wait for server shutdown			
<code>--silent</code>	<code>silent</code>	Silent mode			
<code>--sleep=delay</code>	<code>sleep</code>	Execute commands repeatedly, sleeping for <code>delay</code> seconds in between			
<code>--socket=path</code>	<code>socket</code>	For connections to localhost			
<code>-ssl-ca=file_name</code>	<code>ssl-ca</code>	The path to a file that contains a list of trusted SSL CAs			
<code>-ssl-capath=directory_name</code>	<code>ssl-capath</code>	The path to a directory that contains trusted SSL CA certificates in PEM format			

Format	Config File	Description	Introduc- tion	Deprec- ated	Removed
- - ssl- cert=file_name	ssl-cert	The name of the SSL certificate file to use for establishing a secure connection			
- - ssl- cipher=cipher_list	ssl-cipher	A list of allowable ciphers to use for SSL encryption			
- - ssl-key=file_name	ssl-key	The name of the SSL key file to use for establishing a secure connection			
- - ssl-veri- fy-server-cert	ssl-veri- fy-server-cert	The server's Common Name value in its certificate is verified against the host name used when connecting to the server			
- -user=user_name,	user	The MySQL user name to use when connecting to the server			
--verbose		Verbose mode			
--version		Display version information and exit			
--vertical	vertical	Print query output rows vertically (one line per column value)			
--wait	wait	If the connection cannot be established, wait and retry instead of aborting			

`mysqladmin` supports the options in the following list. It also reads option files and supports the options for processing them described at [Section 4.2.3.2.1](#), “Command-Line Options that Affect Option-File Handling”.

- `--help, -?`  
Display a help message and exit.
- `--character-sets-dir=path`  
The directory where character sets are installed. See [Section 9.2](#), “The Character Set Used for Data and Sorting”.
- `--compress, -C`  
Compress all information sent between the client and the server if both support compression.
- `--count=N, -c N`  
The number of iterations to make for repeated command execution if the `--sleep` option is given.
- `--debug[=debug_options], -#[debug_options]`  
Write a debugging log. A typical `debug_options` string is `'d:t:o,file_name'`. The default is `'d:t:o,/tmp/mysqladmin.trace'`.
- `--debug-check`  
Print some debugging information when the program exits. This option was added in MySQL 5.1.21.
- `--debug-info`  
Print debugging information and memory and CPU usage statistics when the program exits. This option was added in MySQL 5.1.14.
- `--default-character-set=charset_name`  
Use `charset_name` as the default character set. See [Section 9.2](#), “The Character Set Used for Data and Sorting”.
- `--force, -f`

Do not ask for confirmation for the `drop db_name` command. With multiple commands, continue even if an error occurs.

- `--host=host_name, -h host_name`

Connect to the MySQL server on the given host.

- `--no-beep, -b`

Suppress the warning beep that is emitted by default for errors such as a failure to connect to the server. This option was added in MySQL 5.1.17.

- `--password[=password], -p[password]`

The password to use when connecting to the server. If you use the short option form (`-p`), you *cannot* have a space between the option and the password. If you omit the `password` value following the `--password` or `-p` option on the command line, you are prompted for one.

Specifying a password on the command line should be considered insecure. See [Section 5.5.6.2, “End-User Guidelines for Password Security”](#).

- `--pipe, -W`

On Windows, connect to the server via a named pipe. This option applies only for connections to a local server, and only if the server supports named-pipe connections.

- `--port=port_num, -P port_num`

The TCP/IP port number to use for the connection.

- `--protocol={TCP|SOCKET|PIPE|MEMORY}`

The connection protocol to use for connecting to the server. It is useful when the other connection parameters normally would cause a protocol to be used other than the one you want. For details on the allowable values, see [Section 4.2.2, “Connecting to the MySQL Server”](#).

- `--relative, -r`

Show the difference between the current and previous values when used with the `--sleep` option. Currently, this option works only with the `extended-status` command.

- `--silent, -s`

Exit silently if a connection to the server cannot be established.

- `--sleep=delay, -i delay`

Execute commands repeatedly, sleeping for `delay` seconds in between. The `--count` option determines the number of iterations. If `--count` is not given, `mysqladmin` executes commands indefinitely until interrupted.

- `--socket=path, -S path`

For connections to `localhost`, the Unix socket file to use, or, on Windows, the name of the named pipe to use.

- `--ssl*`

Options that begin with `--ssl` specify whether to connect to the server via SSL and indicate where to find SSL keys and certificates. See [Section 5.5.7.3, “SSL Command Options”](#).

- `--user=user_name, -u user_name`

The MySQL user name to use when connecting to the server.

- `--verbose, -v`

Verbose mode. Print more information about what the program does.

- `--version, -V`

Display version information and exit.

- `--vertical, -E`

Print output vertically. This is similar to `--relative`, but prints output vertically.

- `--wait[=count], -w[count]`

If the connection cannot be established, wait and retry instead of aborting. If a *count* value is given, it indicates the number of times to retry. The default is one time.

You can also set the following variables by using `--var_name=value`. The `--set-variable` format is deprecated. syntax:

- `connect_timeout`

The maximum number of seconds before connection timeout. The default value is 43200 (12 hours).

- `shutdown_timeout`

The maximum number of seconds to wait for server shutdown. The default value is 3600 (1 hour).

### 4.5.3. `mysqlcheck` — A Table Maintenance Program

The `mysqlcheck` client performs table maintenance: It checks, repairs, optimizes, or analyzes tables.

Each table is locked and therefore unavailable to other sessions while it is being processed. Table maintenance operations can be time-consuming, particularly for large tables. If you use the `--databases` or `--all-databases` option to process all tables in one or more databases, an invocation of `mysqlcheck` might take a long time. (This is also true for `mysql_upgrade` because that program invokes `mysqlcheck` to check all tables and repair them if necessary.)

`mysqlcheck` is similar in function to `myisamchk`, but works differently. The main operational difference is that `mysqlcheck` must be used when the `mysqld` server is running, whereas `myisamchk` should be used when it is not. The benefit of using `mysqlcheck` is that you do not have to stop the server to perform table maintenance.

`mysqlcheck` uses the SQL statements `CHECK TABLE`, `REPAIR TABLE`, `ANALYZE TABLE`, and `OPTIMIZE TABLE` in a convenient way for the user. It determines which statements to use for the operation you want to perform, and then sends the statements to the server to be executed. For details about which storage engines each statement works with, see the descriptions for those statements in [Section 12.5.2, “Table Maintenance Statements”](#).

The `MyISAM` storage engine supports all four maintenance operations, so `mysqlcheck` can be used to perform any of them on `MyISAM` tables. Other storage engines do not necessarily support all operations. In such cases, an error message is displayed. For example, if `test.t` is a `MEMORY` table, an attempt to check it produces this result:

```
shell> mysqlcheck test t
test.t
note      : The storage engine for the table doesn't support check
```

If `mysqlcheck` is unable to repair a table, see [Section 2.12.4, “Rebuilding or Repairing Tables or Indexes”](#) for manual table repair strategies. This will be the case, for example, for `InnoDB` tables, which can be checked with `CHECK TABLE`, but not repaired with `REPAIR TABLE`.

The use of `mysqlcheck` with partitioned tables is not supported before MySQL 5.1.27.

#### Caution

It is best to make a backup of a table before performing a table repair operation; under some circumstances the operation might cause data loss. Possible causes include but are not limited to file system errors.

There are three general ways to invoke `mysqlcheck`:

```
shell> mysqlcheck [options] db_name [tables]
shell> mysqlcheck [options] --databases db_name1 [db_name2 db_name3...]
shell> mysqlcheck [options] --all-databases
```

If you do not name any tables following `db_name` or if you use the `--databases` or `--all-databases` option, entire databases are checked.

`mysqlcheck` has a special feature compared to other client programs. The default behavior of checking tables (`--check`) can be changed by renaming the binary. If you want to have a tool that repairs tables by default, you should just make a copy of `mysqlcheck` named `mysqlrepair`, or make a symbolic link to `mysqlcheck` named `mysqlrepair`. If you invoke `mysqlrepair`, it repairs tables.

The following names can be used to change `mysqlcheck` default behavior.

<code>mysqlrepair</code>	The default option is <code>--repair</code>
<code>mysqlanalyze</code>	The default option is <code>--analyze</code>
<code>mysqloptimize</code>	The default option is <code>--optimize</code>

**Table 4.4. `mysqlcheck` Option Reference**

Format	Config File	Description	Introduc- tion	Deprec- ated	Removed
<code>--all-databases</code>	<code>all-databases</code>	Check all tables in all databases			
<code>--all-in-1</code>	<code>all-in-1</code>	Execute a single statement for each database that names all the tables from that database			
<code>--analyze</code>	<code>analyze</code>	Analyze the tables			
<code>--auto-repair</code>	<code>auto-repair</code>	If a checked table is corrupted, automatically fix it			
<code>- -character-sets-dir=path</code>	<code>character-sets-dir</code>	The directory where character sets are installed			
<code>--check</code>	<code>check</code>	Check the tables for errors			
<code>- -check-only-changed</code>	<code>check-only-changed</code>	Check only tables that have changed since the last check			
<code>--check-upgrade</code>	<code>check-upgrade</code>	Invoke CHECK TABLE with the FOR UPGRADE option	5.1.7		
<code>--compress</code>	<code>compress</code>	Compress all information sent between the client and the server			
<code>--databases</code>	<code>databases</code>	Process all tables in the named databases			
<code>- -debug[=debug_options]</code>	<code>debug</code>	Write a debugging log			
<code>--debug-check</code>	<code>debug-check</code>	Print debugging information when the program exits	5.1.21		
<code>--debug-info</code>	<code>debug-info</code>	Print debugging information, memory and CPU statistics when the program exits	5.1.14		
<code>- -default-character-set=charset_name</code>	<code>default-character-set</code>	Use charset_name as the default character set			
<code>--extended</code>	<code>extended</code>	Check and repair tables			
<code>--fast</code>	<code>fast</code>	Check only tables that have not been closed properly			
<code>--fix-db-names</code>	<code>fix-db-names</code>	Convert database names to 5.1 format	5.1.7		
<code>--fix-table-names</code>	<code>fix-table-names</code>	Convert table names to 5.1 format	5.1.7		
<code>--force</code>	<code>force</code>	Continue even if an SQL error occurs			
<code>--help</code>		Display help message and exit			
<code>--host=host_name</code>	<code>host</code>	Connect to the MySQL server on the given host			
<code>--medium-check</code>	<code>medium-check</code>	Do a check that is faster than an <code>--extended</code> operation			
<code>--optimize</code>	<code>optimize</code>	Optimize the tables			
<code>- -password[=password]</code>	<code>password</code>	The password to use when connecting to the server			
<code>--pipe</code>		On Windows, connect to server via a named pipe			



Format	Config File	Description	Introduc- tion	Deprec- ated	Removed
--port=port_num	port	The TCP/IP port number to use for the connection			
--protocol=type	protocol	The connection protocol to use			
--quick	quick	The fastest method of checking			
--repair	repair	Perform a repair that can fix almost anything except unique keys that are not unique			
--silent	silent	Silent mode			
--socket=path	socket	For connections to localhost			
- -ssl-ca=file_name	ssl-ca	The path to a file that contains a list of trusted SSL CAs			
- - ssl- capath=directory_ name	ssl-capath	The path to a directory that contains trusted SSL CA certificates in PEM format			
- - ssl- cert=file_name	ssl-cert	The name of the SSL certificate file to use for establishing a secure connection			
- - ssl- cipher=cipher_list	ssl-cipher	A list of allowable ciphers to use for SSL encryption			
- - ssl-key=file_name	ssl-key	The name of the SSL key file to use for establishing a secure connection			
- - ssl-veri- fy-server-cert	ssl-veri- fy-server-cert	The server's Common Name value in its certificate is verified against the host name used when connecting to the server			
--tables	tables	Overrides the --databases or -B option			
--use-frm	use-frm	For repair operations on MyISAM tables			
- -user=user_name,	user	The MySQL user name to use when connecting to the server			
--verbose		Verbose mode			
--version		Display version information and exit			

`mysqlcheck` supports the options in the following list. It also reads option files and supports the options for processing them described at [Section 4.2.3.2.1, “Command-Line Options that Affect Option-File Handling”](#).

- `--help, -?`

Display a help message and exit.

- `--all-databases, -A`

Check all tables in all databases. This is the same as using the `--databases` option and naming all the databases on the command line.

- `--all-in-1, -1`

Instead of issuing a statement for each table, execute a single statement for each database that names all the tables from that database to be processed.

- `--analyze, -a`

Analyze the tables.

### MySQL Enterprise

For expert advice on optimizing tables, subscribe to the MySQL Enterprise Monitor. For more information,

see <http://www.mysql.com/products/enterprise/advisors.html>.

- `--auto-repair`

If a checked table is corrupted, automatically fix it. Any necessary repairs are done after all tables have been checked.
- `--character-sets-dir=path`

The directory where character sets are installed. See [Section 9.2, “The Character Set Used for Data and Sorting”](#).
- `--check, -c`

Check the tables for errors. This is the default operation.
- `--check-only-changed, -C`

Check only tables that have changed since the last check or that have not been closed properly.
- `--check-upgrade, -g`

Invoke `CHECK TABLE` with the `FOR UPGRADE` option to check tables for incompatibilities with the current version of the server. This option automatically enables the `--fix-db-names` and `--fix-table-names` options. `--check-upgrade` was added in MySQL 5.1.7.
- `--compress`

Compress all information sent between the client and the server if both support compression.
- `--databases, -B`

Process all tables in the named databases. Normally, `mysqlcheck` treats the first name argument on the command line as a database name and following names as table names. With this option, it treats all name arguments as database names.
- `--debug[=debug_options], -# [debug_options]`

Write a debugging log. A typical `debug_options` string is `'d:t:o,file_name'`. The default is `'d:t:o'`.
- `--debug-check`

Print some debugging information when the program exits. This option was added in MySQL 5.1.21.
- `--debug-info`

Print debugging information and memory and CPU usage statistics when the program exits. This option was added in MySQL 5.1.14.
- `--default-character-set=charset_name`

Use `charset_name` as the default character set. See [Section 9.2, “The Character Set Used for Data and Sorting”](#).
- `--extended, -e`

If you are using this option to check tables, it ensures that they are 100% consistent but takes a long time.

If you are using this option to repair tables, it runs an extended repair that may not only take a long time to execute, but may produce a lot of garbage rows also!
- `--fast, -F`

Check only tables that have not been closed properly.
- `--fix-db-names`

Convert database names to 5.1 format. Only database names that contain special characters are affected. This option was added in MySQL 5.1.7.
- `--fix-table-names`

Convert table names to 5.1 format. Only table names that contain special characters are affected. This option was added in MySQL 5.1.7. As of MySQL 5.1.23, this option also applies to views.
- `--force, -f`

Continue even if an SQL error occurs.

- `--host=host_name, -h host_name`

Connect to the MySQL server on the given host.

- `--medium-check, -m`

Do a check that is faster than an `--extended` operation. This finds only 99.99% of all errors, which should be good enough in most cases.

- `--optimize, -o`

Optimize the tables.

- `--password[=password], -p[password]`

The password to use when connecting to the server. If you use the short option form (`-p`), you *cannot* have a space between the option and the password. If you omit the `password` value following the `--password` or `-p` option on the command line, you are prompted for one.

Specifying a password on the command line should be considered insecure. See [Section 5.5.6.2, “End-User Guidelines for Password Security”](#).

- `--pipe, -W`

On Windows, connect to the server via a named pipe. This option applies only for connections to a local server, and only if the server supports named-pipe connections.

- `--port=port_num, -P port_num`

The TCP/IP port number to use for the connection.

- `--protocol={TCP|SOCKET|PIPE|MEMORY}`

The connection protocol to use for connecting to the server. It is useful when the other connection parameters normally would cause a protocol to be used other than the one you want. For details on the allowable values, see [Section 4.2.2, “Connecting to the MySQL Server”](#).

- `--quick, -q`

If you are using this option to check tables, it prevents the check from scanning the rows to check for incorrect links. This is the fastest check method.

If you are using this option to repair tables, it tries to repair only the index tree. This is the fastest repair method.

- `--repair, -r`

Perform a repair that can fix almost anything except unique keys that are not unique.

- `--silent, -s`

Silent mode. Print only error messages.

- `--socket=path, -S path`

For connections to `localhost`, the Unix socket file to use, or, on Windows, the name of the named pipe to use.

- `--ssl*`

Options that begin with `--ssl` specify whether to connect to the server via SSL and indicate where to find SSL keys and certificates. See [Section 5.5.7.3, “SSL Command Options”](#).

- `--tables`

Overrides the `--databases` or `-B` option. All name arguments following the option are regarded as table names.

- `--use-frm`

For repair operations on `MyISAM` tables, get the table structure from the `.frm` file so that the table can be repaired even if the `.MYI` header is corrupted.

- `--user=user_name, -u user_name`

The MySQL user name to use when connecting to the server.

- `--verbose, -v`

Verbose mode. Print information about the various stages of program operation.

- `--version, -V`

Display version information and exit.

## 4.5.4. `mysqldump` — A Database Backup Program

The `mysqldump` client is a backup program originally written by Igor Romanenko. It can be used to dump a database or a collection of databases for backup or transfer to another SQL server (not necessarily a MySQL server). The dump typically contains SQL statements to create the table, populate it, or both. However, `mysqldump` can also be used to generate files in CSV, other delimited text, or XML format.

If you are doing a backup on the server and your tables all are MyISAM tables, consider using the `mysqlhotcopy` instead because it can accomplish faster backups and faster restores. See Section 4.6.9, “`mysqlhotcopy` — A Database Backup Program”.

There are three general ways to invoke `mysqldump`:

```
shell> mysqldump [options] db_name [tables]
shell> mysqldump [options] --databases db_name1 [db_name2 db_name3...]
shell> mysqldump [options] --all-databases
```

If you do not name any tables following `db_name` or if you use the `--databases` or `--all-databases` option, entire databases are dumped.

`mysqldump` does not dump the `INFORMATION_SCHEMA` database. If you name that database explicitly on the command line, `mysqldump` silently ignores it.

To get a list of the options your version of `mysqldump` supports, execute `mysqldump --help`.

Some `mysqldump` options are shorthand for groups of other options. `--opt` and `--compact` fall into this category. For example, use of `--opt` is the same as specifying `--add-drop-table --add-locks --create-options --disable-keys --extended-insert --lock-tables --quick --set-charset`. Note that all of the options that `--opt` stands for also are on by default because `--opt` is on by default.

To reverse the effect of a group option, uses its `--skip-xxx` form (`--skip-opt` or `--skip-compact`). It is also possible to select only part of the effect of a group option by following it with options that enable or disable specific features. Here are some examples:

- To select the effect of `--opt` except for some features, use the `--skip` option for each feature. For example, to disable extended inserts and memory buffering, use `--opt --skip-extended-insert --skip-quick`. (As of MySQL 5.1, `--skip-extended-insert --skip-quick` is sufficient because `--opt` is on by default.)
- To reverse `--opt` for all features except index disabling and table locking, use `--skip-opt --disable-keys --lock-tables`.

When you selectively enable or disable the effect of a group option, order is important because options are processed first to last. For example, `--disable-keys --lock-tables --skip-opt` would not have the intended effect; it is the same as `--skip-opt` by itself.

`mysqldump` can retrieve and dump table contents row by row, or it can retrieve the entire content from a table and buffer it in memory before dumping it. Buffering in memory can be a problem if you are dumping large tables. To dump tables row by row, use the `--quick` option (or `--opt`, which enables `--quick`). The `--opt` option (and hence `--quick`) is enabled by default in MySQL 5.1; to enable memory buffering, use `--skip-quick`.

If you are using a recent version of `mysqldump` to generate a dump to be reloaded into a very old MySQL server, you should not use the `--opt` or `--extended-insert` option. Use `--skip-opt` instead.

### Note

`mysqldump` from the MySQL 5.1.21 distribution cannot be used to create dumps from MySQL server versions 5.1.20 and older. This issue is fixed in MySQL 5.1.22. ([Bug#30123](#))

**Table 4.5. `mysqldump` Option Reference**

Format	Config File	Description	Introduc- tion	Deprec- ated	Removed
- - add-drop-database	add-drop-database	Add a DROP DATABASE statement before each CREATE DATABASE statement			
--add-drop-table	add-drop-table	Add a DROP TABLE statement before each CREATE TABLE statement			
--add-locks	add-locks	Surround each table dump with LOCK TABLES and UNLOCK TABLES statements			
--all-databases	all-databases	Dump all tables in all databases			
--all-tablespaces	all-tablespaces	Adds to a table dump all SQL statements needed to create any tablespaces used by an NDB Cluster table	5.1.6		
--allow-keywords	allow-keywords	Allow creation of column names that are keywords			
--comments	comments	Add comments to the dump file			
--compact	compact	Produce less verbose output			
- -com- pat- ible=name[,name, ...]	compatible	Produce output that is more compatible with other database systems or with older MySQL servers			
--complete-insert	complete-insert	Use complete INSERT statements that include column names			
--create-options	create-options	Include all MySQL-specific table options in the CREATE TABLE statements			
--databases	databases	Dump several databases			
- -de- bug[=debug_optio ns]	debug	Write a debugging log			
--debug-check	debug-check	Print debugging information when the program exits	5.1.21		
--debug-info	debug-info	Print debugging information, memory and CPU statistics when the program exits	5.1.14		
- -de- fault-charac- ter- set=charset_name	default-charac- ter-set	Use charset_name as the default character set			
--delayed-insert	delayed-insert	Write INSERT DELAYED statements rather than INSERT statements			
- -de- lete-master-logs	delete-master-logs	On a master replication server, delete the binary logs after performing the dump operation			
--disable-keys	disable-keys	For each table, surround the INSERT statements with disable and enable keys statements			
--dump-date	dump-date	Include dump date in "Dump completed on" comment if --comments is given	5.1.23		
--events	events	Dump events from the dumped databases	5.1.8		
--extended-insert	extended-insert	Use multiple-row INSERT syntax that include several VALUES lists			
- - fields-en- closed-by=string	fields-enclosed-by	This option is used with the -T option and has the same meaning as the corresponding clause for LOAD DATA INFILE			
-	fields-escaped-by	This option is used with the -T option and has the			

Format	Config File	Description	Introduc- tion	Deprec- ated	Removed
-fields-escaped-by		same meaning as the corresponding clause for LOAD DATA INFILE			
- - fields-option- ally-en- closed-by=string	fields-option- ally-enclosed-by	This option is used with the -T option and has the same meaning as the corresponding clause for LOAD DATA INFILE			
- - fields-ter- minated-by=string	fields-ter- minated-by	This option is used with the -T option and has the same meaning as the corresponding clause for LOAD DATA INFILE			
--lock-all-tables	first-slave	Deprecated. Now renamed to --lock-all-tables			
--flush-logs	flush-logs	Flush the MySQL server log files before starting the dump			
--flush-privileges	flush-privileges	Emit a FLUSH PRIVILEGES statement after dumping the mysql database			
--help		Display help message and exit			
--hex-blob	hex-blob	Dump binary columns using hexadecimal notation (for example, 'abc' becomes 0x616263)			
- -ig- nore-ta- ble=db_name.tbl_ name	ignore-table	Do not dump the given table			
--insert-ignore	insert-ignore	Write INSERT statements with the IGNORE option			
- - lines-ter- minated-by=string	lines-ter- minated-by	This option is used with the -T option and has the same meaning as the corresponding clause for LOAD DATA INFILE			
--lock-all-tables	lock-all-tables	Lock all tables across all databases			
--lock-tables	lock-tables	Lock all tables before dumping them			
- - log-er- ror=file_name	log-error	Append warnings and errors to the named file	5.1.18		
- -mas- ter-data[=value]	master-data	Write the binary log file name and position to the output			
- - max_allowed_pac- ket=value	max_allowed_pac- ket	The maximum packet length to send to or receive from the server			
- - net_buffer_length =value	net_buffer_length	The buffer size for TCP/IP and socket communica- tion			
--no-autocommit	no-autocommit	Enclose the INSERT statements for each dumped table within SET autocommit = 0 and COMMIT statements			
--no-create-db	no-create-db	This option suppresses the CREATE DATABASE statements			
--no-create-info	no-create-info	Do not write CREATE TABLE statements that re- create each dumped table			
--no-data	no-data	Do not write any table row information (that is, do not dump table contents)			
--no-set-names	no-set-names	Turn off complete-insert			
--opt	opt	This option is shorthand; it is the same as specify-			

Format	Config File	Description	Introduc- tion	Deprec- ated	Removed
		ing --add-drop-table --add-locks --create-options - -disable-keys --extended-insert --lock-tables - -quick --set-charset.			
- -order-by-primary	order-by-primary	Sorts each table's rows by its primary key, or by its first unique index			
- -pass- word[=password]	password	The password to use when connecting to the server			
--pipe		On Windows, connect to server via a named pipe			
--port=port_num	port	The TCP/IP port number to use for the connection			
--quick	quick	Retrieve rows for a table from the server a row at a time			
--quote-names	quote-names	Quote database, table, and column names within backtick characters			
--replace	replace	Write REPLACE statements rather than INSERT statements	5.1.3		
--result-file=file	result-file	Direct output to a given file			
--routines	routines	Dump stored routines (procedures and functions) from the dumped databases	5.1.2		
--set-charset	set-charset	Add SET NAMES default_character_set to the output			
- -single-transaction	single-transaction	This option issues a BEGIN SQL statement before dumping data from the server			
- - skip- add-drop-table	skip- add-drop-table	Do not add			
--skip-add-locks	skip-add-locks	Do not add locks			
--skip-comments	skip-comments	Do not add comments to the dump file			
--skip-compact	skip-compact	Turn off compact			
- -skip-disable-keys	skip-disable-keys	Do not disable keys			
- - skip-exten- ded-insert	skip-exten- ded-insert	Turn off extended-insert			
--skip-opt	skip-opt	Turn off the options set by opt			
--skip-quick	skip-quick	Do not retrieve rows for a table from the server a row at a time			
- -skip-quote-names	skip-quote-names	Turn off quote names			
--skip-set-charset	skip-set-charset	Suppress the SET NAMES statement			
--skip-triggers	skip-triggers	Turn off triggers			
--skip-tz-utc	skip-tz-utc	Turn off tz-utc	5.1.2		
- -ssl-ca=file_name	ssl-ca	The path to a file that contains a list of trusted SSL CAs			
- - ssl- capath=directory_ name	ssl-capath	The path to a directory that contains trusted SSL CA certificates in PEM format			
- - ssl- cert=file_name	ssl-cert	The name of the SSL certificate file to use for es- tablishing a secure connection			
-	ssl-cipher	A list of allowable ciphers to use for SSL encryp-			



Format	Config File	Description	Introduc- tion	Deprec- ated	Removed
- ssl- cipher=cipher_list		tion			
- ssl-key=file_name	ssl-key	The name of the SSL key file to use for establish- ing a secure connection			
- ssl-veri- fy-server-cert	ssl-veri- fy-server-cert	The server's Common Name value in its certificate is verified against the host name used when con- necting to the server			
--tab=path	tab	Produce tab-separated data files			
--tables	tables	Override the --databases or -B option			
--triggers	triggers	Dump triggers for each dumped table			
--tz-utc	tz-utc	Add SET TIME_ZONE='+00:00' to the dump file	5.1.2		
--verbose		Verbose mode			
--version		Display version information and exit			
- where='where_co ndition'	where	Dump only rows selected by the given WHERE condition			
--xml	xml	Produce XML output			

`mysqldump` supports the options in the following list. It also reads option files and supports the options for processing them described at [Section 4.2.3.2.1, “Command-Line Options that Affect Option-File Handling”](#).

- `--help, -?`  
Display a help message and exit.
- `--add-drop-database`  
Add a `DROP DATABASE` statement before each `CREATE DATABASE` statement.
- `--add-drop-table`  
Add a `DROP TABLE` statement before each `CREATE TABLE` statement.
- `--add-locks`  
Surround each table dump with `LOCK TABLES` and `UNLOCK TABLES` statements. This results in faster inserts when the dump file is reloaded. See [Section 7.2.21, “Speed of INSERT Statements”](#).
- `--all-databases, -A`  
Dump all tables in all databases. This is the same as using the `--databases` option and naming all the databases on the command line.
- `--all-tablespaces, -Y`  
Adds to a table dump all SQL statements needed to create any tablespaces used by an `NDBCLUSTER` table. This information is not otherwise included in the output from `mysqldump`. This option is currently relevant only to MySQL Cluster tables.  
  
This option was added in MySQL 5.1.6.
- `--allow-keywords`  
Allow creation of column names that are keywords. This works by prefixing each column name with the table name.
- `--character-sets-dir=path`  
The directory where character sets are installed. See [Section 9.2, “The Character Set Used for Data and Sorting”](#).
- `--comments, -i`

Write additional information in the dump file such as program version, server version, and host. This option is enabled by default. To suppress this additional information, use `--skip-comments`.

- `--compact`

Produce less verbose output. This option enables the `--skip-add-drop-table`, `--skip-add-locks`, `--skip-comments`, `--skip-disable-keys`, and `--skip-set-charset` options.

### Note

Prior to release 5.1.21, this option did not create valid SQL if the database dump contained views. The recreation of views requires the creation and removal of temporary tables and this option suppressed the removal of those temporary tables. As a workaround, use `--compact` with the `--add-drop-table` option and then manually adjust the dump file.

- `--compatible=name`

Produce output that is more compatible with other database systems or with older MySQL servers. The value of `name` can be `ansi`, `mysql323`, `mysql40`, `postgresql`, `oracle`, `mssql`, `db2`, `maxdb`, `no_key_options`, `no_table_options`, or `no_field_options`. To use several values, separate them by commas. These values have the same meaning as the corresponding options for setting the server SQL mode. See [Section 5.1.7, “Server SQL Modes”](#).

This option does not guarantee compatibility with other servers. It only enables those SQL mode values that are currently available for making dump output more compatible. For example, `--compatible=oracle` does not map data types to Oracle types or use Oracle comment syntax.

*This option requires a server version of 4.1.0 or higher. With older servers, it does nothing.*

- `--complete-insert, -c`

Use complete `INSERT` statements that include column names.

- `--compress, -C`

Compress all information sent between the client and the server if both support compression.

- `--create-options`

Include all MySQL-specific table options in the `CREATE TABLE` statements.

- `--databases, -B`

Dump several databases. Normally, `mysqldump` treats the first name argument on the command line as a database name and following names as table names. With this option, it treats all name arguments as database names. `CREATE DATABASE` and `USE` statements are included in the output before each new database.

- `--debug[=debug_options], -# [debug_options]`

Write a debugging log. A typical `debug_options` string is `'d:t:o,file_name'`. The default value is `'d:t:o,/tmp/mysqldump.trace'`.

- `--debug-check`

Print some debugging information when the program exits. This option was added in MySQL 5.1.21.

- `--debug-info`

Print debugging information and memory and CPU usage statistics when the program exits. This option was added in MySQL 5.1.14.

- `--default-character-set=charset_name`

Use `charset_name` as the default character set. See [Section 9.2, “The Character Set Used for Data and Sorting”](#). If no character set is specified, `mysqldump` uses `utf8`, and earlier versions use `latin1`.

This option has no effect for output data files produced by using the `--tab` option. See the description for that option.

- `--delayed-insert`

Write `INSERT DELAYED` statements rather than `INSERT` statements.

- `--delete-master-logs`

On a master replication server, delete the binary logs after performing the dump operation. This option automatically enables `--master-data`.

- `--disable-keys, -K`

For each table, surround the `INSERT` statements with `/*!40000 ALTER TABLE tbl_name DISABLE KEYS */;` and `/*!40000 ALTER TABLE tbl_name ENABLE KEYS */;` statements. This makes loading the dump file faster because the indexes are created after all rows are inserted. This option is effective only for non-unique indexes of `MyISAM` tables.

- `--dump-date`

`mysqldump` produces a `-- Dump completed on DATE` comment at the end of the dump if the `--comments` option is given. However, the date causes dump files for identical data taken at different times to appear to be different. `--dump-date` and `--skip-dump-date` control whether the date is added to the comment. The default is `--dump-date` (include the date in the comment). `--skip-dump-date` suppresses date printing. This option was added in MySQL 5.1.23.

- `--events, -E`

Dump events from the dumped databases. This option was added in MySQL 5.1.8.

- `--extended-insert, -e`

Use multiple-row `INSERT` syntax that include several `VALUES` lists. This results in a smaller dump file and speeds up inserts when the file is reloaded.

- `--fields-terminated-by=..., --fields-enclosed-by=..., --fields-optionally-enclosed-by=..., --fields-escaped-by=...`

These options are used with the `-T` option and have the same meaning as the corresponding clauses for `LOAD DATA INFILE`. See [Section 12.2.6, “LOAD DATA INFILE Syntax”](#).

- `--first-slave, -x`

Deprecated. Now renamed to `--lock-all-tables`.

- `--flush-logs, -F`

Flush the MySQL server log files before starting the dump. This option requires the `RELOAD` privilege. Note that if you use this option in combination with the `--all-databases` (or `-A`) option, the logs are flushed *for each database dumped*. The exception is when using `--lock-all-tables` or `--master-data`: In this case, the logs are flushed only once, corresponding to the moment that all tables are locked. If you want your dump and the log flush to happen at exactly the same moment, you should use `--flush-logs` together with either `--lock-all-tables` or `--master-data`.

- `--flush-privileges`

Emit a `FLUSH PRIVILEGES` statement after dumping the `mysql` database. This option should be used any time the dump contains the `mysql` database and any other database that depends on the data in the `mysql` database for proper restoration. This option was added in MySQL 5.1.12.

- `--force, -f`

Continue even if an SQL error occurs during a table dump.

One use for this option is to cause `mysqldump` to continue executing even when it encounters a view that has become invalid because the definition refers to a table that has been dropped. Without `--force`, `mysqldump` exits with an error message. With `--force`, `mysqldump` prints the error message, but it also writes an SQL comment containing the view definition to the dump output and continues executing.

- `--host=host_name, -h host_name`

Dump data from the MySQL server on the given host. The default host is `localhost`.

- `--hex-blob`

Dump binary columns using hexadecimal notation (for example, `'abc'` becomes `0x616263`). The affected data types are `BINARY`, `VARBINARY`, `BLOB`, and `BIT`.

- `--ignore-table=db_name.tbl_name`

Do not dump the given table, which must be specified using both the database and table names. To ignore multiple tables, use this option multiple times. This option also can be used to ignore views.

- `--insert-ignore`

Write `INSERT` statements with the `IGNORE` option.

- `--lines-terminated-by=...`

This option is used with the `-T` option and has the same meaning as the corresponding clause for `LOAD DATA INFILE`. See Section 12.2.6, “`LOAD DATA INFILE` Syntax”.

- `--lock-all-tables, -x`

Lock all tables across all databases. This is achieved by acquiring a global read lock for the duration of the whole dump. This option automatically turns off `--single-transaction` and `--lock-tables`.

- `--lock-tables, -l`

Lock all tables before dumping them. The tables are locked with `READ LOCAL` to allow concurrent inserts in the case of `MyISAM` tables. For transactional tables such as `InnoDB` and `BDB`, `--single-transaction` is a much better option, because it does not need to lock the tables at all.

Please note that when dumping multiple databases, `--lock-tables` locks tables for each database separately. Therefore, this option does not guarantee that the tables in the dump file are logically consistent between databases. Tables in different databases may be dumped in completely different states.

- `--log-error=file_name`

Append warnings and errors to the named file. This option was added in MySQL 5.1.18.

- `--master-data[=value]`

Use this option to dump a master replication server to produce a dump file that can be used to set up another server as a slave of the master. It causes the dump output to include a `CHANGE MASTER TO` statement that indicates the binary log coordinates (file name and position) of the dumped server. These are the master server coordinates from which the slave should start replicating.

If the option value is 2, the `CHANGE MASTER TO` statement is written as an SQL comment, and thus is informative only; it has no effect when the dump file is reloaded. If the option value is 1, the statement takes effect when the dump file is reloaded. If the option value is not specified, the default value is 1.

This option requires the `RELOAD` privilege and the binary log must be enabled.

The `--master-data` option automatically turns off `--lock-tables`. It also turns on `--lock-all-tables`, unless `--single-transaction` also is specified, in which case, a global read lock is acquired only for a short time at the beginning of the dump (see the description for `--single-transaction`). In all cases, any action on logs happens at the exact moment of the dump.

It is also possible to set up a slave by dumping an existing slave of the master. To do this, use the following procedure on the existing slave:

1. Stop the slave's SQL thread and get its current status:

```
mysql> STOP SLAVE SQL_THREAD;
mysql> SHOW SLAVE STATUS;
```

2. From the output of the `SHOW SLAVE STATUS` statement, get the binary log coordinates of the master server from which the new slave should start replicating. These coordinates are the values of the `Relay_Master_Log_File` and `Exec_Master_Log_Pos` values. Denote those values as `file_name` and `file_pos`.

3. Dump the slave server:

```
shell> mysqldump --master-data=2 --all-databases > dumpfile
```

4. Restart the slave:

```
mysql> START SLAVE;
```

- On the new slave, reload the dump file:

```
shell> mysql < dumpfile
```

- On the new slave, set the replication coordinates to those of the master server obtained earlier:

```
mysql> CHANGE MASTER TO
-> MASTER_LOG_FILE = 'file_name', MASTER_LOG_POS = file_pos;
```

The `CHANGE MASTER TO` statement might also need other parameters, such as `MASTER_HOST` to point the slave to the correct master server host. Add any such parameters as necessary.

- `--no-autocommit`

Enclose the `INSERT` statements for each dumped table within `SET autocommit = 0` and `COMMIT` statements.

- `--no-create-db, -n`

This option suppresses the `CREATE DATABASE` statements that are otherwise included in the output if the `--databases` or `--all-databases` option is given.

- `--no-create-info, -t`

Do not write `CREATE TABLE` statements that re-create each dumped table.

- `--no-data, -d`

Do not write any table row information (that is, do not dump table contents). This is very useful if you want to dump only the `CREATE TABLE` statement for the table.

- `--no-set-names`

This option is deprecated. Use `--skip-set-charset`. instead.

- `--opt`

This option is shorthand; it is the same as specifying `--add-drop-table --add-locks --create-options --disable-keys --extended-insert --lock-tables --quick --set-charset`. It should give you a fast dump operation and produce a dump file that can be reloaded into a MySQL server quickly.

*The `--opt` option is enabled by default. Use `--skip-opt` to disable it.* See the discussion at the beginning of this section for information about selectively enabling or disabling certain of the options affected by `--opt`.

- `--order-by-primary`

Sorts each table's rows by its primary key, or by its first unique index, if such an index exists. This is useful when dumping a `MyISAM` table to be loaded into an `InnoDB` table, but will make the dump itself take considerably longer.

- `--password[=password], -p[password]`

The password to use when connecting to the server. If you use the short option form (`-p`), you *cannot* have a space between the option and the password. If you omit the *password* value following the `--password` or `-p` option on the command line, you are prompted for one.

Specifying a password on the command line should be considered insecure. See [Section 5.5.6.2, “End-User Guidelines for Password Security”](#).

- `--pipe, -W`

On Windows, connect to the server via a named pipe. This option applies only for connections to a local server, and only if the server supports named-pipe connections.

- `--port=port_num, -P port_num`

The TCP/IP port number to use for the connection.

- `--protocol={TCP|SOCKET|PIPE|MEMORY}`

The connection protocol to use for connecting to the server. It is useful when the other connection parameters normally would cause a protocol to be used other than the one you want. For details on the allowable values, see [Section 4.2.2, “Connecting to](#)

the MySQL Server”.

- `--quick, -q`

This option is useful for dumping large tables. It forces `mysqldump` to retrieve rows for a table from the server a row at a time rather than retrieving the entire row set and buffering it in memory before writing it out.

- `--quote-names, -Q`

Quote database, table, and column names within “`” characters. If the `ANSI_QUOTES` SQL mode is enabled, names are quoted within “” characters. This option is enabled by default. It can be disabled with `--skip-quote-names`, but this option should be given after any option such as `--compatible` that may enable `--quote-names`.

- `--replace`

Write `REPLACE` statements rather than `INSERT` statements. Available as of MySQL 5.1.3.

- `--result-file=file_name, -r file_name`

Direct output to a given file. This option should be used on Windows to prevent newline “\n” characters from being converted to “\r\n” carriage return/newline sequences. The result file is created and its contents overwritten, even if an error occurs while generating the dump. The previous contents are lost.

- `--routines, -R`

Dump stored routines (procedures and functions) from the dumped databases. Use of this option requires the `SELECT` privilege for the `mysql.proc` table. The output generated by using `--routines` contains `CREATE PROCEDURE` and `CREATE FUNCTION` statements to re-create the routines. However, these statements do not include attributes such as the routine creation and modification timestamps. This means that when the routines are reloaded, they will be created with the timestamps equal to the reload time.

If you require routines to be re-created with their original timestamp attributes, do not use `--routines`. Instead, dump and reload the contents of the `mysql.proc` table directly, using a MySQL account that has appropriate privileges for the `mysql` database.

This option was added in MySQL 5.1.2. Before that, stored routines are not dumped. Routine `DEFINER` values are not dumped until MySQL 5.1.8. This means that before 5.1.8, when routines are reloaded, they will be created with the definer set to the reloading user. If you require routines to be re-created with their original definer, dump and load the contents of the `mysql.proc` table directly as described earlier.

- `--set-charset`

Add `SET NAMES default_character_set` to the output. This option is enabled by default. To suppress the `SET NAMES` statement, use `--skip-set-charset`.

- `--single-transaction`

This option issues a `BEGIN` SQL statement before dumping data from the server. It is useful only with transactional tables such as `InnoDB`, because then it dumps the consistent state of the database at the time when `BEGIN` was issued without blocking any applications.

When using this option, you should keep in mind that only `InnoDB` tables are dumped in a consistent state. For example, any `MyISAM` or `MEMORY` tables dumped while using this option may still change state.

While a `--single-transaction` dump is in process, to ensure a valid dump file (correct table contents and binary log position), no other connection should use the following statements: `ALTER TABLE`, `DROP TABLE`, `RENAME TABLE`, `TRUNCATE TABLE`. A consistent read is not isolated from those statements, so use of them on a table to be dumped can cause the `SELECT` performed by `mysqldump` to retrieve the table contents to obtain incorrect contents or fail.

This option is not supported for MySQL Cluster tables; the results cannot be guaranteed to be consistent due to the fact that the `NDBCLUSTER` storage engine supports only the `READ_COMMITTED` transaction isolation level. You should always use `NDB` backup and restore instead.

The `--single-transaction` option and the `--lock-tables` option are mutually exclusive, because `LOCK TABLES` causes any pending transactions to be committed implicitly.

To dump large tables, you should combine this option with `--quick`.

- `--skip-comments`

See the description for the `--comments` option.

- `--skip-opt`

See the description for the `--opt` option.

- `--socket=path, -S path`

For connections to `localhost`, the Unix socket file to use, or, on Windows, the name of the named pipe to use.

- `--ssl*`

Options that begin with `--ssl` specify whether to connect to the server via SSL and indicate where to find SSL keys and certificates. See [Section 5.5.7.3, “SSL Command Options”](#).

- `--tab=path, -T path`

Produce tab-separated data files. For each dumped table, `mysqldump` creates a `tbl_name.sql` file that contains the `CREATE TABLE` statement that creates the table, and a `tbl_name.txt` file that contains its data. The option value is the directory in which to write the files.

By default, the `.txt` data files are formatted using tab characters between column values and a newline at the end of each line. The format can be specified explicitly using the `--fields-xxx` and `--lines-terminated-by` options.

Column values are dumped using the `binary` character set and the `--default-character-set` option is ignored. In effect, there is no character set conversion. If a table contains columns in several character sets, the output data file will as well and you may not be able to reload the file correctly.

### Note

This option should be used only when `mysqldump` is run on the same machine as the `mysqld` server. You must have the `FILE` privilege, and the server must have permission to write files in the directory that you specify.

- `--tables`

Override the `--databases` or `-B` option. `mysqldump` regards all name arguments following the option as table names.

- `--triggers`

Dump triggers for each dumped table. This option is enabled by default; disable it with `--skip-triggers`.

- `--tz-utc`

This option enables `TIMESTAMP` columns to be dumped and reloaded between servers in different time zones. `mysqldump` sets its connection time zone to UTC and adds `SET TIME_ZONE= '+00:00'` to the dump file. Without this option, `TIMESTAMP` columns are dumped and reloaded in the time zones local to the source and destination servers, which can cause the values to change. `--tz-utc` also protects against changes due to daylight saving time. `--tz-utc` is enabled by default. To disable it, use `--skip-tz-utc`. This option was added in MySQL 5.1.2.

- `--user=user_name, -u user_name`

The MySQL user name to use when connecting to the server.

- `--verbose, -v`

Verbose mode. Print more information about what the program does.

- `--version, -V`

Display version information and exit.

- `--where='where_condition', -w 'where_condition'`

Dump only rows selected by the given `WHERE` condition. Quotes around the condition are mandatory if it contains spaces or other characters that are special to your command interpreter.

Examples:

```
--where="user='jimf' "
-w"userid>1"
-w"userid<1"
```

- `--xml, -X`



Write dump output as well-formed XML.

**NULL, 'NULL', and Empty Values:** For some column named *column\_name*, the NULL value, an empty string, and the string value 'NULL' are distinguished from one another in the output generated by this option as follows.

Value:	XML Representation:
NULL ( <i>unknown value</i> )	<code>&lt;field name="column_name" xsi:nil="true" /&gt;</code>
' ' ( <i>empty string</i> )	<code>&lt;field name="column_name"&gt;&lt;/field&gt;</code>
'NULL' ( <i>string value</i> )	<code>&lt;field name="column_name"&gt;NULL&lt;/field&gt;</code>

Beginning with MySQL 5.1.12, the output from the `mysql` client when run using the `--xml` option also follows these rules. (See [Section 4.5.1.1, “mysql Options”](#).)

Beginning with MySQL 5.1.18, XML output from `mysqldump` includes the XML namespace, as shown here:

```
shell> mysqldump --xml -u root world City
<?xml version="1.0"?>
<mysqldump xmlns:xsi="http://www.w3.org/2001/XMLSchema-instance">
  <database name="world">
    <table_structure name="City">
      <field Field="ID" Type="int(11)" Null="NO" Key="PRI" Extra="auto_increment" />
      <field Field="Name" Type="char(35)" Null="NO" Key="" Default="" Extra="" />
      <field Field="CountryCode" Type="char(3)" Null="NO" Key="" Default="" Extra="" />
      <field Field="District" Type="char(20)" Null="NO" Key="" Default="" Extra="" />
      <field Field="Population" Type="int(11)" Null="NO" Key="" Default="0" Extra="" />
      <key Table="City" Non_unique="0" Key_name="PRIMARY" Seq_in_index="1" Column_name="ID" Collation="A" Cardinality="4080" Null="" Index_type="BTREE" Comment="" />
      <options Name="City" Engine="MyISAM" Version="10" Row_format="Fixed" Rows="4079" Avg_row_length="67" Data_length="273" Max_data_length="18858823439613951" Index_length="43008" Data_free="0" Auto_increment="4080" Create_time="2007-03-31 01:47:02" Collation="latin1_swedish_ci" Create_options="" Comment="" />
    </table_structure>
    <table_data name="City">
      <row>
        <field name="ID">1</field>
        <field name="Name">Kabul</field>
        <field name="CountryCode">AFG</field>
        <field name="District">Kabul</field>
        <field name="Population">1780000</field>
      </row>
      ...
      <row>
        <field name="ID">4079</field>
        <field name="Name">Rafah</field>
        <field name="CountryCode">PSE</field>
        <field name="District">Rafah</field>
        <field name="Population">92020</field>
      </row>
    </table_data>
  </database>
</mysqldump>
```

You can also set the following variables by using `--var_name=value` syntax:

- `max_allowed_packet`

The maximum size of the buffer for client/server communication. The maximum is 1GB.

- `net_buffer_length`

The initial size of the buffer for client/server communication. When creating multiple-row-insert statements (as with option `--extended-insert` or `--opt`), `mysqldump` creates rows up to `net_buffer_length` length. If you increase this variable, you should also ensure that the `net_buffer_length` variable in the MySQL server is at least this large.

The most common use of `mysqldump` is probably for making a backup of an entire database:

```
shell> mysqldump db_name > backup-file.sql
```

You can read the dump file back into the server like this:

```
shell> mysql db_name < backup-file.sql
```

Or like this:

```
shell> mysql -e "source /path-to-backup/backup-file.sql" db_name
```

`mysqldump` is also very useful for populating databases by copying data from one MySQL server to another:

```
shell> mysqldump --opt db_name | mysql --host=remote_host -C db_name
```

It is possible to dump several databases with one command:

```
shell> mysqldump --databases db_name1 [db_name2 ...] > my_databases.sql
```

To dump all databases, use the `--all-databases` option:

```
shell> mysqldump --all-databases > all_databases.sql
```

For InnoDB tables, `mysqldump` provides a way of making an online backup:

```
shell> mysqldump --all-databases --single-transaction > all_databases.sql
```

This backup acquires a global read lock on all tables (using `FLUSH TABLES WITH READ LOCK`) at the beginning of the dump. As soon as this lock has been acquired, the binary log coordinates are read and the lock is released. If long updating statements are running when the `FLUSH` statement is issued, the MySQL server may get stalled until those statements finish. After that, the dump becomes lock-free and does not disturb reads and writes on the tables. If the update statements that the MySQL server receives are short (in terms of execution time), the initial lock period should not be noticeable, even with many updates.

For point-in-time recovery (also known as “roll-forward,” when you need to restore an old backup and replay the changes that happened since that backup), it is often useful to rotate the binary log (see [Section 5.2.4, “The Binary Log”](#)) or at least know the binary log coordinates to which the dump corresponds:

```
shell> mysqldump --all-databases --master-data=2 > all_databases.sql
```

Or:

```
shell> mysqldump --all-databases --flush-logs --master-data=2
> all_databases.sql
```

The `--master-data` and `--single-transaction` options can be used simultaneously, which provides a convenient way to make an online backup suitable for point-in-time recovery if tables are stored using the InnoDB storage engine.

For more information on making backups, see [Section 6.1, “Database Backups”](#), and [Section 6.2, “Example Backup and Recovery Strategy”](#).

If you encounter problems backing up views, please read the section that covers restrictions on views which describes a work-around for backing up views when this fails due to insufficient privileges. See [Section D.4, “Restrictions on Views”](#).

#### MySQL Enterprise

MySQL Enterprise subscribers will find more information about `mysqldump` in the Knowledge Base article, [How Can I Avoid Inserting Duplicate Rows From a Dump File?](#). Access to the MySQL Knowledge Base collection of articles is one of the advantages of subscribing to MySQL Enterprise. For more information, see <http://www.mysql.com/products/enterprise/advisors.html>.

## 4.5.5. `mysqlimport` — A Data Import Program

The `mysqlimport` client provides a command-line interface to the `LOAD DATA INFILE` SQL statement. Most options to `mysqlimport` correspond directly to clauses of `LOAD DATA INFILE` syntax. See [Section 12.2.6, “LOAD DATA INFILE Syntax”](#).

Invoke `mysqlimport` like this:

```
shell> mysqlimport [options] db_name textfile1 [textfile2 ...]
```

For each text file named on the command line, `mysqlimport` strips any extension from the file name and uses the result to determine the name of the table into which to import the file's contents. For example, files named `patient.txt`, `patient.text`, and `patient` all would be imported into a table named `patient`.

Table 4.6. `mysqlimport` Option Reference

Format	Config File	Description	Introduc- tion	Deprec- ated	Removed
- - columns=column _list	columns	This option takes a comma-separated list of column names as its value			
--compress	compress	Compress all information sent between the client and the server			
- -de- bug[=debug_optio ns]	debug	Write a debugging log			
--debug-check	debug-check	Print debugging information when the program exits	5.1.21		
--debug-info	debug-info	Print debugging information, memory and CPU statistics when the program exits	5.1.14		
- -de- fault-charac- ter- set=charset_name	default-charac- ter-set	Use charset_name as the default character set			
--delete	delete	Empty the table before importing the text file			
- - fields-en- closed-by=string	fields-enclosed-by	This option has the same meaning as the corresponding clause for LOAD DATA INFILE			
- -fields-escaped-by	fields-escaped-by	This option has the same meaning as the corresponding clause for LOAD DATA INFILE			
- - fields-option- ally-en- closed-by=string	fields-option- ally-en- closed-by	This option has the same meaning as the corresponding clause for LOAD DATA INFILE			
- - fields-ter- minated-by=string	fields-ter- minated-by	-- This option has the same meaning as the corresponding clause for LOAD DATA INFILE			
--force	force	Continue even if an SQL error occurs			
--help		Display help message and exit			
--host=host_name	host	Connect to the MySQL server on the given host			
--ignore	ignore	See the description for the --replace option			
--ignore-lines=#	ignore-lines	Ignore the first N lines of the data file			
- - lines-ter- minated-by=string	lines-ter- minated-by	This option has the same meaning as the corresponding clause for LOAD DATA INFILE			
--local	local	Read input files locally from the client host			
--lock-tables	lock-tables	Lock all tables for writing before processing any text files			
--low-priority	low-priority	Use LOW_PRIORITY when loading the table.			
- -pass- word[=password]	password	The password to use when connecting to the server			
--pipe		On Windows, connect to server via a named pipe			
--port=port_num	port	The TCP/IP port number to use for the connection			
--protocol=type	protocol	The connection protocol to use			

Format	Config File	Description	Introduc- tion	Deprec- ated	Removed
<code>--replace</code>	<code>replace</code>	The <code>--replace</code> and <code>--ignore</code> options control handling of input rows that duplicate existing rows on unique key values			
<code>--silent</code>	<code>silent</code>	Produce output only when errors occur			
<code>--socket=path</code>	<code>socket</code>	For connections to localhost			
<code>- -ssl-ca=file_name</code>	<code>ssl-ca</code>	The path to a file that contains a list of trusted SSL CAs			
<code>- - ssl- capath=directory_ name</code>	<code>ssl-capath</code>	The path to a directory that contains trusted SSL CA certificates in PEM format			
<code>- - ssl- cert=file_name</code>	<code>ssl-cert</code>	The name of the SSL certificate file to use for establishing a secure connection			
<code>- - ssl- cipher=cipher_list</code>	<code>ssl-cipher</code>	A list of allowable ciphers to use for SSL encryption			
<code>- - ssl-key=file_name</code>	<code>ssl-key</code>	The name of the SSL key file to use for establishing a secure connection			
<code>- - ssl-veri- fy-server-cert</code>	<code>ssl-veri- fy-server-cert</code>	The server's Common Name value in its certificate is verified against the host name used when connecting to the server			
<code>--use-threads=#</code>	<code>use-threads</code>	The number of threads for parallel file-loading	5.1.7		
<code>- -user=user_name,</code>	<code>user</code>	The MySQL user name to use when connecting to the server			
<code>--verbose</code>		Verbose mode			
<code>--version</code>		Display version information and exit			

`mysqlimport` supports the options in the following list. It also reads option files and supports the options for processing them described at [Section 4.2.3.2.1, “Command-Line Options that Affect Option-File Handling”](#).

- `--help, -?`  
Display a help message and exit.
- `--character-sets-dir=path`  
The directory where character sets are installed. See [Section 9.2, “The Character Set Used for Data and Sorting”](#).
- `--columns=column_list, -c column_list`  
This option takes a comma-separated list of column names as its value. The order of the column names indicates how to match data file columns with table columns.
- `--compress, -C`  
Compress all information sent between the client and the server if both support compression.
- `--debug[=debug_options], -# [debug_options]`  
Write a debugging log. A typical `debug_options` string is `'d:t:o,file_name'`. The default is `'d:t:o'`.
- `--debug-check`  
Print some debugging information when the program exits. This option was added in MySQL 5.1.21.

- `--debug-info`  
Print debugging information and memory and CPU usage statistics when the program exits. This option was added in MySQL 5.1.14.
- `--default-character-set=charset_name`  
Use *charset\_name* as the default character set. See [Section 9.2, “The Character Set Used for Data and Sorting”](#).
- `--delete, -D`  
Empty the table before importing the text file.
- `--fields-terminated-by=..., --fields-enclosed-by=..., --fields-optionally-enclosed-by=..., --fields-escaped-by=...`  
These options have the same meaning as the corresponding clauses for `LOAD DATA INFILE`. See [Section 12.2.6, “LOAD DATA INFILE Syntax”](#).
- `--force, -f`  
Ignore errors. For example, if a table for a text file does not exist, continue processing any remaining files. Without `--force`, `mysqlimport` exits if a table does not exist.
- `--host=host_name, -h host_name`  
Import data to the MySQL server on the given host. The default host is `localhost`.
- `--ignore, -i`  
See the description for the `--replace` option.
- `--ignore-lines=N`  
Ignore the first *N* lines of the data file.
- `--lines-terminated-by=...`  
This option has the same meaning as the corresponding clause for `LOAD DATA INFILE`. For example, to import Windows files that have lines terminated with carriage return/linefeed pairs, use `--lines-terminated-by="\r\n"`. (You might have to double the backslashes, depending on the escaping conventions of your command interpreter.) See [Section 12.2.6, “LOAD DATA INFILE Syntax”](#).
- `--local, -L`  
Read input files locally from the client host.  

**MySQL Enterprise**  
For expert advice on the security implications of enabling `LOCAL`, subscribe to the MySQL Enterprise Monitor. For more information, see <http://www.mysql.com/products/enterprise/advisors.html>.
- `--lock-tables, -l`  
Lock *all* tables for writing before processing any text files. This ensures that all tables are synchronized on the server.
- `--low-priority`  
Use `LOW_PRIORITY` when loading the table. This affects only storage engines that use only table-level locking (`MyISAM`, `MEMORY`, `MERGE`).
- `--password[=password], -p[password]`  
The password to use when connecting to the server. If you use the short option form (`-p`), you *cannot* have a space between the option and the password. If you omit the *password* value following the `--password` or `-p` option on the command line, you are prompted for one.  
Specifying a password on the command line should be considered insecure. See [Section 5.5.6.2, “End-User Guidelines for Password Security”](#).
- `--pipe, -W`

On Windows, connect to the server via a named pipe. This option applies only for connections to a local server, and only if the server supports named-pipe connections.

- `--port=port_num, -P port_num`

The TCP/IP port number to use for the connection.

- `--protocol={TCP|SOCKET|PIPE|MEMORY}`

The connection protocol to use for connecting to the server. It is useful when the other connection parameters normally would cause a protocol to be used other than the one you want. For details on the allowable values, see [Section 4.2.2, “Connecting to the MySQL Server”](#).

- `--replace, -r`

The `--replace` and `--ignore` options control handling of input rows that duplicate existing rows on unique key values. If you specify `--replace`, new rows replace existing rows that have the same unique key value. If you specify `--ignore`, input rows that duplicate an existing row on a unique key value are skipped. If you do not specify either option, an error occurs when a duplicate key value is found, and the rest of the text file is ignored.

- `--silent, -s`

Silent mode. Produce output only when errors occur.

- `--socket=path, -S path`

For connections to `localhost`, the Unix socket file to use, or, on Windows, the name of the named pipe to use.

- `--ssl*`

Options that begin with `--ssl` specify whether to connect to the server via SSL and indicate where to find SSL keys and certificates. See [Section 5.5.7.3, “SSL Command Options”](#).

- `--user=user_name, -u user_name`

The MySQL user name to use when connecting to the server.

- `--use-threads=N`

Load files in parallel using *N* threads. This option was added in MySQL 5.1.7.

- `--verbose, -v`

Verbose mode. Print more information about what the program does.

- `--version, -V`

Display version information and exit.

Here is a sample session that demonstrates use of `mysqlimport`:

```
shell> mysql -e 'CREATE TABLE impptest(id INT, n VARCHAR(30))' test
shell> ed
a
100      Max Sydow
101      Count Dracula
.
w impptest.txt
32
q
shell> od -c impptest.txt
0000000  1  0  0  \t  M  a  x           S  y  d  o  w  \n  1  0
0000020  1  \t  C  o  u  n  t           D  r  a  c  u  l  a  \n
0000040
shell> mysqlimport --local test impptest.txt
test. impptest: Records: 2 Deleted: 0 Skipped: 0 Warnings: 0
shell> mysql -e 'SELECT * FROM impptest' test
+-----+-----+
| id  | n                |
+-----+-----+
| 100 | Max Sydow        |
| 101 | Count Dracula    |
+-----+-----+
```

## 4.5.6. `mysqlshow` — Display Database, Table, and Column Information

The `mysqlshow` client can be used to quickly see which databases exist, their tables, or a table's columns or indexes.

`mysqlshow` provides a command-line interface to several SQL `SHOW` statements. See [Section 12.5.5, “SHOW Syntax”](#). The same information can be obtained by using those statements directly. For example, you can issue them from the `mysql` client program.

Invoke `mysqlshow` like this:

```
shell> mysqlshow [options] [db_name [tbl_name [col_name]]]
```

- If no database is given, a list of database names is shown.
- If no table is given, all matching tables in the database are shown.
- If no column is given, all matching columns and column types in the table are shown.

The output displays only the names of those databases, tables, or columns for which you have some privileges.

If the last argument contains shell or SQL wildcard characters (“\*”, “?”, “%”, or “\_”), only those names that are matched by the wildcard are shown. If a database name contains any underscores, those should be escaped with a backslash (some Unix shells require two) to get a list of the proper tables or columns. “\*” and “?” characters are converted into SQL “%” and “\_” wildcard characters. This might cause some confusion when you try to display the columns for a table with a “\_” in the name, because in this case, `mysqlshow` shows you only the table names that match the pattern. This is easily fixed by adding an extra “%” last on the command line as a separate argument.

**Table 4.7. `mysqlshow` Option Reference**

Format	Config File	Description	Introduc- tion	Deprec- ated	Removed
<code>--compress</code>	<code>compress</code>	Compress all information sent between the client and the server			
<code>--count</code>	<code>count</code>	Show the number of rows per table			
<code>- -de- bug[=debug_optio ns]</code>	<code>debug</code>	Write a debugging log			
<code>--debug-check</code>	<code>debug-check</code>	Print debugging information when the program exits	5.1.21		
<code>--debug-info</code>	<code>debug-info</code>	Print debugging information, memory and CPU statistics when the program exits	5.1.14		
<code>- -de- fault-charac- ter- set=charset_name</code>	<code>default-charac- ter-set</code>	Use <code>charset_name</code> as the default character set			
<code>--help</code>		Display help message and exit			
<code>--host=host_name</code>	<code>host</code>	Connect to the MySQL server on the given host			
<code>--keys</code>	<code>keys</code>	Show table indexes			
<code>- -pass- word[=password]</code>	<code>password</code>	The password to use when connecting to the server			
<code>--pipe</code>		On Windows, connect to server via a named pipe			
<code>--port=port_num</code>	<code>port</code>	The TCP/IP port number to use for the connection			
<code>--protocol=type</code>	<code>protocol</code>	The connection protocol to use			
<code>--show-table-type</code>		Show a column indicating the table type			
<code>--socket=path</code>	<code>socket</code>	For connections to localhost			
<code>- -ssl-ca=file_name</code>	<code>ssl-ca</code>	The path to a file that contains a list of trusted SSL CAs			
<code>-</code>	<code>ssl-capath</code>	The path to a directory that contains trusted SSL			



Format	Config File	Description	Introduc- tion	Deprec- ated	Removed
- ssl- capath=directory_ name		CA certificates in PEM format			
- ssl- cert=file_name	ssl-cert	The name of the SSL certificate file to use for es- tablishing a secure connection			
- ssl- cipher=cipher_list	ssl-cipher	A list of allowable ciphers to use for SSL encryp- tion			
- ssl-key=file_name	ssl-key	The name of the SSL key file to use for establish- ing a secure connection			
- ssl-veri- fy-server-cert	ssl-veri- fy-server-cert	The server's Common Name value in its certificate is verified against the host name used when con- necting to the server			
--status	status	Display extra information about each table			
- -user=user_name,	user	The MySQL user name to use when connecting to the server			
--verbose		Verbose mode			
--version		Display version information and exit			

`mysqlshow` supports the options in the following list. It also reads option files and supports the options for processing them de-  
scribed at [Section 4.2.3.2.1, “Command-Line Options that Affect Option-File Handling”](#).

- `--help, -?`  
Display a help message and exit.
- `--character-sets-dir=path`  
The directory where character sets are installed. See [Section 9.2, “The Character Set Used for Data and Sorting”](#).
- `--compress, -C`  
Compress all information sent between the client and the server if both support compression.
- `--count`  
Show the number of rows per table. This can be slow for non-[MyISAM](#) tables.
- `--debug[=debug_options], -# [debug_options]`  
Write a debugging log. A typical `debug_options` string is `'d:t:o,file_name'`. The default is `'d:t:o'`.
- `--debug-check`  
Print some debugging information when the program exits. This option was added in MySQL 5.1.21.
- `--debug-info`  
Print debugging information and memory and CPU usage statistics when the program exits. This option was added in MySQL 5.1.14.
- `--default-character-set=charset_name`  
Use `charset_name` as the default character set. See [Section 9.2, “The Character Set Used for Data and Sorting”](#).
- `--host=host_name, -h host_name`

Connect to the MySQL server on the given host.

- `--keys, -k`

Show table indexes.

- `--password[=password], -p[password]`

The password to use when connecting to the server. If you use the short option form (`-p`), you *cannot* have a space between the option and the password. If you omit the *password* value following the `--password` or `-p` option on the command line, you are prompted for one.

Specifying a password on the command line should be considered insecure. See [Section 5.5.6.2, “End-User Guidelines for Password Security”](#).

- `--pipe, -W`

On Windows, connect to the server via a named pipe. This option applies only for connections to a local server, and only if the server supports named-pipe connections.

- `--port=port_num, -P port_num`

The TCP/IP port number to use for the connection.

- `--protocol={TCP|SOCKET|PIPE|MEMORY}`

The connection protocol to use for connecting to the server. It is useful when the other connection parameters normally would cause a protocol to be used other than the one you want. For details on the allowable values, see [Section 4.2.2, “Connecting to the MySQL Server”](#).

- `--show-table-type, -t`

Show a column indicating the table type, as in `SHOW FULL TABLES`. The type is `BASE TABLE` or `VIEW`.

- `--socket=path, -S path`

For connections to `localhost`, the Unix socket file to use, or, on Windows, the name of the named pipe to use.

- `--ssl*`

Options that begin with `--ssl` specify whether to connect to the server via SSL and indicate where to find SSL keys and certificates. See [Section 5.5.7.3, “SSL Command Options”](#).

- `--status, -i`

Display extra information about each table.

- `--user=user_name, -u user_name`

The MySQL user name to use when connecting to the server.

- `--verbose, -v`

Verbose mode. Print more information about what the program does. This option can be used multiple times to increase the amount of information.

- `--version, -V`

Display version information and exit.

## 4.5.7. `mysqlslap` — Load Emulation Client

`mysqlslap` is a diagnostic program designed to emulate client load for a MySQL server and to report the timing of each stage. It works as if multiple clients are accessing the server. `mysqlslap` is available as of MySQL 5.1.4.

Invoke `mysqlslap` like this:

```
shell> mysqlslap [options]
```

Some options such as `--create` or `--query` enable you to specify a string containing an SQL statement or a file containing statements. If you specify a file, by default it must contain one statement per line. (That is, the implicit statement delimiter is the newline character.) Use the `--delimiter` option to specify a different delimiter, which enables you to specify statements that span multiple lines or place multiple statements on a single line. You cannot include comments in a file; `mysqlslap` does not understand them.

`mysqlslap` runs in three stages:

1. Create schema, table, and optionally any stored programs or data you want to using for the test. This stage uses a single client connection.
2. Run the load test. This stage can use many client connections.
3. Clean up (disconnect, drop table if specified). This stage uses a single client connection.

Examples:

Supply your own create and query SQL statements, with 50 clients querying and 200 selects for each:

```
mysqlslap --delimiter=";" \
  --create="CREATE TABLE a (b int);INSERT INTO a VALUES (23)" \
  --query="SELECT * FROM a" --concurrency=50 --iterations=200
```

Let `mysqlslap` build the query SQL statement with a table of two `INT` columns and three `VARCHAR` columns. Use five clients querying 20 times each. Do not create the table or insert the data (that is, use the previous test's schema and data):

```
mysqlslap --concurrency=5 --iterations=20 \
  --number-int-cols=2 --number-char-cols=3 \
  --auto-generate-sql
```

Tell the program to load the create, insert, and query SQL statements from the specified files, where the `create.sql` file has multiple table creation statements delimited by `' ; '` and multiple insert statements delimited by `' ; '`. The `--query` file will have multiple queries delimited by `' ; '`. Run all the load statements, then run all the queries in the query file with five clients (five times each):

```
mysqlslap --concurrency=5 \
  --iterations=5 --query=query.sql --create=create.sql \
  --delimiter=";"
```

**Table 4.8. `mysqlslap` Option Reference**

Format	Config File	Description	Introduc- tion	Deprec- ated	Removed
<code>- -auto-generate-sql</code>	<code>auto-generate-sql</code>	Generate SQL statements automatically when they are not supplied in files or via command options			
<code>- - auto-gener- ate- sql- add- autoincrement</code>	<code>auto-gener- ate- sql- add- autoincrement</code>	Add <code>AUTO_INCREMENT</code> column to automatically generated tables	5.1.18		
<code>- - auto-gener- ate- sql-ex- ecute-number=#</code>	<code>auto-gener- ate- sql-ex- ecute-number</code>	Specify how many queries to generate automatically	5.1.18		
<code>- - auto-gener- ate- sql-guid-primary</code>	<code>auto-gener- ate- sql-guid-primary</code>	Add a GUID-based primary key to automatically generated tables	5.1.18		
<code>- - auto-gener-</code>	<code>auto-gener- ate-sql-load-type</code>	Specify how many queries to generate automatically	5.1.16		

Format	Config File	Description	Introduction	Deprecated	Removed
ate-sql-load-type=type					
- - auto-generate-sql-secondary-indexes=#	auto-generate-sql-secondary-indexes	Specify how many secondary indexes to add to automatically generated tables	5.1.18		
- - auto-generate-sql-unique-query-number=#	auto-generate-sql-unique-query-number	How many different queries to generate for automatic tests.	5.1.18		
- - auto-generate-sql-unique-write-number=#	auto-generate-sql-unique-write-number	How many different queries to generate for - -auto-generate-sql-write-number	5.1.18		
- - auto-generate-sql-write-number=#	auto-generate-sql-write-number	How many row inserts to perform on each thread	5.1.16		
--commit=#	commit	How many statements to execute before committing.	5.1.21		
--compress	compress	Compress all information sent between the client and the server			
--concurrency=#	concurrency	The number of clients to simulate when issuing the SELECT statement			
--create=value	create	The file or string containing the statement to use for creating the table			
- -create-schema=value	create-schema	The schema in which to run the tests	5.1.5		
--csv=[file]	csv	Generate output in comma-separated values format			
- -debug[=debug_options]	debug	Write a debugging log			
--debug-check	debug-check	Print debugging information when the program exits	5.1.21		
--debug-info	debug-info	Print debugging information, memory and CPU statistics when the program exits	5.1.21		
--delimiter=str	delimiter	The delimiter to use in SQL statements			
--detach=#	detach	Detach (close and reopen) each connection after each N statements	5.1.21		
- -engine=engine_name	engine	The storage engine to use for creating the table			
--help		Display help message and exit			
--host=host_name	host	Connect to the MySQL server on the given host			
--iterations=#	iterations	The number of times to run the tests			

Format	Config File	Description	Introduction	Deprecated	Removed
- - lock-directory=path	lock-directory	The directory to use for storing locks	5.1.5		5.1.18
- -number-char-cols=#	number-char-cols	The number of VARCHAR columns to use if - -auto-generate-sql is specified			
- -number-int-cols=#	number-int-cols	The number of INT columns to use if - -auto-generate-sql is specified			
- -number-of-queries=#	number-of-queries	Limit each client to approximately this number of queries	5.1.5		
--only-print	only-print	Do not connect to databases. mysqlslap only prints what it would have done	5.1.5		
- -password[=password]	password	The password to use when connecting to the server			
--pipe		On Windows, connect to server via a named pipe			
--port=port_num	port	The TCP/IP port number to use for the connection			
- -post-query=value	post-query	The file or string containing the statement to execute after the tests have completed	5.1.18		
--post-system=str	post-system	The string to execute via system() after the tests have completed	5.1.21		
--pre-query=value	pre-query	The file or string containing the statement to execute before running the tests	5.1.18		
--pre-system=str	pre-system	The string to execute via system(>) before running the tests	5.1.21		
--preserve-schema	preserve-schema	Preserve the schema from the mysqlslap run	5.1.5		5.1.23
--protocol=type	protocol	The connection protocol to use			
--query=value	query	The file or string containing the SELECT statement to use for retrieving data			
--silent	silent	Silent mode			
--slave	slave	Follow master locks for other mysqlslap clients	5.1.5		5.1.18
--socket=path	socket	For connections to localhost			
- -ssl-ca=file_name	ssl-ca	The path to a file that contains a list of trusted SSL CAs			
- - ssl-capath=directory_name	ssl-capath	The path to a directory that contains trusted SSL CA certificates in PEM format			
- - ssl-cert=file_name	ssl-cert	The name of the SSL certificate file to use for establishing a secure connection			
- - ssl-cipher=cipher_list	ssl-cipher	A list of allowable ciphers to use for SSL encryption			
- - ssl-key=file_name	ssl-key	The name of the SSL key file to use for establishing a secure connection			
- - ssl-verify-server-cert	ssl-verify-server-cert	The server's Common Name value in its certificate is verified against the host name used when connecting to the server			

Format	Config File	Description	Introduc- tion	Deprec- ated	Removed
<code>--use-threads</code>	<code>use-threads</code>	On Unix, the default is to use <code>fork()</code> calls	5.1.6		5.1.18
<code>- -user=user_name,</code>	<code>user</code>	The MySQL user name to use when connecting to the server			
<code>--verbose</code>		Verbose mode			
<code>--version</code>		Display version information and exit			

`mysqlslap` supports the options in the following list. It also reads option files and supports the options for processing them described at [Section 4.2.3.2.1, “Command-Line Options that Affect Option-File Handling”](#).

- `--help, -?`  
Display a help message and exit.
- `--auto-generate-sql, -a`  
Generate SQL statements automatically when they are not supplied in files or via command options.
- `--auto-generate-sql-add-autoincrement`  
Add an `AUTO_INCREMENT` column to automatically generated tables. This option was added in MySQL 5.1.18.
- `--auto-generate-sql-execute-number=N`  
Specify how many queries to generate automatically. This option was added in MySQL 5.1.18.
- `--auto-generate-sql-guid-primary`  
Add a GUID-based primary key to automatically generated tables. This option was added in MySQL 5.1.18.
- `--auto-generate-sql-load-type=type`  
Specify the test load type. The allowable values are `read` (scan tables), `write` (insert into tables), `key` (read primary keys), `update` (update primary keys), or `mixed` (half inserts, half scanning selects). The default is `mixed`. This option was added in MySQL 5.1.16.
- `--auto-generate-sql-secondary-indexes=N`  
Specify how many secondary indexes to add to automatically generated tables. By default, none are added. This option was added in MySQL 5.1.18.
- `--auto-generate-sql-unique-query-number=N`  
How many different queries to generate for automatic tests. For example, if you run a `key` test that performs 1000 selects, you can use this option with a value of 1000 to run 1000 unique queries, or with a value of 50 to perform 50 different selects. The default is 10. This option was added in MySQL 5.1.18.
- `--auto-generate-sql-unique-write-number=N`  
How many different queries to generate for `--auto-generate-sql-write-number`. The default is 10. This option was added in MySQL 5.1.18.
- `--auto-generate-sql-write-number=N`  
How many row inserts to perform on each thread. The default is 100. This option was added in MySQL 5.1.16.
- `--commit=N`  
How many statements to execute before committing. The default is 0 (no commits are done). This option was added in MySQL 5.1.21.
- `--compress, -C`  
Compress all information sent between the client and the server if both support compression.
- `--concurrency=N, -c N`

The number of clients to simulate when issuing the `SELECT` statement.

- `--create=value`

The file or string containing the statement to use for creating the table.

- `--create-schema=value`

The schema in which to run the tests. This option was added in MySQL 5.1.5.

- `--csv[=file_name]`

Generate output in comma-separated values format. The output goes to the named file, or to the standard output if no file is given. This option was added in MySQL 5.1.5.

- `--debug[=debug_options], -# [debug_options]`

Write a debugging log. A typical `debug_options` string is `'d:t:o,file_name'`. The default is `'d:t:o,/tmp/mysqlslap.trace'`.

- `--debug-check`

Print some debugging information when the program exits. This option was added in MySQL 5.1.21.

- `--debug-info, -T`

Print debugging information and memory and CPU usage statistics when the program exits. This option was added in MySQL 5.1.21.

- `--delimiter=str, -F str`

The delimiter to use in SQL statements supplied in files or via command options.

- `--detach=N`

Detach (close and reopen) each connection after each `N` statements. The default is 0 (connections are not detached). This option was added in MySQL 5.1.21.

- `--engine=engine_name, -e engine_name`

The storage engine to use for creating tables.

- `--host=host_name, -h host_name`

Connect to the MySQL server on the given host.

- `--iterations=N, -i N`

The number of times to run the tests.

- `--lock-directory=path`

The directory to use for storing locks. This option was added in MySQL 5.1.5 and removed in 5.1.18.

- `--number-char-cols=N, -x N`

The number of `VARCHAR` columns to use if `--auto-generate-sql` is specified.

- `--number-int-cols=N, -y N`

The number of `INT` columns to use if `--auto-generate-sql` is specified.

- `--number-of-queries=N`

Limit each client to approximately this number of queries. This option was added in MySQL 5.1.5.

- `--only-print`

Do not connect to databases. `mysqlslap` only prints what it would have done. This option was added in MySQL 5.1.5.

- `--password[=password], -p[password]`

The password to use when connecting to the server. If you use the short option form (`-p`), you *cannot* have a space between the option and the password. If you omit the *password* value following the `--password` or `-p` option on the command line, you are prompted for one.

Specifying a password on the command line should be considered insecure. See [Section 5.5.6.2, “End-User Guidelines for Password Security”](#).

- `--pipe, -W`

On Windows, connect to the server via a named pipe. This option applies only for connections to a local server, and only if the server supports named-pipe connections.

- `--port=port_num, -P port_num`

The TCP/IP port number to use for the connection.

- `--post-query=value`

The file or string containing the statement to execute after the tests have completed. This execution is not counted for timing purposes. This option was added in MySQL 5.1.18.

- `--shared-memory-base-name=name`

On Windows, the shared-memory name to use, for connections made via shared memory to a local server. This option applies only if the server supports shared-memory connections.

- `--post-system=str`

The string to execute via `system()` after the tests have completed. This execution is not counted for timing purposes. This option was added in MySQL 5.1.21.

- `--pre-query=value`

The file or string containing the statement to execute before running the tests. This execution is not counted for timing purposes. This option was added in MySQL 5.1.18.

- `--pre-system=str`

The string to execute via `system()` before running the tests. This execution is not counted for timing purposes. This option was added in MySQL 5.1.21.

- `--preserve-schema`

Preserve the schema from the `mysqldslap` run. The `--auto-generate-sql` and `--create` options disable this option. This option was added in MySQL 5.1.5 and removed in MySQL 5.1.23.

- `--protocol={TCP|SOCKET|PIPE|MEMORY}`

The connection protocol to use for connecting to the server. It is useful when the other connection parameters normally would cause a protocol to be used other than the one you want. For details on the allowable values, see [Section 4.2.2, “Connecting to the MySQL Server”](#).

- `--query=value, -q value`

The file or string containing the `SELECT` statement to use for retrieving data.

- `--silent, -s`

Silent mode. No output.

- `--slave`

Follow master locks for other `mysqldslap` clients. Use this option if you are trying to synchronize around one master server with `--lock-directory` plus NFS. This option was added in MySQL 5.1.5 and removed in 5.1.18.

- `--socket=path, -S path`

For connections to `localhost`, the Unix socket file to use, or, on Windows, the name of the named pipe to use.

- `--ssl*`



Options that begin with `--ssl` specify whether to connect to the server via SSL and indicate where to find SSL keys and certificates. See [Section 5.5.7.3, “SSL Command Options”](#).

- `--use-threads`

On Unix, the default is to use `fork()` calls and this option causes `pthread` calls to be used instead. (On Windows, the default is to use `pthread` calls and the option has no effect.) This option was added in MySQL 5.1.6 and removed in 5.1.18.

- `--user=user_name, -u user_name`

The MySQL user name to use when connecting to the server.

- `--verbose, -v`

Verbose mode. Print more information about what the program does. This option can be used multiple times to increase the amount of information.

- `--version, -V`

Display version information and exit.

## 4.6. MySQL Administrative and Utility Programs

### 4.6.1. `innochecksum` — Offline InnoDB File Checksum Utility

`innochecksum` prints checksums for InnoDB files.

Invoke `innochecksum` like this:

```
shell> innochecksum [options] file_name
```

`innochecksum` supports the options described in the following list. For options that refer to page numbers, the numbers are zero-based.

- `-c`

Print a count of the number of pages in the file.

- `-d`

Debug mode; prints checksums for each page.

- `-e num`

End at this page number.

- `-p num`

Check only this page number.

- `-s num`

Start at this page number.

- `-v`

Verbose mode; print a progress indicator every five seconds.

### 4.6.2. `myisam_ftdump` — Display Full-Text Index information

`myisam_ftdump` displays information about `FULLTEXT` indexes in `MyISAM` tables. It reads the `MyISAM` index file directly, so it must be run on the server host where the table is located

Invoke `myisam_ftdump` like this:

```
shell> myisam_ftdump [options] tbl_name index_num
```

The `tbl_name` argument should be the name of a **MyISAM** table. You can also specify a table by naming its index file (the file with the `.MYI` suffix). If you do not invoke `myisam_ftdump` in the directory where the table files are located, the table or index file name must be preceded by the path name to the table's database directory. Index numbers begin with 0.

Example: Suppose that the `test` database contains a table named `mytexttable1` that has the following definition:

```
CREATE TABLE mytexttable
(
  id   INT NOT NULL,
  txt  TEXT NOT NULL,
  PRIMARY KEY (id),
  FULLTEXT (txt)
);
```

The index on `id` is index 0 and the `FULLTEXT` index on `txt` is index 1. If your working directory is the `test` database directory, invoke `myisam_ftdump` as follows:

```
shell> myisam_ftdump mytexttable 1
```

If the path name to the `test` database directory is `/usr/local/mysql/data/test`, you can also specify the table name argument using that path name. This is useful if you do not invoke `myisam_ftdump` in the database directory:

```
shell> myisam_ftdump /usr/local/mysql/data/test/mytexttable 1
```

`myisam_ftdump` supports the following options:

- `--help, -h -?`  
Display a help message and exit.
- `--count, -c`  
Calculate per-word statistics (counts and global weights).
- `--dump, -d`  
Dump the index, including data offsets and word weights.
- `--length, -l`  
Report the length distribution.
- `--stats, -s`  
Report global index statistics. This is the default operation if no other operation is specified.
- `--verbose, -v`  
Verbose mode. Print more output about what the program does.

### 4.6.3. `myisamchk` — MyISAM Table-Maintenance Utility

The `myisamchk` utility gets information about your database tables or checks, repairs, or optimizes them. `myisamchk` works with **MyISAM** tables (tables that have `.MYD` and `.MYI` files for storing data and indexes).

The use of `myisamchk` with partitioned tables is not supported.

#### Caution

It is best to make a backup of a table before performing a table repair operation; under some circumstances the operation might cause data loss. Possible causes include but are not limited to file system errors.

Invoke `myisamchk` like this:

```
shell> myisamchk [options] tbl_name ...
```

The `options` specify what you want `myisamchk` to do. They are described in the following sections. You can also get a list of options by invoking `myisamchk --help`.

With no options, `myisamchk` simply checks your table as the default operation. To get more information or to tell `myisamchk` to take corrective action, specify options as described in the following discussion.

`tbl_name` is the database table you want to check or repair. If you run `myisamchk` somewhere other than in the database directory, you must specify the path to the database directory, because `myisamchk` has no idea where the database is located. In fact, `myisamchk` does not actually care whether the files you are working on are located in a database directory. You can copy the files that correspond to a database table into some other location and perform recovery operations on them there.

You can name several tables on the `myisamchk` command line if you wish. You can also specify a table by naming its index file (the file with the `.MYI` suffix). This allows you to specify all tables in a directory by using the pattern `*.MYI`. For example, if you are in a database directory, you can check all the MyISAM tables in that directory like this:

```
shell> myisamchk *.MYI
```

If you are not in the database directory, you can check all the tables there by specifying the path to the directory:

```
shell> myisamchk /path/to/database_dir/*.MYI
```

You can even check all tables in all databases by specifying a wildcard with the path to the MySQL data directory:

```
shell> myisamchk /path/to/datadir/*/*.MYI
```

The recommended way to quickly check all MyISAM tables is:

```
shell> myisamchk --silent --fast /path/to/datadir/*/*.MYI
```

If you want to check all MyISAM tables and repair any that are corrupted, you can use the following command:

```
shell> myisamchk --silent --force --fast --update-state \
--key_buffer_size=64M --sort_buffer_size=64M \
--read_buffer_size=1M --write_buffer_size=1M \
/path/to/datadir/*/*.MYI
```

This command assumes that you have more than 64MB free. For more information about memory allocation with `myisamchk`, see [Section 4.6.3.5, “myisamchk Memory Usage”](#).

### MySQL Enterprise

For expert advice on checking and repairing tables, subscribe to the MySQL Enterprise Monitor. For more information, see <http://www.mysql.com/products/enterprise/advisors.html>.

### Important

You must ensure that no other program is using the tables while you are running `myisamchk`. The most effective means of doing so is to shut down the MySQL server while running `myisamchk`, or to lock all tables that `myisamchk` is being used on.

Otherwise, when you run `myisamchk`, it may display the following error message:

```
warning: clients are using or haven't closed the table properly
```

This means that you are trying to check a table that has been updated by another program (such as the `mysqld` server) that hasn't yet closed the file or that has died without closing the file properly, which can sometimes lead to the corruption of one or more MyISAM tables.

If `mysqld` is running, you must force it to flush any table modifications that are still buffered in memory by using `FLUSH TABLES`. You should then ensure that no one is using the tables while you are running `myisamchk`.

However, the easiest way to avoid this problem is to use `CHECK TABLE` instead of `myisamchk` to check tables. See [Section 12.5.2.3, “CHECK TABLE Syntax”](#).

`myisamchk` supports the options in the following table. It also reads option files and supports the options for processing them described at [Section 4.2.3.2.1, “Command-Line Options that Affect Option-File Handling”](#).

**Table 4.9. `myisamchk` Option Reference**

Format	Config File	Description	Introduc- tion	Deprec- ated	Removed
<code>--analyze</code>	<code>analyze</code>	Analyze the distribution of key values			

Format	Config File	Description	Introduc- tion	Deprec- ated	Removed
--backup	backup	Make a backup of the .MYD file as file_name-time.BAK			
- -block- search=offset	block-search	Find the record that a block at the given offset belongs to			
--check	check	Check the table for errors			
- -check- only-changed	check- only-changed	Check only tables that have changed since the last check			
- -correct-checksum	correct-checksum	Correct the checksum information for the table			
- -data- file-length=len	data-file-length	Maximum length of the data file (when re-creating data file when it is full)			
- -de- bug[=debug_optio ns]	debug	Write a debugging log			
decode_bits=#	decode_bits	Decode_bits			
--description	description	Print some descriptive information about the table			
--extend-check	extend-check	Do a repair that tries to recover every possible row from the data file			
--extended-check	extended-check	Check the table very thoroughly			
--fast	fast	Check only tables that haven't been closed properly			
--force	force	Do a repair operation automatically if myisamchk finds any errors in the table			
--force	force-recover	Overwrite old temporary files. For use with the -r or -o option			
ft_max_word_len=#	ft_max_word_len	Maximum word length for FULLTEXT indexes			
ft_min_word_len=#	ft_min_word_len	Minimum word length for FULLTEXT indexes			
ft_stopword_file=value	ft_stopword_file	Use stopwords from this file instead of built-in list			
--HELP		Display help message and exit			
--help		Display help message and exit			
--information	information	Print informational statistics about the table that is checked			
key_buffer_size=#	key_buffer_size	The size of the buffer used for index blocks for MyISAM tables			
--keys-used=val	keys-used	A bit-value that indicates which indexes to update			
- -max-re- cord-length=len	max-record-length	Skip rows larger than the given length if myisamchk cannot allocate memory to hold them			
--medium-check	medium-check	Do a check that is faster than an --extend-check operation			
myis- am_block_size=#	myis- am_block_size	Block size to be used for MyISAM index pages			
--parallel-recover	parallel-recover	Uses the same technique as -r and -n, but creates all the keys in parallel, using different threads (beta)			
--quick	quick	Achieve a faster repair by not modifying the data			

Format	Config File	Description	Introduc- tion	Deprec- ated	Removed
		file.			
read_buffer_size=#	read_buffer_size	Each thread that does a sequential scan allocates a buffer of this size for each table it scans			
--read-only	read-only	Don't mark the table as checked			
--recover	recover	Do a repair that can fix almost any problem except unique keys that aren't unique			
--safe-recover	safe-recover	Do a repair using an old recovery method that reads through all rows in order and updates all index trees based on the rows found			
- - set- auto-incre- ment[=value]	set- auto-increment	Force AUTO_INCREMENT numbering for new records to start at the given value			
- - set-colla- tion=name	set-collation	Specify the collation to use for sorting table indexes			
--silent	silent	Silent mode			
sort_buffer_size=#	sort_buffer_size	The buffer that is allocated when sorting the index when doing a REPAIR or when creating indexes with CREATE INDEX or ALTER TABLE			
--sort-index	sort-index	Sort the index tree blocks in high-low order			
sort_key_blocks=#	sort_key_blocks	sort_key_blocks			
--sort-records=#	sort-records	Sort records according to a particular index			
--sort-recover	sort-recover	Force myisamchk to use sorting to resolve the keys even if the temporary files would be very large			
stats_method=value	stats_method	Specifies how MyISAM index statistics collection code should treat NULLs			
--tmpdir=path	tmpdir	Path of the directory to be used for storing temporary files			
--unpack	unpack	Unpack a table that was packed with myisampack			
--update-state	update-state	Store information in the .MYI file to indicate when the table was checked and whether the table crashed			
--verbose		Verbose mode			
--version		Display version information and exit			
write_buffer_size=#	write_buffer_size	Write buffer size			

#### 4.6.3.1. myisamchk General Options

The options described in this section can be used for any type of table maintenance operation performed by `myisamchk`. The sections following this one describe options that pertain only to specific operations, such as table checking or repairing.

- `--help, -?`

Display a help message and exit. Options are grouped by type of operation.

- `--HELP, -H`

Display a help message and exit. Options are presented in a single list.

- `--debug=debug_options, -# debug_options`

Write a debugging log. A typical `debug_options` string is `'d:t:o,file_name'`. The default is

```
'd:t:o,/tmp/myisamchk.trace'.
```

- `--silent, -s`

Silent mode. Write output only when errors occur. You can use `-s` twice (`-ss`) to make `myisamchk` very silent.

- `--verbose, -v`

Verbose mode. Print more information about what the program does. This can be used with `-d` and `-e`. Use `-v` multiple times (`-vv, -vvv`) for even more output.

- `--version, -V`

Display version information and exit.

- `--wait, -w`

Instead of terminating with an error if the table is locked, wait until the table is unlocked before continuing. If you are running `mysqld` with external locking disabled, the table can be locked only by another `myisamchk` command.

You can also set the following variables by using `--var_name=value` syntax:

Variable	Default Value
<code>decode_bits</code>	9
<code>ft_max_word_len</code>	version-dependent
<code>ft_min_word_len</code>	4
<code>ft_stopword_file</code>	built-in list
<code>key_buffer_size</code>	523264
<code>myisam_block_size</code>	1024
<code>read_buffer_size</code>	262136
<code>sort_buffer_size</code>	2097144
<code>sort_key_blocks</code>	16
<code>stats_method</code>	<code>nulls_unequal</code>
<code>write_buffer_size</code>	262136

The possible `myisamchk` variables and their default values can be examined with `myisamchk --help`:

`sort_buffer_size` is used when the keys are repaired by sorting keys, which is the normal case when you use `--recover`.

`key_buffer_size` is used when you are checking the table with `--extend-check` or when the keys are repaired by inserting keys row by row into the table (like when doing normal inserts). Repairing through the key buffer is used in the following cases:

- You use `--safe-recover`.
- The temporary files needed to sort the keys would be more than twice as big as when creating the key file directly. This is often the case when you have large key values for `CHAR`, `VARCHAR`, or `TEXT` columns, because the sort operation needs to store the complete key values as it proceeds. If you have lots of temporary space and you can force `myisamchk` to repair by sorting, you can use the `--sort-recover` option.

Repairing through the key buffer takes much less disk space than using sorting, but is also much slower.

If you want a faster repair, set the `key_buffer_size` and `sort_buffer_size` variables to about 25% of your available memory. You can set both variables to large values, because only one of them is used at a time.

`myisam_block_size` is the size used for index blocks.

`stats_method` influences how `NULL` values are treated for index statistics collection when the `--analyze` option is given. It acts like the `myisam_stats_method` system variable. For more information, see the description of `myisam_stats_method` in [Section 5.1.3, “Server System Variables”](#), and [Section 7.4.6, “MyISAM Index Statistics Collection”](#). For MySQL 5.1, `stats_method` was added in MySQL 5.0.14. For older versions, the statistics collection method is equivalent to `nulls_equal`.

The `ft_min_word_len` and `ft_max_word_len` variables are available as of MySQL 4.0.0. `ft_stopword_file` is available as of MySQL 4.0.19.

`ft_min_word_len` and `ft_max_word_len` indicate the minimum and maximum word length for `FULLTEXT` indexes. `ft_stopword_file` names the stopword file. These need to be set under the following circumstances.

If you use `myisamchk` to perform an operation that modifies table indexes (such as repair or analyze), the `FULLTEXT` indexes are rebuilt using the default full-text parameter values for minimum and maximum word length and the stopword file unless you specify otherwise. This can result in queries failing.

The problem occurs because these parameters are known only by the server. They are not stored in `MyISAM` index files. To avoid the problem if you have modified the minimum or maximum word length or the stopword file in the server, specify the same `ft_min_word_len`, `ft_max_word_len`, and `ft_stopword_file` values to `myisamchk` that you use for `mysqld`. For example, if you have set the minimum word length to 3, you can repair a table with `myisamchk` like this:

```
shell> myisamchk --recover --ft_min_word_len=3 tbl_name.MYI
```

To ensure that `myisamchk` and the server use the same values for full-text parameters, you can place each one in both the `[mysqld]` and `[myisamchk]` sections of an option file:

```
[mysqld]
ft_min_word_len=3

[myisamchk]
ft_min_word_len=3
```

An alternative to using `myisamchk` is to use the `REPAIR TABLE`, `ANALYZE TABLE`, `OPTIMIZE TABLE`, or `ALTER TABLE`. These statements are performed by the server, which knows the proper full-text parameter values to use.

### 4.6.3.2. `myisamchk` Check Options

`myisamchk` supports the following options for table checking operations:

- `--check, -c`

Check the table for errors. This is the default operation if you specify no option that selects an operation type explicitly.

- `--check-only-changed, -C`

Check only tables that have changed since the last check.

- `--extend-check, -e`

Check the table very thoroughly. This is quite slow if the table has many indexes. This option should only be used in extreme cases. Normally, `myisamchk` or `myisamchk --medium-check` should be able to determine whether there are any errors in the table.

If you are using `--extend-check` and have plenty of memory, setting the `key_buffer_size` variable to a large value helps the repair operation run faster.

- `--fast, -F`

Check only tables that haven't been closed properly.

- `--force, -f`

Do a repair operation automatically if `myisamchk` finds any errors in the table. The repair type is the same as that specified with the `--recover` or `-r` option.

- `--information, -i`

Print informational statistics about the table that is checked.

- `--medium-check, -m`

Do a check that is faster than an `--extend-check` operation. This finds only 99.99% of all errors, which should be good enough in most cases.

- `--read-only, -T`

Do not mark the table as checked. This is useful if you use `myisamchk` to check a table that is in use by some other application that does not use locking, such as `mysqld` when run with external locking disabled.

- `--update-state, -U`

Store information in the `.MYI` file to indicate when the table was checked and whether the table crashed. This should be used to get full benefit of the `--check-only-changed` option, but you shouldn't use this option if the `mysqld` server is using the table and you are running it with external locking disabled.

### 4.6.3.3. `myisamchk` Repair Options

`myisamchk` supports the following options for table repair operations:

- `--backup, -B`

Make a backup of the `.MYD` file as `file_name-time.BAK`

- `--character-sets-dir=path`

The directory where character sets are installed. See [Section 9.2, “The Character Set Used for Data and Sorting”](#).

- `--correct-checksum`

Correct the checksum information for the table.

- `--data-file-length=len, -D len`

Maximum length of the data file (when re-creating data file when it is “full”).

- `--extend-check, -e`

Do a repair that tries to recover every possible row from the data file. Normally, this also finds a lot of garbage rows. Do not use this option unless you are desperate.

- `--force, -f`

Overwrite old intermediate files (files with names like `tbl_name.TMD`) instead of aborting.

- `--keys-used=val, -k val`

For `myisamchk`, the option value is a bit-value that indicates which indexes to update. Each binary bit of the option value corresponds to a table index, where the first index is bit 0. An option value of 0 disables updates to all indexes, which can be used to get faster inserts. Deactivated indexes can be reactivated by using `myisamchk -r`.

- `--no-symlinks, -l`

Do not follow symbolic links. Normally `myisamchk` repairs the table that a symlink points to. This option does not exist as of MySQL 4.0 because versions from 4.0 on do not remove symlinks during repair operations.

- `--max-record-length=len`

Skip rows larger than the given length if `myisamchk` cannot allocate memory to hold them.

- `--parallel-recover, -p`

Uses the same technique as `-r` and `-n`, but creates all the keys in parallel, using different threads. *This is beta-quality code. Use at your own risk!*

- `--quick, -q`

Achieve a faster repair by not modifying the data file. You can specify this option twice to force `myisamchk` to modify the original data file in case of duplicate keys.

- `--recover, -r`

Do a repair that can fix almost any problem except unique keys that are not unique (which is an extremely unlikely error with `MyISAM` tables). If you want to recover a table, this is the option to try first. You should try `--safe-recover` only if `myisamchk` reports that the table cannot be recovered using `--recover`. (In the unlikely case that `--recover` fails, the data



file remains intact.)

If you have lots of memory, you should increase the value of `sort_buffer_size`.

- `--safe-recover, -o`

Do a repair using an old recovery method that reads through all rows in order and updates all index trees based on the rows found. This is an order of magnitude slower than `--recover`, but can handle a couple of very unlikely cases that `--recover` cannot. This recovery method also uses much less disk space than `--recover`. Normally, you should repair first using `--recover`, and then with `--safe-recover` only if `--recover` fails.

If you have lots of memory, you should increase the value of `key_buffer_size`.

- `--set-character-set=name`

Change the character set used by the table indexes. This option was replaced by `--set-collation` in MySQL 5.0.3.

- `--set-collation=name`

Specify the collation to use for sorting table indexes. The character set name is implied by the first part of the collation name.

- `--sort-recover, -n`

Force `myisamchk` to use sorting to resolve the keys even if the temporary files would be very large.

- `--tmpdir=path, -t path`

Path of the directory to be used for storing temporary files. If this is not set, `myisamchk` uses the value of the `TMPDIR` environment variable. `tmpdir` can be set to a list of directory paths that are used successively in round-robin fashion for creating temporary files. The separator character between directory names is the colon (":") on Unix and the semicolon (";") on Windows, NetWare, and OS/2.

- `--unpack, -u`

Unpack a table that was packed with `myisampack`.

#### 4.6.3.4. Other `myisamchk` Options

`myisamchk` supports the following options for actions other than table checks and repairs:

- `--analyze, -a`

Analyze the distribution of key values. This improves join performance by enabling the join optimizer to better choose the order in which to join the tables and which indexes it should use. To obtain information about the key distribution, use a `myisamchk --description --verbose tbl_name` command or the `SHOW INDEX FROM tbl_name` statement.

#### MySQL Enterprise

For expert advice on optimizing tables, subscribe to the MySQL Enterprise Monitor. For more information, see <http://www.mysql.com/products/enterprise/advisors.html>.

- `--block-search=offset, -b offset`

Find the record that a block at the given offset belongs to.

- `--description, -d`

Print some descriptive information about the table.

- `--set-auto-increment[=value], -A[value]`

Force `AUTO_INCREMENT` numbering for new records to start at the given value (or higher, if there are existing records with `AUTO_INCREMENT` values this large). If `value` is not specified, `AUTO_INCREMENT` numbers for new records begin with the largest value currently in the table, plus one.

- `--sort-index, -S`

Sort the index tree blocks in high-low order. This optimizes seeks and makes table scans that use indexes faster.

- `--sort-records=N, -R N`

Sort records according to a particular index. This makes your data much more localized and may speed up range-based `SELECT` and `ORDER BY` operations that use this index. (The first time you use this option to sort a table, it may be very slow.) To determine a table's index numbers, use `SHOW INDEX`, which displays a table's indexes in the same order that `myisamchk` sees them. Indexes are numbered beginning with 1.

If keys are not packed (`PACK_KEYS=0`), they have the same length, so when `myisamchk` sorts and moves records, it just overwrites record offsets in the index. If keys are packed (`PACK_KEYS=1`), `myisamchk` must unpack key blocks first, then re-create indexes and pack the key blocks again. (In this case, re-creating indexes is faster than updating offsets for each index.)

#### 4.6.3.5. `myisamchk` Memory Usage

Memory allocation is important when you run `myisamchk`. `myisamchk` uses no more memory than its memory-related variables are set to. If you are going to use `myisamchk` on very large tables, you should first decide how much memory you want it to use. The default is to use only about 3MB to perform repairs. By using larger values, you can get `myisamchk` to operate faster. For example, if you have more than 32MB RAM, you could use options such as these (in addition to any other options you might specify):

```
shell> myisamchk --sort_buffer_size=16M --key_buffer_size=16M \
         --read_buffer_size=1M --write_buffer_size=1M ...
```

Using `--sort_buffer_size=16M` should probably be enough for most cases.

Be aware that `myisamchk` uses temporary files in `TMPDIR`. If `TMPDIR` points to a memory file system, you may easily get out of memory errors. If this happens, run `myisamchk` with the `--tmpdir=path` option to specify some directory located on a file system that has more space.

When repairing, `myisamchk` also needs a lot of disk space:

- Double the size of the data file (the original file and a copy). This space is not needed if you do a repair with `--quick`; in this case, only the index file is re-created. *This space must be available on the same file system as the original data file*, as the copy is created in the same directory as the original.
- Space for the new index file that replaces the old one. The old index file is truncated at the start of the repair operation, so you usually ignore this space. This space must be available on the same file system as the original data file.
- When using `--recover` or `--sort-recover` (but not when using `--safe-recover`), you need space for a sort buffer. The following formula yields the amount of space required:

```
(largest_key + row_pointer_length) × number_of_rows × 2
```

You can check the length of the keys and the `row_pointer_length` with `myisamchk -dv tbl_name`. This space is allocated in the temporary directory (specified by `TMPDIR` or `--tmpdir=path`).

If you have a problem with disk space during repair, you can try `--safe-recover` instead of `--recover`.

#### 4.6.4. `myisamlog` — Display MyISAM Log File Contents

`myisamlog` processes the contents of a MyISAM log file.

Invoke `myisamlog` like this:

```
shell> myisamlog [options] [log_file [tbl_name] ...]
shell> isamlog [options] [log_file [tbl_name] ...]
```

The default operation is update (`-u`). If a recovery is done (`-r`), all writes and possibly updates and deletes are done and errors are only counted. The default log file name is `myisam.log` for `myisamlog` and `isam.log` for `isamlog` if no `log_file` argument is given. If tables are named on the command line, only those tables are updated.

`myisamlog` supports the following options:

- `-?, -I`

Display a help message and exit.

- `-c N`

Execute only *N* commands.

- `-f N`

Specify the maximum number of open files.

- `-i`

Display extra information before exiting.

- `-o offset`

Specify the starting offset.

- `-p N`

Remove *N* components from path.

- `-r`

Perform a recovery operation.

- `-R record_pos_file record_pos`

Specify record position file and record position.

- `-u`

Perform an update operation.

- `-v`

Verbose mode. Print more output about what the program does. This option can be given multiple times to produce more and more output.

- `-w write_file`

Specify the write file.

- `-V`

Display version information.

## 4.6.5. `mysampack` — Generate Compressed, Read-Only MyISAM Tables

The `mysampack` utility compresses MyISAM tables. `mysampack` works by compressing each column in the table separately. Usually, `mysampack` packs the data file 40%-70%.

When the table is used later, the server reads into memory the information needed to decompress columns. This results in much better performance when accessing individual rows, because you only have to uncompress exactly one row.

MySQL uses `mmap()` when possible to perform memory mapping on compressed tables. If `mmap()` does not work, MySQL falls back to normal read/write file operations.

Please note the following:

- If the `mysqld` server was invoked with external locking disabled, it is not a good idea to invoke `mysampack` if the table might be updated by the server during the packing process. It is safest to compress tables with the server stopped.
- After packing a table, it becomes read only. This is generally intended (such as when accessing packed tables on a CD). Allowing writes to a packed table is on our TODO list, but with low priority.

Invoke `mysampack` like this:

```
shell> mysampack [options] file_name ...
```

Each file name argument should be the name of an index (`.MYI`) file. If you are not in the database directory, you should specify

the path name to the file. It is permissible to omit the `.MYI` extension.

After you compress a table with `myisampack`, you should use `myisamchk -rq` to rebuild its indexes. [Section 4.6.3, “myisamchk — MyISAM Table-Maintenance Utility”](#).

`myisampack` supports the options in the following list. It also reads option files and supports the options for processing them described at [Section 4.2.3.2.1, “Command-Line Options that Affect Option-File Handling”](#).

- `--help, -?`  
Display a help message and exit.
- `--backup, -b`  
Make a backup of each table's data file using the name `tbl_name.OLD`.
- `--character-sets-dir=path`  
The directory where character sets are installed. See [Section 9.2, “The Character Set Used for Data and Sorting”](#).
- `--debug[=debug_options], -# [debug_options]`  
Write a debugging log. A typical `debug_options` string is `'d:t:o,file_name'`. The default is `'d:t:o'`.
- `--force, -f`  
Produce a packed table even if it becomes larger than the original or if the intermediate file from an earlier invocation of `myisampack` exists. (`myisampack` creates an intermediate file named `tbl_name.TMD` in the database directory while it compresses the table. If you kill `myisampack`, the `.TMD` file might not be deleted.) Normally, `myisampack` exits with an error if it finds that `tbl_name.TMD` exists. With `--force`, `myisampack` packs the table anyway.
- `--join=big_tbl_name, -j big_tbl_name`  
Join all tables named on the command line into a single packed table `big_tbl_name`. All tables that are to be combined *must* have identical structure (same column names and types, same indexes, and so forth).  
  
`big_tbl_name` must not exist prior to the join operation. All source tables named on the command line to be merged into `big_tbl_name` must exist. The source tables are read for the join operation but not modified. The join operation does not create a `.frm` file for `big_tbl_name`, so after the join operation finishes, copy the `.frm` file from one of the source tables and name it `big_tbl_name.frm`.
- `--silent, -s`  
Silent mode. Write output only when errors occur.
- `--test, -t`  
Do not actually pack the table, just test packing it.
- `--tmpdir=path, -T path`  
Use the named directory as the location where `myisampack` creates temporary files.
- `--verbose, -v`  
Verbose mode. Write information about the progress of the packing operation and its result.
- `--version, -V`  
Display version information and exit.
- `--wait, -w`  
Wait and retry if the table is in use. If the `mysqld` server was invoked with external locking disabled, it is not a good idea to invoke `myisampack` if the table might be updated by the server during the packing process.

The following sequence of commands illustrates a typical table compression session:

```
shell> ls -l station.*
-rw-rw-r-- 1 monty my 994128 Apr 17 19:00 station.MYD
-rw-rw-r-- 1 monty my 53248 Apr 17 19:00 station.MYI
-rw-rw-r-- 1 monty my 5767 Apr 17 19:00 station.frm
```

```

shell> myisamchk -dvv station

MyISAM file:      station
Isam-version:    2
Creation time:   1996-03-13 10:08:58
Recover time:   1997-02-02  3:06:43
Data records:   1192 Deleted blocks:      0
Datafile parts: 1192 Deleted data:        0
Datafile pointer (bytes): 2 Keyfile pointer (bytes): 2
Max datafile length: 54657023 Max keyfile length: 33554431
Recordlength:   834
Record format:  Fixed length

table description:
Key Start Len Index Type Root Blocksize Rec/key
1 2 4 unique unsigned long 1024 1024 1
2 32 30 multip. text 10240 1024 1

Field Start Length Type
1 1 1
2 2 4
3 6 4
4 10 1
5 11 20
6 31 1
7 32 30
8 62 35
9 97 35
10 132 35
11 167 4
12 171 16
13 187 35
14 222 4
15 226 16
16 242 20
17 262 20
18 282 20
19 302 30
20 332 4
21 336 4
22 340 1
23 341 8
24 349 8
25 357 8
26 365 2
27 367 2
28 369 4
29 373 4
30 377 1
31 378 2
32 380 8
33 388 4
34 392 4
35 396 4
36 400 4
37 404 1
38 405 4
39 409 4
40 413 4
41 417 4
42 421 4
43 425 4
44 429 20
45 449 30
46 479 1
47 480 1
48 481 79
49 560 79
50 639 79
51 718 79
52 797 8
53 805 1
54 806 1
55 807 20
56 827 4
57 831 4

shell> myisampack station.MYI
Compressing station.MYI: (1192 records)
- Calculating statistics

normal:      20 empty-space: 16 empty-zero: 12 empty-fill: 11
pre-space:   0 end-space: 12 table-lookups: 5 zero: 7
Original trees: 57 After join: 17
- Compressing file
87.14%
Remember to run myisamchk -rq on compressed tables

shell> ls -l station.*
-rw-rw-r-- 1 monty my 127874 Apr 17 19:00 station.MYD
-rw-rw-r-- 1 monty my 55296 Apr 17 19:04 station.MYI
-rw-rw-r-- 1 monty my 5767 Apr 17 19:00 station.frm

shell> myisamchk -dvv station

MyISAM file:      station
Isam-version:    2

```

```

Creation time: 1996-03-13 10:08:58
Recover time: 1997-04-17 19:04:26
Data records:          1192 Deleted blocks:          0
Datafile parts:       1192 Deleted data:            0
Datafile pointer (bytes): 3 Keyfile pointer (bytes): 1
Max datafile length: 16777215 Max keyfile length: 131071
Recordlength:         834
Record format: Compressed

table description:
Key Start Len Index Type Root Blocksize Rec/key
1 2 4 unique unsigned long 10240 1024 1
2 32 30 multip. text 54272 1024 1

Field Start Length Type Huff tree Bits
1 1 1 constant 1 0
2 2 4 zerofill(1) 2 9
3 6 4 no zeros, zerofill(1) 2 9
4 10 1 3 9
5 11 20 table-lookup 4 0
6 31 1 3 9
7 32 30 no endspace, not_always 5 9
8 62 35 no endspace, not_always, no empty 6 9
9 97 35 no empty 7 9
10 132 35 no endspace, not_always, no empty 6 9
11 167 4 zerofill(1) 2 9
12 171 16 no endspace, not_always, no empty 5 9
13 187 35 no endspace, not_always, no empty 6 9
14 222 4 zerofill(1) 2 9
15 226 16 no endspace, not_always, no empty 5 9
16 242 20 no endspace, not_always 8 9
17 262 20 no endspace, no empty 8 9
18 282 20 no endspace, no empty 5 9
19 302 30 no endspace, no empty 6 9
20 332 4 always zero 2 9
21 336 4 always zero 2 9
22 340 1 3 9
23 341 8 table-lookup 9 0
24 349 8 table-lookup 10 0
25 357 8 always zero 2 9
26 365 2 2 9
27 367 2 no zeros, zerofill(1) 2 9
28 369 4 no zeros, zerofill(1) 2 9
29 373 4 table-lookup 11 0
30 377 1 3 9
31 378 2 no zeros, zerofill(1) 2 9
32 380 8 no zeros 2 9
33 388 4 always zero 2 9
34 392 4 table-lookup 12 0
35 396 4 no zeros, zerofill(1) 13 9
36 400 4 no zeros, zerofill(1) 2 9
37 404 1 2 9
38 405 4 no zeros 2 9
39 409 4 always zero 2 9
40 413 4 no zeros 2 9
41 417 4 always zero 2 9
42 421 4 no zeros 2 9
43 425 4 always zero 2 9
44 429 20 no empty 3 9
45 449 30 no empty 3 9
46 479 1 14 4
47 480 1 14 4
48 481 79 no endspace, no empty 15 9
49 560 79 no empty 2 9
50 639 79 no empty 2 9
51 718 79 no endspace 16 9
52 797 8 no empty 2 9
53 805 1 17 1
54 806 1 3 9
55 807 20 no empty 3 9
56 827 4 no zeros, zerofill(2) 2 9
57 831 4 no zeros, zerofill(1) 2 9

```

`myisampack` displays the following kinds of information:

- `normal`

The number of columns for which no extra packing is used.

- `empty-space`

The number of columns containing values that are only spaces. These occupy one bit.

- `empty-zero`

The number of columns containing values that are only binary zeros. These occupy one bit.

- `empty-fill`

The number of integer columns that do not occupy the full byte range of their type. These are changed to a smaller type. For example, a `BIGINT` column (eight bytes) can be stored as a `TINYINT` column (one byte) if all its values are in the range from `-128` to `127`.

- `pre-space`

The number of decimal columns that are stored with leading spaces. In this case, each value contains a count for the number of leading spaces.

- `end-space`

The number of columns that have a lot of trailing spaces. In this case, each value contains a count for the number of trailing spaces.

- `table-lookup`

The column had only a small number of different values, which were converted to an `ENUM` before Huffman compression.

- `zero`

The number of columns for which all values are zero.

- `Original trees`

The initial number of Huffman trees.

- `After join`

The number of distinct Huffman trees left after joining trees to save some header space.

After a table has been compressed, `myisamchk -dvv` prints additional information about each column:

- `Type`

The data type. The value may contain any of the following descriptors:

- `constant`

All rows have the same value.

- `no endspace`

Do not store endspace.

- `no endspace, not_always`

Do not store endspace and do not do endspace compression for all values.

- `no endspace, no empty`

Do not store endspace. Do not store empty values.

- `table-lookup`

The column was converted to an `ENUM`.

- `zerofill(N)`

The most significant `N` bytes in the value are always 0 and are not stored.

- `no zeros`

Do not store zeros.

- `always zero`

Zero values are stored using one bit.

- `Huff tree`

The number of the Huffman tree associated with the column.

- `Bits`

The number of bits used in the Huffman tree.

After you run `myisampack`, you must run `myisamchk` to re-create any indexes. At this time, you can also sort the index blocks and create statistics needed for the MySQL optimizer to work more efficiently:

```
shell> myisamchk -rq --sort-index --analyze tbl_name.MYI
```

After you have installed the packed table into the MySQL database directory, you should execute `mysqladmin flush-tables` to force `mysqld` to start using the new table.

To unpack a packed table, use the `--unpack` option to `myisamchk`.

## 4.6.6. `mysqlaccess` — Client for Checking Access Privileges

`mysqlaccess` is a diagnostic tool that Yves Carrier has provided for the MySQL distribution. It checks the access privileges for a host name, user name, and database combination. Note that `mysqlaccess` checks access using only the `user`, `db`, and `host` tables. It does not check table, column, or routine privileges specified in the `tables_priv`, `columns_priv`, or `procs_priv` tables.

Invoke `mysqlaccess` like this:

```
shell> mysqlaccess [host_name [user_name [db_name]]] [options]
```

`mysqlaccess` supports the following options:

**Table 4.10. `mysqlaccess` Option Reference**

Format	Config File	Description	Introduc- tion	Deprec- ated	Removed
<code>--brief</code>	<code>brief</code>	Generate reports in single-line tabular format			
<code>--commit</code>	<code>commit</code>	Copy the new access privileges from the temporary tables to the original grant tables			
<code>--copy</code>	<code>copy</code>	Reload the temporary grant tables from original ones			
<code>--db=db_name</code>	<code>db</code>	Specify the database name			
<code>--debug=#</code>	<code>debug</code>	Specify the debug level			
<code>--help</code>		Display help message and exit			
<code>--host=host_name</code>	<code>host</code>	Connect to the MySQL server on the given host			
<code>--howto</code>	<code>howto</code>	Display some examples that show how to use <code>mysqlaccess</code>			
<code>--old_server</code>	<code>old_server</code>	Assume that the server is an old MySQL server (prior to MySQL 3.21)			
<code>- -pass- word[=password]</code>	<code>password</code>	The password to use when connecting to the server			
<code>--plan</code>	<code>plan</code>	Display suggestions and ideas for future releases			
<code>--preview</code>	<code>preview</code>	Show the privilege differences after making changes to the temporary grant tables			
<code>--relnotes</code>	<code>relnotes</code>	Display the release notes			
<code>- -rhost=host_name</code>	<code>rhost</code>	Connect to the MySQL server on the given host			
<code>--rollback</code>	<code>rollback</code>	Undo the most recent changes to the temporary grant tables.			
<code>- -spass- word[=password]</code>	<code>spassword</code>	The password to use when connecting to the server as the superuser			



Format	Config File	Description	Introduc- tion	Deprec- ated	Removed
- -super- user=user_name	superuser	Specify the user name for connecting as the super- user			
--table	table	Generate reports in table format			
- -user=user_name,	user	The MySQL user name to use when connecting			
--version		Display version information and exit			

- `--help, -?`  
Display a help message and exit.
- `--brief, -b`  
Generate reports in single-line tabular format.
- `--commit`  
Copy the new access privileges from the temporary tables to the original grant tables. The grant tables must be flushed for the new privileges to take effect. (For example, execute a `mysqladmin reload` command.)
- `--copy`  
Reload the temporary grant tables from original ones.
- `--db=db_name, -d db_name`  
Specify the database name.
- `--debug=N`  
Specify the debug level. *N* can be an integer from 0 to 3.
- `--host=host_name, -h host_name`  
The host name to use in the access privileges.
- `--howto`  
Display some examples that show how to use `mysqlaccess`.
- `--old_server`  
Assume that the server is an old MySQL server (before MySQL 3.21) that does not yet know how to handle full `WHERE` clauses.
- `--password[=password], -p[password]`  
The password to use when connecting to the server. If you omit the `password` value following the `--password` or `-p` option on the command line, you are prompted for one.  
  
Specifying a password on the command line should be considered insecure. See [Section 5.5.6.2, “End-User Guidelines for Password Security”](#).
- `--plan`  
Display suggestions and ideas for future releases.
- `--preview`  
Show the privilege differences after making changes to the temporary grant tables.
- `--relnotes`  
Display the release notes.

- `--rhost=host_name, -H host_name`  
Connect to the MySQL server on the given host.
- `--rollback`  
Undo the most recent changes to the temporary grant tables.
- `--spassword[=password], -P[password]`  
The password to use when connecting to the server as the superuser. If you omit the `password` value following the `--password` or `-P` option on the command line, you are prompted for one.  
Specifying a password on the command line should be considered insecure. See [Section 5.5.6.2, “End-User Guidelines for Password Security”](#).
- `--superuser=user_name, -U user_name`  
Specify the user name for connecting as the superuser.
- `--table, -t`  
Generate reports in table format.
- `--user=user_name, -u user_name`  
The user name to use in the access privileges.
- `--version, -v`  
Display version information and exit.

If your MySQL distribution is installed in some non-standard location, you must change the location where `mysqlaccess` expects to find the `mysql` client. Edit the `mysqlaccess` script at approximately line 18. Search for a line that looks like this:

```
$MYSQL = '/usr/local/bin/mysql'; # path to mysql executable
```

Change the path to reflect the location where `mysql` actually is stored on your system. If you do not do this, a `Broken pipe` error will occur when you run `mysqlaccess`.

## 4.6.7. `mysqlbinlog` — Utility for Processing Binary Log Files

The server's binary log consists of files containing “events” that describe modifications to database contents. The server writes these files in binary format. To display their contents in text format, use the `mysqlbinlog` utility. You can also use `mysqlbinlog` to display the contents of relay log files written by a slave server in a replication setup because relay logs have the same format as binary logs. The binary log and relay log are discussed further in [Section 5.2.4, “The Binary Log”](#), and [Section 16.4.2, “Replication Relay and Status Files”](#).

Invoke `mysqlbinlog` like this:

```
shell> mysqlbinlog [options] log_file ...
```

For example, to display the contents of the binary log file named `binlog.000003`, use this command:

```
shell> mysqlbinlog binlog.000003
```

The output includes events contained in `binlog.000003`. Event information includes the statement, the ID of the server on which it was executed, the timestamp when the statement was executed, how much time it took, and so forth.

The output from `mysqlbinlog` can be re-executed (for example, by using it as input to `mysql`) to reapply the statements in the log. This is useful for recovery operations after a server crash. For other usage examples, see the discussion later in this section.

Normally, you use `mysqlbinlog` to read binary log files directly and apply them to the local MySQL server. It is also possible to read binary logs from a remote server by using the `--read-from-remote-server` option. When you read remote binary logs, the connection parameter options can be given to indicate how to connect to the server. These options are `--host`, `--password`, `--port`, `--protocol`, `--socket`, and `--user`; they are ignored except when you also use the `--read-from-remote-server` option.

`mysqlbinlog` supports the following options. It also reads option files and supports the options for processing them described at

Section 4.2.3.2.1, “Command-Line Options that Affect Option-File Handling”.

**Table 4.11. `mysqlbinlog` Option Reference**

Format	Config File	Description	Introduction	Deprecated	Removed
- -base64-output[= value]	base64-output	Print binary log entries using base-64 encoding	5.1.5		
- -character-sets-dir= path	character-sets-dir	The directory where character sets are installed			
- -database=db_name	database	List entries for just this database			
- -debug[= debug_options]	debug	Write a debugging log			
--debug-check	debug-check	Print debugging information when the program exits	5.1.21		
--debug-info	debug-info	Print debugging information, memory and CPU statistics when the program exits	5.1.21		
--disable-log-bin	disable-log-bin	Disable binary logging			
--force-read	force-read	If <code>mysqlbinlog</code> reads a binary log event that it does not recognize, it prints a warning			
--help		Display help message and exit			
--hexdump	hexdump	Display a hex dump of the log in comments	5.1.2		
--host=host_name	host	Connect to the MySQL server on the given host			
--local-load=path	local-load	Prepare local temporary files for LOAD DATA INFILE in the specified directory			
--offset=#	offset	Skip the first N entries in the log			
- -password[= password]	password	The password to use when connecting to the server			
--port=port_num	port	The TCP/IP port number to use for the connection			
--protocol=type	protocol	The connection protocol to use			
- -read-from-re- mote-server	read-from-re- mote-server	Read the binary log from a MySQL server rather than reading a local log file			
--result-file=name	result-file	Direct output to the given file			
--server-id=id	server-id	Extract only those events created by the server having the given server ID	5.1.4		
- -set-charset= charset_name	set-charset	Add a SET NAMES <code>charset_name</code> statement to the output	5.1.12		
--short-form	short-form	Display only the statements contained in the log			
--socket=path	socket	For connections to localhost			
- -start-date- time=datetime	start-datetime	Start reading the binary log at the first event having a timestamp equal to or later than the datetime argument			
--start-position=#	start-position	Start reading the binary log at the first event having a position equal to or greater than the argument			
-	stop-datetime	Stop reading the binary log at the first event having			

Format	Config File	Description	Introduction	Deprecated	Removed
<code>-stop-date-time=datetime</code>		a timestamp equal to or greater than the datetime argument			
<code>--stop-position=#</code>	<code>stop-position</code>	Stop reading the binary log at the first event having a position equal to or greater than the argument			
<code>--to-last-log</code>	<code>to-last-log</code>	Do not stop at the end of the requested binary log from a MySQL server, but rather continue printing until the end of the last binary log			
<code>-user=user_name,</code>	<code>user</code>	The MySQL user name to use when connecting to the server			
<code>--verbose</code>		Reconstruct row events as SQL statements	5.1.28		
<code>--version</code>		Display version information and exit			
<code>--write-binlog</code>	<code>write-binlog</code>	Log ANALYZE, OPTIMIZE, REPAIR statements to binary log. <code>--skip-write-binlog</code> adds <code>NO_WRITE_TO_BINLOG</code> to these statements.	5.1.18		

- `--help, -?`

Display a help message and exit.

- `--base64-output[=value]`

This option determines when events should be displayed encoded as base-64 strings using `BINLOG` statements. The option has these allowable values (not case sensitive):

- `AUTO` ("automatic") or `UNSPEC` ("unspecified") displays `BINLOG` statements automatically when necessary (that is, for format description events and row events). This is the default if no `--base64-output` option is given.

#### Note

Automatic `BINLOG` display is the only safe behavior if you intend to use the output of `mysqlbinlog` to re-execute binary log file contents. The other option values are intended only for debugging or testing purposes because they may produce output that does not include all events in executable form.

- `ALWAYS` displays `BINLOG` statements whenever possible. This is the implied value if the option is given as `--base64-output` without a value.
- `NEVER` causes `BINLOG` statements not to be displayed. `mysqlbinlog` exits with an error if a row event is found that must be displayed using `BINLOG`.
- `DECODE-ROWS` specifies to `mysqlbinlog` that you intend for row events to be decoded and displayed as commented SQL statements by also specifying the `--verbose` option. Like `NEVER`, `DECODE-ROWS` suppresses display of `BINLOG` statements, but unlike `NEVER`, it does not exit with an error if a row event is found.

The `--base64-output` option was introduced in MySQL 5.1.5, to be given as `--base64-output` or `--skip-base64-output` (with the sense of `AUTO` or `NEVER`). The option values described in the preceding list may be used as of MySQL 5.1.24, with the exception of `UNSPEC` and `DECODE-ROWS`, which are available as of MySQL 5.1.28.

For examples that show the effect of `--base64-output` and `--verbose` on row event output, see [Section 4.6.7.2, "mysqlbinlog Row Event Display"](#).

- `--character-sets-dir=path`

The directory where character sets are installed. See [Section 9.2, "The Character Set Used for Data and Sorting"](#).

- `--database=db_name, -d db_name`

List entries for just this database (local log only). You can only specify one database with this option - if you specify multiple `--database` options, only the last one is used. This option forces `mysqlbinlog` to output entries from the binary log where the default database (that is, the one selected by `USE`) is `db_name`. Note that this does not replicate cross-database statements such as `UPDATE some_db.some_table SET foo='bar'` while having selected a different database or no database.

- `--debug[=debug_options], -# [debug_options]`

Write a debugging log. A typical *debug\_options* string is `'d:t:o,file_name'`. The default is `'d:t:o,/tmp/mysqlbinlog.trace'`.

- `--debug-check`

Print some debugging information when the program exits. This option was added in MySQL 5.1.21.

- `--debug-info`

Print debugging information and memory and CPU usage statistics when the program exits. This option was added in MySQL 5.1.21.

- `--disable-log-bin, -D`

Disable binary logging. This is useful for avoiding an endless loop if you use the `--to-last-log` option and are sending the output to the same MySQL server. This option also is useful when restoring after a crash to avoid duplication of the statements you have logged.

This option requires that you have the `SUPER` privilege. It causes `mysqlbinlog` to include a `SET sql_log_bin = 0` statement in its output to disable binary logging of the remaining output. The `SET` statement is ineffective unless you have the `SUPER` privilege.

- `--force-read, -f`

With this option, if `mysqlbinlog` reads a binary log event that it does not recognize, it prints a warning, ignores the event, and continues. Without this option, `mysqlbinlog` stops if it reads such an event.

- `--hexdump, -H`

Display a hex dump of the log in comments, as described in [Section 4.6.7.1, “mysqlbinlog Hex Dump Format”](#). This output can be helpful for replication debugging. This option was added in MySQL 5.1.2.

- `--host=host_name, -h host_name`

Get the binary log from the MySQL server on the given host.

- `--local-load=path, -l path`

Prepare local temporary files for `LOAD DATA INFILE` in the specified directory.

- `--offset=N, -o N`

Skip the first *N* entries in the log.

- `--password[=password], -p[password]`

The password to use when connecting to the server. If you use the short option form (`-p`), you *cannot* have a space between the option and the password. If you omit the *password* value following the `--password` or `-p` option on the command line, you are prompted for one.

Specifying a password on the command line should be considered insecure. See [Section 5.5.6.2, “End-User Guidelines for Password Security”](#).

- `--port=port_num, -P port_num`

The TCP/IP port number to use for connecting to a remote server.

- `--position=N, -j N`

Deprecated. Use `--start-position` instead.

- `--protocol={TCP|SOCKET|PIPE|MEMORY}`

The connection protocol to use for connecting to the server. It is useful when the other connection parameters normally would cause a protocol to be used other than the one you want. For details on the allowable values, see [Section 4.2.2, “Connecting to the MySQL Server”](#).

- `--read-from-remote-server, -R`

Read the binary log from a MySQL server rather than reading a local log file. Any connection parameter options are ignored unless this option is given as well. These options are `--host`, `--password`, `--port`, `--protocol`, `--socket`, and `-`

`-user`.

This option requires that the remote server be running. It works only for binary log files on the remote server, not relay log files.

- `--result-file=name, -r name`

Direct output to the given file.

- `--server-id=id`

Extract only those events created by the server having the given server ID. This option is available as of MySQL 5.1.4.

- `--set-charset=charset_name`

Add a `SET NAMES charset_name` statement to the output to specify the character set to be used for processing log files. This option was added in MySQL 5.1.12.

- `--short-form, -s`

Display only the statements contained in the log, without any extra information.

- `--socket=path, -S path`

For connections to `localhost`, the Unix socket file to use, or, on Windows, the name of the named pipe to use.

- `--start-datetime=datetime`

Start reading the binary log at the first event having a timestamp equal to or later than the `datetime` argument. The `datetime` value is relative to the local time zone on the machine where you run `mysqlbinlog`. The value should be in a format accepted for the `DATETIME` or `TIMESTAMP` data types. For example:

```
shell> mysqlbinlog --start-datetime="2005-12-25 11:25:56" binlog.000003
```

This option is useful for point-in-time recovery. See [Section 6.2, “Example Backup and Recovery Strategy”](#).

- `--start-position=N`

Start reading the binary log at the first event having a position equal to or greater than `N`. This option applies to the first log file named on the command line.

- `--stop-datetime=datetime`

Stop reading the binary log at the first event having a timestamp equal to or later than the `datetime` argument. This option is useful for point-in-time recovery. See the description of the `--start-datetime` option for information about the `datetime` value.

- `--stop-position=N`

Stop reading the binary log at the first event having a position equal to or greater than `N`. This option applies to the last log file named on the command line.

- `--to-last-log, -t`

Do not stop at the end of the requested binary log from a MySQL server, but rather continue printing until the end of the last binary log. If you send the output to the same MySQL server, this may lead to an endless loop. This option requires `--read-from-remote-server`.

- `--user=user_name, -u user_name`

The MySQL user name to use when connecting to a remote server.

- `--verbose, -v`

Reconstruct row events and display them as commented SQL statements. If given twice, the output includes comments to indicate column data types and some metadata. This option was added in MySQL 5.1.28.

For examples that show the effect of `--base64-output` and `--verbose` on row event output, see [Section 4.6.7.2, “mysqlbinlog Row Event Display”](#).

- `--version, -V`

Display version information and exit.

- `--write-binlog`

This option is enabled by default, so that `ANALYZE TABLE`, `OPTIMIZE TABLE`, and `REPAIR TABLE` statements generated by `mysqlcheck` are written to the binary log. Use `--skip-write-binlog` to cause `NO_WRITE_TO_BINLOG` to be added to the statements so that they are not logged. Use the `--skip-write-binlog` when these statements should not be sent to replication slaves or run when using the binary logs for recovery from backup. This option was added in MySQL 5.1.18.

You can also set the following variable by using `--var_name=value` syntax:

- `open_files_limit`

Specify the number of open file descriptors to reserve.

You can pipe the output of `mysqlbinlog` into the `mysql` client to execute the statements contained in the binary log. This is used to recover from a crash when you have an old backup (see Section 6.1, “Database Backups”). For example:

```
shell> mysqlbinlog binlog.000001 | mysql
```

Or:

```
shell> mysqlbinlog binlog.[0-9]* | mysql
```

You can also redirect the output of `mysqlbinlog` to a text file instead, if you need to modify the statement log first (for example, to remove statements that you do not want to execute for some reason). After editing the file, execute the statements that it contains by using it as input to the `mysql` program.

`mysqlbinlog` has the `--start-position` option, which prints only those statements with an offset in the binary log greater than or equal to a given position (the given position must match the start of one event). It also has options to stop and start when it sees an event with a given date and time. This enables you to perform point-in-time recovery using the `--stop-datetime` option (to be able to say, for example, “roll forward my databases to how they were today at 10:30 a.m.”).

If you have more than one binary log to execute on the MySQL server, the safe method is to process them all using a single connection to the server. Here is an example that demonstrates what may be *unsafe*:

```
shell> mysqlbinlog binlog.000001 | mysql # DANGER!!
shell> mysqlbinlog binlog.000002 | mysql # DANGER!!
```

Processing binary logs this way using different connections to the server causes problems if the first log file contains a `CREATE TEMPORARY TABLE` statement and the second log contains a statement that uses the temporary table. When the first `mysql` process terminates, the server drops the temporary table. When the second `mysql` process attempts to use the table, the server reports “unknown table.”

To avoid problems like this, use a *single* connection to execute the contents of all binary logs that you want to process. Here is one way to do so:

```
shell> mysqlbinlog binlog.000001 binlog.000002 | mysql
```

Another approach is to write all the logs to a single file and then process the file:

```
shell> mysqlbinlog binlog.000001 > /tmp/statements.sql
shell> mysqlbinlog binlog.000002 >> /tmp/statements.sql
shell> mysql -e "source /tmp/statements.sql"
```

`mysqlbinlog` can produce output that reproduces a `LOAD DATA INFILE` operation without the original data file. `mysqlbinlog` copies the data to a temporary file and writes a `LOAD DATA LOCAL INFILE` statement that refers to the file. The default location of the directory where these files are written is system-specific. To specify a directory explicitly, use the `-local-load` option.

Because `mysqlbinlog` converts `LOAD DATA INFILE` statements to `LOAD DATA LOCAL INFILE` statements (that is, it adds `LOCAL`), both the client and the server that you use to process the statements must be configured to allow `LOCAL` capability. See Section 5.3.4, “Security Issues with `LOAD DATA LOCAL`”.

**MySQL Enterprise**  
For expert advice on the security implications of enabling `LOCAL`, subscribe to the MySQL Enterprise Mon-

itor. For more information, see <http://www.mysql.com/products/enterprise/advisors.html>.

### Warning

The temporary files created for `LOAD DATA LOCAL` statements are *not* automatically deleted because they are needed until you actually execute those statements. You should delete the temporary files yourself after you no longer need the statement log. The files can be found in the temporary file directory and have names like `origin-al_file_name-#-#`.

## 4.6.7.1. mysqlbinlog Hex Dump Format

The `--hexdump` option produces a hex dump of the log contents:

```
shell> mysqlbinlog --hexdump master-bin.000001
```

The hex output consists of comment lines beginning with `#`, so the output might look like this for the preceding command:

```
/*140019 SET @@session.max_insert_delayed_threads=0*/;
/*150003 SET @@OLD_COMPLETION_TYPE@@COMPLETION_TYPE,COMPLETION_TYPE=0*/;
# at 4
#051024 17:24:13 server id 1 end_log_pos 98
# Position Timestamp Type Master ID Size Master Pos Flags
# 00000004 9d fc 5c 43 0f 01 00 00 00 5e 00 00 00 62 00 00 00 00 00
# 00000017 04 00 35 2e 30 2e 31 35 2d 64 65 62 75 67 2d 6c |..5.0.15.debug.l
# 00000027 6f 67 00 00 00 00 00 00 00 00 00 00 00 00 00 00 |og.....
# 00000037 00 00 00 00 00 00 00 00 00 00 00 00 00 00 00 00 |.....
# 00000047 00 00 00 00 9d fc 5c 43 13 38 0d 00 08 00 12 00 |.....C.8.....
# 00000057 04 04 04 04 12 00 00 4b 00 04 1a |.....K...|
# Start: binlog v 4, server v 5.0.15-debug-log created 051024 17:24:13
# at startup
ROLLBACK;
```

Hex dump output currently contains the following elements. This format is subject to change.

- **Position:** The byte position within the log file.
- **Timestamp:** The event timestamp. In the example shown, '9d fc 5c 43' is the representation of '051024 17:24:13' in hexadecimal.
- **Type:** The event type code. In the example shown, '0f' indicates a `FORMAT_DESCRIPTION_EVENT`. The following table lists the possible type codes.

Type	Name	Meaning
00	UNKNOWN_EVENT	This event should never be present in the log.
01	START_EVENT_V3	This indicates the start of a log file written by MySQL 4 or earlier.
02	QUERY_EVENT	The most common type of events. These contain statements executed on the master.
03	STOP_EVENT	Indicates that master has stopped.
04	ROTATE_EVENT	Written when the master switches to a new log file.
05	INTVAR_EVENT	Used for <code>AUTO_INCREMENT</code> values or when the <code>LAST_INSERT_ID()</code> function is used in the statement.
06	LOAD_EVENT	Used for <code>LOAD DATA INFILE</code> in MySQL 3.23.
07	SLAVE_EVENT	Reserved for future use.
08	CREATE_FILE_EVENT	Used for <code>LOAD DATA INFILE</code> statements. This indicates the start of execution of such a statement. A temporary file is created on the slave. Used in MySQL 4 only.
09	APPEND_BLOCK_EVENT	Contains data for use in a <code>LOAD DATA INFILE</code> statement. The data is stored in the temporary file on the slave.
0a	EXEC_LOAD_EVENT	Used for <code>LOAD DATA INFILE</code> statements. The contents of the temporary file is stored in the table on the slave. Used in MySQL 4 only.
0b	DELETE_FILE_EVENT	Rollback of a <code>LOAD DATA INFILE</code> statement. The temporary file should be deleted on the slave.
0c	NEW_LOAD_EVENT	Used for <code>LOAD DATA INFILE</code> in MySQL 4 and earlier.
0d	RAND_EVENT	Used to send information about random values if the <code>RAND()</code> function is used in the statement.
0e	USER_VAR_EVENT	Used to replicate user variables.
0f	FORMAT_DESCRIPTION_EVENT	This indicates the start of a log file written by MySQL 5 or later.



10	XID_EVENT	Event indicating commit of an XA transaction.
11	BE- GIN_LOAD_QUERY_E VENT	Used for <code>LOAD DATA INFILE</code> statements in MySQL 5 and later.
12	EX- ECUTE_LOAD_QUERY _EVENT	Used for <code>LOAD DATA INFILE</code> statements in MySQL 5 and later.
13	TABLE_MAP_EVENT	Information about a table definition. Used in MySQL 5.1.5 and later.
14	PRE_GA_WRITE_ROW S_EVENT	Row data for a single table that should be created. Used in MySQL 5.1.5 to 5.1.17.
15	PRE_GA_UPDATE_ROW S_EVENT	Row data for a single table that needs to be updated. Used in MySQL 5.1.5 to 5.1.17.
16	PRE_GA_DELETE_ROW S_EVENT	Row data for a single table that should be deleted. Used in MySQL 5.1.5 to 5.1.17.
17	WRITE_ROWS_EVENT	Row data for a single table that should be created. Used in MySQL 5.1.18 and later.
18	UP- DATE_ROWS_EVENT	Row data for a single table that needs to be updated. Used in MySQL 5.1.18 and later.
19	DE- LETE_ROWS_EVENT	Row data for a single table that should be deleted. Used in MySQL 5.1.18 and later.
1a	INCIDENT_EVENT	Something out of the ordinary happened. Added in MySQL 5.1.18.

- **Master ID:** The server ID of the master that created the event.
- **Size:** The size in bytes of the event.
- **Master Pos:** The position of the next event in the original master log file.
- **Flags:** 16 flags. Currently, the following flags are used. The others are reserved for future use.

Flag	Name	Meaning
01	LOG_EVENT_BINLOG _IN_USE_F	Log file correctly closed. (Used only in <code>FORMAT_DESCRIPTION_EVENT</code> .) If this flag is set (if the flags are, for example, '01 00') in a <code>FORMAT_DESCRIPTION_EVENT</code> , the log file has not been properly closed. Most probably this is because of a master crash (for example, due to power failure).
02		Reserved for future use.
04	LOG_EVENT_THREAD _SPECIFIC_F	Set if the event is dependent on the connection it was executed in (for example, '04 00'), for example, if the event uses temporary tables.
08	LOG_EVENT_SUPPRE SS_USE_F	Set in some circumstances when the event is not dependent on the default database.

#### 4.6.7.2. `mysqlbinlog` Row Event Display

The following examples illustrate how `mysqlbinlog` displays row events that specify data modifications. These correspond to events with the `WRITE_ROWS_EVENT`, `UPDATE_ROWS_EVENT`, and `DELETE_ROWS_EVENT` type codes. The `--base64-output=DECODE-ROWS` and `--verbose` options may be used to affect row event output. These options are available as of MySQL 5.1.28.

Suppose that the server is using row-based binary logging and that you execute the following sequence of statements:

```
CREATE TABLE t
(
  id INT NOT NULL,
  name VARCHAR(20) NOT NULL,
  date DATE NULL
) ENGINE = InnoDB;

START TRANSACTION;
INSERT INTO t VALUES(1, 'apple', NULL);
UPDATE t SET name = 'pear', date = '2009-01-01' WHERE id = 1;
DELETE FROM t WHERE id = 1;
COMMIT;
```

By default, `mysqlbinlog` displays row events encoded as base-64 strings using `BINLOG` statements. Omitting extraneous lines, the output for the row events produced by the preceding statement sequence looks like this:

```
shell> mysqlbinlog log_file
...
# at 218
#080828 15:03:08 server id 1  end_log_pos 258          Write_rows: table id 17 flags: STMT_END_F

BINLOG '
fAS3SBMBAAAAALAAAAANoAAAAABEAAAAAAAAABHRlc3QAAXQAawMPCgIUAAQ=
fAS3SBcBAAAAKAAAAAIBAAAQABEAAAAAAAAEAA//8AQAAAAVhcHBsZQ==
'/*!*/;
...
# at 302
#080828 15:03:08 server id 1  end_log_pos 356          Update_rows: table id 17 flags: STMT_END_F

BINLOG '
fAS3SBMBAAAAALAAAAc4BAAAAABEAAAAAAAAABHRlc3QAAXQAawMPCgIUAAQ=
fAS3SBgBAAAAANGAAAGQBAAAQABEAAAAAAAAEAAA//AEAAAAFYXBwbGx4AQAAAAARwZWZyIbIP
'/*!*/;
...
# at 400
#080828 15:03:08 server id 1  end_log_pos 442          Delete_rows: table id 17 flags: STMT_END_F

BINLOG '
fAS3SBMBAAAAALAAAAJABAAAAABEAAAAAAAAABHRlc3QAAXQAawMPCgIUAAQ=
fAS3SBkBAAAAkGAAALoBAAAQABEAAAAAAAAEAA//4AQAAAAARwZWZyIbIP
'/*!*/;
```

To see the row events as comments in the form of “pseudo-SQL” statements, run `mysqlbinlog` with the `--verbose` or `-v` option. The output will contain lines beginning with `###`:

```
shell> mysqlbinlog -v log_file
...
# at 218
#080828 15:03:08 server id 1  end_log_pos 258          Write_rows: table id 17 flags: STMT_END_F

BINLOG '
fAS3SBMBAAAAALAAAAANoAAAAABEAAAAAAAAABHRlc3QAAXQAawMPCgIUAAQ=
fAS3SBcBAAAAKAAAAAIBAAAQABEAAAAAAAAEAA//8AQAAAAVhcHBsZQ==
'/*!*/;
### INSERT INTO test.t
### SET
###   @1=1
###   @2='apple'
###   @3=NULL
...
# at 302
#080828 15:03:08 server id 1  end_log_pos 356          Update_rows: table id 17 flags: STMT_END_F

BINLOG '
fAS3SBMBAAAAALAAAAc4BAAAAABEAAAAAAAAABHRlc3QAAXQAawMPCgIUAAQ=
fAS3SBgBAAAAANGAAAGQBAAAQABEAAAAAAAAEAAA//AEAAAAFYXBwbGx4AQAAAAARwZWZyIbIP
'/*!*/;
### UPDATE test.t
### WHERE
###   @1=1
###   @2='apple'
###   @3=NULL
### SET
###   @1=1
###   @2='pear'
###   @3='2009:01:01'
...
# at 400
#080828 15:03:08 server id 1  end_log_pos 442          Delete_rows: table id 17 flags: STMT_END_F

BINLOG '
fAS3SBMBAAAAALAAAAJABAAAAABEAAAAAAAAABHRlc3QAAXQAawMPCgIUAAQ=
fAS3SBkBAAAAkGAAALoBAAAQABEAAAAAAAAEAA//4AQAAAAARwZWZyIbIP
'/*!*/;
### DELETE FROM test.t
### WHERE
###   @1=1
###   @2='pear'
###   @3='2009:01:01'
```

Specify `--verbose` or `-v` twice to also display data types and some metadata for each column. The output will contain an additional comment following each column change:

```
shell> mysqlbinlog -vv log_file
...
# at 218
#080828 15:03:08 server id 1  end_log_pos 258          Write_rows: table id 17 flags: STMT_END_F

BINLOG '
fAS3SBMBAAAAALAAAAANoAAAAABEAAAAAAAAABHRlc3QAAXQAawMPCgIUAAQ=
fAS3SBcBAAAAKAAAAAIBAAAQABEAAAAAAAAEAA//8AQAAAAVhcHBsZQ==
'/*!*/;
### INSERT INTO test.t
### SET
```

```

### @1=1 /* INT meta=0 nullable=0 is_null=0 */
### @2='apple' /* VARSTRING(20) meta=20 nullable=0 is_null=0 */
### @3=NULL /* VARSTRING(20) meta=0 nullable=1 is_null=1 */
...
# at 302
#080828 15:03:08 server id 1 end_log_pos 356 Update_rows: table id 17 flags: STMT_END_F

BINLOG '
fAS3SBMBAAAAALAAAA4BAAAAABEAAAAAAAAABHRlc3QAAXQAawMPCgIUAAQ=
fAS3SBgBAAAAANGAAAGQBAAAQABEAAAAAAAAEAAA///AEAAAAFYXBwbGX4AQAAAAARwZWFyIbIP
'/*!*/;
### UPDATE test.t
### WHERE
### @1=1 /* INT meta=0 nullable=0 is_null=0 */
### @2='apple' /* VARSTRING(20) meta=20 nullable=0 is_null=0 */
### @3=NULL /* VARSTRING(20) meta=0 nullable=1 is_null=1 */
### SET
### @1=1 /* INT meta=0 nullable=0 is_null=0 */
### @2='pear' /* VARSTRING(20) meta=20 nullable=0 is_null=0 */
### @3='2009:01:01' /* DATE meta=0 nullable=1 is_null=0 */
...
# at 400
#080828 15:03:08 server id 1 end_log_pos 442 Delete_rows: table id 17 flags: STMT_END_F

BINLOG '
fAS3SBMBAAAAALAAAAJABAAAAABEAAAAAAAAABHRlc3QAAXQAawMPCgIUAAQ=
fAS3SBkBAAAAkGAAALoBAAAQABEAAAAAAAAEAAA//4AQAAAAARwZWFyIbIP
'/*!*/;
### DELETE FROM test.t
### WHERE
### @1=1 /* INT meta=0 nullable=0 is_null=0 */
### @2='pear' /* VARSTRING(20) meta=20 nullable=0 is_null=0 */
### @3='2009:01:01' /* DATE meta=0 nullable=1 is_null=0 */

```

You can tell `mysqlbinlog` to suppress the `BINLOG` statements for row events by using the `--base64-output=DECODE-ROWS` option. This is similar to `--base64-output=NEVER` but does not exit with an error if a row event is found. The combination of `--base64-output=DECODE-ROWS` and `--verbose` provides a convenient way to see row events only as SQL statements:

```

shell> mysqlbinlog -v --base64-output=DECODE-ROWS log_file
...
# at 218
#080828 15:03:08 server id 1 end_log_pos 258 Write_rows: table id 17 flags: STMT_END_F
### INSERT INTO test.t
### SET
### @1=1
### @2='apple'
### @3=NULL
...
# at 302
#080828 15:03:08 server id 1 end_log_pos 356 Update_rows: table id 17 flags: STMT_END_F
### UPDATE test.t
### WHERE
### @1=1
### @2='apple'
### @3=NULL
### SET
### @1=1
### @2='pear'
### @3='2009:01:01'
...
# at 400
#080828 15:03:08 server id 1 end_log_pos 442 Delete_rows: table id 17 flags: STMT_END_F
### DELETE FROM test.t
### WHERE
### @1=1
### @2='pear'
### @3='2009:01:01'

```

## Note

You should not suppress `BINLOG` statements if you intend to re-execute `mysqlbinlog` output.

The SQL statements produced by `--verbose` for row events are much more readable than the corresponding `BINLOG` statements. However, they do not correspond exactly to the original SQL statements that generated the events. The following limitations apply:

- The original column names are lost and replaced by `@N`, where `N` is a column number.
- Character set information is not available in the binary log, which affects string column display:
  - There is no distinction made between corresponding binary and nonbinary string types (`BINARY` and `CHAR`, `VARBINARY` and `VARCHAR`, `BLOB` and `TEXT`). The output uses a data type of `STRING` for fixed-length strings and `VARSTRING` for variable-length strings.
  - For multi-byte character sets, the maximum number of bytes per character is not present in the binary log, so the length for

string types is displayed in bytes rather than in characters. For example, `STRING(4)` will be used as the data type for values from either of these column types:

```
CHAR(4) CHARACTER SET latin1
CHAR(2) CHARACTER SET ucs2
```

- Due to the storage format for events of type `UPDATE_ROWS_EVENT`, `UPDATE` statements are displayed with the `WHERE` clause preceding the `SET` clause.

Proper interpretation of row events requires the information from the format description event at the beginning of the binary log. Because `mysqlbinlog` does not know in advance whether the rest of the log contains row events, by default it displays the format description event using a `BINLOG` statement in the initial part of the output.

If the binary log is known not to contain any events requiring a `BINLOG` statement (that is, no row events), the `-base64-output=NEVER` option can be used to prevent this header from being written.

## 4.6.8. `mysqldumpslow` — Summarize Slow Query Log Files

The MySQL slow query log contains information about queries that take a long time to execute (see [Section 5.2.5, “The Slow Query Log”](#)). `mysqldumpslow` parses MySQL slow query log files and prints a summary of their contents.

Normally, `mysqldumpslow` groups queries that are similar except for the particular values of number and string data values. It “abstracts” these values to `N` and `'S'` when displaying summary output. The `-a` and `-n` options can be used to modify value abstracting behavior.

Invoke `mysqldumpslow` like this:

```
shell> mysqldumpslow [options] [log_file ...]
```

**Table 4.12. `mysqldumpslow` Option Reference**

Format	Config File	Description	Introduc- tion	Deprec- ated	Removed
<code>-a</code>		Do not abstract all numbers to <code>N</code> and strings to <code>S</code>			
<code>-n num</code>		Abstract numbers with at least the specified digits			
<code>--debug</code>	<code>debug</code>	Write debugging information			
<code>-g pattern</code>		Only consider statements that match the pattern			
<code>--help</code>		Display help message and exit			
<code>-h name</code>		Host name of the server in the log file name			
<code>-i name</code>		Name of the server instance			
<code>-l</code>		Do not subtract lock time from total time			
<code>-r</code>		Reverse the sort order			
<code>-s value</code>		How to sort output			
<code>-t num</code>		Display only first <code>num</code> queries			
<code>--verbose</code>	<code>verbose</code>	Verbose mode			

`mysqldumpslow` supports the following options:

- `--help`  
Display a help message and exit.
- `-a`  
Do not abstract all numbers to `N` and strings to `'S'`.
- `--debug, -d`  
Run in debug mode.

- `-g pattern`  
Consider only queries that match the (grep-style) pattern.
- `-h host_name`  
Host name of MySQL server for `*-slow.log` file name. The value can contain a wildcard. The default is `*` (match all).
- `-i name`  
Name of server instance (if using `mysql.server` startup script).
- `-l`  
Do not subtract lock time from total time.
- `-n N`  
Abstract numbers with at least `N` digits within names.
- `-r`  
Reverse the sort order.
- `-s sort_type`  
How to sort the output. The value of `sort_type` should be chosen from the following list:
  - `t, at`: Sort by query time or average query time
  - `l, al`: Sort by lock time or average lock time
  - `s, as`: Sort by rows sent or average rows went
  - `c`: Sort by count
- `-t N`  
Display only the first `N` queries in the output.
- `--verbose, -v`  
Verbose mode. Print more information about what the program does.

Example of usage:

```
shell> mysqldumpslow
Reading mysql slow query log from /usr/local/mysql/data/mysqld51-apple-slow.log
Count: 1  Time=4.32s (4s)  Lock=0.00s (0s)  Rows=0.0 (0), root[root]@localhost
insert into t2 select * from t1
Count: 3  Time=2.53s (7s)  Lock=0.00s (0s)  Rows=0.0 (0), root[root]@localhost
insert into t2 select * from t1 limit N
Count: 3  Time=2.13s (6s)  Lock=0.00s (0s)  Rows=0.0 (0), root[root]@localhost
insert into t1 select * from t1
```

## 4.6.9. `mysqlhotcopy` — A Database Backup Program

`mysqlhotcopy` is a Perl script that was originally written and contributed by Tim Bunce. It uses `LOCK TABLES`, `FLUSH TABLES`, and `cp` or `scp` to make a database backup quickly. It is the fastest way to make a backup of the database or single tables, but it can be run only on the same machine where the database directories are located. `mysqlhotcopy` works only for backing up `MyISAM` and `ARCHIVE` tables. It runs on Unix and NetWare.

```
shell> mysqlhotcopy db_name [/path/to/new_directory]
```

```
shell> mysqlhotcopy db_name_1 ... db_name_n /path/to/new_directory
```

Back up tables in the given database that match a regular expression:

```
shell> mysqlhotcopy db_name ./regex/
```

The regular expression for the table name can be negated by prefixing it with a tilde (“~”):

```
shell> mysqlhotcopy db_name./~regex/
```

**Table 4.13. `mysqlhotcopy` Option Reference**

Format	Config File	Description	Introduc- tion	Deprec- ated	Removed
<code>--addtodest</code>	<code>addtodest</code>	Do not rename target directory (if it exists); merely add files to it			
<code>--allowold</code>	<code>allowold</code>	Do not abort if a target exists; rename it by adding an <code>_old</code> suffix			
<code>- -check- point=db_name.tb l_name</code>	<code>checkpoint</code>	Insert checkpoint entries			
<code>--chroot=path</code>	<code>chroot</code>	Base directory of the chroot jail in which mysqld operates			
<code>--debug</code>	<code>debug</code>	Write a debugging log			
<code>--dryrun</code>	<code>dryrun</code>	Report actions without performing them			
<code>--flushlog</code>	<code>flushlog</code>	Flush logs after all tables are locked			
<code>--help</code>		Display help message and exit			
<code>--host=host_name</code>	<code>host</code>	Connect to the MySQL server on the given host			
<code>--keepold</code>	<code>keepold</code>	Do not delete previous (renamed) target when done			
<code>--noindices</code>	<code>noindices</code>	Do not include full index files in the backup			
<code>- -pass- word[=password]</code>	<code>password</code>	The password to use when connecting to the server			
<code>--port=port_num</code>	<code>port</code>	The TCP/IP port number to use for the connection			
<code>--quiet</code>	<code>quiet</code>	Be silent except for errors			
<code>--regexp</code>	<code>regexp</code>	Copy all databases with names that match the given regular expression			
<code>--resetmaster</code>	<code>resetmaster</code>	Reset the binary log after locking all the tables			
<code>--resetslave</code>	<code>resetslave</code>	Reset the master.info file after locking all the tables			
<code>--socket=path</code>	<code>socket</code>	For connections to localhost			
<code>--tmpdir=path</code>	<code>tmpdir</code>	The temporary directory			
<code>- -user=user_name,</code>	<code>user</code>	The MySQL user name to use when connecting to the server			

`mysqlhotcopy` supports the following options:

- `--help, -?`  
Display a help message and exit.
- `--addtodest`  
Do not rename target directory (if it exists); merely add files to it.
- `--allowold`  
Do not abort if a target exists; rename it by adding an `_old` suffix.
- `--checkpoint=db_name.tbl_name`  
Insert checkpoint entries into the specified database `db_name` and table `tbl_name`.

- `--chroot=path`

Base directory of the `chroot` jail in which `mysqld` operates. The `path` value should match that of the `--chroot` option given to `mysqld`.
- `--debug`

Enable debug output.
- `--dryrun, -n`

Report actions without performing them.
- `--flushlog`

Flush logs after all tables are locked.
- `--host=host_name, -h host_name`

The host name of the local host to use for making a TCP/IP connection to the local server. By default, the connection is made to `localhost` using a Unix socket file.
- `--keepold`

Do not delete previous (renamed) target when done.
- `--method=command`

The method for copying files (`cp` or `scp`).
- `--noindices`

Do not include full index files in the backup. This makes the backup smaller and faster. The indexes for reloaded tables can be reconstructed later with `myisamchk -rq`.
- `--password=password, -ppassword`

The password to use when connecting to the server. Note that the password value is not optional for this option, unlike for other MySQL programs. You can use an option file to avoid giving the password on the command line.

Specifying a password on the command line should be considered insecure. See [Section 5.5.6.2, “End-User Guidelines for Password Security”](#).
- `--port=port_num, -P port_num`

The TCP/IP port number to use when connecting to the local server.
- `--quiet, -q`

Be silent except for errors.
- `--record_log_pos=db_name.tbl_name`

Record master and slave status in the specified database `db_name` and table `tbl_name`.
- `--regexp=expr`

Copy all databases with names that match the given regular expression.
- `--resetmaster`

Reset the binary log after locking all the tables.
- `--resetslave`

Reset the `master.info` file after locking all the tables.
- `--socket=path, -S path`

The Unix socket file to use for the connection.
- `--suffix=str`

The suffix for names of copied databases.

- `--tmpdir=path`

The temporary directory. The default is `/tmp`.

- `--user=user_name, -u user_name`

The MySQL user name to use when connecting to the server.

`mysqlhotcopy` reads the `[client]` and `[mysqlhotcopy]` option groups from option files.

To execute `mysqlhotcopy`, you must have access to the files for the tables that you are backing up, the `SELECT` privilege for those tables, the `RELOAD` privilege (to be able to execute `FLUSH TABLES`), and the `LOCK TABLES` privilege (to be able to lock the tables).

Use `perldoc` for additional `mysqlhotcopy` documentation, including information about the structure of the tables needed for the `--checkpoint` and `--record_log_pos` options:

```
shell> perldoc mysqlhotcopy
```

#### MySQL Enterprise

MySQL Enterprise subscribers will find more information about `mysqlhotcopy` in the Knowledge Base article, [How Does mysqlhotcopy Work?](#). Access to the MySQL Knowledge Base collection of articles is one of the advantages of subscribing to MySQL Enterprise. For more information, see <http://www.mysql.com/products/enterprise/advisors.html>.

## 4.6.10. `mysqlmanager` — The MySQL Instance Manager

### Important

MySQL Instance Manager has been deprecated and is removed in MySQL 6.0.

`mysqlmanager` is the MySQL Instance Manager (IM). This program monitors and manages MySQL Database Server instances. MySQL Instance Manager is available for Unix-like operating systems, as well as Windows. It runs as a daemon that listens on a TCP/IP port. On Unix, it also listens on a Unix socket file.

MySQL Instance Manager can be used in place of the `mysqld_safe` script to start and stop one or more instances of MySQL Server. Because Instance Manager can manage multiple server instances, it can also be used in place of the `mysqld_multi` script. Instance Manager offers these capabilities:

- Instance Manager can start and stop instances, and report on the status of instances.
- Server instances can be treated as guarded or unguarded:
  - When Instance Manager starts, it starts each guarded instance. If the instance crashes, Instance Manager detects this and restarts it. When Instance Manager stops, it stops the instance.
  - A nonguarded instance is not started when Instance Manager starts or monitored by it. If the instance crashes after being started, Instance Manager does not restart it. When Instance Manager exits, it does not stop the instance if it is running.

Instances are guarded by default. An instance can be designated as nonguarded by including the `nonguarded` option in the configuration file.

- Instance Manager provides an interactive interface for configuring instances, so that the need to edit the configuration file manually is reduced or eliminated.
- Instance Manager provides remote instance management. That is, it runs on the host where you want to control MySQL Server instances, but you can connect to it from a remote host to perform instance-management operations.

The following sections describe MySQL Instance Manager operation in more detail.

### 4.6.10.1. MySQL Instance Manager Command Options

#### Important



MySQL Instance Manager has been deprecated and is removed in MySQL 6.0.

The MySQL Instance Manager supports a number of command options. For a brief listing, invoke `mysqlmanager` with the `-help` option. Options may be given on the command line or in the Instance Manager configuration file. On Windows, the standard configuration file is `my.ini` in the directory where Instance Manager is installed. On Unix, the standard file is `/etc/my.cnf`. To specify a different configuration file, start Instance Manager with the `--defaults-file` option.

`mysqlmanager` supports the options described in the following list. The options for managing entries in the password file are described further in [Section 4.6.10.4, “Instance Manager User and Password Management”](#).

- `--help, -?`  
Display a help message and exit.
- `--add-user`  
Add a new user (specified with the `--username` option) to the password file. This option was added in MySQL 5.1.12.
- `--angel-pid-file=file_name`  
The file in which the angel process records its process ID when `mysqlmanager` runs in daemon mode (that is, when the `--run-as-service` option is given). The default file name is `mysqlmanager.angel.pid`.  
  
If the `--angel-pid-file` option is not given, the default angel PID file has the same name as the PID file except that any PID file extension is replaced with an extension of `.angel.pid`. (For example, `mysqlmanager.pid` becomes `mysqlmanager.angel.pid`.)  
  
This option was added in MySQL 5.1.11.
- `--bind-address=IP`  
The IP address to bind to.
- `--check-password-file`  
Check the validity and consistency of the password file. This option was added in MySQL 5.1.12.
- `--clean-password-file`  
Drop all users from the password file. This option was added in MySQL 5.1.12.
- `--debug=debug_options, -# debug_options`  
Write a debugging log. A typical `debug_options` string is `'d:t:o,file_name'`. This option was added in MySQL 5.1.10.
- `--default-mysqld-path=path`  
The path name of the MySQL Server binary. This path name is used for all server instance sections in the configuration file for which no `mysqld-path` option is present. The default value of this option is the compiled-in path name, which depends on how the MySQL distribution was configured. Example: `--default-mysqld-path=/usr/sbin/mysqld`
- `--defaults-file=file_name`  
Read Instance Manager and MySQL Server settings from the given file. All configuration changes made by the Instance Manager will be written to this file. This must be the first option on the command line if it is used, and the file must exist.  
  
If this option is not given, Instance Manager uses its standard configuration file. On Windows, the standard file is `my.ini` in the directory where Instance Manager is installed. On Unix, the standard file is `/etc/my.cnf`.
- `--drop-user`  
Drop a user (specified with the `--username` option) from the password file. This option was added in MySQL 5.1.12.
- `--edit-user`  
Change an entry for an existing user (specified with the `--username` option) in the password file. This option was added in MySQL 5.1.12.
- `--install`

On Windows, install Instance Manager as a Windows service. The service name is `MySQL Manager`.

- `--list-users`

List the users in the password file. This option was added in MySQL 5.1.12.

- `--log=file_name`

The path to the Instance Manager log file. This option has no effect unless the `--run-as-service` option is also given. If the file name specified for the option is a relative name, the log file is created under the directory from which Instance Manager is started. To ensure that the file is created in a specific directory, specify it as a full path name.

If `--run-as-service` is given without `--log`, the log file is `mysqlmanager.log` in the data directory.

If `--run-as-service` is not given, log messages go to the standard output. To capture log output, you can redirect Instance Manager output to a file:

```
mysqlmanager > im.log
```

- `--monitoring-interval=seconds`

The interval in seconds for monitoring server instances. The default value is 20 seconds. Instance Manager tries to connect to each monitored (guarded) instance using the non-existing `MySQL_Instance_Manager` user account to check whether it is alive/not hanging. If the result of the connection attempt indicates that the instance is unavailable, Instance Manager performs several attempts to restart the instance.

Normally, the `MySQL_Instance_Manager` account does not exist, so the connection attempts by Instance Manager cause the monitored instance to produce messages in its general query log similar to the following:

```
Access denied for user 'MySQL_Instance_M'@'localhost' »
(using password: YES)
```

The `nonguarded` option in the appropriate server instance section disables monitoring for a particular instance. If the instance dies after being started, Instance Manager will not restart it. Instance Manager tries to connect to a nonguarded instance only when you request the instance's status (for example, with the `SHOW INSTANCES` status).

See [Section 4.6.10.5, “MySQL Server Instance Status Monitoring”](#), for more information.

- `--mysqld-safe-compatible`

Run in a `mysqld_safe`-compatible manner. For details, see [Section 4.6.10.3, “Starting the MySQL Server with MySQL Instance Manager”](#). This option was added in MySQL 5.1.12.

- `--password=password, -p password`

Specify the password for an entry to be added to or modified in the password file. Unlike the `--password/-P` option for most MySQL programs, the password value is required, not optional. See also [Section 4.6.10.4, “Instance Manager User and Password Management”](#). This option was added in MySQL 5.1.12.

- `--password-file=file_name`

The name of the file where the Instance Manager looks for users and passwords. On Windows, the default is `mysqlmanager.passwd` in the directory where Instance Manager is installed. On Unix, the default file is `/etc/mysqlmanager.passwd`. See also [Section 4.6.10.4, “Instance Manager User and Password Management”](#).

- `--pid-file=file_name`

The process ID file to use. On Windows, the default file is `mysqlmanager.pid` in the directory where Instance Manager is installed. On Unix, the default is `mysqlmanager.pid` in the data directory.

- `--port=port_num`

The port number to use when listening for TCP/IP connections from clients. The default port number (assigned by IANA) is 2273.

- `--print-defaults`

Print the current defaults and exit. This must be the first option on the command line if it is used.

- `--print-password-line`

Prepare an entry for the password file, print it to the standard output, and exit. You can redirect the output from Instance Manager to a file to save the entry in the file.

Prior to MySQL 5.1.12, this option was named `--passwd`.

- `--remove`

On Windows, removes Instance Manager as a Windows service. This assumes that Instance Manager has been run with `--install` previously.

- `--run-as-service`

On Unix, daemonize and start an angel process. The angel process monitors Instance Manager and restarts it if it crashes. (The angel process itself is simple and unlikely to crash.)

- `--socket=path`

On Unix, the socket file to use for incoming connections. The default file is named `/tmp/mysqlmanager.sock`. This option has no meaning on Windows.

- `--standalone`

This option is used on Windows to run Instance Manager in standalone mode. You should specify it when you start Instance Manager from the command line.

- `--user=user_name`

On Unix, the user name of the system account to use for starting and running `mysqlmanager`. This option generates a warning and has no effect unless you start `mysqlmanager` as `root` (so that it can change its effective user ID), or as the named user. It is recommended that you configure `mysqlmanager` to run using the same account used to run the `mysqld` server. (“User” in this context refers to a system login account, not a MySQL user listed in the grant tables.)

- `--username=user_name, -u user_name`

Specify the user name for an entry to be added to or modified in the password file. This option was added in MySQL 5.1.12.

- `--version, -V`

Display version information and exit.

- `--wait-timeout=N`

The number of seconds to wait for activity on an incoming connection before closing it. The default is 28800 seconds (8 hours).

This option was added in MySQL 5.1.7. Before that, the timeout is 30 seconds and cannot be changed.

## 4.6.10.2. MySQL Instance Manager Configuration Files

### Important

MySQL Instance Manager has been deprecated and is removed in MySQL 6.0.

Instance Manager uses its standard configuration file unless it is started with a `--defaults-file` option that specifies a different file. On Windows, the standard file is `my.ini` in the directory where Instance Manager is installed. On Unix, the standard file is `/etc/my.cnf`.

Instance Manager reads options for itself from the `[manager]` section of the configuration file, and options for server instances from `[mysqld]` or `[mysqldN]` sections. The `[manager]` section contains any of the options listed in [Section 4.6.10.1](#), “MySQL Instance Manager Command Options”, except for those specified as having to be given as the first option on the command line. Here is a sample `[manager]` section:

```
# MySQL Instance Manager options section
[manager]
default-mysqld-path = /usr/local/mysql/libexec/mysqld
socket=/tmp/manager.sock
pid-file=/tmp/manager.pid
password-file = /home/cps/.mysqlmanager.passwd
monitoring-interval = 2
port = 1999
bind-address = 192.168.1.5
```

Each `[mysqld]` or `[mysqldN]` instance section specifies options given by Instance Manager to a server instance at startup. These are mainly common MySQL Server options (see [Section 5.1.2, “Server Command Options”](#)). In addition, a `[mysqldN]` section can contain the options in the following list, which are specific to Instance Manager. These options are interpreted by Instance Manager itself; it does not pass them to the server when it attempts to start that server.

### Warning

The Instance Manager-specific options must not be used in a `[mysqld]` section. If a server is started without using Instance Manager, it will not recognize these options and will fail to start properly.

- `mysqld-path = path`

The path name of the `mysqld` server binary to use for the server instance.

- `nonguarded`

This option disables Instance Manager monitoring functionality for the server instance. By default, an instance is guarded: At Instance Manager start time, it starts the instance. It also monitors the instance status and attempts to restart it if it fails. At Instance Manager exit time, it stops the instance. None of these things happen for nonguarded instances.

- `shutdown-delay = seconds`

The number of seconds Instance Manager should wait for the server instance to shut down. The default value is 35 seconds. After the delay expires, Instance Manager assumes that the instance is hanging and attempts to terminate it. If you use [InnoDB](#) with large tables, you should increase this value.

Here are some sample instance sections:

```
[mysqld1]
mysqld-path=/usr/local/mysql/libexec/mysqld
socket=/tmp/mysql.sock
port=3307
server_id=1
skip-stack-trace
core-file
log-bin
log-error
log=mylog
log-slow-queries

[mysqld2]
nonguarded
port=3308
server_id=2
mysqld-path= /home/cps/mysql/trees/mysql-5.1/sql/mysqld
socket      = /tmp/mysql.sock5
pid-file    = /tmp/hostname.pid5
datadir=    /home/cps/mysql_data/data_dir1
language=   /home/cps/mysql/trees/mysql-5.1/sql/share/english
log-bin
log=/tmp/fordel.log
```

### 4.6.10.3. Starting the MySQL Server with MySQL Instance Manager

#### Important

MySQL Instance Manager has been deprecated and is removed in MySQL 6.0.

This section discusses how Instance Manager starts server instances when it starts. However, before you start Instance Manager, you should set up a password file for it. Otherwise, you will not be able to connect to Instance Manager to control it after it starts. For details about creating Instance Manager accounts, see [Section 4.6.10.4, “Instance Manager User and Password Management”](#).

On Unix, the `mysqld` MySQL database server normally is started with the `mysql.server` script, which usually resides in the `/etc/init.d/` folder. That script invokes the `mysqld_safe` script by default. However, you can use Instance Manager instead if you modify the `/etc/my.cnf` configuration file by adding `use-manager` to the `[mysql.server]` section:

```
[mysql.server]
use-manager
```

Before MySQL 5.1.12, Instance Manager always tries to start at least one server instance: When it starts, it reads its configuration file if it exists to find server instance sections and prepare a list of instances. Instance sections have names of the form `[mysqld]` or `[mysqldN]`, where `N` is an unsigned integer (for example, `[mysqld1]`, `[mysqld2]`, and so forth).

After preparing the list of instances, Instance Manager starts the guarded instances in the list. If there are no instances, Instance

Manager creates an instance named `mysqld` and attempts to start it with default (compiled-in) configuration values. This means that the Instance Manager cannot find the `mysqld` program if it is not installed in the default location. (Section 2.1.5, “Installation Layouts”, describes default locations for components of MySQL distributions.) If you have installed the MySQL server in a non-standard location, you should create the Instance Manager configuration file.

The startup behavior just described is similar to that of `mysqld_safe`, which always attempts to start a server. However, it lacks the flexibility required for some operations because it is not possible to run Instance Manager in such a way that it refrains from starting any server instances. For example, you cannot invoke Instance Manager for the purpose of configuring an instance without also starting it (a task that a MySQL installer application might want to perform). Consequently, MySQL 5.1.12 introduces the following changes:

- A new option, `--mysqld-safe-compatible`, may be used to cause Instance Manager to run with startup behavior similar to that used before MySQL 5.1.12: If Instance Manager finds a `[mysqld]` instance section in the configuration file, it will start it. If Instance Manager finds no `[mysqld]` section, it creates one using default configuration values, writes a `[mysqld]` section to the configuration file if it is accessible, and starts the `mysqld` instance. Instance Manager also starts any other guarded instances listed in the configuration file.
- Without `--mysqld-safe-compatible`, Instance Manager reads its configuration file if it exists and starts instances for any guarded instance sections that it finds. If there are none, it starts no instances.

Instance Manager also stops all guarded server instances when it shuts down.

The allowable options for `[mysqldN]` server instance sections are described in Section 4.6.10.2, “MySQL Instance Manager Configuration Files”. In these sections, you can use a special `mysqld-path=path-to-mysqld-binary` option that is recognized only by Instance Manager. Use this option to let Instance Manager know where the `mysqld` binary resides. If there are multiple instances, it may also be necessary to set other options such as `datadir` and `port`, to ensure that each instance has a different data directory and TCP/IP port number. Section 5.6, “Running Multiple MySQL Servers on the Same Machine”, discusses the configuration values that must differ for each instance when you run multiple instance on the same machine.

### Warning

The `[mysqld]` instance section, if it exists, must not contain any Instance Manager-specific options.

The typical Unix startup/shutdown cycle for a MySQL server with the MySQL Instance Manager enabled is as follows:

1. The `/etc/init.d/mysql` script starts MySQL Instance Manager.
2. Instance Manager starts the guarded server instances and monitors them.
3. If a server instance fails, Instance Manager restarts it.
4. If Instance Manager is shut down (for example, with the `/etc/init.d/mysql stop` command), it shuts down all server instances.

## 4.6.10.4. Instance Manager User and Password Management

### Important

MySQL Instance Manager has been deprecated and is removed in MySQL 6.0.

The Instance Manager stores its user information in a password file. On Windows, the default is `mysqlmanager.password` in the directory where Instance Manager is installed. On Unix, the default file is `/etc/mysqlmanager.password`. To specify a different location for the password file, use the `--password-file` option.

If the password file does not exist or contains no password entries, you cannot connect to the Instance Manager.

### Note

Any Instance Manager process that is running to monitor server instances does not notice changes to the password file. You must stop it and restart it after making password entry changes.

Entries in the password file have the following format, where the two fields are the account user name and encrypted password, separated by a colon:

```
petr:*35110DC9B4D8140F5DE667E28C72DD2597B5C848
```

Instance Manager password encryption is the same as that used by MySQL Server. It is a one-way operation; no means are provided for decrypting encrypted passwords.

Instance Manager accounts differ somewhat from MySQL Server accounts:

- MySQL Server accounts are associated with a host name, user name, and password (see [Section 5.5.1, “User Names and Passwords”](#)).
- Instance Manager accounts are associated with a user name and password only.

This means that a client can connect to Instance Manager with a given user name from any host. To limit connections so that clients can connect only from the local host, start Instance Manager with the `--bind-address=127.0.0.1` option so that it listens only to the local network interface. Remote clients will not be able to connect. Local clients can connect like this:

```
shell> mysql -h 127.0.0.1 -P 2273
```

Before MySQL 5.1.12, the only option for creating password file entries is `--passwd`, which causes Instance Manager to prompt for user name and password values and display the resulting entry. You can save the output in the `/etc/mysqlmanager.passwd` password file to store it. Here is an example:

```
shell> mysqlmanager --passwd >> /etc/mysqlmanager.passwd
Creating record for new user.
Enter user name: mike
Enter password: mikepass
Re-type password: mikepass
```

At the prompts, enter the user name and password for the new Instance Manager user. You must enter the password twice. It does not echo to the screen, so double entry guards against entering a different password than you intend (if the two passwords do not match, no entry is generated).

The preceding command causes the following line to be added to `/etc/mysqlmanager.passwd`:

```
mike:*BBF1F551DD9DD96A01E66EC7DDC073911BAD17BA
```

Use of the `--password` option fails if `mysqlmanager` is invoked directly from an IBM 5250 terminal. To work around this, use a command like the following from the command line to generate the password entry:

```
shell> mysql -B --skip-column-name \
-e 'SELECT CONCAT("user_name",":",PASSWORD("pass_val"));'
```

The output from the command can be used as an entry in the `/etc/mysqlmanager.passwd` file.

Beginning with MySQL 5.1.12, the `--passwd` option is renamed to `--print-password-line` and there are several other options for managing user accounts from the command line. For example, the `--username` and `--password` options are available on the command line for specifying the user name and password for an account entry. You can use them to generate an entry with no prompting like this (type the command on a single line):

```
shell> mysqlmanager --print-password-line
--username=mike --password=mikepass >> /etc/mysqlmanager.passwd
```

If you omit the `--username` or `--password` option, Instance Manager prompts for the required value.

`--print-password-line` causes Instance Manager to send the resulting account entry to its output, which you can append to the password file. The following list describes other account-management options that cause Instance Manager to operate directly on the password file. (These options make Instance Manager scriptable for account-management purposes.) For operations on the password file to succeed, the file must exist and it must be accessible by Instance Manager. (The exception is `-clean-password-file`, which creates the file if it does not exist. Alternatively, if there is no password file, manually create it as an empty file and ensure that its ownership and access modes allow it to be read and written by Instance Manager.) The default password file is used unless you specify a `--password-file` option.

To ensure consistent treatment of the password file, it should be owned by the system account that you use for running Instance Manager to manage server instances, and you should invoke it from that account when you use it to manage accounts in the password file.

- Create a new user:

```
mysqlmanager --add-user --username=user_name [--password=password]
```

This command adds a new entry with the given user name and password to the password file. The `--username` (or `-u`) option is required. `mysqlmanager` prompts for the password if it is not given on the command line with the `--password` (or `-p`) option. The command fails if the user already exists.

- Drop an existing user:

```
mysqlmanager --drop-user --username=user_name
```

This command removes the entry with the given user name from the password file. The user name is required. The command fails if the user does not exist.

- Change the password for an existing user:

```
mysqlmanager --edit-user --username=user_name [--password=password]
```

This command changes the given user's password in the password file. The user name is required. `mysqlmanager` prompts for the password if it is not given on the command line. The command fails if the user does not exist.

- List existing users:

```
mysqlmanager --list-users
```

This command lists the user names of the accounts in the password file.

- Check the password file:

```
mysqlmanager --check-password-file
```

This command performs a consistency and validity check of the password file. The command fails if there is something wrong with the file.

- Empty the password file:

```
mysqlmanager --clean-password-file
```

This command empties the password file, which has the effect of dropping all users listed in it. The option creates the password file if it does not exist, so it can be used to initialize a new password file to be used for other account-management operations. Take care not to use this option to reinitialize a file containing accounts that you do not want to drop.

#### 4.6.10.5. MySQL Server Instance Status Monitoring

##### Important

MySQL Instance Manager has been deprecated and is removed in MySQL 6.0.

To monitor the status of each guarded server instance, the MySQL Instance Manager attempts to connect to the instance at regular intervals using the `MySQL_Instance_Manager@localhost` user account with a password of `check_connection`.

You are *not* required to create this account for MySQL Server; in fact, it is expected that it will not exist. Instance Manager can tell that a server is operational if the server accepts the connection attempt but refuses access for the account by returning a login error. However, these failed connection attempts are logged by the server to its general query log (see [Section 5.2.3, “The General Query Log”](#)).

Instance Manager also attempts a connection to nonguarded server instances when you use the `SHOW INSTANCES` or `SHOW INSTANCE STATUS` command. This is the only status monitoring done for nonguarded instances.

Instance Manager knows if a server instance fails at startup because it receives a status from the attempt. For an instance that starts but later crashes, Instance Manager receives a signal because it is the parent process of the instance.

Beginning with MySQL 5.1.12, Instance Manager tracks instance states so that it can determine which commands are allowed for each instance. For example, commands that modify an instance's configuration are allowed only while the instance is offline.

Each instance is in one of the states described in the following table. Guarded instances can be in any of the states. Nonguarded instances can only be offline or online. Instance state information is displayed in the `status` column of the `SHOW INSTANCES` and `SHOW INSTANCE STATUS` commands.

State	Meaning
-------	---------



<code>offline</code>	The instance has not been started and is not running.
<code>starting</code>	The instance is starting (initializing). Nonguarded instances cannot be in this state. A nonguarded instance goes directly from offline to online.
<code>stopping</code>	The instance is stopping. Nonguarded instances cannot be in this state. A nonguarded instance goes directly from online to offline, or stays offline if startup fails.
<code>online</code>	The instance has started and is running.
<code>failed</code>	The instance was online but it crashed and is being restarted by Instance Manager, or else the instance failed to start at all and Instance Manager is again attempting to start it. Nonguarded instances cannot be in this state.
<code>crashed</code>	Instance Manager failed to start the instance after several attempts. (Instance Manager will try again later.) Nonguarded instances cannot be in this state.
<code>abandoned</code>	Instance Manager was not able to start the instance, has given up, and will make no further attempts until instructed otherwise. To tell Instance Manager to try again, you must first use <code>STOP INSTANCE</code> to put the instance in offline state, and then use <code>START INSTANCE</code> to start the instance. If it is necessary to make configuration changes for the instance, you must do so after putting the instance offline and before starting it. (Instance Manager accepts configuration-changing commands only for offline instances.) Nonguarded instances cannot be in this state.

#### 4.6.10.6. Connecting to MySQL Instance Manager

##### Important

MySQL Instance Manager has been deprecated and is removed in MySQL 6.0.

After you set up a password file for the MySQL Instance Manager and Instance Manager is running, you can connect to it. The MySQL client-server protocol is used to communicate with the Instance Manager. For example, you can connect to it using the standard `mysql` client program:

```
shell> mysql --port=2273 --host=im.example.org --user=mysql --password
```

Instance Manager supports the version of the MySQL client-server protocol used by the client tools and libraries distributed with MySQL 4.1 or later, so other programs that use the MySQL C API also can connect to it.

#### 4.6.10.7. MySQL Instance Manager Commands

##### Important

MySQL Instance Manager has been deprecated and is removed in MySQL 6.0.

After you connect to MySQL Instance Manager, you can issue commands. The following general principles apply to Instance Manager command execution:

- Commands that take an instance name fail if the name is not a valid instance name.
- Commands that take an instance name (other than `CREATE INSTANCE`) fail if the instance does not exist.
- As of MySQL 5.1.12, commands for an instance require that the instance be in an appropriate state. You cannot configure or start an instance that is not offline. You cannot start an instance that is online.
- Instance Manager maintains information about instance configuration in an internal (in-memory) cache. Initially, this information comes from the configuration file if it exists, but some commands change the configuration of an instance. Commands that modify the configuration file fail if the file does not exist or is not accessible to Instance Manager.

As of MySQL 5.1.12, configuration-changing commands modify both the in-memory cache and the server instance section recorded in the configuration file to maintain consistency between them. For this to occur, the instance must be offline and the configuration file must be accessible and not malformed. If the configuration file cannot be updated, the command fails and the cache remains unchanged.

- On Windows, the standard file is `my.ini` in the directory where Instance Manager is installed. On Unix, the standard configuration file is `/etc/my.cnf`. To specify a different configuration file, start Instance Manager with the `--defaults-file` option.
- If a `[mysqld]` instance section exists in the configuration file, it must not contain any Instance Manager-specific options (see [Section 4.6.10.2, “MySQL Instance Manager Configuration Files”](#)). Therefore, you must not add any of these options if you change the configuration for an instance named `mysqld`.



The following list describes the commands that Instance Manager accepts, with examples.

- `CREATE INSTANCE instance_name [option_name[=option_value], ...]`

This command configures a new instance by creating an [*instance\_name*] section in the configuration file. The command fails if *instance\_name* is not a valid instance name or the instance already exists.

The created section instance is empty if no options are given. Otherwise, the options are added to the section. Options should be given in the same format used when you write options in option files. (See [Section 4.2.3.2, “Using Option Files”](#) for a description of the allowable syntax.) If you specify multiple options, separate them by commas.

For example, to create an instance section named [`mysqld98`], you might write something like this were you to modify the configuration file directly:

```
[mysqld98]
basedir=/var/mysql98
```

To achieve the same effect via `CREATE INSTANCE`, issue this command to Instance Manager:

```
mysql> CREATE INSTANCE mysqld98 basedir="/var/mysql98";
Query OK, 0 rows affected (0,00 sec)
```

`CREATE INSTANCE` creates the instance but does not start it.

If the instance name is the (deprecated) name `mysqld`, the option list cannot include any options that are specific to Instance Manager, such as `nonguarded` (see [Section 4.6.10.2, “MySQL Instance Manager Configuration Files”](#)).

This command was added in MySQL 5.1.12.

- `DROP INSTANCE instance_name`

This command removes the configuration for *instance\_name* from the configuration file.

```
mysql> DROP INSTANCE mysqld98;
Query OK, 0 rows affected (0,00 sec)
```

The command fails if *instance\_name* is not a valid instance name, the instance does not exist, or is not offline.

This command was added in MySQL 5.1.12.

- `START INSTANCE instance_name`

This command attempts to start an offline instance. The command is asynchronous; it does not wait for the instance to start.

```
mysql> START INSTANCE mysqld4;
Query OK, 0 rows affected (0,00 sec)
```

- `STOP INSTANCE instance_name`

This command attempts to stop an instance. The command is synchronous; it waits for the instance to stop.

```
mysql> STOP INSTANCE mysqld4;
Query OK, 0 rows affected (0,00 sec)
```

- `SHOW INSTANCES`

Shows the names and status of all loaded instances.

```
mysql> SHOW INSTANCES;
+-----+-----+
| instance_name | status |
+-----+-----+
| mysqld3       | offline |
| mysqld4       | online  |
| mysqld2       | offline |
+-----+-----+
```

- `SHOW INSTANCE STATUS instance_name`

Shows status and version information for an instance.

```
mysql> SHOW INSTANCE STATUS mysqld3;
```

instance_name	status	version
mysqld3	online	unknown

- `SHOW INSTANCE OPTIONS instance_name`

Shows the options used by an instance.

```
mysql> SHOW INSTANCE OPTIONS mysqld3;
```

option_name	value
instance_name	mysqld3
mysqld-path	/home/cps/mysql/trees/mysql-4.1/sql/mysqld
port	3309
socket	/tmp/mysql.sock3
pid-file	hostname.pid3
datadir	/home/cps/mysql_data/data_dir1/
language	/home/cps/mysql/trees/mysql-4.1/sql/share/english

- `SHOW instance_name LOG FILES`

The command lists all log files used by the instance. The result set contains the path to the log file and the log file size. If no log file path is specified in the instance section of the configuration file (for example, `log=/var/mysql.log`), the Instance Manager tries to guess its placement. If Instance Manager is unable to guess the log file placement you should specify the log file location explicitly by using a log option in the appropriate instance section of the configuration file.

```
mysql> SHOW mysqld LOG FILES;
```

Logfile	Path	Filesize
ERROR LOG	/home/cps/var/mysql/owlet.err	9186
GENERAL LOG	/home/cps/var/mysql/owlet.log	471503
SLOW LOG	/home/cps/var/mysql/owlet-slow.log	4463

`SHOW ... LOG FILES` displays information only about log files. If a server instance uses log tables (see [Section 5.2.1, “Selecting General Query and Slow Query Log Output Destinations”](#)), no information about those tables is shown.

Log options are described in [Section 5.1.2, “Server Command Options”](#).

- `SHOW instance_name LOG {ERROR | SLOW | GENERAL} size[,offset_from_end]`

This command retrieves a portion of the specified log file. Because most users are interested in the latest log messages, the `size` parameter defines the number of bytes to retrieve from the end of the log. To retrieve data from the middle of the log file, specify the optional `offset_from_end` parameter. The following example retrieves 21 bytes of data, starting 23 bytes before the end of the log file and ending 2 bytes before the end:

```
mysql> SHOW mysqld LOG GENERAL 21, 2;
```

Log
using password: YES

- `SET instance_name.option_name[=option_value]`

This command edits the specified instance's configuration section to change or add instance options. The option is added to the section if it is not already present. Otherwise, the new setting replaces the existing one.

```
mysql> SET mysqld2.port=3322;
Query OK, 0 rows affected (0.00 sec)
```

As of MySQL 5.1.12, you can specify multiple options (separated by commas), and `SET` can be used only for offline instances. Each option must indicate the instance name:

```
mysql> SET mysqld2.port=3322, mysqld3.nonguarded;
Query OK, 0 rows affected (0.00 sec)
```

Before MySQL 5.1.12, only a single option can be specified. Also, changes made to the configuration file do not take effect until the MySQL server is restarted. In addition, these changes are not stored in the instance manager's local cache of instance settings until a `FLUSH INSTANCES` command is executed.

- `UNSET instance_name.option_name`

This command removes an option from an instance's configuration section.

```
mysql> UNSET mysqld2.port;
Query OK, 0 rows affected (0.00 sec)
```

As of MySQL 5.1.12, you can specify multiple options (separated by commas), and `UNSET` can be used only for offline instances. Each option must indicate the instance name:

```
mysql> UNSET mysqld2.port, mysqld4.nonguarded;
Query OK, 0 rows affected (0.00 sec)
```

Before MySQL 5.1.12, only a single option can be specified. Also, changes made to the configuration file do not take effect until the MySQL server is restarted. In addition, these changes are not stored in the instance manager's local cache of instance settings until a `FLUSH INSTANCES` command is executed.

- `FLUSH INSTANCES`

As of MySQL 5.1.12, `FLUSH INSTANCES` cannot be used unless all instances are offline. The command causes Instance Manager to reread the configuration file, update its in-memory configuration cache, and start any guarded instances.

Before MySQL 5.1.12, this command forces Instance Manager reread the configuration file and to refresh internal structures. This command should be performed after editing the configuration file. The command does not restart instances.

```
mysql> FLUSH INSTANCES;
Query OK, 0 rows affected (0.04 sec)
```

## 4.6.11. `mysql_convert_table_format` — Convert Tables to Use a Given Storage Engine

`mysql_convert_table_format` converts the tables in a database to use a particular storage engine (`MyISAM` by default). `mysql_convert_table_format` is written in Perl and requires that the `DBI` and `DBD: :mysql` Perl modules be installed (see [Section 2.15, “Perl Installation Notes”](#)).

Invoke `mysql_convert_table_format` like this:

```
shell> mysql_convert_table_format [options]db_name
```

The `db_name` argument indicates the database containing the tables to be converted.

`mysql_convert_table_format` supports the options described in the following list.

- `--help`

Display a help message and exit.

- `--force`

Continue even if errors occur.

- `--host=host_name`

Connect to the MySQL server on the given host.

- `--password=password`

The password to use when connecting to the server. Note that the password value is not optional for this option, unlike for other MySQL programs. You can use an option file to avoid giving the password on the command line.

Specifying a password on the command line should be considered insecure. See [Section 5.5.6.2, “End-User Guidelines for Password Security”](#).

- `--port=port_num`

The TCP/IP port number to use for the connection.

- `--socket=path`

For connections to `localhost`, the Unix socket file to use.

- `--type=engine_name`

Specify the storage engine that the tables should be converted to use. The default is `MyISAM` if this option is not given.

#### MySQL Enterprise

For expert advice on choosing the optimum storage engine, subscribe to the MySQL Enterprise Monitor. For more information, see <http://www.mysql.com/products/enterprise/advisors.html>.

- `--user=user_name`

The MySQL user name to use when connecting to the server.

- `--verbose`

Verbose mode. Print more information about what the program does.

- `--version`

Display version information and exit.

## 4.6.12. `mysql_find_rows` — Extract SQL Statements from Files

`mysql_find_rows` reads files containing SQL statements and extracts statements that match a given regular expression or that contain `USE db_name` or `SET` statements. The utility was written for use with update log files (as used prior to MySQL 5.0) and as such expects statements to be terminated with semicolon (;) characters. It may be useful with other files that contain SQL statements as long as statements are terminated with semicolons.

Invoke `mysql_find_rows` like this:

```
shell> mysql_find_rows [options] [file_name ...]
```

Each `file_name` argument should be the name of file containing SQL statements. If no file names are given, `mysql_find_rows` reads the standard input.

Examples:

```
mysql_find_rows --regexp=problem_table --rows=20 < update.log
mysql_find_rows --regexp=problem_table update-log.1 update-log.2
```

`mysql_find_rows` supports the following options:

- `--help, --Information`

Display a help message and exit.

- `--regexp=pattern`

Display queries that match the pattern.

- `--rows=N`

Quit after displaying `N` queries.

- `--skip-use-db`

Do not include `USE db_name` statements in the output.

- `--start_row=N`

Start output from this row.

## 4.6.13. `mysql_fix_extensions` — Normalize Table File Name Extensions

`mysql_fix_extensions` converts the extensions for `MyISAM` (or `ISAM`) table files to their canonical forms. It looks for files with extensions matching any lettercase variant of `.frm`, `.myd`, `.myi`, `.isd`, and `.ism` and renames them to have extensions of `.frm`, `.MYD`, `.MYI`, `.ISD`, and `.ISM`, respectively. This can be useful after transferring the files from a system with case-insensitive file names (such as Windows) to a system with case-sensitive file names.

Invoke `mysql_fix_extensions` like this, where `data_dir` is the path name to the MySQL data directory.

```
shell> mysql_fix_extensions data_dir
```

## 4.6.14. `mysql_setpermission` — Interactively Set Permissions in Grant Tables

`mysql_setpermission` is a Perl script that was originally written and contributed by Luuk de Boer. It interactively sets permissions in the MySQL grant tables. `mysql_setpermission` is written in Perl and requires that the `DBI` and `DBD::mysql` Perl modules be installed (see [Section 2.15, “Perl Installation Notes”](#)).

Invoke `mysql_setpermission` like this:

```
shell> mysql_setpermission [options]
```

`options` should be either `--help` to display the help message, or options that indicate how to connect to the MySQL server. The account used when you connect determines which permissions you have when attempting to modify existing permissions in the grant tables.

`mysql_setpermissions` also reads options from the `[client]` and `[perl]` groups in the `.my.cnf` file in your home directory, if the file exists.

`mysql_setpermission` supports the following options:

- `--help`  
Display a help message and exit.
- `--host=host_name`  
Connect to the MySQL server on the given host.
- `--password=password`  
The password to use when connecting to the server. Note that the password value is not optional for this option, unlike for other MySQL programs. You can use an option file to avoid giving the password on the command line.  
Specifying a password on the command line should be considered insecure. See [Section 5.5.6.2, “End-User Guidelines for Password Security”](#).
- `--port=port_num`  
The TCP/IP port number to use for the connection.
- `--socket=path`  
For connections to `localhost`, the Unix socket file to use.
- `--user=user_name`  
The MySQL user name to use when connecting to the server.

## 4.6.15. `mysql_waitpid` — Kill Process and Wait for Its Termination

`mysql_waitpid` signals a process to terminate and waits for the process to exit. It uses the `kill()` system call and Unix signals, so it runs on Unix and Unix-like systems.

Invoke `mysql_waitpid` like this:

```
shell> mysql_waitpid [options] pid wait_time
```

`mysql_waitpid` sends signal 0 to the process identified by `pid` and waits up to `wait_time` seconds for the process to terminate. `pid` and `wait_time` must be positive integers.

If process termination occurs within the wait time or the process does not exist, `mysql_waitpid` returns 0. Otherwise, it returns 1.

If the `kill()` system call cannot handle signal 0, `mysql_waitpid()` uses signal 1 instead.

`mysql_waitpid` supports the following options:

- `--help, -?, -I`  
Display a help message and exit.
- `--verbose, -v`  
Verbose mode. Display a warning if signal 0 could not be used and signal 1 is used instead.
- `--version, -V`  
Display version information and exit.

## 4.6.16. `mysql_zap` — Kill Processes That Match a Pattern

`mysql_zap` kills processes that match a pattern. It uses the `ps` command and Unix signals, so it runs on Unix and Unix-like systems.

Invoke `mysql_zap` like this:

```
shell> mysql_zap [-signal] [-?Ift] pattern
```

A process matches if its output line from the `ps` command contains the pattern. By default, `mysql_zap` asks for confirmation for each process. Respond `y` to kill the process, or `q` to exit `mysql_zap`. For any other response, `mysql_zap` does not attempt to kill the process.

If the `-signal` option is given, it specifies the name or number of the signal to send to each process. Otherwise, `mysql_zap` tries first with `TERM` (signal 15) and then with `KILL` (signal 9).

`mysql_zap` supports the following additional options:

- `--help, -?, -I`  
Display a help message and exit.
- `-f`  
Force mode. `mysql_zap` attempts to kill each process without confirmation.
- `-t`  
Test mode. Display information about each process but do not kill it.

## 4.7. MySQL Program Development Utilities

This section describes some utilities that you may find useful when developing MySQL programs.

In shell scripts, you can use the `my_print_defaults` program to parse option files and see what options would be used by a given program. The following example shows the output that `my_print_defaults` might produce when asked to show the options found in the `[client]` and `[mysql]` groups:

```
shell> my_print_defaults client mysql
--port=3306
--socket=/tmp/mysql.sock
--no-auto-rehash
```

**Note for developers:** Option file handling is implemented in the C client library simply by processing all options in the appropriate

group or groups before any command-line arguments. This works well for programs that use the last instance of an option that is specified multiple times. If you have a C or C++ program that handles multiply specified options this way but that doesn't read option files, you need add only two lines to give it that capability. Check the source code of any of the standard MySQL clients to see how to do this.

Several other language interfaces to MySQL are based on the C client library, and some of them provide a way to access option file contents. These include Perl and Python. For details, see the documentation for your preferred interface.

### 4.7.1. `mysql2mysql` — Convert mSQL Programs for Use with MySQL

Initially, the MySQL C API was developed to be very similar to that for the mSQL database system. Because of this, mSQL programs often can be converted relatively easily for use with MySQL by changing the names of the C API functions.

The `mysql2mysql` utility performs the conversion of mSQL C API function calls to their MySQL equivalents. `mysql2mysql` converts the input file in place, so make a copy of the original before converting it. For example, use `mysql2mysql` like this:

```
shell> cp client-prog.c client-prog.c.orig
shell> mysql2mysql client-prog.c
client-prog.c converted
```

Then examine `client-prog.c` and make any post-conversion revisions that may be necessary.

`mysql2mysql` uses the `replace` utility to make the function name substitutions. See [Section 4.8.2, “replace — A String-Replacement Utility”](#).

### 4.7.2. `mysql_config` — Get Compile Options for Compiling Clients

`mysql_config` provides you with useful information for compiling your MySQL client and connecting it to MySQL.

`mysql_config` supports the following options:

- `--cflags`  
Compiler flags to find include files and critical compiler flags and defines used when compiling the `libmysqlclient` library. The options returned are tied to the specific compiler that was used when the library was created and might clash with the settings for your own compiler. Use `--include` for more portable options that contain only include paths.
- `--include`  
Compiler options to find MySQL include files.
- `--libmysqld-libs, --embedded`  
Libraries and options required to link with the MySQL embedded server.
- `--libs`  
Libraries and options required to link with the MySQL client library.
- `--libs_r`  
Libraries and options required to link with the thread-safe MySQL client library.
- `--plugindir`  
The default plugin directory path name, defined when configuring MySQL. This option was added in MySQL 5.1.24.
- `--port`  
The default TCP/IP port number, defined when configuring MySQL.
- `--socket`  
The default Unix socket file, defined when configuring MySQL.
- `--version`  
Version number for the MySQL distribution.

If you invoke `mysql_config` with no options, it displays a list of all options that it supports, and their values:

```

shell> mysql_config
Usage: /usr/local/mysql/bin/mysql_config [options]
Options:
--cflags          [-I/usr/local/mysql/include/mysql -mcpu=pentiumpro]
--include         [-I/usr/local/mysql/include/mysql]
--libs           [-L/usr/local/mysql/lib/mysql -lmysqlclient -lz
                 -lcrypt -lnsl -lm -L/usr/lib -lssl -lcrypto]
--libs_r         [-L/usr/local/mysql/lib/mysql -lmysqlclient_r
                 -lpthread -lz -lcrypt -lnsl -lm -lpthread]
--socket         [/tmp/mysql.sock]
--port           [3306]
--version        [4.0.16]
--libmysqld-libs [-L/usr/local/mysql/lib/mysql -lmysqld -lpthread -lz
                 -lcrypt -lnsl -lm -lpthread -lrt]

```

You can use `mysql_config` within a command line to include the value that it displays for a particular option. For example, to compile a MySQL client program, use `mysql_config` as follows:

```

shell> CFG=/usr/local/mysql/bin/mysql_config
shell> sh -c "gcc -o progname ` $CFG --include ` progname.c ` $CFG --libs `"

```

When you use `mysql_config` this way, be sure to invoke it within backtick (“`) characters. That tells the shell to execute it and substitute its output into the surrounding command.

### 4.7.3. `my_print_defaults` — Display Options from Option Files

`my_print_defaults` displays the options that are present in option groups of option files. The output indicates what options will be used by programs that read the specified option groups. For example, the `mysqlcheck` program reads the `[mysqlcheck]` and `[client]` option groups. To see what options are present in those groups in the standard option files, invoke `my_print_defaults` like this:

```

shell> my_print_defaults mysqlcheck client
--user=myusername
--password=secret
--host=localhost

```

The output consists of options, one per line, in the form that they would be specified on the command line.

`my_print_defaults` supports the following options:

- `--help, -?`  
Display a help message and exit.
- `--config-file=file_name, --defaults-file=file_name, -c file_name`  
Read only the given option file.
- `--debug=debug_options, -# debug_options`  
Write a debugging log. A typical `debug_options` string is `'d:t:o,file_name'`. The default is `'d:t:o,/tmp/my_print_defaults.trace'`.
- `--defaults-extra-file=file_name, --extra-file=file_name, -e file_name`  
Read this option file after the global option file but (on Unix) before the user option file.
- `--defaults-group-suffix=suffix, -g suffix`  
In addition to the groups named on the command line, read groups that have the given suffix.
- `--no-defaults, -n`  
Return an empty string.
- `--verbose, -v`  
Verbose mode. Print more information about what the program does.
- `--version, -V`  
Display version information and exit.



## 4.7.4. `resolve_stack_dump` — Resolve Numeric Stack Trace Dump to Symbols

`resolve_stack_dump` resolves a numeric stack dump to symbols.

Invoke `resolve_stack_dump` like this:

```
shell> resolve_stack_dump [options] symbols_file [numeric_dump_file]
```

The symbols file should include the output from the `nm --numeric-sort mysqld` command. The numeric dump file should contain a numeric stack track from `mysqld`. If no numeric dump file is named on the command line, the stack trace is read from the standard input.

`resolve_stack_dump` supports the options described in the following list.

- `--help, -h`  
Display a help message and exit.
- `--numeric-dump-file=file_name, -n file_name`  
Read the stack trace from the given file.
- `--symbols-file=file_name, -s file_name`  
Use the given symbols file.
- `--version, -V`  
Display version information and exit.

## 4.8. Miscellaneous Programs

### 4.8.1. `perror` — Explain Error Codes

For most system errors, MySQL displays, in addition to an internal text message, the system error code in one of the following styles:

```
message ... (errno: #)
message ... (Errcode: #)
```

You can find out what the error code means by examining the documentation for your system or by using the `perror` utility.

`perror` prints a description for a system error code or for a storage engine (table handler) error code.

Invoke `perror` like this:

```
shell> perror [options] errorcode ...
```

Example:

```
shell> perror 13 64
OS error code 13: Permission denied
OS error code 64: Machine is not on the network
```

To obtain the error message for a MySQL Cluster error code, invoke `perror` with the `--ndb` option:

```
shell> perror --ndb errorcode
```

Note that the meaning of system error messages may be dependent on your operating system. A given error code may mean different things on different operating systems.

`perror` supports the following options:

- `--help, --info, -I, -?`

Display a help message and exit.

- `--ndb`

Print the error message for a MySQL Cluster error code.

- `--silent, -s`

Silent mode. Print only the error message.

- `--verbose, -v`

Verbose mode. Print error code and message. This is the default behavior.

- `--version, -V`

Display version information and exit.

## 4.8.2. `replace` — A String-Replacement Utility

The `replace` utility program changes strings in place in files or on the standard input.

Invoke `replace` in one of the following ways:

```
shell> replace from to [from to] ... -- file_name [file_name] ...
shell> replace from to [from to] ... < file_name
```

`from` represents a string to look for and `to` represents its replacement. There can be one or more pairs of strings.

Use the `--` option to indicate where the string-replacement list ends and the file names begin. In this case, any file named on the command line is modified in place, so you may want to make a copy of the original before converting it. `replace` prints a message indicating which of the input files it actually modifies.

If the `--` option is not given, `replace` reads the standard input and writes to the standard output.

`replace` uses a finite state machine to match longer strings first. It can be used to swap strings. For example, the following command swaps `a` and `b` in the given files, `file1` and `file2`:

```
shell> replace a b b a -- file1 file2 ...
```

The `replace` program is used by `mysql2mysql`. See Section 4.7.1, “`mysql2mysql` — Convert mSQL Programs for Use with MySQL”.

`replace` supports the following options:

- `-?, -I`

Display a help message and exit.

- `##debug_options`

Enable debugging.

- `-s`

Silent mode. Print less information what the program does.

- `-v`

Verbose mode. Print more information about what the program does.

- `-V`

Display version information and exit.

## 4.8.3. `resolveip` — Resolve Host name to IP Address or Vice Versa

The `resolveip` utility resolves host names to IP addresses and vice versa.

Invoke `resolveip` like this:

```
shell> resolveip [options] {host_name|ip-addr} ...
```

`resolveip` supports the options described in the following list.

- `--help, --info, -?, -I`  
Display a help message and exit.
- `--silent, -s`  
Silent mode. Produce less output.
- `--version, -V`  
Display version information and exit.

---

# Chapter 5. MySQL Server Administration

MySQL Server (`mysqld`) is the main program that does most of the work in a MySQL installation. This section provides an overview of MySQL Server and covers topics that deal with administering a MySQL installation:

- Server configuration
- The server log files
- Security issues and user-account management
- Management of multiple servers on a single machine

## 5.1. The MySQL Server

`mysqld` is the MySQL server. The following discussion covers these MySQL server configuration topics:

- Startup options that the server supports
- Server system variables
- Server status variables
- How to set the server SQL mode
- The server shutdown process

### Note

Not all storage engines are supported by all MySQL server binaries and configurations. To find out how to determine which storage engines are supported by your MySQL server installation, see [Section 12.5.5.17, “SHOW ENGINES Syntax”](#).

### 5.1.1. Server Option and Variable Reference

The following table provides a list of all the command line options, server and status variables applicable within `mysqld`.

The table lists command-line options (Cmd-line), options valid in configuration files (Option file), server system variables (System Var), and status variables (Status var) in one unified list, with notification of where each option/variable is valid. If a server option set on the command line or in an option file differs from the name of the corresponding server system or status variable, the variable name is noted immediately below the corresponding option. For status variables, the scope of the variable is shown (Scope) as either global, session, or both. Please see the corresponding sections for details on setting and using the options and variables. Where appropriate, a direct link to further information on the item as available.

**Table 5.1. `mysqld` Option/Variable Summary**

Name	Cmd-Line	Option file	System Var	Status Var	Var Scope	Dynamic
<a href="#">abort-slave-event-count</a>	Yes	Yes				
<a href="#">Aborted_clients</a>				Yes	Global	No
<a href="#">Aborted_connects</a>				Yes	Global	No
<a href="#">allow-suspicious-udfs</a>	Yes	Yes				
<a href="#">ansi</a>	Yes	Yes				
<a href="#">auto_increment_increment</a>	Yes	Yes	Yes		Both	Yes
<a href="#">auto_increment_offset</a>	Yes	Yes	Yes		Both	Yes
<a href="#">autocommit</a>			Yes		Session	Yes
<a href="#">automatic_sp_privileges</a>			Yes		Global	Yes
<a href="#">back_log</a>	Yes	Yes	Yes		Global	No
<a href="#">basedir</a>	Yes	Yes	Yes		Global	No

Name	Cmd-Line	Option file	System Var	Status Var	Var Scope	Dynamic
big-tables	Yes	Yes			Session	Yes
- Variable: big_tables			Yes		Session	Yes
bind-address	Yes	Yes				
Binlog_cache_disk_use				Yes	Global	No
binlog_cache_size	Yes	Yes	Yes		Global	Yes
Binlog_cache_use				Yes	Global	No
binlog-do-db	Yes	Yes				
binlog-format	Yes	Yes			Both	Yes
- Variable: binlog_format			Yes		Both	Yes
binlog-ignore-db	Yes	Yes				
binlog-row-event-max-size	Yes	Yes				
bootstrap	Yes	Yes				
bulk_insert_buffer_size	Yes	Yes	Yes		Both	Yes
Bytes_received				Yes	Both	No
Bytes_sent				Yes	Both	No
character_set_client			Yes		Both	Yes
character-set-client-handshake	Yes	Yes				
character_set_connection			Yes		Both	Yes
character_set_database <sup>a</sup>			Yes		Both	Yes
character-set-filesystem	Yes	Yes			Both	Yes
- Variable: character_set_filesystem			Yes		Both	Yes
character_set_results			Yes		Both	Yes
character-set-server	Yes	Yes			Both	Yes
- Variable: character_set_server			Yes		Both	Yes
character_set_system			Yes		Global	No
character-sets-dir	Yes	Yes			Global	No
- Variable: character_sets_dir			Yes		Global	No
chroot	Yes	Yes				
collation_connection			Yes		Both	Yes
collation_database <sup>b</sup>			Yes		Both	Yes
collation-server	Yes	Yes			Both	Yes
- Variable: collation_server			Yes		Both	Yes
Com_admin_commands				Yes	Both	No
Com_alter_db				Yes	Both	No
Com_alter_event				Yes	Both	No
Com_alter_table				Yes	Both	No
Com_analyze				Yes	Both	No
Com_backup_table				Yes	Both	No
Com_begin				Yes	Both	No
Com_call_procedure				Yes	Both	No
Com_change_db				Yes	Both	No
Com_change_master				Yes	Both	No
Com_check				Yes	Both	No
Com_checksum				Yes	Both	No
Com_commit				Yes	Both	No
Com_create_db				Yes	Both	No
Com_create_event				Yes	Both	No

Name	Cmd-Line	Option file	System Var	Status Var	Var Scope	Dynamic
Com_create_function				Yes	Both	No
Com_create_index				Yes	Both	No
Com_create_table				Yes	Both	No
Com_create_user				Yes	Both	No
Com_dealloc_sql				Yes	Both	No
Com_delete				Yes	Both	No
Com_delete_multi				Yes	Both	No
Com_do				Yes	Both	No
Com_drop_db				Yes	Both	No
Com_drop_event				Yes	Both	No
Com_drop_function				Yes	Both	No
Com_drop_index				Yes	Both	No
Com_drop_table				Yes	Both	No
Com_drop_user				Yes	Both	No
Com_execute_sql				Yes	Both	No
Com_flush				Yes	Both	No
Com_grant				Yes	Both	No
Com_ha_close				Yes	Both	No
Com_ha_open				Yes	Both	No
Com_ha_read				Yes	Both	No
Com_help				Yes	Both	No
Com_insert				Yes	Both	No
Com_insert_select				Yes	Both	No
Com_kill				Yes	Both	No
Com_load				Yes	Both	No
Com_lock_tables				Yes	Both	No
Com_optimize				Yes	Both	No
Com_preload_keys				Yes	Both	No
Com_prepare_sql				Yes	Both	No
Com_purge				Yes	Both	No
Com_purge_before_date				Yes	Both	No
Com_rename_table				Yes	Both	No
Com_repair				Yes	Both	No
Com_replace				Yes	Both	No
Com_replace_select				Yes	Both	No
Com_reset				Yes	Both	No
Com_restore_table				Yes	Both	No
Com_revoke				Yes	Both	No
Com_revoke_all				Yes	Both	No
Com_rollback				Yes	Both	No
Com_savepoint				Yes	Both	No
Com_select				Yes	Both	No
Com_set_option				Yes	Both	No
Com_show_binlog_events				Yes	Both	No
Com_show_binlogs				Yes	Both	No
Com_show_charsets				Yes	Both	No
Com_show_collations				Yes	Both	No

Name	Cmd-Line	Option file	System Var	Status Var	Var Scope	Dynamic
Com_show_column_types				Yes	Both	No
Com_show_create_db				Yes	Both	No
Com_show_create_event				Yes	Both	No
Com_show_create_table				Yes	Both	No
Com_show_databases				Yes	Both	No
Com_show_engine_logs				Yes	Both	No
Com_show_engine_mutex				Yes	Both	No
Com_show_engine_status				Yes	Both	No
Com_show_errors				Yes	Both	No
Com_show_events				Yes	Both	No
Com_show_fields				Yes	Both	No
Com_show_grants				Yes	Both	No
Com_show_innodb_status				Yes	Both	No
Com_show_keys				Yes	Both	No
Com_show_logs				Yes	Both	No
Com_show_master_status				Yes	Both	No
Com_show_ndb_status				Yes	Both	No
Com_show_new_master				Yes	Both	No
Com_show_open_tables				Yes	Both	No
Com_show_plugins				Yes	Both	No
Com_show_privileges				Yes	Both	No
Com_show_processlist				Yes	Both	No
Com_show_profile				Yes	Both	No
Com_show_profiles				Yes	Both	No
Com_show_slave_hosts				Yes	Both	No
Com_show_slave_status				Yes	Both	No
Com_show_status				Yes	Both	No
Com_show_storage_engines				Yes	Both	No
Com_show_tables				Yes	Both	No
Com_show_triggers				Yes	Both	No
Com_show_variables				Yes	Both	No
Com_show_warnings				Yes	Both	No
Com_slave_start				Yes	Both	No
Com_slave_stop				Yes	Both	No
Com_stmt_close				Yes	Both	No
Com_stmt_execute				Yes	Both	No
Com_stmt_fetch				Yes	Both	No
Com_stmt_prepare				Yes	Both	No
Com_stmt_reprepare				Yes	Both	No
Com_stmt_reset				Yes	Both	No
Com_stmt_send_long_data				Yes	Both	No
Com_truncate				Yes	Both	No
Com_unlock_tables				Yes	Both	No
Com_update				Yes	Both	No
Com_update_multi				Yes	Both	No
Com_xa_commit				Yes	Both	No
Com_xa_end				Yes	Both	No

Name	Cmd-Line	Option file	System Var	Status Var	Var Scope	Dynamic
Com_xa_prepare				Yes	Both	No
Com_xa_recover				Yes	Both	No
Com_xa_rollback				Yes	Both	No
Com_xa_start				Yes	Both	No
completion_type	Yes	Yes	Yes		Both	Yes
Compression				Yes	Session	No
concurrent_insert	Yes	Yes	Yes		Global	Yes
connect_timeout	Yes	Yes	Yes		Global	Yes
Connections				Yes	Global	No
console	Yes	Yes				
core-file	Yes	Yes				
Created_tmp_disk_tables				Yes	Both	No
Created_tmp_files				Yes	Global	No
Created_tmp_tables				Yes	Both	No
datadir	Yes	Yes	Yes		Global	No
date_format			Yes		Both	Yes
datetime_format	Yes	Yes	Yes		Both	Yes
debug	Yes	Yes	Yes		Both	Yes
default-storage-engine	Yes	Yes				
default-table-type	Yes	Yes				
default-time-zone	Yes	Yes				
default_week_format	Yes	Yes	Yes		Both	Yes
defaults-extra-file	Yes					
defaults-file	Yes					
defaults-group-suffix	Yes					
delay-key-write	Yes	Yes			Global	Yes
- Variable: delay_key_write			Yes		Global	Yes
Delayed_errors				Yes	Global	No
delayed_insert_limit	Yes	Yes	Yes		Global	Yes
Delayed_insert_threads				Yes	Global	No
delayed_insert_timeout	Yes	Yes	Yes		Global	Yes
delayed_queue_size	Yes	Yes	Yes		Global	Yes
Delayed_writes				Yes	Global	No
des-key-file	Yes	Yes				
disconnect-slave-event-count	Yes	Yes				
div_precision_increment	Yes	Yes	Yes		Both	Yes
enable-locking	Yes	Yes				
enable-named-pipe	Yes	Yes				
enable-pstack	Yes	Yes				
engine-condition-pushdown	Yes	Yes			Both	Yes
- Variable: engine_condition_pushdown			Yes		Both	Yes
error_count			Yes		Session	No
event-scheduler	Yes	Yes			Global	Yes
- Variable: event_scheduler			Yes		Global	Yes
exit-info	Yes	Yes				
expire_logs_days	Yes	Yes	Yes		Global	Yes
external-locking	Yes	Yes				



Name	Cmd-Line	Option file	System Var	Status Var	Var Scope	Dynamic
- Variable: skip_external_locking						
flush	Yes	Yes	Yes		Global	Yes
Flush_commands				Yes	Global	No
flush_time	Yes	Yes	Yes		Global	Yes
foreign_key_checks			Yes		Session	Yes
ft_boolean_syntax	Yes	Yes	Yes		Global	Yes
ft_max_word_len	Yes	Yes	Yes		Global	No
ft_min_word_len	Yes	Yes	Yes		Global	No
ft_query_expansion_limit	Yes	Yes	Yes		Global	No
ft_stopword_file	Yes	Yes	Yes		Global	No
gdb	Yes	Yes				
general-log	Yes	Yes			Global	Yes
- Variable: general_log			Yes		Global	Yes
general_log_file	Yes	Yes	Yes		Global	Yes
group_concat_max_len	Yes	Yes	Yes		Both	Yes
Handler_commit				Yes	Both	No
Handler_delete				Yes	Both	No
Handler_discover				Yes	Both	No
Handler_prepare				Yes	Both	No
Handler_read_first				Yes	Both	No
Handler_read_key				Yes	Both	No
Handler_read_next				Yes	Both	No
Handler_read_prev				Yes	Both	No
Handler_read_rnd				Yes	Both	No
Handler_read_rnd_next				Yes	Both	No
Handler_rollback				Yes	Both	No
Handler_savepoint				Yes	Both	No
Handler_savepoint_rollback				Yes	Both	No
Handler_update				Yes	Both	No
Handler_write				Yes	Both	No
have_archive			Yes		Global	No
have_blackhole_engine			Yes		Global	No
have_compress			Yes		Global	No
have_crypt			Yes		Global	No
have_csv			Yes		Global	No
have_dynamic_loading			Yes		Global	No
have_example_engine			Yes		Global	No
have_federated_engine			Yes		Global	No
have_geometry			Yes		Global	No
have_innodb			Yes		Global	No
have_isam			Yes		Global	No
have_merge_engine			Yes		Global	No
have_ndbcluster			Yes		Global	No
have_openssl			Yes		Global	No
have_partitioning			Yes		Global	No
have_query_cache			Yes		Global	No
have_raid			Yes		Global	No

Name	Cmd-Line	Option file	System Var	Status Var	Var Scope	Dynamic
have_row_based_replication			Yes		Global	No
have_rtree_keys			Yes		Global	No
have_ssl			Yes		Global	No
have_symlink			Yes		Global	No
help	Yes	Yes				
hostname			Yes		Global	No
identity			Yes		Session	Yes
ignore_builtin_innodb	Yes	Yes	Yes		Global	No
init_connect	Yes	Yes	Yes		Global	Yes
init-file	Yes	Yes			Global	No
- Variable: init_file			Yes		Global	No
init_slave	Yes	Yes	Yes		Global	Yes
innodb	Yes	Yes				
innodb_adaptive_hash_index	Yes	Yes	Yes		Global	No
innodb_additional_mem_pool_size	Yes	Yes	Yes		Global	No
innodb_autoextend_increment	Yes	Yes	Yes		Global	Yes
innodb_autoinc_lock_mode	Yes	Yes	Yes		Global	No
innodb_buffer_pool_awe_mem_mb	Yes	Yes	Yes		Global	No
Innodb_buffer_pool_pages_data				Yes	Global	No
Innodb_buffer_pool_pages_dirty				Yes	Global	No
Innodb_buffer_pool_pages_flushed				Yes	Global	No
Innodb_buffer_pool_pages_free				Yes	Global	No
Innodb_buffer_pool_pages_latched				Yes	Global	No
Innodb_buffer_pool_pages_misc				Yes	Global	No
Innodb_buffer_pool_pages_total				Yes	Global	No
Innodb_buffer_pool_read_ahead_rnd				Yes	Global	No
Innodb_buffer_pool_read_ahead_seq				Yes	Global	No
Innodb_buffer_pool_read_requests				Yes	Global	No
Innodb_buffer_pool_reads				Yes	Global	No
innodb_buffer_pool_size	Yes	Yes	Yes		Global	No
Innodb_buffer_pool_wait_free				Yes	Global	No
Innodb_buffer_pool_write_requests				Yes	Global	No
innodb_checksums	Yes	Yes	Yes		Global	No
innodb_commit_concurrency	Yes	Yes	Yes		Global	Yes
innodb_concurrency_tickets	Yes	Yes	Yes		Global	Yes
innodb_data_file_path	Yes	Yes	Yes		Global	No
Innodb_data_fsyncs				Yes	Global	No
innodb_data_home_dir	Yes	Yes	Yes		Global	No
Innodb_data_pending_fsyncs				Yes	Global	No
Innodb_data_pending_reads				Yes	Global	No
Innodb_data_pending_writes				Yes	Global	No
Innodb_data_read				Yes	Global	No
Innodb_data_reads				Yes	Global	No
Innodb_data_writes				Yes	Global	No
Innodb_data_written				Yes	Global	No
Innodb_dblwr_pages_written				Yes	Global	No
Innodb_dblwr_writes				Yes	Global	No

Name	Cmd-Line	Option file	System Var	Status Var	Var Scope	Dynamic
innodb_doublewrite	Yes	Yes	Yes		Global	No
innodb_fast_shutdown	Yes	Yes	Yes		Global	Yes
innodb_file_io_threads	Yes	Yes	Yes		Global	No
innodb_file_per_table	Yes	Yes	Yes		Global	No
innodb_flush_log_at_trx_commit	Yes	Yes	Yes		Global	Yes
innodb_flush_method	Yes	Yes	Yes		Global	No
innodb_force_recovery	Yes	Yes	Yes		Global	No
innodb_lock_wait_timeout	Yes	Yes	Yes		Global	No
innodb_locks_unsafe_for_binlog	Yes	Yes	Yes		Global	No
innodb_log_arch_dir	Yes	Yes	Yes		Global	No
innodb_log_archive	Yes	Yes	Yes		Global	No
innodb_log_buffer_size	Yes	Yes	Yes		Global	No
innodb_log_file_size	Yes	Yes	Yes		Global	No
innodb_log_files_in_group	Yes	Yes	Yes		Global	No
innodb_log_group_home_dir	Yes	Yes	Yes		Global	No
Innodb_log_waits				Yes	Global	No
Innodb_log_write_requests				Yes	Global	No
Innodb_log_writes				Yes	Global	No
innodb_max_dirty_pages_pct	Yes	Yes	Yes		Global	Yes
innodb_max_purge_lag	Yes	Yes	Yes		Global	Yes
innodb_mirrored_log_groups	Yes	Yes	Yes		Global	No
innodb_open_files	Yes	Yes	Yes		Global	No
Innodb_os_log_fsyncs				Yes	Global	No
Innodb_os_log_pending_fsyncs				Yes	Global	No
Innodb_os_log_pending_writes				Yes	Global	No
Innodb_os_log_written				Yes	Global	No
Innodb_page_size				Yes	Global	No
Innodb_pages_created				Yes	Global	No
Innodb_pages_read				Yes	Global	No
Innodb_pages_written				Yes	Global	No
innodb_rollback_on_timeout	Yes	Yes	Yes		Global	No
Innodb_row_lock_current_waits				Yes	Global	No
Innodb_row_lock_time				Yes	Global	No
Innodb_row_lock_time_avg				Yes	Global	No
Innodb_row_lock_time_max				Yes	Global	No
Innodb_row_lock_waits				Yes	Global	No
Innodb_rows_deleted				Yes	Global	No
Innodb_rows_inserted				Yes	Global	No
Innodb_rows_read				Yes	Global	No
Innodb_rows_updated				Yes	Global	No
innodb_stats_on_metadata	Yes	Yes	Yes		Global	Yes
innodb_status_file	Yes	Yes				
innodb_support_xa	Yes	Yes	Yes		Both	Yes
innodb_sync_spin_loops	Yes	Yes	Yes		Global	Yes
innodb_table_locks	Yes	Yes	Yes		Both	Yes
innodb_thread_concurrency	Yes	Yes	Yes		Global	Yes
innodb_thread_sleep_delay	Yes	Yes	Yes		Global	Yes

Name	Cmd-Line	Option file	System Var	Status Var	Var Scope	Dynamic
<a href="#">innodb_use_legacy_cardinality_algorithm</a>	Yes	Yes	Yes		Global	Yes
<a href="#">insert_id</a>			Yes		Session	Yes
<a href="#">interactive_timeout</a>	Yes	Yes	Yes		Both	Yes
<a href="#">join_buffer_size</a>	Yes	Yes	Yes		Both	Yes
<a href="#">keep_files_on_create</a>	Yes	Yes	Yes		Both	Yes
<a href="#">Key_blocks_not_flushed</a>				Yes	Global	No
<a href="#">Key_blocks_unused</a>				Yes	Global	No
<a href="#">Key_blocks_used</a>				Yes	Global	No
<a href="#">key_buffer_size</a>	Yes	Yes	Yes		Global	Yes
<a href="#">key_cache_age_threshold</a>	Yes	Yes	Yes		Global	Yes
<a href="#">key_cache_block_size</a>	Yes	Yes	Yes		Global	Yes
<a href="#">key_cache_division_limit</a>	Yes	Yes	Yes		Global	Yes
<a href="#">Key_read_requests</a>				Yes	Global	No
<a href="#">Key_reads</a>				Yes	Global	No
<a href="#">Key_write_requests</a>				Yes	Global	No
<a href="#">Key_writes</a>				Yes	Global	No
<a href="#">language</a>	Yes	Yes	Yes		Global	No
<a href="#">large_page_size</a>			Yes		Global	No
<a href="#">large-pages</a>	Yes	Yes			Global	No
- Variable: large_pages			Yes		Global	No
<a href="#">last_insert_id</a>			Yes		Session	Yes
<a href="#">Last_query_cost</a>				Yes	Session	No
<a href="#">lc_time_names</a>			Yes		Both	Yes
<a href="#">license</a>			Yes		Global	No
<a href="#">local_infile</a>			Yes		Global	Yes
<a href="#">local-infile</a>	Yes	Yes				
- Variable: local_infile						
<a href="#">locked_in_memory</a>			Yes		Global	No
<a href="#">log</a>	Yes	Yes	Yes		Global	Yes
<a href="#">log_bin</a>			Yes		Global	No
<a href="#">log-bin</a>	Yes	Yes	Yes		Global	No
<a href="#">log-bin-index</a>	Yes	Yes				
<a href="#">log-bin-trust-function-creators</a>	Yes	Yes			Global	Yes
- Variable: log_bin_trust_function_creators			Yes		Global	Yes
<a href="#">log-bin-trust-routine-creators</a>	Yes	Yes			Global	Yes
- Variable: log_bin_trust_routine_creators			Yes		Global	Yes
<a href="#">log-error</a>	Yes	Yes			Global	No
- Variable: log_error			Yes		Global	No
<a href="#">log-isam</a>	Yes	Yes				
<a href="#">log-output</a>	Yes	Yes			Global	Yes
- Variable: log_output			Yes		Global	Yes
<a href="#">log-queries-not-using-indexes</a>	Yes	Yes			Global	Yes
- Variable: log_queries_not_using_indexes			Yes		Global	Yes
<a href="#">log-short-format</a>	Yes	Yes				
<a href="#">log-slave-updates</a>	Yes	Yes			Global	No
- Variable: log_slave_updates			Yes		Global	No
<a href="#">log-slow-admin-statements</a>	Yes	Yes				

Name	Cmd-Line	Option file	System Var	Status Var	Var Scope	Dynamic
log-slow-queries	Yes	Yes			Global	Yes
- Variable: log_slow_queries			Yes		Global	Yes
log-slow-slave-statements	Yes	Yes				
log-tc	Yes	Yes				
log-tc-size	Yes	Yes				
log-warnings	Yes	Yes			Both	Yes
- Variable: log_warnings			Yes		Both	Yes
long_query_time	Yes	Yes	Yes		Both	Yes
low-priority-updates	Yes	Yes			Both	Yes
- Variable: low_priority_updates			Yes		Both	Yes
lower_case_file_system	Yes	Yes	Yes		Global	No
lower_case_table_names	Yes	Yes	Yes		Global	No
master-bind	Yes	Yes	Yes			No
master-connect-retry	Yes	Yes				
master-host	Yes	Yes				
master-info-file	Yes	Yes				
master-password	Yes	Yes				
master-port	Yes	Yes				
master-retry-count	Yes	Yes				
master-ssl	Yes	Yes				
master-ssl-ca	Yes	Yes				
master-ssl-capath	Yes	Yes				
master-ssl-cert	Yes	Yes				
master-ssl-cipher	Yes	Yes				
master-ssl-key	Yes	Yes				
master-user	Yes	Yes				
max_allowed_packet	Yes	Yes	Yes		Both	Yes
max_binlog_cache_size	Yes	Yes	Yes		Global	Yes
max-binlog-dump-events	Yes	Yes				
max_binlog_size	Yes	Yes	Yes		Global	Yes
max_connect_errors	Yes	Yes	Yes		Global	Yes
max_connections	Yes	Yes	Yes		Global	Yes
max_delayed_threads	Yes	Yes	Yes		Both	Yes
max_error_count	Yes	Yes	Yes		Both	Yes
max_heap_table_size	Yes	Yes	Yes		Both	Yes
max_insert_delayed_threads			Yes		Both	Yes
max_join_size	Yes	Yes	Yes		Both	Yes
max_length_for_sort_data	Yes	Yes	Yes		Both	Yes
max_prepared_stmt_count	Yes	Yes	Yes		Global	Yes
max_relay_log_size	Yes	Yes	Yes		Global	Yes
max_seeks_for_key	Yes	Yes	Yes		Both	Yes
max_sort_length	Yes	Yes	Yes		Both	Yes
max_sp_recursion_depth	Yes	Yes	Yes		Both	Yes
max_tmp_tables	Yes	Yes	Yes		Both	Yes
Max_used_connections				Yes	Global	No
max_user_connections	Yes	Yes	Yes		Both	Yes
max_write_lock_count	Yes	Yes	Yes		Global	Yes

Name	Cmd-Line	Option file	System Var	Status Var	Var Scope	Dynamic
memlock	Yes	Yes	Yes		Global	No
merge	Yes	Yes				
min-examined-row-limit	Yes	Yes	Yes		Both	Yes
multi_range_count	Yes	Yes	Yes		Both	Yes
myisam-block-size	Yes	Yes				
myisam_data_pointer_size	Yes	Yes	Yes		Global	Yes
myisam_max_sort_file_size	Yes	Yes	Yes		Global	Yes
myisam-recover	Yes	Yes				
myisam_recover_options			Yes		Global	No
myisam_repair_threads	Yes	Yes	Yes		Both	Yes
myisam_sort_buffer_size	Yes	Yes	Yes		Both	Yes
myisam_stats_method	Yes	Yes	Yes		Both	Yes
myisam_use_mmap	Yes	Yes	Yes		Global	Yes
named_pipe			Yes		Global	No
ndb_autoincrement_prefetch_sz	Yes	Yes	Yes		Both	Yes
ndb-batch-size	Yes	Yes	Yes		Global	No
ndb_cache_check_time	Yes	Yes	Yes		Global	Yes
ndb-cluster-connection-pool	Yes	Yes		Yes	Global	No
Ndb_cluster_node_id				Yes	Both	No
Ndb_config_from_host				Yes	Both	No
Ndb_config_from_port				Yes	Both	No
Ndb_conflict_fn_max				Yes	Global	No
Ndb_conflict_fn_old				Yes	Global	No
ndb-connectstring	Yes	Yes				
ndb_execute_count				Yes	Global	No
ndb_extra_logging	Yes	Yes	Yes		Global	Yes
ndb_force_send	Yes	Yes	Yes		Both	Yes
ndb_index_stat_cache_entries	Yes	Yes				
ndb_index_stat_enable	Yes	Yes				
ndb_index_stat_update_freq	Yes	Yes				
ndb_log_empty_epochs	Yes	Yes	Yes		Global	Yes
ndb_log_orig			Yes		Global	No
ndb-log-update-as-write	Yes	Yes	Yes		Global	Yes
ndb_log_updated_only	Yes	Yes	Yes		Global	Yes
ndb-mgmd-host	Yes	Yes				
ndb-nodeid	Yes	Yes		Yes	Global	No
Ndb_number_of_data_nodes				Yes	Global	No
ndb_optimization_delay			Yes		Global	Yes
ndb_optimized_node_selection	Yes	Yes				
ndb_pruned_scan_count				Yes	Global	No
ndb_report_thresh_binlog_epoch_slip	Yes	Yes				
ndb_report_thresh_binlog_mem_usage	Yes	Yes				
ndb_scan_count				Yes	Global	No
ndb_table_no_logging			Yes		Session	Yes
ndb_table_temporary			Yes		Session	Yes
ndb_use_copying_alter_table			Yes		Both	No
ndb_use_exact_count			Yes		Both	Yes

Name	Cmd-Line	Option file	System Var	Status Var	Var Scope	Dynamic
<a href="#">ndb_use_transactions</a>	Yes	Yes				
<a href="#">ndb_wait_connected</a>	Yes	Yes	Yes			No
<a href="#">ndbcluster</a>	Yes	Yes				
<a href="#">net_buffer_length</a>	Yes	Yes	Yes		Both	Yes
<a href="#">net_read_timeout</a>	Yes	Yes	Yes		Both	Yes
<a href="#">net_retry_count</a>	Yes	Yes	Yes		Both	Yes
<a href="#">net_write_timeout</a>	Yes	Yes	Yes		Both	Yes
<a href="#">new</a>	Yes	Yes	Yes		Both	Yes
<a href="#">no-defaults</a>	Yes					
<a href="#">Not_flushed_delayed_rows</a>				Yes	Global	No
<a href="#">old</a>	Yes	Yes	Yes		Global	No
<a href="#">old-alter-table</a> - Variable: <a href="#">old_alter_table</a>	Yes	Yes				
<a href="#">old-passwords</a> - Variable: <a href="#">old_passwords</a>	Yes	Yes			Both	Yes
<a href="#">old-style-user-limits</a>	Yes	Yes		Yes	Both	Yes
<a href="#">one-thread</a>	Yes	Yes				
<a href="#">Open_files</a>				Yes	Global	No
<a href="#">open-files-limit</a> - Variable: <a href="#">open_files_limit</a>	Yes	Yes			Global	No
<a href="#">Open_streams</a>				Yes	Global	No
<a href="#">Open_table_definitions</a>				Yes	Global	No
<a href="#">Open_tables</a>				Yes	Both	No
<a href="#">Opened_files</a>				Yes	Global	No
<a href="#">Opened_table_definitions</a>				Yes	Both	No
<a href="#">Opened_tables</a>				Yes	Both	No
<a href="#">optimizer_prune_level</a>	Yes	Yes	Yes		Both	Yes
<a href="#">optimizer_search_depth</a>	Yes	Yes	Yes		Both	Yes
<a href="#">optimizer_switch</a>	Yes	Yes	Yes		Both	Yes
<a href="#">pid-file</a> - Variable: <a href="#">pid_file</a>	Yes	Yes			Global	No
<a href="#">plugin_dir</a>	Yes	Yes	Yes		Global	No
<a href="#">plugin-load</a>	Yes	Yes				
<a href="#">port</a>	Yes	Yes	Yes		Global	No
<a href="#">port-open-timeout</a>	Yes	Yes				
<a href="#">preload_buffer_size</a>	Yes	Yes	Yes		Both	Yes
<a href="#">Prepared_stmt_count</a>				Yes	Global	No
<a href="#">prepared_stmt_count</a>			Yes		Global	No
<a href="#">print-defaults</a>	Yes					
<a href="#">profiling</a>			Yes		Session	Yes
<a href="#">profiling_history_size</a>			Yes		Both	Yes
<a href="#">protocol_version</a>			Yes		Global	No
<a href="#">Qcache_free_blocks</a>				Yes	Global	No
<a href="#">Qcache_free_memory</a>				Yes	Global	No
<a href="#">Qcache_hits</a>				Yes	Global	No
<a href="#">Qcache_inserts</a>				Yes	Global	No
<a href="#">Qcache_lowmem_prunes</a>				Yes	Global	No

Name	Cmd-Line	Option file	System Var	Status Var	Var Scope	Dynamic
Qcache_not_cached				Yes	Global	No
Qcache_queries_in_cache				Yes	Global	No
Qcache_total_blocks				Yes	Global	No
Queries				Yes	Both	No
query_alloc_block_size	Yes	Yes	Yes		Both	Yes
query_cache_limit	Yes	Yes	Yes		Global	Yes
query_cache_min_res_unit	Yes	Yes	Yes		Global	Yes
query_cache_size	Yes	Yes	Yes		Global	Yes
query_cache_type	Yes	Yes	Yes		Both	Yes
query_cache_wlock_invalidate	Yes	Yes	Yes		Both	Yes
query_prealloc_size	Yes	Yes	Yes		Both	Yes
Questions				Yes	Both	No
rand_seed1			Yes		Session	Yes
rand_seed2			Yes		Session	Yes
range_alloc_block_size	Yes	Yes	Yes		Both	Yes
read_buffer_size	Yes	Yes	Yes		Both	Yes
read_only	Yes	Yes	Yes		Global	Yes
read_rnd_buffer_size	Yes	Yes	Yes		Both	Yes
relay-log	Yes	Yes				
relay-log-index	Yes	Yes				
- Variable: relay_log_index						
relay-log-info-file	Yes	Yes				
- Variable: relay_log_info_file						
relay_log_purge	Yes	Yes	Yes		Global	Yes
relay_log_space_limit	Yes	Yes	Yes		Global	No
replicate-do-db	Yes	Yes				
replicate-do-table	Yes	Yes				
replicate-ignore-db	Yes	Yes				
replicate-ignore-table	Yes	Yes				
replicate-rewrite-db	Yes	Yes				
replicate-same-server-id	Yes	Yes				
replicate-wild-do-table	Yes	Yes				
replicate-wild-ignore-table	Yes	Yes				
report-host	Yes	Yes			Global	No
- Variable: report_host			Yes		Global	No
report-password	Yes	Yes			Global	No
- Variable: report_password			Yes		Global	No
report-port	Yes	Yes			Global	No
- Variable: report_port			Yes		Global	No
report-user	Yes	Yes			Global	No
- Variable: report_user			Yes		Global	No
rpl_recovery_rank			Yes		Global	Yes
Rpl_status				Yes	Global	No
safe-mode	Yes	Yes				
safe-show-database	Yes	Yes	Yes		Global	Yes
safe-user-create	Yes	Yes				
safemalloc-mem-limit	Yes	Yes				



Name	Cmd-Line	Option file	System Var	Status Var	Var Scope	Dynamic
secure-auth	Yes	Yes			Global	Yes
- Variable: secure_auth			Yes		Global	Yes
secure-file-priv	Yes	Yes			Global	No
- Variable: secure_file_priv			Yes		Global	No
Select_full_join				Yes	Both	No
Select_full_range_join				Yes	Both	No
Select_range				Yes	Both	No
Select_range_check				Yes	Both	No
Select_scan				Yes	Both	No
server-id	Yes	Yes			Global	Yes
- Variable: server_id			Yes		Global	Yes
shared_memory			Yes		Global	No
shared_memory_base_name			Yes		Global	No
show-slave-auth-info	Yes	Yes				
skip-character-set-client-handshake	Yes	Yes				
skip-concurrent-insert	Yes	Yes				
- Variable: concurrent_insert						
skip-external-locking	Yes	Yes			Global	No
- Variable: skip_external_locking			Yes		Global	No
skip-grant-tables	Yes	Yes				
skip-host-cache	Yes	Yes				
skip-innodb	Yes	Yes				
skip-innodb-checksums	Yes	Yes				
skip-locking	Yes	Yes				
skip-log-warnings	Yes					
skip-merge	Yes	Yes				
- Variable:						
skip-name-resolve	Yes	Yes				
skip-ndbcluster	Yes	Yes				
skip-networking	Yes	Yes			Global	No
- Variable: skip_networking			Yes		Global	No
skip-new	Yes	Yes				
skip-safemalloc	Yes	Yes				
skip-show-database	Yes	Yes			Global	No
- Variable: skip_show_database			Yes		Global	No
skip-slave-start	Yes	Yes				
skip-ssl	Yes	Yes				
skip-stack-trace	Yes	Yes				
skip-symbolic-links	Yes					
skip-symlink	Yes	Yes				
skip-thread-priority	Yes	Yes				
slave-allow-batching	Yes	Yes			Global	Yes
- Variable: slave_allow_batching			Yes		Global	Yes
slave_compressed_protocol	Yes	Yes	Yes		Global	Yes
slave_exec_mode			Yes		Global	Yes
Slave_heartbeat_period				Yes	Global	No
slave-load-tmpdir	Yes	Yes			Global	No

Name	Cmd-Line	Option file	System Var	Status Var	Var Scope	Dynamic
- Variable: slave_load_tmpdir			Yes		Global	No
slave-net-timeout	Yes	Yes			Global	Yes
- Variable: slave_net_timeout			Yes		Global	Yes
Slave_open_temp_tables				Yes	Global	No
Slave_received_heartbeats				Yes	Global	No
Slave_retried_transactions				Yes	Global	No
Slave_running				Yes	Global	No
slave-skip-errors	Yes	Yes			Global	No
- Variable: slave_skip_errors			Yes		Global	No
slave_transaction_retries	Yes	Yes	Yes		Global	Yes
Slow_launch_threads				Yes	Both	No
slow_launch_time	Yes	Yes	Yes		Global	Yes
Slow_queries				Yes	Both	No
slow-query-log	Yes	Yes			Global	Yes
- Variable: slow_query_log			Yes		Global	Yes
slow_query_log_file	Yes	Yes	Yes		Global	Yes
socket	Yes	Yes	Yes		Global	No
sort_buffer_size	Yes	Yes	Yes		Both	Yes
Sort_merge_passes				Yes	Both	No
Sort_range				Yes	Both	No
Sort_rows				Yes	Both	No
Sort_scan				Yes	Both	No
sporadic-binlog-dump-fail	Yes	Yes				
sql_auto_is_null			Yes		Session	Yes
sql_big_selects			Yes		Session	Yes
sql_big_tables			Yes		Session	Yes
sql_buffer_result			Yes		Session	Yes
sql_log_bin			Yes		Session	Yes
sql_log_off			Yes		Session	Yes
sql_log_update			Yes		Session	Yes
sql_low_priority_updates			Yes		Both	Yes
sql_max_join_size			Yes		Both	Yes
sql-mode	Yes	Yes			Both	Yes
- Variable: sql_mode			Yes		Both	Yes
sql_notes			Yes		Session	Yes
sql_quote_show_create			Yes		Session	Yes
sql_safe_updates			Yes		Session	Yes
sql_select_limit			Yes		Both	Yes
sql_slave_skip_counter			Yes		Global	Yes
sql_warnings			Yes		Session	Yes
ssl	Yes	Yes				
Ssl_accept_renegotiates				Yes	Global	No
Ssl_accepts				Yes	Global	No
ssl-ca	Yes	Yes			Global	No
- Variable: ssl_ca			Yes		Global	No
Ssl_callback_cache_hits				Yes	Global	No
ssl-capath	Yes	Yes			Global	No

Name	Cmd-Line	Option file	System Var	Status Var	Var Scope	Dynamic
- Variable: ssl_capath			Yes		Global	No
ssl-cert	Yes	Yes			Global	No
- Variable: ssl_cert			Yes		Global	No
ssl-cipher	Yes	Yes			Global	No
- Variable: ssl_cipher			Yes		Global	No
Ssl_cipher				Yes	Both	No
Ssl_cipher_list				Yes	Both	No
Ssl_client_connects				Yes	Global	No
Ssl_connect_renegotiates				Yes	Global	No
Ssl_ctx_verify_depth				Yes	Global	No
Ssl_ctx_verify_mode				Yes	Global	No
Ssl_default_timeout				Yes	Both	No
Ssl_finished_accepts				Yes	Global	No
Ssl_finished_connects				Yes	Global	No
ssl-key	Yes	Yes			Global	No
- Variable: ssl_key			Yes		Global	No
Ssl_session_cache_hits				Yes	Global	No
Ssl_session_cache_misses				Yes	Global	No
Ssl_session_cache_mode				Yes	Global	No
Ssl_session_cache_overflows				Yes	Global	No
Ssl_session_cache_size				Yes	Global	No
Ssl_session_cache_timeouts				Yes	Global	No
Ssl_sessions_reused				Yes	Both	No
Ssl_used_session_cache_entries				Yes	Global	No
Ssl_verify_depth				Yes	Both	No
Ssl_verify_mode				Yes	Both	No
ssl-verify-server-cert	Yes	Yes				
Ssl_version				Yes	Both	No
standalone	Yes	Yes				
storage_engine			Yes		Both	Yes
symbolic-links	Yes	Yes				
sync-binlog	Yes	Yes			Global	Yes
- Variable: sync_binlog			Yes		Global	Yes
sync_frm	Yes	Yes			Global	Yes
- Variable: sync_frm			Yes		Global	Yes
sysdate-is-now	Yes	Yes				
system_time_zone			Yes		Global	No
table_cache	Yes	Yes	Yes		Global	Yes
table_definition_cache	Yes	Yes	Yes		Global	Yes
table_lock_wait_timeout	Yes	Yes	Yes		Global	Yes
Table_locks_immediate				Yes	Global	No
Table_locks_waited				Yes	Global	No
table_open_cache	Yes	Yes	Yes		Global	Yes
table_type			Yes		Both	Yes
tc-heuristic-recover	Yes	Yes				
Tc_log_max_pages_used				Yes	Global	No
Tc_log_page_size				Yes	Global	No

Name	Cmd-Line	Option file	System Var	Status Var	Var Scope	Dynamic
<a href="#">Tc_log_page_waits</a>				Yes	Global	No
<a href="#">temp-pool</a>	Yes	Yes				
<a href="#">thread_cache_size</a>	Yes	Yes	Yes		Global	Yes
<a href="#">thread_concurrency</a>	Yes	Yes	Yes		Global	No
<a href="#">thread_handling</a>	Yes	Yes	Yes		Global	No
<a href="#">thread_stack</a>	Yes	Yes	Yes		Global	No
<a href="#">Threads_cached</a>				Yes	Global	No
<a href="#">Threads_connected</a>				Yes	Global	No
<a href="#">Threads_created</a>				Yes	Global	No
<a href="#">Threads_running</a>				Yes	Global	No
<a href="#">time_format</a>	Yes	Yes	Yes		Both	Yes
<a href="#">time_zone</a>	Yes	Yes	Yes		Both	Yes
<a href="#">timed_mutexes</a>	Yes	Yes	Yes		Global	Yes
<a href="#">timestamp</a>			Yes		Session	Yes
<a href="#">tmp_table_size</a>	Yes	Yes	Yes		Both	Yes
<a href="#">tmpdir</a>	Yes	Yes	Yes		Global	No
<a href="#">transaction_alloc_block_size</a>	Yes	Yes	Yes		Both	Yes
<a href="#">transaction_allow_batching</a>			Yes		Session	Yes
<a href="#">transaction-isolation</a>	Yes	Yes				
<a href="#">transaction_prealloc_size</a>	Yes	Yes	Yes		Both	Yes
<a href="#">tx_isolation</a>			Yes		Both	Yes
<a href="#">unique_checks</a>			Yes		Session	Yes
<a href="#">updatable_views_with_limit</a>	Yes	Yes	Yes		Both	Yes
<a href="#">Uptime</a>				Yes	Global	No
<a href="#">Uptime_since_flush_status</a>				Yes	Global	No
<a href="#">use-symbolic-links</a>	Yes	Yes				
<a href="#">user</a>	Yes	Yes				
<a href="#">verbose</a>	Yes	Yes				
<a href="#">version</a>	Yes	Yes	Yes		Global	No
<a href="#">version_comment</a>			Yes		Global	No
<a href="#">version_compile_machine</a>			Yes		Global	No
<a href="#">version_compile_os</a>			Yes		Global	No
<a href="#">wait_timeout</a>	Yes	Yes	Yes		Both	Yes
<a href="#">warning_count</a>			Yes		Session	No

<sup>a</sup>This option is dynamic, but only the server should set this information. You should not set the value of this variable manually.

<sup>b</sup>This option is dynamic, but only the server should set this information. You should not set the value of this variable manually.

## 5.1.2. Server Command Options

When you start the `mysqld` server, you can specify program options using any of the methods described in [Section 4.2.3, “Specifying Program Options”](#). The most common methods are to provide options in an option file or on the command line. However, in most cases it is desirable to make sure that the server uses the same options each time it runs. The best way to ensure this is to list them in an option file. See [Section 4.2.3.2, “Using Option Files”](#).

### MySQL Enterprise

For expert advice on setting command options, subscribe to the MySQL Enterprise Monitor. For more information, see <http://www.mysql.com/products/enterprise/advisors.html>.

`mysqld` reads options from the `[mysqld]` and `[server]` groups. `mysqld_safe` reads options from the `[mysqld]`, `[server]`, `[mysqld_safe]`, and `[safe_mysqld]` groups. `mysql.server` reads options from the `[mysqld]` and `[mysql.server]` groups.

An embedded MySQL server usually reads options from the `[server]`, `[embedded]`, and `[xxxxxx_SERVER]` groups, where `xxxxxx` is the name of the application into which the server is embedded.

`mysqld` accepts many command options. For a brief summary, execute `mysqld --help`. To see the full list, use `mysqld -verbose --help`.

The following list shows some of the most common server options. Additional options are described in other sections:

- Options that affect security: See [Section 5.3.3, “Security-Related `mysqld` Options”](#).
- SSL-related options: See [Section 5.5.7.3, “SSL Command Options”](#).
- Binary log control options: See [Section 5.2.4, “The Binary Log”](#).
- Replication-related options: See [Section 16.1.3, “Replication and Binary Logging Options and Variables”](#).
- Options specific to particular storage engines: See [Section 13.4.1, “MyISAM Startup Options”](#), [Section 13.6.3, “InnoDB Startup Options and System Variables”](#), and [mysqld Command Options for MySQL Cluster](#).

You can also set the values of server system variables by using variable names as options, as described at the end of this section.

- `--help, -?`

<b>Command Line Format</b>	<code>-?</code>
<b>Config File Format</b>	<code>help</code>

Display a short help message and exit. Use both the `--verbose` and `--help` options to see the full message.

- `--allow-suspicious-udfs`

<b>Command Line Format</b>	<code>--allow-suspicious-udfs</code>	
<b>Config File Format</b>	<code>allow-suspicious-udfs</code>	
<b>Value Set</b>	<b>Type</b>	boolean
	<b>Default</b>	FALSE

This option controls whether user-defined functions that have only an `xxx` symbol for the main function can be loaded. By default, the option is off and only UDFs that have at least one auxiliary symbol can be loaded; this prevents attempts at loading functions from shared object files other than those containing legitimate UDFs. See [Section 21.3.2.6, “User-Defined Function Security Precautions”](#).

- `--ansi`

<b>Command Line Format</b>	<code>--ansi</code>
<b>Config File Format</b>	<code>ansi</code>

Use standard (ANSI) SQL syntax instead of MySQL syntax. For more precise control over the server SQL mode, use the `-sql-mode` option instead. See [Section 1.7.3, “Running MySQL in ANSI Mode”](#), and [Section 5.1.7, “Server SQL Modes”](#).

- `--basedir=path, -b path`

<b>Command Line Format</b>	<code>--basedir=name</code>	
<b>Config File Format</b>	<code>basedir</code>	
<b>Option Sets Variable</b>	Yes, <code>basedir</code>	
<b>Variable Name</b>	<code>basedir</code>	
<b>Variable Scope</b>	Global	
<b>Dynamic Variable</b>	No	
<b>Value Set</b>	<b>Type</b>	filename

The path to the MySQL installation directory. All paths are usually resolved relative to this directory.

- `--big-tables`

<b>Command Line Format</b>	<code>--big-tables</code>	
<b>Config File Format</b>	<code>big-tables</code>	
<b>Option Sets Variable</b>	Yes, <code>big_tables</code>	
<b>Variable Name</b>	<code>big-tables</code>	
<b>Variable Scope</b>	Session	
<b>Dynamic Variable</b>	Yes	
<b>Value Set</b>	<b>Type</b>	<code>boolean</code>

Allow large result sets by saving all temporary sets in files. This option prevents most “table full” errors, but also slows down queries for which in-memory tables would suffice. Since MySQL 3.23.2, the server is able to handle large result sets automatically by using memory for small temporary tables and switching to disk tables where necessary.

- `--bind-address=IP`

<b>Command Line Format</b>	<code>--bind-address=name</code>	
<b>Config File Format</b>	<code>bind-address</code>	
<b>Value Set</b>	<b>Type</b>	<code>string</code>
	<b>Default</b>	<code>0.0.0.0</code>
	<b>Range</b>	<code>0.0.0.0-255.255.255.255</code>

The IP address to bind to. Only one address can be selected. If this option is specified multiple times, the last address given is used.

If no address or `0.0.0.0` is specified, the server listens on all interfaces.

- `--binlog-format={ROW | STATEMENT | MIXED}`

<b>Version Introduced</b>	5.1.5	
<b>Command Line Format</b>	<code>--binlog-format</code>	
<b>Config File Format</b>	<code>binlog-format</code>	
<b>Option Sets Variable</b>	Yes, <code>binlog_format</code>	
<b>Variable Name</b>	<code>binlog_format</code>	
<b>Variable Scope</b>	Both	
<b>Dynamic Variable</b>	Yes	
<b>Value Set (&gt;= 5.1.5, &lt;= 5.1.7)</b>	<b>Type</b>	<code>enumeration</code>
	<b>Default</b>	<code>STATEMENT</code>
	<b>Valid Values</b>	<code>ROW, STATEMENT</code>
<b>Value Set (&gt;= 5.1.8, &lt;= 5.1.11)</b>	<b>Type</b>	<code>enumeration</code>
	<b>Default</b>	<code>STATEMENT</code>
	<b>Valid Values</b>	<code>ROW, STATEMENT, MIXED</code>
<b>Value Set (&gt;= 5.1.12, &lt;= 5.1.28)</b>	<b>Type</b>	<code>enumeration</code>
	<b>Default</b>	<code>MIXED</code>
	<b>Valid Values</b>	<code>ROW, STATEMENT, MIXED</code>
<b>Value Set (&gt;= 5.1.29)</b>	<b>Type</b>	<code>enumeration</code>
	<b>Default</b>	<code>STATEMENT</code>
	<b>Valid Values</b>	<code>ROW, STATEMENT, MIXED</code>

Specify whether to use row-based, statement-based, or mixed replication (statement-based was the default prior to MySQL 5.1.12; in 5.1.12, the default was changed to mixed replication; in 5.1.29, the default was changed back to statement-based). See [Section 16.1.2, “Replication Formats”](#). This option was added in MySQL 5.1.5.

### Important

**MySQL Cluster.** The default value for this option in all MySQL Cluster NDB 6.1, 6.2, 6.3, and later 6.x releases is `MIXED`. See [MySQL Cluster Replication — Assumptions and General Requirements](#), for more information.

- `--bootstrap`

<b>Command Line Format</b>	<code>--bootstrap</code>
<b>Config File Format</b>	<code>bootstrap</code>

This option is used by the `mysql_install_db` script to create the MySQL privilege tables without having to start a full MySQL server.

This option is unavailable if MySQL was configured with the `--disable-grant-options` option. See [Section 2.10.2, “Typical configure Options”](#).

- `--character-sets-dir=path`

<b>Command Line Format</b>	<code>--character-sets-dir=name</code>	
<b>Config File Format</b>	<code>character-sets-dir</code>	
<b>Option Sets Variable</b>	Yes, <code>character_sets_dir</code>	
<b>Variable Name</b>	<code>character-sets-dir</code>	
<b>Variable Scope</b>	Global	
<b>Dynamic Variable</b>	No	
<b>Value Set</b>	<b>Type</b>	<code>filename</code>

The directory where character sets are installed. See [Section 9.2, “The Character Set Used for Data and Sorting”](#).

- `--character-set-client-handshake`

<b>Command Line Format</b>	<code>--character-set-client-handshake</code>	
<b>Config File Format</b>	<code>character-set-client-handshake</code>	
<b>Value Set</b>	<b>Type</b>	<code>boolean</code>
	<b>Default</b>	<code>TRUE</code>

Don't ignore character set information sent by the client. To ignore client information and use the default server character set, use `--skip-character-set-client-handshake`; this makes MySQL behave like MySQL 4.0.

- `--character-set-filesystem=charset_name`

<b>Version Introduced</b>	5.1.6	
<b>Command Line Format</b>	<code>--character-set-filesystem=name</code>	
<b>Config File Format</b>	<code>character-set-filesystem</code>	
<b>Option Sets Variable</b>	Yes, <code>character_set_filesystem</code>	
<b>Variable Name</b>	<code>character_set_filesystem</code>	
<b>Variable Scope</b>	Both	
<b>Dynamic Variable</b>	Yes	
<b>Value Set</b>	<b>Type</b>	<code>string</code>

The file system character set. This option sets the `character_set_filesystem` system variable. It was added in MySQL 5.1.6.

- `--character-set-server=charset_name, -C charset_name`

<b>Command Line Format</b>	<code>--character-set-server</code>	
<b>Config File Format</b>	<code>character-set-server</code>	
<b>Option Sets Variable</b>	Yes, <code>character_set_server</code>	
<b>Variable Name</b>	<code>character_set_server</code>	
<b>Variable Scope</b>	Both	
<b>Dynamic Variable</b>	Yes	
<b>Value Set</b>	<b>Type</b>	<code>string</code>

Use `charset_name` as the default server character set. See [Section 9.2, “The Character Set Used for Data and Sorting”](#). If you use this option to specify a non-default character set, you should also use `--collation-server` to specify the collation.

- `--chroot=path, -r path`

<b>Command Line Format</b>	<code>--chroot=name</code>	
<b>Config File Format</b>	<code>chroot</code>	
<b>Value Set</b>	<b>Type</b>	<code>filename</code>

Put the `mysqld` server in a closed environment during startup by using the `chroot()` system call. This is a recommended security measure. Note that use of this option somewhat limits `LOAD DATA INFILE` and `SELECT ... INTO OUTFILE`.

- `--collation-server=collation_name`

<b>Command Line Format</b>	<code>--collation-server</code>	
<b>Config File Format</b>	<code>collation-server</code>	
<b>Option Sets Variable</b>	Yes, <code>collation_server</code>	
<b>Variable Name</b>	<code>collation_server</code>	
<b>Variable Scope</b>	Both	
<b>Dynamic Variable</b>	Yes	
<b>Value Set</b>	<b>Type</b>	<code>string</code>

Use `collation_name` as the default server collation. See [Section 9.2, “The Character Set Used for Data and Sorting”](#).

- `--console`

<b>Command Line Format</b>	<code>--console</code>	
<b>Config File Format</b>	<code>console</code>	
<b>Platform Specific</b>	windows	

(Windows only.) Write error log messages to `stderr` and `stdout` even if `--log-error` is specified. `mysqld` does not close the console window if this option is used.

- `--core-file`

<b>Command Line Format</b>	<code>--core-file</code>	
<b>Config File Format</b>	<code>core-file</code>	
<b>Value Set</b>	<b>Type</b>	<code>boolean</code>
	<b>Default</b>	<code>TRUE</code>

Write a core file if `mysqld` dies. The name and location of the core file is system dependent. On Linux, a core file named `core.pid` is written to the current working directory of the process, which for `mysqld` is the data directory. `pid` represents



the process ID of the server process. On Mac OS X, a core file named `core.pid` is written to the `/cores` directory. On Solaris, use the `coreadm` command to specify where to write the core file and how to name it.

For some systems, to get a core file you must also specify the `--core-file-size` option to `mysqld_safe`. See [Section 4.3.2, “mysqld\\_safe — MySQL Server Startup Script”](#). On some systems, such as Solaris, you do not get a core file if you are also using the `--user` option. There might be additional restrictions or limitations. For example, it might be necessary to execute `ulimit -c unlimited` before starting the server. Consult your system documentation.

- `--datadir=path, -h path`

<b>Command Line Format</b>	<code>--datadir=name</code>	
<b>Config File Format</b>	<code>datadir</code>	
<b>Option Sets Variable</b>	Yes, <code>datadir</code>	
<b>Variable Name</b>	<code>datadir</code>	
<b>Variable Scope</b>	Global	
<b>Dynamic Variable</b>	No	
<b>Value Set</b>	<b>Type</b>	<code>filename</code>

The path to the data directory.

- `--debug[=debug_options], -# [debug_options]`

<b>Command Line Format</b>	<code>--debug[=debug_options]</code>	
<b>Config File Format</b>	<code>debug</code>	
<b>Variable Name</b>	<code>debug</code>	
<b>Variable Scope</b>	Both	
<b>Dynamic Variable</b>	Yes	
<b>Value Set</b>	<b>Type</b>	<code>string</code>
	<b>Default</b>	<code>'d:t:o,/tmp/mysqld.trace'</code>

If MySQL is configured with `--with-debug`, you can use this option to get a trace file of what `mysqld` is doing. A typical `debug_options` string is `'d:t:o,file_name'`. The default is `'d:t:i:o,mysqld.trace'`. See [MySQL Internals: Porting](#).

As of MySQL 5.1.12, using `--with-debug` to configure MySQL with debugging support enables you to use the `--debug="d,parser_debug"` option when you start the server. This causes the Bison parser that is used to process SQL statements to dump a parser trace to the server's standard error output. Typically, this output is written to the error log.

This option may be given multiple times. Values that begin with `+` or `-` are added to or subtracted from the previous value. For example, `--debug=T --debug=+P` sets the value to `P:T`.

- `--default-character-set=charset_name` (*DEPRECATED*)

<b>Command Line Format</b>	<code>--default-character-set=name</code>	
<b>Config File Format</b>	<code>default-character-set</code>	
<b>Deprecated</b>	5.0	
<b>Value Set</b>	<b>Type</b>	<code>string</code>

Use `charset_name` as the default character set. This option is deprecated in favor of `--character-set-server`. See [Section 9.2, “The Character Set Used for Data and Sorting”](#).

- `--default-collation=collation_name`

<b>Command Line Format</b>	<code>--default-collation=name</code>	
<b>Variable Name</b>	<code>default-collation</code>	
<b>Variable Scope</b>		
<b>Dynamic Variable</b>	No	

<b>Deprecated</b>	4.1.3	
<b>Value Set</b>	<b>Type</b>	string

Use `collation_name` as the default collation. This option is deprecated in favor of `--collation-server`. See [Section 9.2, “The Character Set Used for Data and Sorting”](#).

- `--default-storage-engine=type`

<b>Command Line Format</b>	<code>--default-storage-engine=name</code>
<b>Config File Format</b>	<code>default-storage-engine</code>

Set the default storage engine (table type) for tables. See [Chapter 13, Storage Engines](#).

- `--default-table-type=type`

<b>Command Line Format</b>	<code>--default-table-type=name</code>	
<b>Config File Format</b>	<code>default-table-type</code>	
<b>Deprecated</b>	5.0, by <code>default-storage-engine</code>	
<b>Value Set</b>	<b>Type</b>	string

This option is a deprecated synonym for `--default-storage-engine`.

- `--default-time-zone=timezone`

<b>Command Line Format</b>	<code>--default-time-zone=name</code>	
<b>Config File Format</b>	<code>default-time-zone</code>	
<b>Value Set</b>	<b>Type</b>	string

Set the default server time zone. This option sets the global `time_zone` system variable. If this option is not given, the default time zone is the same as the system time zone (given by the value of the `system_time_zone` system variable).

- `--delay-key-write[={OFF|ON|ALL}]`

<b>Command Line Format</b>	<code>--delay-key-write[=name]</code>	
<b>Config File Format</b>	<code>delay-key-write</code>	
<b>Option Sets Variable</b>	Yes, <code>delay_key_write</code>	
<b>Variable Name</b>	<code>delay-key-write</code>	
<b>Variable Scope</b>	Global	
<b>Dynamic Variable</b>	Yes	
<b>Value Set</b>	<b>Type</b>	enumeration
	<b>Default</b>	ON
	<b>Valid Values</b>	ON, OFF, ALL

Specify how to use delayed key writes. Delayed key writing causes key buffers not to be flushed between writes for `MyISAM` tables. `OFF` disables delayed key writes. `ON` enables delayed key writes for those tables that were created with the `DELAY_KEY_WRITE` option. `ALL` delays key writes for all `MyISAM` tables. See [Section 7.5.3, “Tuning Server Parameters”](#), and [Section 13.4.1, “MyISAM Startup Options”](#).

**Note**

If you set this variable to `ALL`, you should not use `MyISAM` tables from within another program (such as another MySQL server or `myisamchk`) when the tables are in use. Doing so leads to index corruption.

- `--des-key-file=file_name`

<b>Command Line Format</b>	<code>--des-key-file=name</code>
<b>Config File Format</b>	<code>des-key-file</code>

Read the default DES keys from this file. These keys are used by the `DES_ENCRYPT()` and `DES_DECRYPT()` functions.

- `--enable-named-pipe`

<b>Command Line Format</b>	<code>--named_pipe</code>
<b>Config File Format</b>	<code>enable-named-pipe</code>
<b>Platform Specific</b>	windows

Enable support for named pipes. This option applies only on Windows NT, 2000, XP, and 2003 systems. For MySQL 5.1.20 and earlier, this option is available only when using the `mysqld-nt` and `mysqld-debug` servers that support named-pipe connections. For MySQL 5.1.21 and later, `mysqld-nt` is not available, but support is included in the standard `mysqld` and `mysqld-debug` servers.

- `--enable-pstack`

<b>Command Line Format</b>	<code>--enable-pstack</code>	
<b>Config File Format</b>	<code>enable-pstack</code>	
<b>Value Set</b>	<b>Type</b>	boolean
	<b>Default</b>	FALSE

Print a symbolic stack trace on failure.

- `--engine-condition-pushdown={ON|OFF}`

<b>Command Line Format</b>	<code>--engine-condition-pushdown</code>	
<b>Config File Format</b>	<code>engine-condition-pushdown</code>	
<b>Option Sets Variable</b>	Yes, <code>engine_condition_pushdown</code>	
<b>Variable Name</b>	<code>engine_condition_pushdown</code>	
<b>Variable Scope</b>	Both	
<b>Dynamic Variable</b>	Yes	
<b>Value Set (&gt;= 5.1.0)</b>	<b>Type</b>	boolean
	<b>Default</b>	ON

Sets the `engine_condition_pushdown` system variable. For more information, see [Section 7.2.7, “Condition Pushdown Optimization”](#).

- `--event-scheduler[=value]`

<b>Version Introduced</b>	5.1.6	
<b>Command Line Format</b>	<code>--event-scheduler[=value]</code>	
<b>Config File Format</b>	<code>event-scheduler</code>	
<b>Option Sets Variable</b>	Yes, <code>event_scheduler</code>	
<b>Variable Name</b>	<code>event_scheduler</code>	
<b>Variable Scope</b>	Global	
<b>Dynamic Variable</b>	Yes	
<b>Value Set</b>	<b>Type</b>	enumeration
	<b>Default</b>	OFF
	<b>Valid Values</b>	ON, OFF, DISABLED

Enable or disable, and start or stop, the event scheduler. This option was added in MySQL 5.1.6. Note that its permitted values and behaviour changed in MySQL 5.1.11, and again in MySQL 5.1.12.

For detailed information, see [The event-scheduler Option](#).

- `--exit-info[=flags], -T [flags]`

<b>Command Line Format</b>	<code>--exit-info[=<i>flags</i>]</code>	
<b>Config File Format</b>	<code>exit-info</code>	
<b>Value Set</b>	<b>Type</b>	<code>numeric</code>

This is a bit mask of different flags that you can use for debugging the `mysqld` server. Do not use this option unless you know *exactly* what it does!

- `--external-locking`

<b>Command Line Format</b>	<code>--external-locking</code>	
<b>Config File Format</b>	<code>external-locking</code>	
<b>Option Sets Variable</b>	Yes, <code>skip_external_locking</code>	
<b>Disabled by</b>	<code>skip-external-locking</code>	
<b>Value Set</b>	<b>Type</b>	<code>boolean</code>
	<b>Default</b>	<code>FALSE</code>

Enable external locking (system locking), which is disabled by default as of MySQL 4.0. Note that if you use this option on a system on which `lockd` does not fully work (such as Linux), it is easy for `mysqld` to deadlock. This option previously was named `--enable-locking`.

For more information about external locking, including conditions under which it can and cannot be used, see [Section 7.3.4, “External Locking”](#).

- `--flush`

<b>Command Line Format</b>	<code>--flush</code>	
<b>Config File Format</b>	<code>flush</code>	
<b>Variable Name</b>	<code>flush</code>	
<b>Variable Scope</b>	Global	
<b>Dynamic Variable</b>	Yes	
<b>Value Set</b>	<b>Type</b>	<code>boolean</code>
	<b>Default</b>	<code>OFF</code>

Flush (synchronize) all changes to disk after each SQL statement. Normally, MySQL does a write of all changes to disk only after each SQL statement and lets the operating system handle the synchronizing to disk. See [Section B.1.4.2, “What to Do If MySQL Keeps Crashing”](#).

- `--gdb`

<b>Command Line Format</b>	<code>--gdb</code>	
<b>Config File Format</b>	<code>gdb</code>	
<b>Value Set</b>	<b>Type</b>	<code>boolean</code>
	<b>Default</b>	<code>FALSE</code>

Install an interrupt handler for `SIGINT` (needed to stop `mysqld` with `^C` to set breakpoints) and disable stack tracing and core file handling. See [MySQL Internals: Porting](#).

- `--general-log[={0|1}]`

<b>Version Introduced</b>	5.1.12	
<b>Command Line Format</b>	<code>--general-log</code>	
<b>Config File Format</b>	<code>general-log</code>	
<b>Option Sets Variable</b>	Yes, <code>general_log</code>	
<b>Variable Name</b>	<code>general_log</code>	
<b>Variable Scope</b>	Global	
<b>Dynamic Variable</b>	Yes	
<b>Value Set</b>	<b>Type</b>	<code>boolean</code>
	<b>Default</b>	<code>OFF</code>

Specify the initial general query log state. With no argument or an argument of 1, the `--general-log` option enables the log. If omitted or given with an argument of 0, the option disables the log. This option was added in MySQL 5.1.12.

- `--init-file=file_name`

<b>Command Line Format</b>	<code>--init-file=name</code>	
<b>Config File Format</b>	<code>init-file</code>	
<b>Option Sets Variable</b>	Yes, <code>init_file</code>	
<b>Variable Name</b>	<code>init_file</code>	
<b>Variable Scope</b>	Global	
<b>Dynamic Variable</b>	No	
<b>Value Set</b>	<b>Type</b>	<code>filename</code>

Read SQL statements from this file at startup. Each statement must be on a single line and should not include comments.

This option is unavailable if MySQL was configured with the `--disable-grant-options` option. See [Section 2.10.2](#), “Typical configure Options”.

- `--innodb-xxx`

The InnoDB options are listed in [Section 13.6.3](#), “InnoDB Startup Options and System Variables”.

- `--language=lang_name`, `-L lang_name`

<b>Command Line Format</b>	<code>--language=name</code>	
<b>Config File Format</b>	<code>language</code>	
<b>Option Sets Variable</b>	Yes, <code>language</code>	
<b>Variable Name</b>	<code>language</code>	
<b>Variable Scope</b>	Global	
<b>Dynamic Variable</b>	No	
<b>Value Set</b>	<b>Type</b>	<code>filename</code>
	<b>Default</b>	<code>/usr/local/mysql/share/mysql/english/</code>

Return client error messages in the given language. `lang_name` can be given as the language name or as the full path name to the directory where the language files are installed. See [Section 9.3](#), “Setting the Error Message Language”.

- `--large-pages`

<b>Command Line Format</b>	<code>--large-pages</code>	
<b>Config File Format</b>	<code>large-pages</code>	
<b>Option Sets Variable</b>	Yes, <code>large_pages</code>	

<b>Variable Name</b>	<code>large_pages</code>	
<b>Variable Scope</b>	Global	
<b>Dynamic Variable</b>	No	
<b>Platform Specific</b>	linux	
<b>Value Set</b>	<b>Type</b> (linux)	<code>boolean</code>
	<b>Default</b>	<code>FALSE</code>

Some hardware/operating system architectures support memory pages greater than the default (usually 4KB). The actual implementation of this support depends on the underlying hardware and operating system. Applications that perform a lot of memory accesses may obtain performance improvements by using large pages due to reduced Translation Lookaside Buffer (TLB) misses.

Currently, MySQL supports only the Linux implementation of large page support (which is called HugeTLB in Linux). See [Section 7.5.9, “Enabling Large Page Support”](#).

`--large-pages` is disabled by default.

- `--log[=file_name], -l [file_name]`

<b>Version Deprecated</b>	5.1.29	
<b>Command Line Format</b>	<code>--log[=<i>name</i>]</code>	
<b>Config File Format</b>	<code>log</code>	
<b>Option Sets Variable</b>	Yes, <code>log</code>	
<b>Variable Name</b>	<code>log</code>	
<b>Variable Scope</b>	Global	
<b>Dynamic Variable</b>	Yes	
<b>Deprecated</b>	5.1.29, by <code>general-log</code>	
<b>Value Set</b>	<b>Type</b>	<code>string</code>
	<b>Default</b>	<code>OFF</code>

This option enables logging to the general query log, which contains entries that record client connections and SQL statements received from clients. The log output destination can be selected with the `--log-output` option as of MySQL 5.1.6. Before 5.1.6, logging occurs to the general query log file. If you omit the file name, MySQL uses `host_name.log` as the file name. See [Section 5.2.1, “Selecting General Query and Slow Query Log Output Destinations”](#), and [Section 5.2.3, “The General Query Log”](#).

As of MySQL 5.1.29, the `--log` option is deprecated and will be removed (along with the `log` system variable) in MySQL 7.0. Instead, use the `--general_log` option to enable the general query log and the `--general_log_file=file_name` option to set the general query log file name.

- `--log-error[=file_name]`

<b>Command Line Format</b>	<code>--log-error[=<i>name</i>]</code>	
<b>Config File Format</b>	<code>log-error</code>	
<b>Option Sets Variable</b>	Yes, <code>log_error</code>	
<b>Variable Name</b>	<code>log_error</code>	
<b>Variable Scope</b>	Global	
<b>Dynamic Variable</b>	No	
<b>Value Set</b>	<b>Type</b>	<code>filename</code>
	<b>Default</b>	

Log errors and startup messages to this file. See [Section 5.2.2, “The Error Log”](#). If you omit the file name, MySQL uses `host_name.err`. If the file name has no extension, the server adds an extension of `.err`.

- `--log-isam[=file_name]`

<b>Command Line Format</b>	<code>--log-isam[=name]</code>
<b>Config File Format</b>	<code>log-isam</code>
<b>Value Set</b>	<b>Type</b>   <code>filename</code>

Log all MyISAM changes to this file (used only when debugging MyISAM).

- `--log-long-format` (*DEPRECATED*)

<b>Command Line Format</b>	<code>--log-long-format</code>
<b>Config File Format</b>	<code>log-long-format</code>
<b>Deprecated</b>	4.1

Log extra information to the binary log and slow query log, if they have been activated. For example, the user name and timestamp are logged for all queries. This option is deprecated, as it now represents the default logging behavior. (See the description for `--log-short-format`.) The `--log-queries-not-using-indexes` option is available for the purpose of logging queries that do not use indexes to the slow query log.

- `--log-output[=value,...]`

<b>Version Introduced</b>	5.1.6	
<b>Command Line Format</b>	<code>--log-output[=name]</code>	
<b>Config File Format</b>	<code>log-output</code>	
<b>Option Sets Variable</b>	Yes, <code>log_output</code>	
<b>Variable Name</b>	<code>log_output</code>	
<b>Variable Scope</b>	Global	
<b>Dynamic Variable</b>	Yes	
<b>Value Set</b>	<b>Type</b>	<code>enumeration</code>
	<b>Default</b>	<code>FILE</code>
	<b>Valid Values</b>	<code>TABLE, FILE, NONE</code>

This option determines the destination for general query log and slow query log output. The option value can be given as one or more of the words `TABLE`, `FILE`, or `NONE`. If the option is given without a value, the default is `FILE`. (For MySQL 5.1.6 through 5.1.20, the default is `TABLE`.) `TABLE` select logging to the `general_log` and `slow_log` tables in the `mysql` database as a destination. `FILE` selects logging to log files as a destination. `NONE` disables logging. If `NONE` is present in the option value, it takes precedence over any other words that are present. `TABLE` and `FILE` can both be given to select to both log output destinations.

This option selects log output destinations, but does not enable log output. To do that, use the `--general_log` and `--slow_query_log` options. For `FILE` logging, the `--general_log_file` and `--slow_query_log_file` options determine the log file location. (Before MySQL 5.1.29, enable the logs with the `--log` and `--log-slow-queries` options. The options take an optional file name argument to specify the log file name.) For more information, see [Section 5.2.1, “Selecting General Query and Slow Query Log Output Destinations”](#).

The `--log-output` option was added in MySQL 5.1.6.

- `--log-queries-not-using-indexes`

<b>Version Deprecated</b>	5.1.29
<b>Command Line Format</b>	<code>--log-queries-not-using-indexes</code>
<b>Config File Format</b>	<code>log-queries-not-using-indexes</code>
<b>Option Sets Variable</b>	Yes, <code>log_queries_not_using_indexes</code>
<b>Variable Name</b>	<code>log_queries_not_using_indexes</code>
<b>Variable Scope</b>	Global
<b>Dynamic Variable</b>	Yes
<b>Deprecated</b>	5.1.29, by <code>slow-query-log</code>

<b>Value Set</b>	<b>Type</b>	boolean
------------------	-------------	---------

If you are using this option with the slow query log enabled, queries that are expected to retrieve all rows are logged. See [Section 5.2.5, “The Slow Query Log”](#). This option does not necessarily mean that no index is used. For example, a query that uses a full index scan uses an index but would be logged because the index would not limit the number of rows.

- `--log-short-format`

<b>Command Line Format</b>	<code>--log-short-format</code>	
<b>Config File Format</b>	<code>log-short-format</code>	
<b>Value Set</b>	<b>Type</b>	boolean
	<b>Default</b>	FALSE

Originally intended to log less information to the binary log and slow query log, if they have been activated. However, this option is not operational.

- `--log-slow-admin-statements`

<b>Command Line Format</b>	<code>--log-slow-admin-statements</code>	
<b>Config File Format</b>	<code>log-slow-admin-statements</code>	
<b>Value Set</b>	<b>Type</b>	boolean
	<b>Default</b>	FALSE

Log slow administrative statements such as `OPTIMIZE TABLE`, `ANALYZE TABLE`, and `ALTER TABLE` to the slow query log.

- `--log-slow-queries[=file_name]`

<b>Command Line Format</b>	<code>--log-slow-queries[=name]</code>	
<b>Config File Format</b>	<code>log-slow-queries</code>	
<b>Option Sets Variable</b>	Yes, <code>log_slow_queries</code>	
<b>Variable Name</b>	<code>log_slow_queries</code>	
<b>Variable Scope</b>	Global	
<b>Dynamic Variable</b>	Yes	
<b>Value Set</b>	<b>Type</b>	boolean

This option enables logging to the slow query log, which contains entries for all queries that have taken more than `long_query_time` seconds to execute. See the descriptions of the `--log-long-format` and `--log-short-format` options for details.

The log output destination can be selected with the `--log-output` option as of MySQL 5.1.6. Before 5.1.6, logging occurs to the slow query log file. If you omit the file name, MySQL uses `host_name-slow.log` as the file name. See [Section 5.2.1, “Selecting General Query and Slow Query Log Output Destinations”](#), and [Section 5.2.5, “The Slow Query Log”](#).

As of MySQL 5.1.29, the `--log-slow-queries` option is deprecated and will be removed (along with the `log_slow_queries` system variable) in MySQL 7.0. Instead, use the `--slow_query_log` option to enable the slow query log and the `--slow_query_log_file=file_name` option to set the slow query log file name.

- `--log-tc=file_name`

<b>Command Line Format</b>	<code>--log-tc=name</code>	
<b>Config File Format</b>	<code>log-tc</code>	
<b>Value Set</b>	<b>Type</b>	filename
	<b>Default</b>	<code>tc.log</code>



The name of the memory-mapped transaction coordinator log file (for XA transactions that affect multiple storage engines when the binary log is disabled). The default name is `tc.log`. The file is created under the data directory if not given as a full path name. Currently, this option is unused.

- `--log-tc-size=size`

<b>Command Line Format</b>	<code>--log-tc-size=#</code>	
<b>Config File Format</b>	<code>log-tc-size</code>	
<b>Value Set</b>	<b>Platform Bit Size</b>	32
	<b>Type</b>	numeric
	<b>Default</b>	24576
	<b>Max Value</b>	4294967295
<b>Value Set</b>	<b>Platform Bit Size</b>	64
	<b>Type</b>	numeric
	<b>Default</b>	24576
	<b>Max Value</b>	18446744073709547520

The size in bytes of the memory-mapped transaction coordinator log. The default size is 24KB.

- `--log-warnings[=level],-W [level]`

<b>Command Line Format</b>	<code>--log-warnings[=#]</code>	
<b>Config File Format</b>	<code>log-warnings</code>	
<b>Option Sets Variable</b>	Yes, <code>log_warnings</code>	
<b>Variable Name</b>	<code>log_warnings</code>	
<b>Variable Scope</b>	Both	
<b>Dynamic Variable</b>	Yes	
<b>Disabled by</b>	<code>skip-log-warnings</code>	
<b>Value Set</b>	<b>Platform Bit Size</b>	32
	<b>Type</b>	numeric
	<b>Default</b>	1
	<b>Range</b>	0-18446744073709547520

Print out warnings such as `Aborted connection...` to the error log. Enabling this option is recommended, for example, if you use replication (you get more information about what is happening, such as messages about network failures and reconnections). This option is enabled (1) by default, and the default `level` value if omitted is 1. To disable this option, use `--log-warnings=0`. If the value is greater than 1, aborted connections are written to the error log. See [Section B.1.2.11, “Communication Errors and Aborted Connections”](#).

If a slave server was started with `--log-warnings` enabled, the slave prints messages to the error log to provide information about its status, such as the binary log and relay log coordinates where it starts its job, when it is switching to another relay log, when it reconnects after a disconnect, and so forth.

- `--low-priority-updates`

<b>Command Line Format</b>	<code>--low-priority-updates</code>	
<b>Config File Format</b>	<code>low-priority-updates</code>	
<b>Option Sets Variable</b>	Yes, <code>low_priority_updates</code>	
<b>Variable Name</b>	<code>low_priority_updates</code>	
<b>Variable Scope</b>	Both	
<b>Dynamic Variable</b>	Yes	
<b>Value Set</b>	<b>Type</b>	boolean
	<b>Default</b>	FALSE

Give table-modifying operations (`INSERT`, `REPLACE`, `DELETE`, `UPDATE`) lower priority than selects. This can also be done via `{INSERT | REPLACE | DELETE | UPDATE} LOW_PRIORITY ...` to lower the priority of only one query, or by `SET LOW_PRIORITY_UPDATES=1` to change the priority in one thread. This affects only storage engines that use only table-level locking (`MyISAM`, `MEMORY`, `MERGE`). See [Section 7.3.2, “Table Locking Issues”](#).

- `--min-examined-row-limit=number`

<b>Version Introduced</b>	5.1.21	
<b>Command Line Format</b>	<code>--min-examined-row-limit=#</code>	
<b>Config File Format</b>	<code>min-examined-row-limit</code>	
<b>Variable Name</b>	<code>min_examined_row_limit</code>	
<b>Variable Scope</b>	Both	
<b>Dynamic Variable</b>	Yes	
<b>Value Set</b>	<b>Platform Bit Size</b>	32
	<b>Type</b>	numeric
	<b>Default</b>	0
	<b>Range</b>	0-4294967295
<b>Value Set</b>	<b>Platform Bit Size</b>	64
	<b>Type</b>	numeric
	<b>Default</b>	0
	<b>Range</b>	0-18446744073709547520

When this option is set, queries which examine fewer than `number` rows are not written to the slow query log. The default is 0.

This option was introduced in MySQL 5.1.21.

- `--memlock`

<b>Command Line Format</b>	<code>--memlock</code>	
<b>Config File Format</b>	<code>memlock</code>	
<b>Variable Name</b>	<code>locked_in_memory</code>	
<b>Variable Scope</b>	Global	
<b>Dynamic Variable</b>	No	
<b>Value Set</b>	<b>Type</b>	boolean
	<b>Default</b>	FALSE

Lock the `mysqld` process in memory. This option might help if you have a problem where the operating system is causing `mysqld` to swap to disk.

`--memlock` works on systems that support the `mlockall()` system call; this includes Solaris as well as most Linux distributions that use a 2.4 or newer kernel. On Linux systems, you can tell whether or not `mlockall()` (and thus this option) is supported by checking to see whether or not it is defined in the system `mman.h` file, like this:

```
shell> grep mlockall /usr/include/sys/mman.h
```

If `mlockall()` is supported, you should see in the output of the previous command something like the following:

```
extern int mlockall (int __flags) __THROW;
```

### Important

Using this option requires that you run the server as `root`, which, for reasons of security, is normally not a good idea. See [Section 5.3.5, “How to Run MySQL as a Normal User”](#).

You must not try to use this option on a system that does not support the `mlockall()` system call; if you do so, `mysqld` will very likely crash as soon as you try to start it.

- `--myisam-block-size=N`

<b>Command Line Format</b>	<code>--myisam-block-size=#</code>	
<b>Config File Format</b>	<code>myisam-block-size</code>	
<b>Value Set</b>	<b>Type</b>	numeric
	<b>Default</b>	1024
	<b>Range</b>	1024-16384

The block size to be used for MyISAM index pages.

- `--myisam-recover[=option[,option]...]`

<b>Command Line Format</b>	<code>--myisam-recover[=name]</code>	
<b>Config File Format</b>	<code>myisam-recover</code>	
<b>Value Set</b>	<b>Type</b>	enumeration
	<b>Default</b>	OFF
	<b>Valid Values</b>	DEFAULT, BACKUP, FORCE, QUICK

Set the MyISAM storage engine recovery mode. The option value is any combination of the values of `DEFAULT`, `BACKUP`, `FORCE`, or `QUICK`. If you specify multiple values, separate them by commas. Specifying the option with no argument is the same as specifying `DEFAULT`, and specifying with an explicit value of `" "` disables recovery (same as not giving the option). If recovery is enabled, each time `mysqld` opens a MyISAM table, it checks whether the table is marked as crashed or wasn't closed properly. (The last option works only if you are running with external locking disabled.) If this is the case, `mysqld` runs a check on the table. If the table was corrupted, `mysqld` attempts to repair it.

The following options affect how the repair works.

Option	Description
<code>DEFAULT</code>	Recovery without backup, forcing, or quick checking.
<code>BACKUP</code>	If the data file was changed during recovery, save a backup of the <code>tbl_name.MYD</code> file as <code>tbl_name-datetime.BAK</code> .
<code>FORCE</code>	Run recovery even if we would lose more than one row from the <code>.MYD</code> file.
<code>QUICK</code>	Don't check the rows in the table if there aren't any delete blocks.

Before the server automatically repairs a table, it writes a note about the repair to the error log. If you want to be able to recover from most problems without user intervention, you should use the options `BACKUP`, `FORCE`. This forces a repair of a table even if some rows would be deleted, but it keeps the old data file as a backup so that you can later examine what happened.

See [Section 13.4.1, "MyISAM Startup Options"](#).

- `--old-passwords`

<b>Command Line Format</b>	<code>--old_passwords</code>	
<b>Config File Format</b>	<code>old-passwords</code>	
<b>Option Sets Variable</b>	Yes, <code>old_passwords</code>	
<b>Variable Name</b>	<code>old_passwords</code>	
<b>Variable Scope</b>	Both	
<b>Dynamic Variable</b>	Yes	
<b>Value Set</b>	<b>Type</b>	boolean
	<b>Default</b>	FALSE

Force the server to generate short (pre-4.1) password hashes for new passwords. This is useful for compatibility when the server must support older client programs. See [Section 5.5.6.3, "Password Hashing in MySQL"](#).

- `--old-style-user-limits`

<b>Command Line Format</b>	<code>--old-style-user-limits</code>	
<b>Config File Format</b>	<code>old-style-user-limits</code>	
<b>Value Set</b>	<b>Type</b>	<code>boolean</code>
	<b>Default</b>	<code>FALSE</code>

Enable old-style user limits. (Before MySQL 5.0.3, account resource limits were counted separately for each host from which a user connected rather than per account row in the `user` table.) See [Section 5.5.4, “Limiting Account Resources”](#).

- `--one-thread`

<b>Command Line Format</b>	<code>--one-thread</code>
<b>Config File Format</b>	<code>one-thread</code>

Only use one thread (for debugging under Linux). This option is available only if the server is built with debugging enabled. See [MySQL Internals: Porting](#).

As of MySQL 5.1.17, this option is deprecated; use `--thread_handling=one-thread` instead.

- `--open-files-limit=count`

<b>Command Line Format</b>	<code>--open-files-limit=#</code>	
<b>Config File Format</b>	<code>open-files-limit</code>	
<b>Option Sets Variable</b>	Yes, <code>open_files_limit</code>	
<b>Variable Name</b>	<code>open_files_limit</code>	
<b>Variable Scope</b>	Global	
<b>Dynamic Variable</b>	No	
<b>Value Set</b>	<b>Type</b>	<code>numeric</code>
	<b>Default</b>	<code>0</code>
	<b>Range</b>	<code>0-65535</code>

Changes the number of file descriptors available to `mysqld`. You should try increasing the value of this option if `mysqld` gives you the error `Too many open files`. `mysqld` uses the option value to reserve descriptors with `setrlimit()`. If the requested number of file descriptors cannot be allocated, `mysqld` writes a warning to the error log.

`mysqld` may attempt to allocate more than the requested number of descriptors (if they are available), using the values of `max_connections` and `table_open_cache` to estimate whether more descriptors will be needed.

- `--pid-file=path`

<b>Command Line Format</b>	<code>--pid-file=name</code>	
<b>Config File Format</b>	<code>pid-file</code>	
<b>Option Sets Variable</b>	Yes, <code>pid_file</code>	
<b>Variable Name</b>	<code>pid_file</code>	
<b>Variable Scope</b>	Global	
<b>Dynamic Variable</b>	No	
<b>Value Set</b>	<b>Type</b>	<code>filename</code>

The path name of the process ID file. This file is used by other programs such as `mysqld_safe` to determine the server's process ID.

- `--plugin-load=plugin_list`

<b>Version Introduced</b>	5.1.18
<b>Command Line Format</b>	<code>--plugin-load=plugin_list</code>

<b>Config File Format</b>	plugin-load	
<b>Value Set</b>	<b>Type</b>	string

Under normal startup, the server determines which plugins to load by reading the `mysql.plugins` system table. This option enables plugins to be loaded even when `--skip-grant-tables` is given (which tells the server not to read system tables). This option also enables plugins to be loaded at startup under configurations when plugins cannot be loaded at runtime. The option was added in MySQL 5.1.18.

The option value is a colon-separated list of `name=plugin_library` values. Each `name` is the name of the plugin, and `plugin_library` is the name of the shared library that contains the plugin code. Each library file must be located in the directory named by the `plugin_dir` system variable. For example, if plugins named `myplug1` and `myplug2` have library files `myplug1.so` and `myplug2.so`, use this option to load them at startup:

```
shell> mysqld --plugin-load=myplug1=myplug1.so:myplug2=myplug2.so
```

All plugins to load must be named in the same `--plugin-load` option. If multiple `--plugin-load` options are given, only the last one is used.

The plugins are loaded for a single invocation of `mysqld` only. After a restart, the plugins are not loaded unless `--plugin-load` is used again. This is in contrast to `INSTALL PLUGIN`, which adds an entry to the `mysql.plugins` table to cause the plugin to be loaded for every normal server startup.

- `--port=port_num, -P port_num`

<b>Command Line Format</b>	<code>--port=#</code>	
<b>Config File Format</b>	port	
<b>Option Sets Variable</b>	Yes, port	
<b>Variable Name</b>	port	
<b>Variable Scope</b>	Global	
<b>Dynamic Variable</b>	No	
<b>Value Set</b>	<b>Type</b>	numeric
	<b>Default</b>	3306

The port number to use when listening for TCP/IP connections. The port number must be 1024 or higher unless the server is started by the `root` system user.

- `--port-open-timeout=num`

<b>Version Introduced</b>	5.1.5	
<b>Command Line Format</b>	<code>--port-open-timeout=#</code>	
<b>Config File Format</b>	port-open-timeout	
<b>Value Set</b>	<b>Type</b>	numeric
	<b>Default</b>	0

On some systems, when the server is stopped, the TCP/IP port might not become available immediately. If the server is restarted quickly afterward, its attempt to reopen the port can fail. This option indicates how many seconds the server should wait for the TCP/IP port to become free if it cannot be opened. The default is not to wait. This option was added in MySQL 5.1.5.

- `--safe-mode`

<b>Command Line Format</b>	<code>--safe-mode</code>	
<b>Config File Format</b>	safe-mode	
<b>Deprecated</b>	5.0	

Skip some optimization stages.

- `--safe-show-database` (*DEPRECATED*)

<b>Command Line Format</b>	<code>--safe-show-database</code>	
<b>Config File Format</b>	<code>safe-show-database</code>	
<b>Variable Name</b>	<code>safe_show_database</code>	
<b>Variable Scope</b>	Global	
<b>Dynamic Variable</b>	Yes	
<b>Deprecated</b>	4.0.2	
<b>Value Set</b>	<b>Type</b>	boolean

See Section 5.4.1, “Privileges Provided by MySQL”.

- `--safe-user-create`

<b>Command Line Format</b>	<code>--safe-user-create</code>	
<b>Config File Format</b>	<code>safe-user-create</code>	
<b>Value Set</b>	<b>Type</b>	boolean
	<b>Default</b>	FALSE

If this option is enabled, a user cannot create new MySQL users by using the `GRANT` statement unless the user has the `INSERT` privilege for the `mysql.user` table or any column in the table. If you want a user to have the ability to create new users that have those privileges that the user has the right to grant, you should grant the user the following privilege:

```
GRANT INSERT(user) ON mysql.user TO 'user_name'@'host_name';
```

This ensures that the user cannot change any privilege columns directly, but has to use the `GRANT` statement to give privileges to other users.

- `--secure-auth`

<b>Command Line Format</b>	<code>--secure-auth</code>	
<b>Config File Format</b>	<code>secure-auth</code>	
<b>Option Sets Variable</b>	Yes, <code>secure_auth</code>	
<b>Variable Name</b>	<code>secure_auth</code>	
<b>Variable Scope</b>	Global	
<b>Dynamic Variable</b>	Yes	
<b>Value Set</b>	<b>Type</b>	boolean
	<b>Default</b>	FALSE

Disallow authentication by clients that attempt to use accounts that have old (pre-4.1) passwords.

- `--secure-file-priv=path`

<b>Version Introduced</b>	5.1.17	
<b>Command Line Format</b>	<code>--secure-file-priv</code>	
<b>Config File Format</b>	<code>secure-file-priv</code>	
<b>Option Sets Variable</b>	Yes, <code>secure_file_priv</code>	
<b>Variable Name</b>	<code>secure_file_priv</code>	
<b>Variable Scope</b>	Global	
<b>Dynamic Variable</b>	No	
<b>Value Set</b>	<b>Type</b>	string

This option limits the effect of the `LOAD_FILE()` function and the `LOAD DATA` and `SELECT ... INTO OUTFILE` state-

ments to work only with files in the specified directory.

This option was added in MySQL 5.1.17.

- `--shared-memory`

Enable shared-memory connections by local clients. This option is available only on Windows.

- `--shared-memory-base-name=name`

The name of shared memory to use for shared-memory connections. This option is available only on Windows. The default name is `MYSQL`. The name is case sensitive.

- `--skip-concurrent-insert`

Turn off the ability to select and insert at the same time on `MyISAM` tables. (This is to be used only if you think you have found a bug in this feature.) See [Section 7.3.3, “Concurrent Inserts”](#).

- `--skip-external-locking`

Do not use external locking (system locking). For more information about external locking, including conditions under which it can and cannot be used, see [Section 7.3.4, “External Locking”](#).

External locking has been disabled by default since MySQL 4.0.

- `--skip-grant-tables`

This option causes the server to start without using the privilege system at all, which gives anyone with access to the server *unrestricted access to all databases*. You can cause a running server to start using the grant tables again by executing `mysqladmin flush-privileges` or `mysqladmin reload` command from a system shell, or by issuing a MySQL `FLUSH PRIVILEGES` statement after connecting to the server. This option also suppresses loading of plugins, user-defined functions (UDFs), and, beginning with MySQL 5.1.17, scheduled events. To cause plugins to be loaded anyway, use the `-plugin-load` option.

`--skip-grant-tables` is unavailable if MySQL was configured with the `--disable-grant-options` option. See [Section 2.10.2, “Typical configure Options”](#).

- `--skip-host-cache`

Do not use the internal host name cache for faster name-to-IP resolution. Instead, query the DNS server every time a client connects. See [Section 7.5.11, “How MySQL Uses DNS”](#).

- `--skip-innodb`

Disable the `InnoDB` storage engine. This saves memory and disk space and might speed up some operations. Do not use this option if you require `InnoDB` tables.

- `--skip-name-resolve`

Do not resolve host names when checking client connections. Use only IP numbers. If you use this option, all `Host` column values in the grant tables must be IP numbers or `localhost`. See [Section 7.5.11, “How MySQL Uses DNS”](#).

- `--skip-networking`

Don't listen for TCP/IP connections at all. All interaction with `mysqld` must be made via named pipes or shared memory (on Windows) or Unix socket files (on Unix). This option is highly recommended for systems where only local clients are allowed. See [Section 7.5.11, “How MySQL Uses DNS”](#).

- `--ssl*`

Options that begin with `--ssl` specify whether to allow clients to connect via SSL and indicate where to find SSL keys and certificates. See [Section 5.5.7.3, “SSL Command Options”](#).

- `--standalone`

<b>Command Line Format</b>	<code>--standalone</code>
<b>Config File Format</b>	<code>standalone</code>
<b>Platform Specific</b>	windows

Available on Windows NT-based systems only; instructs the MySQL server not to run as a service.

- `--symbolic-links, --skip-symbolic-links`

<b>Command Line Format</b>	<code>--symbolic-links</code>
<b>Config File Format</b>	<code>symbolic-links</code>

Enable or disable symbolic link support. This option has different effects on Windows and Unix:

- On Windows, enabling symbolic links allows you to establish a symbolic link to a database directory by creating a `db_name.sym` file that contains the path to the real directory. See [Section 7.6.1.3, “Using Symbolic Links for Databases on Windows”](#).
- On Unix, enabling symbolic links means that you can link a [MyISAM](#) index file or data file to another directory with the `INDEX DIRECTORY` or `DATA DIRECTORY` options of the `CREATE TABLE` statement. If you delete or rename the table, the files that its symbolic links point to also are deleted or renamed. See [Section 7.6.1.2, “Using Symbolic Links for Tables on Unix”](#).
- `--skip-safemalloc`

<b>Command Line Format</b>	<code>--skip-safe-malloc</code>
<b>Config File Format</b>	<code>skip-safemalloc</code>

If MySQL is configured with `--with-debug=full`, all MySQL programs check for memory overruns during each memory allocation and memory freeing operation. This checking is very slow, so for the server you can avoid it when you don't need it by using the `--skip-safemalloc` option.

- `--skip-show-database`

<b>Command Line Format</b>	<code>--skip-show-database</code>
<b>Config File Format</b>	<code>skip-show-database</code>
<b>Option Sets Variable</b>	Yes, <code>skip_show_database</code>
<b>Variable Name</b>	<code>skip_show_database</code>
<b>Variable Scope</b>	Global
<b>Dynamic Variable</b>	No

With this option, the `SHOW DATABASES` statement is allowed only to users who have the `SHOW DATABASES` privilege, and the statement displays all database names. Without this option, `SHOW DATABASES` is allowed to all users, but displays each database name only if the user has the `SHOW DATABASES` privilege or some privilege for the database. Note that *any* global privilege is considered a privilege for the database.

- `--skip-stack-trace`

<b>Command Line Format</b>	<code>--skip-stack-trace</code>
<b>Config File Format</b>	<code>skip-stack-trace</code>

Don't write stack traces. This option is useful when you are running `mysqld` under a debugger. On some systems, you also must use this option to get a core file. See [MySQL Internals: Porting](#).

- `--skip-thread-priority`

<b>Version Deprecated</b>	5.1.29
<b>Command Line Format</b>	<code>--skip-thread-priority</code>
<b>Config File Format</b>	<code>skip-thread-priority</code>
<b>Deprecated</b>	5.1.29

Disable using thread priorities for faster response time. This option is deprecated as of MySQL 5.1.29 and is removed in MySQL 6.0.



- `--slow-query-log[={0|1}]`

<b>Version Introduced</b>	5.1.12	
<b>Command Line Format</b>	<code>--slow-query-log</code>	5.1.29
<b>Config File Format</b>	<code>slow-query-log</code>	5.1.29
<b>Option Sets Variable</b>	Yes, <code>slow_query_log</code>	
<b>Variable Name</b>	<code>slow_query_log</code>	
<b>Variable Scope</b>	Global	
<b>Dynamic Variable</b>	Yes	
<b>Value Set</b>	<b>Type</b>	<code>boolean</code>
	<b>Default</b>	<code>OFF</code>

Specify the initial slow query log state. With no argument or an argument of 1, the `--slow-query-log` option enables the log. If omitted or given with an argument of 0, the option disables the log. This option was added in MySQL 5.1.12.

- `--socket=path`

<b>Command Line Format</b>	<code>--socket=name</code>	
<b>Config File Format</b>	<code>socket</code>	
<b>Option Sets Variable</b>	Yes, <code>socket</code>	
<b>Variable Name</b>	<code>socket</code>	
<b>Variable Scope</b>	Global	
<b>Dynamic Variable</b>	No	
<b>Value Set</b>	<b>Type</b>	<code>filename</code>
	<b>Default</b>	<code>/tmp/mysql.sock</code>

On Unix, this option specifies the Unix socket file to use when listening for local connections. The default value is `/tmp/mysql.sock`. On Windows, the option specifies the pipe name to use when listening for local connections that use a named pipe. The default value is `MySQL` (not case sensitive).

- `--sql-mode=value[,value[,value...]]`

<b>Command Line Format</b>	<code>--sql-mode=name</code>	
<b>Config File Format</b>	<code>sql-mode</code>	
<b>Option Sets Variable</b>	Yes, <code>sql_mode</code>	
<b>Variable Name</b>	<code>sql_mode</code>	
<b>Variable Scope</b>	Both	
<b>Dynamic Variable</b>	Yes	
<b>Value Set</b>	<b>Type</b>	<code>set</code>
	<b>Default</b>	<code>''</code>
	<b>Valid Values</b>	<code>ALLOW_INVALID_DATES, ANSI_QUOTES, ERROR_FOR_DIVISION_BY_ZERO, HIGH_NOT_PRECEDENCE, IGNORE_SPACE, NO_AUTO_CREATE_USER, NO_AUTO_VALUE_ON_ZERO, NO_BACKSLASH_ESCAPES, NO_DIR_IN_CREATE, NO_ENGINE_SUBSTITUTION, NO_FIELD_OPTIONS, NO_KEY_OPTIONS, NO_TABLE_OPTIONS, NO_UNSIGNED_SUBTRACTION, NO_ZERO_DATE, NO_ZERO_IN_DATE,</code>

		ONLY_FULL_GROUP_BY, PAD_CHAR_TO_FULL_LENGTH, PIPES_AS_CONCAT, REAL_AS_FLOAT, STRICT_ALL_TABLES, STRICT_TRANS_TABLES
--	--	---

Set the SQL mode. See [Section 5.1.7, “Server SQL Modes”](#).

- `--sysdate-is-now`

<b>Version Introduced</b>	5.1.8	
<b>Command Line Format</b>	<code>--sysdate-is-now</code>	
<b>Config File Format</b>	<code>sysdate-is-now</code>	
<b>Value Set</b>	<b>Type</b>	boolean
	<b>Default</b>	FALSE

`SYSDATE()` by default returns the time at which it executes, not the time at which the statement in which it occurs begins executing. This differs from the behavior of `NOW()`. This option causes `SYSDATE()` to be an alias for `NOW()`. For information about the implications for binary logging and replication, see the description for `SYSDATE()` in [Section 11.6, “Date and Time Functions”](#) and for `SET TIMESTAMP` in [Section 5.1.4, “Session System Variables”](#).

This option was added in MySQL 5.1.8.

- `--tc-heuristic-recover={COMMIT|ROLLBACK}`

<b>Command Line Format</b>	<code>--tc-heuristic-recover=name</code>	
<b>Config File Format</b>	<code>tc-heuristic-recover</code>	
<b>Value Set</b>	<b>Type</b>	enumeration
	<b>Valid Values</b>	COMMIT, RECOVER

The type of decision to use in the heuristic recovery process. Currently, this option is unused.

- `--temp-pool`

<b>Command Line Format</b>	<code>--temp-pool</code>	
<b>Config File Format</b>	<code>temp-pool</code>	
<b>Value Set</b>	<b>Type</b>	boolean
	<b>Default</b>	TRUE

This option causes most temporary files created by the server to use a small set of names, rather than a unique name for each new file. This works around a problem in the Linux kernel dealing with creating many new files with different names. With the old behavior, Linux seems to “leak” memory, because it is being allocated to the directory entry cache rather than to the disk cache. As of MySQL 5.1.31, this option is ignored except on Linux.

- `--transaction-isolation=level`

<b>Command Line Format</b>	<code>--transaction-isolation=name</code>	
<b>Config File Format</b>	<code>transaction-isolation</code>	
<b>Value Set</b>	<b>Type</b>	enumeration
	<b>Valid Values</b>	READ-UNCOMMITTED, READ-COMMITTED, REPEATABLE-READ, SERIALIZABLE

Sets the default transaction isolation level. The `level` value can be `READ-UNCOMMITTED`, `READ-COMMITTED`, `REPEATABLE-READ`, or `SERIALIZABLE`. See [Section 12.4.6, “SET TRANSACTION Syntax”](#).

- `--tmpdir=path, -t path`

<b>Command Line Format</b>	<code>--tmpdir=name</code>	
<b>Config File Format</b>	<code>tmpdir</code>	
<b>Option Sets Variable</b>	Yes, <code>tmpdir</code>	
<b>Variable Name</b>	<code>tmpdir</code>	
<b>Variable Scope</b>	Global	
<b>Dynamic Variable</b>	No	
<b>Value Set</b>	<b>Type</b>	<code>filename</code>

The path of the directory to use for creating temporary files. It might be useful if your default `/tmp` directory resides on a partition that is too small to hold temporary tables. This option accepts several paths that are used in round-robin fashion. Paths should be separated by colon characters (“:”) on Unix and semicolon characters (“;”) on Windows, NetWare, and OS/2. If the MySQL server is acting as a replication slave, you should not set `--tmpdir` to point to a directory on a memory-based file system or to a directory that is cleared when the server host restarts. For more information about the storage location of temporary files, see [Section B.1.4.4, “Where MySQL Stores Temporary Files”](#). A replication slave needs some of its temporary files to survive a machine restart so that it can replicate temporary tables or `LOAD DATA INFILE` operations. If files in the temporary file directory are lost when the server restarts, replication fails.

- `--user={user_name|user_id}, -u {user_name|user_id}`

<b>Command Line Format</b>	<code>--user=name</code>	
<b>Config File Format</b>	<code>user</code>	
<b>Value Set</b>	<b>Type</b>	<code>string</code>

Run the `mysqld` server as the user having the name `user_name` or the numeric user ID `user_id`. (“User” in this context refers to a system login account, not a MySQL user listed in the grant tables.)

This option is *mandatory* when starting `mysqld` as `root`. The server changes its user ID during its startup sequence, causing it to run as that particular user rather than as `root`. See [Section 5.3.1, “General Security Guidelines”](#).

To avoid a possible security hole where a user adds a `--user=root` option to a `my.cnf` file (thus causing the server to run as `root`), `mysqld` uses only the first `--user` option specified and produces a warning if there are multiple `--user` options. Options in `/etc/my.cnf` and `$MYSQL_HOME/my.cnf` are processed before command-line options, so it is recommended that you put a `--user` option in `/etc/my.cnf` and specify a value other than `root`. The option in `/etc/my.cnf` is found before any other `--user` options, which ensures that the server runs as a user other than `root`, and that a warning results if any other `--user` option is found.

- `--verbose, -v`

Use this option with the `--help` option for detailed help.

- `--version, -V`

Display version information and exit.

You can assign a value to a server system variable by using an option of the form `--var_name=value`. For example, `--key_buffer_size=32M` sets the `key_buffer_size` variable to a value of 32MB.

Note that when you assign a value to a variable, MySQL might automatically correct the value to stay within a given range, or adjust the value to the closest allowable value if only certain values are allowed.

If you want to restrict the maximum value to which a variable can be set at runtime with `SET`, you can define this by using the `--maximum-var_name=value` command-line option.

You can change the values of most system variables for a running server with the `SET` statement. See [Section 12.5.4, “SET Syntax”](#).

[Section 5.1.3, “Server System Variables”](#), provides a full description for all variables, and additional information for setting them at server startup and runtime. [Section 7.5.3, “Tuning Server Parameters”](#), includes information on optimizing the server by tuning system variables.

## 5.1.3. Server System Variables

The MySQL server maintains many system variables that indicate how it is configured. Each system variable has a default value. System variables can be set at server startup using options on the command line or in an option file. Most of them can be changed dynamically while the server is running by means of the `SET` statement, which enables you to modify operation of the server without having to stop and restart it. You can refer to system variable values in expressions.

There are several ways to see the names and values of system variables:

- To see the values that a server will use based on its compiled-in defaults and any option files that it reads, use this command:

```
mysql --verbose --help
```

- To see the values that a server will use based on its compiled-in defaults, ignoring the settings in any option files, use this command:

```
mysql --no-defaults --verbose --help
```

- To see the current values used by a running server, use the `SHOW VARIABLES` statement.

This section provides a description of each system variable. Variables with no version indicated are present in all MySQL 5.1 releases. For historical information concerning their implementation, please see <http://www.mysql.com/products/enterprise//5.0/en/>, and <http://www.mysql.com/products/enterprise//4.1/en/>.

The following table lists all available system variables:

**Table 5.2. `mysql` System Variable Summary**

Name	Cmd-Line	Option file	System Var	Var Scope	Dynamic
<a href="#">auto_increment_increment</a>	Yes	Yes	Yes	Both	Yes
<a href="#">auto_increment_offset</a>	Yes	Yes	Yes	Both	Yes
<a href="#">autocommit</a>			Yes	Session	Yes
<a href="#">automatic_sp_privileges</a>			Yes	Global	Yes
<a href="#">back_log</a>	Yes	Yes	Yes	Global	No
<a href="#">basedir</a>	Yes	Yes	Yes	Global	No
<a href="#">big-tables</a>	Yes	Yes			Yes
- Variable: <code>big_tables</code>			Yes	Session	Yes
<a href="#">binlog_cache_size</a>	Yes	Yes	Yes	Global	Yes
<a href="#">binlog-format</a>	Yes	Yes			Yes
- Variable: <code>binlog_format</code>			Yes	Both	Yes
<a href="#">bulk_insert_buffer_size</a>	Yes	Yes	Yes	Both	Yes
<a href="#">character_set_client</a>			Yes	Both	Yes
<a href="#">character_set_connection</a>			Yes	Both	Yes
<a href="#">character_set_database<sup>a</sup></a>			Yes	Both	Yes
<a href="#">character-set-filesystem</a>	Yes	Yes			Yes
- Variable: <code>character_set_filesystem</code>			Yes	Both	Yes
<a href="#">character_set_results</a>			Yes	Both	Yes
<a href="#">character-set-server</a>	Yes	Yes			Yes
- Variable: <code>character_set_server</code>			Yes	Both	Yes
<a href="#">character_set_system</a>			Yes	Global	No
<a href="#">character-sets-dir</a>	Yes	Yes			No
- Variable: <code>character_sets_dir</code>			Yes	Global	No
<a href="#">collation_connection</a>			Yes	Both	Yes
<a href="#">collation_database<sup>b</sup></a>			Yes	Both	Yes
<a href="#">collation-server</a>	Yes	Yes			Yes
- Variable: <code>collation_server</code>			Yes	Both	Yes

Name	Cmd-Line	Option file	System Var	Var Scope	Dynamic
completion_type	Yes	Yes	Yes	Both	Yes
concurrent_insert	Yes	Yes	Yes	Global	Yes
connect_timeout	Yes	Yes	Yes	Global	Yes
datadir	Yes	Yes	Yes	Global	No
date_format			Yes	Both	Yes
datetime_format	Yes	Yes	Yes	Both	Yes
debug	Yes	Yes	Yes	Both	Yes
default_week_format	Yes	Yes	Yes	Both	Yes
delay-key-write	Yes	Yes			Yes
- Variable: delay_key_write			Yes	Global	Yes
delayed_insert_limit	Yes	Yes	Yes	Global	Yes
delayed_insert_timeout	Yes	Yes	Yes	Global	Yes
delayed_queue_size	Yes	Yes	Yes	Global	Yes
div_precision_increment	Yes	Yes	Yes	Both	Yes
engine-condition-pushdown	Yes	Yes			Yes
- Variable: engine_condition_pushdown			Yes	Both	Yes
error_count			Yes	Session	No
event-scheduler	Yes	Yes			Yes
- Variable: event_scheduler			Yes	Global	Yes
expire_logs_days	Yes	Yes	Yes	Global	Yes
flush	Yes	Yes	Yes	Global	Yes
flush_time	Yes	Yes	Yes	Global	Yes
foreign_key_checks			Yes	Session	Yes
ft_boolean_syntax	Yes	Yes	Yes	Global	Yes
ft_max_word_len	Yes	Yes	Yes	Global	No
ft_min_word_len	Yes	Yes	Yes	Global	No
ft_query_expansion_limit	Yes	Yes	Yes	Global	No
ft_stopword_file	Yes	Yes	Yes	Global	No
general-log	Yes	Yes			Yes
- Variable: general_log			Yes	Global	Yes
general_log_file	Yes	Yes	Yes	Global	Yes
group_concat_max_len	Yes	Yes	Yes	Both	Yes
have_archive			Yes	Global	No
have_blackhole_engine			Yes	Global	No
have_compress			Yes	Global	No
have_crypt			Yes	Global	No
have_csv			Yes	Global	No
have_dynamic_loading			Yes	Global	No
have_example_engine			Yes	Global	No
have_federated_engine			Yes	Global	No
have_geometry			Yes	Global	No
have_innodb			Yes	Global	No
have_isam			Yes	Global	No
have_merge_engine			Yes	Global	No
have_ndbcluster			Yes	Global	No
have_openssl			Yes	Global	No
have_partitioning			Yes	Global	No
have_query_cache			Yes	Global	No

Name	Cmd-Line	Option file	System Var	Var Scope	Dynamic
have_raid			Yes	Global	No
have_row_based_replication			Yes	Global	No
have_rtree_keys			Yes	Global	No
have_ssl			Yes	Global	No
have_symlink			Yes	Global	No
hostname			Yes	Global	No
identity			Yes	Session	Yes
ignore_builtin_innodb	Yes	Yes	Yes	Global	No
init_connect	Yes	Yes	Yes	Global	Yes
init-file	Yes	Yes			No
- Variable: init_file			Yes	Global	No
init_slave	Yes	Yes	Yes	Global	Yes
innodb_adaptive_hash_index	Yes	Yes	Yes	Global	No
innodb_additional_mem_pool_size	Yes	Yes	Yes	Global	No
innodb_autoextend_increment	Yes	Yes	Yes	Global	Yes
innodb_autoinc_lock_mode	Yes	Yes	Yes	Global	No
innodb_buffer_pool_awesome_mem_mb	Yes	Yes	Yes	Global	No
innodb_buffer_pool_size	Yes	Yes	Yes	Global	No
innodb_checksums	Yes	Yes	Yes	Global	No
innodb_commit_concurrency	Yes	Yes	Yes	Global	Yes
innodb_concurrency_tickets	Yes	Yes	Yes	Global	Yes
innodb_data_file_path	Yes	Yes	Yes	Global	No
innodb_data_home_dir	Yes	Yes	Yes	Global	No
innodb_doublewrite	Yes	Yes	Yes	Global	No
innodb_fast_shutdown	Yes	Yes	Yes	Global	Yes
innodb_file_io_threads	Yes	Yes	Yes	Global	No
innodb_file_per_table	Yes	Yes	Yes	Global	No
innodb_flush_log_at_trx_commit	Yes	Yes	Yes	Global	Yes
innodb_flush_method	Yes	Yes	Yes	Global	No
innodb_force_recovery	Yes	Yes	Yes	Global	No
innodb_lock_wait_timeout	Yes	Yes	Yes	Global	No
innodb_locks_unsafe_for_binlog	Yes	Yes	Yes	Global	No
innodb_log_arch_dir	Yes	Yes	Yes	Global	No
innodb_log_archive	Yes	Yes	Yes	Global	No
innodb_log_buffer_size	Yes	Yes	Yes	Global	No
innodb_log_file_size	Yes	Yes	Yes	Global	No
innodb_log_files_in_group	Yes	Yes	Yes	Global	No
innodb_log_group_home_dir	Yes	Yes	Yes	Global	No
innodb_max_dirty_pages_pct	Yes	Yes	Yes	Global	Yes
innodb_max_purge_lag	Yes	Yes	Yes	Global	Yes
innodb_mirrored_log_groups	Yes	Yes	Yes	Global	No
innodb_open_files	Yes	Yes	Yes	Global	No
innodb_rollback_on_timeout	Yes	Yes	Yes	Global	No
innodb_stats_on_metadata	Yes	Yes	Yes	Global	Yes
innodb_support_xa	Yes	Yes	Yes	Both	Yes
innodb_sync_spin_loops	Yes	Yes	Yes	Global	Yes
innodb_table_locks	Yes	Yes	Yes	Both	Yes
innodb_thread_concurrency	Yes	Yes	Yes	Global	Yes

Name	Cmd-Line	Option file	System Var	Var Scope	Dynamic
innodb_thread_sleep_delay	Yes	Yes	Yes	Global	Yes
innodb_use_legacy_cardinality_algorithm	Yes	Yes	Yes	Global	Yes
insert_id			Yes	Session	Yes
interactive_timeout	Yes	Yes	Yes	Both	Yes
join_buffer_size	Yes	Yes	Yes	Both	Yes
keep_files_on_create	Yes	Yes	Yes	Both	Yes
key_buffer_size	Yes	Yes	Yes	Global	Yes
key_cache_age_threshold	Yes	Yes	Yes	Global	Yes
key_cache_block_size	Yes	Yes	Yes	Global	Yes
key_cache_division_limit	Yes	Yes	Yes	Global	Yes
language	Yes	Yes	Yes	Global	No
large_page_size			Yes	Global	No
large-pages	Yes	Yes			No
- Variable: large_pages			Yes	Global	No
last_insert_id			Yes	Session	Yes
lc_time_names			Yes	Both	Yes
license			Yes	Global	No
local_infile			Yes	Global	Yes
locked_in_memory			Yes	Global	No
log	Yes	Yes	Yes	Global	Yes
log_bin			Yes	Global	No
log-bin	Yes	Yes	Yes	Global	No
log-bin-trust-function-creators	Yes	Yes			Yes
- Variable: log_bin_trust_function_creators			Yes	Global	Yes
log-bin-trust-routine-creators	Yes	Yes			Yes
- Variable: log_bin_trust_routine_creators			Yes	Global	Yes
log-error	Yes	Yes			No
- Variable: log_error			Yes	Global	No
log-output	Yes	Yes			Yes
- Variable: log_output			Yes	Global	Yes
log-queries-not-using-indexes	Yes	Yes			Yes
- Variable: log_queries_not_using_indexes			Yes	Global	Yes
log-slave-updates	Yes	Yes			No
- Variable: log_slave_updates			Yes	Global	No
log-slow-queries	Yes	Yes			Yes
- Variable: log_slow_queries			Yes	Global	Yes
log-warnings	Yes	Yes			Yes
- Variable: log_warnings			Yes	Both	Yes
long_query_time	Yes	Yes	Yes	Both	Yes
low-priority-updates	Yes	Yes			Yes
- Variable: low_priority_updates			Yes	Both	Yes
lower_case_file_system	Yes	Yes	Yes	Global	No
lower_case_table_names	Yes	Yes	Yes	Global	No
master-bind	Yes	Yes	Yes		No
max_allowed_packet	Yes	Yes	Yes	Both	Yes
max_binlog_cache_size	Yes	Yes	Yes	Global	Yes
max_binlog_size	Yes	Yes	Yes	Global	Yes
max_connect_errors	Yes	Yes	Yes	Global	Yes

Name	Cmd-Line	Option file	System Var	Var Scope	Dynamic
max_connections	Yes	Yes	Yes	Global	Yes
max_delayed_threads	Yes	Yes	Yes	Both	Yes
max_error_count	Yes	Yes	Yes	Both	Yes
max_heap_table_size	Yes	Yes	Yes	Both	Yes
max_insert_delayed_threads			Yes	Both	Yes
max_join_size	Yes	Yes	Yes	Both	Yes
max_length_for_sort_data	Yes	Yes	Yes	Both	Yes
max_prepared_stmt_count	Yes	Yes	Yes	Global	Yes
max_relay_log_size	Yes	Yes	Yes	Global	Yes
max_seeks_for_key	Yes	Yes	Yes	Both	Yes
max_sort_length	Yes	Yes	Yes	Both	Yes
max_sp_recursion_depth	Yes	Yes	Yes	Both	Yes
max_tmp_tables	Yes	Yes	Yes	Both	Yes
max_user_connections	Yes	Yes	Yes	Both	Yes
max_write_lock_count	Yes	Yes	Yes	Global	Yes
memlock	Yes	Yes	Yes	Global	No
min-examined-row-limit	Yes	Yes	Yes	Both	Yes
multi_range_count	Yes	Yes	Yes	Both	Yes
myisam_data_pointer_size	Yes	Yes	Yes	Global	Yes
myisam_max_sort_file_size	Yes	Yes	Yes	Global	Yes
myisam_recover_options			Yes	Global	No
myisam_repair_threads	Yes	Yes	Yes	Both	Yes
myisam_sort_buffer_size	Yes	Yes	Yes	Both	Yes
myisam_stats_method	Yes	Yes	Yes	Both	Yes
myisam_use_mmap	Yes	Yes	Yes	Global	Yes
named_pipe			Yes	Global	No
ndb_autoincrement_prefetch_sz	Yes	Yes	Yes	Both	Yes
ndb-batch-size	Yes	Yes	Yes	Global	No
ndb_cache_check_time	Yes	Yes	Yes	Global	Yes
ndb_extra_logging	Yes	Yes	Yes	Global	Yes
ndb_force_send	Yes	Yes	Yes	Both	Yes
ndb_log_empty_epochs	Yes	Yes	Yes	Global	Yes
ndb_log_orig			Yes	Global	No
ndb-log-update-as-write	Yes	Yes	Yes	Global	Yes
ndb_log_updated_only	Yes	Yes	Yes	Global	Yes
ndb_optimization_delay			Yes	Global	Yes
ndb_table_no_logging			Yes	Session	Yes
ndb_table_temporary			Yes	Session	Yes
ndb_use_copying_alter_table			Yes	Both	No
ndb_use_exact_count			Yes	Both	Yes
ndb_wait_connected	Yes	Yes	Yes		No
net_buffer_length	Yes	Yes	Yes	Both	Yes
net_read_timeout	Yes	Yes	Yes	Both	Yes
net_retry_count	Yes	Yes	Yes	Both	Yes
net_write_timeout	Yes	Yes	Yes	Both	Yes
new	Yes	Yes	Yes	Both	Yes
old	Yes	Yes	Yes	Global	No
old-passwords	Yes	Yes			Yes



Name	Cmd-Line	Option file	System Var	Var Scope	Dynamic
- Variable: old_passwords			Yes	Both	Yes
open-files-limit	Yes	Yes			No
- Variable: open_files_limit			Yes	Global	No
optimizer_prune_level	Yes	Yes	Yes	Both	Yes
optimizer_search_depth	Yes	Yes	Yes	Both	Yes
optimizer_switch	Yes	Yes	Yes	Both	Yes
pid-file	Yes	Yes			No
- Variable: pid_file			Yes	Global	No
plugin_dir	Yes	Yes	Yes	Global	No
port	Yes	Yes	Yes	Global	No
preload_buffer_size	Yes	Yes	Yes	Both	Yes
prepared_stmt_count			Yes	Global	No
profiling			Yes	Session	Yes
profiling_history_size			Yes	Both	Yes
protocol_version			Yes	Global	No
query_alloc_block_size	Yes	Yes	Yes	Both	Yes
query_cache_limit	Yes	Yes	Yes	Global	Yes
query_cache_min_res_unit	Yes	Yes	Yes	Global	Yes
query_cache_size	Yes	Yes	Yes	Global	Yes
query_cache_type	Yes	Yes	Yes	Both	Yes
query_cache_wlock_invalidate	Yes	Yes	Yes	Both	Yes
query_prealloc_size	Yes	Yes	Yes	Both	Yes
rand_seed1			Yes	Session	Yes
rand_seed2			Yes	Session	Yes
range_alloc_block_size	Yes	Yes	Yes	Both	Yes
read_buffer_size	Yes	Yes	Yes	Both	Yes
read_only	Yes	Yes	Yes	Global	Yes
read_rnd_buffer_size	Yes	Yes	Yes	Both	Yes
relay_log_purge	Yes	Yes	Yes	Global	Yes
relay_log_space_limit	Yes	Yes	Yes	Global	No
report-host	Yes	Yes			No
- Variable: report_host			Yes	Global	No
report-password	Yes	Yes			No
- Variable: report_password			Yes	Global	No
report-port	Yes	Yes			No
- Variable: report_port			Yes	Global	No
report-user	Yes	Yes			No
- Variable: report_user			Yes	Global	No
rpl_recovery_rank			Yes	Global	Yes
safe-show-database	Yes	Yes	Yes	Global	Yes
secure-auth	Yes	Yes			Yes
- Variable: secure_auth			Yes	Global	Yes
secure-file-priv	Yes	Yes			No
- Variable: secure_file_priv			Yes	Global	No
server-id	Yes	Yes			Yes
- Variable: server_id			Yes	Global	Yes
shared_memory			Yes	Global	No
shared_memory_base_name			Yes	Global	No

Name	Cmd-Line	Option file	System Var	Var Scope	Dynamic
skip-external-locking	Yes	Yes			No
- Variable: skip_external_locking			Yes	Global	No
skip-networking	Yes	Yes			No
- Variable: skip_networking			Yes	Global	No
skip-show-database	Yes	Yes			No
- Variable: skip_show_database			Yes	Global	No
slave-allow-batching	Yes	Yes			Yes
- Variable: slave_allow_batching			Yes	Global	Yes
slave_compressed_protocol	Yes	Yes	Yes	Global	Yes
slave_exec_mode			Yes	Global	Yes
slave-load-tmpdir	Yes	Yes			No
- Variable: slave_load_tmpdir			Yes	Global	No
slave-net-timeout	Yes	Yes			Yes
- Variable: slave_net_timeout			Yes	Global	Yes
slave-skip-errors	Yes	Yes			No
- Variable: slave_skip_errors			Yes	Global	No
slave_transaction_retries	Yes	Yes	Yes	Global	Yes
slow_launch_time	Yes	Yes	Yes	Global	Yes
slow-query-log	Yes	Yes			Yes
- Variable: slow_query_log			Yes	Global	Yes
slow_query_log_file	Yes	Yes	Yes	Global	Yes
socket	Yes	Yes	Yes	Global	No
sort_buffer_size	Yes	Yes	Yes	Both	Yes
sql_auto_is_null			Yes	Session	Yes
sql_big_selects			Yes	Session	Yes
sql_big_tables			Yes	Session	Yes
sql_buffer_result			Yes	Session	Yes
sql_log_bin			Yes	Session	Yes
sql_log_off			Yes	Session	Yes
sql_log_update			Yes	Session	Yes
sql_low_priority_updates			Yes	Both	Yes
sql_max_join_size			Yes	Both	Yes
sql-mode	Yes	Yes			Yes
- Variable: sql_mode			Yes	Both	Yes
sql_notes			Yes	Session	Yes
sql_quote_show_create			Yes	Session	Yes
sql_safe_updates			Yes	Session	Yes
sql_select_limit			Yes	Both	Yes
sql_slave_skip_counter			Yes	Global	Yes
sql_warnings			Yes	Session	Yes
ssl-ca	Yes	Yes			No
- Variable: ssl_ca			Yes	Global	No
ssl-capath	Yes	Yes			No
- Variable: ssl_capath			Yes	Global	No
ssl-cert	Yes	Yes			No
- Variable: ssl_cert			Yes	Global	No
ssl-cipher	Yes	Yes			No
- Variable: ssl_cipher			Yes	Global	No

Name	Cmd-Line	Option file	System Var	Var Scope	Dynamic
ssl-key	Yes	Yes			No
- Variable: ssl_key			Yes	Global	No
storage_engine			Yes	Both	Yes
sync-binlog	Yes	Yes			Yes
- Variable: sync_binlog			Yes	Global	Yes
sync_frm	Yes	Yes			Yes
- Variable: sync_frm			Yes	Global	Yes
system_time_zone			Yes	Global	No
table_cache	Yes	Yes	Yes	Global	Yes
table_definition_cache	Yes	Yes	Yes	Global	Yes
table_lock_wait_timeout	Yes	Yes	Yes	Global	Yes
table_open_cache	Yes	Yes	Yes	Global	Yes
table_type			Yes	Both	Yes
thread_cache_size	Yes	Yes	Yes	Global	Yes
thread_concurrency	Yes	Yes	Yes	Global	No
thread_handling	Yes	Yes	Yes	Global	No
thread_stack	Yes	Yes	Yes	Global	No
time_format	Yes	Yes	Yes	Both	Yes
time_zone	Yes	Yes	Yes	Both	Yes
timed_mutexes	Yes	Yes	Yes	Global	Yes
timestamp			Yes	Session	Yes
tmp_table_size	Yes	Yes	Yes	Both	Yes
tmpdir	Yes	Yes	Yes	Global	No
transaction_alloc_block_size	Yes	Yes	Yes	Both	Yes
transaction_allow_batching			Yes	Session	Yes
transaction_prealloc_size	Yes	Yes	Yes	Both	Yes
tx_isolation			Yes	Both	Yes
unique_checks			Yes	Session	Yes
updatable_views_with_limit	Yes	Yes	Yes	Both	Yes
version	Yes	Yes	Yes	Global	No
version_comment			Yes	Global	No
version_compile_machine			Yes	Global	No
version_compile_os			Yes	Global	No
wait_timeout	Yes	Yes	Yes	Both	Yes
warning_count			Yes	Session	No

<sup>a</sup>This option is dynamic, but only the server should set this information. You should not set the value of this variable manually.

<sup>b</sup>This option is dynamic, but only the server should set this information. You should not set the value of this variable manually.

For additional system variable information, see these sections:

- [Section 5.1.4, “Session System Variables”](#), describes system variables that exist only as session variables (that is, they do not have any global counterpart).
- [Section 5.1.5, “Using System Variables”](#), discusses the syntax for setting and displaying system variable values.
- [Section 5.1.5.2, “Dynamic System Variables”](#), lists the variables that can be set at runtime.
- Information on tuning system variables can be found in [Section 7.5.3, “Tuning Server Parameters”](#).
- [Section 13.6.3, “InnoDB Startup Options and System Variables”](#), lists `InnoDB` system variables.
- [MySQL Cluster System Variables](#), lists system variables which are specific to MySQL Cluster.

- For information on server system variables specific to replication, see [Section 16.1.3, “Replication and Binary Logging Options and Variables”](#).

### Note

Some of the following variable descriptions refer to “enabling” or “disabling” a variable. These variables can be enabled with the `SET` statement by setting them to `ON` or `1`, or disabled by setting them to `OFF` or `0`. However, to set such a variable on the command line or in an option file, you must set it to `1` or `0`; setting it to `ON` or `OFF` will not work. For example, on the command line, `--delay_key_write=1` works but `--delay_key_write=ON` does not.

Values for buffer sizes, lengths, and stack sizes are given in bytes unless otherwise specified.

Some system variables control the size of buffers or caches. For a given buffer, the server might need to allocate internal data structures. These structures typically are allocated from the total memory allocated to the buffer, and the amount of space required might be platform dependent. This means that when you assign a value to a system variable that controls a buffer size, the amount of space actually available might differ from the value assigned. In some cases, the amount might be less than the value assigned. It is also possible that the server will adjust a value upward. For example, if you assign a value of 0 to a variable for which the minimal value is 1024, the server will set the value to 1024.

- `automatic_sp_privileges`

<b>Variable Name</b>	<code>automatic_sp_privileges</code>	
<b>Variable Scope</b>	Global	
<b>Dynamic Variable</b>	Yes	
<b>Value Set</b>	<b>Type</b>	<code>boolean</code>
	<b>Default</b>	<code>TRUE</code>

When this variable has a value of 1 (the default), the server automatically grants the `EXECUTE` and `ALTER ROUTINE` privileges to the creator of a stored routine, if the user cannot already execute and alter or drop the routine. (The `ALTER ROUTINE` privilege is required to drop the routine.) The server also automatically drops those privileges when the creator drops the routine. If `automatic_sp_privileges` is 0, the server does not automatically add or drop these privileges.

- `back_log`

<b>Command Line Format</b>	<code>--back_log=#</code>	
<b>Config File Format</b>	<code>back_log</code>	
<b>Option Sets Variable</b>	Yes, <code>back_log</code>	
<b>Variable Name</b>	<code>back_log</code>	
<b>Variable Scope</b>	Global	
<b>Dynamic Variable</b>	No	
<b>Value Set</b>	<b>Type</b>	<code>numeric</code>
	<b>Default</b>	<code>50</code>
	<b>Range</b>	<code>1-65535</code>

The number of outstanding connection requests MySQL can have. This comes into play when the main MySQL thread gets very many connection requests in a very short time. It then takes some time (although very little) for the main thread to check the connection and start a new thread. The `back_log` value indicates how many requests can be stacked during this short time before MySQL momentarily stops answering new requests. You need to increase this only if you expect a large number of connections in a short period of time.

In other words, this value is the size of the listen queue for incoming TCP/IP connections. Your operating system has its own limit on the size of this queue. The manual page for the Unix `listen()` system call should have more details. Check your OS documentation for the maximum value for this variable. `back_log` cannot be set higher than your operating system limit.

- `basedir`

<b>Command Line Format</b>	<code>--basedir=name</code>
<b>Config File Format</b>	<code>basedir</code>

<b>Option Sets Variable</b>	Yes, <code>basedir</code>	
<b>Variable Name</b>	<code>basedir</code>	
<b>Variable Scope</b>	Global	
<b>Dynamic Variable</b>	No	
<b>Value Set</b>	<b>Type</b>	<code>filename</code>

The MySQL installation base directory. This variable can be set with the `--basedir` option. Relative path names for other variables usually are resolved relative to the base directory.

- `bulk_insert_buffer_size`

<b>Command Line Format</b>	<code>--bulk_insert_buffer_size=#</code>	
<b>Config File Format</b>	<code>bulk_insert_buffer_size</code>	
<b>Option Sets Variable</b>	Yes, <code>bulk_insert_buffer_size</code>	
<b>Variable Name</b>	<code>bulk_insert_buffer_size</code>	
<b>Variable Scope</b>	Both	
<b>Dynamic Variable</b>	Yes	
<b>Value Set</b>	<b>Platform Bit Size</b>	32
	<b>Type</b>	numeric
	<b>Default</b>	8388608
	<b>Range</b>	0-4294967295
<b>Value Set</b>	<b>Platform Bit Size</b>	64
	<b>Type</b>	numeric
	<b>Default</b>	8388608
	<b>Range</b>	0-18446744073709547520

MyISAM uses a special tree-like cache to make bulk inserts faster for `INSERT ... SELECT`, `INSERT ... VALUES (...), (...), ...`, and `LOAD DATA INFILE` when adding data to non-empty tables. This variable limits the size of the cache tree in bytes per thread. Setting it to 0 disables this optimization. The default value is 8MB.

- `character_set_client`

<b>Variable Name</b>	<code>character_set_client</code>	
<b>Variable Scope</b>	Both	
<b>Dynamic Variable</b>	Yes	
<b>Value Set</b>	<b>Type</b>	<code>string</code>

The character set for statements that arrive from the client. The session value of this variable is set using the character set requested by the client when the client connects to the server. (Many clients support a `--default-character-set` option to enable this character set to be specified explicitly. See also [Section 9.1.4, “Connection Character Sets and Collations”](#).) The global value of the variable is used to set the session value in cases when the client-requested value is unknown or not available, or the server is configured to ignore client requests:

- The client is from a version of MySQL older than MySQL 4.1, and thus does not request a character set.
- The client requests a character set not known to the server. For example, a Japanese-enabled client requests `sjis` when connecting to a server not configured with `sjis` support.
- `mysqld` was started with the `--skip-character-set-client-handshake` option, which causes it to ignore client character set configuration. This reproduces MySQL 4.0 behavior and is useful should you wish to upgrade the server without upgrading all the clients.

- `character_set_connection`

<b>Variable Name</b>	<code>character_set_connection</code>
----------------------	---------------------------------------

<b>Variable Scope</b>	Both
<b>Dynamic Variable</b>	Yes
<b>Value Set</b>	<b>Type</b>   <code>string</code>

The character set used for literals that do not have a character set introducer and for number-to-string conversion.

- `character_set_database`

<b>Variable Name</b>	<code>character_set_database</code>
<b>Variable Scope</b>	Both
<b>Dynamic Variable</b>	Yes
<b>Footnote</b>	This option is dynamic, but only the server should set this information. You should not set the value of this variable manually.
<b>Value Set</b>	<b>Type</b>   <code>string</code>

The character set used by the default database. The server sets this variable whenever the default database changes. If there is no default database, the variable has the same value as `character_set_server`.

- `character_set_filesystem`

<b>Version Introduced</b>	5.1.6
<b>Command Line Format</b>	<code>--character-set-filesystem=name</code>
<b>Config File Format</b>	<code>character-set-filesystem</code>
<b>Option Sets Variable</b>	Yes, <code>character_set_filesystem</code>
<b>Variable Name</b>	<code>character_set_filesystem</code>
<b>Variable Scope</b>	Both
<b>Dynamic Variable</b>	Yes
<b>Value Set</b>	<b>Type</b>   <code>string</code>

The file system character set. This variable is used to interpret string literals that refer to file names, such as in the `LOAD DATA INFILE` and `SELECT ... INTO OUTFILE` statements and the `LOAD_FILE()` function. Such file names are converted from `character_set_client` to `character_set_filesystem` before the file opening attempt occurs. The default value is `binary`, which means that no conversion occurs. For systems on which multi-byte file names are allowed, a different value may be more appropriate. For example, if the system represents file names using UTF-8, set `character_set_filesystem` to `'utf8'`. This variable was added in MySQL 5.1.6.

- `character_set_results`

<b>Variable Name</b>	<code>character_set_results</code>
<b>Variable Scope</b>	Both
<b>Dynamic Variable</b>	Yes
<b>Value Set</b>	<b>Type</b>   <code>string</code>

The character set used for returning query results to the client.

- `character_set_server`

<b>Command Line Format</b>	<code>--character-set-server</code>
<b>Config File Format</b>	<code>character-set-server</code>
<b>Option Sets Variable</b>	Yes, <code>character_set_server</code>
<b>Variable Name</b>	<code>character_set_server</code>
<b>Variable Scope</b>	Both
<b>Dynamic Variable</b>	Yes

<b>Value Set</b>	<b>Type</b>	string
------------------	-------------	--------

The server's default character set.

- `character_set_system`

<b>Variable Name</b>	<code>character_set_system</code>	
<b>Variable Scope</b>	Global	
<b>Dynamic Variable</b>	No	
<b>Value Set</b>	<b>Type</b>	string

The character set used by the server for storing identifiers. The value is always `utf8`.

- `character_sets_dir`

<b>Command Line Format</b>	<code>--character-sets-dir=name</code>	
<b>Config File Format</b>	<code>character-sets-dir</code>	
<b>Option Sets Variable</b>	Yes, <code>character_sets_dir</code>	
<b>Variable Name</b>	<code>character-sets-dir</code>	
<b>Variable Scope</b>	Global	
<b>Dynamic Variable</b>	No	
<b>Value Set</b>	<b>Type</b>	filename

The directory where character sets are installed.

- `collation_connection`

<b>Variable Name</b>	<code>collation_connection</code>	
<b>Variable Scope</b>	Both	
<b>Dynamic Variable</b>	Yes	
<b>Value Set</b>	<b>Type</b>	string

The collation of the connection character set.

- `collation_database`

<b>Variable Name</b>	<code>collation_database</code>	
<b>Variable Scope</b>	Both	
<b>Dynamic Variable</b>	Yes	
<b>Footnote</b>	This option is dynamic, but only the server should set this information. You should not set the value of this variable manually.	
<b>Value Set</b>	<b>Type</b>	string

The collation used by the default database. The server sets this variable whenever the default database changes. If there is no default database, the variable has the same value as `collation_server`.

- `collation_server`

<b>Command Line Format</b>	<code>--collation-server</code>	
<b>Config File Format</b>	<code>collation-server</code>	
<b>Option Sets Variable</b>	Yes, <code>collation_server</code>	
<b>Variable Name</b>	<code>collation_server</code>	

<b>Variable Scope</b>	Both
<b>Dynamic Variable</b>	Yes
<b>Value Set</b>	<b>Type</b>   <code>string</code>

The server's default collation.

- `completion_type`

<b>Command Line Format</b>	<code>--completion_type=#</code>	
<b>Config File Format</b>	<code>completion_type</code>	
<b>Option Sets Variable</b>	Yes, <code>completion_type</code>	
<b>Variable Name</b>	<code>completion_type</code>	
<b>Variable Scope</b>	Both	
<b>Dynamic Variable</b>	Yes	
<b>Value Set</b>	<b>Type</b>	<code>numeric</code>
	<b>Default</b>	<code>0</code>
	<b>Valid Values</b>	<code>0, 1, 2</code>

The transaction completion type:

- If the value is 0 (the default), `COMMIT` and `ROLLBACK` are unaffected.
  - If the value is 1, `COMMIT` and `ROLLBACK` are equivalent to `COMMIT AND CHAIN` and `ROLLBACK AND CHAIN`, respectively. (A new transaction starts immediately with the same isolation level as the just-terminated transaction.)
  - If the value is 2, `COMMIT` and `ROLLBACK` are equivalent to `COMMIT RELEASE` and `ROLLBACK RELEASE`, respectively. (The server disconnects after terminating the transaction.)
- `concurrent_insert`

<b>Command Line Format</b>	<code>--concurrent_insert[=#]</code>	
<b>Config File Format</b>	<code>concurrent_insert</code>	
<b>Option Sets Variable</b>	Yes, <code>concurrent_insert</code>	
<b>Variable Name</b>	<code>concurrent_insert</code>	
<b>Variable Scope</b>	Global	
<b>Dynamic Variable</b>	Yes	
<b>Value Set</b>	<b>Type</b>	<code>numeric</code>
	<b>Default</b>	<code>1</code>
	<b>Valid Values</b>	<code>0, 1, 2</code>

If 1 (the default), MySQL allows `INSERT` and `SELECT` statements to run concurrently for `MyISAM` tables that have no free blocks in the middle of the data file. You can turn this option off by starting `mysqld` with `--safe-mode` or `--skip-new`.

This variable can take three integer values.

Value	Description
0	Off
1	(Default) Enables concurrent insert for <code>MyISAM</code> tables that don't have holes
2	Enables concurrent inserts for all <code>MyISAM</code> tables, even those that have holes. For a table with a hole, new rows are inserted at the end of the table if it is in use by another thread. Otherwise, MySQL acquires a normal write lock and inserts the row into the hole.

See also [Section 7.3.3, “Concurrent Inserts”](#).



- `connect_timeout`

<b>Command Line Format</b>	<code>--connect_timeout=#</code>	
<b>Config File Format</b>	<code>connect_timeout</code>	
<b>Option Sets Variable</b>	Yes, <code>connect_timeout</code>	
<b>Variable Name</b>	<code>connect_timeout</code>	
<b>Variable Scope</b>	Global	
<b>Dynamic Variable</b>	Yes	
<b>Value Set (&lt;= 5.1.22)</b>	<b>Type</b>	<code>numeric</code>
	<b>Default</b>	<code>5</code>
<b>Value Set (&gt;= 5.1.23)</b>	<b>Type</b>	<code>numeric</code>
	<b>Default</b>	<code>10</code>

The number of seconds that the `mysqld` server waits for a connect packet before responding with `Bad handshake`. The default value is 10 seconds as of MySQL 5.1.23 and 5 seconds before that.

Increasing the `connect_timeout` value might help if clients frequently encounter errors of the form `Lost connection to MySQL server at 'XXX', system error: errno`.

- `datadir`

<b>Command Line Format</b>	<code>--datadir=name</code>	
<b>Config File Format</b>	<code>datadir</code>	
<b>Option Sets Variable</b>	Yes, <code>datadir</code>	
<b>Variable Name</b>	<code>datadir</code>	
<b>Variable Scope</b>	Global	
<b>Dynamic Variable</b>	No	
<b>Value Set</b>	<b>Type</b>	<code>filename</code>

The MySQL data directory. This variable can be set with the `--datadir` option.

- `date_format`

This variable is unused.

- `datetime_format`

This variable is unused.

- `debug`

<b>Command Line Format</b>	<code>--debug[=debug_options]</code>	
<b>Config File Format</b>	<code>debug</code>	
<b>Variable Name</b>	<code>debug</code>	
<b>Variable Scope</b>	Both	
<b>Dynamic Variable</b>	Yes	
<b>Value Set</b>	<b>Type</b>	<code>string</code>
	<b>Default</b>	<code>'d:t:o,/tmp/mysqld.trace'</code>

This variable indicates the current debugging settings. It is available only for servers built with debugging support. The initial value comes from the value of instances of the `--debug` option given at server startup. The global and session values may be set at runtime; the `SUPER` privilege is required, even for the session value.

Assigning a value that begins with `+` or `-` cause the value to added to or subtracted from the current value:

```
mysql> SET debug = 'T';
```

```
mysql> SELECT @@debug;
+-----+
| @@debug |
+-----+
| T       |
+-----+

mysql> SET debug = '+P';
mysql> SELECT @@debug;
+-----+
| @@debug |
+-----+
| P:T     |
+-----+

mysql> SET debug = '-P';
mysql> SELECT @@debug;
+-----+
| @@debug |
+-----+
| T       |
+-----+
```

This variable was added in MySQL 5.1.7.

- `default_week_format`

<b>Command Line Format</b>	<code>--default-week-format=#</code>	
<b>Config File Format</b>	<code>default-week-format</code>	
<b>Option Sets Variable</b>	Yes, <code>default-week-format</code>	
<b>Variable Name</b>	<code>default-week-format</code>	
<b>Variable Scope</b>	Both	
<b>Dynamic Variable</b>	Yes	
<b>Value Set</b>	<b>Type</b>	numeric
	<b>Default</b>	0
	<b>Range</b>	0-7

The default mode value to use for the `WEEK()` function. See [Section 11.6, “Date and Time Functions”](#).

- `delay_key_write`

<b>Command Line Format</b>	<code>--delay-key-write[=name]</code>	
<b>Config File Format</b>	<code>delay-key-write</code>	
<b>Option Sets Variable</b>	Yes, <code>delay-key-write</code>	
<b>Variable Name</b>	<code>delay-key-write</code>	
<b>Variable Scope</b>	Global	
<b>Dynamic Variable</b>	Yes	
<b>Value Set</b>	<b>Type</b>	enumeration
	<b>Default</b>	ON
	<b>Valid Values</b>	ON, OFF, ALL

This option applies only to `MyISAM` tables. It can have one of the following values to affect handling of the `DELAY_KEY_WRITE` table option that can be used in `CREATE TABLE` statements.

Option	Description
OFF	<code>DELAY_KEY_WRITE</code> is ignored.
ON	MySQL honors any <code>DELAY_KEY_WRITE</code> option specified in <code>CREATE TABLE</code> statements. This is the default value.
ALL	All new opened tables are treated as if they were created with the <code>DELAY_KEY_WRITE</code> option enabled.

If `DELAY_KEY_WRITE` is enabled for a table, the key buffer is not flushed for the table on every index update, but only when the table is closed. This speeds up writes on keys a lot, but if you use this feature, you should add automatic checking of all

MyISAM tables by starting the server with the `--myisam-recover` option (for example, `--myisam-recover=BACKUP, FORCE`). See [Section 5.1.2, “Server Command Options”](#), and [Section 13.4.1, “MyISAM Startup Options”](#).

### Warning

If you enable external locking with `--external-locking`, there is no protection against index corruption for tables that use delayed key writes.

- `delayed_insert_limit`

<b>Command Line Format</b>	<code>--delayed_insert_limit=#</code>	
<b>Config File Format</b>	<code>delayed_insert_limit</code>	
<b>Option Sets Variable</b>	Yes, <code>delayed_insert_limit</code>	
<b>Variable Name</b>	<code>delayed_insert_limit</code>	
<b>Variable Scope</b>	Global	
<b>Dynamic Variable</b>	Yes	
<b>Value Set</b>	<b>Platform Bit Size</b>	32
	<b>Type</b>	numeric
	<b>Default</b>	100
	<b>Range</b>	1-4294967295
<b>Value Set</b>	<b>Platform Bit Size</b>	64
	<b>Type</b>	numeric
	<b>Default</b>	100
	<b>Range</b>	1-18446744073709547520

After inserting `delayed_insert_limit` delayed rows, the `INSERT DELAYED` handler thread checks whether there are any `SELECT` statements pending. If so, it allows them to execute before continuing to insert delayed rows.

- `delayed_insert_timeout`

<b>Command Line Format</b>	<code>--delayed_insert_timeout=#</code>	
<b>Config File Format</b>	<code>delayed_insert_timeout</code>	
<b>Option Sets Variable</b>	Yes, <code>delayed_insert_timeout</code>	
<b>Variable Name</b>	<code>delayed_insert_timeout</code>	
<b>Variable Scope</b>	Global	
<b>Dynamic Variable</b>	Yes	
<b>Value Set</b>	<b>Type</b>	numeric
	<b>Default</b>	300

How many seconds an `INSERT DELAYED` handler thread should wait for `INSERT` statements before terminating.

- `delayed_queue_size`

<b>Command Line Format</b>	<code>--delayed_queue_size=#</code>	
<b>Config File Format</b>	<code>delayed_queue_size</code>	
<b>Option Sets Variable</b>	Yes, <code>delayed_queue_size</code>	
<b>Variable Name</b>	<code>delayed_queue_size</code>	
<b>Variable Scope</b>	Global	
<b>Dynamic Variable</b>	Yes	
<b>Value Set</b>	<b>Platform Bit Size</b>	32
	<b>Type</b>	numeric
	<b>Default</b>	1000

	<b>Range</b>	1-4294967295
<b>Value Set</b>	<b>Platform Bit Size</b>	64
	<b>Type</b>	numeric
	<b>Default</b>	1000
	<b>Range</b>	1-18446744073709547520

This is a per-table limit on the number of rows to queue when handling `INSERT DELAYED` statements. If the queue becomes full, any client that issues an `INSERT DELAYED` statement waits until there is room in the queue again.

- `div_precision_increment`

<b>Command Line Format</b>	<code>--div_precision_increment=#</code>	
<b>Config File Format</b>	<code>div_precision_increment</code>	
<b>Option Sets Variable</b>	Yes, <code>div_precision_increment</code>	
<b>Variable Name</b>	<code>div_precision_increment</code>	
<b>Variable Scope</b>	Both	
<b>Dynamic Variable</b>	Yes	
<b>Value Set</b>	<b>Type</b>	numeric
	<b>Default</b>	4
	<b>Range</b>	0-30

This variable indicates the number of digits by which to increase the scale of the result of division operations performed with the `/` operator. The default value is 4. The minimum and maximum values are 0 and 30, respectively. The following example illustrates the effect of increasing the default value.

```
mysql> SELECT 1/7;
+-----+
| 1/7 |
+-----+
| 0.1429 |
+-----+
mysql> SET div_precision_increment = 12;
mysql> SELECT 1/7;
+-----+
| 1/7 |
+-----+
| 0.142857142857 |
+-----+
```

- `engine_condition_pushdown`

<b>Command Line Format</b>	<code>--engine-condition-pushdown</code>	
<b>Config File Format</b>	<code>engine-condition-pushdown</code>	
<b>Option Sets Variable</b>	Yes, <code>engine_condition_pushdown</code>	
<b>Variable Name</b>	<code>engine_condition_pushdown</code>	
<b>Variable Scope</b>	Both	
<b>Dynamic Variable</b>	Yes	
<b>Value Set (&gt;= 5.1.0)</b>	<b>Type</b>	boolean
	<b>Default</b>	ON

When the value of this variable is 0 (`OFF`), a query such as `SELECT * FROM t WHERE mycol = 42`, where `mycol` is a non-indexed column, is executed as a full table scan. The storage engine sends every row to the MySQL server, which applies the `WHERE` condition. If `engine_condition_pushdown` is set to 1 (`ON`), the condition is “pushed down” to the storage engine, which uses the condition to perform the scan, and sends back to the MySQL server only those rows that match the condition. By default, this variable is `OFF`.

In MySQL 5.1, this variable is useful only with the `NDBCLUSTER` storage engine. However, we intend to implement it for additional storage engines in future MySQL releases.

Setting this variable to `ON` on a MySQL Server acting as a MySQL Cluster SQL node causes `WHERE` conditions on unindexed columns to be evaluated on the cluster's data nodes and only the rows that match to be sent back to the SQL node that issued the query. This means the amount of cluster data that must be sent over the network is greatly reduced, increasing the efficiency with which results are returned.

For more information, see [Section 7.2.7, “Condition Pushdown Optimization”](#).

- `event_scheduler`

<b>Version Introduced</b>	5.1.6	
<b>Command Line Format</b>	<code>--event-scheduler[=value]</code>	
<b>Config File Format</b>	<code>event_scheduler</code>	
<b>Option Sets Variable</b>	Yes, <code>event_scheduler</code>	
<b>Variable Name</b>	<code>event_scheduler</code>	
<b>Variable Scope</b>	Global	
<b>Dynamic Variable</b>	Yes	
<b>Value Set</b>	<b>Type</b>	enumeration
	<b>Default</b>	OFF
	<b>Valid Values</b>	ON, OFF, DISABLED

This variable indicates the status of the Event Scheduler; as of MySQL 5.1.12, possible values are `ON`, `OFF`, and `DISABLED`, with the default being `OFF`. This variable and its effects on the Event Scheduler's operation are discussed in greater detail in the [Overview section of the Events chapter](#).

This variable was added in MySQL 5.1.6.

- `expire_logs_days`

<b>Command Line Format</b>	<code>--expire_logs_days=#</code>	
<b>Config File Format</b>	<code>expire_logs_days</code>	
<b>Option Sets Variable</b>	Yes, <code>expire_logs_days</code>	
<b>Variable Name</b>	<code>expire_logs_days</code>	
<b>Variable Scope</b>	Global	
<b>Dynamic Variable</b>	Yes	
<b>Value Set</b>	<b>Type</b>	numeric
	<b>Default</b>	0
	<b>Range</b>	0-99

The number of days for automatic binary log removal. The default is 0, which means “no automatic removal.” Possible removals happen at startup and at binary log rotation.

- `flush`

<b>Command Line Format</b>	<code>--flush</code>	
<b>Config File Format</b>	<code>flush</code>	
<b>Variable Name</b>	<code>flush</code>	
<b>Variable Scope</b>	Global	
<b>Dynamic Variable</b>	Yes	
<b>Value Set</b>	<b>Type</b>	boolean
	<b>Default</b>	OFF

If `ON`, the server flushes (synchronizes) all changes to disk after each SQL statement. Normally, MySQL does a write of all changes to disk only after each SQL statement and lets the operating system handle the synchronizing to disk. See [Section B.1.4.2, “What to Do If MySQL Keeps Crashing”](#). This variable is set to `ON` if you start `mysqld` with the `--flush` op-

tion.

- `flush_time`

<b>Command Line Format</b>	<code>--flush_time=#</code>	
<b>Config File Format</b>	<code>flush_time</code>	
<b>Option Sets Variable</b>	Yes, <code>flush_time</code>	
<b>Variable Name</b>	<code>flush_time</code>	
<b>Variable Scope</b>	Global	
<b>Dynamic Variable</b>	Yes	
<b>Value Set</b>	<b>Type</b>	<code>numeric</code>
	<b>Default</b>	<code>0</code>
	<b>Min Value</b>	<code>0</code>
<b>Value Set</b>	<b>Type (windows)</b>	<code>numeric</code>
	<b>Default</b>	<code>1800</code>
	<b>Min Value</b>	<code>0</code>

If this is set to a nonzero value, all tables are closed every `flush_time` seconds to free up resources and synchronize unflushed data to disk. We recommend that this option be used only on Windows 9x or Me, or on systems with minimal resources.

- `ft_boolean_syntax`

<b>Command Line Format</b>	<code>--ft_boolean_syntax=name</code>	
<b>Config File Format</b>	<code>ft_boolean_syntax</code>	
<b>Variable Name</b>	<code>ft_boolean_syntax</code>	
<b>Variable Scope</b>	Global	
<b>Dynamic Variable</b>	Yes	
<b>Value Set</b>	<b>Type</b>	<code>string</code>
	<b>Default</b>	<code>+-&gt;&lt;()~*:""&amp;</code>

The list of operators supported by boolean full-text searches performed using `IN BOOLEAN MODE`. See [Section 11.8.2, “Boolean Full-Text Searches”](#).

The default variable value is `' + -><()~*:""&| '`. The rules for changing the value are as follows:

- Operator function is determined by position within the string.
  - The replacement value must be 14 characters.
  - Each character must be an ASCII non-alphanumeric character.
  - Either the first or second character must be a space.
  - No duplicates are allowed except the phrase quoting operators in positions 11 and 12. These two characters are not required to be the same, but they are the only two that may be.
  - Positions 10, 13, and 14 (which by default are set to “:”, “&”, and “|”) are reserved for future extensions.
- `ft_max_word_len`

<b>Command Line Format</b>	<code>--ft_max_word_len=#</code>	
<b>Config File Format</b>	<code>ft_max_word_len</code>	
<b>Option Sets Variable</b>	Yes, <code>ft_max_word_len</code>	
<b>Variable Name</b>	<code>ft_max_word_len</code>	
<b>Variable Scope</b>	Global	
<b>Dynamic Variable</b>	No	

Value Set	Type	numeric
	Min Value	10

The maximum length of the word to be included in a `FULLTEXT` index.

### Note

`FULLTEXT` indexes must be rebuilt after changing this variable. Use `REPAIR TABLE tbl_name QUICK`.

- `ft_min_word_len`

Command Line Format	<code>--ft_min_word_len=#</code>	
Config File Format	<code>ft_min_word_len</code>	
Option Sets Variable	Yes, <code>ft_min_word_len</code>	
Variable Name	<code>ft_min_word_len</code>	
Variable Scope	Global	
Dynamic Variable	No	
Value Set	Type	numeric
	Default	4
	Min Value	1

The minimum length of the word to be included in a `FULLTEXT` index.

### Note

`FULLTEXT` indexes must be rebuilt after changing this variable. Use `REPAIR TABLE tbl_name QUICK`.

- `ft_query_expansion_limit`

Command Line Format	<code>--ft_query_expansion_limit=#</code>	
Config File Format	<code>ft_query_expansion_limit</code>	
Option Sets Variable	Yes, <code>ft_query_expansion_limit</code>	
Variable Name	<code>ft_query_expansion_limit</code>	
Variable Scope	Global	
Dynamic Variable	No	
Value Set	Type	numeric
	Default	20
	Range	0-1000

The number of top matches to use for full-text searches performed using `WITH QUERY EXPANSION`.

- `ft_stopword_file`

Command Line Format	<code>--ft_stopword_file=name</code>	
Config File Format	<code>ft_stopword_file</code>	
Option Sets Variable	Yes, <code>ft_stopword_file</code>	
Variable Name	<code>ft_stopword_file</code>	
Variable Scope	Global	
Dynamic Variable	No	
Value Set	Type	filename

The file from which to read the list of stopwords for full-text searches. All the words from the file are used; comments are *not*

honored. By default, a built-in list of stopwords is used (as defined in the `storage/myisam/ft_static.c` file). Setting this variable to the empty string ( `'` ) disables stopword filtering.

### Note

`FULLTEXT` indexes must be rebuilt after changing this variable or the contents of the stopword file. Use `REPAIR TABLE tbl_name QUICK`.

- `general_log`

<b>Version Introduced</b>	5.1.12	
<b>Command Line Format</b>	<code>--general-log</code>	
<b>Config File Format</b>	<code>general-log</code>	
<b>Option Sets Variable</b>	Yes, <code>general_log</code>	
<b>Variable Name</b>	<code>general_log</code>	
<b>Variable Scope</b>	Global	
<b>Dynamic Variable</b>	Yes	
<b>Value Set</b>	<b>Type</b>	<code>boolean</code>
	<b>Default</b>	<code>OFF</code>

Whether the general query log is enabled. The value can be 0 (or `OFF`) to disable the log or 1 (or `ON`) to enable the log. The default value depends on whether the `--general-log` option is given (`--log` before MySQL 5.1.29). The destination for log output is controlled by the `log_output` system variable; if that value is `NONE`, no log entries are written even if the log is enabled. The `general_log` variable was added in MySQL 5.1.12.

- `general_log_file`

<b>Version Introduced</b>	5.1.12	
<b>Command Line Format</b>	<code>--general-log-file=file_name</code>	5.1.29
<b>Config File Format</b>	<code>general_log_file</code>	5.1.29
<b>Option Sets Variable</b>	Yes, <code>general_log_file</code>	
<b>Variable Name</b>	<code>general_log_file</code>	
<b>Variable Scope</b>	Global	
<b>Dynamic Variable</b>	Yes	
<b>Value Set</b>	<b>Type</b>	<code>filename</code>
	<b>Default</b>	<code>host_name.log</code>

The name of the general query log file. The default value is `host_name.log`, but the initial value can be changed with the `--general_log_file` option (`--log` before MySQL 5.1.29). This variable was added in MySQL 5.1.12.

- `group_concat_max_len`

<b>Command Line Format</b>	<code>--group_concat_max_len=#</code>	
<b>Config File Format</b>	<code>group_concat_max_len</code>	
<b>Option Sets Variable</b>	Yes, <code>group_concat_max_len</code>	
<b>Variable Name</b>	<code>group_concat_max_len</code>	
<b>Variable Scope</b>	Both	
<b>Dynamic Variable</b>	Yes	
<b>Value Set</b>	<b>Platform Bit Size</b>	32
	<b>Type</b>	<code>numeric</code>
	<b>Default</b>	1024
	<b>Range</b>	4-4294967295
<b>Value Set</b>	<b>Platform Bit Size</b>	64



	<b>Type</b>	numeric
	<b>Default</b>	1024
	<b>Range</b>	4-18446744073709547520

The maximum allowed result length in bytes for the `GROUP_CONCAT()` function. The default is 1024.

- `have_archive`

**YES** if `mysqld` supports `ARCHIVE` tables, **NO** if not. This variable was removed in MySQL 5.1.14.

- `have_blackhole_engine`

**YES** if `mysqld` supports `BLACKHOLE` tables, **NO** if not. This variable was removed in MySQL 5.1.14.

- `have_compress`

**YES** if the `zlib` compression library is available to the server, **NO** if not. If not, the `COMPRESS()` and `UNCOMPRESS()` functions cannot be used.

- `have_crypt`

**YES** if the `crypt()` system call is available to the server, **NO** if not. If not, the `ENCRYPT()` function cannot be used.

- `have_csv`

**YES** if `mysqld` supports `ARCHIVE` tables, **NO** if not.

- `have_dynamic_loading`

**YES** if `mysqld` supports dynamic loading of plugins, **NO** if not. This variable was added in MySQL 5.1.10.

- `have_example_engine`

**YES** if `mysqld` supports `EXAMPLE` tables, **NO** if not. This variable was removed in MySQL 5.1.14.

- `have_federated_engine`

**YES** if `mysqld` supports `FEDERATED` tables, **NO** if not. This variable was removed in MySQL 5.1.14.

- `have_geometry`

**YES** if the server supports spatial data types, **NO** if not.

- `have_innodb`

**YES** if `mysqld` supports `InnoDB` tables. **DISABLED** if `--skip-innodb` is used.

- `have_isam`

In MySQL 5.1, this variable appears only for reasons of backward compatibility. It is always **NO** because `ISAM` tables are no longer supported. This variable was removed in MySQL 5.1.7.

- `have_merge_engine`

**YES** if `mysqld` supports `MERGE` tables. **DISABLED** if `--skip-merge` is used. This variable was removed in MySQL 5.1.3.

- `have_openssl`

**YES** if `mysqld` supports SSL connections, **NO** if not. As of MySQL 5.1.17, this variable is an alias for `have_ssl`.

- `have_partitioning`

**YES** if `mysqld` supports partitioning. Added in MySQL 5.1.1 as `have_partition_engine` and renamed to `have_partitioning` in 5.1.6.

- `have_query_cache`

**YES** if `mysqld` supports the query cache, **NO** if not.

- `have_row_based_replication`

<b>Version Introduced</b>	5.1.5	
<b>Version Removed</b>	5.1.15	
<b>Variable Name</b>	<code>have_row_based_replication</code>	
<b>Variable Scope</b>	Global	
<b>Dynamic Variable</b>	No	
<b>Value Set</b>	<b>Type</b>	<code>boolean</code>

**YES** if the server can perform replication using row-based binary logging. If the value is **NO**, the server can use only statement-based logging. See [Section 16.1.2, “Replication Formats”](#). This variable was added in MySQL 5.1.5 and removed in 5.1.15.

- `have_raid`

In MySQL 5.1, this variable appears only for reasons of backward compatibility. It is always **NO** because **RAID** tables are no longer supported. This variable was removed in MySQL 5.1.7.

- `have_rtree_keys`

**YES** if **RTREE** indexes are available, **NO** if not. (These are used for spatial indexes in **MyISAM** tables.)

- `have_ssl`

**YES** if `mysqld` supports SSL connections, **NO** if not. This variable was added in MySQL 5.1.17. Before that, use `have_openssl`.

- `have_symlink`

**YES** if symbolic link support is enabled, **NO** if not. This is required on Unix for support of the **DATA DIRECTORY** and **INDEX DIRECTORY** table options, and on Windows for support of data directory symlinks.

- `hostname`

<b>Version Introduced</b>	5.1.17	
<b>Variable Name</b>	<code>hostname</code>	
<b>Variable Scope</b>	Global	
<b>Dynamic Variable</b>	No	
<b>Value Set</b>	<b>Type</b>	<code>string</code>

The server sets this variable to the server host name at startup. This variable was added in MySQL 5.1.17.

- `init_connect`

<b>Command Line Format</b>	<code>--init-connect=name</code>	
<b>Config File Format</b>	<code>init_connect</code>	
<b>Option Sets Variable</b>	Yes, <code>init_connect</code>	
<b>Variable Name</b>	<code>init_connect</code>	
<b>Variable Scope</b>	Global	
<b>Dynamic Variable</b>	Yes	
<b>Value Set</b>	<b>Type</b>	<code>string</code>

A string to be executed by the server for each client that connects. The string consists of one or more SQL statements. To specify multiple statements, separate them by semicolon characters. For example, each client begins by default with autocommit mode enabled. There is no global system variable to specify that autocommit should be disabled by default, but `init_connect` can be used to achieve the same effect:

```
SET GLOBAL init_connect='SET autocommit=0';
```

This variable can also be set on the command line or in an option file. To set the variable as just shown using an option file, include these lines:

```
[mysqld]
init_connect='SET autocommit=0'
```

Note that the content of `init_connect` is not executed for users that have the `SUPER` privilege. This is done so that an erroneous value for `init_connect` does not prevent all clients from connecting. For example, the value might contain a statement that has a syntax error, thus causing client connections to fail. Not executing `init_connect` for users that have the `SUPER` privilege enables them to open a connection and fix the `init_connect` value.

- `init_file`

<b>Command Line Format</b>	<code>--init-file=name</code>	
<b>Config File Format</b>	<code>init-file</code>	
<b>Option Sets Variable</b>	Yes, <code>init_file</code>	
<b>Variable Name</b>	<code>init_file</code>	
<b>Variable Scope</b>	Global	
<b>Dynamic Variable</b>	No	
<b>Value Set</b>	<b>Type</b>	<code>filename</code>

The name of the file specified with the `--init-file` option when you start the server. This should be a file containing SQL statements that you want the server to execute when it starts. Each statement must be on a single line and should not include comments.

Note that the `--init-file` option is unavailable if MySQL was configured with the `--disable-grant-options` option. See [Section 2.10.2, “Typical configure Options”](#).

- `innodb_xxx`

InnoDB system variables are listed in [Section 13.6.3, “InnoDB Startup Options and System Variables”](#).

- `interactive_timeout`

<b>Command Line Format</b>	<code>--interactive_timeout=#</code>	
<b>Config File Format</b>	<code>interactive_timeout</code>	
<b>Option Sets Variable</b>	Yes, <code>interactive_timeout</code>	
<b>Variable Name</b>	<code>interactive_timeout</code>	
<b>Variable Scope</b>	Both	
<b>Dynamic Variable</b>	Yes	
<b>Value Set</b>	<b>Type</b>	<code>numeric</code>
	<b>Default</b>	<code>28800</code>
	<b>Min Value</b>	<code>1</code>

The number of seconds the server waits for activity on an interactive connection before closing it. An interactive client is defined as a client that uses the `CLIENT_INTERACTIVE` option to `mysql_real_connect()`. See also `wait_timeout`.

- `join_buffer_size`

<b>Command Line Format</b>	<code>--join_buffer_size=#</code>	
<b>Config File Format</b>	<code>join_buffer_size</code>	
<b>Option Sets Variable</b>	Yes, <code>join_buffer_size</code>	
<b>Variable Name</b>	<code>join_buffer_size</code>	
<b>Variable Scope</b>	Both	
<b>Dynamic Variable</b>	Yes	
<b>Value Set</b>	<b>Platform Bit Size</b>	<code>64</code>

	<b>Type</b>	numeric
	<b>Default</b>	131072
	<b>Range</b>	8200-18446744073709547520

The size of the buffer that is used for plain index scans, range index scans, and joins that do not use indexes and thus perform full table scans. Normally, the best way to get fast joins is to add indexes. Increase the value of `join_buffer_size` to get a faster full join when adding indexes is not possible. One join buffer is allocated for each full join between two tables. For a complex join between several tables for which indexes are not used, multiple join buffers might be necessary.

The maximum allowable setting for `join_buffer_size` is 4GB. As of MySQL 5.1.23, values larger than 4GB are allowed for 64-bit platforms (except 64-bit Windows, for which large values are truncated to 4GB with a warning).

- `keep_files_on_create`

<b>Version Introduced</b>	5.1.21	
<b>Command Line Format</b>	<code>--keep_files_on_create=#</code>	
<b>Config File Format</b>	<code>keep_files_on_create</code>	
<b>Option Sets Variable</b>	Yes, <code>keep_files_on_create</code>	
<b>Variable Name</b>	<code>keep_files_on_create</code>	
<b>Variable Scope</b>	Both	
<b>Dynamic Variable</b>	Yes	
<b>Value Set</b>	<b>Type</b>	boolean
	<b>Default</b>	OFF

If a `MyISAM` table is created with no `DATA DIRECTORY` option, the `.MYD` file is created in the database directory. By default, if `MyISAM` finds an existing `.MYD` file in this case, it overwrites it. The same applies to `.MYI` files for tables created with no `INDEX DIRECTORY` option. To suppress this behavior, set the `keep_files_on_create` variable to `ON` (1), in which case `MyISAM` will not overwrite existing files and returns an error instead. The default value is `OFF` (0).

If a `MyISAM` table is created with a `DATA DIRECTORY` or `INDEX DIRECTORY` option and an existing `.MYD` or `.MYI` file is found, `MyISAM` always returns an error. It will not overwrite a file in the specified directory.

This variable was added in MySQL 5.1.23.

- `key_buffer_size`

<b>Command Line Format</b>	<code>--key_buffer_size=#</code>	
<b>Config File Format</b>	<code>key_buffer_size</code>	
<b>Option Sets Variable</b>	Yes, <code>key_buffer_size</code>	
<b>Variable Name</b>	<code>key_buffer_size</code>	
<b>Variable Scope</b>	Global	
<b>Dynamic Variable</b>	Yes	
<b>Value Set</b>	<b>Type</b>	numeric
	<b>Default</b>	8388608
	<b>Range</b>	8-4294967295

Index blocks for `MyISAM` tables are buffered and are shared by all threads. `key_buffer_size` is the size of the buffer used for index blocks. The key buffer is also known as the key cache.

The maximum allowable setting for `key_buffer_size` is 4GB on 32-bit platforms. As of MySQL 5.1.23, values larger than 4GB are allowed for 64-bit platforms, except 64-bit Windows prior to MySQL 5.1.31, for which large values are truncated to 4GB with a warning. As of MySQL 5.1.31, values larger than 4GB are also allowed for 64-bit Windows. The effective maximum size might be less, depending on your available physical RAM and per-process RAM limits imposed by your operating system or hardware platform. The value of this variable indicates the amount of memory requested. Internally, the server allocates as much memory as possible up to this amount, but the actual allocation might be less.

Increase the value to get better index handling (for all reads and multiple writes) to as much as you can afford. Using a value that is 25% of total memory on a machine that mainly runs MySQL is quite common. However, if you make the value too large (for example, more than 50% of your total memory) your system might start to page and become extremely slow. MySQL relies on the operating system to perform file system caching for data reads, so you must leave some room for the file system cache. Consider also the memory requirements of other storage engines.

For even more speed when writing many rows at the same time, use `LOCK TABLES`. See [Section 7.2.21, “Speed of INSERT Statements”](#).

You can check the performance of the key buffer by issuing a `SHOW STATUS` statement and examining the `Key_read_requests`, `Key_reads`, `Key_write_requests`, and `Key_writes` status variables. (See [Section 12.5.5, “SHOW Syntax”](#).) The `Key_reads/Key_read_requests` ratio should normally be less than 0.01. The `Key_writes/Key_write_requests` ratio is usually near 1 if you are using mostly updates and deletes, but might be much smaller if you tend to do updates that affect many rows at the same time or if you are using the `DELAY_KEY_WRITE` table option.

The fraction of the key buffer in use can be determined using `key_buffer_size` in conjunction with the `Key_blocks_unused` status variable and the buffer block size, which is available from the `key_cache_block_size` system variable:

```
1 - ((Key_blocks_unused × key_cache_block_size) / key_buffer_size)
```

This value is an approximation because some space in the key buffer may be allocated internally for administrative structures.

It is possible to create multiple `MyISAM` key caches. The size limit of 4GB applies to each cache individually, not as a group. See [Section 7.4.5, “The MyISAM Key Cache”](#).

- `key_cache_age_threshold`

<b>Command Line Format</b>	<code>--key_cache_age_threshold=#</code>	
<b>Config File Format</b>	<code>key_cache_age_threshold</code>	
<b>Option Sets Variable</b>	Yes, <code>key_cache_age_threshold</code>	
<b>Variable Name</b>	<code>key_cache_age_threshold</code>	
<b>Variable Scope</b>	Global	
<b>Dynamic Variable</b>	Yes	
<b>Value Set</b>	<b>Platform Bit Size</b>	32
	<b>Type</b>	numeric
	<b>Default</b>	300
	<b>Range</b>	100-4294967295
<b>Value Set</b>	<b>Platform Bit Size</b>	64
	<b>Type</b>	numeric
	<b>Default</b>	300
	<b>Range</b>	100-18446744073709547520

This value controls the demotion of buffers from the hot sub-chain of a key cache to the warm sub-chain. Lower values cause demotion to happen more quickly. The minimum value is 100. The default value is 300. See [Section 7.4.5, “The MyISAM Key Cache”](#).

- `key_cache_block_size`

<b>Command Line Format</b>	<code>--key_cache_block_size=#</code>	
<b>Config File Format</b>	<code>key_cache_block_size</code>	
<b>Option Sets Variable</b>	Yes, <code>key_cache_block_size</code>	
<b>Variable Name</b>	<code>key_cache_block_size</code>	
<b>Variable Scope</b>	Global	
<b>Dynamic Variable</b>	Yes	
<b>Value Set</b>	<b>Type</b>	numeric
	<b>Default</b>	1024

	<b>Range</b>	512-16384
--	--------------	-----------

The size in bytes of blocks in the key cache. The default value is 1024. See [Section 7.4.5, “The MyISAM Key Cache”](#).

- `key_cache_division_limit`

<b>Command Line Format</b>	<code>--key_cache_division_limit=#</code>	
<b>Config File Format</b>	<code>key_cache_division_limit</code>	
<b>Option Sets Variable</b>	Yes, <code>key_cache_division_limit</code>	
<b>Variable Name</b>	<code>key_cache_division_limit</code>	
<b>Variable Scope</b>	Global	
<b>Dynamic Variable</b>	Yes	
<b>Value Set</b>	<b>Type</b>	numeric
	<b>Default</b>	100
	<b>Range</b>	1-100

The division point between the hot and warm sub-chains of the key cache buffer chain. The value is the percentage of the buffer chain to use for the warm sub-chain. Allowable values range from 1 to 100. The default value is 100. See [Section 7.4.5, “The MyISAM Key Cache”](#).

- `language`

<b>Command Line Format</b>	<code>--language=name</code>	
<b>Config File Format</b>	<code>language</code>	
<b>Option Sets Variable</b>	Yes, <code>language</code>	
<b>Variable Name</b>	<code>language</code>	
<b>Variable Scope</b>	Global	
<b>Dynamic Variable</b>	No	
<b>Value Set</b>	<b>Type</b>	filename
	<b>Default</b>	<code>/usr/local/mysql/share/mysql/english/</code>

The language used for error messages.

- `large_files_support`

<b>Variable Name</b>	<code>large_files_support</code>
<b>Variable Scope</b>	Global
<b>Dynamic Variable</b>	No

Whether `mysqld` was compiled with options for large file support.

- `large_pages`

<b>Command Line Format</b>	<code>--large-pages</code>
<b>Config File Format</b>	<code>large-pages</code>
<b>Option Sets Variable</b>	Yes, <code>large_pages</code>
<b>Variable Name</b>	<code>large_pages</code>
<b>Variable Scope</b>	Global
<b>Dynamic Variable</b>	No
<b>Platform Specific</b>	linux

<b>Value Set</b>	<b>Type</b> (linux)	boolean
	<b>Default</b>	FALSE

Whether large page support is enabled (via the `--large-pages` option). See [Section 7.5.9, “Enabling Large Page Support”](#).

- `large_page_size`

<b>Variable Name</b>	<code>large_page_size</code>	
<b>Variable Scope</b>	Global	
<b>Dynamic Variable</b>	No	
<b>Value Set</b>	<b>Type</b> (linux)	numeric
	<b>Default</b>	0

If large page support is enabled, this shows the size of memory pages. Currently, large memory pages are supported only on Linux; on other platforms, the value of this variable is always 0. See [Section 7.5.9, “Enabling Large Page Support”](#).

- `lc_time_names`

<b>Version Introduced</b>	5.1.12	
<b>Variable Name</b>	<code>lc_time_names</code>	
<b>Variable Scope</b>	Both	
<b>Dynamic Variable</b>	Yes	
<b>Value Set</b>	<b>Type</b>	string
	<b>Default</b>	

This variable specifies the locale that controls the language used to display day and month names and abbreviations. This variable affects the output from the `DATE_FORMAT()`, `DAYNAME()` and `MONTHNAME()` functions. Locale names are POSIX-style values such as `'ja_JP'` or `'pt_BR'`. The default value is `'en_US'` regardless of your system's locale setting. For further information, see [Section 9.8, “MySQL Server Locale Support”](#). This variable was added in MySQL 5.1.12.

- `license`

<b>Variable Name</b>	<code>license</code>	
<b>Variable Scope</b>	Global	
<b>Dynamic Variable</b>	No	
<b>Value Set</b>	<b>Type</b>	string
	<b>Default</b>	GPL

The type of license the server has.

- `local_infile`

<b>Variable Name</b>	<code>local_infile</code>	
<b>Variable Scope</b>	Global	
<b>Dynamic Variable</b>	Yes	
<b>Value Set</b>	<b>Type</b>	
	<b>Default</b>	

Whether `LOCAL` is supported for `LOAD DATA INFILE` statements. See [Section 5.3.4, “Security Issues with LOAD DATA LOCAL”](#).

- `locked_in_memory`

<b>Variable Name</b>	<code>locked_in_memory</code>	
<b>Variable Scope</b>	Global	

<b>Dynamic Variable</b>	No
-------------------------	----

Whether `mysqld` was locked in memory with `--memlock`.

- `log`

Whether logging of all statements to the general query log is enabled. See [Section 5.2.3, “The General Query Log”](#).

This variable is deprecated as of MySQL 5.1.29; use `general_log` instead.

- `log_bin`

<b>Variable Name</b>	<code>log_bin</code>
<b>Variable Scope</b>	Global
<b>Dynamic Variable</b>	No

Whether the binary log is enabled. See [Section 5.2.4, “The Binary Log”](#).

- `log_bin_trust_function_creators`

<b>Command Line Format</b>	<code>--log-bin-trust-function-creators</code>	
<b>Config File Format</b>	<code>log-bin-trust-function-creators</code>	
<b>Option Sets Variable</b>	Yes, <code>log_bin_trust_function_creators</code>	
<b>Variable Name</b>	<code>log_bin_trust_function_creators</code>	
<b>Variable Scope</b>	Global	
<b>Dynamic Variable</b>	Yes	
<b>Value Set</b>	<b>Type</b>	<code>boolean</code>
	<b>Default</b>	<code>FALSE</code>

This variable applies when binary logging is enabled. It controls whether stored function creators can be trusted not to create stored functions that will cause unsafe events to be written to the binary log. If set to 0 (the default), users are not allowed to create or alter stored functions unless they have the `SUPER` privilege in addition to the `CREATE ROUTINE` or `ALTER ROUTINE` privilege. A setting of 0 also enforces the restriction that a function must be declared with the `DETERMINISTIC` characteristic, or with the `READS SQL DATA` or `NO SQL` characteristic. If the variable is set to 1, MySQL does not enforce these restrictions on stored function creation. This variable also applies to trigger creation. See [Section 18.6, “Binary Logging of Stored Programs”](#).

- `log_error`

<b>Command Line Format</b>	<code>--log-error[=name]</code>	
<b>Config File Format</b>	<code>log-error</code>	
<b>Option Sets Variable</b>	Yes, <code>log_error</code>	
<b>Variable Name</b>	<code>log_error</code>	
<b>Variable Scope</b>	Global	
<b>Dynamic Variable</b>	No	
<b>Value Set</b>	<b>Type</b>	<code>filename</code>

The location of the error log.

- `log_output`

<b>Version Introduced</b>	5.1.6
<b>Command Line Format</b>	<code>--log-output[=name]</code>
<b>Config File Format</b>	<code>log-output</code>
<b>Option Sets Variable</b>	Yes, <code>log_output</code>



<b>Variable Name</b>	<code>log_output</code>	
<b>Variable Scope</b>	Global	
<b>Dynamic Variable</b>	Yes	
<b>Value Set</b>	<b>Type</b>	enumeration
	<b>Default</b>	FILE
	<b>Valid Values</b>	TABLE, FILE, NONE

The destination for general query log and slow query log output. The value can be a comma-separated list of one or more of the words `TABLE` (log to tables), `FILE` (log to files), or `NONE` (do not log to tables or files). The default value is `TABLE`. `NONE`, if present, takes precedence over any other specifiers. If the value is `NONE` log entries are not written even if the logs are enabled. If the logs are not enabled, no logging occurs even if the value of `log_output` is not `NONE`. For more information, see [Section 5.2.1, “Selecting General Query and Slow Query Log Output Destinations”](#). This variable was added in MySQL 5.1.6.

- `log_queries_not_using_indexes`

<b>Version Deprecated</b>	5.1.29	
<b>Command Line Format</b>	<code>--log-queries-not-using-indexes</code>	
<b>Config File Format</b>	<code>log-queries-not-using-indexes</code>	
<b>Option Sets Variable</b>	Yes, <code>log_queries_not_using_indexes</code>	
<b>Variable Name</b>	<code>log_queries_not_using_indexes</code>	
<b>Variable Scope</b>	Global	
<b>Dynamic Variable</b>	Yes	
<b>Deprecated</b>	5.1.29, by <code>slow-query-log</code>	
<b>Value Set</b>	<b>Type</b>	boolean

Whether queries that do not use indexes are logged to the slow query log. See [Section 5.2.5, “The Slow Query Log”](#). This variable was added in MySQL 5.1.11.

- `log_slave_updates`

Whether updates received by a slave server from a master server should be logged to the slave's own binary log. Binary logging must be enabled on the slave for this variable to have any effect. See [Section 16.1.3, “Replication and Binary Logging Options and Variables”](#).

- `log_slow_queries`

<b>Command Line Format</b>	<code>--log-slow-queries[=name]</code>	
<b>Config File Format</b>	<code>log-slow-queries</code>	
<b>Option Sets Variable</b>	Yes, <code>log_slow_queries</code>	
<b>Variable Name</b>	<code>log_slow_queries</code>	
<b>Variable Scope</b>	Global	
<b>Dynamic Variable</b>	Yes	
<b>Value Set</b>	<b>Type</b>	boolean

Whether slow queries should be logged. “Slow” is determined by the value of the `long_query_time` variable. See [Section 5.2.5, “The Slow Query Log”](#).

This variable is deprecated as of MySQL 5.1.29; use `slow_query_log` instead.

- `log_warnings`

<b>Command Line Format</b>	<code>--log-warnings[=#]</code>	
<b>Config File Format</b>	<code>log-warnings</code>	
<b>Option Sets Variable</b>	Yes, <code>log_warnings</code>	

<b>Variable Name</b>	log_warnings	
<b>Variable Scope</b>	Both	
<b>Dynamic Variable</b>	Yes	
<b>Disabled by</b>	skip-log-warnings	
<b>Value Set</b>	<b>Platform Bit Size</b>	32
	<b>Type</b>	numeric
	<b>Default</b>	1
	<b>Range</b>	0-18446744073709547520

Whether to produce additional warning messages. It is enabled (1) by default and can be disabled by setting it to 0. Aborted connections are not logged to the error log unless the value is greater than 1.

- [long\\_query\\_time](#)

<b>Command Line Format</b>	--long_query_time=#	
<b>Config File Format</b>	long_query_time	
<b>Option Sets Variable</b>	Yes, long_query_time	
<b>Variable Name</b>	long_query_time	
<b>Variable Scope</b>	Both	
<b>Dynamic Variable</b>	Yes	
<b>Value Set (&gt;= 5.1.21)</b>	<b>Type</b>	numeric
	<b>Default</b>	10
	<b>Min Value</b>	0

If a query takes longer than this many seconds, the server increments the [Slow\\_queries](#) status variable. If the slow query log is enabled, the query is logged to the slow query log file. This value is measured in real time, not CPU time, so a query that is under the threshold on a lightly loaded system might be above the threshold on a heavily loaded one. Prior to MySQL 5.1.21, the minimum value is 1, and the value for this variable must be an integer. Beginning with MySQL 5.1.21, the minimum is 0, and a resolution of microseconds is supported when logging to a file. However, the microseconds part is ignored and only integer values are written when logging to tables. The default value is 10. See [Section 5.2.5, “The Slow Query Log”](#).

- [low\\_priority\\_updates](#)

<b>Command Line Format</b>	--low-priority-updates	
<b>Config File Format</b>	low-priority-updates	
<b>Option Sets Variable</b>	Yes, low_priority_updates	
<b>Variable Name</b>	low_priority_updates	
<b>Variable Scope</b>	Both	
<b>Dynamic Variable</b>	Yes	
<b>Value Set</b>	<b>Type</b>	boolean
	<b>Default</b>	FALSE

If set to 1, all [INSERT](#), [UPDATE](#), [DELETE](#), and [LOCK TABLE WRITE](#) statements wait until there is no pending [SELECT](#) or [LOCK TABLE READ](#) on the affected table. This affects only storage engines that use only table-level locking ([MyISAM](#), [MEMORY](#), [MERGE](#)). This variable previously was named [sql\\_low\\_priority\\_updates](#).

- [lower\\_case\\_file\\_system](#)

<b>Command Line Format</b>	--lower_case_file_system[=#]	
<b>Config File Format</b>	lower_case_file_system	
<b>Option Sets Variable</b>	Yes, lower_case_file_system	
<b>Variable Name</b>	lower_case_file_system	

<b>Variable Scope</b>	Global	
<b>Dynamic Variable</b>	No	
<b>Value Set</b>	<b>Type</b>	boolean

This variable describes the case sensitivity of file names on the file system where the data directory is located. `OFF` means file names are case sensitive, `ON` means they are not case sensitive.

- `lower_case_table_names`

<b>Command Line Format</b>	<code>--lower_case_table_names[=#]</code>	
<b>Config File Format</b>	<code>lower_case_table_names</code>	
<b>Option Sets Variable</b>	Yes, <code>lower_case_table_names</code>	
<b>Variable Name</b>	<code>lower_case_table_names</code>	
<b>Variable Scope</b>	Global	
<b>Dynamic Variable</b>	No	
<b>Value Set</b>	<b>Type</b>	numeric
	<b>Default</b>	0
	<b>Range</b>	0-2

If set to 1, table names are stored in lowercase on disk and table name comparisons are not case sensitive. If set to 2 table names are stored as given but compared in lowercase. This option also applies to database names and table aliases. See [Section 8.2.2, “Identifier Case Sensitivity”](#).

If you are using `InnoDB` tables, you should set this variable to 1 on all platforms to force names to be converted to lowercase.

You should *not* set this variable to 0 if you are running MySQL on a system that does not have case-sensitive file names (such as Windows or Mac OS X). If this variable is not set at startup and the file system on which the data directory is located does not have case-sensitive file names, MySQL automatically sets `lower_case_table_names` to 2.

- `max_allowed_packet`

<b>Command Line Format</b>	<code>--max_allowed_packet=#</code>	
<b>Config File Format</b>	<code>max_allowed_packet</code>	
<b>Option Sets Variable</b>	Yes, <code>max_allowed_packet</code>	
<b>Variable Name</b>	<code>max_allowed_packet</code>	
<b>Variable Scope</b>	Both	
<b>Dynamic Variable</b>	Yes	
<b>Value Set</b>	<b>Type</b>	numeric
	<b>Default</b>	1048576
	<b>Range</b>	1024-1073741824

The maximum size of one packet or any generated/intermediate string.

The packet message buffer is initialized to `net_buffer_length` bytes, but can grow up to `max_allowed_packet` bytes when needed. This value by default is small, to catch large (possibly incorrect) packets.

You must increase this value if you are using large `BLOB` columns or long strings. It should be as big as the largest `BLOB` you want to use. The protocol limit for `max_allowed_packet` is 1GB. The value should be a multiple of 1024; non-multiples are rounded down to the nearest multiple.

When you change the message buffer size by changing the value of the `max_allowed_packet` variable, you should also change the buffer size on the client side if your client program allows it. On the client side, `max_allowed_packet` has a default of 1GB. Some programs such as `mysql` and `mysqldump` enable you to change the client-side value by setting `max_allowed_packet` on the command line or in an option file.

As of MySQL 5.1.31, the session value of this variable is read only. Before 5.1.31, setting the session value is allowed but has

no effect.

- `max_connect_errors`

<b>Command Line Format</b>	<code>--max_connect_errors=#</code>	
<b>Config File Format</b>	<code>max_connect_errors</code>	
<b>Option Sets Variable</b>	Yes, <code>max_connect_errors</code>	
<b>Variable Name</b>	<code>max_connect_errors</code>	
<b>Variable Scope</b>	Global	
<b>Dynamic Variable</b>	Yes	
<b>Value Set</b>	<b>Platform Bit Size</b>	32
	<b>Type</b>	numeric
	<b>Default</b>	10
	<b>Range</b>	1-4294967295
<b>Value Set</b>	<b>Platform Bit Size</b>	64
	<b>Type</b>	numeric
	<b>Default</b>	10
	<b>Range</b>	1-18446744073709547520

If there are more than this number of interrupted connections from a host, that host is blocked from further connections. You can unblock blocked hosts with the `FLUSH HOSTS` statement.

- `max_connections`

<b>Command Line Format</b>	<code>--max_connections=#</code>	
<b>Config File Format</b>	<code>max_connections</code>	
<b>Option Sets Variable</b>	Yes, <code>max_connections</code>	
<b>Variable Name</b>	<code>max_connections</code>	
<b>Variable Scope</b>	Global	
<b>Dynamic Variable</b>	Yes	
<b>Value Set (&lt;= 5.1.14)</b>	<b>Type</b>	numeric
	<b>Default</b>	100
<b>Value Set (&gt;= 5.1.15)</b>	<b>Type</b>	numeric
	<b>Default</b>	151
	<b>Range</b>	1-16384
<b>Value Set (&gt;= 5.1.17)</b>	<b>Type</b>	numeric
	<b>Default</b>	151
	<b>Range</b>	1-100000

The number of simultaneous client connections allowed. By default, this is 151, beginning with MySQL 5.1.15. (Previously, the default was 100.) See [Section B.1.2.7, “Too many connections”](#), for more information.

#### MySQL Enterprise

For notification that the maximum number of connections is getting dangerously high and for advice on setting the optimum value for `max_connections` subscribe to the MySQL Enterprise Monitor. For more information, see <http://www.mysql.com/products/enterprise/advisors.html>.

Increasing this value increases the number of file descriptors that `mysqld` requires. See [Section 7.4.7, “How MySQL Opens and Closes Tables”](#), for comments on file descriptor limits.

- `max_delayed_threads`

<b>Command Line Format</b>	<code>--max_delayed_threads=#</code>
----------------------------	--------------------------------------

<b>Config File Format</b>	<code>max_delayed_threads</code>	
<b>Option Sets Variable</b>	Yes, <code>max_delayed_threads</code>	
<b>Variable Name</b>	<code>max_delayed_threads</code>	
<b>Variable Scope</b>	Both	
<b>Dynamic Variable</b>	Yes	
<b>Value Set</b>	<b>Type</b>	numeric
	<b>Default</b>	20
	<b>Range</b>	0-16384

Do not start more than this number of threads to handle `INSERT DELAYED` statements. If you try to insert data into a new table after all `INSERT DELAYED` threads are in use, the row is inserted as if the `DELAYED` attribute wasn't specified. If you set this to 0, MySQL never creates a thread to handle `DELAYED` rows; in effect, this disables `DELAYED` entirely.

For the `SESSION` value of this variable, the only valid values are 0 or the `GLOBAL` value.

- `max_error_count`

<b>Command Line Format</b>	<code>--max_error_count=#</code>	
<b>Config File Format</b>	<code>max_error_count</code>	
<b>Option Sets Variable</b>	Yes, <code>max_error_count</code>	
<b>Variable Name</b>	<code>max_error_count</code>	
<b>Variable Scope</b>	Both	
<b>Dynamic Variable</b>	Yes	
<b>Value Set</b>	<b>Type</b>	numeric
	<b>Default</b>	64
	<b>Range</b>	0-65535

The maximum number of error, warning, and note messages to be stored for display by the `SHOW ERRORS` and `SHOW WARNINGS` statements.

- `max_heap_table_size`

<b>Command Line Format</b>	<code>--max_heap_table_size=#</code>	
<b>Config File Format</b>	<code>max_heap_table_size</code>	
<b>Option Sets Variable</b>	Yes, <code>max_heap_table_size</code>	
<b>Variable Name</b>	<code>max_heap_table_size</code>	
<b>Variable Scope</b>	Both	
<b>Dynamic Variable</b>	Yes	
<b>Value Set</b>	<b>Type</b>	numeric
	<b>Default</b>	16777216
	<b>Range</b>	16384-4294967295

This variable sets the maximum size to which `MEMORY` tables are allowed to grow. The value of the variable is used to calculate `MEMORY` table `MAX_ROWS` values. Setting this variable has no effect on any existing `MEMORY` table, unless the table is re-created with a statement such as `CREATE TABLE` or altered with `ALTER TABLE` or `TRUNCATE TABLE`. A server restart also sets the maximum size of existing `MEMORY` tables to the global `max_heap_table_size` value.

### Note

On 64-bit platforms, the maximum value for this variable is 1844674407370954752.

**MySQL Enterprise**  
Subscribers to the MySQL Enterprise Monitor receive recommendations for the optimum setting for

`max_heap_table_size`. For more information, see <http://www.mysql.com/products/enterprise/advisors.html>.

- `max_insert_delayed_threads`

<b>Variable Name</b>	<code>max_insert_delayed_threads</code>	
<b>Variable Scope</b>	Both	
<b>Dynamic Variable</b>	Yes	
<b>Value Set</b>	<b>Type</b>	numeric

This variable is a synonym for `max_delayed_threads`.

- `max_join_size`

<b>Command Line Format</b>	<code>--max_join_size=#</code>	
<b>Config File Format</b>	<code>max_join_size</code>	
<b>Option Sets Variable</b>	Yes, <code>max_join_size</code>	
<b>Variable Name</b>	<code>max_join_size</code>	
<b>Variable Scope</b>	Both	
<b>Dynamic Variable</b>	Yes	
<b>Value Set</b>	<b>Type</b>	numeric
	<b>Default</b>	4294967295
	<b>Range</b>	1-4294967295

Do not allow `SELECT` statements that probably need to examine more than `max_join_size` rows (for single-table statements) or row combinations (for multiple-table statements) or that are likely to do more than `max_join_size` disk seeks. By setting this value, you can catch `SELECT` statements where keys are not used properly and that would probably take a long time. Set it if your users tend to perform joins that lack a `WHERE` clause, that take a long time, or that return millions of rows.

Setting this variable to a value other than `DEFAULT` resets the value of `sql_big_selects` to 0. If you set the `sql_big_selects` value again, the `max_join_size` variable is ignored.

If a query result is in the query cache, no result size check is performed, because the result has previously been computed and it does not burden the server to send it to the client.

This variable previously was named `sql_max_join_size`.

- `max_length_for_sort_data`

<b>Command Line Format</b>	<code>--max_length_for_sort_data=#</code>	
<b>Config File Format</b>	<code>max_length_for_sort_data</code>	
<b>Option Sets Variable</b>	Yes, <code>max_length_for_sort_data</code>	
<b>Variable Name</b>	<code>max_length_for_sort_data</code>	
<b>Variable Scope</b>	Both	
<b>Dynamic Variable</b>	Yes	
<b>Value Set</b>	<b>Type</b>	numeric
	<b>Default</b>	1024
	<b>Range</b>	4-8388608

The cutoff on the size of index values that determines which `filesort` algorithm to use. See [Section 7.2.13, “ORDER BY Optimization”](#).

- `max_prepared_stmt_count`

<b>Version Introduced</b>	5.1.10	
<b>Command Line Format</b>	<code>--max_prepared_stmt_count=#</code>	5.0.21

<b>Config File Format</b>	<code>max_prepared_stmt_count</code>	5.0.21
<b>Option Sets Variable</b>	Yes, <code>max_prepared_stmt_count</code>	
<b>Variable Name</b>	<code>max_prepared_stmt_count</code>	
<b>Variable Scope</b>	Global	
<b>Dynamic Variable</b>	Yes	
<b>Value Set</b>	<b>Type</b>	numeric
	<b>Default</b>	16382
	<b>Range</b>	0-1048576

This variable limits the total number of prepared statements in the server. It can be used in environments where there is the potential for denial-of-service attacks based on running the server out of memory by preparing huge numbers of statements. If the value is set lower than the current number of prepared statements, existing statements are not affected and can be used, but no new statements can be prepared until the current number drops below the limit. The default value is 16,382. The allowable range of values is from 0 to 1 million. Setting the value to 0 disables prepared statements. This variable was added in MySQL 5.1.10.

- `max_relay_log_size`

<b>Command Line Format</b>	<code>--max_relay_log_size=#</code>	
<b>Config File Format</b>	<code>max_relay_log_size</code>	
<b>Option Sets Variable</b>	Yes, <code>max_relay_log_size</code>	
<b>Variable Name</b>	<code>max_relay_log_size</code>	
<b>Variable Scope</b>	Global	
<b>Dynamic Variable</b>	Yes	
<b>Value Set</b>	<b>Type</b>	numeric
	<b>Default</b>	0
	<b>Range</b>	0-1073741824

If a write by a replication slave to its relay log causes the current log file size to exceed the value of this variable, the slave rotates the relay logs (closes the current file and opens the next one). If `max_relay_log_size` is 0, the server uses `max_binlog_size` for both the binary log and the relay log. If `max_relay_log_size` is greater than 0, it constrains the size of the relay log, which enables you to have different sizes for the two logs. You must set `max_relay_log_size` to between 4096 bytes and 1GB (inclusive), or to 0. The default value is 0. See [Section 16.4.1, “Replication Implementation Details”](#).

- `max_seeks_for_key`

<b>Command Line Format</b>	<code>--max_seeks_for_key=#</code>	
<b>Config File Format</b>	<code>max_seeks_for_key</code>	
<b>Option Sets Variable</b>	Yes, <code>max_seeks_for_key</code>	
<b>Variable Name</b>	<code>max_seeks_for_key</code>	
<b>Variable Scope</b>	Both	
<b>Dynamic Variable</b>	Yes	
<b>Value Set</b>	<b>Platform Bit Size</b>	32
	<b>Type</b>	numeric
	<b>Default</b>	4294967295
	<b>Range</b>	1-4294967295
<b>Value Set</b>	<b>Platform Bit Size</b>	64
	<b>Type</b>	numeric
	<b>Default</b>	18446744073709547520
	<b>Range</b>	1-18446744073709547520

Limit the assumed maximum number of seeks when looking up rows based on a key. The MySQL optimizer assumes that no more than this number of key seeks are required when searching for matching rows in a table by scanning an index, regardless of the actual cardinality of the index (see [Section 12.5.5.23](#), “`SHOW INDEX Syntax`”). By setting this to a low value (say, 100), you can force MySQL to prefer indexes instead of table scans.

- `max_sort_length`

<b>Command Line Format</b>	<code>--max_sort_length=#</code>	
<b>Config File Format</b>	<code>max_sort_length</code>	
<b>Option Sets Variable</b>	Yes, <code>max_sort_length</code>	
<b>Variable Name</b>	<code>max_sort_length</code>	
<b>Variable Scope</b>	Both	
<b>Dynamic Variable</b>	Yes	
<b>Value Set</b>	<b>Type</b>	numeric
	<b>Default</b>	1024
	<b>Range</b>	4-8388608

The number of bytes to use when sorting `BLOB` or `TEXT` values. Only the first `max_sort_length` bytes of each value are used; the rest are ignored.

- `max_sp_recursion_depth`

<b>Command Line Format</b>	<code>--max_sp_recursion_depth[=#]</code>	
<b>Config File Format</b>	<code>max_sp_recursion_depth</code>	
<b>Option Sets Variable</b>	Yes, <code>max_sp_recursion_depth</code>	
<b>Variable Name</b>	<code>max_sp_recursion_depth</code>	
<b>Variable Scope</b>	Both	
<b>Dynamic Variable</b>	Yes	
<b>Value Set</b>	<b>Type</b>	numeric
	<b>Default</b>	0
	<b>Max Value</b>	255

The number of times that any given stored procedure may be called recursively. The default value for this option is 0, which completely disallows recursion in stored procedures. The maximum value is 255.

Stored procedure recursion increases the demand on thread stack space. If you increase the value of `max_sp_recursion_depth`, it may be necessary to increase thread stack size by increasing the value of `thread_stack` at server startup.

- `max_tmp_tables`

<b>Command Line Format</b>	<code>--max_tmp_tables=#</code>	
<b>Config File Format</b>	<code>max_tmp_tables</code>	
<b>Option Sets Variable</b>	Yes, <code>max_tmp_tables</code>	
<b>Variable Name</b>	<code>max_tmp_tables</code>	
<b>Variable Scope</b>	Both	
<b>Dynamic Variable</b>	Yes	
<b>Value Set</b>	<b>Platform Bit Size</b>	32
	<b>Type</b>	numeric
	<b>Default</b>	32
	<b>Range</b>	1-4294967295
<b>Value Set</b>	<b>Platform Bit Size</b>	64
	<b>Type</b>	numeric



	<b>Default</b>	32
	<b>Range</b>	1-18446744073709547520

The maximum number of temporary tables a client can keep open at the same time. (This option does not yet do anything.)

- `max_user_connections`

<b>Command Line Format</b>	<code>--max_user_connections=#</code>	
<b>Config File Format</b>	<code>max_user_connections</code>	
<b>Option Sets Variable</b>	Yes, <code>max_user_connections</code>	
<b>Variable Name</b>	<code>max_user_connections</code>	
<b>Variable Scope</b>	Both	
<b>Dynamic Variable</b>	Yes	
<b>Value Set</b>	<b>Type</b>	numeric
	<b>Range</b>	1-4294967295

The maximum number of simultaneous connections allowed to any given MySQL account. A value of 0 means “no limit.”

This variable has both a global scope and a (read-only) session scope. The session variable has the same value as the global variable unless the current account has a nonzero `MAX_USER_CONNECTIONS` resource limit. In that case, the session value reflects the account limit.

- `max_write_lock_count`

<b>Command Line Format</b>	<code>--max_write_lock_count=#</code>	
<b>Config File Format</b>	<code>max_write_lock_count</code>	
<b>Option Sets Variable</b>	Yes, <code>max_write_lock_count</code>	
<b>Variable Name</b>	<code>max_write_lock_count</code>	
<b>Variable Scope</b>	Global	
<b>Dynamic Variable</b>	Yes	
<b>Value Set</b>	<b>Platform Bit Size</b>	32
	<b>Type</b>	numeric
	<b>Default</b>	4294967295
	<b>Range</b>	1-4294967295
<b>Value Set</b>	<b>Platform Bit Size</b>	64
	<b>Type</b>	numeric
	<b>Default</b>	18446744073709547520
	<b>Range</b>	1-18446744073709547520

After this many write locks, allow some pending read lock requests to be processed in between.

- `min_examined_row_limit`

<b>Version Introduced</b>	5.1.21	
<b>Command Line Format</b>	<code>--min-examined-row-limit=#</code>	
<b>Config File Format</b>	<code>min-examined-row-limit</code>	
<b>Variable Name</b>	<code>min_examined_row_limit</code>	
<b>Variable Scope</b>	Both	
<b>Dynamic Variable</b>	Yes	
<b>Value Set</b>	<b>Platform Bit Size</b>	32
	<b>Type</b>	numeric

	<b>Default</b>	0
	<b>Range</b>	0-4294967295
<b>Value Set</b>	<b>Platform Bit Size</b>	64
	<b>Type</b>	numeric
	<b>Default</b>	0
	<b>Range</b>	0-18446744073709547520

Queries that examine fewer than this number of rows are not logged to the slow query log. This variable was added in MySQL 5.1.21.

- `myisam_data_pointer_size`

<b>Command Line Format</b>	<code>--myisam_data_pointer_size=#</code>	
<b>Config File Format</b>	<code>myisam_data_pointer_size</code>	
<b>Option Sets Variable</b>	Yes, <code>myisam_data_pointer_size</code>	
<b>Variable Name</b>	<code>myisam_data_pointer_size</code>	
<b>Variable Scope</b>	Global	
<b>Dynamic Variable</b>	Yes	
<b>Value Set</b>	<b>Type</b>	numeric
	<b>Default</b>	6
	<b>Range</b>	2-7

The default pointer size in bytes, to be used by `CREATE TABLE` for MyISAM tables when no `MAX_ROWS` option is specified. This variable cannot be less than 2 or larger than 7. The default value is 6. See [Section B.1.2.12, “The table is full”](#).

- `myisam_max_sort_file_size`

<b>Command Line Format</b>	<code>--myisam_max_sort_file_size=#</code>	
<b>Config File Format</b>	<code>myisam_max_sort_file_size</code>	
<b>Option Sets Variable</b>	Yes, <code>myisam_max_sort_file_size</code>	
<b>Variable Name</b>	<code>myisam_max_sort_file_size</code>	
<b>Variable Scope</b>	Global	
<b>Dynamic Variable</b>	Yes	
<b>Value Set</b>	<b>Type</b>	numeric
	<b>Default</b>	2147483648

The maximum size of the temporary file that MySQL is allowed to use while re-creating a MyISAM index (during `REPAIR TABLE`, `ALTER TABLE`, or `LOAD DATA INFILE`). If the file size would be larger than this value, the index is created using the key cache instead, which is slower. The value is given in bytes.

The default value is 2GB. If MyISAM index files exceed this size and disk space is available, increasing the value may help performance.

- `myisam_recover_options`

<b>Variable Name</b>	<code>myisam_recover_options</code>
<b>Variable Scope</b>	Global
<b>Dynamic Variable</b>	No

The value of the `--myisam-recover` option. See [Section 5.1.2, “Server Command Options”](#).

- `myisam_repair_threads`

<b>Command Line Format</b>	<code>--myisam_repair_threads=#</code>	
<b>Config File Format</b>	<code>myisam_repair_threads</code>	
<b>Option Sets Variable</b>	Yes, <code>myisam_repair_threads</code>	
<b>Variable Name</b>	<code>myisam_repair_threads</code>	
<b>Variable Scope</b>	Both	
<b>Dynamic Variable</b>	Yes	
<b>Value Set</b>	<b>Platform Bit Size</b>	32
	<b>Type</b>	numeric
	<b>Default</b>	1
	<b>Range</b>	1-4294967295
<b>Value Set</b>	<b>Platform Bit Size</b>	64
	<b>Type</b>	numeric
	<b>Default</b>	1
	<b>Range</b>	1-18446744073709547520

If this value is greater than 1, **MyISAM** table indexes are created in parallel (each index in its own thread) during the **Repair by sorting** process. The default value is 1.

### Note

Multi-threaded repair is still *beta-quality* code.

- `myisam_sort_buffer_size`

<b>Command Line Format</b>	<code>--myisam_sort_buffer_size=#</code>	
<b>Config File Format</b>	<code>myisam_sort_buffer_size</code>	
<b>Option Sets Variable</b>	Yes, <code>myisam_sort_buffer_size</code>	
<b>Variable Name</b>	<code>myisam_sort_buffer_size</code>	
<b>Variable Scope</b>	Both	
<b>Dynamic Variable</b>	Yes	
<b>Value Set</b>	<b>Platform Bit Size</b>	32
	<b>Type</b>	numeric
	<b>Default</b>	8388608
	<b>Range</b>	4-4294967295
<b>Value Set</b>	<b>Platform Bit Size</b>	64
	<b>Type</b>	numeric
	<b>Default</b>	8388608
	<b>Range</b>	4-18446744073709547520

The size of the buffer that is allocated when sorting **MyISAM** indexes during a **REPAIR TABLE** or when creating indexes with **CREATE INDEX** or **ALTER TABLE**.

The maximum allowable setting for `myisam_sort_buffer_size` is 4GB. As of MySQL 5.1.23, values larger than 4GB are allowed for 64-bit platforms (except 64-bit Windows, for which large values are truncated to 4GB with a warning).

- `myisam_stats_method`

<b>Command Line Format</b>	<code>--myisam_stats_method=name</code>
<b>Config File Format</b>	<code>myisam_stats_method</code>
<b>Option Sets Variable</b>	Yes, <code>myisam_stats_method</code>
<b>Variable Name</b>	<code>myisam_stats_method</code>

<b>Variable Scope</b>	Both	
<b>Dynamic Variable</b>	Yes	
<b>Value Set</b>	<b>Type</b>	enumeration
	<b>Valid Values</b>	nulls_equal, nulls_unequal, nulls_ignored

How the server treats `NULL` values when collecting statistics about the distribution of index values for `MyISAM` tables. This variable has three possible values, `nulls_equal`, `nulls_unequal`, and `nulls_ignored`. For `nulls_equal`, all `NULL` index values are considered equal and form a single value group that has a size equal to the number of `NULL` values. For `nulls_unequal`, `NULL` values are considered unequal, and each `NULL` forms a distinct value group of size 1. For `nulls_ignored`, `NULL` values are ignored.

The method that is used for generating table statistics influences how the optimizer chooses indexes for query execution, as described in [Section 7.4.6, “MyISAM Index Statistics Collection”](#).

Any unique prefix of a valid value may be used to set the value of this variable.

- `myisam_use_mmap`

<b>Version Introduced</b>	5.1.4	
<b>Command Line Format</b>	<code>--myisam_use_mmap</code>	
<b>Config File Format</b>	<code>myisam_use_mmap</code>	
<b>Option Sets Variable</b>	Yes, <code>myisam_use_mmap</code>	
<b>Variable Name</b>	<code>myisam_use_mmap</code>	
<b>Variable Scope</b>	Global	
<b>Dynamic Variable</b>	Yes	
<b>Value Set</b>	<b>Type</b>	boolean
	<b>Default</b>	<code>FALSE</code>

Use memory mapping for reading and writing `MyISAM` tables. This variable was added in MySQL 5.1.4.

- `named_pipe`

<b>Variable Name</b>	<code>named_pipe</code>
<b>Variable Scope</b>	Global
<b>Dynamic Variable</b>	No
<b>Platform Specific</b>	windows

(Windows only.) Indicates whether the server supports connections over named pipes.

- `net_buffer_length`

<b>Command Line Format</b>	<code>--net_buffer_length=#</code>	
<b>Config File Format</b>	<code>net_buffer_length</code>	
<b>Option Sets Variable</b>	Yes, <code>net_buffer_length</code>	
<b>Variable Name</b>	<code>net_buffer_length</code>	
<b>Variable Scope</b>	Both	
<b>Dynamic Variable</b>	Yes	
<b>Value Set</b>	<b>Type</b>	numeric
	<b>Default</b>	16384
	<b>Range</b>	1024-1048576

Each client thread is associated with a connection buffer and result buffer. Both begin with a size given by

`net_buffer_length` but are dynamically enlarged up to `max_allowed_packet` bytes as needed. The result buffer shrinks to `net_buffer_length` after each SQL statement.

This variable should not normally be changed, but if you have very little memory, you can set it to the expected length of statements sent by clients. If statements exceed this length, the connection buffer is automatically enlarged. The maximum value to which `net_buffer_length` can be set is 1MB.

As of MySQL 5.1.31, the session value of this variable is read only. Before 5.1.31, setting the session value is allowed but has no effect.

- `net_read_timeout`

<b>Command Line Format</b>	<code>--net_read_timeout=#</code>	
<b>Config File Format</b>	<code>net_read_timeout</code>	
<b>Option Sets Variable</b>	Yes, <code>net_read_timeout</code>	
<b>Variable Name</b>	<code>net_read_timeout</code>	
<b>Variable Scope</b>	Both	
<b>Dynamic Variable</b>	Yes	
<b>Value Set</b>	<b>Type</b>	numeric
	<b>Default</b>	30
	<b>Min Value</b>	1

The number of seconds to wait for more data from a connection before aborting the read. This timeout applies only to TCP/IP connections, not to connections made via Unix socket files, named pipes, or shared memory. When the server is reading from the client, `net_read_timeout` is the timeout value controlling when to abort. When the server is writing to the client, `net_write_timeout` is the timeout value controlling when to abort. See also `slave_net_timeout`.

- `net_retry_count`

<b>Command Line Format</b>	<code>--net_retry_count=#</code>	
<b>Config File Format</b>	<code>net_retry_count</code>	
<b>Option Sets Variable</b>	Yes, <code>net_retry_count</code>	
<b>Variable Name</b>	<code>net_retry_count</code>	
<b>Variable Scope</b>	Both	
<b>Dynamic Variable</b>	Yes	
<b>Value Set</b>	<b>Platform Bit Size</b>	32
	<b>Type</b>	numeric
	<b>Default</b>	10
	<b>Range</b>	1-4294967295
<b>Value Set</b>	<b>Platform Bit Size</b>	64
	<b>Type</b>	numeric
	<b>Default</b>	10
	<b>Range</b>	1-18446744073709547520

If a read on a communication port is interrupted, retry this many times before giving up. This value should be set quite high on FreeBSD because internal interrupts are sent to all threads.

- `net_write_timeout`

<b>Command Line Format</b>	<code>--net_write_timeout=#</code>
<b>Config File Format</b>	<code>net_write_timeout</code>
<b>Option Sets Variable</b>	Yes, <code>net_write_timeout</code>
<b>Variable Name</b>	<code>net_write_timeout</code>
<b>Variable Scope</b>	Both
<b>Dynamic Variable</b>	Yes

<b>Value Set</b>	<b>Type</b>	numeric
	<b>Default</b>	60
	<b>Min Value</b>	1

The number of seconds to wait for a block to be written to a connection before aborting the write. This timeout applies only to TCP/IP connections, not to connections made via Unix socket files, named pipes, or shared memory. See also [net\\_read\\_timeout](#).

- [new](#)

<b>Command Line Format</b>	--new	
<b>Config File Format</b>	new	
<b>Option Sets Variable</b>	Yes, <a href="#">new</a>	
<b>Variable Name</b>	<a href="#">new</a>	
<b>Variable Scope</b>	Both	
<b>Dynamic Variable</b>	Yes	
<b>Disabled by</b>	<a href="#">skip-new</a>	
<b>Value Set</b>	<b>Type</b>	boolean
	<b>Default</b>	FALSE

This variable was used in MySQL 4.0 to turn on some 4.1 behaviors, and is retained for backward compatibility. In MySQL 5.1, its value is always `OFF`.

- [old](#)

<b>Version Introduced</b>	5.1.18
<b>Command Line Format</b>	<a href="#">old</a>
<b>Config File Format</b>	<a href="#">old</a>
<b>Variable Name</b>	<a href="#">old</a>
<b>Variable Scope</b>	Global
<b>Dynamic Variable</b>	No

[old](#) is a compatibility variable. It is disabled by default, but can be enabled at startup to revert the server to behaviors present in older versions.

Currently, when [old](#) is enabled, it changes the default scope of index hints to that used prior to MySQL 5.1.17. That is, index hints with no `FOR` clause apply only to how indexes are used for row retrieval and not to resolution of `ORDER BY` or `GROUP BY` clauses. (See [Section 12.2.8.2, “Index Hint Syntax”](#).) Take care about enabling this in a replication setup. With statement-based binary logging, having different modes for the master and slaves might lead to replication errors.

This variable was added as `old_mode` in MySQL 5.1.17 and renamed to `old` in MySQL 5.1.18.

- [old\\_passwords](#)

<b>Command Line Format</b>	--old_passwords	
<b>Config File Format</b>	old_passwords	
<b>Option Sets Variable</b>	Yes, <a href="#">old_passwords</a>	
<b>Variable Name</b>	<a href="#">old_passwords</a>	
<b>Variable Scope</b>	Both	
<b>Dynamic Variable</b>	Yes	
<b>Value Set</b>	<b>Type</b>	boolean
	<b>Default</b>	FALSE

Whether the server should use pre-4.1-style passwords for MySQL user accounts. See [Section B.1.2.4, “Client does not support authentication protocol”](#).

- `one_shot`

This is not a variable, but it can be used when setting some variables. It is described in [Section 12.5.4, “SET Syntax”](#).

- `open_files_limit`

<b>Command Line Format</b>	<code>--open-files-limit=#</code>	
<b>Config File Format</b>	<code>open-files-limit</code>	
<b>Option Sets Variable</b>	Yes, <code>open_files_limit</code>	
<b>Variable Name</b>	<code>open_files_limit</code>	
<b>Variable Scope</b>	Global	
<b>Dynamic Variable</b>	No	
<b>Value Set</b>	<b>Type</b>	numeric
	<b>Default</b>	0
	<b>Range</b>	0-65535

The number of files that the operating system allows `mysqld` to open. This is the real value allowed by the system and might be different from the value you gave using the `--open-files-limit` option to `mysqld` or `mysqld_safe`. The value is 0 on systems where MySQL can't change the number of open files.

- `optimizer_prune_level`

<b>Command Line Format</b>	<code>--optimizer_prune_level[=#]</code>	
<b>Config File Format</b>	<code>optimizer_prune_level</code>	
<b>Option Sets Variable</b>	Yes, <code>optimizer_prune_level</code>	
<b>Variable Name</b>	<code>optimizer_prune_level</code>	
<b>Variable Scope</b>	Both	
<b>Dynamic Variable</b>	Yes	
<b>Value Set</b>	<b>Type</b>	boolean
	<b>Default</b>	1

Controls the heuristics applied during query optimization to prune less-promising partial plans from the optimizer search space. A value of 0 disables heuristics so that the optimizer performs an exhaustive search. A value of 1 causes the optimizer to prune plans based on the number of rows retrieved by intermediate plans.

- `optimizer_search_depth`

<b>Command Line Format</b>	<code>--optimizer_search_depth[=#]</code>	
<b>Config File Format</b>	<code>optimizer_search_depth</code>	
<b>Option Sets Variable</b>	Yes, <code>optimizer_search_depth</code>	
<b>Variable Name</b>	<code>optimizer_search_depth</code>	
<b>Variable Scope</b>	Both	
<b>Dynamic Variable</b>	Yes	
<b>Value Set</b>	<b>Type</b>	numeric
	<b>Default</b>	62

The maximum depth of search performed by the query optimizer. Values larger than the number of relations in a query result in better query plans, but take longer to generate an execution plan for a query. Values smaller than the number of relations in a query return an execution plan quicker, but the resulting plan may be far from being optimal. If set to 0, the system automatically picks a reasonable value. If set to the maximum number of tables used in a query plus 2, the optimizer switches to the algorithm used in MySQL 5.0.0 (and previous versions) for performing searches.

- `optimizer_switch`

<b>Version Introduced</b>	5.1.34	
<b>Command Line Format</b>	<code>--optimizer_switch=value</code>	
<b>Config File Format</b>	<code>optimizer_switch</code>	
<b>Option Sets Variable</b>	Yes, <code>optimizer_switch</code>	
<b>Variable Name</b>	<code>optimizer_switch</code>	
<b>Variable Scope</b>	Both	
<b>Dynamic Variable</b>	Yes	
<b>Value Set</b>	<b>Type</b>	set
	<b>Valid Values</b>	<code>index_merge={on off}, index_merge_intersection={on off}, index_merge_union={on off}, index_merge_sort_union={on off}</code>

The `optimizer_switch` system variable enables control over optimizer behaviors. The value of this variable is a set of flags, each of which has a value of `on` or `off` to indicate whether the corresponding optimizer behavior is enabled or disabled. This variable has global and session values and be changed at runtime. The global default can be set at server startup.

To see the current set of optimizer flags, select the variable value:

```
mysql> SELECT @@optimizer_switch\G
***** 1. row *****
@@optimizer_switch: index_merge=on,index_merge_union=on,
                    index_merge_sort_union=on,index_merge_intersection=on
```

For more information about the syntax of this variable and the optimizer behaviors that it controls, see [Section 7.2.18, “Using optimizer\\_switch to Control the Optimizer”](#).

- `pid_file`

<b>Command Line Format</b>	<code>--pid-file=name</code>	
<b>Config File Format</b>	<code>pid-file</code>	
<b>Option Sets Variable</b>	Yes, <code>pid_file</code>	
<b>Variable Name</b>	<code>pid_file</code>	
<b>Variable Scope</b>	Global	
<b>Dynamic Variable</b>	No	
<b>Value Set</b>	<b>Type</b>	filename

The path name of the process ID (PID) file. This variable can be set with the `--pid-file` option.

- `plugin_dir`

<b>Version Introduced</b>	5.1.2	
<b>Command Line Format</b>	<code>--plugin_dir=name</code>	
<b>Config File Format</b>	<code>plugin_dir</code>	
<b>Option Sets Variable</b>	Yes, <code>plugin_dir</code>	
<b>Variable Name</b>	<code>plugin_dir</code>	
<b>Variable Scope</b>	Global	
<b>Dynamic Variable</b>	No	
<b>Value Set</b>	<b>Type</b>	filename
	<b>Default</b>	<code>/usr/local/mysql/lib/mysql</code>

The path name of the plugin directory. This variable was added in MySQL 5.1.2.



- `port`

<b>Command Line Format</b>	<code>--port=#</code>	
<b>Config File Format</b>	<code>port</code>	
<b>Option Sets Variable</b>	Yes, <code>port</code>	
<b>Variable Name</b>	<code>port</code>	
<b>Variable Scope</b>	Global	
<b>Dynamic Variable</b>	No	
<b>Value Set</b>	<b>Type</b>	<code>numeric</code>
	<b>Default</b>	<code>3306</code>

The number of the port on which the server listens for TCP/IP connections. This variable can be set with the `--port` option.

- `preload_buffer_size`

<b>Command Line Format</b>	<code>--preload_buffer_size=#</code>	
<b>Config File Format</b>	<code>preload_buffer_size</code>	
<b>Option Sets Variable</b>	Yes, <code>preload_buffer_size</code>	
<b>Variable Name</b>	<code>preload_buffer_size</code>	
<b>Variable Scope</b>	Both	
<b>Dynamic Variable</b>	Yes	
<b>Value Set</b>	<b>Type</b>	<code>numeric</code>
	<b>Default</b>	<code>32768</code>
	<b>Range</b>	<code>1024-1073741824</code>

The size of the buffer that is allocated when preloading indexes.

- `prepared_stmt_count`

The current number of prepared statements. (The maximum number of statements is given by the `max_prepared_stmt_count` system variable.) This variable was added in MySQL 5.1.10. In MySQL 5.1.14, it was converted to the global `Prepared_stmt_count` status variable.

- `protocol_version`

<b>Variable Name</b>	<code>protocol_version</code>	
<b>Variable Scope</b>	Global	
<b>Dynamic Variable</b>	No	
<b>Value Set</b>	<b>Type</b>	<code>numeric</code>

The version of the client/server protocol used by the MySQL server.

- `query_alloc_block_size`

<b>Command Line Format</b>	<code>--query_alloc_block_size=#</code>	
<b>Config File Format</b>	<code>query_alloc_block_size</code>	
<b>Option Sets Variable</b>	Yes, <code>query_alloc_block_size</code>	
<b>Variable Name</b>	<code>query_alloc_block_size</code>	
<b>Variable Scope</b>	Both	
<b>Dynamic Variable</b>	Yes	
<b>Value Set</b>	<b>Platform Bit Size</b>	<code>32</code>
	<b>Type</b>	<code>numeric</code>
	<b>Default</b>	<code>8192</code>

	<b>Range</b>	1024-4294967295
<b>Value Set</b>	<b>Platform Bit Size</b>	64
	<b>Type</b>	numeric
	<b>Default</b>	8192
	<b>Range</b>	1024-18446744073709547520

The allocation size of memory blocks that are allocated for objects created during statement parsing and execution. If you have problems with memory fragmentation, it might help to increase this a bit.

- `query_cache_limit`

<b>Command Line Format</b>	<code>--query_cache_limit=#</code>	
<b>Config File Format</b>	<code>query_cache_limit</code>	
<b>Option Sets Variable</b>	Yes, <code>query_cache_limit</code>	
<b>Variable Name</b>	<code>query_cache_limit</code>	
<b>Variable Scope</b>	Global	
<b>Dynamic Variable</b>	Yes	
<b>Value Set</b>	<b>Platform Bit Size</b>	32
	<b>Type</b>	numeric
	<b>Default</b>	1048576
	<b>Range</b>	0-4294967295
<b>Value Set</b>	<b>Platform Bit Size</b>	64
	<b>Type</b>	numeric
	<b>Default</b>	1048576
	<b>Range</b>	0-18446744073709547520

Don't cache results that are larger than this number of bytes. The default value is 1MB.

- `query_cache_min_res_unit`

<b>Command Line Format</b>	<code>--query_cache_min_res_unit=#</code>	
<b>Config File Format</b>	<code>query_cache_min_res_unit</code>	
<b>Option Sets Variable</b>	Yes, <code>query_cache_min_res_unit</code>	
<b>Variable Name</b>	<code>query_cache_min_res_unit</code>	
<b>Variable Scope</b>	Global	
<b>Dynamic Variable</b>	Yes	
<b>Value Set</b>	<b>Platform Bit Size</b>	32
	<b>Type</b>	numeric
	<b>Default</b>	4096
	<b>Range</b>	512-4294967295
<b>Value Set</b>	<b>Platform Bit Size</b>	64
	<b>Type</b>	numeric
	<b>Default</b>	4096
	<b>Range</b>	512-18446744073709547520

The minimum size (in bytes) for blocks allocated by the query cache. The default value is 4096 (4KB). Tuning information for this variable is given in [Section 7.5.5.3, "Query Cache Configuration"](#).

- `query_cache_size`

<b>Command Line Format</b>	<code>--query_cache_size=#</code>	
<b>Config File Format</b>	<code>query_cache_size</code>	
<b>Option Sets Variable</b>	Yes, <code>query_cache_size</code>	
<b>Variable Name</b>	<code>query_cache_size</code>	
<b>Variable Scope</b>	Global	
<b>Dynamic Variable</b>	Yes	
<b>Value Set</b>	<b>Platform Bit Size</b>	32
	<b>Type</b>	numeric
	<b>Default</b>	0
	<b>Range</b>	0-4294967295
<b>Value Set</b>	<b>Platform Bit Size</b>	64
	<b>Type</b>	numeric
	<b>Default</b>	0
	<b>Range</b>	0-18446744073709547520

The amount of memory allocated for caching query results. The default value is 0, which disables the query cache. The allowable values are multiples of 1024; other values are rounded down to the nearest multiple. Note that `query_cache_size` bytes of memory are allocated even if `query_cache_type` is set to 0. See [Section 7.5.5.3, “Query Cache Configuration”](#), for more information.

The query cache needs a minimum size of about 40KB to allocate its structures. (The exact size depends on system architecture.) If you set the value of `query_cache_size` too small, you'll get a warning, as described in [Section 7.5.5.3, “Query Cache Configuration”](#).

- `query_cache_type`

<b>Command Line Format</b>	<code>--query_cache_type=#</code>	
<b>Config File Format</b>	<code>query_cache_type</code>	
<b>Option Sets Variable</b>	Yes, <code>query_cache_type</code>	
<b>Variable Name</b>	<code>query_cache_type</code>	
<b>Variable Scope</b>	Both	
<b>Dynamic Variable</b>	Yes	
<b>Value Set</b>	<b>Type</b>	enumeration
	<b>Default</b>	1
	<b>Valid Values</b>	0, 1, 2

Set the query cache type. Setting the `GLOBAL` value sets the type for all clients that connect thereafter. Individual clients can set the `SESSION` value to affect their own use of the query cache. Possible values are shown in the following table.

Option	Description
0 or <code>OFF</code>	Don't cache results in or retrieve results from the query cache. Note that this does not deallocate the query cache buffer. To do that, you should set <code>query_cache_size</code> to 0.
1 or <code>ON</code>	Cache all cacheable query results except for those that begin with <code>SELECT SQL_NO_CACHE</code> .
2 or <code>DEMAND</code>	Cache results only for cacheable queries that begin with <code>SELECT SQL_CACHE</code> .

This variable defaults to `ON`.

Any unique prefix of a valid value may be used to set the value of this variable.

- `query_cache_wlock_invalidate`

<b>Command Line Format</b>	<code>--query_cache_wlock_invalidate</code>
<b>Config File Format</b>	<code>query_cache_wlock_invalidate</code>

<b>Option Sets Variable</b>	Yes, <code>query_cache_wlock_invalidate</code>	
<b>Variable Name</b>	<code>query_cache_wlock_invalidate</code>	
<b>Variable Scope</b>	Both	
<b>Dynamic Variable</b>	Yes	
<b>Value Set</b>	<b>Type</b>	<code>boolean</code>
	<b>Default</b>	<code>FALSE</code>

Normally, when one client acquires a `WRITE` lock on a `MyISAM` table, other clients are not blocked from issuing statements that read from the table if the query results are present in the query cache. Setting this variable to 1 causes acquisition of a `WRITE` lock for a table to invalidate any queries in the query cache that refer to the table. This forces other clients that attempt to access the table to wait while the lock is in effect.

- `query_prealloc_size`

<b>Command Line Format</b>	<code>--query_prealloc_size=#</code>	
<b>Config File Format</b>	<code>query_prealloc_size</code>	
<b>Option Sets Variable</b>	Yes, <code>query_prealloc_size</code>	
<b>Variable Name</b>	<code>query_prealloc_size</code>	
<b>Variable Scope</b>	Both	
<b>Dynamic Variable</b>	Yes	
<b>Value Set</b>	<b>Platform Bit Size</b>	32
	<b>Type</b>	<code>numeric</code>
	<b>Default</b>	8192
	<b>Range</b>	8192-4294967295
<b>Value Set</b>	<b>Platform Bit Size</b>	64
	<b>Type</b>	<code>numeric</code>
	<b>Default</b>	8192
	<b>Range</b>	8192-18446744073709547520

The size of the persistent buffer used for statement parsing and execution. This buffer is not freed between statements. If you are running complex queries, a larger `query_prealloc_size` value might be helpful in improving performance, because it can reduce the need for the server to perform memory allocation during query execution operations.

- `range_alloc_block_size`

<b>Command Line Format</b>	<code>--range_alloc_block_size=#</code>	
<b>Config File Format</b>	<code>range_alloc_block_size</code>	
<b>Option Sets Variable</b>	Yes, <code>range_alloc_block_size</code>	
<b>Variable Name</b>	<code>range_alloc_block_size</code>	
<b>Variable Scope</b>	Both	
<b>Dynamic Variable</b>	Yes	
<b>Value Set</b>	<b>Platform Bit Size</b>	64
	<b>Type</b>	<code>numeric</code>
	<b>Default</b>	4096
	<b>Range</b>	4096-18446744073709547520

The size of blocks that are allocated when doing range optimization.

- `read_buffer_size`

<b>Command Line Format</b>	<code>--read_buffer_size=#</code>
----------------------------	-----------------------------------

<b>Config File Format</b>	<code>read_buffer_size</code>	
<b>Option Sets Variable</b>	Yes, <code>read_buffer_size</code>	
<b>Variable Name</b>	<code>read_buffer_size</code>	
<b>Variable Scope</b>	Both	
<b>Dynamic Variable</b>	Yes	
<b>Value Set</b>	<b>Type</b>	numeric
	<b>Default</b>	131072
	<b>Range</b>	8200-2147479552

Each thread that does a sequential scan allocates a buffer of this size (in bytes) for each table it scans. If you do many sequential scans, you might want to increase this value, which defaults to 131072. The value of this variable should be a multiple of 4KB. If it is set to a value that is not a multiple of 4KB, its value will be rounded down to the nearest multiple of 4KB.

The maximum allowable setting for `read_buffer_size` is 2GB.

`read_buffer_size` and `read_rnd_buffer_size` are not specific to any storage engine and apply in a general manner for optimization. See [Section 7.5.8, “How MySQL Uses Memory”](#), for example.

- `read_only`

<b>Command Line Format</b>	<code>--read_only</code>	
<b>Config File Format</b>	<code>read_only</code>	
<b>Option Sets Variable</b>	Yes, <code>read_only</code>	
<b>Variable Name</b>	<code>read_only</code>	
<b>Variable Scope</b>	Global	
<b>Dynamic Variable</b>	Yes	
<b>Value Set</b>	<b>Type</b>	numeric
	<b>Default</b>	0

This variable is off by default. When it is enabled, the server allows no updates except from users that have the `SUPER` privilege or (on a slave server) from updates performed by slave threads. On a slave server, this can be useful to ensure that the slave accepts updates only from its master server and not from clients. This variable does not apply to `TEMPORARY` tables, nor does it prevent the server from inserting rows into the log tables (see [Section 5.2.1, “Selecting General Query and Slow Query Log Output Destinations”](#)).

`read_only` exists only as a `GLOBAL` variable, so changes to its value require the `SUPER` privilege. Changes to `read_only` on a master server are not replicated to slave servers. The value can be set on a slave server independent of the setting on the master.

As of MySQL 5.1.15, the following conditions apply:

- If you attempt to enable `read_only` while you have any explicit locks (acquired with `LOCK TABLES`) or have a pending transaction, an error occurs.
- If you attempt to enable `read_only` while other clients hold explicit table locks or have pending transactions, the attempt blocks until the locks are released and the transactions end. While the attempt to enable `read_only` is pending, requests by other clients for table locks or to begin transactions also block until `read_only` has been set.
- `read_only` can be enabled while you hold a global read lock (acquired with `FLUSH TABLES WITH READ LOCK`) because that does not involve table locks.

- `read_rnd_buffer_size`

<b>Command Line Format</b>	<code>--read_rnd_buffer_size=#</code>	
<b>Config File Format</b>	<code>read_rnd_buffer_size</code>	
<b>Option Sets Variable</b>	Yes, <code>read_rnd_buffer_size</code>	
<b>Variable Name</b>	<code>read_rnd_buffer_size</code>	
<b>Variable Scope</b>	Both	

<b>Dynamic Variable</b>	Yes	
<b>Value Set</b>	<b>Type</b>	numeric
	<b>Default</b>	262144
	<b>Range</b>	8200-4294967295

When reading rows in sorted order following a key-sorting operation, the rows are read through this buffer to avoid disk seeks. See [Section 7.2.13, “ORDER BY Optimization”](#). Setting the variable to a large value can improve `ORDER BY` performance by a lot. However, this is a buffer allocated for each client, so you should not set the global variable to a large value. Instead, change the session variable only from within those clients that need to run large queries.

The maximum allowable setting for `read_rnd_buffer_size` is 2GB.

`read_buffer_size` and `read_rnd_buffer_size` are not specific to any storage engine and apply in a general manner for optimization. See [Section 7.5.8, “How MySQL Uses Memory”](#), for example.

- `relay_log_purge`

<b>Command Line Format</b>	<code>--relay_log_purge</code>	
<b>Config File Format</b>	<code>relay_log_purge</code>	
<b>Option Sets Variable</b>	Yes, <code>relay_log_purge</code>	
<b>Variable Name</b>	<code>relay_log_purge</code>	
<b>Variable Scope</b>	Global	
<b>Dynamic Variable</b>	Yes	
<b>Value Set</b>	<b>Type</b>	boolean
	<b>Default</b>	TRUE

Disables or enables automatic purging of relay log files as soon as they are not needed any more. The default value is 1 (ON).

- `relay_log_space_limit`

<b>Command Line Format</b>	<code>--relay_log_space_limit=#</code>	
<b>Config File Format</b>	<code>relay_log_space_limit</code>	
<b>Option Sets Variable</b>	Yes, <code>relay_log_space_limit</code>	
<b>Variable Name</b>	<code>relay_log_space_limit</code>	
<b>Variable Scope</b>	Global	
<b>Dynamic Variable</b>	No	
<b>Value Set</b>	<b>Platform Bit Size</b>	32
	<b>Type</b>	numeric
	<b>Default</b>	0
	<b>Range</b>	0-4294967295
<b>Value Set</b>	<b>Platform Bit Size</b>	64
	<b>Type</b>	numeric
	<b>Default</b>	0
	<b>Range</b>	0-18446744073709547520

The maximum amount of space to use for all relay logs.

- `report_host`

The value of the `--report-host` option. This variable was added in MySQL 5.1.24.

- `report_password`

The value of the `--report-password` option. This variable was added in MySQL 5.1.24.

- `report_port`

The value of the `--report-port` option. This variable was added in MySQL 5.1.24.

- `report_user`

The value of the `--report-user` option. This variable was added in MySQL 5.1.24.

- `secure_auth`

<b>Command Line Format</b>	<code>--secure-auth</code>	
<b>Config File Format</b>	<code>secure-auth</code>	
<b>Option Sets Variable</b>	Yes, <code>secure_auth</code>	
<b>Variable Name</b>	<code>secure_auth</code>	
<b>Variable Scope</b>	Global	
<b>Dynamic Variable</b>	Yes	
<b>Value Set</b>	<b>Type</b>	<code>boolean</code>
	<b>Default</b>	<code>FALSE</code>

If the MySQL server has been started with the `--secure-auth` option, it blocks connections from all accounts that have passwords stored in the old (pre-4.1) format. In that case, the value of this variable is `ON`, otherwise it is `OFF`.

You should enable this option if you want to prevent all use of passwords employing the old format (and hence insecure communication over the network).

Server startup fails with an error if this option is enabled and the privilege tables are in pre-4.1 format. See [Section B.1.2.4](#), “Client does not support authentication protocol”.

- `secure_file_priv`

<b>Version Introduced</b>	5.1.17	
<b>Command Line Format</b>	<code>--secure-file-priv</code>	
<b>Config File Format</b>	<code>secure-file-priv</code>	
<b>Option Sets Variable</b>	Yes, <code>secure_file_priv</code>	
<b>Variable Name</b>	<code>secure_file_priv</code>	
<b>Variable Scope</b>	Global	
<b>Dynamic Variable</b>	No	
<b>Value Set</b>	<b>Type</b>	<code>string</code>

By default, this variable is empty. If set to the name of a directory, it limits the effect of the `LOAD_FILE()` function and the `LOAD DATA` and `SELECT ... INTO OUTFILE` statements to work only with files in that directory.

This variable was added in MySQL 5.1.17.

- `server_id`

<b>Command Line Format</b>	<code>--server-id=#</code>	
<b>Config File Format</b>	<code>server-id</code>	
<b>Option Sets Variable</b>	Yes, <code>server_id</code>	
<b>Variable Name</b>	<code>server_id</code>	
<b>Variable Scope</b>	Global	
<b>Dynamic Variable</b>	Yes	
<b>Value Set</b>	<b>Type</b>	<code>numeric</code>
	<b>Default</b>	<code>0</code>
	<b>Range</b>	<code>0-4294967295</code>

The server ID, used in replication to give each master and slave a unique identity. This variable is set by the `--server-id` option. For each server participating in replication, you should pick a positive integer in the range from 1 to  $2^{32} - 1$  to act as that server's ID.

- `shared_memory`

<b>Variable Name</b>	<code>shared_memory</code>
<b>Variable Scope</b>	Global
<b>Dynamic Variable</b>	No
<b>Platform Specific</b>	windows

(Windows only.) Whether the server allows shared-memory connections.

- `shared_memory_base_name`

<b>Variable Name</b>	<code>shared_memory_base_name</code>
<b>Variable Scope</b>	Global
<b>Dynamic Variable</b>	No
<b>Platform Specific</b>	windows

(Windows only.) The name of shared memory to use for shared-memory connections. This is useful when running multiple MySQL instances on a single physical machine. The default name is `MYSQL`. The name is case sensitive.

- `skip_external_locking`

This is `OFF` if `mysqld` uses external locking, `ON` if external locking is disabled.

- `skip_networking`

This is `ON` if the server allows only local (non-TCP/IP) connections. On Unix, local connections use a Unix socket file. On Windows, local connections use a named pipe or shared memory. On NetWare, only TCP/IP connections are supported, so do not set this variable to `ON`. This variable can be set to `ON` with the `--skip-networking` option.

- `skip_show_database`

This prevents people from using the `SHOW DATABASES` statement if they do not have the `SHOW DATABASES` privilege. This can improve security if you have concerns about users being able to see databases belonging to other users. Its effect depends on the `SHOW DATABASES` privilege: If the variable value is `ON`, the `SHOW DATABASES` statement is allowed only to users who have the `SHOW DATABASES` privilege, and the statement displays all database names. If the value is `OFF`, `SHOW DATABASES` is allowed to all users, but displays the names of only those databases for which the user has the `SHOW DATABASES` or other privilege.

- `slow_launch_time`

<b>Command Line Format</b>	<code>--slow_launch_time=#</code>	
<b>Config File Format</b>	<code>slow_launch_time</code>	
<b>Option Sets Variable</b>	Yes, <code>slow_launch_time</code>	
<b>Variable Name</b>	<code>slow_launch_time</code>	
<b>Variable Scope</b>	Global	
<b>Dynamic Variable</b>	Yes	
<b>Value Set</b>	<b>Type</b>	<code>numeric</code>
	<b>Default</b>	<code>2</code>

If creating a thread takes longer than this many seconds, the server increments the `Slow_launch_threads` status variable.

- `slow_query_log`

Whether the slow query log is enabled. The value can be 0 (or `OFF`) to disable the log or 1 (or `ON`) to enable the log. The default value depends on whether the `--slow_query_log` option is given (`--log-slow-queries` before MySQL 5.1.29).



The destination for log output is controlled by the `log_output` system variable; if that value is `NONE`, no log entries are written even if the log is enabled. The `slow_query_log` variable was added in MySQL 5.1.12.

- `slow_query_log_file`

<b>Version Introduced</b>	5.1.12	
<b>Command Line Format</b>	<code>--slow-query-log-file=file_name</code>	
<b>Config File Format</b>	<code>slow_query_log_file</code>	
<b>Option Sets Variable</b>	Yes, <code>slow_query_log_file</code>	
<b>Variable Name</b>	<code>slow_query_log_file</code>	
<b>Variable Scope</b>	Global	
<b>Dynamic Variable</b>	Yes	
<b>Value Set</b>	<b>Type</b>	<code>filename</code>

The name of the slow query log file. The default value is `host_name-slow.log`, but the initial value can be changed with the `--slow_query_log_file` option (`--log-slow-queries` before MySQL 5.1.29). This variable was added in MySQL 5.1.12.

- `socket`

<b>Command Line Format</b>	<code>--socket=name</code>	
<b>Config File Format</b>	<code>socket</code>	
<b>Option Sets Variable</b>	Yes, <code>socket</code>	
<b>Variable Name</b>	<code>socket</code>	
<b>Variable Scope</b>	Global	
<b>Dynamic Variable</b>	No	
<b>Value Set</b>	<b>Type</b>	<code>filename</code>
	<b>Default</b>	<code>/tmp/mysql.sock</code>

On Unix platforms, this variable is the name of the socket file that is used for local client connections. The default is `/tmp/mysql.sock`. (For some distribution formats, the directory might be different, such as `/var/lib/mysql` for RPMs.)

On Windows, this variable is the name of the named pipe that is used for local client connections. The default value is `MySQL` (not case sensitive).

- `sort_buffer_size`

<b>Command Line Format</b>	<code>--sort_buffer_size=#</code>	
<b>Config File Format</b>	<code>sort_buffer_size</code>	
<b>Option Sets Variable</b>	Yes, <code>sort_buffer_size</code>	
<b>Variable Name</b>	<code>sort_buffer_size</code>	
<b>Variable Scope</b>	Both	
<b>Dynamic Variable</b>	Yes	
<b>Value Set</b>	<b>Platform Bit Size</b>	32
	<b>Type</b>	<code>numeric</code>
	<b>Default</b>	2097144
	<b>Max Value</b>	4294967295
<b>Value Set</b>	<b>Platform Bit Size</b>	64
	<b>Type</b>	<code>numeric</code>
	<b>Default</b>	2097144
	<b>Max Value</b>	18446744073709547520

Each thread that needs to do a sort allocates a buffer of this size. Increase this value for faster `ORDER BY` or `GROUP BY` operations. See [Section B.1.4.4, “Where MySQL Stores Temporary Files”](#).

The maximum allowable setting for `sort_buffer_size` is 4GB. As of MySQL 5.1.23, values larger than 4GB are allowed for 64-bit platforms (except 64-bit Windows, for which large values are truncated to 4GB with a warning).

- `sql_mode`

<b>Command Line Format</b>	<code>--sql-mode=name</code>	
<b>Config File Format</b>	<code>sql-mode</code>	
<b>Option Sets Variable</b>	Yes, <code>sql_mode</code>	
<b>Variable Name</b>	<code>sql_mode</code>	
<b>Variable Scope</b>	Both	
<b>Dynamic Variable</b>	Yes	
<b>Value Set</b>	<b>Type</b>	set
	<b>Default</b>	''
	<b>Valid Values</b>	ALLOW_INVALID_DATES, ANSI_QUOTES, ERROR_FOR_DIVISION_BY_ZERO, HIGH_NOT_PRECEDENCE, IGNORE_SPACE, NO_AUTO_CREATE_USER, NO_AUTO_VALUE_ON_ZERO, NO_BACKSLASH_ESCAPES, NO_DIR_IN_CREATE, NO_ENGINE_SUBSTITUTION, NO_FIELD_OPTIONS, NO_KEY_OPTIONS, NO_TABLE_OPTIONS, NO_UNSIGNED_SUBTRACTION, NO_ZERO_DATE, NO_ZERO_IN_DATE, ONLY_FULL_GROUP_BY, PAD_CHAR_TO_FULL_LENGTH, PIPES_AS_CONCAT, REAL_AS_FLOAT, STRICT_ALL_TABLES, STRICT_TRANS_TABLES

The current server SQL mode, which can be set dynamically. See [Section 5.1.7, “Server SQL Modes”](#).

- `sql_select_limit`

<b>Variable Name</b>	<code>sql_select_limit</code>	
<b>Variable Scope</b>	Both	
<b>Dynamic Variable</b>	Yes	
<b>Value Set</b>	<b>Type</b>	numeric

The maximum number of rows to return from `SELECT` statements. The default value for a new connection is the maximum number of rows that the server allows per table, which depends on the server configuration and may be affected if the server build was configured with `--with-big-tables`. Typical default values are  $(2^{32})-1$  or  $(2^{64})-1$ . If you have changed the limit, the default value can be restored by assigning a value of `DEFAULT`.

If a `SELECT` has a `LIMIT` clause, the `LIMIT` takes precedence over the value of `sql_select_limit`.

`sql_select_limit` does not apply to `SELECT` statements executed within stored routines. It also does not apply to `SELECT` statements that do not produce a result set to be returned to the client. These include `SELECT` statements in subqueries, `CREATE TABLE ... SELECT`, and `INSERT INTO ... SELECT`.

- `ssl_ca`

<b>Version Introduced</b>	5.1.11
---------------------------	--------

<b>Command Line Format</b>	<code>--ssl-ca=name</code>
<b>Config File Format</b>	<code>ssl-ca</code>
<b>Option Sets Variable</b>	Yes, <code>ssl_ca</code>
<b>Variable Name</b>	<code>ssl_ca</code>
<b>Variable Scope</b>	Global
<b>Dynamic Variable</b>	No
<b>Value Set</b>	<b>Type</b>   <code>filename</code>

The path to a file with a list of trusted SSL CAs. This variable was added in MySQL 5.1.11.

- `ssl_capath`

<b>Version Introduced</b>	5.1.11
<b>Command Line Format</b>	<code>--ssl-capath=name</code>
<b>Config File Format</b>	<code>ssl-capath</code>
<b>Option Sets Variable</b>	Yes, <code>ssl_capath</code>
<b>Variable Name</b>	<code>ssl_capath</code>
<b>Variable Scope</b>	Global
<b>Dynamic Variable</b>	No
<b>Value Set</b>	<b>Type</b>   <code>filename</code>

The path to a directory that contains trusted SSL CA certificates in PEM format. This variable was added in MySQL 5.1.11.

- `ssl_cert`

<b>Version Introduced</b>	5.1.11
<b>Command Line Format</b>	<code>--ssl-cert=name</code>
<b>Config File Format</b>	<code>ssl-cert</code>
<b>Option Sets Variable</b>	Yes, <code>ssl_cert</code>
<b>Variable Name</b>	<code>ssl_cert</code>
<b>Variable Scope</b>	Global
<b>Dynamic Variable</b>	No
<b>Value Set</b>	<b>Type</b>   <code>filename</code>

The name of the SSL certificate file to use for establishing a secure connection. This variable was added in MySQL 5.1.11.

- `ssl_cipher`

<b>Version Introduced</b>	5.1.11
<b>Command Line Format</b>	<code>--ssl-cipher=name</code>
<b>Config File Format</b>	<code>ssl-cipher</code>
<b>Option Sets Variable</b>	Yes, <code>ssl_cipher</code>
<b>Variable Name</b>	<code>ssl_cipher</code>
<b>Variable Scope</b>	Global
<b>Dynamic Variable</b>	No
<b>Value Set</b>	<b>Type</b>   <code>filename</code>

A list of allowable ciphers to use for SSL encryption. This variable was added in MySQL 5.1.11.

- `ssl_key`

<b>Version Introduced</b>	5.1.11
<b>Command Line Format</b>	<code>--ssl-key=name</code>
<b>Config File Format</b>	<code>ssl-key</code>
<b>Option Sets Variable</b>	Yes, <code>ssl_key</code>
<b>Variable Name</b>	<code>ssl_key</code>
<b>Variable Scope</b>	Global
<b>Dynamic Variable</b>	No
<b>Value Set</b>	<b>Type</b>   <code>string</code>

The name of the SSL key file to use for establishing a secure connection. This variable was added in MySQL 5.1.11.

- `storage_engine`

<b>Variable Name</b>	<code>storage_engine</code>
<b>Variable Scope</b>	Both
<b>Dynamic Variable</b>	Yes
<b>Value Set</b>	<b>Type</b>   <code>enumeration</code>

The default storage engine (table type). To set the storage engine at server startup, use the `--default-storage-engine` option. See [Section 5.1.2, “Server Command Options”](#).

- `sync_frm`

<b>Command Line Format</b>	<code>--sync_frm</code>
<b>Config File Format</b>	<code>sync_frm</code>
<b>Option Sets Variable</b>	Yes, <code>sync_frm</code>
<b>Variable Name</b>	<code>sync_frm</code>
<b>Variable Scope</b>	Global
<b>Dynamic Variable</b>	Yes
<b>Value Set</b>	<b>Type</b>   <code>boolean</code>
	<b>Default</b>   <code>TRUE</code>

If this variable is set to 1, when any non-temporary table is created its `.frm` file is synchronized to disk (using `fdatasync()`). This is slower but safer in case of a crash. The default is 1.

- `system_time_zone`

<b>Variable Name</b>	<code>system_time_zone</code>
<b>Variable Scope</b>	Global
<b>Dynamic Variable</b>	No
<b>Value Set</b>	<b>Type</b>   <code>string</code>

The server system time zone. When the server begins executing, it inherits a time zone setting from the machine defaults, possibly modified by the environment of the account used for running the server or the startup script. The value is used to set `system_time_zone`. Typically the time zone is specified by the `TZ` environment variable. It also can be specified using the `--timezone` option of the `mysqld_safe` script.

The `system_time_zone` variable differs from `time_zone`. Although they might have the same value, the latter variable is used to initialize the time zone for each client that connects. See [Section 9.7, “MySQL Server Time Zone Support”](#).

- `table_cache`

<b>Version Removed</b>	5.1.3
------------------------	-------

<b>Version Deprecated</b>	5.1.3	
<b>Command Line Format</b>	<code>--table_cache=#</code>	
<b>Config File Format</b>	<code>table_cache</code>	
<b>Option Sets Variable</b>	Yes, <code>table_cache</code>	
<b>Variable Name</b>	<code>table_cache</code>	
<b>Variable Scope</b>	Global	
<b>Dynamic Variable</b>	Yes	
<b>Deprecated</b>	5.1.3, by <code>table_open_cache</code>	
<b>Value Set</b>	<b>Type</b>	numeric
	<b>Default</b>	64
	<b>Range</b>	1-524288

This is the old name of `table_open_cache` before MySQL 5.1.3. From 5.1.3 on, use `table_open_cache` instead.

- `table_definition_cache`

<b>Version Introduced</b>	5.1.3	
<b>Command Line Format</b>	<code>--table_definition_cache=#</code>	
<b>Config File Format</b>	<code>table_definition_cache</code>	
<b>Option Sets Variable</b>	Yes, <code>table_definition_cache</code>	
<b>Variable Name</b>	<code>table_definition_cache</code>	
<b>Variable Scope</b>	Global	
<b>Dynamic Variable</b>	Yes	
<b>Value Set (&lt;= 5.1.24)</b>	<b>Type</b>	numeric
	<b>Default</b>	128
	<b>Range</b>	1-524288
<b>Value Set (&gt;= 5.1.25)</b>	<b>Type</b>	numeric
	<b>Default</b>	256
	<b>Range</b>	256-524288

The number of table definitions that can be stored in the definition cache. If you use a large number of tables, you can create a large table definition cache to speed up opening of tables. The table definition cache takes less space and does not use file descriptors, unlike the normal table cache. This variable was added in MySQL 5.1.3. The minimum and default values are 1 and 128 before MySQL 5.1.25. The minimum and default are both 256 as of MySQL 5.1.25.

- `table_lock_wait_timeout`

<b>Command Line Format</b>	<code>--table_lock_wait_timeout=#</code>	
<b>Config File Format</b>	<code>table_lock_wait_timeout</code>	
<b>Option Sets Variable</b>	Yes, <code>table_lock_wait_timeout</code>	
<b>Variable Name</b>	<code>table_lock_wait_timeout</code>	
<b>Variable Scope</b>	Global	
<b>Dynamic Variable</b>	Yes	
<b>Value Set</b>	<b>Type</b>	numeric
	<b>Default</b>	50
	<b>Range</b>	1-1073741824

This variable currently is unused.

- `table_open_cache`

<b>Version Introduced</b>	5.1.3	
<b>Command Line Format</b>	<code>--table-open-cache=#</code>	
<b>Config File Format</b>	<code>table_open_cache</code>	
<b>Variable Name</b>	<code>table_open_cache</code>	
<b>Variable Scope</b>	Global	
<b>Dynamic Variable</b>	Yes	
<b>Value Set</b>	<b>Type</b>	numeric
	<b>Default</b>	64
	<b>Range</b>	1-524288

The number of open tables for all threads. Increasing this value increases the number of file descriptors that `mysqld` requires. You can check whether you need to increase the table cache by checking the `Opened_tables` status variable. See [Section 5.1.6, “Server Status Variables”](#). If the value of `Opened_tables` is large and you don't do `FLUSH TABLES` often (which just forces all tables to be closed and reopened), then you should increase the value of the `table_open_cache` variable. For more information about the table cache, see [Section 7.4.7, “How MySQL Opens and Closes Tables”](#). Before MySQL 5.1.3, this variable is called `table_cache`.

- `table_type`

<b>Variable Name</b>	<code>table_type</code>	
<b>Variable Scope</b>	Both	
<b>Dynamic Variable</b>	Yes	
<b>Deprecated</b>	5.2.5, by <code>storage_engine</code>	
<b>Value Set</b>	<b>Type</b>	enumeration

This variable is a synonym for `storage_engine`. In MySQL 5.1, `storage_engine` is the preferred name. In MySQL 6.0, `table_type` will be removed.

- `thread_cache_size`

<b>Command Line Format</b>	<code>--thread_cache_size=#</code>	
<b>Config File Format</b>	<code>thread_cache_size</code>	
<b>Option Sets Variable</b>	Yes, <code>thread_cache_size</code>	
<b>Variable Name</b>	<code>thread_cache_size</code>	
<b>Variable Scope</b>	Global	
<b>Dynamic Variable</b>	Yes	
<b>Value Set</b>	<b>Type</b>	numeric
	<b>Default</b>	0
	<b>Range</b>	0-16384

How many threads the server should cache for reuse. When a client disconnects, the client's threads are put in the cache if there are fewer than `thread_cache_size` threads there. Requests for threads are satisfied by reusing threads taken from the cache if possible, and only when the cache is empty is a new thread created. This variable can be increased to improve performance if you have a lot of new connections. (Normally, this doesn't provide a notable performance improvement if you have a good thread implementation.) By examining the difference between the `Connections` and `Threads_created` status variables, you can see how efficient the thread cache is. For details, see [Section 5.1.6, “Server Status Variables”](#).

- `thread_concurrency`

<b>Command Line Format</b>	<code>--thread_concurrency=#</code>	
<b>Config File Format</b>	<code>thread_concurrency</code>	
<b>Option Sets Variable</b>	Yes, <code>thread_concurrency</code>	
<b>Variable Name</b>	<code>thread_concurrency</code>	

<b>Variable Scope</b>	Global	
<b>Dynamic Variable</b>	No	
<b>Value Set</b>	<b>Type</b>	numeric
	<b>Default</b>	10
	<b>Range</b>	1-512

This variable is specific to Solaris systems, for which `mysqld` invokes the `thr_setconcurrency()` with the variable value. This function enables applications to give the threads system a hint about the desired number of threads that should be run at the same time.

- `thread_handling`

<b>Version Introduced</b>	5.1.17	
<b>Command Line Format</b>	<code>--thread_handling=name</code>	
<b>Config File Format</b>	<code>thread_handling</code>	
<b>Option Sets Variable</b>	Yes, <code>thread_handling</code>	
<b>Variable Name</b>	<code>thread_handling</code>	
<b>Variable Scope</b>	Global	
<b>Dynamic Variable</b>	No	
<b>Value Set</b>	<b>Type</b>	enumeration
	<b>Valid Values</b>	<code>no-threads</code> , <code>one-thread-per-connection</code>

The thread-handling model. The allowable values are `one-thread` (the server uses one thread) and `one-thread-per-connection` (the server uses one thread to handle each client connection). `one-thread` is useful for debugging under Linux; see [MySQL Internals: Porting](#). This variable was added in MySQL 5.1.17

- `thread_stack`

<b>Command Line Format</b>	<code>--thread_stack=#</code>	
<b>Config File Format</b>	<code>thread_stack</code>	
<b>Option Sets Variable</b>	Yes, <code>thread_stack</code>	
<b>Variable Name</b>	<code>thread_stack</code>	
<b>Variable Scope</b>	Global	
<b>Dynamic Variable</b>	No	
<b>Value Set</b>	<b>Platform Bit Size</b>	32
	<b>Type</b>	numeric
	<b>Default</b>	196608
	<b>Range</b>	131072-4294967295
<b>Value Set</b>	<b>Platform Bit Size</b>	64
	<b>Type</b>	numeric
	<b>Default</b>	196608
	<b>Range</b>	131072-18446744073709547520

The stack size for each thread. Many of the limits detected by the `crash-me` test are dependent on this value. See [Section 7.1.4, “The MySQL Benchmark Suite”](#). The default (192KB) is large enough for normal operation. If the thread stack size is too small, it limits the complexity of the SQL statements that the server can handle, the recursion depth of stored procedures, and other memory-consuming actions.

- `time_format`

This variable is unused.

- `time_zone`

<b>Command Line Format</b>	<code>--default_time_zone=string</code>	
<b>Config File Format</b>	<code>default_time_zone</code>	
<b>Variable Name</b>	<code>time_zone</code>	
<b>Variable Scope</b>	Both	
<b>Dynamic Variable</b>	Yes	
<b>Value Set</b>	<b>Type</b>	<code>string</code>

The current time zone. This variable is used to initialize the time zone for each client that connects. By default, the initial value of this is 'SYSTEM' (which means, "use the value of `system_time_zone`"). The value can be specified explicitly at server startup with the `--default-time-zone` option. See [Section 9.7, "MySQL Server Time Zone Support"](#).

- `timed_mutexes`

<b>Command Line Format</b>	<code>--timed_mutexes</code>	
<b>Config File Format</b>	<code>timed_mutexes</code>	
<b>Option Sets Variable</b>	Yes, <code>timed_mutexes</code>	
<b>Variable Name</b>	<code>timed_mutexes</code>	
<b>Variable Scope</b>	Global	
<b>Dynamic Variable</b>	Yes	
<b>Value Set</b>	<b>Type</b>	<code>boolean</code>
	<b>Default</b>	<code>OFF</code>

This variable controls whether InnoDB mutexes are timed. If this variable is set to 0 or `OFF` (the default), mutex timing is disabled. If the variable is set to 1 or `ON`, mutex timing is enabled. With timing enabled, the `os_wait_times` value in the output from `SHOW ENGINE INNODB MUTEX` indicates the amount of time (in ms) spent in operating system waits. Otherwise, the value is 0.

- `tmp_table_size`

<b>Version Removed</b>	5.1.12	
<b>Command Line Format</b>	<code>--tmp_table_size=#</code>	
<b>Config File Format</b>	<code>tmp_table_size</code>	
<b>Option Sets Variable</b>	Yes, <code>tmp_table_size</code>	
<b>Variable Name</b>	<code>tmp_table_size</code>	
<b>Variable Scope</b>	Both	
<b>Dynamic Variable</b>	Yes	
<b>Value Set</b>	<b>Type</b>	<code>numeric</code>
	<b>Default</b>	<code>system dependent</code>
	<b>Range</b>	<code>1024-4294967295</code>

The maximum size of internal in-memory temporary tables. (The actual limit is determined as the smaller of `max_heap_table_size` and `tmp_table_size`.) If an in-memory temporary table exceeds the limit, MySQL automatically converts it to an on-disk MyISAM table. Increase the value of `tmp_table_size` (and `max_heap_table_size` if necessary) if you do many advanced `GROUP BY` queries and you have lots of memory. This variable does not apply to user-created `MEMORY` tables.

- `tmpdir`

<b>Command Line Format</b>	<code>--tmpdir=name</code>	
<b>Config File Format</b>	<code>tmpdir</code>	
<b>Option Sets Variable</b>	Yes, <code>tmpdir</code>	
<b>Variable Name</b>	<code>tmpdir</code>	



<b>Variable Scope</b>	Global	
<b>Dynamic Variable</b>	No	
<b>Value Set</b>	<b>Type</b>	filename

The directory used for temporary files and temporary tables. This variable can be set to a list of several paths that are used in round-robin fashion. Paths should be separated by colon characters (":") on Unix and semicolon characters (";") on Windows, NetWare, and OS/2.

The multiple-directory feature can be used to spread the load between several physical disks. If the MySQL server is acting as a replication slave, you should not set `tmpdir` to point to a directory on a memory-based file system or to a directory that is cleared when the server host restarts. A replication slave needs some of its temporary files to survive a machine restart so that it can replicate temporary tables or `LOAD DATA INFILE` operations. If files in the temporary file directory are lost when the server restarts, replication fails. However, if you are using MySQL 4.0.0 or later, you can set the slave's temporary directory using the `slave_load_tmpdir` variable. In that case, the slave won't use the general `tmpdir` value and you can set `tmpdir` to a non-permanent location.

- `transaction_alloc_block_size`

<b>Command Line Format</b>	<code>--transaction_alloc_block_size=#</code>	
<b>Config File Format</b>	<code>transaction_alloc_block_size</code>	
<b>Option Sets Variable</b>	Yes, <code>transaction_alloc_block_size</code>	
<b>Variable Name</b>	<code>transaction_alloc_block_size</code>	
<b>Variable Scope</b>	Both	
<b>Dynamic Variable</b>	Yes	
<b>Value Set</b>	<b>Platform Bit Size</b>	32
	<b>Type</b>	numeric
	<b>Default</b>	8192
	<b>Range</b>	1024-4294967295

The amount in bytes by which to increase a per-transaction memory pool which needs memory. See the description of `transaction_prealloc_size`.

- `transaction_prealloc_size`

<b>Command Line Format</b>	<code>--transaction_prealloc_size=#</code>	
<b>Config File Format</b>	<code>transaction_prealloc_size</code>	
<b>Option Sets Variable</b>	Yes, <code>transaction_prealloc_size</code>	
<b>Variable Name</b>	<code>transaction_prealloc_size</code>	
<b>Variable Scope</b>	Both	
<b>Dynamic Variable</b>	Yes	
<b>Value Set</b>	<b>Platform Bit Size</b>	32
	<b>Type</b>	numeric
	<b>Default</b>	4096
	<b>Range</b>	1024-4294967295
<b>Value Set</b>	<b>Platform Bit Size</b>	64
	<b>Type</b>	numeric
	<b>Default</b>	4096
	<b>Range</b>	1024-18446744073709547520

There is a per-transaction memory pool from which various transaction-related allocations take memory. The initial size of the pool in bytes is `transaction_prealloc_size`. For every allocation that cannot be satisfied from the pool because it has insufficient memory available, the pool is increased by `transaction_alloc_block_size` bytes. When the transaction ends, the pool is truncated to `transaction_prealloc_size` bytes.

By making `transaction_prealloc_size` sufficiently large to contain all statements within a single transaction, you can avoid many `malloc()` calls.

- `tx_isolation`

<b>Variable Name</b>	<code>tx_isolation</code>	
<b>Variable Scope</b>	Both	
<b>Dynamic Variable</b>	Yes	
<b>Value Set</b>	<b>Type</b>	enumeration
	<b>Default</b>	REPEATABLE-READ
	<b>Valid Values</b>	READ-UNCOMMITTED, READ-COMMITTED, REPEATABLE-READ, SERIALIZABLE

The default transaction isolation level. Defaults to `REPEATABLE-READ`.

This variable is set by the `SET TRANSACTION ISOLATION LEVEL` statement. See [Section 12.4.6, “SET TRANSACTION Syntax”](#). If you set `tx_isolation` directly to an isolation level name that contains a space, the name should be enclosed within quotes, with the space replaced by a dash. For example:

```
SET tx_isolation = 'READ-COMMITTED';
```

Any unique prefix of a valid value may be used to set the value of this variable.

- `updatable_views_with_limit`

<b>Command Line Format</b>	<code>--updatable_views_with_limit=#</code>	
<b>Config File Format</b>	<code>updatable_views_with_limit</code>	
<b>Option Sets Variable</b>	Yes, <code>updatable_views_with_limit</code>	
<b>Variable Name</b>	<code>updatable_views_with_limit</code>	
<b>Variable Scope</b>	Both	
<b>Dynamic Variable</b>	Yes	
<b>Value Set</b>	<b>Type</b>	boolean
	<b>Default</b>	1

This variable controls whether updates to a view can be made when the view does not contain all columns of the primary key defined in the underlying table, if the update statement contains a `LIMIT` clause. (Such updates often are generated by GUI tools.) An update is an `UPDATE` or `DELETE` statement. Primary key here means a `PRIMARY KEY`, or a `UNIQUE` index in which no column can contain `NULL`.

The variable can have two values:

- `1` or `YES`: Issue a warning only (not an error message). This is the default value.
  - `0` or `NO`: Prohibit the update.
- `version`

The version number for the server.

- `version_comment`

The `configure` script has a `--with-comment` option that allows a comment to be specified when building MySQL. This variable contains the value of that comment.

- `version_compile_machine`

The type of machine or architecture on which MySQL was built.

- `version_compile_os`

<b>Variable Name</b>	version_compile_os	
<b>Variable Scope</b>	Global	
<b>Dynamic Variable</b>	No	
<b>Value Set</b>	<b>Type</b>	string

The type of operating system on which MySQL was built.

- `wait_timeout`

<b>Command Line Format</b>	--wait_timeout=#	
<b>Config File Format</b>	wait_timeout	
<b>Option Sets Variable</b>	Yes, wait_timeout	
<b>Variable Name</b>	wait_timeout	
<b>Variable Scope</b>	Both	
<b>Dynamic Variable</b>	Yes	
<b>Value Set</b>	<b>Type</b>	numeric
	<b>Default</b>	28800
	<b>Range</b>	1-31536000
<b>Value Set</b>	<b>Type (windows)</b>	numeric
	<b>Default</b>	28800
	<b>Range</b>	1-2147483

The number of seconds the server waits for activity on a non-interactive connection before closing it. This timeout applies only to TCP/IP and Unix socket file connections, not to connections made via named pipes, or shared memory.

On thread startup, the session `wait_timeout` value is initialized from the global `wait_timeout` value or from the global `interactive_timeout` value, depending on the type of client (as defined by the `CLIENT_INTERACTIVE` connect option to `mysql_real_connect()`). See also `interactive_timeout`.

#### MySQL Enterprise

Expert use of server system variables is part of the service offered by the MySQL Enterprise Monitor. To subscribe, see <http://www.mysql.com/products/enterprise/advisors.html>.

### 5.1.4. Session System Variables

Several system variables exist only as session variables. These cannot be set at server startup but can be assigned values at runtime using the `SET` statement (except for those that are read only). Most of them are not displayed by `SHOW VARIABLES`, but you can obtain their values using `SELECT`. This section describes the session system variables. For information about setting or displaying their values, see [Section 5.1.5, “Using System Variables”](#). For example:

```
mysql> SELECT @@autocommit;
+-----+
| @@autocommit |
+-----+
|             1 |
+-----+
```

The lettercase of these variables does not matter.

The following table lists the system variables that have only session scope:

**Table 5.3. `mysqld` Session System Variable Summary**

Name	Cmd-Line	Option file	System Var	Dynamic
<code>autocommit</code>			Yes	Yes
<code>big-tables</code>	Yes	Yes		
- Variable: <code>big_tables</code>			Yes	Yes

Name	Cmd-Line	Option file	System Var	Dynamic
<a href="#">error_count</a>			Yes	No
<a href="#">foreign_key_checks</a>			Yes	Yes
<a href="#">identity</a>			Yes	Yes
<a href="#">insert_id</a>			Yes	Yes
<a href="#">last_insert_id</a>			Yes	Yes
<a href="#">ndb_table_no_logging</a>			Yes	Yes
<a href="#">ndb_table_temporary</a>			Yes	Yes
<a href="#">profiling</a>			Yes	Yes
<a href="#">rand_seed1</a>			Yes	Yes
<a href="#">rand_seed2</a>			Yes	Yes
<a href="#">sql_auto_is_null</a>			Yes	Yes
<a href="#">sql_big_selects</a>			Yes	Yes
<a href="#">sql_big_tables</a>			Yes	Yes
<a href="#">sql_buffer_result</a>			Yes	Yes
<a href="#">sql_log_bin</a>			Yes	Yes
<a href="#">sql_log_off</a>			Yes	Yes
<a href="#">sql_log_update</a>			Yes	Yes
<a href="#">sql_notes</a>			Yes	Yes
<a href="#">sql_quote_show_create</a>			Yes	Yes
<a href="#">sql_safe_updates</a>			Yes	Yes
<a href="#">sql_warnings</a>			Yes	Yes
<a href="#">timestamp</a>			Yes	Yes
<a href="#">transaction_allow_batching</a>			Yes	Yes
<a href="#">unique_checks</a>			Yes	Yes
<a href="#">warning_count</a>			Yes	No

- [autocommit](#)

The autocommit mode. If set to 1, all changes to a table take effect immediately. If set to 0, you must use [COMMIT](#) to accept a transaction or [ROLLBACK](#) to cancel it. By default, client connections begin with [autocommit](#) set to 1. If you change [autocommit](#) mode from 0 to 1, MySQL performs an automatic [COMMIT](#) of any open transaction. Another way to begin a transaction is to use a [START TRANSACTION](#) or [BEGIN](#) statement. See [Section 12.4.1, “START TRANSACTION, COMMIT, and ROLLBACK Syntax”](#).

- [big\\_tables](#)

If set to 1, all temporary tables are stored on disk rather than in memory. This is a little slower, but the error [The table \*tbl\\_name\* is full](#) does not occur for [SELECT](#) operations that require a large temporary table. The default value for a new connection is 0 (use in-memory temporary tables). Normally, you should never need to set this variable, because in-memory tables are automatically converted to disk-based tables as required.

### Note

This variable was formerly named [sql\\_big\\_tables](#).

- [error\\_count](#)

The number of errors that resulted from the last statement that generated messages. This variable is read only. See [Section 12.5.5.18, “SHOW ERRORS Syntax”](#).

- [foreign\\_key\\_checks](#)

If set to 1 (the default), foreign key constraints for [InnoDB](#) tables are checked. If set to 0, they are ignored. Disabling foreign key checking can be useful for reloading [InnoDB](#) tables in an order different from that required by their parent/child relationships. See [Section 13.6.4.4, “FOREIGN KEY Constraints”](#).

Setting [foreign\\_key\\_checks](#) to 0 also affects data definition statements: [DROP SCHEMA](#) drops a schema even if it con-

tains tables that have foreign keys that are referred to by tables outside the schema, and `DROP TABLE` drops tables that have foreign keys that are referred to by other tables.

### Note

Setting `foreign_key_checks` to 1 does not trigger a scan of the existing table data. Therefore, rows added to the table while `foreign_key_checks = 0` will not be verified for consistency.

- `identity`

This variable is a synonym for the `last_insert_id` variable. It exists for compatibility with other database systems. You can read its value with `SELECT @@identity`, and set it using `SET identity`.

- `insert_id`

The value to be used by the following `INSERT` or `ALTER TABLE` statement when inserting an `AUTO_INCREMENT` value. This is mainly used with the binary log.

- `last_insert_id`

The value to be returned from `LAST_INSERT_ID()`. This is stored in the binary log when you use `LAST_INSERT_ID()` in a statement that updates a table. Setting this variable does not update the value returned by the `mysql_insert_id()` C API function.

- `profiling`

If set to 0 (the default), statement profiling is disabled. If set to 1, statement profiling is enabled and the `SHOW PROFILES` and `SHOW PROFILE` statements provide access to profiling information. See [Section 12.5.5.33, “SHOW PROFILES Syntax”](#). This variable was added in MySQL 5.1.24.

- `profiling_history_size`

The number of statements for which to maintain profiling information if `profiling` is enabled. The default value is 15. The maximum value is 100. Setting the value to 0 effectively disables profiling. See [Section 12.5.5.33, “SHOW PROFILES Syntax”](#). This variable was added in MySQL 5.1.24.

- `rand_seed1`

The `rand_seed1` and `rand_seed2` variables exist as session variables only, and can be set but not read. Beginning with MySQL 5.1.18, the variables — but not their values — are shown in the output of `SHOW VARIABLES`.

The purpose of these variables is to support replication of the `RAND()` function. For statements that invoke `RAND()`, the master passes two values to the slave, where they are used to seed the random number generator. The slave uses these values to set the session variables `rand_seed1` and `rand_seed2` so that `RAND()` on the slave generates the same value as on the master.

- `rand_seed2`

See the description for `rand_seed1`.

- `sql_auto_is_null`

If set to 1 (the default), you can find the last inserted row for a table that contains an `AUTO_INCREMENT` column by using the following construct:

```
WHERE auto_increment_column IS NULL
```

This behavior is used by some ODBC programs, such as Access.

- `sql_big_selects`

If set to 0, MySQL aborts `SELECT` statements that are likely to take a very long time to execute (that is, statements for which the optimizer estimates that the number of examined rows exceeds the value of `max_join_size`). This is useful when an inadvisable `WHERE` statement has been issued. The default value for a new connection is 1, which allows all `SELECT` statements.

If you set the `max_join_size` system variable to a value other than `DEFAULT`, `sql_big_selects` is set to 0.

- `sql_buffer_result`

If set to 1, `sql_buffer_result` forces results from `SELECT` statements to be put into temporary tables. This helps MySQL free the table locks early and can be beneficial in cases where it takes a long time to send results to the client. The default value

is 0.

- `sql_log_bin`

If set to 0, no logging is done to the binary log for the client. The client must have the `SUPER` privilege to set this option. The default value is 1.

- `sql_log_off`

If set to 1, no logging is done to the general query log for this client. The client must have the `SUPER` privilege to set this option. The default value is 0.

- `sql_log_update`

This variable is deprecated, and is mapped to `sql_log_bin`.

- `sql_notes`

If set to 1 (the default), warnings of `Note` level are recorded. If set to 0, `Note` warnings are suppressed. `mysqldump` includes output to set this variable to 0 so that reloading the dump file does not produce warnings for events that do not affect the integrity of the reload operation.

- `sql_quote_show_create`

If set to 1 (the default), the server quotes identifiers for `SHOW CREATE TABLE` and `SHOW CREATE DATABASE` statements. If set to 0, quoting is disabled. This option is enabled by default so that replication works for identifiers that require quoting. See [Section 12.5.5.12, “SHOW CREATE TABLE Syntax”](#), and [Section 12.5.5.8, “SHOW CREATE DATABASE Syntax”](#).

- `sql_safe_updates`

If set to 1, MySQL aborts `UPDATE` or `DELETE` statements that do not use a key in the `WHERE` clause or a `LIMIT` clause. This makes it possible to catch `UPDATE` or `DELETE` statements where keys are not used properly and that would probably change or delete a large number of rows. The default value is 0.

- `sql_warnings`

This variable controls whether single-row `INSERT` statements produce an information string if warnings occur. The default is 0. Set the value to 1 to produce an information string.

- `timestamp = {timestamp_value | DEFAULT}`

Set the time for this client. This is used to get the original timestamp if you use the binary log to restore rows. `timestamp_value` should be a Unix epoch timestamp, not a MySQL timestamp.

`SET timestamp` affects the value returned by `NOW()` but not by `SYSDATE()`. This means that timestamp settings in the binary log have no effect on invocations of `SYSDATE()`. The server can be started with the `--sysdate-is-now` option to cause `SYSDATE()` to be an alias for `NOW()`, in which case `SET timestamp` affects both functions.

- `unique_checks`

If set to 1 (the default), uniqueness checks for secondary indexes in `InnoDB` tables are performed. If set to 0, storage engines are allowed to assume that duplicate keys are not present in input data. If you know for certain that your data does not contain uniqueness violations, you can set this to 0 to speed up large table imports to `InnoDB`.

Note that setting this variable to 0 does not *require* storage engines to ignore duplicate keys. An engine is still allowed to check for them and issue duplicate-key errors if it detects them.

- `warning_count`

The number of errors, warnings, and notes that resulted from the last statement that generated messages. This variable is read only. See [Section 12.5.5.42, “SHOW WARNINGS Syntax”](#).

## 5.1.5. Using System Variables

The MySQL server maintains many system variables that indicate how it is configured. [Section 5.1.3, “Server System Variables”](#), describes the meaning of these variables. Each system variable has a default value. System variables can be set at server startup using options on the command line or in an option file. Most of them can be changed dynamically while the server is running by means of the `SET` statement, which enables you to modify operation of the server without having to stop and restart it. You can refer to system variable values in expressions.

The server maintains two kinds of system variables. Global variables affect the overall operation of the server. Session variables affect its operation for individual client connections. A given system variable can have both a global and a session value. Global and session system variables are related as follows:

- When the server starts, it initializes all global variables to their default values. These defaults can be changed by options specified on the command line or in an option file. (See [Section 4.2.3, “Specifying Program Options”](#).)
- The server also maintains a set of session variables for each client that connects. The client's session variables are initialized at connect time using the current values of the corresponding global variables. For example, the client's SQL mode is controlled by the session `sql_mode` value, which is initialized when the client connects to the value of the global `sql_mode` value.

System variable values can be set globally at server startup by using options on the command line or in an option file. When you use a startup option to set a variable that takes a numeric value, the value can be given with a suffix of `K`, `M`, or `G` (either uppercase or lowercase) to indicate a multiplier of 1024, 1024<sup>2</sup> or 1024<sup>3</sup>; that is, units of kilobytes, megabytes, or gigabytes, respectively. Thus, the following command starts the server with a query cache size of 16 megabytes and a maximum packet size of one gigabyte:

```
mysqld --query_cache_size=16M --max_allowed_packet=1G
```

Within an option file, those variables are set like this:

```
[mysqld]
query_cache_size=16M
max_allowed_packet=1G
```

The lettercase of suffix letters does not matter; `16M` and `16m` are equivalent, as are `1G` and `1g`.

If you want to restrict the maximum value to which a system variable can be set at runtime with the `SET` statement, you can specify this maximum by using an option of the form `--maximum-var_name=value` at server startup. For example, to prevent the value of `query_cache_size` from being increased to more than 32MB at runtime, use the option `--maximum-query_cache_size=32M`.

Many system variables are dynamic and can be changed while the server runs by using the `SET` statement. For a list, see [Section 5.1.5.2, “Dynamic System Variables”](#). To change a system variable with `SET`, refer to it as `var_name`, optionally preceded by a modifier:

- To indicate explicitly that a variable is a global variable, precede its name by `GLOBAL` or `@@global..`. The `SUPER` privilege is required to set global variables.
- To indicate explicitly that a variable is a session variable, precede its name by `SESSION`, `@@session..`, or `@@`. Setting a session variable requires no special privilege, but a client can change only its own session variables, not those of any other client.
- `LOCAL` and `@@local..` are synonyms for `SESSION` and `@@session..`
- If no modifier is present, `SET` changes the session variable.

A `SET` statement can contain multiple variable assignments, separated by commas. If you set several system variables, the most recent `GLOBAL` or `SESSION` modifier in the statement is used for following variables that have no modifier specified.

Examples:

```
SET sort_buffer_size=10000;
SET @@local.sort_buffer_size=10000;
SET GLOBAL sort_buffer_size=1000000, SESSION sort_buffer_size=1000000;
SET @@sort_buffer_size=1000000;
SET @@global.sort_buffer_size=1000000, @@local.sort_buffer_size=1000000;
```

The `@@var_name` syntax for system variables is supported for compatibility with some other database systems.

If you change a session system variable, the value remains in effect until your session ends or until you change the variable to a different value. The change is not visible to other clients.

If you change a global system variable, the value is remembered and used for new connections until the server restarts. (To make a global system variable setting permanent, you should set it in an option file.) The change is visible to any client that accesses that global variable. However, the change affects the corresponding session variable only for clients that connect after the change. The global variable change does not affect the session variable for any client that is currently connected (not even that of the client that issues the `SET GLOBAL` statement).

To prevent incorrect usage, MySQL produces an error if you use `SET GLOBAL` with a variable that can only be used with `SET SESSION` or if you do not specify `GLOBAL` (or `@global.`) when setting a global variable.

To set a `SESSION` variable to the `GLOBAL` value or a `GLOBAL` value to the compiled-in MySQL default value, use the `DEFAULT` keyword. For example, the following two statements are identical in setting the session value of `max_join_size` to the global value:

```
SET max_join_size=DEFAULT;
SET @@session.max_join_size=@@global.max_join_size;
```

Not all system variables can be set to `DEFAULT`. In such cases, use of `DEFAULT` results in an error.

You can refer to the values of specific global or session system variables in expressions by using one of the `@@`-modifiers. For example, you can retrieve values in a `SELECT` statement like this:

```
SELECT @@global.sql_mode, @@session.sql_mode, @@sql_mode;
```

When you refer to a system variable in an expression as `@@var_name` (that is, when you do not specify `@@global.` or `@@session.`), MySQL returns the session value if it exists and the global value otherwise. (This differs from `SET @@var_name = value`, which always refers to the session value.)

### Note

Some variables displayed by `SHOW VARIABLES` may not be available using `SELECT @@var_name` syntax; an `Unknown system variable` occurs. As a workaround in such cases, you can use `SHOW VARIABLES LIKE 'var_name'`.

Suffixes for specifying a value multiplier can be used when setting a variable at server startup, but not to set the value with `SET` at runtime. On the other hand, with `SET` you can assign a variable's value using an expression, which is not true when you set a variable at server startup. For example, the first of the following lines is legal at server startup, but the second is not:

```
shell> mysql --max_allowed_packet=16M
shell> mysql --max_allowed_packet=16*1024*1024
```

Conversely, the second of the following lines is legal at runtime, but the first is not:

```
mysql> SET GLOBAL max_allowed_packet=16M;
mysql> SET GLOBAL max_allowed_packet=16*1024*1024;
```

### Note

Some system variables can be enabled with the `SET` statement by setting them to `ON` or `1`, or disabled by setting them to `OFF` or `0`. However, to set such a variable on the command line or in an option file, you must set it to `1` or `0`; setting it to `ON` or `OFF` will not work. For example, on the command line, `--delay_key_write=1` works but `--delay_key_write=ON` does not.

To display system variable names and values, use the `SHOW VARIABLES` statement:

```
mysql> SHOW VARIABLES;
+-----+-----+
| Variable_name | Value |
+-----+-----+
| auto_increment_increment | 1 |
| auto_increment_offset | 1 |
| automatic_sp_privileges | ON |
| back_log | 50 |
| basedir | /home/mysql/ |
| binlog_cache_size | 32768 |
| bulk_insert_buffer_size | 8388608 |
| character_set_client | latin1 |
| character_set_connection | latin1 |
| character_set_database | latin1 |
| character_set_results | latin1 |
| character_set_server | latin1 |
| character_set_system | utf8 |
| character_sets_dir | /home/mysql/share/mysql/charsets/ |
| collation_connection | latin1_swedish_ci |
| collation_database | latin1_swedish_ci |
| collation_server | latin1_swedish_ci |
| ... | ... |
| innodb_additional_mem_pool_size | 1048576 |
| innodb_autoextend_increment | 8 |
| innodb_buffer_pool_size | 8388608 |
| innodb_checksums | ON |
| innodb_commit_concurrency | 0 |
| innodb_concurrency_tickets | 500 |
| innodb_data_file_path | ibdata1:10M:autoextend |
| innodb_data_home_dir |
```



```

...
version                | 5.1.6-alpha-log          |
version_comment        | Source distribution      |
version_compile_machine| i686                     |
version_compile_os     | suse-linux              |
wait_timeout           | 28800                    |
+-----+-----+-----+

```

With a [LIKE](#) clause, the statement displays only those variables that match the pattern. To obtain a specific variable name, use a [LIKE](#) clause as shown:

```

SHOW VARIABLES LIKE 'max_join_size';
SHOW SESSION VARIABLES LIKE 'max_join_size';

```

To get a list of variables whose name match a pattern, use the “%” wildcard character in a [LIKE](#) clause:

```

SHOW VARIABLES LIKE '%size%';
SHOW GLOBAL VARIABLES LIKE '%size%';

```

Wildcard characters can be used in any position within the pattern to be matched. Strictly speaking, because “\_” is a wildcard that matches any single character, you should escape it as “\\_” to match it literally. In practice, this is rarely necessary.

For [SHOW VARIABLES](#), if you specify neither [GLOBAL](#) nor [SESSION](#), MySQL returns [SESSION](#) values.

The reason for requiring the [GLOBAL](#) keyword when setting [GLOBAL](#)-only variables but not when retrieving them is to prevent problems in the future. If we were to remove a [SESSION](#) variable that has the same name as a [GLOBAL](#) variable, a client with the [SUPER](#) privilege might accidentally change the [GLOBAL](#) variable rather than just the [SESSION](#) variable for its own connection. If we add a [SESSION](#) variable with the same name as a [GLOBAL](#) variable, a client that intends to change the [GLOBAL](#) variable might find only its own [SESSION](#) variable changed.

### 5.1.5.1. Structured System Variables

A structured variable differs from a regular system variable in two respects:

- Its value is a structure with components that specify server parameters considered to be closely related.
- There might be several instances of a given type of structured variable. Each one has a different name and refers to a different resource maintained by the server.

MySQL 5.1 supports one structured variable type, which specifies parameters governing the operation of key caches. A key cache structured variable has these components:

- [key\\_buffer\\_size](#)
- [key\\_cache\\_block\\_size](#)
- [key\\_cache\\_division\\_limit](#)
- [key\\_cache\\_age\\_threshold](#)

This section describes the syntax for referring to structured variables. Key cache variables are used for syntax examples, but specific details about how key caches operate are found elsewhere, in [Section 7.4.5, “The MyISAM Key Cache”](#).

To refer to a component of a structured variable instance, you can use a compound name in *instance\_name.component\_name* format. Examples:

```

hot_cache.key_buffer_size
hot_cache.key_cache_block_size
cold_cache.key_cache_block_size

```

For each structured system variable, an instance with the name of [default](#) is always predefined. If you refer to a component of a structured variable without any instance name, the [default](#) instance is used. Thus, [default.key\\_buffer\\_size](#) and [key\\_buffer\\_size](#) both refer to the same system variable.

Structured variable instances and components follow these naming rules:

- For a given type of structured variable, each instance must have a name that is unique *within* variables of that type. However, instance names need not be unique *across* structured variable types. For example, each structured variable has an instance

named `default`, so `default` is not unique across variable types.

- The names of the components of each structured variable type must be unique across all system variable names. If this were not true (that is, if two different types of structured variables could share component member names), it would not be clear which default structured variable to use for references to member names that are not qualified by an instance name.
- If a structured variable instance name is not legal as an unquoted identifier, refer to it as a quoted identifier using backticks. For example, `hot-cache` is not legal, but ``hot-cache`` is.
- `global`, `session`, and `local` are not legal instance names. This avoids a conflict with notation such as `@@global.var_name` for referring to non-structured system variables.

Currently, the first two rules have no possibility of being violated because the only structured variable type is the one for key caches. These rules will assume greater significance if some other type of structured variable is created in the future.

With one exception, you can refer to structured variable components using compound names in any context where simple variable names can occur. For example, you can assign a value to a structured variable using a command-line option:

```
shell> mysqld --hot_cache.key_buffer_size=64K
```

In an option file, use this syntax:

```
[mysqld]
hot_cache.key_buffer_size=64K
```

If you start the server with this option, it creates a key cache named `hot_cache` with a size of 64KB in addition to the default key cache that has a default size of 8MB.

Suppose that you start the server as follows:

```
shell> mysqld --key_buffer_size=256K \
--extra_cache.key_buffer_size=128K \
--extra_cache.key_cache_block_size=2048
```

In this case, the server sets the size of the default key cache to 256KB. (You could also have written `--default.key_buffer_size=256K`.) In addition, the server creates a second key cache named `extra_cache` that has a size of 128KB, with the size of block buffers for caching table index blocks set to 2048 bytes.

The following example starts the server with three different key caches having sizes in a 3:1:1 ratio:

```
shell> mysqld --key_buffer_size=6M \
--hot_cache.key_buffer_size=2M \
--cold_cache.key_buffer_size=2M
```

Structured variable values may be set and retrieved at runtime as well. For example, to set a key cache named `hot_cache` to a size of 10MB, use either of these statements:

```
mysql> SET GLOBAL hot_cache.key_buffer_size = 10*1024*1024;
mysql> SET @@global.hot_cache.key_buffer_size = 10*1024*1024;
```

To retrieve the cache size, do this:

```
mysql> SELECT @@global.hot_cache.key_buffer_size;
```

However, the following statement does not work. The variable is not interpreted as a compound name, but as a simple string for a `LIKE` pattern-matching operation:

```
mysql> SHOW GLOBAL VARIABLES LIKE 'hot_cache.key_buffer_size';
```

This is the exception to being able to use structured variable names anywhere a simple variable name may occur.

### 5.1.5.2. Dynamic System Variables

Many server system variables are dynamic and can be set at runtime using `SET GLOBAL` or `SET SESSION`. You can also obtain their values using `SELECT`. See [Section 5.1.5, “Using System Variables”](#).

The following table shows the full list of all dynamic system variables. The last column indicates for each variable whether `GLOBAL` or `SESSION` (or both) apply. The table also lists session options that can be set with the `SET` statement. [Section 5.1.4, “Session](#)

[System Variables](#)”, discusses these options.

Variables that have a type of “string” take a string value. Variables that have a type of “numeric” take a numeric value. Variables that have a type of “boolean” can be set to 0, 1, **ON** or **OFF**. (If you set them on the command line or in an option file, use the numeric values.) Variables that are marked as “enumeration” normally should be set to one of the available values for the variable, but can also be set to the number that corresponds to the desired enumeration value. For enumerated system variables, the first enumeration value corresponds to 0. This differs from **ENUM** columns, for which the first enumeration value corresponds to 1.

Variable Name	Variable Type	Variable Scope
auto_increment_increment	numeric	GLOBAL   SESSION
auto_increment_offset	numeric	GLOBAL   SESSION
autocommit	boolean	SESSION
automatic_sp_privileges	boolean	GLOBAL
big_tables	boolean	SESSION
binlog_cache_size	numeric	GLOBAL
binlog_format	enumeration	GLOBAL   SESSION
bulk_insert_buffer_size	numeric	GLOBAL   SESSION
character_set_client	string	GLOBAL   SESSION
character_set_connection	string	GLOBAL   SESSION
character_set_database	string	GLOBAL   SESSION
character_set_filesystem	string	GLOBAL   SESSION
character_set_results	string	GLOBAL   SESSION
character_set_server	string	GLOBAL   SESSION
collation_connection	string	GLOBAL   SESSION
collation_database	string	GLOBAL   SESSION
collation_server	string	GLOBAL   SESSION
completion_type	numeric	GLOBAL   SESSION
concurrent_insert	boolean	GLOBAL
connect_timeout	numeric	GLOBAL
date_format	string	GLOBAL   SESSION
datetime_format	string	GLOBAL   SESSION
debug	string	GLOBAL   SESSION
default_week_format	numeric	GLOBAL   SESSION
delay_key_write	enumeration	GLOBAL
delayed_insert_limit	numeric	GLOBAL
delayed_insert_timeout	numeric	GLOBAL
delayed_queue_size	numeric	GLOBAL
div_precision_increment	numeric	GLOBAL   SESSION
engine_condition_pushdown	boolean	GLOBAL   SESSION
event_scheduler	enumeration	GLOBAL
expire_logs_days	numeric	GLOBAL
flush	boolean	GLOBAL
flush_time	numeric	GLOBAL
foreign_key_checks	boolean	SESSION
ft_boolean_syntax	string	GLOBAL
general_log	boolean	GLOBAL
general_log_file	filename	GLOBAL
group_concat_max_len	numeric	GLOBAL   SESSION
identity	numeric	SESSION
init_connect	string	GLOBAL
init_slave	string	GLOBAL
innodb_autoextend_increment	numeric	GLOBAL

Variable Name	Variable Type	Variable Scope
<code>innodb_commit_concurrency</code>	numeric	GLOBAL
<code>innodb_concurrency_tickets</code>	numeric	GLOBAL
<code>innodb_fast_shutdown</code>	boolean	GLOBAL
<code>innodb_flush_log_at_trx_commit</code>	numeric	GLOBAL
<code>innodb_max_dirty_pages_pct</code>	numeric	GLOBAL
<code>innodb_max_purge_lag</code>	numeric	GLOBAL
<code>innodb_stats_on_metadata</code>	boolean	GLOBAL
<code>innodb_support_xa</code>	boolean	GLOBAL   SESSION
<code>innodb_sync_spin_loops</code>	numeric	GLOBAL
<code>innodb_table_locks</code>	boolean	GLOBAL   SESSION
<code>innodb_thread_concurrency</code>	numeric	GLOBAL
<code>innodb_thread_sleep_delay</code>	numeric	GLOBAL
<code>innodb_use_legacy_cardinality_algorithm</code>	boolean	GLOBAL
<code>insert_id</code>	numeric	SESSION
<code>interactive_timeout</code>	numeric	GLOBAL   SESSION
<code>join_buffer_size</code>	numeric	GLOBAL   SESSION
<code>keep_files_on_create</code>	boolean	GLOBAL   SESSION
<code>key_buffer_size</code>	numeric	GLOBAL
<code>key_cache_age_threshold</code>	numeric	GLOBAL
<code>key_cache_block_size</code>	numeric	GLOBAL
<code>key_cache_division_limit</code>	numeric	GLOBAL
<code>last_insert_id</code>	numeric	SESSION
<code>lc_time_names</code>	string	GLOBAL   SESSION
<code>local_infile</code>		GLOBAL
<code>log</code>	string	GLOBAL
<code>log_bin_trust_function_creators</code>	boolean	GLOBAL
<code>log_bin_trust_routine_creators</code>	boolean	GLOBAL
<code>log_output</code>	enumeration	GLOBAL
<code>log_queries_not_using_indexes</code>	boolean	GLOBAL
<code>log_slow_queries</code>	boolean	GLOBAL
<code>log_warnings</code>	numeric	GLOBAL   SESSION
<code>long_query_time</code>	numeric	GLOBAL   SESSION
<code>low_priority_updates</code>	boolean	GLOBAL   SESSION
<code>max_allowed_packet</code>	numeric	GLOBAL   SESSION
<code>max_binlog_cache_size</code>	numeric	GLOBAL
<code>max_binlog_size</code>	numeric	GLOBAL
<code>max_connect_errors</code>	numeric	GLOBAL
<code>max_connections</code>	numeric	GLOBAL
<code>max_delayed_threads</code>	numeric	GLOBAL   SESSION
<code>max_error_count</code>	numeric	GLOBAL   SESSION
<code>max_heap_table_size</code>	numeric	GLOBAL   SESSION
<code>max_insert_delayed_threads</code>	numeric	GLOBAL   SESSION
<code>max_join_size</code>	numeric	GLOBAL   SESSION
<code>max_length_for_sort_data</code>	numeric	GLOBAL   SESSION
<code>max_prepared_stmt_count</code>	numeric	GLOBAL
<code>max_relay_log_size</code>	numeric	GLOBAL
<code>max_seeks_for_key</code>	numeric	GLOBAL   SESSION

Variable Name	Variable Type	Variable Scope
max_sort_length	numeric	GLOBAL   SESSION
max_sp_recursion_depth	numeric	GLOBAL   SESSION
max_tmp_tables	numeric	GLOBAL   SESSION
max_user_connections	numeric	GLOBAL   SESSION
max_write_lock_count	numeric	GLOBAL
min_examined_row_limit	numeric	GLOBAL   SESSION
multi_range_count	numeric	GLOBAL   SESSION
myisam_data_pointer_size	numeric	GLOBAL
myisam_max_sort_file_size	numeric	GLOBAL
myisam_repair_threads	numeric	GLOBAL   SESSION
myisam_sort_buffer_size	numeric	GLOBAL   SESSION
myisam_stats_method	enumeration	GLOBAL   SESSION
myisam_use_mmap	boolean	GLOBAL
ndb_autoincrement_prefetch_sz	numeric	GLOBAL   SESSION
ndb_cache_check_time	numeric	GLOBAL
ndb_extra_logging	numeric	GLOBAL
ndb_force_send	boolean	GLOBAL   SESSION
ndb_log_empty_epochs	boolean	GLOBAL
ndb_log_update_as_write	boolean	GLOBAL
ndb_log_updated_only	boolean	GLOBAL
ndb_optimization_delay	numeric	GLOBAL
ndb_table_no_logging	boolean	SESSION
ndb_table_temporary	boolean	SESSION
ndb_use_exact_count	boolean	GLOBAL   SESSION
net_buffer_length	numeric	GLOBAL   SESSION
net_read_timeout	numeric	GLOBAL   SESSION
net_retry_count	numeric	GLOBAL   SESSION
net_write_timeout	numeric	GLOBAL   SESSION
new	boolean	GLOBAL   SESSION
old_passwords	boolean	GLOBAL   SESSION
optimizer_prune_level	boolean	GLOBAL   SESSION
optimizer_search_depth	numeric	GLOBAL   SESSION
optimizer_switch	set	GLOBAL   SESSION
preload_buffer_size	numeric	GLOBAL   SESSION
profiling	boolean	SESSION
profiling_history_size	numeric	GLOBAL   SESSION
query_alloc_block_size	numeric	GLOBAL   SESSION
query_cache_limit	numeric	GLOBAL
query_cache_min_res_unit	numeric	GLOBAL
query_cache_size	numeric	GLOBAL
query_cache_type	enumeration	GLOBAL   SESSION
query_cache_wlock_invalidate	boolean	GLOBAL   SESSION
query_prealloc_size	numeric	GLOBAL   SESSION
rand_seed1	numeric	SESSION
rand_seed2	numeric	SESSION
range_alloc_block_size	numeric	GLOBAL   SESSION
read_buffer_size	numeric	GLOBAL   SESSION

Variable Name	Variable Type	Variable Scope
<code>read_only</code>	numeric	GLOBAL
<code>read_rnd_buffer_size</code>	numeric	GLOBAL   SESSION
<code>relay_log_purge</code>	boolean	GLOBAL
<code>rpl_recovery_rank</code>	numeric	GLOBAL
<code>safe_show_database</code>	boolean	GLOBAL
<code>secure_auth</code>	boolean	GLOBAL
<code>server_id</code>	numeric	GLOBAL
<code>slave_allow_batching</code>	boolean	GLOBAL
<code>slave_compressed_protocol</code>	boolean	GLOBAL
<code>slave_exec_mode</code>	enumeration	GLOBAL
<code>slave_net_timeout</code>	numeric	GLOBAL
<code>slave_transaction_retries</code>	numeric	GLOBAL
<code>slow_launch_time</code>	numeric	GLOBAL
<code>slow_query_log</code>	boolean	GLOBAL
<code>slow_query_log_file</code>	filename	GLOBAL
<code>sort_buffer_size</code>	numeric	GLOBAL   SESSION
<code>sql_auto_is_null</code>	boolean	SESSION
<code>sql_big_selects</code>	boolean	SESSION
<code>sql_big_tables</code>	boolean	SESSION
<code>sql_buffer_result</code>	boolean	SESSION
<code>sql_log_bin</code>	boolean	SESSION
<code>sql_log_off</code>	boolean	SESSION
<code>sql_log_update</code>	boolean	SESSION
<code>sql_low_priority_updates</code>	boolean	GLOBAL   SESSION
<code>sql_max_join_size</code>	numeric	GLOBAL   SESSION
<code>sql_mode</code>	set	GLOBAL   SESSION
<code>sql_notes</code>	boolean	SESSION
<code>sql_quote_show_create</code>	boolean	SESSION
<code>sql_safe_updates</code>	boolean	SESSION
<code>sql_select_limit</code>	numeric	GLOBAL   SESSION
<code>sql_slave_skip_counter</code>	numeric	GLOBAL
<code>sql_warnings</code>	boolean	SESSION
<code>storage_engine</code>	enumeration	GLOBAL   SESSION
<code>sync_binlog</code>	numeric	GLOBAL
<code>sync_frm</code>	boolean	GLOBAL
<code>table_cache</code>	numeric	GLOBAL
<code>table_definition_cache</code>	numeric	GLOBAL
<code>table_lock_wait_timeout</code>	numeric	GLOBAL
<code>table_open_cache</code>	numeric	GLOBAL
<code>table_type</code>	enumeration	GLOBAL   SESSION
<code>thread_cache_size</code>	numeric	GLOBAL
<code>time_format</code>	string	GLOBAL   SESSION
<code>time_zone</code>	string	GLOBAL   SESSION
<code>timed_mutexes</code>	boolean	GLOBAL
<code>timestamp</code>	string	SESSION
<code>tmp_table_size</code>	numeric	GLOBAL   SESSION
<code>transaction_alloc_block_size</code>	numeric	GLOBAL   SESSION

Variable Name	Variable Type	Variable Scope
<code>transaction_allow_batching</code>	boolean	SESSION
<code>transaction_prealloc_size</code>	numeric	GLOBAL   SESSION
<code>tx_isolation</code>	enumeration	GLOBAL   SESSION
<code>unique_checks</code>	boolean	SESSION
<code>updatable_views_with_limit</code>	boolean	GLOBAL   SESSION
<code>wait_timeout</code>	numeric	GLOBAL   SESSION

### MySQL Enterprise

Improper configuration of system variables can adversely affect performance and security. The MySQL Enterprise Monitor continually monitors system variables and provides expert advice about appropriate settings. For more information, see <http://www.mysql.com/products/enterprise/advisors.html>.

## 5.1.6. Server Status Variables

The server maintains many status variables that provide information about its operation. You can view these variables and their values by using the `SHOW [GLOBAL | SESSION] STATUS` statement (see Section 12.5.5.37, “`SHOW STATUS Syntax`”). The optional `GLOBAL` keyword aggregates the values over all connections, and `SESSION` shows the values for the current connection.

```
mysql> SHOW GLOBAL STATUS;
```

Variable_name	Value
Aborted_clients	0
Aborted_connects	0
Bytes_received	155372598
Bytes_sent	1176560426
...	
Connections	30023
Created_tmp_disk_tables	0
Created_tmp_files	3
Created_tmp_tables	2
...	
Threads_created	217
Threads_running	88
Uptime	1389872

The following table lists all available server status variables:

Variable Name	Variable Type	Variable Scope
<code>Aborted_clients</code>	numeric	GLOBAL
<code>Aborted_connects</code>	numeric	GLOBAL
<code>Binlog_cache_disk_use</code>	numeric	GLOBAL
<code>Binlog_cache_use</code>	numeric	GLOBAL
<code>Bytes_received</code>	numeric	GLOBAL   SESSION
<code>Bytes_sent</code>	numeric	GLOBAL   SESSION
<code>Com_admin_commands</code>	numeric	GLOBAL   SESSION
<code>Com_alter_db</code>	numeric	GLOBAL   SESSION
<code>Com_alter_event</code>	numeric	GLOBAL   SESSION
<code>Com_alter_table</code>	numeric	GLOBAL   SESSION
<code>Com_analyze</code>	numeric	GLOBAL   SESSION
<code>Com_backup_table</code>	numeric	GLOBAL   SESSION
<code>Com_begin</code>	numeric	GLOBAL   SESSION
<code>Com_call_procedure</code>	numeric	GLOBAL   SESSION
<code>Com_change_db</code>	numeric	GLOBAL   SESSION
<code>Com_change_master</code>	numeric	GLOBAL   SESSION
<code>Com_check</code>	numeric	GLOBAL   SESSION
<code>Com_checksum</code>	numeric	GLOBAL   SESSION
<code>Com_commit</code>	numeric	GLOBAL   SESSION

Variable Name	Variable Type	Variable Scope
Com_create_db	numeric	GLOBAL   SESSION
Com_create_event	numeric	GLOBAL   SESSION
Com_create_function	numeric	GLOBAL   SESSION
Com_create_index	numeric	GLOBAL   SESSION
Com_create_table	numeric	GLOBAL   SESSION
Com_create_user	numeric	GLOBAL   SESSION
Com_dealloc_sql	numeric	GLOBAL   SESSION
Com_delete	numeric	GLOBAL   SESSION
Com_delete_multi	numeric	GLOBAL   SESSION
Com_do	numeric	GLOBAL   SESSION
Com_drop_db	numeric	GLOBAL   SESSION
Com_drop_event	numeric	GLOBAL   SESSION
Com_drop_function	numeric	GLOBAL   SESSION
Com_drop_index	numeric	GLOBAL   SESSION
Com_drop_table	numeric	GLOBAL   SESSION
Com_drop_user	numeric	GLOBAL   SESSION
Com_execute_sql	numeric	GLOBAL   SESSION
Com_flush	numeric	GLOBAL   SESSION
Com_grant	numeric	GLOBAL   SESSION
Com_ha_close	numeric	GLOBAL   SESSION
Com_ha_open	numeric	GLOBAL   SESSION
Com_ha_read	numeric	GLOBAL   SESSION
Com_help	numeric	GLOBAL   SESSION
Com_insert	numeric	GLOBAL   SESSION
Com_insert_select	numeric	GLOBAL   SESSION
Com_kill	numeric	GLOBAL   SESSION
Com_load	numeric	GLOBAL   SESSION
Com_lock_tables	numeric	GLOBAL   SESSION
Com_optimize	numeric	GLOBAL   SESSION
Com_preload_keys	numeric	GLOBAL   SESSION
Com_prepare_sql	numeric	GLOBAL   SESSION
Com_purge	numeric	GLOBAL   SESSION
Com_purge_before_date	numeric	GLOBAL   SESSION
Com_rename_table	numeric	GLOBAL   SESSION
Com_repair	numeric	GLOBAL   SESSION
Com_replace	numeric	GLOBAL   SESSION
Com_replace_select	numeric	GLOBAL   SESSION
Com_reset	numeric	GLOBAL   SESSION
Com_restore_table	numeric	GLOBAL   SESSION
Com_revoke	numeric	GLOBAL   SESSION
Com_revoke_all	numeric	GLOBAL   SESSION
Com_rollback	numeric	GLOBAL   SESSION
Com_savepoint	numeric	GLOBAL   SESSION
Com_select	numeric	GLOBAL   SESSION
Com_set_option	numeric	GLOBAL   SESSION
Com_show_binlog_events	numeric	GLOBAL   SESSION
Com_show_binlogs	numeric	GLOBAL   SESSION



Variable Name	Variable Type	Variable Scope
Com_show_charsets	numeric	GLOBAL   SESSION
Com_show_collations	numeric	GLOBAL   SESSION
Com_show_column_types	numeric	GLOBAL   SESSION
Com_show_create_db	numeric	GLOBAL   SESSION
Com_show_create_event	numeric	GLOBAL   SESSION
Com_show_create_table	numeric	GLOBAL   SESSION
Com_show_databases	numeric	GLOBAL   SESSION
Com_show_engine_logs	numeric	GLOBAL   SESSION
Com_show_engine_mutex	numeric	GLOBAL   SESSION
Com_show_engine_status	numeric	GLOBAL   SESSION
Com_show_errors	numeric	GLOBAL   SESSION
Com_show_events	numeric	GLOBAL   SESSION
Com_show_fields	numeric	GLOBAL   SESSION
Com_show_grants	numeric	GLOBAL   SESSION
Com_show_innodb_status	numeric	GLOBAL   SESSION
Com_show_keys	numeric	GLOBAL   SESSION
Com_show_logs	numeric	GLOBAL   SESSION
Com_show_master_status	numeric	GLOBAL   SESSION
Com_show_ndb_status	numeric	GLOBAL   SESSION
Com_show_new_master	numeric	GLOBAL   SESSION
Com_show_open_tables	numeric	GLOBAL   SESSION
Com_show_plugins	numeric	GLOBAL   SESSION
Com_show_privileges	numeric	GLOBAL   SESSION
Com_show_processlist	numeric	GLOBAL   SESSION
Com_show_profile	numeric	GLOBAL   SESSION
Com_show_profiles	numeric	GLOBAL   SESSION
Com_show_slave_hosts	numeric	GLOBAL   SESSION
Com_show_slave_status	numeric	GLOBAL   SESSION
Com_show_status	numeric	GLOBAL   SESSION
Com_show_storage_engines	numeric	GLOBAL   SESSION
Com_show_tables	numeric	GLOBAL   SESSION
Com_show_triggers	numeric	GLOBAL   SESSION
Com_show_variables	numeric	GLOBAL   SESSION
Com_show_warnings	numeric	GLOBAL   SESSION
Com_slave_start	numeric	GLOBAL   SESSION
Com_slave_stop	numeric	GLOBAL   SESSION
Com_stmt_close	numeric	GLOBAL   SESSION
Com_stmt_execute	numeric	GLOBAL   SESSION
Com_stmt_fetch	numeric	GLOBAL   SESSION
Com_stmt_prepare	numeric	GLOBAL   SESSION
Com_stmt_reprepare	numeric	GLOBAL   SESSION
Com_stmt_reset	numeric	GLOBAL   SESSION
Com_stmt_send_long_data	numeric	GLOBAL   SESSION
Com_truncate	numeric	GLOBAL   SESSION
Com_unlock_tables	numeric	GLOBAL   SESSION
Com_update	numeric	GLOBAL   SESSION
Com_update_multi	numeric	GLOBAL   SESSION

Variable Name	Variable Type	Variable Scope
Com_xa_commit	numeric	GLOBAL   SESSION
Com_xa_end	numeric	GLOBAL   SESSION
Com_xa_prepare	numeric	GLOBAL   SESSION
Com_xa_recover	numeric	GLOBAL   SESSION
Com_xa_rollback	numeric	GLOBAL   SESSION
Com_xa_start	numeric	GLOBAL   SESSION
Compression	numeric	SESSION
Connections	numeric	GLOBAL
Created_tmp_disk_tables	numeric	GLOBAL   SESSION
Created_tmp_files	numeric	GLOBAL
Created_tmp_tables	numeric	GLOBAL   SESSION
Delayed_errors	numeric	GLOBAL
Delayed_insert_threads	numeric	GLOBAL
Delayed_writes	numeric	GLOBAL
Flush_commands	numeric	GLOBAL
Handler_commit	numeric	GLOBAL   SESSION
Handler_delete	numeric	GLOBAL   SESSION
Handler_discover	numeric	GLOBAL   SESSION
Handler_prepare	numeric	GLOBAL   SESSION
Handler_read_first	numeric	GLOBAL   SESSION
Handler_read_key	numeric	GLOBAL   SESSION
Handler_read_next	numeric	GLOBAL   SESSION
Handler_read_prev	numeric	GLOBAL   SESSION
Handler_read_rnd	numeric	GLOBAL   SESSION
Handler_read_rnd_next	numeric	GLOBAL   SESSION
Handler_rollback	numeric	GLOBAL   SESSION
Handler_savepoint	numeric	GLOBAL   SESSION
Handler_savepoint_rollback	numeric	GLOBAL   SESSION
Handler_update	numeric	GLOBAL   SESSION
Handler_write	numeric	GLOBAL   SESSION
InnoDB_buffer_pool_pages_data	numeric	GLOBAL
InnoDB_buffer_pool_pages_dirty	numeric	GLOBAL
InnoDB_buffer_pool_pages_flushed	numeric	GLOBAL
InnoDB_buffer_pool_pages_free	numeric	GLOBAL
InnoDB_buffer_pool_pages_latched	numeric	GLOBAL
InnoDB_buffer_pool_pages_misc	numeric	GLOBAL
InnoDB_buffer_pool_pages_total	numeric	GLOBAL
InnoDB_buffer_pool_read_ahead_rnd	numeric	GLOBAL
InnoDB_buffer_pool_read_ahead_seq	numeric	GLOBAL
InnoDB_buffer_pool_read_requests	numeric	GLOBAL
InnoDB_buffer_pool_reads	numeric	GLOBAL
InnoDB_buffer_pool_wait_free	numeric	GLOBAL
InnoDB_buffer_pool_write_requests	numeric	GLOBAL
InnoDB_data_fsyncs	numeric	GLOBAL
InnoDB_data_pending_fsyncs	numeric	GLOBAL
InnoDB_data_pending_reads	numeric	GLOBAL
InnoDB_data_pending_writes	numeric	GLOBAL

Variable Name	Variable Type	Variable Scope
Innodb_data_read	numeric	GLOBAL
Innodb_data_reads	numeric	GLOBAL
Innodb_data_writes	numeric	GLOBAL
Innodb_data_written	numeric	GLOBAL
Innodb_dblwr_pages_written	numeric	GLOBAL
Innodb_dblwr_writes	numeric	GLOBAL
Innodb_log_waits	numeric	GLOBAL
Innodb_log_write_requests	numeric	GLOBAL
Innodb_log_writes	numeric	GLOBAL
Innodb_os_log_fsyncs	numeric	GLOBAL
Innodb_os_log_pending_fsyncs	numeric	GLOBAL
Innodb_os_log_pending_writes	numeric	GLOBAL
Innodb_os_log_written	numeric	GLOBAL
Innodb_page_size	numeric	GLOBAL
Innodb_pages_created	numeric	GLOBAL
Innodb_pages_read	numeric	GLOBAL
Innodb_pages_written	numeric	GLOBAL
Innodb_row_lock_current_waits	numeric	GLOBAL
Innodb_row_lock_time	numeric	GLOBAL
Innodb_row_lock_time_avg	numeric	GLOBAL
Innodb_row_lock_time_max	numeric	GLOBAL
Innodb_row_lock_waits	numeric	GLOBAL
Innodb_rows_deleted	numeric	GLOBAL
Innodb_rows_inserted	numeric	GLOBAL
Innodb_rows_read	numeric	GLOBAL
Innodb_rows_updated	numeric	GLOBAL
Key_blocks_not_flushed	numeric	GLOBAL
Key_blocks_unused	numeric	GLOBAL
Key_blocks_used	numeric	GLOBAL
Key_read_requests	numeric	GLOBAL
Key_reads	numeric	GLOBAL
Key_write_requests	numeric	GLOBAL
Key_writes	numeric	GLOBAL
Last_query_cost	numeric	SESSION
Max_used_connections	numeric	GLOBAL
ndb-cluster-connection-pool	numeric	GLOBAL
Ndb_cluster_node_id	numeric	GLOBAL   SESSION
Ndb_config_from_host	numeric	GLOBAL   SESSION
Ndb_config_from_port	numeric	GLOBAL   SESSION
Ndb_conflict_fn_max	numeric	GLOBAL
Ndb_conflict_fn_old	numeric	GLOBAL
ndb_execute_count	numeric	GLOBAL
ndb-nodeid	numeric	GLOBAL
Ndb_number_of_data_nodes	numeric	GLOBAL
ndb_pruned_scan_count	numeric	GLOBAL
ndb_scan_count	numeric	GLOBAL
Not_flushed_delayed_rows	numeric	GLOBAL

Variable Name	Variable Type	Variable Scope
Open_files	numeric	GLOBAL
Open_streams	numeric	GLOBAL
Open_table_definitions	numeric	GLOBAL
Open_tables	numeric	GLOBAL   SESSION
Opened_files	numeric	GLOBAL
Opened_table_definitions	numeric	GLOBAL   SESSION
Opened_tables	numeric	GLOBAL   SESSION
Prepared_stmt_count	numeric	GLOBAL
Qcache_free_blocks	numeric	GLOBAL
Qcache_free_memory	numeric	GLOBAL
Qcache_hits	numeric	GLOBAL
Qcache_inserts	numeric	GLOBAL
Qcache_lowmem_prunes	numeric	GLOBAL
Qcache_not_cached	numeric	GLOBAL
Qcache_queries_in_cache	numeric	GLOBAL
Qcache_total_blocks	numeric	GLOBAL
Queries	numeric	GLOBAL   SESSION
Questions	numeric	GLOBAL   SESSION
Rpl_status	string	GLOBAL
Select_full_join	numeric	GLOBAL   SESSION
Select_full_range_join	numeric	GLOBAL   SESSION
Select_range	numeric	GLOBAL   SESSION
Select_range_check	numeric	GLOBAL   SESSION
Select_scan	numeric	GLOBAL   SESSION
Slave_heartbeat_period		GLOBAL
Slave_open_temp_tables	numeric	GLOBAL
Slave_received_heartbeats		GLOBAL
Slave_retried_transactions	numeric	GLOBAL
Slave_running	boolean	GLOBAL
Slow_launch_threads	numeric	GLOBAL   SESSION
Slow_queries	numeric	GLOBAL   SESSION
Sort_merge_passes	numeric	GLOBAL   SESSION
Sort_range	numeric	GLOBAL   SESSION
Sort_rows	numeric	GLOBAL   SESSION
Sort_scan	numeric	GLOBAL   SESSION
Ssl_accept_renegotiates	numeric	GLOBAL
Ssl_accepts	numeric	GLOBAL
Ssl_callback_cache_hits	numeric	GLOBAL
Ssl_cipher	string	GLOBAL   SESSION
Ssl_cipher_list	string	GLOBAL   SESSION
Ssl_client_connects	numeric	GLOBAL
Ssl_connect_renegotiates	numeric	GLOBAL
Ssl_ctx_verify_depth	numeric	GLOBAL
Ssl_ctx_verify_mode	numeric	GLOBAL
Ssl_default_timeout	numeric	GLOBAL   SESSION
Ssl_finished_accepts	numeric	GLOBAL
Ssl_finished_connects	numeric	GLOBAL

Variable Name	Variable Type	Variable Scope
<code>Ssl_session_cache_hits</code>	numeric	GLOBAL
<code>Ssl_session_cache_misses</code>	numeric	GLOBAL
<code>Ssl_session_cache_mode</code>	string	GLOBAL
<code>Ssl_session_cache_overflows</code>	numeric	GLOBAL
<code>Ssl_session_cache_size</code>	numeric	GLOBAL
<code>Ssl_session_cache_timeouts</code>	numeric	GLOBAL
<code>Ssl_sessions_reused</code>	numeric	GLOBAL   SESSION
<code>Ssl_used_session_cache_entries</code>	numeric	GLOBAL
<code>Ssl_verify_depth</code>	numeric	GLOBAL   SESSION
<code>Ssl_verify_mode</code>	numeric	GLOBAL   SESSION
<code>Ssl_version</code>	string	GLOBAL   SESSION
<code>Table_locks_immediate</code>	numeric	GLOBAL
<code>Table_locks_waited</code>	numeric	GLOBAL
<code>Tc_log_max_pages_used</code>	numeric	GLOBAL
<code>Tc_log_page_size</code>	numeric	GLOBAL
<code>Tc_log_page_waits</code>	numeric	GLOBAL
<code>Threads_cached</code>	numeric	GLOBAL
<code>Threads_connected</code>	numeric	GLOBAL
<code>Threads_created</code>	numeric	GLOBAL
<code>Threads_running</code>	numeric	GLOBAL
<code>Uptime</code>	numeric	GLOBAL
<code>Uptime_since_flush_status</code>	numeric	GLOBAL

Many status variables are reset to 0 by the `FLUSH STATUS` statement.

#### MySQL Enterprise

For expert advice on using status variables, subscribe to the MySQL Enterprise Monitor. For more information, see <http://www.mysql.com/products/enterprise/advisors.html>.

The status variables have the following meanings. Variables with no version indicated were already present prior to MySQL 5.1. For information regarding their implementation history, see *MySQL 5.0 Reference Manual*.

- `Aborted_clients`

The number of connections that were aborted because the client died without closing the connection properly. See [Section B.1.2.11, “Communication Errors and Aborted Connections”](#).

- `Aborted_connects`

The number of failed attempts to connect to the MySQL server. See [Section B.1.2.11, “Communication Errors and Aborted Connections”](#).

- `Binlog_cache_disk_use`

The number of transactions that used the temporary binary log cache but that exceeded the value of `binlog_cache_size` and used a temporary file to store statements from the transaction.

- `Binlog_cache_use`

The number of transactions that used the temporary binary log cache.

- `Bytes_received`

The number of bytes received from all clients.

- `Bytes_sent`

The number of bytes sent to all clients.

- `Com_xxx`

The `Com_xxx` statement counter variables indicate the number of times each `xxx` statement has been executed. There is one status variable for each type of statement. For example, `Com_delete` and `Com_insert` count `DELETE` and `INSERT` statements, respectively. However, if a query result is returned from query cache, the server increments the `Qcache_hits` status variable, not `Com_select`. See [Section 7.5.5.4, “Query Cache Status and Maintenance”](#).

All of the `Com_stmt_xxx` variables are increased even if a prepared statement argument is unknown or an error occurred during execution. In other words, their values correspond to the number of requests issued, not to the number of requests successfully completed.

The `Com_stmt_xxx` status variables are as follows:

- `Com_stmt_prepare`
- `Com_stmt_execute`
- `Com_stmt_fetch`
- `Com_stmt_send_long_data`
- `Com_stmt_reset`
- `Com_stmt_close`

Those variables stand for prepared statement commands. Their names refer to the `COM_xxx` command set used in the network layer. In other words, their values increase whenever prepared statement API calls such as `mysql_stmt_prepare()`, `mysql_stmt_execute()`, and so forth are executed. However, `Com_stmt_prepare`, `Com_stmt_execute` and `Com_stmt_close` also increase for `PREPARE`, `EXECUTE`, or `DEALLOCATE PREPARE`, respectively. Additionally, the values of the older (available since MySQL 4.1.3) statement counter variables `Com_prepare_sql`, `Com_execute_sql`, and `Com_dealloc_sql` increase for the `PREPARE`, `EXECUTE`, and `DEALLOCATE PREPARE` statements. `Com_stmt_fetch` stands for the total number of network round-trips issued when fetching from cursors.

`Com_stmt_reprepare` indicated the number of times statements were automatically reprepared by the server after metadata changes to tables or views referred to by the statement. This variable was added in MySQL 5.1.25. A reprepare operation increments `Com_stmt_reprepare` is incremented, and also `Com_stmt_prepare`.

- `Compression`

Whether the client connection uses compression in the client/server protocol. Added in MySQL 5.1.2.

- `Connections`

The number of connection attempts (successful or not) to the MySQL server.

- `Created_tmp_disk_tables`

The number of temporary tables on disk created automatically by the server while executing statements.

- `Created_tmp_files`

How many temporary files `mysqld` has created.

- `Created_tmp_tables`

The number of in-memory temporary tables created automatically by the server while executing statements. If `Created_tmp_disk_tables` is large, you may want to increase the `tmp_table_size` value to cause temporary tables to be memory-based instead of disk-based.

- `Delayed_errors`

The number of rows written with `INSERT DELAYED` for which some error occurred (probably `duplicate key`).

- `Delayed_insert_threads`

The number of `INSERT DELAYED` handler threads in use.

- `Delayed_writes`

The number of `INSERT DELAYED` rows written.

- `Flush_commands`

The number of executed `FLUSH` statements.

- `Handler_commit`

The number of internal `COMMIT` statements.

- `Handler_delete`

The number of times that rows have been deleted from tables.

- `Handler_prepare`

A counter for the prepare phase of two-phase commit operations.

- `Handler_read_first`

The number of times the first entry was read from an index. If this value is high, it suggests that the server is doing a lot of full index scans; for example, `SELECT coll FROM foo`, assuming that `coll` is indexed.

- `Handler_read_key`

The number of requests to read a row based on a key. If this value is high, it is a good indication that your tables are properly indexed for your queries.

- `Handler_read_next`

The number of requests to read the next row in key order. This value is incremented if you are querying an index column with a range constraint or if you are doing an index scan.

- `Handler_read_prev`

The number of requests to read the previous row in key order. This read method is mainly used to optimize `ORDER BY ... DESC`.

- `Handler_read_rnd`

The number of requests to read a row based on a fixed position. This value is high if you are doing a lot of queries that require sorting of the result. You probably have a lot of queries that require MySQL to scan entire tables or you have joins that don't use keys properly.

- `Handler_read_rnd_next`

The number of requests to read the next row in the data file. This value is high if you are doing a lot of table scans. Generally this suggests that your tables are not properly indexed or that your queries are not written to take advantage of the indexes you have.

- `Handler_rollback`

The number of requests for a storage engine to perform a rollback operation.

- `Handler_savepoint`

The number of requests for a storage engine to place a savepoint.

- `Handler_savepoint_rollback`

The number of requests for a storage engine to roll back to a savepoint.

- `Handler_update`

The number of requests to update a row in a table.

- `Handler_write`

The number of requests to insert a row in a table.

- `Innodb_buffer_pool_pages_data`

The number of pages containing data (dirty or clean).

- `Innodb_buffer_pool_pages_dirty`

The number of pages currently dirty.

- `Innodb_buffer_pool_pages_flushed`

The number of buffer pool page-flush requests.

- `Innodb_buffer_pool_pages_free`

The number of free pages.

- `Innodb_buffer_pool_pages_latched`

The number of latched pages in `InnoDB` buffer pool. These are pages currently being read or written or that cannot be flushed or removed for some other reason. Calculation of this variable is expensive, so as of MySQL 5.1.28, it is available only when the `UNIV_DEBUG` system is defined at server build time.

- `Innodb_buffer_pool_pages_misc`

The number of pages that are busy because they have been allocated for administrative overhead such as row locks or the adaptive hash index. This value can also be calculated as `Innodb_buffer_pool_pages_total - Innodb_buffer_pool_pages_free - Innodb_buffer_pool_pages_data`.

- `Innodb_buffer_pool_pages_total`

The total size of the buffer pool, in pages.

- `Innodb_buffer_pool_read_ahead_rnd`

The number of “random” read-aheads initiated by `InnoDB`. This happens when a query scans a large portion of a table but in random order.

- `Innodb_buffer_pool_read_ahead_seq`

The number of sequential read-aheads initiated by `InnoDB`. This happens when `InnoDB` does a sequential full table scan.

- `Innodb_buffer_pool_read_requests`

The number of logical read requests `InnoDB` has done.

- `Innodb_buffer_pool_reads`

The number of logical reads that `InnoDB` could not satisfy from the buffer pool and had to do a single-page read.

- `Innodb_buffer_pool_wait_free`

Normally, writes to the `InnoDB` buffer pool happen in the background. However, if it is necessary to read or create a page and no clean pages are available, it is also necessary to wait for pages to be flushed first. This counter counts instances of these waits. If the buffer pool size has been set properly, this value should be small.

- `Innodb_buffer_pool_write_requests`

The number writes done to the `InnoDB` buffer pool.

- `Innodb_data_fsyncs`

The number of `fsync()` operations so far.

- `Innodb_data_pending_fsyncs`

The current number of pending `fsync()` operations.

- `Innodb_data_pending_reads`

The current number of pending reads.

- `Innodb_data_pending_writes`



The current number of pending writes.

- `Innodb_data_read`

The amount of data read so far, in bytes.

- `Innodb_data_reads`

The total number of data reads.

- `Innodb_data_writes`

The total number of data writes.

- `Innodb_data_written`

The amount of data written so far, in bytes.

- `Innodb_dblwr_pages_written`

The number of pages that have been written for doublewrite operations. See [Section 13.6.11.1, “InnoDB Disk I/O”](#).

- `Innodb_dblwr_writes`

The number of doublewrite operations that have been performed. See [Section 13.6.11.1, “InnoDB Disk I/O”](#).

- `Innodb_log_waits`

The number of times that the log buffer was too small and a wait was required for it to be flushed before continuing.

- `Innodb_log_write_requests`

The number of log write requests.

- `Innodb_log_writes`

The number of physical writes to the log file.

- `Innodb_os_log_fsyncs`

The number of `fsync()` writes done to the log file.

- `Innodb_os_log_pending_fsyncs`

The number of pending log file `fsync()` operations.

- `Innodb_os_log_pending_writes`

The number of pending log file writes.

- `Innodb_os_log_written`

The number of bytes written to the log file.

- `Innodb_page_size`

The compiled-in InnoDB page size (default 16KB). Many values are counted in pages; the page size allows them to be easily converted to bytes.

- `Innodb_pages_created`

The number of pages created.

- `Innodb_pages_read`

The number of pages read.

- `Innodb_pages_written`

The number of pages written.

- `Innodb_row_lock_current_waits`  
The number of row locks currently being waited for.
- `Innodb_row_lock_time`  
The total time spent in acquiring row locks, in milliseconds.
- `Innodb_row_lock_time_avg`  
The average time to acquire a row lock, in milliseconds.
- `Innodb_row_lock_time_max`  
The maximum time to acquire a row lock, in milliseconds.
- `Innodb_row_lock_waits`  
The number of times a row lock had to be waited for.
- `Innodb_rows_deleted`  
The number of rows deleted from `InnoDB` tables.
- `Innodb_rows_inserted`  
The number of rows inserted into `InnoDB` tables.
- `Innodb_rows_read`  
The number of rows read from `InnoDB` tables.
- `Innodb_rows_updated`  
The number of rows updated in `InnoDB` tables.
- `Key_blocks_not_flushed`  
The number of key blocks in the key cache that have changed but have not yet been flushed to disk.
- `Key_blocks_unused`  
The number of unused blocks in the key cache. You can use this value to determine how much of the key cache is in use; see the discussion of `key_buffer_size` in [Section 5.1.3, “Server System Variables”](#).
- `Key_blocks_used`  
The number of used blocks in the key cache. This value is a high-water mark that indicates the maximum number of blocks that have ever been in use at one time.
- `Key_read_requests`  
The number of requests to read a key block from the cache.
- `Key_reads`  
The number of physical reads of a key block from disk. If `Key_reads` is large, then your `key_buffer_size` value is probably too small. The cache miss rate can be calculated as `Key_reads/Key_read_requests`.
- `Key_write_requests`  
The number of requests to write a key block to the cache.
- `Key_writes`  
The number of physical writes of a key block to disk.
- `Last_query_cost`  
The total cost of the last compiled query as computed by the query optimizer. This is useful for comparing the cost of different query plans for the same query. The default value of 0 means that no query has been compiled yet. The default value is 0. `Last_query_cost` has session scope.

The `Last_query_cost` value can be computed accurately only for simple “flat” queries, not complex queries such as those with subqueries or `UNION`. For the latter, the value is set to 0.

- `Max_used_connections`

The maximum number of connections that have been in use simultaneously since the server started.

- `Not_flushed_delayed_rows`

The number of rows waiting to be written in `INSERT DELAY` queues.

- `Open_files`

The number of files that are open. This count includes regular files opened by the server. It does not include other types of files such as sockets or pipes. Also, the count does not include files that storage engines open using their own internal functions rather than asking the server level to do so.

- `Open_streams`

The number of streams that are open (used mainly for logging).

- `Open_table_definitions`

The number of cached `.frm` files. This variable was added in MySQL 5.1.3.

- `Open_tables`

The number of tables that are open.

- `Opened_files`

The number of files that have been opened with `my_open()` (a `mysys` library function). Parts of the server that open files without using this function do not increment the count. This variable was added in MySQL 5.1.21.

- `Opened_table_definitions`

The number of `.frm` files that have been cached. This variable was added in MySQL 5.1.24.

- `Opened_tables`

The number of tables that have been opened. If `Opened_tables` is big, your `table_open_cache` value is probably too small.

- `Prepared_stmt_count`

The current number of prepared statements. (The maximum number of statements is given by the `max_prepared_stmt_count` system variable.) This variable was added in MySQL 5.1.14.

- `Qcache_free_blocks`

The number of free memory blocks in the query cache.

- `Qcache_free_memory`

The amount of free memory for the query cache.

- `Qcache_hits`

The number of query cache hits.

- `Qcache_inserts`

The number of queries added to the query cache.

- `Qcache_lowmem_prunes`

The number of queries that were deleted from the query cache because of low memory.

- `Qcache_not_cached`

The number of non-cached queries (not cacheable, or not cached due to the `query_cache_type` setting).

- [Qcache\\_queries\\_in\\_cache](#)  
The number of queries registered in the query cache.
- [Qcache\\_total\\_blocks](#)  
The total number of blocks in the query cache.
- [Queries](#)  
The number of statements executed by the server. This variable includes statements executed within stored programs, unlike the [Questions](#) variable. This variable was added in MySQL 5.1.31.
- [Questions](#)  
The number of statements executed by the server. As of MySQL 5.1.31, this includes only statements sent to the server by clients and no longer includes statements executed within stored programs, unlike the [Queries](#) variable.
- [Rpl\\_status](#)  
The status of fail-safe replication (not yet implemented).
- [Select\\_full\\_join](#)  
The number of joins that perform table scans because they do not use indexes. If this value is not 0, you should carefully check the indexes of your tables.
- [Select\\_full\\_range\\_join](#)  
The number of joins that used a range search on a reference table.
- [Select\\_range](#)  
The number of joins that used ranges on the first table. This is normally not a critical issue even if the value is quite large.
- [Select\\_range\\_check](#)  
The number of joins without keys that check for key usage after each row. If this is not 0, you should carefully check the indexes of your tables.
- [Select\\_scan](#)  
The number of joins that did a full scan of the first table.
- [Slave\\_open\\_temp\\_tables](#)  
The number of temporary tables that the slave SQL thread currently has open.
- [Slave\\_retried\\_transactions](#)  
The total number of times since startup that the replication slave SQL thread has retried transactions.
- [Slave\\_running](#)  
This is **ON** if this server is a replication slave that is connected to a replication master, and both the I/O and SQL threads are running; otherwise, it is **OFF**.
- [Slow\\_launch\\_threads](#)  
The number of threads that have taken more than [slow\\_launch\\_time](#) seconds to create.
- [Slow\\_queries](#)  
The number of queries that have taken more than [long\\_query\\_time](#) seconds. See [Section 5.2.5, “The Slow Query Log”](#).
- [Sort\\_merge\\_passes](#)  
The number of merge passes that the sort algorithm has had to do. If this value is large, you should consider increasing the value of the [sort\\_buffer\\_size](#) system variable.
- [Sort\\_range](#)

The number of sorts that were done using ranges.

- `Sort_rows`

The number of sorted rows.

- `Sort_scan`

The number of sorts that were done by scanning the table.

- `Ssl_accept_renegotiates`

The number of negotiates needed to establish the connection.

- `Ssl_accepts`

The number of accepted SSL connections.

- `Ssl_callback_cache_hits`

The number of callback cache hits.

- `Ssl_cipher`

The current SSL cipher (empty for non-SSL connections).

- `Ssl_cipher_list`

The list of possible SSL ciphers.

- `Ssl_client_connects`

The number of SSL connection attempts to an SSL-enabled master.

- `Ssl_connect_renegotiates`

The number of negotiates needed to establish the connection to an SSL-enabled master.

- `Ssl_ctx_verify_depth`

The SSL context verification depth (how many certificates in the chain are tested).

- `Ssl_ctx_verify_mode`

The SSL context verification mode.

- `Ssl_default_timeout`

The default SSL timeout.

- `Ssl_finished_accepts`

The number of successful SSL connections to the server.

- `Ssl_finished_connects`

The number of successful slave connections to an SSL-enabled master.

- `Ssl_session_cache_hits`

The number of SSL session cache hits.

- `Ssl_session_cache_misses`

The number of SSL session cache misses.

- `Ssl_session_cache_mode`

The SSL session cache mode.

- `Ssl_session_cache_overflows`

The number of SSL session cache overflows.

- `Ssl_session_cache_size`

The SSL session cache size.

- `Ssl_session_cache_timeouts`

The number of SSL session cache timeouts.

- `Ssl_sessions_reused`

How many SSL connections were reused from the cache.

- `Ssl_used_session_cache_entries`

How many SSL session cache entries were used.

- `Ssl_verify_depth`

The verification depth for replication SSL connections.

- `Ssl_verify_mode`

The verification mode for replication SSL connections.

- `Ssl_version`

The SSL version number.

- `Table_locks_immediate`

The number of times that a request for a table lock could be granted immediately.

- `Table_locks_waited`

The number of times that a request for a table lock could not be granted immediately and a wait was needed. If this is high and you have performance problems, you should first optimize your queries, and then either split your table or tables or use replication.

- `Tc_log_max_pages_used`

For the memory-mapped implementation of the log that is used by `mysqld` when it acts as the transaction coordinator for recovery of internal XA transactions, this variable indicates the largest number of pages used for the log since the server started. If the product of `Tc_log_max_pages_used` and `Tc_log_page_size` is always significantly less than the log size, the size is larger than necessary and can be reduced. (The size is set by the `--log-tc-size` option. Currently, this variable is unused: It is unneeded for binary log-based recovery, and the memory-mapped recovery log method is not used unless the number of storage engines capable of two-phase commit is greater than one. (`InnoDB` is the only applicable engine.)

- `Tc_log_page_size`

The page size used for the memory-mapped implementation of the XA recovery log. The default value is determined using `getpagesize()`. Currently, this variable is unused for the same reasons as described for `Tc_log_max_pages_used`.

- `Tc_log_page_waits`

For the memory-mapped implementation of the recovery log, this variable increments each time the server was not able to commit a transaction and had to wait for a free page in the log. If this value is large, you might want to increase the log size (with the `--log-tc-size` option). For binary log-based recovery, this variable increments each time the binary log cannot be closed because there are two-phase commits in progress. (The close operation waits until all such transactions are finished.)

- `Threads_cached`

The number of threads in the thread cache.

- `Threads_connected`

The number of currently open connections.

- `Threads_created`

The number of threads created to handle connections. If `Threads_created` is big, you may want to increase the `thread_cache_size` value. The cache miss rate can be calculated as `Threads_created/Connections`.

- `Threads_running`

The number of threads that are not sleeping.

- `Uptime`

The number of seconds that the server has been up.

- `Uptime_since_flush_status`

The number of seconds since the most recent `FLUSH STATUS` statement. This variable was added in 5.1.24.

## 5.1.7. Server SQL Modes

The MySQL server can operate in different SQL modes, and can apply these modes differently for different clients. This capability enables each application to tailor the server's operating mode to its own requirements.

For answers to some questions that are often asked about server SQL modes in MySQL, see [Section A.3, “MySQL 5.1 FAQ — Server SQL Mode”](#).

Modes define what SQL syntax MySQL should support and what kind of data validation checks it should perform. This makes it easier to use MySQL in different environments and to use MySQL together with other database servers.

You can set the default SQL mode by starting `mysqld` with the `--sql-mode="modes"` option, or by using `sql-mode="modes"` in `my.cnf` (Unix operating systems) or `my.ini` (Windows). `modes` is a list of different modes separated by comma (“,”) characters. The default value is empty (no modes set). The `modes` value also can be empty (`--sql-mode=""` on the command line, or `sql-mode=""` in `my.cnf` on Unix systems or in `my.ini` on Windows) if you want to clear it explicitly.

You can change the SQL mode at runtime by using a `SET [GLOBAL|SESSION] sql_mode='modes'` statement to set the `sql_mode` system value. Setting the `GLOBAL` variable requires the `SUPER` privilege and affects the operation of all clients that connect from that time on. Setting the `SESSION` variable affects only the current client. Any client can change its own session `sql_mode` value at any time.

### Important

**SQL mode and user-defined partitioning.** Changing the server SQL mode after creating and inserting data into partitioned tables can cause major changes in the behavior of such tables, and could lead to loss or corruption of data. It is strongly recommended that you never change the SQL mode once you have created tables employing user-defined partitioning.

See [Section 17.5, “Restrictions and Limitations on Partitioning”](#), for more information.

You can retrieve the current global or session `sql_mode` value with the following statements:

```
SELECT @@GLOBAL.sql_mode;
SELECT @@SESSION.sql_mode;
```

The most important `sql_mode` values are probably these:

- `ANSI`

This mode changes syntax and behavior to conform more closely to standard SQL.

- `STRICT_TRANS_TABLES`

If a value could not be inserted as given into a transactional table, abort the statement. For a non-transactional table, abort the statement if the value occurs in a single-row statement or the first row of a multiple-row statement. More detail is given later in this section.

- `TRADITIONAL`

Make MySQL behave like a “traditional” SQL database system. A simple description of this mode is “give an error instead of a warning” when inserting an incorrect value into a column.

**Note**

The `INSERT/UPDATE` aborts as soon as the error is noticed. This may not be what you want if you are using a non-transactional storage engine, because data changes made prior to the error may not be rolled back, resulting in a “partially done” update.

When this manual refers to “strict mode,” it means a mode where at least one of `STRICT_TRANS_TABLES` or `STRICT_ALL_TABLES` is enabled.

The following list describes all supported modes:

- `ALLOW_INVALID_DATES`

Don't do full checking of dates. Check only that the month is in the range from 1 to 12 and the day is in the range from 1 to 31. This is very convenient for Web applications where you obtain year, month, and day in three different fields and you want to store exactly what the user inserted (without date validation). This mode applies to `DATE` and `DATETIME` columns. It does not apply `TIMESTAMP` columns, which always require a valid date.

The server requires that month and day values be legal, and not merely in the range 1 to 12 and 1 to 31, respectively. With strict mode disabled, invalid dates such as `'2004-04-31'` are converted to `'0000-00-00'` and a warning is generated. With strict mode enabled, invalid dates generate an error. To allow such dates, enable `ALLOW_INVALID_DATES`.

- `ANSI_QUOTES`

Treat “`”` as an identifier quote character (like the “`”` quote character) and not as a string quote character. You can still use “`”` to quote identifiers with this mode enabled. With `ANSI_QUOTES` enabled, you cannot use double quotes to quote literal strings, because it is interpreted as an identifier.

- `ERROR_FOR_DIVISION_BY_ZERO`

Produce an error in strict mode (otherwise a warning) when a division by zero (or `MOD(X, 0)`) occurs during an `INSERT` or `UPDATE`. If this mode is not enabled, MySQL instead returns `NULL` for divisions by zero. For `INSERT IGNORE` or `UPDATE IGNORE`, MySQL generates a warning for divisions by zero, but the result of the operation is `NULL`.

- `HIGH_NOT_PRECEDENCE`

The precedence of the `NOT` operator is such that expressions such as `NOT a BETWEEN b AND c` are parsed as `NOT (a BETWEEN b AND c)`. In some older versions of MySQL, the expression was parsed as `(NOT a) BETWEEN b AND c`. The old higher-precedence behavior can be obtained by enabling the `HIGH_NOT_PRECEDENCE` SQL mode.

```
mysql> SET sql_mode = '';
mysql> SELECT NOT 1 BETWEEN -5 AND 5;
-> 0
mysql> SET sql_mode = 'HIGH_NOT_PRECEDENCE';
mysql> SELECT NOT 1 BETWEEN -5 AND 5;
-> 1
```

- `IGNORE_SPACE`

Allow spaces between a function name and the “`(`” character. This causes built-in function names to be treated as reserved words. As a result, identifiers that are the same as function names must be quoted as described in [Section 8.2, “Schema Object Names”](#). For example, because there is a `COUNT()` function, the use of `count` as a table name in the following statement causes an error:

```
mysql> CREATE TABLE count (i INT);
ERROR 1064 (42000): You have an error in your SQL syntax
```

The table name should be quoted:

```
mysql> CREATE TABLE `count` (i INT);
Query OK, 0 rows affected (0.00 sec)
```

The `IGNORE_SPACE` SQL mode applies to built-in functions, not to user-defined functions or stored functions. It is always allowable to have spaces after a UDF or stored function name, regardless of whether `IGNORE_SPACE` is enabled.

For further discussion of `IGNORE_SPACE`, see [Section 8.2.4, “Function Name Parsing and Resolution”](#).

- `NO_AUTO_CREATE_USER`



Prevent the `GRANT` statement from automatically creating new users if it would otherwise do so, unless a non-empty password also is specified.

- `NO_AUTO_VALUE_ON_ZERO`

`NO_AUTO_VALUE_ON_ZERO` affects handling of `AUTO_INCREMENT` columns. Normally, you generate the next sequence number for the column by inserting either `NULL` or `0` into it. `NO_AUTO_VALUE_ON_ZERO` suppresses this behavior for `0` so that only `NULL` generates the next sequence number.

This mode can be useful if `0` has been stored in a table's `AUTO_INCREMENT` column. (Storing `0` is not a recommended practice, by the way.) For example, if you dump the table with `mysqldump` and then reload it, MySQL normally generates new sequence numbers when it encounters the `0` values, resulting in a table with contents different from the one that was dumped. Enabling `NO_AUTO_VALUE_ON_ZERO` before reloading the dump file solves this problem. `mysqldump` now automatically includes in its output a statement that enables `NO_AUTO_VALUE_ON_ZERO`, to avoid this problem.

- `NO_BACKSLASH_ESCAPES`

Disable the use of the backslash character (“\”) as an escape character within strings. With this mode enabled, backslash becomes an ordinary character like any other.

- `NO_DIR_IN_CREATE`

When creating a table, ignore all `INDEX DIRECTORY` and `DATA DIRECTORY` directives. This option is useful on slave replication servers.

- `NO_ENGINE_SUBSTITUTION`

Control automatic substitution of the default storage engine when a statement such as `CREATE TABLE` or `ALTER TABLE` specifies a storage engine that is disabled or not compiled in.

Up through MySQL 5.1.11, with `NO_ENGINE_SUBSTITUTION` disabled, the default engine is used and a warning occurs if the desired engine is known but disabled or not compiled in. If the desired engine is invalid (not a known engine name), an error occurs and the table is not created or altered.

With `NO_ENGINE_SUBSTITUTION` enabled, an error occurs and the table is not created or altered if the desired engine is unavailable for any reason (whether disabled or invalid).

As of MySQL 5.1.12, storage engines can be pluggable at runtime, so the distinction between disabled and invalid no longer applies. All unavailable engines are treated the same way:

With `NO_ENGINE_SUBSTITUTION` disabled, for `CREATE TABLE` the default engine is used and a warning occurs if the desired engine is unavailable. For `ALTER TABLE`, a warning occurs and the table is not altered.

With `NO_ENGINE_SUBSTITUTION` enabled, an error occurs and the table is not created or altered if the desired engine is unavailable.

- `NO_FIELD_OPTIONS`

Do not print MySQL-specific column options in the output of `SHOW CREATE TABLE`. This mode is used by `mysqldump` in portability mode.

- `NO_KEY_OPTIONS`

Do not print MySQL-specific index options in the output of `SHOW CREATE TABLE`. This mode is used by `mysqldump` in portability mode.

- `NO_TABLE_OPTIONS`

Do not print MySQL-specific table options (such as `ENGINE`) in the output of `SHOW CREATE TABLE`. This mode is used by `mysqldump` in portability mode.

- `NO_UNSIGNED_SUBTRACTION`

In integer subtraction operations, do not mark the result as `UNSIGNED` if one of the operands is unsigned. In other words, *the result of a subtraction is always signed whenever this mode is in effect, even if one of the operands is unsigned*. For example, compare the type of column `c2` in table `t1` with that of column `c2` in table `t2`:

```
mysql> SET SQL_MODE='';
mysql> CREATE TABLE test (c1 BIGINT UNSIGNED NOT NULL);
mysql> CREATE TABLE t1 SELECT c1 - 1 AS c2 FROM test;
mysql> DESCRIBE t1;
+-----+-----+-----+-----+-----+-----+
```

```

+----+-----+-----+-----+-----+-----+
| Field | Type                | Null | Key | Default | Extra |
+----+-----+-----+-----+-----+-----+
| c2    | bigint(21) unsigned |      |     | 0        |       |
+----+-----+-----+-----+-----+-----+

mysql> SET SQL_MODE='NO_UNSIGNED_SUBTRACTION';
mysql> CREATE TABLE t2 SELECT c1 - 1 AS c2 FROM test;
mysql> DESCRIBE t2;
+----+-----+-----+-----+-----+-----+
| Field | Type                | Null | Key | Default | Extra |
+----+-----+-----+-----+-----+-----+
| c2    | bigint(21)          |      |     | 0        |       |
+----+-----+-----+-----+-----+-----+

```

Note that this means that `BIGINT UNSIGNED` is not 100% usable in all contexts. See [Section 11.9, “Cast Functions and Operators”](#).

```

mysql> SET SQL_MODE = '';
mysql> SELECT CAST(0 AS UNSIGNED) - 1;
+-----+
| CAST(0 AS UNSIGNED) - 1 |
+-----+
| 18446744073709551615   |
+-----+

mysql> SET SQL_MODE = 'NO_UNSIGNED_SUBTRACTION';
mysql> SELECT CAST(0 AS UNSIGNED) - 1;
+-----+
| CAST(0 AS UNSIGNED) - 1 |
+-----+
| -1                       |
+-----+

```

- `NO_ZERO_DATE`

In strict mode, don't allow `'0000-00-00'` as a valid date. You can still insert zero dates with the `IGNORE` option. When not in strict mode, the date is accepted but a warning is generated.

- `NO_ZERO_IN_DATE`

In strict mode, do not accept dates where the year part is nonzero but the month or day part is 0 (for example, `'0000-00-00'` is legal but `'2010-00-01'` and `'2010-01-00'` are not). If used with the `IGNORE` option, MySQL inserts a `'0000-00-00'` date for any such date. When not in strict mode, the date is accepted but a warning is generated.

- `ONLY_FULL_GROUP_BY`

Do not allow queries for which the `SELECT` list refers to non-aggregated columns that are not named in the `GROUP BY` clause. The following query is invalid with this mode enabled because `address` is not named in the `GROUP BY` clause:

```
SELECT name, address, MAX(age) FROM t GROUP BY name;
```

As of MySQL 5.1.11, this mode also restricts references to non-aggregated columns in the `HAVING` clause that are not named in the `GROUP BY` clause.

- `PAD_CHAR_TO_FULL_LENGTH`

By default, trailing spaces are trimmed from `CHAR` column values on retrieval. If `PAD_CHAR_TO_FULL_LENGTH` is enabled, trimming does not occur and retrieved `CHAR` values are padded to their full length. This mode does not apply to `VARCHAR` columns, for which trailing spaces are retained on retrieval. This mode was added in MySQL 5.1.20.

```

mysql> CREATE TABLE t1 (c1 CHAR(10));
Query OK, 0 rows affected (0.37 sec)

mysql> INSERT INTO t1 (c1) VALUES('xy');
Query OK, 1 row affected (0.01 sec)

mysql> SET sql_mode = '';
Query OK, 0 rows affected (0.00 sec)

mysql> SELECT c1, CHAR_LENGTH(c1) FROM t1;
+----+-----+
| c1  | CHAR_LENGTH(c1) |
+----+-----+
| xy  | 2               |
+----+-----+
1 row in set (0.00 sec)

mysql> SET sql_mode = 'PAD_CHAR_TO_FULL_LENGTH';
Query OK, 0 rows affected (0.00 sec)

mysql> SELECT c1, CHAR_LENGTH(c1) FROM t1;
+----+-----+
| c1  | CHAR_LENGTH(c1) |
+----+-----+

```

```

+-----+-----+
| xy          |          10 |
+-----+-----+
1 row in set (0.00 sec)

```

- [PIPES\\_AS\\_CONCAT](#)

Treat `||` as a string concatenation operator (same as `CONCAT()`) rather than as a synonym for `OR`.

- [REAL\\_AS\\_FLOAT](#)

Treat `REAL` as a synonym for `FLOAT`. By default, MySQL treats `REAL` as a synonym for `DOUBLE`.

- [STRICT\\_ALL\\_TABLES](#)

Enable strict mode for all storage engines. Invalid data values are rejected. Additional detail follows.

- [STRICT\\_TRANS\\_TABLES](#)

Enable strict mode for transactional storage engines, and when possible for non-transactional storage engines. Additional details follow.

Strict mode controls how MySQL handles input values that are invalid or missing. A value can be invalid for several reasons. For example, it might have the wrong data type for the column, or it might be out of range. A value is missing when a new row to be inserted does not contain a value for a non-`NULL` column that has no explicit `DEFAULT` clause in its definition. (For a `NULL` column, `NULL` is inserted if the value is missing.)

For transactional tables, an error occurs for invalid or missing values in a statement when either of the [STRICT\\_ALL\\_TABLES](#) or [STRICT\\_TRANS\\_TABLES](#) modes are enabled. The statement is aborted and rolled back.

For non-transactional tables, the behavior is the same for either mode, if the bad value occurs in the first row to be inserted or updated. The statement is aborted and the table remains unchanged. If the statement inserts or modifies multiple rows and the bad value occurs in the second or later row, the result depends on which strict option is enabled:

- For [STRICT\\_ALL\\_TABLES](#), MySQL returns an error and ignores the rest of the rows. However, in this case, the earlier rows still have been inserted or updated. This means that you might get a partial update, which might not be what you want. To avoid this, it is best to use single-row statements because these can be aborted without changing the table.
- For [STRICT\\_TRANS\\_TABLES](#), MySQL converts an invalid value to the closest valid value for the column and insert the adjusted value. If a value is missing, MySQL inserts the implicit default value for the column data type. In either case, MySQL generates a warning rather than an error and continues processing the statement. Implicit defaults are described in [Section 10.1.4, “Data Type Default Values”](#).

Strict mode disallows invalid date values such as `'2004-04-31'`. It does not disallow dates with zero month or day parts such as `'2004-04-00'` or “zero” dates. To disallow these as well, enable the `NO_ZERO_IN_DATE` and `NO_ZERO_DATE` SQL modes in addition to strict mode.

If you are not using strict mode (that is, neither [STRICT\\_TRANS\\_TABLES](#) nor [STRICT\\_ALL\\_TABLES](#) is enabled), MySQL inserts adjusted values for invalid or missing values and produces warnings. In strict mode, you can produce this behavior by using `INSERT IGNORE` or `UPDATE IGNORE`. See [Section 12.5.5.42, “SHOW WARNINGS Syntax”](#).

Strict mode does not affect whether foreign key constraints are checked. `foreign_key_checks` can be used for that. (See [Section 5.1.4, “Session System Variables”](#).)

The following special modes are provided as shorthand for combinations of mode values from the preceding list.

The descriptions include all mode values that are available in the most recent version of MySQL. For older versions, a combination mode does not include individual mode values that are not available except in newer versions.

- [ANSI](#)

Equivalent to [REAL\\_AS\\_FLOAT](#), [PIPES\\_AS\\_CONCAT](#), [ANSI\\_QUOTES](#), [IGNORE\\_SPACE](#).

As of MySQL 5.1.18, `ANSI` mode also causes the server to return an error for queries where a set function `S` with an outer reference `S(outer_ref)` cannot be aggregated in the outer query against which the outer reference has been resolved. This is such a query:

```
SELECT * FROM t1 WHERE t1.a IN (SELECT MAX(t1.b) FROM t2 WHERE ...);
```

Here, `MAX(t1.b)` cannot be aggregated in the outer query because it appears in the `WHERE` clause of that query. Standard SQL requires an error in this situation. If `ANSI` mode is not enabled, the server treats `S(outer_ref)` in such queries the same way that it would interpret `S(const)`, as was always done prior to 5.1.18.

See [Section 1.7.3, “Running MySQL in ANSI Mode”](#).

- `DB2`

Equivalent to `PIPES_AS_CONCAT, ANSI_QUOTES, IGNORE_SPACE, NO_KEY_OPTIONS, NO_TABLE_OPTIONS, NO_FIELD_OPTIONS`.

- `MAXDB`

Equivalent to `PIPES_AS_CONCAT, ANSI_QUOTES, IGNORE_SPACE, NO_KEY_OPTIONS, NO_TABLE_OPTIONS, NO_FIELD_OPTIONS, NO_AUTO_CREATE_USER`.

- `MSSQL`

Equivalent to `PIPES_AS_CONCAT, ANSI_QUOTES, IGNORE_SPACE, NO_KEY_OPTIONS, NO_TABLE_OPTIONS, NO_FIELD_OPTIONS`.

- `MYSQL323`

Equivalent to `NO_FIELD_OPTIONS, HIGH_NOT_PRECEDENCE`.

- `MYSQL40`

Equivalent to `NO_FIELD_OPTIONS, HIGH_NOT_PRECEDENCE`.

- `ORACLE`

Equivalent to `PIPES_AS_CONCAT, ANSI_QUOTES, IGNORE_SPACE, NO_KEY_OPTIONS, NO_TABLE_OPTIONS, NO_FIELD_OPTIONS, NO_AUTO_CREATE_USER`.

- `POSTGRESQL`

Equivalent to `PIPES_AS_CONCAT, ANSI_QUOTES, IGNORE_SPACE, NO_KEY_OPTIONS, NO_TABLE_OPTIONS, NO_FIELD_OPTIONS`.

- `TRADITIONAL`

Equivalent to `STRICT_TRANS_TABLES, STRICT_ALL_TABLES, NO_ZERO_IN_DATE, NO_ZERO_DATE, ERROR_FOR_DIVISION_BY_ZERO, NO_AUTO_CREATE_USER`.

## 5.1.8. Server-Side Help

MySQL Server supports a `HELP` statement that returns online information from the MySQL Reference manual (see [Section 12.3.3, “HELP Syntax”](#)). The proper operation of this statement requires that the help tables in the `mysql` database be initialized with help topic information, which is done by processing the contents of the `fill_help_tables.sql` script.

For a MySQL binary distribution on Unix, help table setup occurs when you run `mysql_install_db`. For an RPM distribution on Linux or binary distribution on Windows, help table setup occurs as part of the MySQL installation process.

For a MySQL source distribution, you can find the `fill_help_tables.sql` file in the `scripts` directory. To load the file manually, make sure that you have initialized the `mysql` database by running `mysql_install_db`, and then process the file with the `mysql` client as follows:

```
shell> mysql -u root mysql < fill_help_tables.sql
```

If you are working with Bazaar and a MySQL development source tree, the tree doesn't contain `fill_help_tables.sql`. You can download the proper file for your version of MySQL from <http://dev.mysql.com/doc/>. After downloading and uncompressing the file, process it with `mysql` as just described.

## 5.1.9. Server Response to Signals

On Unix, signals can be sent to processes. `mysqld` responds to signals sent to it as follows:

- `SIGTERM` causes the server to shut down.
- `SIGHUP` causes the server to reload the grant tables and flush the logs (like `FLUSH PRIVILEGES` and `FLUSH LOGS`). It also writes a status report to the error log that has this format:

```
Status information:
Current dir: /var/mysql/data/
Running threads: 0  Stack size: 196608
Current locks:

Key caches:
default
Buffer_size:      8388600
Block_size:      1024
Division_limit:  100
Age_limit:       300
blocks used:     0
not flushed:    0
w_requests:     0
writes:         0
r_requests:     0
reads:          0

handler status:
read_key:       0
read_next:     0
read_rnd:      0
read_first:    1
write:         0
delete:        0
update:        0

Table status:
Opened tables:  5
Open tables:    0
Open files:     7
Open streams:   0

Alarm status:
Active alarms:  1
Max used alarms: 2
Next alarm time: 67
```

On some Mac OS X 10.3 versions, `mysqld` ignores `SIGHUP` and `SIGQUIT`.

## 5.1.10. The Shutdown Process

The server shutdown process takes place as follows:

1. The shutdown process is initiated.

Server shutdown can be initiated several ways. For example, a user with the `SHUTDOWN` privilege can execute a `mysqladmin shutdown` command. `mysqladmin` can be used on any platform supported by MySQL. Other operating system-specific shutdown initiation methods are possible as well: The server shuts down on Unix when it receives a `SIGTERM` signal. A server running as a service on Windows shuts down when the services manager tells it to.

2. The server creates a shutdown thread if necessary.

Depending on how shutdown was initiated, the server might create a thread to handle the shutdown process. If shutdown was requested by a client, a shutdown thread is created. If shutdown is the result of receiving a `SIGTERM` signal, the signal thread might handle shutdown itself, or it might create a separate thread to do so. If the server tries to create a shutdown thread and cannot (for example, if memory is exhausted), it issues a diagnostic message that appears in the error log:

```
Error: Can't create thread to kill server
```

3. The server stops accepting new connections.

To prevent new activity from being initiated during shutdown, the server stops accepting new client connections. It does this by closing the network connections to which it normally listens for connections: the TCP/IP port, the Unix socket file, the Windows named pipe, and shared memory on Windows.

4. The server terminates current activity.

For each thread that is associated with a client connection, the connection to the client is broken and the thread is marked as killed. Threads die when they notice that they are so marked. Threads for idle connections die quickly. Threads that currently are processing statements check their state periodically and take longer to die. For additional information about thread termin-

ation, see [Section 12.5.6.4, “KILL Syntax”](#), in particular for the instructions about killed `REPAIR TABLE` or `OPTIMIZE TABLE` operations on `MyISAM` tables.

For threads that have an open transaction, the transaction is rolled back. Note that if a thread is updating a non-transactional table, an operation such as a multiple-row `UPDATE` or `INSERT` may leave the table partially updated, because the operation can terminate before completion.

If the server is a master replication server, threads associated with currently connected slaves are treated like other client threads. That is, each one is marked as killed and exits when it next checks its state.

If the server is a slave replication server, the I/O and SQL threads, if active, are stopped before client threads are marked as killed. The SQL thread is allowed to finish its current statement (to avoid causing replication problems), and then stops. If the SQL thread was in the middle of a transaction at this point, the transaction is rolled back.

- Storage engines are shut down or closed.

At this stage, the table cache is flushed and all open tables are closed.

Each storage engine performs any actions necessary for tables that it manages. For example, `MyISAM` flushes any pending index writes for a table. `InnoDB` flushes its buffer pool to disk, unless `innodb_fast_shutdown` is 2, writes the current LSN to the tablespace, and terminates its own internal threads.

- The server exits.

## 5.2. MySQL Server Logs

MySQL has several different logs that can help you find out what is going on inside `mysqld`.

Log Type	Information Written to Log
The error log	Problems encountered starting, running, or stopping <code>mysqld</code>
The general query log	Established client connections and statements received from clients
The binary log	All statements that change data (also used for replication)
The slow query log	All queries that took more than <code>long_query_time</code> seconds to execute or didn't use indexes

By default, all log files are created in the `mysqld` data directory. You can force `mysqld` to close and reopen the log files (or in some cases switch to a new log) by flushing the logs. Log flushing occurs when you issue a `FLUSH LOGS` statement or execute `mysqladmin flush-logs` or `mysqladmin refresh`. See [Section 12.5.6.3, “FLUSH Syntax”](#), and [Section 4.5.2, “mysqladmin — Client for Administering a MySQL Server”](#).

If you are using MySQL replication capabilities, slave replication servers maintain additional log files called relay logs. [Chapter 16, Replication](#), discusses relay log contents and configuration.

As of MySQL 5.1.6, the server can write general query and slow query entries to log tables, log files, or both. For details, see [Section 5.2.1, “Selecting General Query and Slow Query Log Output Destinations”](#).

As of MySQL 5.1.12, additional runtime control of the general query and slow query logs is available: You can enable or disable logging, or change the name of the log file. See [Section 5.2.3, “The General Query Log”](#), and [Section 5.2.5, “The Slow Query Log”](#).

See [Section 5.5.6.1, “Administrator Guidelines for Password Security”](#), for information about keeping logs secure.

### MySQL Enterprise

The MySQL Enterprise Monitor provides a number of advisors specifically related to the various log files. For more information, see <http://www.mysql.com/products/enterprise/advisors.html>.

### 5.2.1. Selecting General Query and Slow Query Log Output Destinations

As of MySQL 5.1.6, the server provides flexible control over the destination for log output. Log entries can be written to log files to the `general_log` and `slow_log` tables in the `mysql` database. If logging is enabled, either or both destinations can be selected. (Before MySQL 5.1.6, the server uses only log files as the destination for general query log and slow query log entries, if those logs are enabled.)

#### Note

For new installations of MySQL 5.1.6 or higher, the log tables are created during the installation procedure along with the other system tables. If you upgrade MySQL from a release older than 5.1.6 to MySQL 5.1.6 or higher, you must upgrade the system tables after upgrading to make sure that the log tables exist. See [Section 4.4.8](#), “`mysql_upgrade` — Check Tables for MySQL Upgrade”.

Currently, logging to tables incurs significantly more server overhead than logging to files. If you enable the general log or slow query log and require highest performance, you should log to files and not to tables.

**Log control at server startup.** The `--log-output` option specifies the destination for log output, if logging is enabled, but the option does not in itself enable the logs. The syntax for this option is `--log-output[=value,...]`:

- If `--log-output` is given with a value, the value can be a comma-separated list of one or more of the words `TABLE` (log to tables), `FILE` (log to files), or `NONE` (do not log to tables or files). `NONE`, if present, takes precedence over any other specifiers.
- If `--log-output` is omitted or given without a value, the default is `FILE`. (For MySQL 5.1.6 through 5.1.20, the default is `TABLE`.)

The `--general_log` option, if given, enables logging to the general query log for the selected log destinations. `-general_log` takes an optional argument of 1 or 0 to enable or disable the log. To specify a file name other than the default for file logging, use `--general_log_file=file_name`. Similarly, the `--slow_query_log` option, if given, enables logging to the slow query log for the selected destinations and `--slow_query_log_file=file_name` specifies a file name for file logging. If either log is enabled, the server opens the corresponding log file and writes startup messages to it. However, logging of queries to the file does not occur unless the `FILE` log destination is selected. Prior to MySQL 5.1.29, the `--log` and `-log-slow-queries` options enable the general query log and slow query log. Either option may be given with a file name argument to specify a log file name to override the default.

Examples:

- To write general query log entries to the log table and the log file, use `--log-output=TABLE,FILE` to select both log destinations and the `--general_log` option to enable the general query log.
- To write general and slow query log entries only to the log tables, use `--log-output=TABLE` to select tables as the log destination and the `--general_log` and `--slow_query_log` options to enable both logs.
- To write slow query log entries only to the log file, use `--log-output=FILE` to select files as the log destination and the `-slow_query_log` option to enable the slow query log. (In this case, because the default log destination is `FILE`, you could omit the `--log-output` option.)

**Log control at runtime.** Several system variables are associated with log tables and files and enable runtime control over logging:

- The global `log_output` system variable indicates the current logging destination. It can be modified at runtime to change the destination.
- The global `general_log` and `slow_query_log` variables indicate whether the general query log and slow query log are enabled (`ON`) or disabled (`OFF`). You can set these variables at runtime to control whether the logs are enabled.
- The global `general_log_file` and `slow_query_log_file` variables indicate the names of the general query log and slow query log files. As of MySQL 5.1.29, you can set these variables at server startup or at runtime to change the names of the log files. Before MySQL 5.1.29, you can set these variables only at runtime, but the `--log` and `--log-slow-queries` options can be given with a file name argument at startup to change the log file names from their default values.
- The session `sql_log_off` variable can be set to `ON` or `OFF` to disable or enable general query logging for the current connection.

The use of tables for log output offers the following benefits:

- Log entries have a standard format. To display the current structure of the log tables, use these statements:

```
SHOW CREATE TABLE mysql.general_log;
SHOW CREATE TABLE mysql.slow_log;
```

- Log contents are accessible via SQL statements. This enables the use of queries that select only those log entries that satisfy specific criteria. For example, to select log contents associated with a particular client (which can be useful for identifying problematic queries from that client), it is easier to do this using a log table than a log file.



- Logs are accessible remotely through any client that can connect to the server and issue queries (if the client has the appropriate log table privileges). It is not necessary to log in to the server host and directly access the file system.

The log table implementation has the following characteristics:

- In general, the primary purpose of log tables is to provide an interface for users to observe the runtime execution of the server, not to interfere with its runtime execution.
- `CREATE TABLE`, `ALTER TABLE`, and `DROP TABLE` are valid operations on a log table. For `ALTER TABLE` and `DROP TABLE`, the log table cannot be in use and must be disabled, as described later.
- By default, the log tables use the `CSV` storage engine that writes data in comma-separated values format. For users who have access to the `.CSV` files that contain log table data, the files are easy to import into other programs such as spreadsheets that can process CSV input.

Beginning with MySQL 5.1.12, the log tables can be altered to use the `MyISAM` storage engine. You cannot use `ALTER TABLE` to alter a log table that is in use. The log must be disabled first. No engines other than `CSV` or `MyISAM` are legal for the log tables.

- To disable logging so that you can alter (or drop) a log table, you can use the following strategy. The example uses the general query log; the procedure for the slow query log is similar but uses the `slow_log` table and `slow_query_log` system variable.

```
SET @old_log_state = @@global.general_log;
SET GLOBAL general_log = 'OFF';
ALTER TABLE mysql.general_log ENGINE = MyISAM;
SET GLOBAL general_log = @old_log_state;
```

- `TRUNCATE TABLE` is a valid operation on a log table. It can be used to expire log entries.
- As of MySQL 5.1.13, `RENAME TABLE` is a valid operation on a log table. You can atomically rename a log table (to perform log rotation, for example) using the following strategy:

```
USE mysql;
CREATE TABLE IF NOT EXISTS general_log2 LIKE general_log;
RENAME TABLE general_log TO general_log_backup, general_log2 TO general_log;
```

- `LOCK TABLES` cannot be used on a log table.
- `INSERT`, `DELETE`, and `UPDATE` cannot be used on a log table. These operations are allowed only internally to the server itself.
- `FLUSH TABLES WITH READ LOCK` and the state of the global `read_only` system variable have no effect on log tables. The server can always write to the log tables.
- Entries written to the log tables are not written to the binary log and thus are not replicated to slave servers.
- To flush the log tables or log files, use `FLUSH TABLES` or `FLUSH LOGS`, respectively. (From MySQL 5.1.12 to 5.1.20, `FLUSH TABLES` ignores log tables and `FLUSH LOGS` flushes both the log tables and files.)
- It is not recommended to partition log tables, and doing so is not allowed beginning with MySQL 5.1.20.

## 5.2.2. The Error Log

The error log contains information indicating when `mysqld` was started and stopped and also any critical errors that occur while the server is running. If `mysqld` notices a table that needs to be automatically checked or repaired, it writes a message to the error log.

On some operating systems, the error log contains a stack trace if `mysqld` dies. The trace can be used to determine where `mysqld` died. See [MySQL Internals: Porting](#).

You can specify where `mysqld` writes the error log with the `--log-error[=file_name]` option. If no `file_name` value is given, `mysqld` uses the name `host_name.err` by default and writes the file in the data directory. If you execute `FLUSH LOGS`, the error log is renamed with the suffix `-old` and `mysqld` creates a new empty log file. (No renaming occurs if the `--log-error` option was not given to `mysqld`.)

If you do not specify `--log-error`, or (on Windows) if you use the `--console` option, errors are written to `stderr`, the standard error output. Usually this is your terminal.



On Windows, error output is always written to the `.err` file if `--console` is not given.

The `--log-warnings` option or `log_warnings` system variable can be used to control warning logging to the error log. The default value is enabled (1). Warning logging can be disabled using a value of 0. If the value is greater than 1, aborted connections are written to the error log. See [Section B.1.2.11, “Communication Errors and Aborted Connections”](#).

If you use `mysqld_safe` to start `mysqld`, `mysqld_safe` arranges for `mysqld` to write error messages to a log file or (as of MySQL 5.1.20) to `syslog`:

- Before 5.1.20, `mysqld_safe` behavior is to log to a file, using the default error log file if the `--log-error` option is not given to `mysqld_safe`. Otherwise, `mysqld_safe` uses the file name specified via `--log-error=file_name`.
- From 5.1.20 on, `mysqld_safe` has two additional error-logging options, `--syslog` and `--skip-syslog`.

In 5.1.21 and up, the default with no logging options is `--skip-syslog`, which is compatible with the default behavior of writing an error log file for releases prior to 5.1.20. To explicitly specify use of an error log file, specify `--log-error=file_name` to `mysqld_safe`, and `mysqld_safe` will arrange for `mysqld` to write messages to a log file. To use `syslog` instead, specify the `--syslog` option.

**In 5.1.20 only, the following conditions apply:** 1) The default is to use `syslog`, which is not compatible with releases prior to 5.1.20. 2) Logging to `syslog` may fail to operate correctly in some cases, so we recommend that you use `--skip-syslog` or `--log-error`.

For logging to `syslog`, messages from `mysqld_safe` and `mysqld` are written with a tag of `mysqld_safe` and `mysqld`, respectively. As of MySQL 5.1.21, to specify a suffix for the tag, use `--syslog-tag=tag`, which modifies the tags to be `mysqld_safe-tag` and `mysqld-tag`.

If you specify `--log-error` in an option file in a section that `mysqld` reads, `mysqld_safe` also will find and use the option.

If `mysqld_safe` is used to start `mysqld` and `mysqld` dies unexpectedly, `mysqld_safe` notices that it needs to restart `mysqld` and writes a `restarted mysqld` message to the error log.

## 5.2.3. The General Query Log

The general query log is a general record of what `mysqld` is doing. The server writes information to this log when clients connect or disconnect, and it logs each SQL statement received from clients. The general query log can be very useful when you suspect an error in a client and want to know exactly what the client sent to `mysqld`.

`mysqld` writes statements to the query log in the order that it receives them, which might differ from the order in which they are executed. This logging order contrasts to the binary log, for which statements are written after they are executed but before any locks are released. (Also, the query log contains all statements, whereas the binary log does not contain statements that only select data.)

Before 5.1.6, the general query log destination is always a file. To enable the general query log file, use the `--log[=file_name]` or `-l [file_name]` option. To enable the general query log as of MySQL 5.1.6, start `mysqld` with the `--log[=file_name]` or `-l [file_name]` option, and optionally use `--log-output` to specify the log destination (as described in [Section 5.2.1, “Selecting General Query and Slow Query Log Output Destinations”](#)). As of MySQL 5.1.29, `--log` and `-l` are deprecated: Use `--general_log` to enable the general query log, and optionally `--general_log_file=file_name` to specify a log file name. `--general_log` takes an optional argument of 1 or 0 to enable or disable the log.

If you specify no file name for the general query log, the default name is `host_name.log` in the data directory. If you specify a file name that is not an absolute path name, the server writes the file in the data directory.

When `--log` or `-l` is specified, the `--general_log` option also may be given as of MySQL 5.1.12 to specify the initial general query log state. With no argument or an argument of 0, the option disables the log. If omitted or given with an argument of 1, the option enables the log.

For runtime control of the general query log, use the global `general_log` and `general_log_file` system variables. Set `general_log` to 0 (or `OFF`) to disable the log or to 1 (or `ON`) to enable it. Set `general_log_file` to specify the name of the log file. If a log file already is open, it is closed and the new file is opened.

When the general query log is enabled, output is written to any destinations specified by the `--log-output` option or `log_output` system variable. If you enable the log, the server opens the log file and writes startup messages to it. However, logging of queries to the file does not occur unless the `FILE` log destination is selected. If the destination is `NONE`, no queries are written even if the general log is enabled. Setting the log file name has no effect on logging if the log destination value does not contain `FILE`.

Server restarts and log flushing do not cause a new general query log file to be generated (although flushing closes and reopens it). On Unix, you can rename the file and create a new one by using the following commands:

```
shell> mv host_name.log host_name-old.log
shell> mysqladmin flush-logs
shell> cp host_name-old.log backup-directory
shell> rm host_name-old.log
```

Before 5.1.3, you cannot rename a log file on Windows while the server has it open. You must stop the server and rename the file, and then restart the server to create a new log file. As of 5.1.3, this applies only to the error log. However, a stop and restart can be avoided by using `FLUSH LOGS`, which causes the server to rename the error log with an `-old` suffix and open a new error log.

As of MySQL 5.1.12, you can disable the general query log at runtime:

```
SET GLOBAL general_log = 'OFF';
```

With the log disabled, rename the log file externally; for example, from the command line. Then enable the log again:

```
SET GLOBAL general_log = 'ON';
```

This method works on any platform and does not require a server restart.

The session `sql_log_off` variable can be set to `ON` or `OFF` to disable or enable general query logging for the current connection.

The general query log should be protected because logged statements might contain passwords. See [Section 5.5.6.1, “Administrator Guidelines for Password Security”](#).

## 5.2.4. The Binary Log

The binary log contains all statements that update data. It also contains statements that potentially could have updated it (for example, a `DELETE` which matched no rows), unless row-based logging is used. Statements are stored in the form of “events” that describe the modifications. The binary log also contains information about how long each statement took that updated data. The binary log has two important purposes:

- For replication, the binary log is used on master replication servers as a record of the statements to be sent to slave servers. The master server sends the events contained in its binary log to its slaves, which execute those events to make the same data changes that were made on the master. See [Section 16.4, “Replication Implementation”](#).
- Certain data recovery operations require use of the binary log. After a backup file has been restored, the events in the binary log that were recorded after the backup was made are re-executed. These events bring databases up to date from the point of the backup. See [Section 6.2.2, “Using Backups for Recovery”](#).

The binary log is not used for statements such as `SELECT` or `SHOW` that do not modify data. If you want to log all statements (for example, to identify a problem query), use the general query log. See [Section 5.2.3, “The General Query Log”](#).

The binary log should be protected because logged statements might contain passwords. See [Section 5.5.6.1, “Administrator Guidelines for Password Security”](#).

The format of the events recorded in the binary log is dependent on the binary logging format. Three format types are supported, row-based logging, statement-based logging and mixed-base logging. The binary logging format used depends on the MySQL version. For more information on logging formats, see [Section 5.2.4.1, “Binary Logging Formats”](#).

### MySQL Enterprise

The binary log can also be used to track significant DDL events. Analyzing the binary log in this way is an integral part of the MySQL Enterprise Monitor. For more information, see <http://www.mysql.com/products/enterprise/advisors.html>.

Running the server with the binary log enabled makes performance about 1% slower. However, the benefits of the binary log for restore operations and in allowing you to set up replication generally outweigh this minor performance decrement.

When started with the `--log-bin[=base_name]` option, `mysqld` writes a log file containing all SQL statements that update data (both DDL and DML statements). If no `base_name` value is given, the default name is the value of the `pid-file` option (which by default is the name of host machine) followed by `-bin`. If the basename is given, but not as an absolute path name, the server writes the file in the data directory. It is recommended that you specify a basename; see [Section B.1.8.2, “Additional Known Issues”](#), for the reason.

### Note

From MySQL 5.1.18 through 5.1.22, “mysql” was used when no `base_name` was specified. Also in these versions, a path given as part of the `--log-bin` options was treated as absolute rather than relative. The previous behaviors were restored in MySQL 5.1.23. (See [Bug#28603](#) and [Bug#28597](#).)

If you supply an extension in the log name (for example, `--log-bin=base_name.extension`), the extension is silently removed and ignored.

`mysqld` appends a numeric extension to the binary log basename to generate binary log file names. The number increases each time the server creates a new log file, thus creating an ordered series of files. The server creates a new file in the series each time it starts or flushes the logs. The server also creates a new binary log file automatically when the current log's size reaches `max_binlog_size`. A binary log file may become larger than `max_binlog_size` if you are using large transactions because a transaction is written to the file in one piece, never split between files.

To keep track of which binary log files have been used, `mysqld` also creates a binary log index file that contains the names of all used binary log files. By default, this has the same basename as the binary log file, with the extension `.index`. You can change the name of the binary log index file with the `--log-bin-index[=file_name]` option. You should not manually edit this file while `mysqld` is running; doing so would confuse `mysqld`.

You can delete all binary log files with the `RESET MASTER` statement, or a subset of them with `PURGE BINARY LOGS`. See [Section 12.5.6.6, “RESET Syntax”](#), and [Section 12.6.1.1, “PURGE BINARY LOGS Syntax”](#).

Writes to the binary log file and binary log index file are handled in the same way as writes to `MyISAM` tables. See [Section B.1.4.3, “How MySQL Handles a Full Disk”](#).

The binary log format has some known limitations that can affect recovery from backups. See [Section 16.3.1, “Replication Features and Issues”](#).

Binary logging for stored routines and triggers is done as described in [Section 18.6, “Binary Logging of Stored Programs”](#).

A replication slave server by default does not write to its own binary log any data modifications that are received from the replication master. To log these modifications, start the slave with the `--log-slave-updates` option (see also [Section 16.1.3.3, “Replication Slave Options and Variables”](#)).

**Evaluation of update selection options.** The server evaluates the options for logging or ignoring updates to the binary log according to the following rules:

1. Are there `--binlog-do-db` or `--binlog-ignore-db` rules?
  - No: Write the statement to the binary log and exit.
  - Yes: Go to the next step.
2. There are some rules (`--binlog-do-db`, `--binlog-ignore-db`, or both). Is there a default database (has any database been selected by `USE`)?
  - No: Do *not* write the statement, and exit.
  - Yes: Go to the next step.
3. There is a default database. Are there some `--binlog-do-db` rules?
  - Yes: Does the default database match any of the `--binlog-do-db` rules?
    - Yes: Write the statement and exit.
    - No: Do *not* write the statement, and exit.
  - No: Go to the next step.
4. There are some `--binlog-ignore-db` rules. Does the default database match any of the `--binlog-ignore-db` rules?
  - Yes: Do not write the statement, and exit.
  - No: Write the query and exit.

### Important

An exception is made in the rules just given for the `CREATE DATABASE`, `ALTER DATABASE`, and `DROP DATABASE` statements (see [Section 16.1.3.4, “Binary Log Options and Variables”](#)). In those cases, the database being *cre-*

■ *ated, altered, or dropped* replaces the default database when determining whether to log or ignore updates.

For example, a slave running with only `--binlog-do-db=sales` does not write to the binary log any statement for which the default database is different from `sales` (in other words, `--binlog-do-db` can sometimes mean “ignore other databases”).

If you are using replication, you should not delete old binary log files until you are sure that no slave still needs to use them. For example, if your slaves never run more than three days behind, once a day you can execute `mysqladmin flush-logs` on the master and then remove any logs that are more than three days old. You can remove the files manually, but it is preferable to use `PURGE BINARY LOGS`, which also safely updates the binary log index file for you (and which can take a date argument). See [Section 12.6.1.1, “PURGE BINARY LOGS Syntax”](#).

A client that has the `SUPER` privilege can disable binary logging of its own statements by using a `SET sql_log_bin=0` statement. See [Section 5.1.4, “Session System Variables”](#).

You can display the contents of binary log files with the `mysqlbinlog` utility. This can be useful when you want to reprocess statements in the log. For example, you can update a MySQL server from the binary log as follows:

```
shell> mysqlbinlog log_file | mysql -h server_name
```

See [Section 4.6.7, “mysqlbinlog — Utility for Processing Binary Log Files”](#), for more information on the `mysqlbinlog` utility and how to use it. `mysqlbinlog` also can be used with relay log files because they are written using the same format as binary log files.

Binary logging is done immediately after a statement completes but before any locks are released or any commit is done. This ensures that the log is logged in execution order.

Updates to non-transactional tables are stored in the binary log immediately after execution. In MySQL 5.1.22 and earlier versions of MySQL 5.1, an `UPDATE` statement using a stored function that modified a non-transactional table was not logged if it failed, and an `INSERT ... ON DUPLICATE KEY UPDATE` statement that encountered a duplicate key constraint — but which did not actually change any data — was not logged. Beginning with MySQL 5.1.23, both of these statements are written to the binary log. ([Bug#23333](#))

Within an uncommitted transaction, all updates (`UPDATE`, `DELETE`, or `INSERT`) that change transactional tables such as `BDB` or `InnoDB` tables are cached until a `COMMIT` statement is received by the server. At that point, `mysqld` writes the entire transaction to the binary log before the `COMMIT` is executed. When the thread that handles the transaction starts, it allocates a buffer of `binlog_cache_size` to buffer statements. If a statement is bigger than this, the thread opens a temporary file to store the transaction. The temporary file is deleted when the thread ends.

Modifications to non-transactional tables cannot be rolled back. If a transaction that is rolled back includes modifications to non-transactional tables, the entire transaction is logged with a `ROLLBACK` statement at the end to ensure that the modifications to those tables are replicated.

The `Binlog_cache_use` status variable shows the number of transactions that used this buffer (and possibly a temporary file) for storing statements. The `Binlog_cache_disk_use` status variable shows how many of those transactions actually had to use a temporary file. These two variables can be used for tuning `binlog_cache_size` to a large enough value that avoids the use of temporary files.

The `max_binlog_cache_size` system variable (default 4GB, which is also the maximum) can be used to restrict the total size used to cache a multiple-statement transaction. If a transaction is larger than this many bytes, it fails and rolls back. The minimum value is 4096.

If you are using the binary log and row based logging, concurrent inserts are converted to normal inserts for `CREATE ... SELECT` or `INSERT ... SELECT` statement. This is done to ensure that you can re-create an exact copy of your tables by applying the log during a backup operation. If you are using statement based logging then the original statement is written to the log.

Note that the binary log format is different in MySQL 5.1 from previous versions of MySQL, due to enhancements in replication. See [Section 16.3.2, “Replication Compatibility Between MySQL Versions”](#).

By default, the binary log is not synchronized to disk at each write. So if the operating system or machine (not only the MySQL server) crashes, there is a chance that the last statements of the binary log are lost. To prevent this, you can make the binary log be synchronized to disk after every `N` writes to the binary log, with the `sync_binlog` system variable. See [Section 5.1.3, “Server System Variables”](#). 1 is the safest value for `sync_binlog`, but also the slowest. Even with `sync_binlog` set to 1, there is still the chance of an inconsistency between the table content and binary log content in case of a crash. For example, if you are using `InnoDB` tables and the MySQL server processes a `COMMIT` statement, it writes the whole transaction to the binary log and then commits this transaction into `InnoDB`. If the server crashes between those two operations, the transaction is rolled back by `InnoDB` at restart but still exists in the binary log. To resolve this, you should set `--innodb_support_xa` to 1. Although this option is related to the support of XA transactions in `InnoDB`, it also ensures that the binary log and `InnoDB` data files are synchronized.

For this option to provide a greater degree of safety, the MySQL server should also be configured to synchronize the binary log and the `InnoDB` logs to disk at every transaction. The `InnoDB` logs are synchronized by default, and `sync_binlog=1` can be used

to synchronize the binary log. The effect of this option is that at restart after a crash, after doing a rollback of transactions, the MySQL server cuts rolled back `InnoDB` transactions from the binary log. This ensures that the binary log reflects the exact data of `InnoDB` tables, and so, that the slave remains in synchrony with the master (not receiving a statement which has been rolled back).

If the MySQL server discovers at crash recovery that the binary log is shorter than it should have been, it lacks at least one successfully committed `InnoDB` transaction. This should not happen if `sync_binlog=1` and the disk/file system do an actual sync when they are requested to (some don't), so the server prints an error message `The binary log <name> is shorter than its expected size`. In this case, this binary log is not correct and replication should be restarted from a fresh snapshot of the master's data.

For MySQL 5.1.20 and later (and MySQL 5.0.46 and later for backward compatibility), the session values of the following system variables are written to the binary log and honored by the replication slave when parsing the binary log:

- `sql_mode`
- `foreign_key_checks`
- `unique_checks`
- `character_set_client`
- `collation_connection`
- `collation_database`
- `collation_server`
- `sql_auto_is_null`

### 5.2.4.1. Binary Logging Formats

A number of different logging formats are used to record information in the binary log. The exact format employed depends on the version of MySQL being used. There are three logging formats:

- Replication capabilities in MySQL originally were based on propagation of SQL statements from master to slave. This is called *statement-based logging*. You can cause this format to be used by starting the server with `--binlog-format=STATEMENT`.
- In *row-based logging*, the master writes events to the binary log that indicate how individual table rows are affected. You can cause the server to use row-based logging by starting it with `--binlog-format=ROW`.

Support for row-based logging was added in MySQL 5.1.5.

- A third option is also available: *mixed logging*. With mixed logging, statement-based logging is used by default, but the logging mode switches automatically to row-based in certain cases as described below. You can cause MySQL to use mixed logging explicitly by starting `mysqld` with the option `--binlog-format=MIXED`.

Mixed logging is available beginning with MySQL 5.1.8. In MySQL 5.1.12, it become the default logging mode; in 5.1.29, the default was changed back to `STATEMENT`.

Starting with MySQL 5.1.20, the logging format can also be set or limited by the storage engine being used. This helps to eliminate issues when logging, and more specifically replicating, certain statements between a master and slave which are using different storage engines.

With MySQL's classic statement-based replication, there may be issues with replicating non-deterministic statements. In deciding whether or not a given statement is safe for statement-based replication, MySQL determines whether it can guarantee that the statement can be replicated using the statement-based format. If MySQL cannot make this guarantee, it marks the statement as potentially unreliable and issues the warning, `STATEMENT MAY NOT BE SAFE TO LOG IN STATEMENT FORMAT`.

Prior to MySQL 5.1.36, this warning read, `STATEMENT IS NOT SAFE TO LOG IN STATEMENT FORMAT`. ([Bug#42415](#))

You can avoid these issues by using MySQL's row-based replication instead.

### 5.2.4.2. Setting The Binary Log Format

The default binary logging format depends on the version of MySQL you are using:

- For MySQL 5.1.11 and earlier, and for MySQL 5.1.29 and later, statement-based logging is used by default.
- For MySQL 5.1.12 through MySQL 5.1.28, mixed logging is used by default.

**Exception.** For all MySQL Cluster releases using version 6.1 or later of the `NDBCLUSTER` storage engine (even those releases based on MySQL 5.1.29 and later), the default binary log format is `MIXED`. See [MySQL Cluster Replication](#).

You can force the replication format by starting the MySQL server with `--binlog-format=type`. When set, all replication slaves connecting to the server will read the events according to this setting. The supported values for `type` are:

- `ROW` causes replication to be row-based.
- `STATEMENT` causes replication to be statement-based. This is the default for MySQL 5.1.11 and earlier, and MySQL 5.1.29 and later.
- `MIXED` causes replication to use mixed format. This is the default for MySQL 5.1.12 to 5.1.28.

The logging format also can be switched at runtime. To specify the format globally for all clients, set the global value of the `binlog_format` system variable. (To change the global value, you must have need the `SUPER` privilege. This is also true for the `SESSION` value as of MySQL 5.1.29.)

To switch to statement-based format, use either of these statements:

```
mysql> SET GLOBAL binlog_format = 'STATEMENT';
mysql> SET GLOBAL binlog_format = 1;
```

To switch to row-based format, use either of these statements:

```
mysql> SET GLOBAL binlog_format = 'ROW';
mysql> SET GLOBAL binlog_format = 2;
```

To switch to mixed format, use either of these statements:

```
mysql> SET GLOBAL binlog_format = 'MIXED';
mysql> SET GLOBAL binlog_format = 3;
```

An individual client can control the logging format for its own statements by setting the session value of `binlog_format`. For example:

```
mysql> SET SESSION binlog_format = 'STATEMENT';
mysql> SET SESSION binlog_format = 'ROW';
mysql> SET SESSION binlog_format = 'MIXED';
```

In addition to switching the logging format manually, a slave server may switch the format *automatically*. This happens when the server is running in either `STATEMENT` or `MIXED` format and encounters a row in the binary log that is written in `ROW` logging format. In that case, the slave switches to row-based replication temporarily for that event, and switches back to the previous format afterwards.

There are two reasons why you might want to set replication logging on a per-connection basis:

- A thread that makes many small changes to the database might want to use row-based logging. A thread that performs updates that match many rows in the `WHERE` clause might want to use statement-based logging because it will be more efficient to log a few statements than many rows.
- Some statements require a lot of execution time on the master, but result in just a few rows being modified. It might therefore be beneficial to replicate them using row-based logging.

There are exceptions when you cannot switch the replication format at runtime:

- From within a stored function or a trigger.
- If the `NDBCLUSTER` storage engine is enabled.
- If the session is currently in row-based replication mode and has open temporary tables.



Trying to switch the format in any of these cases results in an error.

Switching the replication format at runtime is not recommended when any temporary tables exist, because temporary tables are logged only when using statement-based replication, whereas with row-based replication they are not logged. With mixed replication, temporary tables are usually logged; exceptions happen with user-defined functions (UDFs) and with the `UUID()` function.

With the binlog format set to `ROW`, many changes are written to the binary log using the row-based format. Some changes, however, still use the statement-based format. Examples include all DDL (data definition language) statements such as `CREATE TABLE`, `ALTER TABLE`, or `DROP TABLE`.

The `--binlog-row-event-max-size` option is available for servers that are capable of row-based replication. Rows are stored into the binary log in chunks having a size in bytes not exceeding the value of this option. The value must be a multiple of 256. The default value is 1024.

### Warning

When using *statement-based logging* in a replication scenario, it is possible for the data on the master and slave to become different if a statement is designed in such a way that the data modification is *non-deterministic*; that is, it is left to the will of the query optimizer. In general, this is not a good practice even outside of replication. For a detailed explanation of this issue, see [Section B.1.8.2, “Additional Known Issues”](#).

### 5.2.4.3. Mixed Binary Logging Format

When running in `MIXED` mode, automatic switching from statement-based to row-based replication takes place under the following conditions:

- When a DML statement updates an `NDBCLUSTER` table
- When a function contains `UUID()`
- When 2 or more tables with `AUTO_INCREMENT` columns are updated
- When any `INSERT DELAYED` is executed
- When the body of a view requires row-based replication, the statement creating the view also uses it — for example, this occurs when the statement creating a view uses the `UUID()` function
- When a call to a UDF is involved
- If a statement is logged by row and the client that executed the statement has any temporary tables, then logging by row is used for all subsequent statements (except for those accessing temporary tables) until all temporary tables in use by that client are dropped

This is true whether or not any temporary tables are actually logged

Temporary tables cannot be logged using the row-based format; thus, once row-based logging is used, all subsequent statements using that table are unsafe, and we approximate this condition by treating all statements made by that client as unsafe until the client no longer holds any temporary tables

- Beginning with MySQL 5.1.23:
  - When `FOUND_ROWS()` or `ROW_COUNT()` is used ([Bug#12092](#), [Bug#30244](#))
  - When `USER()`, `CURRENT_USER()`, or `CURRENT_USER` is used ([Bug#28086](#))
- Beginning with MySQL 5.1.24, when a statement refers to one or more system variables. ([Bug#31168](#))
- Beginning with MySQL 5.1.34, when the `LOAD_FILE()` function is used. ([Bug#39701](#))

### Note

Starting with MySQL 5.1.20 a warning is generated if you try to log execute a statement in statement-logging mode that should be logged in row-logging mode. The warning is shown both in the client (in the output of `SHOW WARNINGS`) and through the `mysqld` error log. A warning is added to the `SHOW WARNINGS` table each time a statement is executed. However, only the first statement that generated the warning for each client session is logged to the `mysqld` error log to prevent flooding the error log.

Starting with MySQL 5.1.20, in addition to the decisions above, individual engines can also determine the logging format used when information in a table is updated. The following table lists the logging formats supported by each storage engine:

Storage Engine	Row Logging Supported	Statement Logging Supported
ARCHIVE	Yes	Yes
BLACKHOLE	No	Yes
CSV	Yes	Yes
EXAMPLE	Yes	No
FEDERATED	Yes	Yes
HEAP	Yes	Yes
InnoDB	Yes	Yes
MyISAM	Yes	Yes
MERGE	Yes	Yes
NDBCLUSTER	Yes	No

A given storage engine can support either or both logging formats; the logging capabilities of an individual engine can be further defined as follows:

- If an engine supports row-based logging, then the engine is said to be *row-logging capable*.
- If an engine supports statement-based logging, then the engine is said to be *statement-logging capable*.

When determining the logging mode to be used, the capabilities of all the tables affected by the event are combined. The set of affected tables is then marked according to these rules:

- A set of tables is defined as *row logging restricted* if the tables are row logging capable but not statement logging capable.
- A set of tables is defined as *statement logging restricted* if the tables are statement logging capable but not row logging capable.

Once the determination of the possible logging formats required by the statement is complete it is compared to the current `binlog_format` setting. The following table is used to decide how the information is recorded in the binary log or, if appropriate, whether an error is raised. In the table, a safe operation is defined as one that is deterministic. A number of rules decide whether the statement is deterministic or not, as shown in the following table (where **RLC** stands for “row-logging capable” and **SLC** stands for “statement-logging capable”).

Condition				Action	
Safe/un-safe	binlog_format	RLC	SLC	Error/Warning	Logged as
Safe	STATEMENT	N	N	Error: not loggable	
Safe	STATEMENT	N	Y		STATEMENT
Safe	STATEMENT	Y	N	Error: not loggable	
Safe	STATEMENT	Y	Y		STATEMENT
Safe	MIXED	N	N	Error: not loggable	
Safe	MIXED	N	Y		STATEMENT
Safe	MIXED	Y	N		ROW
Safe	MIXED	Y	Y		STATEMENT
Safe	ROW	N	N	Error: not loggable	
Safe	ROW	N	Y	Error: not loggable	
Safe	ROW	Y	N		ROW
Safe	ROW	Y	Y		ROW
Unsafe	STATEMENT	N	N	Error: not loggable	
Unsafe	STATEMENT	N	Y	Warning: unsafe	STATEMENT
Unsafe	STATEMENT	Y	N	Error: not loggable	
Unsafe	STATEMENT	Y	Y	Warning: unsafe	STATEMENT
Unsafe	MIXED	N	N	Error: not loggable	



Condition				Action	
Safe/un-safe	<code>binlog_format</code>	RLC	SLC	Error/Warning	Logged as
Unsafe	MIXED	N	Y	Error: not loggable	
Unsafe	MIXED	Y	N		ROW
Unsafe	MIXED	Y	Y		ROW
Unsafe	ROW	N	N	Error: not loggable	
Unsafe	ROW	N	Y	Error: not loggable	
Unsafe	ROW	Y	N		ROW
Unsafe	ROW	Y	Y		ROW

When a warning is produced by the determination, a standard MySQL warning is produced (and is available using `SHOW WARNINGS`). The information is also written to the `mysql` error log. Only one error for each error instance per client connection is logged. The log message will include the SQL statement that was attempted.

If a slave server was started with `--log-warnings` enabled, the slave prints messages to the error log to provide information about its status, such as the binary log and relay log coordinates where it starts its job, when it is switching to another relay log, when it reconnects after a disconnect, and so forth.

#### 5.2.4.4. Logging Format for Changes to `mysql` Database Tables

The contents of the grant tables in the `mysql` database can be modified directly (for example, with `INSERT` or `DELETE`) or indirectly (for example, with `GRANT` or `CREATE USER`). As of MySQL 5.1.17, statements that affect `mysql` database tables are written to the binary log using the following rules:

- Data manipulation statements that change data in `mysql` database tables directly are logged according to the setting of the `binlog_format` system variable. This pertains to statements such as `INSERT`, `UPDATE`, `DELETE`, `REPLACE`, `DO`, `LOAD DATA INFILE`, `SELECT`, and `TRUNCATE`.
- Statements that change the `mysql` database indirectly are logged as statements regardless of the value of `binlog_format`. This pertains to statements such as `GRANT`, `REVOKE`, `SET PASSWORD`, `RENAME USER`, `CREATE` (all forms except `CREATE TABLE ... SELECT`), `ALTER` (all forms), and `DROP` (all forms).

`CREATE TABLE ... SELECT` is a combination of data definition and data manipulation. The `CREATE TABLE` part is logged using statement format and the `SELECT` part is logged according to the value of `binlog_format`.

#### 5.2.5. The Slow Query Log

The slow query log consists of all SQL statements that took more than `long_query_time` seconds to execute and (as of MySQL 5.1.21) required at least `min_examined_row_limit` rows to be examined. The time to acquire the initial table locks is not counted as execution time. `mysqld` writes a statement to the slow query log after it has been executed and after all locks have been released, so log order might be different from execution order. The default value of `long_query_time` is 10. Prior to MySQL 5.1.21, the minimum value is 1, and the value for this variable must be an integer. Beginning with MySQL 5.1.21, the minimum is 0, and a resolution of microseconds is supported when logging to a file. However, the microseconds part is ignored and only integer values are written when logging to tables.

Before 5.1.6, the slow query log destination is always a file. To enable the slow query log file, use the `--log-slow-queries[=file_name]` option. To enable the slow query log as of MySQL 5.1.6, start `mysqld` with the `--log-slow-queries[=file_name]` option, and optionally use `--log-output` to specify the log destination (as described in Section 5.2.1, “Selecting General Query and Slow Query Log Output Destinations”). As of MySQL 5.1.29, `--log-slow-queries` is deprecated: Use `--slow_query_log` to enable the slow query log, and optionally `--slow_query_log_file=file_name` to specify a log file name. `--slow_query_log` takes an optional argument of 1 or 0 to enable or disable the log.

If you specify no file name for the slow query log, the default name is `host_name-slow.log` in the data directory. If you specify a file name that is not an absolute path name, the server writes the file in the data directory.

When `--log-slow-queries` is specified, `--slow_query_log` also may be given as of MySQL 5.1.12 to specify the initial slow query log state. With no argument or an argument of 0, the option disables the log. If omitted or given with an argument of 1, the option enables the log.

For runtime control of the general query log, use the global `slow_query_log` and `slow_query_log_file` system variables. Set `slow_query_log` to 0 (or `OFF`) to disable the log or to 1 (or `ON`) to enable it. Set `general_log_file` to specify

the name of the log file. If a log file already is open, it is closed and the new file is opened.

When the slow query log is enabled, output is written to any destinations specified by the `--log-output` option or `log_output` system variable. If you enable the log, the server opens the log file and writes startup messages to it. However, logging of queries to the file does not occur unless the `FILE` log destination is selected. If the destination is `NONE`, no queries are written even if the slow query log is enabled. Setting the log file name has no effect on logging if the log destination value does not contain `FILE`.

The slow query log can be used to find queries that take a long time to execute and are therefore candidates for optimization. However, examining a long slow query log can become a difficult task. To make this easier, you can process the slow query log using the `mysqldumpslow` command to summarize the queries that appear in the log. Use `mysqldumpslow --help` to see the options that this command supports.

In MySQL 5.1, queries that do not use indexes are logged in the slow query log if the `--log-queries-not-using-indexes` option is specified. See [Section 5.1.2, “Server Command Options”](#).

#### MySQL Enterprise

Excessive table scans are indicative of missing or poorly optimized indexes. Using an advisor specifically designed for the task, the MySQL Enterprise Monitor can identify such problems and offer advice on resolution. For more information, see <http://www.mysql.com/products/enterprise/advisors.html>.

In MySQL 5.1, the `--log-slow-admin-statements` server option enables you to request logging of slow administrative statements such as `OPTIMIZE TABLE`, `ANALYZE TABLE`, and `ALTER TABLE` to the slow query log.

Queries handled by the query cache are not added to the slow query log, nor are queries that would not benefit from the presence of an index because the table has zero rows or one row.

Replication slaves do not write replicated queries to the slow query log, even if the same queries were written to the slow query log on the master. This is a known issue which we intend to fix in a future version of MySQL. ([Bug#23300](#))

The slow query log should be protected because logged statements might contain passwords. See [Section 5.5.6.1, “Administrator Guidelines for Password Security”](#).

## 5.2.6. Server Log Maintenance

MySQL Server can create a number of different log files that make it easy to see what is going on. See [Section 5.2, “MySQL Server Logs”](#). However, you must clean up these files regularly to ensure that the logs do not take up too much disk space.

When using MySQL with logging enabled, you may want to back up and remove old log files from time to time and tell MySQL to start logging to new files. See [Section 6.1, “Database Backups”](#).

On a Linux (Red Hat) installation, you can use the `mysql-log-rotate` script for this. If you installed MySQL from an RPM distribution, this script should have been installed automatically. You should be careful with this script if you are using the binary log for replication. You should not remove binary logs until you are certain that their contents have been processed by all slaves.

On other systems, you must install a short script yourself that you start from `cron` (or its equivalent) for handling log files.

For the binary log, you can set the `expire_logs_days` system variable to expire binary log files automatically after a given number of days (see [Section 5.1.3, “Server System Variables”](#)). If you are using replication, you should set the variable no lower than the maximum number of days your slaves might lag behind the master.

You can force MySQL to start using new log files by issuing a `FLUSH LOGS` statement or executing `mysqladmin flush-logs` or `mysqladmin refresh`. See [Section 12.5.6.3, “FLUSH Syntax”](#), and [Section 4.5.2, “mysqladmin — Client for Administering a MySQL Server”](#).

A log flushing operation does the following:

- If general query logging or slow query logging to a log file is enabled, the server closes and reopens the general query log file or slow query log file.
- If binary logging is enabled, the server closes the current binary log file and opens a new log file with the next sequence number.
- If the server was given an error log file name with the `--log-error` option, it renames the error log with the suffix `-old` and creates a new empty error log file.

The server creates a new binary log file when you flush the logs. However, it just closes and reopens the general and slow query log files. To cause new files to be created on Unix, rename the current logs before flushing them. At flush time, the server will open new logs with the original names. For example, if the general and slow query logs are named `mysql.log` and `mysql-`

`slow.log`, you can use a series of commands like this:

```
shell> cd mysql-data-directory
shell> mv mysql.log mysql.old
shell> mv mysql-slow.log mysql-slow.old
shell> mysqladmin flush-logs
```

At this point, you can make a backup of `mysql.old` and `mysql-slow.log` and then remove them from disk.

Before 5.1.3, you cannot rename a log file on Windows while the server has it open. You must stop the server and rename the file, and then restart the server to create a new log file. As of 5.1.3, this applies only to the error log. However, a stop and restart can be avoided by using `FLUSH LOGS`, which causes the server to rename the error log with an `-old` suffix and open a new error log.

As of MySQL 5.1.2, you can disable the general query log or slow query log at runtime:

```
SET GLOBAL general_log = 'OFF';
SET GLOBAL slow_query_log = 'OFF';
```

With the logs disabled, rename the log files externally; for example, from the command line. Then enable the logs again:

```
SET GLOBAL general_log = 'ON';
SET GLOBAL slow_query_log = 'ON';
```

This method works on any platform and does not require a server restart.

## 5.3. General Security Issues

This section describes some general security issues to be aware of and what you can do to make your MySQL installation more secure against attack or misuse. For information specifically about the access control system that MySQL uses for setting up user accounts and checking database access, see [Section 5.4, “The MySQL Access Privilege System”](#).

For answers to some questions that are often asked about MySQL Server security issues, see [Section A.9, “MySQL 5.1 FAQ — Security”](#).

### 5.3.1. General Security Guidelines

Anyone using MySQL on a computer connected to the Internet should read this section to avoid the most common security mistakes.

In discussing security, we emphasize the necessity of fully protecting the entire server host (not just the MySQL server) against all types of applicable attacks: eavesdropping, altering, playback, and denial of service. We do not cover all aspects of availability and fault tolerance here.

MySQL uses security based on Access Control Lists (ACLs) for all connections, queries, and other operations that users can attempt to perform. There is also support for SSL-encrypted connections between MySQL clients and servers. Many of the concepts discussed here are not specific to MySQL at all; the same general ideas apply to almost all applications.

When running MySQL, follow these guidelines whenever possible:

- **Do not ever give anyone (except MySQL `root` accounts) access to the `user` table in the `mysql` database!** This is critical.
- Learn the MySQL access privilege system. The `GRANT` and `REVOKE` statements are used for controlling access to MySQL. Do not grant more privileges than necessary. Never grant privileges to all hosts.

Checklist:

- Try `mysql -u root`. If you are able to connect successfully to the server without being asked for a password, anyone can connect to your MySQL server as the MySQL `root` user with full privileges! Review the MySQL installation instructions, paying particular attention to the information about setting a `root` password. See [Section 2.11.3, “Securing the Initial MySQL Accounts”](#).
- Use the `SHOW GRANTS` statement to check which accounts have access to what. Then use the `REVOKE` statement to remove those privileges that are not necessary.
- Do not store any plain-text passwords in your database. If your computer becomes compromised, the intruder can take the full list of passwords and use them. Instead, use `MD5 ( )`, `SHA1 ( )`, or some other one-way hashing function and store the hash value.
- Do not choose passwords from dictionaries. Special programs exist to break passwords. Even passwords like “xfish98” are very bad. Much better is “duag98” which contains the same word “fish” but typed one key to the left on a standard QWERTY key-

board. Another method is to use a password that is taken from the first characters of each word in a sentence (for example, “Mary had a little lamb” results in a password of “Mhall”). The password is easy to remember and type, but difficult to guess for someone who does not know the sentence.

- Invest in a firewall. This protects you from at least 50% of all types of exploits in any software. Put MySQL behind the firewall or in a demilitarized zone (DMZ).

Checklist:

- Try to scan your ports from the Internet using a tool such as [nmap](#). MySQL uses port 3306 by default. This port should not be accessible from untrusted hosts. Another simple way to check whether or not your MySQL port is open is to try the following command from some remote machine, where `server_host` is the host name or IP number of the host on which your MySQL server runs:

```
shell> telnet server_host 3306
```

If you get a connection and some garbage characters, the port is open, and should be closed on your firewall or router, unless you really have a good reason to keep it open. If `telnet` hangs or the connection is refused, the port is blocked, which is how you want it to be.

- Do not trust any data entered by users of your applications. They can try to trick your code by entering special or escaped character sequences in Web forms, URLs, or whatever application you have built. Be sure that your application remains secure if a user enters something like “ `; DROP DATABASE mysql ;`”. This is an extreme example, but large security leaks and data loss might occur as a result of hackers using similar techniques, if you do not prepare for them.

A common mistake is to protect only string data values. Remember to check numeric data as well. If an application generates a query such as `SELECT * FROM table WHERE ID=234` when a user enters the value 234, the user can enter the value `234 OR 1=1` to cause the application to generate the query `SELECT * FROM table WHERE ID=234 OR 1=1`. As a result, the server retrieves every row in the table. This exposes every row and causes excessive server load. The simplest way to protect from this type of attack is to use single quotes around the numeric constants: `SELECT * FROM table WHERE ID= '234'`. If the user enters extra information, it all becomes part of the string. In a numeric context, MySQL automatically converts this string to a number and strips any trailing non-numeric characters from it.

Sometimes people think that if a database contains only publicly available data, it need not be protected. This is incorrect. Even if it is allowable to display any row in the database, you should still protect against denial of service attacks (for example, those that are based on the technique in the preceding paragraph that causes the server to waste resources). Otherwise, your server becomes unresponsive to legitimate users.

Checklist:

- Try to enter single and double quote marks (“'” and “””) in all of your Web forms. If you get any kind of MySQL error, investigate the problem right away.
- Try to modify dynamic URLs by adding `%22` (“”), `%23` (“#”), and `%27` (“'”) to them.
- Try to modify data types in dynamic URLs from numeric to character types using the characters shown in the previous examples. Your application should be safe against these and similar attacks.
- Try to enter characters, spaces, and special symbols rather than numbers in numeric fields. Your application should remove them before passing them to MySQL or else generate an error. Passing unchecked values to MySQL is very dangerous!
- Check the size of data before passing it to MySQL.
- Have your application connect to the database using a user name different from the one you use for administrative purposes. Do not give your applications any access privileges they do not need.
- Many application programming interfaces provide a means of escaping special characters in data values. Properly used, this prevents application users from entering values that cause the application to generate statements that have a different effect than you intend:
  - MySQL C API: Use the `mysql_real_escape_string()` API call.
  - MySQL++: Use the `escape` and `quote` modifiers for query streams.
  - PHP: Use the `mysql_real_escape_string()` function (available as of PHP 4.3.0, prior to that PHP version use `mysql_escape_string()`, and prior to PHP 4.0.3, use `addslashes()`). Note that only `mysql_real_escape_string()` is character set-aware; the other functions can be “bypassed” when using (invalid) multi-byte character sets. In PHP 5, you can use the `mysqli` extension, which supports the improved MySQL authentication protocol and passwords, as well as prepared statements with placeholders.

- Perl DBI: Use placeholders or the `quote()` method.
- Ruby DBI: Use placeholders or the `quote()` method.
- Java JDBC: Use a `PreparedStatement` object and placeholders.

Other programming interfaces might have similar capabilities.

- Do not transmit plain (unencrypted) data over the Internet. This information is accessible to everyone who has the time and ability to intercept it and use it for their own purposes. Instead, use an encrypted protocol such as SSL or SSH. MySQL supports internal SSL connections as of version 4.0. Another technique is to use SSH port-forwarding to create an encrypted (and compressed) tunnel for the communication.
- Learn to use the `tcpdump` and `strings` utilities. In most cases, you can check whether MySQL data streams are unencrypted by issuing a command like the following:

```
shell> tcpdump -l -i eth0 -w - src or dst port 3306 | strings
```

This works under Linux and should work with small modifications under other systems.

### Warning

If you do not see plaintext data, this does not always mean that the information actually is encrypted. If you need high security, you should consult with a security expert.

## 5.3.2. Making MySQL Secure Against Attackers

When you connect to a MySQL server, you should use a password. The password is not transmitted in clear text over the connection. Password handling during the client connection sequence was upgraded in MySQL 4.1.1 to be very secure. If you are still using pre-4.1.1-style passwords, the encryption algorithm is not as strong as the newer algorithm. With some effort, a clever attacker who can sniff the traffic between the client and the server can crack the password. (See [Section 5.5.6.3, “Password Hashing in MySQL”](#), for a discussion of the different password handling methods.)

### MySQL Enterprise

The MySQL Enterprise Monitor enforces best practices for maximizing the security of your servers. For more information, see <http://www.mysql.com/products/enterprise/advisors.html>.

All other information is transferred as text, and can be read by anyone who is able to watch the connection. If the connection between the client and the server goes through an untrusted network, and you are concerned about this, you can use the compressed protocol to make traffic much more difficult to decipher. You can also use MySQL's internal SSL support to make the connection even more secure. See [Section 5.5.7, “Using SSL for Secure Connections”](#). Alternatively, use SSH to get an encrypted TCP/IP connection between a MySQL server and a MySQL client. You can find an Open Source SSH client at <http://www.openssh.org/>, and a commercial SSH client at <http://www.ssh.com/>.

To make a MySQL system secure, you should strongly consider the following suggestions:

- Require all MySQL accounts to have a password. A client program does not necessarily know the identity of the person running it. It is common for client/server applications that the user can specify any user name to the client program. For example, anyone can use the `mysql` program to connect as any other person simply by invoking it as `mysql -u other_user db_name` if `other_user` has no password. If all accounts have a password, connecting using another user's account becomes much more difficult.

For a discussion of methods for setting passwords, see [Section 5.5.5, “Assigning Account Passwords”](#).

- Never run the MySQL server as the Unix `root` user. This is extremely dangerous, because any user with the `FILE` privilege is able to cause the server to create files as `root` (for example, `~root/.bashrc`). To prevent this, `mysqld` refuses to run as `root` unless that is specified explicitly using the `--user=root` option.

`mysqld` can (and should) be run as an ordinary, unprivileged user instead. You can create a separate Unix account named `mysql` to make everything even more secure. Use this account only for administering MySQL. To start `mysqld` as a different Unix user, add a `user` option that specifies the user name in the `[mysqld]` group of the `my.cnf` option file where you specify server options. For example:

```
[mysqld]
user=mysql
```

This causes the server to start as the designated user whether you start it manually or by using `mysqld_safe` or

`mysql.server`. For more details, see [Section 5.3.5, “How to Run MySQL as a Normal User”](#).

Running `mysqld` as a Unix user other than `root` does not mean that you need to change the `root` user name in the `user` table. *User names for MySQL accounts have nothing to do with user names for Unix accounts.*

- Do not allow the use of symlinks to tables. (This capability can be disabled with the `--skip-symbolic-links` option.) This is especially important if you run `mysqld` as `root`, because anyone that has write access to the server's data directory then could delete any file in the system! See [Section 7.6.1.2, “Using Symbolic Links for Tables on Unix”](#).
- Make sure that the only Unix user account with read or write privileges in the database directories is the account that is used for running `mysqld`.
- Do not grant the `PROCESS` or `SUPER` privilege to non-administrative users. The output of `mysqladmin processlist` and `SHOW PROCESSLIST` shows the text of any statements currently being executed, so any user who is allowed to see the server process list might be able to see statements issued by other users such as `UPDATE user SET password=PASSWORD('not_secure')`.

`mysqld` reserves an extra connection for users who have the `SUPER` privilege, so that a MySQL `root` user can log in and check server activity even if all normal connections are in use.

The `SUPER` privilege can be used to terminate client connections, change server operation by changing the value of system variables, and control replication servers.

- Do not grant the `FILE` privilege to non-administrative users. Any user that has this privilege can write a file anywhere in the file system with the privileges of the `mysqld` daemon. To make this a bit safer, files generated with `SELECT ... INTO OUTFILE` do not overwrite existing files and are writable by everyone.
- The `FILE` privilege may also be used to read any file that is world-readable or accessible to the Unix user that the server runs as. With this privilege, you can read any file into a database table. This could be abused, for example, by using `LOAD DATA` to load `/etc/passwd` into a table, which then can be displayed with `SELECT`.
- If you do not trust your DNS, you should use IP numbers rather than host names in the grant tables. In any case, you should be very careful about creating grant table entries using host name values that contain wildcards.
  - If you want to restrict the number of connections allowed to a single account, you can do so by setting the `max_user_connections` variable in `mysqld`. The `GRANT` statement also supports resource control options for limiting the extent of server use allowed to an account. See [Section 12.5.1.3, “GRANT Syntax”](#).

### 5.3.3. Security-Related `mysqld` Options

The following `mysqld` options affect security:

**Table 5.4. `mysqld` Security Option/Variable Summary**

Name	Cmd-Line	Option file	System Var	Status Var	Var Scope	Dynamic
<code>allow-suspicious-udfs</code>	Yes	Yes				
<code>automatic_sp_privileges</code>			Yes		Global	Yes
<code>chroot</code>	Yes	Yes				
<code>des-key-file</code>	Yes	Yes				
<code>local_infile</code>			Yes		Global	Yes
<code>local-infile</code> - Variable: <code>local_infile</code>	Yes	Yes				
<code>old-passwords</code> - Variable: <code>old_passwords</code>	Yes	Yes			Both	Yes
			Yes		Both	Yes
<code>safe-show-database</code>	Yes	Yes	Yes		Global	Yes
<code>safe-user-create</code>	Yes	Yes				
<code>secure-auth</code> - Variable: <code>secure_auth</code>	Yes	Yes			Global	Yes
			Yes		Global	Yes
<code>secure-file-priv</code> - Variable: <code>secure_file_priv</code>	Yes	Yes			Global	No
			Yes		Global	No



Name	Cmd-Line	Option file	System Var	Status Var	Var Scope	Dynamic
<a href="#">skip-grant-tables</a>	Yes	Yes				
<a href="#">skip-name-resolve</a>	Yes	Yes				
<a href="#">skip-networking</a>	Yes	Yes			Global	No
- Variable: skip_networking			Yes		Global	No
<a href="#">skip-show-database</a>	Yes	Yes			Global	No
- Variable: skip_show_database			Yes		Global	No

- `--allow-suspicious-udfs`

This option controls whether user-defined functions that have only an `xxx` symbol for the main function can be loaded. By default, the option is off and only UDFs that have at least one auxiliary symbol can be loaded; this prevents attempts at loading functions from shared object files other than those containing legitimate UDFs. See [Section 21.3.2.6, “User-Defined Function Security Precautions”](#).

- `--local-infile[={0|1}]`

If you start the server with `--local-infile=0`, clients cannot use `LOCAL` in `LOAD DATA` statements. See [Section 5.3.4, “Security Issues with LOAD DATA LOCAL”](#).

- `--old-passwords`

Force the server to generate short (pre-4.1) password hashes for new passwords. This is useful for compatibility when the server must support older client programs. See [Section 5.5.6.3, “Password Hashing in MySQL”](#).

#### MySQL Enterprise

The MySQL Enterprise Monitor offers advice on the security implications of using this option. For subscription information, see <http://www.mysql.com/products/enterprise/advisors.html>.

- `--safe-show-database` (*OBSOLETE*)

In previous versions of MySQL, this option caused the `SHOW DATABASES` statement to display the names of only those databases for which the user had some kind of privilege. In MySQL 5.1, this option is no longer available as this is now the default behavior, and there is a `SHOW DATABASES` privilege that can be used to control access to database names on a per-account basis. See [Section 12.5.1.3, “GRANT Syntax”](#).

- `--safe-user-create`

If this option is enabled, a user cannot create new MySQL users by using the `GRANT` statement unless the user has the `INSERT` privilege for the `mysql.user` table or any column in the table. If you want a user to have the ability to create new users that have those privileges that the user has the right to grant, you should grant the user the following privilege:

```
GRANT INSERT(user) ON mysql.user TO 'user_name'@'host_name';
```

This ensures that the user cannot change any privilege columns directly, but has to use the `GRANT` statement to give privileges to other users.

- `--secure-auth`

Disallow authentication for accounts that have old (pre-4.1) passwords.

The `mysql` client also has a `--secure-auth` option, which prevents connections to a server if the server requires a password in old format for the client account.

- `--secure-file-priv=path`

This option limits the effect of the `LOAD_FILE()` function and the `LOAD DATA` and `SELECT ... INTO OUTFILE` statements to work only with files in the specified directory.

This option was added in MySQL 5.1.17.

- `--skip-grant-tables`

This option causes the server not to use the privilege system at all. This gives anyone with access to the server *unrestricted access to all databases*. You can cause a running server to start using the grant tables again by executing `mysqladmin`

`flush-privileges` or `mysqladmin reload` command from a system shell, or by issuing a MySQL `FLUSH PRIVILEGES` statement. This option also suppresses loading of plugins and user-defined functions (UDFs).

- `--skip-merge`

Disable the `MERGE` storage engine. This option was added in MySQL 5.1.12 and removed in 5.1.14.

- `--skip-name-resolve`

Host names are not resolved. All `Host` column values in the grant tables must be IP numbers or `localhost`.

- `--skip-networking`

Do not allow TCP/IP connections over the network. All connections to `mysqld` must be made via Unix socket files.

- `--skip-show-database`

With this option, the `SHOW DATABASES` statement is allowed only to users who have the `SHOW DATABASES` privilege, and the statement displays all database names. Without this option, `SHOW DATABASES` is allowed to all users, but displays each database name only if the user has the `SHOW DATABASES` privilege or some privilege for the database. Note that any global privilege is a privilege for the database.

- `--ssl*`

Options that begin with `--ssl` specify whether to allow clients to connect via SSL and indicate where to find SSL keys and certificates. See [Section 5.5.7.3, “SSL Command Options”](#).

### 5.3.4. Security Issues with `LOAD DATA LOCAL`

The `LOAD DATA` statement can load a file that is located on the server host, or it can load a file that is located on the client host when the `LOCAL` keyword is specified.

There are two potential security issues with supporting the `LOCAL` version of `LOAD DATA` statements:

- The transfer of the file from the client host to the server host is initiated by the MySQL server. In theory, a patched server could be built that would tell the client program to transfer a file of the server's choosing rather than the file named by the client in the `LOAD DATA` statement. Such a server could access any file on the client host to which the client user has read access.
- In a Web environment where the clients are connecting from a Web server, a user could use `LOAD DATA LOCAL` to read any files that the Web server process has read access to (assuming that a user could run any command against the SQL server). In this environment, the client with respect to the MySQL server actually is the Web server, not the remote program being run by the user who connects to the Web server.

To deal with these problems, we changed how `LOAD DATA LOCAL` is handled as of MySQL 3.23.49 and MySQL 4.0.2 (4.0.13 on Windows):

- By default, all MySQL clients and libraries in binary distributions are compiled with the `--enable-local-infile` option, to be compatible with MySQL 3.23.48 and before.
- If you build MySQL from source but do not invoke `configure` with the `--enable-local-infile` option, `LOAD DATA LOCAL` cannot be used by any client unless it is written explicitly to invoke `mysql_options(... MYSQL_OPT_LOCAL_INFILE, 0)`. See [Section 20.10.3.49, “mysql\\_options\(\)”](#).
- You can disable all `LOAD DATA LOCAL` commands from the server side by starting `mysqld` with the `--local-infile=0` option.
- For the `mysql` command-line client, enable `LOAD DATA LOCAL` by specifying the `--local-infile[=1]` option, or disable it with the `--local-infile=0` option. For `mysqlimport`, local data file loading is off by default; enable it with the `--local` or `-L` option. In any case, successful use of a local load operation requires that the server is enabled to allow it.
- If you use `LOAD DATA LOCAL` in Perl scripts or other programs that read the `[client]` group from option files, you can add the `local-infile=1` option to that group. However, to keep this from causing problems for programs that do not understand `local-infile`, specify it using the `loose-` prefix:

```
[client]
loose-local-infile=1
```



- If `LOAD DATA LOCAL` is disabled, either in the server or the client, a client that attempts to issue such a statement receives the following error message:

```
ERROR 1148: The used command is not allowed with this MySQL version
```

### MySQL Enterprise

Security advisors notify subscribers to the MySQL Enterprise Monitor whenever a server is started with the `--local-infile` option enabled. For more information, see <http://www.mysql.com/products/enterprise/advisors.html>.

## 5.3.5. How to Run MySQL as a Normal User

On Windows, you can run the server as a Windows service using a normal user account.

On Unix, the MySQL server `mysqld` can be started and run by any user. However, you should avoid running the server as the Unix `root` user for security reasons. To change `mysqld` to run as a normal unprivileged Unix user `user_name`, you must do the following:

1. Stop the server if it is running (use `mysqldadmin shutdown`).
2. Change the database directories and files so that `user_name` has privileges to read and write files in them (you might need to do this as the Unix `root` user):

```
shell> chown -R user_name /path/to/mysql/datadir
```

If you do not do this, the server will not be able to access databases or tables when it runs as `user_name`.

If directories or files within the MySQL data directory are symbolic links, `chown -R` might not follow symbolic links for you. If it does not, you will also need to follow those links and change the directories and files they point to.

3. Start the server as user `user_name`. Another alternative is to start `mysqld` as the Unix `root` user and use the `--user=user_name` option. `mysqld` starts up, then switches to run as the Unix user `user_name` before accepting any connections.
4. To start the server as the given user automatically at system startup time, specify the user name by adding a `user` option to the `[mysqld]` group of the `/etc/my.cnf` option file or the `my.cnf` option file in the server's data directory. For example:

```
[mysqld]
user=user_name
```

If your Unix machine itself isn't secured, you should assign passwords to the MySQL `root` accounts in the grant tables. Otherwise, any user with a login account on that machine can run the `mysql` client with a `--user=root` option and perform any operation. (It is a good idea to assign passwords to MySQL accounts in any case, but especially so when other login accounts exist on the server host.) See [Section 2.11, "Post-Installation Setup and Testing"](#).

## 5.4. The MySQL Access Privilege System

The primary function of the MySQL privilege system is to authenticate a user who connects from a given host and to associate that user with privileges on a database such as `SELECT`, `INSERT`, `UPDATE`, and `DELETE`. Additional functionality includes the ability to have anonymous users and to grant privileges for MySQL-specific functions such as `LOAD DATA INFILE` and administrative operations.

There are some things that you cannot do with the MySQL privilege system:

- You cannot explicitly specify that a given user should be denied access. That is, you cannot explicitly match a user and then refuse the connection.
- You cannot specify that a user has privileges to create or drop tables in a database but not to create or drop the database itself.
- A password applies globally to an account. You cannot associate a password with a specific object such as a database, table, or routine.

The user interface to the MySQL privilege system consists of SQL statements such as `CREATE USER`, `GRANT`, and `REVOKE`. See [Section 12.5.1, "Account Management Statements"](#).

Internally, the server stores privilege information in the grant tables of the `mysql` database (that is, in the database named `mysql`). The MySQL server reads the contents of these tables into memory when it starts and bases access-control decisions on the in-memory copies of the grant tables.

The MySQL privilege system ensures that all users may perform only the operations allowed to them. As a user, when you connect to a MySQL server, your identity is determined by *the host from which you connect* and *the user name you specify*. When you issue requests after connecting, the system grants privileges according to your identity and *what you want to do*.

MySQL considers both your host name and user name in identifying you because there is no reason to assume that a given user name belongs to the same person on all hosts. For example, the user `joe` who connects from `office.example.com` need not be the same person as the user `joe` who connects from `home.example.com`. MySQL handles this by allowing you to distinguish users on different hosts that happen to have the same name: You can grant one set of privileges for connections by `joe` from `office.example.com`, and a different set of privileges for connections by `joe` from `home.example.com`. To see what privileges a given account has, use the `SHOW GRANTS` statement. For example:

```
SHOW GRANTS FOR 'joe'@'office.example.com';
SHOW GRANTS FOR 'joe'@'home.example.com';
```

MySQL access control involves two stages when you run a client program that connects to the server:

**Stage 1:** The server accepts or rejects the connection based on your identity and whether you can verify your identity by supplying the correct password.

**Stage 2:** Assuming that you can connect, the server checks each statement you issue to determine whether you have sufficient privileges to perform it. For example, if you try to select rows from a table in a database or drop a table from the database, the server verifies that you have the `SELECT` privilege for the table or the `DROP` privilege for the database.

For a more detailed description of what happens during each stage, see [Section 5.4.4, “Access Control, Stage 1: Connection Verification”](#), and [Section 5.4.5, “Access Control, Stage 2: Request Verification”](#).

If your privileges are changed (either by yourself or someone else) while you are connected, those changes do not necessarily take effect immediately for the next statement that you issue. For details about the conditions under which the server reloads the grant tables, see [Section 5.4.6, “When Privilege Changes Take Effect”](#).

For general security-related advice, see [Section 5.3, “General Security Issues”](#). For help in diagnosing privilege-related problems, see [Section 5.4.7, “Causes of Access-Denied Errors”](#).

## 5.4.1. Privileges Provided by MySQL

MySQL provides privileges that apply in different contexts and at different levels of operation:

- Administrative privileges enable users to manage operation of the MySQL server. These privileges are global because they are not specific to a particular database.
- Database privileges apply to a database and to all objects within it. These privileges can be granted for specific databases, or globally so that they apply to all databases.
- Privileges for database objects such as tables, indexes, views, and stored routines can be granted for specific objects within a database, for all objects of a given type within a database (for example, all tables in a database), or globally for all objects of a given type in all databases).

Information about account privileges is stored in the `user`, `db`, `host`, `tables_priv`, `columns_priv`, and `procs_priv` tables in the `mysql` database (see [Section 5.4.2, “Privilege System Grant Tables”](#)). The MySQL server reads the contents of these tables into memory when it starts and reloads them under the circumstances indicated in [Section 5.4.6, “When Privilege Changes Take Effect”](#). Access-control decisions are based on the in-memory copies of the grant tables.

Some releases of MySQL introduce changes to the structure of the grant tables to add new access privileges or features. Whenever you update to a new version of MySQL, you should update your grant tables to make sure that they have the current structure so that you can take advantage of any new capabilities. See [Section 4.4.8, “mysql\\_upgrade — Check Tables for MySQL Upgrade”](#).

The following table shows the privilege names used at the SQL level in the `GRANT` and `REVOKE` statements, along with the column name associated with each privilege in the grant tables and the context in which the privilege applies.

Privilege	Column	Context
<code>CREATE</code>	<code>Create_priv</code>	databases, tables, or indexes
<code>DROP</code>	<code>Drop_priv</code>	databases or tables

GRANT OPTION	Grant_priv	databases, tables, or stored routines
REFERENCES	References_priv	databases or tables
EVENT	Event_priv	databases
ALTER	Alter_priv	tables
DELETE	Delete_priv	tables
INDEX	Index_priv	tables
INSERT	Insert_priv	tables
SELECT	Select_priv	tables
UPDATE	Update_priv	tables
CREATE TEMPORARY TABLES	Create_tmp_table_priv	tables
LOCK TABLES	Lock_tables_priv	tables
TRIGGER	Trigger_priv	tables
CREATE VIEW	Create_view_priv	views
SHOW VIEW	Show_view_priv	views
ALTER ROUTINE	Alter_routine_priv	stored routines
CREATE ROUTINE	Create_routine_priv	stored routines
EXECUTE	Execute_priv	stored routines
FILE	File_priv	file access on server host
CREATE USER	Create_user_priv	server administration
PROCESS	Process_priv	server administration
RELOAD	Reload_priv	server administration
REPLICATION CLIENT	Repl_client_priv	server administration
REPLICATION SLAVE	Repl_slave_priv	server administration
SHOW DATABASES	Show_db_priv	server administration
SHUTDOWN	Shutdown_priv	server administration
SUPER	Super_priv	server administration
ALL [PRIVILEGES]		server administration
USAGE		server administration

The following list provides a general description of each privilege available in MySQL. Particular SQL statements might have more specific privilege requirements than indicated here. If so, the description for the statement in question provides the details.

- The **ALL** or **ALL PRIVILEGES** privilege specifier is shorthand. It stands for “all privileges available at a given privilege level” (except **GRANT OPTION**). For example, granting **ALL** at the global or table level grants all global privileges or all table-level privileges.
- The **ALTER** privilege enables use of **ALTER TABLE** to change the structure of or rename tables. (**ALTER TABLE** also requires the **INSERT** and **CREATE** privileges.)

#### MySQL Enterprise

In some circumstances, the **ALTER** privilege is entirely unnecessary — on slaves where there are no non-replicated tables, for instance. The MySQL Enterprise Monitor notifies subscribers when accounts have inappropriate privileges. For more information, see <http://www.mysql.com/products/enterprise/advisors.html>.

- The **ALTER ROUTINE** privilege is needed to alter or drop stored routines (procedures and functions).
- The **CREATE** privilege enables creation of new databases and tables.
- The **CREATE ROUTINE** privilege is needed to create stored routines (procedures and functions).
- The **CREATE TEMPORARY TABLES** privilege enables the use of the keyword **TEMPORARY** in **CREATE TABLE** statements.
- The **CREATE USER** privilege enables use of **CREATE USER**, **DROP USER**, **RENAME USER**, and **REVOKE ALL PRIVILEGES**.
- The **CREATE VIEW** privilege enables use of **CREATE VIEW**.

- The `DELETE` privilege enables rows to be deleted from tables in a database.
- The `DROP` privilege enables you to drop (remove) existing databases, tables, and views. Beginning with MySQL 5.1.10, the `DROP` privilege is also required in order to use the statement `ALTER TABLE ... DROP PARTITION` on a partitioned table. Beginning with MySQL 5.1.16, the `DROP` privilege is required for `TRUNCATE TABLE` (before that, `TRUNCATE TABLE` requires the `DELETE` privilege). *If you grant the `DROP` privilege for the `mysql` database to a user, that user can drop the database in which the MySQL access privileges are stored.*
- The `EVENT` privilege is required to create, alter, or drop events for the Event Scheduler. This privilege was added in MySQL 5.1.6.
- The `EXECUTE` privilege is required to execute stored routines (procedures and functions).
- The `FILE` privilege gives you permission to read and write files on the server host using the `LOAD DATA INFILE` and `SELECT ... INTO OUTFILE` statements. A user who has the `FILE` privilege can read any file on the server host that is either world-readable or readable by the MySQL server. (This implies the user can read any file in any database directory, because the server can access any of those files.) The `FILE` privilege also enables the user to create new files in any directory where the MySQL server has write access. As a security measure, the server will not overwrite existing files.
- The `GRANT OPTION` privilege enables you to give to other users or remove from other users those privileges that you yourself possess.
- The `INDEX` privilege enables you to create or drop (remove) indexes. `INDEX` applies to existing tables. If you have the `CREATE` privilege for a table, you can include index definitions in the `CREATE TABLE` statement.
- The `INSERT` privilege enables rows to be inserted into tables in a database. `INSERT` is also required for the `ANALYZE TABLE`, `OPTIMIZE TABLE`, and `REPAIR TABLE` table-maintenance statements.
- The `LOCK TABLES` privilege enables the use of explicit `LOCK TABLES` statements to lock tables for which you have the `SELECT` privilege. This includes the use of write locks, which prevents other sessions from reading the locked table.
- The `PROCESS` privilege pertains to display of information about the threads executing within the server (that is, information about the statements being executed by sessions). The privilege enables use of `SHOW PROCESSLIST` or `mysqladmin processlist` to see threads belonging to other accounts; you can always see your own threads.
- The `REFERENCES` privilege currently is unused.
- The `RELOAD` privilege enables use of the `FLUSH` statement. It also enables `mysqladmin` commands that are equivalent to `FLUSH` operations: `flush-hosts`, `flush-logs`, `flush-privileges`, `flush-status`, `flush-tables`, `flush-threads`, `refresh`, and `reload`.

The `reload` command tells the server to reload the grant tables into memory. `flush-privileges` is a synonym for `reload`. The `refresh` command closes and reopens the log files and flushes all tables. The other `flush-xxx` commands perform functions similar to `refresh`, but are more specific and may be preferable in some instances. For example, if you want to flush just the log files, `flush-logs` is a better choice than `refresh`.

- The `REPLICATION CLIENT` privilege enables the use of `SHOW MASTER STATUS` and `SHOW SLAVE STATUS`.
- The `REPLICATION SLAVE` privilege should be granted to accounts that are used by slave servers to connect to the current server as their master. Without this privilege, the slave cannot request updates that have been made to databases on the master server.
- The `SELECT` privilege enables you to select rows from tables in a database. `SELECT` statements require the `SELECT` privilege only if they actually retrieve rows from a table. Some `SELECT` statements do not access tables and can be executed without permission for any database. For example, you can use `SELECT` as a simple calculator to evaluate expressions that make no reference to tables:

```
SELECT 1+1;
SELECT PI()*2;
```

- The `SHOW DATABASES` privilege enables the account to see database names by issuing the `SHOW DATABASE` statement. Accounts that do not have this privilege see only databases for which they have some privileges, and cannot use the statement at all if the server was started with the `--skip-show-database` option. Note that *any* global privilege is a privilege for the database.

#### MySQL Enterprise

The `SHOW DATABASES` privilege should be granted only to users who need to see all the databases on a MySQL server. Subscribers to the MySQL Enterprise Monitor are alerted when servers are started without the `--skip-show-database` option. For more information, see <http://www.mysql.com/products/enterprise/advisors.html>.

- The `SHOW VIEW` privilege enables use of `SHOW CREATE VIEW`.
- The `SHUTDOWN` privilege enables use of the `mysqladmin shutdown` command. There is no corresponding SQL statement.
- The `SUPER` privilege enables use of `CHANGE MASTER TO`, `KILL` or `mysqladmin kill` to kill threads belonging to other accounts (you can always kill your own threads), `PURGE BINARY LOGS`, and `SET GLOBAL` statements, the `mysqladmin debug` command, and allows you to connect (once) even if the connection limit controlled by the `max_connections` system variable is reached.

To create or alter stored functions if binary logging is enabled, you may also need the `SUPER` privilege, as described in [Section 18.6, “Binary Logging of Stored Programs”](#).

- The `TRIGGER` privilege enables you to create and drop triggers. You must have this privilege for a table to create or drop triggers for that table. This privilege was added in MySQL 5.1.6. (Prior to MySQL 5.1.6, trigger operations required the `SUPER` privilege.)
- The `UPDATE` privilege enables rows to be updated in tables in a database.
- The `USAGE` privilege specifier stands for “no privileges.” It is used at the global level with `GRANT` to modify account attributes such as resource limits or SSL characteristics without affecting existing account privileges.

It is a good idea to grant to an account only those privileges that it needs. You should exercise particular caution in granting the `FILE` and administrative privileges:

- The `FILE` privilege can be abused to read into a database table any files that the MySQL server can read on the server host. This includes all world-readable files and files in the server's data directory. The table can then be accessed using `SELECT` to transfer its contents to the client host.
- The `GRANT OPTION` privilege enables users to give their privileges to other users. Two users that have different privileges and with the `GRANT OPTION` privilege are able to combine privileges.
- The `ALTER` privilege may be used to subvert the privilege system by renaming tables.
- The `SHUTDOWN` privilege can be abused to deny service to other users entirely by terminating the server.
- The `PROCESS` privilege can be used to view the plain text of currently executing statements, including statements that set or change passwords.
- The `SUPER` privilege can be used to terminate other sessions or change how the server operates.
- Privileges granted for the `mysql` database itself can be used to change passwords and other access privilege information. Passwords are stored encrypted, so a malicious user cannot simply read them to know the plain text password. However, a user with write access to the `user` table `Password` column can change an account's password, and then connect to the MySQL server using that account.

#### MySQL Enterprise

Accounts with unnecessary global privileges constitute a security risk. Subscribers to the MySQL Enterprise Monitor are automatically alerted to the existence of such accounts. For detailed information, see <http://www.mysql.com/products/enterprise/advisors.html>.

## 5.4.2. Privilege System Grant Tables

Normally, you manipulate the contents of the grant tables indirectly by using statements such as `GRANT` and `REVOKE` to set up accounts and control the privileges available to each one. See [Section 12.5.1, “Account Management Statements”](#). The discussion here describes the underlying structure of the grant tables and how the server uses their contents when interacting with clients.

Each grant table contains scope columns and privilege columns:

- Scope columns determine the scope of each row (entry) in the tables; that is, the context in which the row applies. For example, a `user` table row with `Host` and `User` values of `'thomas.loc.gov'` and `'bob'` would be used for authenticating connections made to the server from the host `thomas.loc.gov` by a client that specifies a user name of `bob`. Similarly, a `db` table row with `Host`, `User`, and `Db` column values of `'thomas.loc.gov'`, `'bob'` and `'reports'` would be used when `bob` connects from the host `thomas.loc.gov` to access the `reports` database. The `tables_priv` and `columns_priv` tables contain scope columns indicating tables or table/column combinations to which each row applies. The `procs_priv` scope columns indicate the stored routine to which each row applies.

- Privilege columns indicate which privileges are granted by a table row; that is, what operations can be performed. The server combines the information in the various grant tables to form a complete description of a user's privileges. [Section 5.4.5, “Access Control, Stage 2: Request Verification”](#), describes the rules that are used to do this.

The server uses the grant tables in the following manner:

- The `user` table scope columns determine whether to reject or allow incoming connections. For allowed connections, any privileges granted in the `user` table indicate the user's global (superuser) privileges. Any privilege granted in this table applies to *all* databases on the server.

**Note**

Because any global privilege is considered a privilege for all databases, any global privilege enables a user to see all database names with `SHOW DATABASES` or by examining the `SCHEMATA` table of `INFORMATION_SCHEMA`.

- The `db` table scope columns determine which users can access which databases from which hosts. The privilege columns determine which operations are allowed. A privilege granted at the database level applies to the database and to all objects in the database, such as tables and stored programs.
- The `host` table is used in conjunction with the `db` table when you want a given `db` table row to apply to several hosts. For example, if you want a user to be able to use a database from several hosts in your network, leave the `Host` value empty in the user's `db` table row, then populate the `host` table with a row for each of those hosts. This mechanism is described more detail in [Section 5.4.5, “Access Control, Stage 2: Request Verification”](#).

**Note**

The `host` table must be modified directly with statements such as `INSERT`, `UPDATE`, and `DELETE`. It is not affected by statements such as `GRANT` and `REVOKE` that modify the grant tables indirectly. Most MySQL installations need not use this table at all.

- The `tables_priv` and `columns_priv` tables are similar to the `db` table, but are more fine-grained: They apply at the table and column levels rather than at the database level. A privilege granted at the table level applies to the table and to all its columns. A privilege granted at the column level applies only to a specific column.
- The `procs_priv` table applies to stored routines. A privilege granted at the routine level applies only to a single routine.

The server uses the `user`, `db`, and `host` tables in the `mysql` database at both the first and second stages of access control (see [Section 5.4, “The MySQL Access Privilege System”](#)). The columns in the `user` and `db` tables are shown here. The `host` table is similar to the `db` table but has a specialized use as described in [Section 5.4.5, “Access Control, Stage 2: Request Verification”](#).

Table Name	user	db
<b>Scope columns</b>	<code>Host</code>	<code>Host</code>
	<code>User</code>	<code>Db</code>
	<code>Password</code>	<code>User</code>
<b>Privilege columns</b>	<code>Select_priv</code>	<code>Select_priv</code>
	<code>Insert_priv</code>	<code>Insert_priv</code>
	<code>Update_priv</code>	<code>Update_priv</code>
	<code>Delete_priv</code>	<code>Delete_priv</code>
	<code>Index_priv</code>	<code>Index_priv</code>
	<code>Alter_priv</code>	<code>Alter_priv</code>
	<code>Create_priv</code>	<code>Create_priv</code>
	<code>Drop_priv</code>	<code>Drop_priv</code>
	<code>Grant_priv</code>	<code>Grant_priv</code>
	<code>Create_view_priv</code>	<code>Create_view_priv</code>
	<code>Show_view_priv</code>	<code>Show_view_priv</code>
	<code>Create_routine_priv</code>	<code>Create_routine_priv</code>
	<code>Alter_routine_priv</code>	<code>Alter_routine_priv</code>
	<code>Execute_priv</code>	<code>Execute_priv</code>
	<code>Trigger_priv</code>	<code>Trigger_priv</code>

	Event_priv	Event_priv
	Create_tmp_table_priv	Create_tmp_table_priv
	Lock_tables_priv	Lock_tables_priv
	References_priv	References_priv
	Reload_priv	
	Shutdown_priv	
	Process_priv	
	File_priv	
	Show_db_priv	
	Super_priv	
	Repl_slave_priv	
	Repl_client_priv	
	Create_user_priv	
<b>Security columns</b>	ssl_type	
	ssl_cipher	
	x509_issuer	
	x509_subject	
<b>Resource control columns</b>	max_questions	
	max_updates	
	max_connections	
	max_user_connections	

The `Event_priv` and `Trigger_priv` columns were added in MySQL 5.1.6.

During the second stage of access control, the server performs request verification to make sure that each client has sufficient privileges for each request that it issues. In addition to the `user`, `db`, and `host` grant tables, the server may also consult the `tables_priv` and `columns_priv` tables for requests that involve tables. The latter tables provide finer privilege control at the table and column levels. They have the columns shown in the following table.

Table Name	tables_priv	columns_priv
<b>Scope columns</b>	Host	Host
	Db	Db
	User	User
	Table_name	Table_name
		Column_name
<b>Privilege columns</b>	Table_priv	Column_priv
	Column_priv	
<b>Other columns</b>	Timestamp	Timestamp
	Grantor	

The `Timestamp` and `Grantor` columns currently are unused and are discussed no further here.

For verification of requests that involve stored routines, the server may consult the `procs_priv` table, which has the columns shown in the following table.

Table Name	procs_priv
<b>Scope columns</b>	Host
	Db
	User
	Routine_name
	Routine_type
<b>Privilege columns</b>	Proc_priv



<b>Other columns</b>	Timestamp
	Grantor

The `Routine_type` column is an `ENUM` column with values of `'FUNCTION'` or `'PROCEDURE'` to indicate the type of routine the row refers to. This column enables privileges to be granted separately for a function and a procedure with the same name.

The `Timestamp` and `Grantor` columns currently are unused and are discussed no further here.

Scope columns in the grant tables contain strings. They are declared as shown here; the default value for each is the empty string.

Column Name	Type
Host	CHAR(60)
User	CHAR(16)
Password	CHAR(41)
Db	CHAR(64)
Table_name	CHAR(64)
Column_name	CHAR(64)
Routine_name	CHAR(64)

For access-checking purposes, comparisons of `User`, `Password`, `Db`, and `Table_name` values are case sensitive. Comparisons of `Host`, `Column_name`, and `Routine_name` values are not case sensitive.

In the `user`, `db`, and `host` tables, each privilege is listed in a separate column that is declared as `ENUM('N','Y') DEFAULT 'N'`. In other words, each privilege can be disabled or enabled, with the default being disabled.

In the `tables_priv`, `columns_priv`, and `procs_priv` tables, the privilege columns are declared as `SET` columns. Values in these columns can contain any combination of the privileges controlled by the table. Only those privileges listed in the column value are enabled.

Table Name	Column Name	Possible Set Elements
<code>tables_priv</code>	<code>Table_priv</code>	'Select', 'Insert', 'Update', 'Delete', 'Create', 'Drop', 'Grant', 'References', 'Index', 'Alter', 'Create View', 'Show view', 'Trigger'
<code>tables_priv</code>	<code>Column_priv</code>	'Select', 'Insert', 'Update', 'References'
<code>columns_priv</code>	<code>Column_priv</code>	'Select', 'Insert', 'Update', 'References'
<code>procs_priv</code>	<code>Proc_priv</code>	'Execute', 'Alter Routine', 'Grant'

Administrative privileges (such as `RELOAD` or `SHUTDOWN`) are specified only in the `user` table. Administrative operations are operations on the server itself and are not database-specific, so there is no reason to list these privileges in the other grant tables. Consequently, to determine whether you can perform an administrative operation, the server need consult only the `user` table.

The `FILE` privilege also is specified only in the `user` table. It is not an administrative privilege as such, but your ability to read or write files on the server host is independent of the database you are accessing.

The `mysqld` server reads the contents of the grant tables into memory when it starts. You can tell it to reload the tables by issuing a `FLUSH PRIVILEGES` statement or executing a `mysqladmin flush-privileges` or `mysqladmin reload` command. Changes to the grant tables take effect as indicated in [Section 5.4.6, “When Privilege Changes Take Effect”](#).

When you modify an account's privileges, it is a good idea to verify that the changes set up privileges the way you want. To check the privileges for a given account, use the `SHOW GRANTS` statement (see [Section 12.5.5.22, “SHOW GRANTS Syntax”](#)). For example, to determine the privileges that are granted to an account with user name and host name values of `bob` and `pc84.example.com`, use this statement:

```
SHOW GRANTS FOR 'bob'@'pc84.example.com';
```

### 5.4.3. Specifying Account Names

MySQL account names consist of a user name and a host name. This enables creation of accounts for users with the same name who can connect from different hosts. This section describes how to write account names, including special values and wildcard rules.



Within SQL statements such as `CREATE USER`, `GRANT`, and `SET PASSWORD`, account names are written using the following rules:

- Syntax for account names is `'user_name'@'host_name'`.
- An account name consisting only of a user name is equivalent to `'user_name'@'%'`. For example, `'me'` is equivalent to `'me'@'%'`.
- The user name and host name need not be quoted if they are legal as unquoted identifiers. Quotes are necessary to specify a `user_name` string containing special characters (such as “-”), or a `host_name` string containing special characters or wildcard characters (such as “%”); for example, `'test-user'@'%.com'`.
- Quote user names and host names as identifiers or as strings, using either backticks (“`”), single quotes (“'”), or double quotes (“”).
- The user name and host name parts, if quoted, must be quoted separately. That is, write `'me'@'localhost'`, not `'me@localhost'`; the latter is interpreted as `'me@localhost'@'%'`.

Account names are stored in grant tables using separate columns for the user name and host name parts:

- The `user` table contains one row for each account. The `User` and `Host` columns store the user name and host name. Another column, `Password`, stores the account password. This table also indicates which global privileges the account has.
- Other grant tables indicate privileges an account has for databases and objects within databases. These tables have `User` and `Host` columns to store the account name. Each row in these tables associates with the account in the `user` table that has the same `User` and `Host` values.

For additional detail about grant table structure, see [Section 5.4.2, “Privilege System Grant Tables”](#).

User names and host names have certain special values or wildcard conventions, as described following.

A user name is either a non-blank value that literally matches the user name for incoming connection attempts, or a blank value (empty string) that matches any user name. An account with a blank user name is an anonymous user. To specify an anonymous user in SQL statements, use a quoted empty user name part, such as `'@'localhost'`.

The host part of an account name can take many forms, and wildcards are allowed:

- A host value can be a host name or an IP number. `'localhost'` indicates the local host. `'127.0.0.1'` indicates the loop-back interface.
- You can use the wildcard characters “%” and “\_” in host values. These have the same meaning as for pattern-matching operations performed with the `LIKE` operator. For example, a host value of `'%'` matches any host name, whereas a value of `'%.mysql.com'` matches any host in the `mysql.com` domain. `'192.168.1.%'` matches any host in the 192.168.1 class C network.

Because you can use IP wildcard values in host values (for example, `'192.168.1.%'` to match every host on a subnet), someone could try to exploit this capability by naming a host `192.168.1.somewhere.com`. To foil such attempts, MySQL disallows matching on host names that start with digits and a dot. Thus, if you have a host named something like `1.2.example.com`, its name never matches the host part of account names. An IP wildcard value can match only IP numbers, not host names.

#### MySQL Enterprise

An overly broad host specifier such as “%” constitutes a security risk. The MySQL Enterprise Monitor provides safeguards against this kind of vulnerability. For more information, see <http://www.mysql.com/products/enterprise/advisors.html>.

- For host values specified as IP numbers, you can specify a netmask indicating how many address bits to use for the network number. The syntax is `host_ip/netmask`. For example:

```
CREATE USER 'david'@'192.58.197.0/255.255.255.0';
```

This enables `david` to connect from any client host having an IP number `client_ip` for which the following condition is true:

```
client_ip & netmask = host_ip
```

That is, for the `CREATE USER` statement just shown:

```
client_ip & 255.255.255.0 = 192.58.197.0
```

IP numbers that satisfy this condition and can connect to the MySQL server are those in the range from `192.58.197.0` to `192.58.197.255`.

The netmask can only be used to tell the server to use 8, 16, 24, or 32 bits of the address. Examples:

- `192.0.0.0/255.0.0.0`: anything on the 192 class A network
- `192.168.0.0/255.255.0.0`: anything on the 192.168 class B network
- `192.168.1.0/255.255.255.0`: anything on the 192.168.1 class C network
- `192.168.1.1`: only this specific IP

The following netmask (28 bits) will not work:

```
192.168.0.1/255.255.255.240
```

## 5.4.4. Access Control, Stage 1: Connection Verification

When you attempt to connect to a MySQL server, the server accepts or rejects the connection based on your identity and whether you can verify your identity by supplying the correct password. If not, the server denies access to you completely. Otherwise, the server accepts the connection, and then enters Stage 2 and waits for requests.

Your identity is based on two pieces of information:

- The client host from which you connect
- Your MySQL user name

Identity checking is performed using the three `user` table scope columns (`Host`, `User`, and `Password`). The server accepts the connection only if the `Host` and `User` columns in some `user` table row match the client host name and user name and the client supplies the password specified in that row. The rules for allowable `Host` and `User` values are given in [Section 5.4.3, “Specifying Account Names”](#).

If the `User` column value is non-blank, the user name in an incoming connection must match exactly. If the `User` value is blank, it matches any user name. If the `user` table row that matches an incoming connection has a blank user name, the user is considered to be an anonymous user with no name, not a user with the name that the client actually specified. This means that a blank user name is used for all further access checking for the duration of the connection (that is, during Stage 2).

The `Password` column can be blank. This is not a wildcard and does not mean that any password matches. It means that the user must connect without specifying a password.

Non-blank `Password` values in the `user` table represent encrypted passwords. MySQL does not store passwords in plaintext form for anyone to see. Rather, the password supplied by a user who is attempting to connect is encrypted (using the `PASS-WORD()` function). The encrypted password then is used during the connection process when checking whether the password is correct. (This is done without the encrypted password ever traveling over the connection.) See [Section 5.5.1, “User Names and Passwords”](#).

From MySQL's point of view, the encrypted password is the *real* password, so you should never give anyone access to it. In particular, *do not give non-administrative users read access to tables in the `mysql` database*.

The following table shows how various combinations of `Host` and `User` values in the `user` table apply to incoming connections.

Host Value	User Value	Allowable Connections
'thomas.loc.gov'	'fred'	fred, connecting from thomas.loc.gov
'thomas.loc.gov'	' '	Any user, connecting from thomas.loc.gov
'%'	'fred'	fred, connecting from any host
'%'	' '	Any user, connecting from any host
'%.loc.gov'	'fred'	fred, connecting from any host in the loc.gov domain

'x.y.%'	'fred'	fred, connecting from x.y.net, x.y.com, x.y.edu, and so on; this is probably not useful
'144.155.166.177'	'fred'	fred, connecting from the host with IP address 144.155.166.177
'144.155.166.%'	'fred'	fred, connecting from any host in the 144.155.166 class C subnet
'144.155.166.0/255.255.255.0'	'fred'	Same as previous example

It is possible for the client host name and user name of an incoming connection to match more than one row in the `user` table. The preceding set of examples demonstrates this: Several of the entries shown match a connection from `thomas.loc.gov` by `fred`.

When multiple matches are possible, the server must determine which of them to use. It resolves this issue as follows:

- Whenever the server reads the `user` table into memory, it sorts the rows.
- When a client attempts to connect, the server looks through the rows in sorted order.
- The server uses the first row that matches the client host name and user name.

To see how this works, suppose that the `user` table looks like this:

```

+-----+-----+
| Host      | User  | ...
+-----+-----+
| %         | root  | ...
| %         | jeffrey | ...
| localhost | root  | ...
| localhost |       | ...
+-----+-----+

```

When the server reads the table into memory, it orders the rows with the most-specific `Host` values first. Literal host names and IP numbers are the most specific. (The specificity of a literal IP number is not affected by whether it has a netmask, so `192.168.1.13` and `192.168.1.0/255.255.255.0` are considered equally specific.) The pattern `'%'` means “any host” and is least specific. Rows with the same `Host` value are ordered with the most-specific `User` values first (a blank `User` value means “any user” and is least specific). For the `user` table just shown, the result after sorting looks like this:

```

+-----+-----+
| Host      | User  | ...
+-----+-----+
| localhost | root  | ...
| localhost |       | ...
| %         | jeffrey | ...
| %         | root  | ...
+-----+-----+

```

When a client attempts to connect, the server looks through the sorted rows and uses the first match found. For a connection from `localhost` by `jeffrey`, two of the rows from the table match: the one with `Host` and `User` values of `'localhost'` and `''`, and the one with values of `'%'` and `'jeffrey'`. The `'localhost'` row appears first in sorted order, so that is the one the server uses.

Here is another example. Suppose that the `user` table looks like this:

```

+-----+-----+
| Host      | User  | ...
+-----+-----+
| %         | jeffrey | ...
| thomas.loc.gov |       | ...
+-----+-----+

```

The sorted table looks like this:

```

+-----+-----+
| Host      | User  | ...
+-----+-----+
| thomas.loc.gov |       | ...
| %         | jeffrey | ...
+-----+-----+

```

A connection by `jeffrey` from `thomas.loc.gov` is matched by the first row, whereas a connection by `jeffrey` from any host is matched by the second.

**Note**

It is a common misconception to think that, for a given user name, all rows that explicitly name that user are used first when the server attempts to find a match for the connection. This is not true. The preceding example illustrates this, where a connection from `thomas.loc.gov` by `jeffrey` is first matched not by the row containing `'jeffrey'` as the `User` column value, but by the row with no user name. As a result, `jeffrey` is authenticated as an anonymous user, even though he specified a user name when connecting.

If you are able to connect to the server, but your privileges are not what you expect, you probably are being authenticated as some other account. To find out what account the server used to authenticate you, use the `CURRENT_USER()` function. (See [Section 11.11.3, “Information Functions”](#).) It returns a value in `user_name@host_name` format that indicates the `User` and `Host` values from the matching `user` table row. Suppose that `jeffrey` connects and issues the following query:

```
mysql> SELECT CURRENT_USER();
+-----+
| CURRENT_USER() |
+-----+
| @localhost     |
+-----+
```

The result shown here indicates that the matching `user` table row had a blank `User` column value. In other words, the server is treating `jeffrey` as an anonymous user.

Another way to diagnose authentication problems is to print out the `user` table and sort it by hand to see where the first match is being made.

## 5.4.5. Access Control, Stage 2: Request Verification

After you establish a connection, the server enters Stage 2 of access control. For each request that you issue via that connection, the server determines what operation you want to perform, then checks whether you have sufficient privileges to do so. This is where the privilege columns in the grant tables come into play. These privileges can come from any of the `user`, `db`, `host`, `tables_priv`, `columns_priv`, or `procs_priv` tables. (You may find it helpful to refer to [Section 5.4.2, “Privilege System Grant Tables”](#), which lists the columns present in each of the grant tables.)

The `user` table grants privileges that are assigned to you on a global basis and that apply no matter what the default database is. For example, if the `user` table grants you the `DELETE` privilege, you can delete rows from any table in any database on the server host! In other words, `user` table privileges are superuser privileges. It is wise to grant privileges in the `user` table only to superusers such as database administrators. For other users, you should leave all privileges in the `user` table set to `'N'` and grant privileges at more specific levels only. You can grant privileges for particular databases, tables, columns, or routines.

The `db` and `host` tables grant database-specific privileges. Values in the scope columns of these tables can take the following forms:

- A blank `User` value in the `db` table matches the anonymous user. A non-blank value matches literally; there are no wildcards in user names.
- The wildcard characters “%” and “\_” can be used in the `Host` and `Db` columns of either table. These have the same meaning as for pattern-matching operations performed with the `LIKE` operator. If you want to use either character literally when granting privileges, you must escape it with a backslash. For example, to include the underscore character (“\_”) as part of a database name, specify it as “\\_” in the `GRANT` statement.
- A `'%'` `Host` value in the `db` table means “any host.” A blank `Host` value in the `db` table means “consult the `host` table for further information” (a process that is described later in this section).
- A `'%'` or blank `Host` value in the `host` table means “any host.”
- A `'%'` or blank `Db` value in either table means “any database.”

The server reads the `db` and `host` tables into memory and sorts them at the same time that it reads the `user` table. The server sorts the `db` table based on the `Host`, `Db`, and `User` scope columns, and sorts the `host` table based on the `Host` and `Db` scope columns. As with the `user` table, sorting puts the most-specific values first and least-specific values last, and when the server looks for matching entries, it uses the first match that it finds.

The `tables_priv`, `columns_priv`, and `procs_priv` tables grant table-specific, column-specific, and routine-specific privileges. Values in the scope columns of these tables can take the following forms:

- The wildcard characters “%” and “\_” can be used in the `Host` column. These have the same meaning as for pattern-matching operations performed with the `LIKE` operator.

- A '%' or blank `Host` value means “any host.”
- The `Db`, `Table_name`, `Column_name`, and `Routine_name` columns cannot contain wildcards or be blank.

The server sorts the `tables_priv`, `columns_priv`, and `procs_priv` tables based on the `Host`, `Db`, and `User` columns. This is similar to `db` table sorting, but simpler because only the `Host` column can contain wildcards.

The server uses the sorted tables to verify each request that it receives. For requests that require administrative privileges such as `SHUTDOWN` or `RELOAD`, the server checks only the `user` table row because that is the only table that specifies administrative privileges. The server grants access if the row allows the requested operation and denies access otherwise. For example, if you want to execute `mysqladmin shutdown` but your `user` table row doesn't grant the `SHUTDOWN` privilege to you, the server denies access without even checking the `db` or `host` tables. (They contain no `Shutdown_priv` column, so there is no need to do so.)

For database-related requests (`INSERT`, `UPDATE`, and so on), the server first checks the user's global (superuser) privileges by looking in the `user` table row. If the row allows the requested operation, access is granted. If the global privileges in the `user` table are insufficient, the server determines the user's database-specific privileges by checking the `db` and `host` tables:

1. The server looks in the `db` table for a match on the `Host`, `Db`, and `User` columns. The `Host` and `User` columns are matched to the connecting user's host name and MySQL user name. The `Db` column is matched to the database that the user wants to access. If there is no row for the `Host` and `User`, access is denied.
2. If there is a matching `db` table row and its `Host` column is not blank, that row defines the user's database-specific privileges.
3. If the matching `db` table row's `Host` column is blank, it signifies that the `host` table enumerates which hosts should be allowed access to the database. In this case, a further lookup is done in the `host` table to find a match on the `Host` and `Db` columns. If no `host` table row matches, access is denied. If there is a match, the user's database-specific privileges are computed as the intersection (*not* the union!) of the privileges in the `db` and `host` table entries; that is, the privileges that are 'Y' in both entries. (This way you can grant general privileges in the `db` table row and then selectively restrict them on a host-by-host basis using the `host` table entries.)

After determining the database-specific privileges granted by the `db` and `host` table entries, the server adds them to the global privileges granted by the `user` table. If the result allows the requested operation, access is granted. Otherwise, the server successively checks the user's table and column privileges in the `tables_priv` and `columns_priv` tables, adds those to the user's privileges, and allows or denies access based on the result. For stored-routine operations, the server uses the `procs_priv` table rather than `tables_priv` and `columns_priv`.

Expressed in boolean terms, the preceding description of how a user's privileges are calculated may be summarized like this:

```
global privileges
OR (database privileges AND host privileges)
OR table privileges
OR column privileges
OR routine privileges
```

It may not be apparent why, if the global `user` row privileges are initially found to be insufficient for the requested operation, the server adds those privileges to the database, table, and column privileges later. The reason is that a request might require more than one type of privilege. For example, if you execute an `INSERT INTO ... SELECT` statement, you need both the `INSERT` and the `SELECT` privileges. Your privileges might be such that the `user` table row grants one privilege and the `db` table row grants the other. In this case, you have the necessary privileges to perform the request, but the server cannot tell that from either table by itself; the privileges granted by the entries in both tables must be combined.

The `host` table is not affected by the `GRANT` or `REVOKE` statements, so it is unused in most MySQL installations. If you modify it directly, you can use it for some specialized purposes, such as to maintain a list of secure servers on the local network that are granted all privileges.

You can also use the `host` table to indicate hosts that are *not* secure. Suppose that you have a machine `public.your.domain` that is located in a public area that you do not consider secure. You can enable access to all hosts on your network except that machine by using `host` table entries like this:

```
+-----+-----+
| Host          | Db | ...
+-----+-----+
| public.your.domain | % | ... (all privileges set to 'N')
| %.your.domain   | % | ... (all privileges set to 'Y')
+-----+-----+
```

## 5.4.6. When Privilege Changes Take Effect

When `mysqld` starts, it reads all grant table contents into memory. The in-memory tables become effective for access control at

that point.

If you modify the grant tables indirectly using account-management statements such as `GRANT`, `REVOKE`, or `SET PASSWORD`, the server notices these changes and loads the grant tables into memory again immediately.

If you modify the grant tables directly using statements such as `INSERT`, `UPDATE`, or `DELETE`, your changes have no effect on privilege checking until you either restart the server or tell it to reload the tables. If you change the grant tables directly but forget to reload them, your changes have *no effect* until you restart the server. This may leave you wondering why your changes do not seem to make any difference!

To tell the server to reload the grant tables, perform a flush-privileges operation. This can be done by issuing a `FLUSH PRIVILEGES` statement or by executing a `mysqladmin flush-privileges` or `mysqladmin reload` command.

When the server reloads the grant tables, privileges for each existing client connection are affected as follows:

- Table and column privilege changes take effect with the client's next request.
- Database privilege changes take effect the next time the client executes a `USE db_name` statement.

### Note

Client applications may cache the database name; thus, this effect may not be visible to them without actually changing to a different database or flushing the privileges.

- Global privileges and passwords are unaffected for a connected client. These changes take effect only for subsequent connections.

If the server is started with the `--skip-grant-tables` option, it does not read the grant tables or implement any access control. Anyone can connect and do anything. To cause a server thus started to read the tables and enable access checking, flush the privileges.

## 5.4.7. Causes of Access-Denied Errors

If you encounter problems when you try to connect to the MySQL server, the following items describe some courses of action you can take to correct the problem.

- Make sure that the server is running. If it is not, clients cannot connect to it. For example, if an attempt to connect to the server fails with a message such as one of those following, one cause might be that the server is not running:

```
shell> mysql
ERROR 2003: Can't connect to MySQL server on 'host_name' (111)
shell> mysql
ERROR 2002: Can't connect to local MySQL server through socket
'/tmp/mysql.sock' (111)
```

- It might be that the server is running, but you are trying to connect using a TCP/IP port, named pipe, or Unix socket file different from the one on which the server is listening. To correct this when you invoke a client program, specify a `--port` option to indicate the proper port number, or a `--socket` option to indicate the proper named pipe or Unix socket file. To find out where the socket file is, you can use this command:

```
shell> netstat -ln | grep mysql
```

- Make sure that the server has not been configured to ignore network connections or (if you are attempting to connect remotely) that it has not been configured to listen only locally on its network interfaces. If the server was started with `--skip-networking`, it will not accept TCP/IP connections at all. If the server was started with `--bind-address=127.0.0.1`, it will listen for TCP/IP connections only locally on the loopback interface and will not accept remote connections.
- Check to make sure that there is no firewall blocking access to MySQL. Your firewall may be configured on the basis of the application being executed, or the port number used by MySQL for communication (3306 by default). Under Linux or Unix, check your IP tables (or similar) configuration to ensure that the port has not been blocked. Under Windows, applications such as ZoneAlarm or the Windows XP personal firewall may need to be configured not to block the MySQL port.
- The grant tables must be properly set up so that the server can use them for access control. For some distribution types (such as binary distributions on Windows, or RPM distributions on Linux), the installation process initializes the `mysql` database containing the grant tables. For distributions that do not do this, you must initialize the grant tables manually by running the `mysql_install_db` script. For details, see [Section 2.11.2, “Unix Post-Installation Procedures”](#).

To determine whether you need to initialize the grant tables, look for a `mysql` directory under the data directory. (The data directory normally is named `data` or `var` and is located under your MySQL installation directory.) Make sure that you have a file named `user.MYD` in the `mysql` database directory. If not, execute the `mysql_install_db` script. After running this script and starting the server, test the initial privileges by executing this command:

```
shell> mysql -u root test
```

The server should let you connect without error.

- After a fresh installation, you should connect to the server and set up your users and their access permissions:

```
shell> mysql -u root mysql
```

The server should let you connect because the MySQL `root` user has no password initially. That is also a security risk, so setting the password for the `root` accounts is something you should do while you're setting up your other MySQL accounts. For instructions on setting the initial passwords, see [Section 2.11.3, “Securing the Initial MySQL Accounts”](#).

### MySQL Enterprise

The MySQL Enterprise Monitor enforces security-related best practices. For example, subscribers are alerted whenever there is any account without a password. For more information, see <http://www.mysql.com/products/enterprise/advisors.html>.

- If you have updated an existing MySQL installation to a newer version, did you run the `mysql_upgrade` script? If not, do so. The structure of the grant tables changes occasionally when new capabilities are added, so after an upgrade you should always make sure that your tables have the current structure. For instructions, see [Section 4.4.8, “mysql\\_upgrade — Check Tables for MySQL Upgrade”](#).
- If a client program receives the following error message when it tries to connect, it means that the server expects passwords in a newer format than the client is capable of generating:

```
shell> mysql
Client does not support authentication protocol requested
by server; consider upgrading MySQL client
```

For information on how to deal with this, see [Section 5.5.6.3, “Password Hashing in MySQL”](#), and [Section B.1.2.4, “Client does not support authentication protocol”](#).

- Remember that client programs use connection parameters specified in option files or environment variables. If a client program seems to be sending incorrect default connection parameters when you have not specified them on the command line, check any applicable option files and your environment. For example, if you get `Access denied` when you run a client without any options, make sure that you have not specified an old password in any of your option files!

You can suppress the use of option files by a client program by invoking it with the `--no-defaults` option. For example:

```
shell> mysqladmin --no-defaults -u root version
```

The option files that clients use are listed in [Section 4.2.3.2, “Using Option Files”](#). Environment variables are listed in [Section 2.14, “Environment Variables”](#).

- If you get the following error, it means that you are using an incorrect `root` password:

```
shell> mysqladmin -u root -pxxxx ver
Access denied for user 'root'@'localhost' (using password: YES)
```

If the preceding error occurs even when you have not specified a password, it means that you have an incorrect password listed in some option file. Try the `--no-defaults` option as described in the previous item.

For information on changing passwords, see [Section 5.5.5, “Assigning Account Passwords”](#).

If you have lost or forgotten the `root` password, see [Section B.1.4.1, “How to Reset the Root Password”](#).

- If you change a password by using `SET PASSWORD`, `INSERT`, or `UPDATE`, you must encrypt the password using the `PASSWORD()` function. If you do not use `PASSWORD()` for these statements, the password will not work. For example, the following statement assigns a password, but fails to encrypt it, so the user is not able to connect afterward:

```
SET PASSWORD FOR 'abe'@'host_name' = 'eagle';
```

Instead, set the password like this:



```
SET PASSWORD FOR 'abe'@'host_name' = PASSWORD('eagle');
```

The `PASSWORD()` function is unnecessary when you specify a password using the `CREATE USER` or `GRANT` statements or the `mysqladmin password` command. Each of those automatically uses `PASSWORD()` to encrypt the password. See [Section 5.5.5, “Assigning Account Passwords”](#), and [Section 12.5.1.1, “CREATE USER Syntax”](#).

- `localhost` is a synonym for your local host name, and is also the default host to which clients try to connect if you specify no host explicitly.

To avoid this problem on such systems, you can use a `--host=127.0.0.1` option to name the server host explicitly. This will make a TCP/IP connection to the local `mysqld` server. You can also use TCP/IP by specifying a `--host` option that uses the actual host name of the local host. In this case, the host name must be specified in a `user` table row on the server host, even though you are running the client program on the same host as the server.

- The `Access denied` error message tells you who you are trying to log in as, the client host from which you are trying to connect, and whether you were using a password. Normally, you should have one row in the `user` table that exactly matches the host name and user name that were given in the error message. For example, if you get an error message that contains `using password: NO`, it means that you tried to log in without a password.
- If you get an `Access denied` error when trying to connect to the database with `mysql -u user_name`, you may have a problem with the `user` table. Check this by executing `mysql -u root mysql` and issuing this SQL statement:

```
SELECT * FROM user;
```

The result should include a row with the `Host` and `User` columns matching your client's host name and your MySQL user name.

- If the following error occurs when you try to connect from a host other than the one on which the MySQL server is running, it means that there is no row in the `user` table with a `Host` value that matches the client host:

```
Host ... is not allowed to connect to this MySQL server
```

You can fix this by setting up an account for the combination of client host name and user name that you are using when trying to connect.

If you do not know the IP number or host name of the machine from which you are connecting, you should put a row with `'%'` as the `Host` column value in the `user` table. After trying to connect from the client machine, use a `SELECT USER()` query to see how you really did connect. Then change the `'%'` in the `user` table row to the actual host name that shows up in the log. Otherwise, your system is left insecure because it allows connections from any host for the given user name.

On Linux, another reason that this error might occur is that you are using a binary MySQL version that is compiled with a different version of the `glibc` library than the one you are using. In this case, you should either upgrade your operating system or `glibc`, or download a source distribution of MySQL version and compile it yourself. A source RPM is normally trivial to compile and install, so this is not a big problem.

- If you specify a host name when trying to connect, but get an error message where the host name is not shown or is an IP number, it means that the MySQL server got an error when trying to resolve the IP number of the client host to a name:

```
shell> mysqladmin -u root -pxxxx -h some_hostname ver
Access denied for user 'root'@'' (using password: YES)
```

If you try to connect as `root` and get the following error, it means that you do not have a row in the `user` table with a `User` column value of `'root'` and that `mysqld` cannot resolve the host name for your client:

```
Access denied for user ''@'unknown'
```

These errors indicate a DNS problem. To fix it, execute `mysqladmin flush-hosts` to reset the internal DNS host name cache. See [Section 7.5.11, “How MySQL Uses DNS”](#).

Some permanent solutions are:

- Determine what is wrong with your DNS server and fix it.
- Specify IP numbers rather than host names in the MySQL grant tables.
- Put an entry for the client machine name in `/etc/hosts` on Unix or `\windows\hosts` on Windows.
- Start `mysqld` with the `--skip-name-resolve` option.



- Start `mysqld` with the `--skip-host-cache` option.
- On Unix, if you are running the server and the client on the same machine, connect to `localhost`. Unix connections to `localhost` use a Unix socket file rather than TCP/IP.
- On Windows, if you are running the server and the client on the same machine and the server supports named pipe connections, connect to the host name `.` (period). Connections to `.` use a named pipe rather than TCP/IP.
- If `mysql -u root test` works but `mysql -h your_hostname -u root test` results in `Access denied` (where `your_hostname` is the actual host name of the local host), you may not have the correct name for your host in the `user` table. A common problem here is that the `Host` value in the `user` table row specifies an unqualified host name, but your system's name resolution routines return a fully qualified domain name (or vice versa). For example, if you have an entry with host `'pluto'` in the `user` table, but your DNS tells MySQL that your host name is `'pluto.example.com'`, the entry does not work. Try adding an entry to the `user` table that contains the IP number of your host as the `Host` column value. (Alternatively, you could add an entry to the `user` table with a `Host` value that contains a wildcard; for example, `'pluto.%'`. However, use of `Host` values ending with “%” is *insecure* and is *not* recommended!)
- If `mysql -u user_name test` works but `mysql -u user_name other_db` does not, you have not granted access to the given user for the database named `other_db`.
- If `mysql -u user_name` works when executed on the server host, but `mysql -h host_name -u user_name` does not work when executed on a remote client host, you have not enabled access to the server for the given user name from the remote host.
- If you cannot figure out why you get `Access denied`, remove from the `user` table all entries that have `Host` values containing wildcards (entries that contain `'%'` or `'_'` characters). A very common error is to insert a new entry with `Host='%'` and `User='some_user'`, thinking that this allows you to specify `localhost` to connect from the same machine. The reason that this does not work is that the default privileges include an entry with `Host='localhost'` and `User=''`. Because that entry has a `Host` value `'localhost'` that is more specific than `'%'`, it is used in preference to the new entry when connecting from `localhost`! The correct procedure is to insert a second entry with `Host='localhost'` and `User='some_user'`, or to delete the entry with `Host='localhost'` and `User=''`. After deleting the entry, remember to issue a `FLUSH PRIVILEGES` statement to reload the grant tables. See also [Section 5.4.4, “Access Control, Stage 1: Connection Verification”](#).
- If you are able to connect to the MySQL server, but get an `Access denied` message whenever you issue a `SELECT ... INTO OUTFILE` or `LOAD DATA INFILE` statement, your entry in the `user` table does not have the `FILE` privilege enabled.
- If you change the grant tables directly (for example, by using `INSERT`, `UPDATE`, or `DELETE` statements) and your changes seem to be ignored, remember that you must execute a `FLUSH PRIVILEGES` statement or a `mysqladmin flush-privileges` command to cause the server to reload the privilege tables. Otherwise, your changes have no effect until the next time the server is restarted. Remember that after you change the `root` password with an `UPDATE` command, you will not need to specify the new password until after you flush the privileges, because the server will not know you've changed the password yet!
- If your privileges seem to have changed in the middle of a session, it may be that a MySQL administrator has changed them. Reloading the grant tables affects new client connections, but it also affects existing connections as indicated in [Section 5.4.6, “When Privilege Changes Take Effect”](#).
- If you have access problems with a Perl, PHP, Python, or ODBC program, try to connect to the server with `mysql -u user_name db_name` or `mysql -u user_name -p your_pass db_name`. If you are able to connect using the `mysql` client, the problem lies with your program, not with the access privileges. (There is no space between `-p` and the password; you can also use the `--password=your_pass` syntax to specify the password. If you use the `-p` or `--password` option with no password value, MySQL prompts you for the password.)
- For testing purposes, start the `mysqld` server with the `--skip-grant-tables` option. Then you can change the MySQL grant tables and use the `mysqlaccess` script to check whether your modifications have the desired effect. When you are satisfied with your changes, execute `mysqladmin flush-privileges` to tell the `mysqld` server to reload the privileges. This enables you to begin using the new grant table contents without stopping and restarting the server.
- If you get the following error, you may have a problem with the `db` or `host` table:

```
Access to database denied
```

If the entry selected from the `db` table has an empty value in the `Host` column, make sure that there are one or more corresponding entries in the `host` table specifying which hosts the `db` table entry applies to. This problem occurs infrequently because the `host` table is rarely used.

- If everything else fails, start the `mysqld` server with a debugging option (for example, `--debug=d,general,query`).

This prints host and user information about attempted connections, as well as information about each command issued. See [MySQL Internals: Porting](#).

- If you have any other problems with the MySQL grant tables and feel you must post the problem to the mailing list, always provide a dump of the MySQL grant tables. You can dump the tables with the `mysqldump mysql` command. To file a bug report, see the instructions at [Section 1.6, “How to Report Bugs or Problems”](#). In some cases, you may need to restart `mysqld` with `--skip-grant-tables` to run `mysqldump`.

## 5.5. MySQL User Account Management

This section describes how to set up accounts for clients of your MySQL server. It discusses the following topics:

- The meaning of account names and passwords as used in MySQL and how that compares to names and passwords used by your operating system
- How to set up new accounts and remove existing accounts
- How to change passwords
- Guidelines for using passwords securely
- How to use secure connections with SSL

See also [Section 12.5.1, “Account Management Statements”](#), which describes the syntax and use for all user-management SQL statements.

### 5.5.1. User Names and Passwords

A MySQL account is defined in terms of a user name and the client host or hosts from which the user can connect to the server. The account also has a password. There are several distinctions between the way user names and passwords are used by MySQL and the way they are used by your operating system:

- User names, as used by MySQL for authentication purposes, have nothing to do with user names (login names) as used by Windows or Unix. On Unix, most MySQL clients by default try to log in using the current Unix user name as the MySQL user name, but that is for convenience only. The default can be overridden easily, because client programs allow any user name to be specified with a `-u` or `--user` option. Because this means that anyone can attempt to connect to the server using any user name, you cannot make a database secure in any way unless all MySQL accounts have passwords. Anyone who specifies a user name for an account that has no password is able to connect successfully to the server.
- MySQL user names can be up to 16 characters long. Operating system user names, because they are completely unrelated to MySQL user names, may be of a different maximum length. For example, Unix user names typically are limited to eight characters.

#### Warning

The limit on MySQL user name length is hard-coded in the MySQL servers and clients, and trying to circumvent it by modifying the definitions of the tables in the `mysql` database *does not work*.

You should never alter any of the tables in the `mysql` database in any manner whatsoever except by means of the procedure that is described in [Section 4.4.8, “mysql\\_upgrade — Check Tables for MySQL Upgrade”](#). Attempting to redefine MySQL's system tables in any other fashion results in undefined (and unsupported!) behavior.

- MySQL passwords have nothing to do with passwords for logging in to your operating system. There is no necessary connection between the password you use to log in to a Windows or Unix machine and the password you use to access the MySQL server on that machine.
- MySQL encrypts passwords using its own algorithm. This encryption is the same as that implemented by the `PASSWORD()` SQL function but differs from that used during the Unix login process. Unix password encryption is the same as that implemented by the `ENCRYPT()` SQL function. See the descriptions of the `PASSWORD()` and `ENCRYPT()` functions in [Section 11.11.2, “Encryption and Compression Functions”](#).

From version 4.1 on, MySQL employs a stronger authentication method that has better password protection during the connection process than in earlier versions. It is secure even if TCP/IP packets are sniffed or the `mysql` database is captured. (In earlier versions, even though passwords are stored in encrypted form in the `user` table, knowledge of the encrypted password value could be used to connect to the MySQL server.) [Section 5.5.6.3, “Password Hashing in MySQL”](#), discusses password encryption further.

When you install MySQL, the grant tables are populated with an initial set of accounts. These accounts have names and access privileges that are described in [Section 2.11.3, “Securing the Initial MySQL Accounts”](#), which also discusses how to assign passwords to them. Thereafter, you normally set up, modify, and remove MySQL accounts using statements such as `GRANT` and `REVOKE`. See [Section 12.5.1, “Account Management Statements”](#).

When you connect to a MySQL server with a command-line client, you should specify the user name and password for the account that you want to use:

```
shell> mysql --user=monty --password=guess db_name
```

If you prefer short options, the command looks like this:

```
shell> mysql -u monty -pguess db_name
```

There must be *no space* between the `-p` option and the following password value. For additional information about specifying user names, passwords, and other connection parameters, see [Section 4.2.2, “Connecting to the MySQL Server”](#).

## 5.5.2. Adding User Accounts

You can create MySQL accounts in two ways:

- By using statements intended for creating accounts, such as `CREATE USER` or `GRANT`. These statements cause the server to make appropriate modifications to the grant tables.
- By manipulating the MySQL grant tables directly with statements such as `INSERT`, `UPDATE`, or `DELETE`.

The preferred method is to use account-creation statements because they are more concise and less error-prone than manipulating the grant tables directly. `CREATE USER` and `GRANT` are described in [Section 12.5.1, “Account Management Statements”](#).

Another option for creating accounts is to use one of several available third-party programs that offer capabilities for MySQL account administration. `phpMyAdmin` is one such program.

The following examples show how to use the `mysql` client program to set up new accounts. These examples assume that privileges have been set up according to the defaults described in [Section 2.11.3, “Securing the Initial MySQL Accounts”](#). This means that to make changes, you must connect to the MySQL server as the MySQL `root` user, and the `root` account must have the `INSERT` privilege for the `mysql` database and the `RELOAD` administrative privilege.

As noted in the examples where appropriate, some of the statements will fail if the server's SQL mode has been set to enable certain restrictions. In particular, strict mode (`STRICT_TRANS_TABLES`, `STRICT_ALL_TABLES`) and `NO_AUTO_CREATE_USER` will prevent the server from accepting some of the statements. Workarounds are indicated for these cases. For more information about SQL modes and their effect on grant table manipulation, see [Section 5.1.7, “Server SQL Modes”](#), and [Section 12.5.1.3, “GRANT Syntax”](#).

First, use the `mysql` program to connect to the server as the MySQL `root` user:

```
shell> mysql --user=root mysql
```

If you have assigned a password to the `root` account, you'll also need to supply a `--password` or `-p` option, both for this `mysql` command and for those later in this section.

After connecting to the server as `root`, you can add new accounts. The following statements use `GRANT` to set up four new accounts:

```
mysql> CREATE USER 'monty'@'localhost' IDENTIFIED BY 'some_pass';
mysql> GRANT ALL PRIVILEGES ON *.* TO 'monty'@'localhost'
-> WITH GRANT OPTION;
mysql> CREATE USER 'monty'@'%' IDENTIFIED BY 'some_pass';
mysql> GRANT ALL PRIVILEGES ON *.* TO 'monty'@'%'
-> WITH GRANT OPTION;
mysql> CREATE USER 'admin'@'localhost';
mysql> GRANT RELOAD,PROCESS ON *.* TO 'admin'@'localhost';
mysql> CREATE USER 'dummy'@'localhost';
```

The accounts created by these statements have the following properties:

- Two of the accounts have a user name of `monty` and a password of `some_pass`. Both accounts are superuser accounts with full privileges to do anything. The `'monty'@'localhost'` account can be used only when connecting from the local host. The `'monty'@'%'` account uses the `'%'` wildcard for the host part, so it can be used to connect from any host.

It is necessary to have both accounts for `monty` to be able to connect from anywhere as `monty`. Without the `localhost` account, the anonymous-user account for `localhost` that is created by `mysql_install_db` would take precedence when `monty` connects from the local host. As a result, `monty` would be treated as an anonymous user. The reason for this is that the anonymous-user account has a more specific `Host` column value than the `'monty'@'%'` account and thus comes earlier in the `user` table sort order. (`user` table sorting is discussed in Section 5.4.4, “Access Control, Stage 1: Connection Verification”.)

- The `'admin'@'localhost'` account has no password. This account can be used only by `admin` to connect from the local host. It is granted the `RELOAD` and `PROCESS` administrative privileges. These privileges allow the `admin` user to execute the `mysqladmin reload`, `mysqladmin refresh`, and `mysqladmin flush-xxx` commands, as well as `mysqladmin processlist`. No privileges are granted for accessing any databases. You could add such privileges later by issuing additional `GRANT` statements.
- The `'dummy'@'localhost'` account has no password. This account can be used only to connect from the local host. No privileges are granted. It is assumed that you will grant specific privileges to the account later.

The statements that create accounts with no password will fail if the `NO_AUTO_CREATE_USER` SQL mode is enabled. To deal with this, use an `IDENTIFIED BY` clause that specifies a non-empty password.

To check the privileges for an account, use `SHOW GRANTS`:

```
mysql> SHOW GRANTS FOR 'admin'@'localhost';
+-----+
| Grants for admin@localhost |
+-----+
| GRANT RELOAD, PROCESS ON *.* TO 'admin'@'localhost' |
+-----+
```

As an alternative to `CREATE USER` and `GRANT`, you can create the same accounts directly by issuing `INSERT` statements and then telling the server to reload the grant tables using `FLUSH PRIVILEGES`:

```
shell> mysql --user=root mysql
mysql> INSERT INTO user
-> VALUES('localhost','monty',PASSWORD('some_pass')),
-> 'Y','Y','Y','Y','Y','Y','Y','Y','Y','Y','Y','Y','Y','Y');
mysql> INSERT INTO user
-> VALUES('%','monty',PASSWORD('some_pass')),
-> 'Y','Y','Y','Y','Y','Y','Y','Y','Y','Y','Y','Y','Y','Y',
-> 'Y','Y','Y','Y','Y','Y','Y','Y','Y','Y','Y','Y','Y','Y',
-> '','','','','0,0,0,0');
mysql> INSERT INTO user SET Host='localhost',User='admin',
-> Reload_priv='Y', Process_priv='Y';
mysql> INSERT INTO user (Host,User>Password)
-> VALUES('localhost','dummy','');
mysql> FLUSH PRIVILEGES;
```

When you create accounts with `INSERT`, it is necessary to use `FLUSH PRIVILEGES` to tell the server to reload the grant tables. Otherwise, the changes go unnoticed until you restart the server. With `CREATE USER`, `FLUSH PRIVILEGES` is unnecessary.

The reason for using the `PASSWORD()` function with `INSERT` is to encrypt the password. The `CREATE USER` statement encrypts the password for you, so `PASSWORD()` is unnecessary.

The `'Y'` values enable privileges for the accounts. Depending on your MySQL version, you may have to use a different number of `'Y'` values in the first two `INSERT` statements. The `INSERT` statement for the `admin` account employs the more readable extended `INSERT` syntax using `SET`.

In the `INSERT` statement for the `dummy` account, only the `Host`, `User`, and `Password` columns in the `user` table row are assigned values. None of the privilege columns are set explicitly, so MySQL assigns them all the default value of `'N'`. This is equivalent to what `CREATE USER` does.

If strict SQL mode is enabled, all columns that have no default value must have a value specified. In this case, `INSERT` statements must explicitly specify values for the `ssl_cipher`, `x509_issuer`, and `x509_subject` columns.

To set up a superuser account, it is necessary only to create a `user` table entry with the privilege columns set to `'Y'`. The `user` table privileges are global, so no entries in any of the other grant tables are needed.

The next examples create three accounts and give them access to specific databases. Each of them has a user name of `custom` and password of `obscure`.

To create the accounts with `CREATE USER` and `GRANT`, use the following statements:

```
shell> mysql --user=root mysql
mysql> CREATE USER 'custom'@'localhost' IDENTIFIED BY 'obscure';
mysql> GRANT SELECT,INSERT,UPDATE,DELETE,CREATE,DROP
```

```

-> ON bankaccount.*
-> TO 'custom'@'localhost';
mysql> CREATE USER 'custom'@'host47.example.com' IDENTIFIED BY 'obscure';
mysql> GRANT SELECT,INSERT,UPDATE,DELETE,CREATE,DROP
-> ON expenses.*
-> TO 'custom'@'host47.example.com';
mysql> CREATE USER 'custom'@'server.domain' IDENTIFIED BY 'obscure';
mysql> GRANT SELECT,INSERT,UPDATE,DELETE,CREATE,DROP
-> ON customer.*
-> TO 'custom'@'server.domain';

```

The three accounts can be used as follows:

- The first account can access the `bankaccount` database, but only from the local host.
- The second account can access the `expenses` database, but only from the host `host47.example.com`.
- The third account can access the `customer` database, but only from the host `server.domain`.

To set up the `custom` accounts without `GRANT`, use `INSERT` statements as follows to modify the grant tables directly:

```

shell> mysql --user=root mysql
mysql> INSERT INTO user (Host,User,Password)
-> VALUES('localhost','custom',PASSWORD('obscure'));
mysql> INSERT INTO user (Host,User,Password)
-> VALUES('host47.example.com','custom',PASSWORD('obscure'));
mysql> INSERT INTO user (Host,User,Password)
-> VALUES('server.domain','custom',PASSWORD('obscure'));
mysql> INSERT INTO db
-> (Host,Db,User,Select_priv,Insert_priv,
-> Update_priv,Delete_priv,Create_priv,Drop_priv)
-> VALUES('localhost','bankaccount','custom',
-> 'Y','Y','Y','Y','Y','Y');
mysql> INSERT INTO db
-> (Host,Db,User,Select_priv,Insert_priv,
-> Update_priv,Delete_priv,Create_priv,Drop_priv)
-> VALUES('host47.example.com','expenses','custom',
-> 'Y','Y','Y','Y','Y','Y');
mysql> INSERT INTO db
-> (Host,Db,User,Select_priv,Insert_priv,
-> Update_priv,Delete_priv,Create_priv,Drop_priv)
-> VALUES('server.domain','customer','custom',
-> 'Y','Y','Y','Y','Y','Y');
mysql> FLUSH PRIVILEGES;

```

The first three `INSERT` statements add `user` table entries that allow the user `custom` to connect from the various hosts with the given password, but grant no global privileges (all privileges are set to the default value of 'N'). The next three `INSERT` statements add `db` table entries that grant privileges to `custom` for the `bankaccount`, `expenses`, and `customer` databases, but only when accessed from the proper hosts. As usual when you modify the grant tables directly, you must tell the server to reload them with `FLUSH PRIVILEGES` so that the privilege changes take effect.

To create a user who has access from all machines in a given domain (for example, `mydomain.com`), you can use the “%” wildcard character in the host part of the account name:

```
mysql> CREATE USER 'myname'@'%mydomain.com' IDENTIFIED BY 'mypass';
```

To do the same thing by modifying the grant tables directly, do this:

```
mysql> INSERT INTO user (Host,User,Password,...)
-> VALUES('%mydomain.com','myname',PASSWORD('mypass'),...);
mysql> FLUSH PRIVILEGES;
```

### 5.5.3. Removing User Accounts

To remove an account, use the `DROP USER` statement, which is described in [Section 12.5.1.2, “DROP USER Syntax”](#).

### 5.5.4. Limiting Account Resources

One means of limiting use of MySQL server resources is to set the `max_user_connections` system variable to a nonzero value. However, this limits only the number of simultaneous connections made using a single account, and not what a client can do once connected. In addition, this method is strictly global, and does not allow for management of individual accounts. Both types of control are of interest to many MySQL administrators, particularly those working for Internet Service Providers.

In MySQL 5.1, you can limit the following server resources for individual accounts:

- The number of queries that an account can issue per hour
- The number of updates that an account can issue per hour
- The number of times an account can connect to the server per hour
- The number of simultaneous connections to the server an account can have

Any statement that a client can issue counts against the query limit. Only statements that modify databases or tables count against the update limit.

An “account” in this context corresponds to a single row in the `user` table. That is, connections are assessed against the `User` and `Host` values in the `user` table row that applies to the connection. Suppose that there is a row in the `user` table that has `User` and `Host` values of `usera` and `% .example.com`, to allow `usera` to connect from any host in the `example.com` domain. In this case, the server applies resource limits collectively to all connections by `usera` from any host in the `example.com` domain because all such connections use the same account.

Before MySQL 5.0.3, an “account” was assessed against the actual host from which a user connects. This older method accounting may be selected by starting the server with the `--old-style-user-limits` option. In this case, if `usera` connects simultaneously from `host1.example.com` and `host2.example.com`, the server applies the account resource limits separately to each connection. If `usera` connects again from `host1.example.com`, the server applies the limits for that connection together with the existing connection from that host.

The server limits account resources based on the resource-related columns of the `user` table in the `mysql` database: `max_questions`, `max_updates`, `max_connections`, and `max_user_connections`. If your `user` table does not have these columns, it must be upgraded; see [Section 4.4.8, “mysql\\_upgrade — Check Tables for MySQL Upgrade”](#).

To set resource limits, use the `GRANT` statement and provide a `WITH` clause that names each resource to be limited. For example, to create a new account that can access the `customer` database, but only in a limited fashion, issue these statements:

```
mysql> CREATE USER 'francis'@'localhost' IDENTIFIED BY 'frank';
mysql> GRANT ALL ON customer.* TO 'francis'@'localhost'
-> WITH MAX_QUERIES_PER_HOUR 20
-> MAX_UPDATES_PER_HOUR 10
-> MAX_CONNECTIONS_PER_HOUR 5
-> MAX_USER_CONNECTIONS 2;
```

The limit types need not all be named in the `WITH` clause, but those named can be present in any order. The value for each per-hour limit should be an integer representing a count per hour. If the `GRANT` statement has no `WITH` clause, the limits are each set to the default value of zero (that is, no limit). For `MAX_USER_CONNECTIONS`, the limit is an integer representing the maximum number of simultaneous connections the account can make at any one time. If the limit is set to the default value of zero, the `max_user_connections` system variable determines the number of simultaneous connections for the account.

To modify limits for an existing account, use a `GRANT USAGE` statement at the global level (`ON *.*`). The following statement changes the query limit for `francis` to 100:

```
mysql> GRANT USAGE ON *.* TO 'francis'@'localhost'
-> WITH MAX_QUERIES_PER_HOUR 100;
```

This statement leaves the account's existing privileges unchanged and modifies only the limit values specified.

To remove an existing limit, set its value to zero. For example, to remove the limit on how many times per hour `francis` can connect, use this statement:

```
mysql> GRANT USAGE ON *.* TO 'francis'@'localhost'
-> WITH MAX_CONNECTIONS_PER_HOUR 0;
```

Resource-use counting takes place when any account has a nonzero limit placed on its use of any of the resources.

As the server runs, it counts the number of times each account uses resources. If an account reaches its limit on number of connections within the last hour, further connections for the account are rejected until that hour is up. Similarly, if the account reaches its limit on the number of queries or updates, further queries or updates are rejected until the hour is up. In all such cases, an appropriate error message is issued.

Resource counting is done per account, not per client. For example, if your account has a query limit of 50, you cannot increase your limit to 100 by making two simultaneous client connections to the server. Queries issued on both connections are counted together.

Queries for which results are served from the query cache do not count against the `MAX_QUERIES_PER_HOUR` limit.



The current per-hour resource-use counts can be reset globally for all accounts, or individually for a given account:

- To reset the current counts to zero for all accounts, issue a `FLUSH USER_RESOURCES` statement. The counts also can be reset by reloading the grant tables (for example, with a `FLUSH PRIVILEGES` statement or a `mysqladmin reload` command).
- The counts for an individual account can be set to zero by re-granting it any of its limits. To do this, use `GRANT USAGE` as described earlier and specify a limit value equal to the value that the account currently has.

Counter resets do not affect the `MAX_USER_CONNECTIONS` limit.

All counts begin at zero when the server starts; counts are not carried over through a restart.

For the `MAX_USER_CONNECTIONS` limit, an edge case can occur if the account currently has open the maximum number of connections allowed to it: A disconnect followed quickly by a connect can result in an error (`ER_TOO_MANY_USER_CONNECTIONS` or `ER_USER_LIMIT_REACHED`) if the server has not fully processed the disconnect by the time the connect occurs. When the server finishes disconnect processing, another connection will once more be allowed.

## 5.5.5. Assigning Account Passwords

To assign a password when you create a new account with `CREATE USER`, include an `IDENTIFIED BY` clause:

```
mysql> CREATE USER 'jeffrey'@'localhost' IDENTIFIED BY 'biscuit';
```

To assign or change a password for an existing account, one way is to issue a `SET PASSWORD` statement:

```
mysql> SET PASSWORD FOR 'jeffrey'@'localhost' = PASSWORD('biscuit');
```

Only users such as `root` that have update access to the `mysql` database can change the password for other users. If you are not connected as an anonymous user, you can change your own password by omitting the `FOR` clause:

```
mysql> SET PASSWORD = PASSWORD('biscuit');
```

You can also use a `GRANT USAGE` statement at the global level (`ON *.*`) to assign a password to an account without affecting the account's current privileges:

```
mysql> GRANT USAGE ON *.* TO 'jeffrey'@'localhost' IDENTIFIED BY 'biscuit';
```

Passwords can be assigned from the command line by using the `mysqladmin` command:

```
shell> mysqladmin -u user_name -h host_name password "newpwd"
```

The account for which this command resets the password is the one with a `user` table row that matches `user_name` in the `User` column and the client host from which you connect in the `Host` column.

Although it is generally preferable to assign passwords using one of the preceding methods, you can also do so by modifying the `user` table directly:

- To establish a password when creating a new account, provide a value for the `Password` column:

```
shell> mysql -u root mysql
mysql> INSERT INTO user (Host,User>Password)
-> VALUES ('localhost','jeffrey',PASSWORD('biscuit'));
mysql> FLUSH PRIVILEGES;
```

- To change the password for an existing account, use `UPDATE` to set the `Password` column value:

```
shell> mysql -u root mysql
mysql> UPDATE user SET Password = PASSWORD('bagel')
-> WHERE Host = 'localhost' AND User = 'francis';
mysql> FLUSH PRIVILEGES;
```

When you assign passwords using `CREATE USER` or `GRANT` with an `IDENTIFIED BY` clause or with the `mysqladmin password` command, they take care of encrypting the password for you.

When you assign an account a non-empty password using `SET PASSWORD`, `INSERT`, or `UPDATE`, you must use the `PASSWORD()` function to encrypt the password. `PASSWORD()` is necessary because the `user` table stores passwords in encrypted form, not as plaintext. If you forget that fact, you are likely to set passwords like this:

```
shell> mysql -u root mysql
mysql> INSERT INTO user (Host,User,Password)
-> VALUES ('localhost','jeffrey','biscuit');
mysql> FLUSH PRIVILEGES;
```

The result is that the literal value `'biscuit'` is stored as the password in the `user` table, not the encrypted value. When `jeffrey` attempts to connect to the server using this password, the value is encrypted and compared to the value stored in the `user` table. However, the stored value is the literal string `'biscuit'`, so the comparison fails and the server rejects the connection:

```
shell> mysql -u jeffrey -pbiscuit test
Access denied
```

### Note

`PASSWORD()` encryption differs from Unix password encryption. See [Section 5.5.1, “User Names and Passwords”](#).

## 5.5.6. Password Security in MySQL

Passwords occur in several contexts within MySQL. The following sections provide guidelines that enable administrators and end users to keep these passwords secure and avoid exposing them. There is also a discussion of how MySQL uses password hashing internally.

### 5.5.6.1. Administrator Guidelines for Password Security

Database administrators should use the following guidelines to keep passwords secure.

MySQL stores passwords for user accounts in the `mysql.user` table. Access to this table should never be granted to any non-administrative accounts.

Passwords can appear as plain text in SQL statements such as `CREATE USER`, `GRANT`, and `SET PASSWORD`. If these statements are logged by the MySQL server, the passwords become available to anyone with access to the logs. This applies to the general query log, the slow query log, and the binary log (see [Section 5.2, “MySQL Server Logs”](#)). To guard against unwarranted exposure to log files, they should be located in a directory that restricts access to only the server and the database administrator. If you log to tables in the `mysql` database, access to the tables should never be granted to any non-administrative accounts.

Database backups that include tables or log files containing passwords should be protected using a restricted access mode.

### 5.5.6.2. End-User Guidelines for Password Security

MySQL users should use the following guidelines to keep passwords secure.

When you run a client program to connect to the MySQL server, it is inadvisable to specify your password in a way that exposes it to discovery by other users. The methods you can use to specify your password when you run client programs are listed here, along with an assessment of the risks of each method. In short, the safest methods are to have the client program prompt for the password or to specify the password in a properly protected option file.

- Use a `-p` or `--password=your_pass` option on the command line. For example:

```
shell> mysql -u francis -pfrank db_name
```

This is convenient *but insecure*, because your password becomes visible to system status programs such as `ps` that may be invoked by other users to display command lines. MySQL clients typically overwrite the command-line password argument with zeros during their initialization sequence. However, there is still a brief interval during which the value is visible. Also, on some systems this overwriting strategy is ineffective and the password remains visible to `ps`. (SystemV Unix systems and perhaps others are subject to this problem.)

If your operating environment is set up to display your current command in the title bar of your terminal window, the password remains visible as long as the command is running, even if the command has scrolled out of view in the window content area.

- Use the `-p` or `--password` option on the command line with no password value specified. In this case, the client program solicits the password interactively:

```
shell> mysql -u francis -p db_name
Enter password: *****
```



The “\*” characters indicate where you enter your password. The password is not displayed as you enter it.

It is more secure to enter your password this way than to specify it on the command line because it is not visible to other users. However, this method of entering a password is suitable only for programs that you run interactively. If you want to invoke a client from a script that runs non-interactively, there is no opportunity to enter the password from the keyboard. On some systems, you may even find that the first line of your script is read and interpreted (incorrectly) as your password.

- Store your password in an option file. For example, on Unix you can list your password in the `[client]` section of the `.my.cnf` file in your home directory:

```
[client]
password=your_pass
```

To keep the password safe, the file should not be accessible to anyone but yourself. To ensure this, set the file access mode to 400 or 600. For example:

```
shell> chmod 600 .my.cnf
```

Section 4.2.3.2, “Using Option Files”, discusses option files in more detail.

- Store your password in the `MYSQL_PWD` environment variable. See Section 2.14, “Environment Variables”.

This method of specifying your MySQL password must be considered *extremely insecure* and should not be used. Some versions of `ps` include an option to display the environment of running processes. If you set `MYSQL_PWD`, your password is exposed to any other user who runs `ps`. Even on systems without such a version of `ps`, it is unwise to assume that there are no other methods by which users can examine process environments.

On Unix, the `mysql` client writes a record of executed statements to a history file (see Section 4.5.1, “`mysql` — The MySQL Command-Line Tool”). By default, this file is named `.mysql_history` and is created in your home directory. Passwords can appear as plain text in SQL statements such as `CREATE USER`, `GRANT`, and `SET PASSWORD`, so if you use these statements, they are logged in the history file. To keep this file safe, use a restrictive access mode, the same way as described earlier for the `.my.cnf` file.

### 5.5.6.3. Password Hashing in MySQL

MySQL user accounts are listed in the `user` table of the `mysql` database. Each MySQL account is assigned a password, although what is stored in the `Password` column of the `user` table is not the plaintext version of the password, but a hash value computed from it. Password hash values are computed by the `PASSWORD()` function.

MySQL uses passwords in two phases of client/server communication:

- When a client attempts to connect to the server, there is an initial authentication step in which the client must present a password that has a hash value matching the hash value stored in the `user` table for the account that the client wants to use.
- After the client connects, it can (if it has sufficient privileges) set or change the password hashes for accounts listed in the `user` table. The client can do this by using the `PASSWORD()` function to generate a password hash, or by using the `GRANT` or `SET PASSWORD` statements.

In other words, the server *uses* hash values during authentication when a client first attempts to connect. The server *generates* hash values if a connected client invokes the `PASSWORD()` function or uses a `GRANT` or `SET PASSWORD` statement to set or change a password.

The password hashing mechanism was updated in MySQL 4.1 to provide better security and to reduce the risk of passwords being intercepted. However, this new mechanism is understood only by MySQL 4.1 (and newer) servers and clients, which can result in some compatibility problems. A 4.1 or newer client can connect to a pre-4.1 server, because the client understands both the old and new password hashing mechanisms. However, a pre-4.1 client that attempts to connect to a 4.1 or newer server may run into difficulties. For example, a 3.23 `mysql` client that attempts to connect to a 5.1 server may fail with the following error message:

```
shell> mysql -h localhost -u root
Client does not support authentication protocol requested
by server; consider upgrading MySQL client
```

Another common example of this phenomenon occurs for attempts to use the older PHP `mysql` extension after upgrading to MySQL 4.1 or newer. (See Section 20.11.5, “Common Problems with MySQL and PHP”.)

The following discussion describes the differences between the old and new password mechanisms, and what you should do if you

upgrade your server but need to maintain backward compatibility with pre-4.1 clients. Additional information can be found in [Section B.1.2.4, “Client does not support authentication protocol”](#). This information is of particular importance to PHP programmers migrating MySQL databases from version 4.0 or lower to version 4.1 or higher.

### Note

This discussion contrasts 4.1 behavior with pre-4.1 behavior, but the 4.1 behavior described here actually begins with 4.1.1. MySQL 4.1.0 is an “odd” release because it has a slightly different mechanism than that implemented in 4.1.1 and up. Differences between 4.1.0 and more recent versions are described further in [MySQL 5.0 Reference Manual](#).

Prior to MySQL 4.1, password hashes computed by the `PASSWORD()` function are 16 bytes long. Such hashes look like this:

```
mysql> SELECT PASSWORD('mypass');
+-----+
| PASSWORD('mypass') |
+-----+
| 6f8c114b58f2ce9e   |
+-----+
```

The `Password` column of the `user` table (in which these hashes are stored) also is 16 bytes long before MySQL 4.1.

As of MySQL 4.1, the `PASSWORD()` function has been modified to produce a longer 41-byte hash value:

```
mysql> SELECT PASSWORD('mypass');
+-----+
| PASSWORD('mypass') |
+-----+
| *6C8989366EAF75BB670AD8EA7A7FC1176A95CEF4 |
+-----+
```

Accordingly, the `Password` column in the `user` table also must be 41 bytes long to store these values:

- If you perform a new installation of MySQL 5.1, the `Password` column is made 41 bytes long automatically.
- Upgrading from MySQL 4.1 (4.1.1 or later in the 4.1 series) to MySQL 5.1 should not give rise to any issues in this regard because both versions use the same password hashing mechanism. If you wish to upgrade an older release of MySQL to version 5.1, you should upgrade to version 4.1 first, then upgrade the 4.1 installation to 5.1.

A widened `Password` column can store password hashes in both the old and new formats. The format of any given password hash value can be determined two ways:

- The obvious difference is the length (16 bytes versus 41 bytes).
- A second difference is that password hashes in the new format always begin with a “\*” character, whereas passwords in the old format never do.

The longer password hash format has better cryptographic properties, and client authentication based on long hashes is more secure than that based on the older short hashes.

The differences between short and long password hashes are relevant both for how the server uses passwords during authentication and for how it generates password hashes for connected clients that perform password-changing operations.

The way in which the server uses password hashes during authentication is affected by the width of the `Password` column:

- If the column is short, only short-hash authentication is used.
- If the column is long, it can hold either short or long hashes, and the server can use either format:
  - Pre-4.1 clients can connect, although because they know only about the old hashing mechanism, they can authenticate only using accounts that have short hashes.
  - 4.1 and later clients can authenticate using accounts that have short or long hashes.

Even for short-hash accounts, the authentication process is actually a bit more secure for 4.1 and later clients than for older clients. In terms of security, the gradient from least to most secure is:

- Pre-4.1 client authenticating with short password hash
- 4.1 or later client authenticating with short password hash
- 4.1 or later client authenticating with long password hash

The way in which the server generates password hashes for connected clients is affected by the width of the `Password` column and by the `--old-passwords` option. A 4.1 or later server generates long hashes only if certain conditions are met: The `Password` column must be wide enough to hold long values and the `--old-passwords` option must not be given. These conditions apply as follows:

- The `Password` column must be wide enough to hold long hashes (41 bytes). If the column has not been updated and still has the pre-4.1 width of 16 bytes, the server notices that long hashes cannot fit into it and generates only short hashes when a client performs password-changing operations using `PASSWORD()`, `GRANT`, or `SET PASSWORD`. This is the behavior that occurs if you have upgraded to 4.1 but have not yet run the `mysql_upgrade` program to widen the `Password` column.
- If the `Password` column is wide, it can store either short or long password hashes. In this case, `PASSWORD()`, `GRANT`, and `SET PASSWORD` generate long hashes unless the server was started with the `--old-passwords` option. That option forces the server to generate short password hashes instead.

The purpose of the `--old-passwords` option is to enable you to maintain backward compatibility with pre-4.1 clients under circumstances where the server would otherwise generate long password hashes. The option doesn't affect authentication (4.1 and later clients can still use accounts that have long password hashes), but it does prevent creation of a long password hash in the `user` table as the result of a password-changing operation. Were that to occur, the account no longer could be used by pre-4.1 clients. Without the `--old-passwords` option, the following undesirable scenario is possible:

- An old client connects to an account that has a short password hash.
- The client changes its own password. Without `--old-passwords`, this results in the account having a long password hash.
- The next time the old client attempts to connect to the account, it cannot, because the account has a long password hash that requires the new hashing mechanism during authentication. (Once an account has a long password hash in the user table, only 4.1 and later clients can authenticate for it, because pre-4.1 clients do not understand long hashes.)

This scenario illustrates that, if you must support older pre-4.1 clients, it is dangerous to run a 4.1 or newer server without using the `--old-passwords` option. By running the server with `--old-passwords`, password-changing operations do not generate long password hashes and thus do not cause accounts to become inaccessible to older clients. (Those clients cannot inadvertently lock themselves out by changing their password and ending up with a long password hash.)

The downside of the `--old-passwords` option is that any passwords you create or change use short hashes, even for 4.1 clients. Thus, you lose the additional security provided by long password hashes. If you want to create an account that has a long hash (for example, for use by 4.1 clients), you must do so while running the server without `--old-passwords`.

#### MySQL Enterprise

Subscribers to the MySQL Enterprise Monitor are automatically alerted whenever a server is running with the `--old-passwords` option. For more information, see <http://www.mysql.com/products/enterprise/advisors.html>.

The following scenarios are possible for running a 4.1 or later server:

#### Scenario 1: Short `Password` column in user table:

- Only short hashes can be stored in the `Password` column.
- The server uses only short hashes during client authentication.
- For connected clients, password hash-generating operations involving `PASSWORD()`, `GRANT`, or `SET PASSWORD` use short hashes exclusively. Any change to an account's password results in that account having a short password hash.
- The `--old-passwords` option can be used but is superfluous because with a short `Password` column, the server generates only short password hashes anyway.

#### Scenario 2: Long `Password` column; server not started with `--old-passwords` option:

- Short or long hashes can be stored in the `Password` column.
- 4.1 and later clients can authenticate using accounts that have short or long hashes.
- Pre-4.1 clients can authenticate only using accounts that have short hashes.
- For connected clients, password hash-generating operations involving `PASSWORD()`, `GRANT`, or `SET PASSWORD` use long hashes exclusively. A change to an account's password results in that account having a long password hash.

As indicated earlier, a danger in this scenario is that it is possible for accounts that have a short password hash to become inaccessible to pre-4.1 clients. A change to such an account's password made via `GRANT`, `PASSWORD()`, or `SET PASSWORD` results in the account being given a long password hash. From that point on, no pre-4.1 client can authenticate to that account until the client upgrades to 4.1.

To deal with this problem, you can change a password in a special way. For example, normally you use `SET PASSWORD` as follows to change an account password:

```
SET PASSWORD FOR 'some_user'@'some_host' = PASSWORD('mypass');
```

To change the password but create a short hash, use the `OLD_PASSWORD()` function instead:

```
SET PASSWORD FOR 'some_user'@'some_host' = OLD_PASSWORD('mypass');
```

`OLD_PASSWORD()` is useful for situations in which you explicitly want to generate a short hash.

**Scenario 3:** Long `Password` column; 4.1 or newer server started with `--old-passwords` option:

- Short or long hashes can be stored in the `Password` column.
- 4.1 and later clients can authenticate for accounts that have short or long hashes (but note that it is possible to create long hashes only when the server is started without `--old-passwords`).
- Pre-4.1 clients can authenticate only for accounts that have short hashes.
- For connected clients, password hash-generating operations involving `PASSWORD()`, `GRANT`, or `SET PASSWORD` use short hashes exclusively. Any change to an account's password results in that account having a short password hash.

In this scenario, you cannot create accounts that have long password hashes, because the `--old-passwords` option prevents generation of long hashes. Also, if you create an account with a long hash before using the `--old-passwords` option, changing the account's password while `--old-passwords` is in effect results in the account being given a short password, causing it to lose the security benefits of a longer hash.

The disadvantages for these scenarios may be summarized as follows:

In scenario 1, you cannot take advantage of longer hashes that provide more secure authentication.

In scenario 2, accounts with short hashes become inaccessible to pre-4.1 clients if you change their passwords without explicitly using `OLD_PASSWORD()`.

In scenario 3, `--old-passwords` prevents accounts with short hashes from becoming inaccessible, but password-changing operations cause accounts with long hashes to revert to short hashes, and you cannot change them back to long hashes while `--old-passwords` is in effect.

#### 5.5.6.4. Implications of Password Hashing Changes in MySQL 4.1 for Application Programs

An upgrade to MySQL version 4.1 or later can cause compatibility issues for applications that use `PASSWORD()` to generate passwords for their own purposes. Applications really should not do this, because `PASSWORD()` should be used only to manage passwords for MySQL accounts. But some applications use `PASSWORD()` for their own purposes anyway.

If you upgrade to 4.1 or later from a pre-4.1 version of MySQL and run the server under conditions where it generates long password hashes, an application using `PASSWORD()` for its own passwords breaks. The recommended course of action in such cases is to modify the application to use another function, such as `SHA1()` or `MD5()`, to produce hashed values. If that is not possible, you can use the `OLD_PASSWORD()` function, which is provided for generate short hashes in the old format. However, you should note that `OLD_PASSWORD()` may one day no longer be supported.

If the server is running under circumstances where it generates short hashes, `OLD_PASSWORD()` is available but is equivalent to `PASSWORD()`.

PHP programmers migrating their MySQL databases from version 4.0 or lower to version 4.1 or higher should see [Section 20.11](#), “MySQL PHP API”.

## 5.5.7. Using SSL for Secure Connections

MySQL supports secure (encrypted) connections between MySQL clients and the server using the Secure Sockets Layer (SSL) protocol. This section discusses how to use SSL connections. For information on how to require users to use SSL connections, see the discussion of the `REQUIRE` clause of the `GRANT` statement in [Section 12.5.1.3](#), “`GRANT` Syntax”.

The standard configuration of MySQL is intended to be as fast as possible, so encrypted connections are not used by default. Doing so would make the client/server protocol much slower. Encrypting data is a CPU-intensive operation that requires the computer to do additional work and can delay other MySQL tasks. For applications that require the security provided by encrypted connections, the extra computation is warranted.

MySQL allows encryption to be enabled on a per-connection basis. You can choose a normal unencrypted connection or a secure encrypted SSL connection according the requirements of individual applications.

Secure connections are based on the OpenSSL API and are available through the MySQL C API. Replication uses the C API, so secure connections can be used between master and slave servers.

Another way to connect securely is from within an SSH connection to the MySQL server host. For an example, see [Section 5.5.8](#), “Connecting to MySQL Remotely from Windows with SSH”.

### 5.5.7.1. Basic SSL Concepts

To understand how MySQL uses SSL, it is necessary to explain some basic SSL and X509 concepts. People who are familiar with these can skip this part of the discussion.

By default, MySQL uses unencrypted connections between the client and the server. This means that someone with access to the network could watch all your traffic and look at the data being sent or received. They could even change the data while it is in transit between client and server. To improve security a little, you can compress client/server traffic by using the `--compress` option when invoking client programs. However, this does not foil a determined attacker.

When you need to move information over a network in a secure fashion, an unencrypted connection is unacceptable. Encryption is the way to make any kind of data unreadable. In fact, today's practice requires many additional security elements from encryption algorithms. They should resist many kind of known attacks such as changing the order of encrypted messages or replaying data twice.

SSL is a protocol that uses different encryption algorithms to ensure that data received over a public network can be trusted. It has mechanisms to detect any data change, loss, or replay. SSL also incorporates algorithms that provide identity verification using the X509 standard.

X509 makes it possible to identify someone on the Internet. It is most commonly used in e-commerce applications. In basic terms, there should be some company called a “Certificate Authority” (or CA) that assigns electronic certificates to anyone who needs them. Certificates rely on asymmetric encryption algorithms that have two encryption keys (a public key and a secret key). A certificate owner can show the certificate to another party as proof of identity. A certificate consists of its owner's public key. Any data encrypted with this public key can be decrypted only using the corresponding secret key, which is held by the owner of the certificate.

If you need more information about SSL, X509, or encryption, use your favorite Internet search engine to search for the keywords in which you are interested.

### 5.5.7.2. Using SSL Connections

To use SSL connections between the MySQL server and client programs, your system must support either OpenSSL or yaSSL and your version of MySQL must be built with SSL support.

To make it easier to use secure connections, MySQL is bundled with yaSSL. (MySQL and yaSSL employ the same licensing model, whereas OpenSSL uses an Apache-style license.) yaSSL support initially was available only for a few platforms, but now it is available on all MySQL platforms supported by Sun Microsystems, Inc.

To get secure connections to work with MySQL and SSL, you must do the following:

1. If you are not using a binary (precompiled) version of MySQL that has been built with SSL support, and you are going to use OpenSSL rather than the bundled yaSSL library, install OpenSSL if it has not already been installed. We have tested MySQL with OpenSSL 0.9.6. To obtain OpenSSL, visit <http://www.openssl.org>.
2. If you are not using a binary (precompiled) version of MySQL that has been built with SSL support, configure a MySQL

source distribution to use SSL. When you configure MySQL, invoke the `configure` script like this:

```
shell> ./configure --with-ssl
```

That configures the distribution to use the bundled yaSSL library. To use OpenSSL instead, specify the `--with-ssl` option with the path to the directory where the OpenSSL header files and libraries are located:

```
shell> ./configure --with-ssl=path
```

Before MySQL 5.1.11, you must use the appropriate option to select the SSL library that you want to use.

For yaSSL:

```
shell> ./configure --with-yassl
```

For OpenSSL:

```
shell> ./configure --with-openssl
```

Note that yaSSL support on Unix platforms requires that either `/dev/urandom` or `/dev/random` be available to retrieve true random numbers. For additional information (especially regarding yaSSL on Solaris versions prior to 2.8 and HP-UX), see [Bug#13164](#).

3. Make sure that the `user` in the `mysql` database includes the SSL-related columns (beginning with `ssl_` and `x509_`). If your `user` table does not have these columns, it must be upgraded; see [Section 4.4.8, “mysql\\_upgrade — Check Tables for MySQL Upgrade”](#).
4. To check whether a server binary is compiled with SSL support, invoke it with the `--ssl` option. An error will occur if the server does not support SSL:

```
shell> mysqld --ssl --help
060525 14:18:52 [ERROR] mysqld: unknown option '--ssl'
```

To check whether a running `mysqld` server supports SSL, examine the value of the `have_ssl` system variable (if you have no `have_ssl` variable, check for `have_openssl`):

```
mysql> SHOW VARIABLES LIKE 'have_ssl';
+-----+-----+
| Variable_name | Value |
+-----+-----+
| have_ssl      | YES   |
+-----+-----+
```

If the value is `YES`, the server supports SSL connections. If the value is `DISABLED`, the server supports SSL connections but was not started with the appropriate `--ssl-xxx` options (described later in this section).

To enable SSL connections, the proper SSL-related options must be used (see [Section 5.5.7.3, “SSL Command Options”](#)).

To start the MySQL server so that it allows clients to connect via SSL, use the options that identify the key and certificate files the server needs when establishing a secure connection:

```
shell> mysqld --ssl-ca=cacert.pem \
--ssl-cert=server-cert.pem \
--ssl-key=server-key.pem
```

- `--ssl-ca` identifies the Certificate Authority (CA) certificate.
- `--ssl-cert` identifies the server public key. This can be sent to the client and authenticated against the CA certificate that it has.
- `--ssl-key` identifies the server private key.

To establish a secure connection to a MySQL server with SSL support, the options that a client must specify depend on the SSL requirements of the user account that the client uses. (See the discussion of the `REQUIRE` clause in [Section 12.5.1.3, “GRANT Syntax”](#).)

If the account has no special SSL requirements or was created using a `GRANT` statement that includes the `REQUIRE SSL` option, a

client can connect securely by using just the `--ssl-ca` option:

```
shell> mysql --ssl-ca=cacert.pem
```

To require that a client certificate also be specified, create the account using the `REQUIRE X509` option. Then the client must also specify the proper client key and certificate files or the server will reject the connection:

```
shell> mysql --ssl-ca=cacert.pem \
--ssl-cert=client-cert.pem \
--ssl-key=client-key.pem
```

In other words, the options are similar to those used for the server. Note that the Certificate Authority certificate has to be the same.

A client can determine whether the current connection with the server uses SSL by checking the value of the `Ssl_cipher` status variable. The value of `Ssl_cipher` is non-empty if SSL is used, and empty otherwise. For example:

```
mysql> SHOW STATUS LIKE 'Ssl_cipher';
+-----+-----+
| Variable_name | Value |
+-----+-----+
| Ssl_cipher    | DHE-RSA-AES256-SHA |
+-----+-----+
```

For the `mysql` client, you can use the `STATUS` or `\s` command and check the `SSL` line:

```
mysql> \s
...
SSL:                Not in use
...
```

Or:

```
mysql> \s
...
SSL:                Cipher in use is DHE-RSA-AES256-SHA
...
```

To establish a secure connection from within an application program, use the `mysql_ssl_set()` C API function to set the appropriate certificate options before calling `mysql_real_connect()`. See [Section 20.10.3.67, “mysql\\_ssl\\_set\(\)”](#). After the connection is established, you can use `mysql_get_ssl_cipher()` to determine whether SSL is in use. A non-NULL return value indicates a secure connection and names the SSL cipher used for encryption. A NULL return value indicates that SSL is not being used. See [Section 20.10.3.33, “mysql\\_get\\_ssl\\_cipher\(\)”](#).

### 5.5.7.3. SSL Command Options

The following list describes options that are used for specifying the use of SSL, certificate files, and key files. They can be given on the command line or in an option file. These options are not available unless MySQL has been built with SSL support. See [Section 5.5.7.2, “Using SSL Connections”](#). (There are also `--master-ssl*` options that can be used for setting up a secure connection from a slave replication server to a master server; see [Section 16.1.3, “Replication and Binary Logging Options and Variables”](#).)

**Table 5.5. `mysqld` SSL Option/Variable Summary**

Name	Cmd-Line	Option file	System Var	Status Var	Var Scope	Dynamic
<a href="#">have_openssl</a>			Yes		Global	No
<a href="#">have_ssl</a>			Yes		Global	No
<a href="#">skip-ssl</a>	Yes	Yes				
<a href="#">ssl</a>	Yes	Yes				
<a href="#">ssl-ca</a>	Yes	Yes			Global	No
- Variable: <code>ssl_ca</code>			Yes		Global	No
<a href="#">ssl-capath</a>	Yes	Yes			Global	No
- Variable: <code>ssl_capath</code>			Yes		Global	No
<a href="#">ssl-cert</a>	Yes	Yes			Global	No
- Variable: <code>ssl_cert</code>			Yes		Global	No
<a href="#">ssl-cipher</a>	Yes	Yes			Global	No
- Variable: <code>ssl_cipher</code>			Yes		Global	No



Name	Cmd-Line	Option file	System Var	Status Var	Var Scope	Dynamic
<a href="#">ssl-key</a>	Yes	Yes			Global	No
- Variable: <code>ssl_key</code>			Yes		Global	No
<a href="#">ssl-verify-server-cert</a>	Yes	Yes				

- `--ssl`

For the server, this option specifies that the server allows SSL connections. For a client program, it allows the client to connect to the server using SSL. This option is not sufficient in itself to cause an SSL connection to be used. You must also specify the `--ssl-ca` option, and possibly the `--ssl-cert` and `--ssl-key` options.

This option is more often used in its opposite form to override any other SSL options and indicate that SSL should *not* be used. To do this, specify the option as `--skip-ssl` or `--ssl=0`.

Note that use of `--ssl` does not *require* an SSL connection. For example, if the server or client is compiled without SSL support, a normal unencrypted connection is used.

The secure way to require use of an SSL connection is to create an account on the server that includes a `REQUIRE SSL` clause in the `GRANT` statement. Then use that account to connect to the server, where both the server and the client have SSL support enabled.

The `REQUIRE` clause allows other SSL-related restrictions as well. The description of `REQUIRE` in [Section 12.5.1.3, “GRANT Syntax”](#), provides additional detail about which SSL command options may or must be specified by clients that connect using accounts that are created using the various `REQUIRE` options.

- `--ssl-ca=file_name`

The path to a file that contains a list of trusted SSL CAs.

- `--ssl-capath=directory_name`

The path to a directory that contains trusted SSL CA certificates in PEM format.

- `--ssl-cert=file_name`

The name of the SSL certificate file to use for establishing a secure connection.

- `--ssl-cipher=cipher_list`

A list of allowable ciphers to use for SSL encryption. For greatest portability, `cipher_list` should be a list of one or more cipher names, separated by colons. Examples:

```
--ssl-cipher=AES128-SHA
--ssl-cipher=DHE-RSA-AES256-SHA:AES128-SHA
```

This format is understood both by OpenSSL and yaSSL. OpenSSL supports a more flexible syntax for specifying ciphers, as described in the OpenSSL documentation at <http://www.openssl.org/docs/apps/ciphers.html>. However, this extended syntax will fail if used with a MySQL installation compiled against yaSSL.

If no cipher in the list is supported, SSL connections will not work.

- `--ssl-key=file_name`

The name of the SSL key file to use for establishing a secure connection.

- `--ssl-verify-server-cert`

This option is available for client programs only, not the server. It causes the server's Common Name value in the certificate that the server sends to the client to be verified against the host name that the client uses for connecting to the server, and the connection is rejected if there is a mismatch. This feature can be used to prevent man-in-the-middle attacks. Verification is disabled by default. This option was added in MySQL 5.1.11.

As of MySQL 5.1.18, if you use SSL when establishing a client connection, you can tell the client not to authenticate the server certificate by specifying neither `--ssl-ca` nor `--ssl-capath`. The server still verifies the client according to any applicable requirements established via `GRANT` statements for the client, and it still uses any `--ssl-ca/--ssl-capath` values that were passed to server at startup time.



### 5.5.7.4. Setting Up SSL Certificates for MySQL

This section demonstrates how to set up SSL certificate and key files for use by MySQL servers and clients. The first example shows a simplified procedure such as you might use from the command line. The second shows a script that contains more detail. The first two examples are intended for use on Unix and both use the `openssl` command that is part of OpenSSL. The third example describes how to set up SSL files on Windows.

Following the third example, instructions are given for using the files to test SSL connections. You can also use the files as described in [Section 5.5.7.2, “Using SSL Connections”](#).

#### Example 1: Creating SSL files from the command line on Unix

The following example shows a set of commands to create MySQL server and client certificate and key files. You will need to respond to several prompts by the `openssl` commands. For testing, you can press Enter to all prompts. For production use, you should provide non-empty responses.

```
# Create clean environment
shell> rm -rf newcerts
shell> mkdir newcerts && cd newcerts

# Create CA certificate
shell> openssl genrsa 2048 > ca-key.pem
shell> openssl req -new -x509 -nodes -days 1000 \
    -key ca-key.pem > ca-cert.pem

# Create server certificate
shell> openssl req -newkey rsa:2048 -days 1000 \
    -nodes -keyout server-key.pem > server-req.pem
shell> openssl x509 -req -in server-req.pem -days 1000 \
    -CA ca-cert.pem -CAkey ca-key.pem -set_serial 01 > server-cert.pem

# Create client certificate
shell> openssl req -newkey rsa:2048 -days 1000 \
    -nodes -keyout client-key.pem > client-req.pem
shell> openssl x509 -req -in client-req.pem -days 1000 \
    -CA ca-cert.pem -CAkey ca-key.pem -set_serial 01 > client-cert.pem
```

#### Example 2: Creating SSL files using a script on Unix

Here is an example script that shows how to set up SSL certificates for MySQL:

```
DIR=`pwd`/openssl
PRIV=$DIR/private

mkdir $DIR $PRIV $DIR/newcerts
cp /usr/share/ssl/openssl.cnf $DIR
replace ./demoCA $DIR -- $DIR/openssl.cnf

# Create necessary files: $database, $serial and $new_certs_dir
# directory (optional)

touch $DIR/index.txt
echo "01" > $DIR/serial

#
# Generation of Certificate Authority(CA)
#
openssl req -new -x509 -keyout $PRIV/cakey.pem -out $DIR/cacert.pem \
    -days 3600 -config $DIR/openssl.cnf

# Sample output:
# Using configuration from /home/monty/openssl/openssl.cnf
# Generating a 1024 bit RSA private key
# .....++++++
# .....++++++
# writing new private key to '/home/monty/openssl/private/cakey.pem'
# Enter PEM pass phrase:
# Verifying password - Enter PEM pass phrase:
# -----
# You are about to be asked to enter information that will be
# incorporated into your certificate request.
# What you are about to enter is what is called a Distinguished Name
# or a DN.
# There are quite a few fields but you can leave some blank
# For some fields there will be a default value,
# If you enter '.', the field will be left blank.
# -----
# Country Name (2 letter code) [AU]:FI
# State or Province Name (full name) [Some-State]:.
# Locality Name (eg, city) []:
# Organization Name (eg, company) [Internet Widgits Pty Ltd]:MySQL AB
# Organizational Unit Name (eg, section) []:
# Common Name (eg, YOUR name) []:MySQL admin
# Email Address []:

#
# Create server request and key
```

```

#
openssl req -new -keyout $DIR/server-key.pem -out \
    $DIR/server-req.pem -days 3600 -config $DIR/openssl.cnf

# Sample output:
# Using configuration from /home/monty/openssl/openssl.cnf
# Generating a 1024 bit RSA private key
# ..+++++
# .....+++++
# writing new private key to '/home/monty/openssl/server-key.pem'
# Enter PEM pass phrase:
# Verifying password - Enter PEM pass phrase:
# -----
# You are about to be asked to enter information that will be
# incorporated into your certificate request.
# What you are about to enter is what is called a Distinguished Name
# or a DN.
# There are quite a few fields but you can leave some blank
# For some fields there will be a default value,
# If you enter '.', the field will be left blank.
# -----
# Country Name (2 letter code) [AU]:FI
# State or Province Name (full name) [Some-State]:.
# Locality Name (eg, city) []:
# Organization Name (eg, company) [Internet Widgits Pty Ltd]:MySQL AB
# Organizational Unit Name (eg, section) []:
# Common Name (eg, YOUR name) []:MySQL server
# Email Address []:
#
# Please enter the following 'extra' attributes
# to be sent with your certificate request
# A challenge password []:
# An optional company name []:

#
# Remove the passphrase from the key
#
openssl rsa -in $DIR/server-key.pem -out $DIR/server-key.pem

#
# Sign server cert
#
openssl ca -policy policy_anything -out $DIR/server-cert.pem \
    -config $DIR/openssl.cnf -infile $DIR/server-req.pem

# Sample output:
# Using configuration from /home/monty/openssl/openssl.cnf
# Enter PEM pass phrase:
# Check that the request matches the signature
# Signature ok
# The Subjects Distinguished Name is as follows
# countryName      :PRINTABLE:'FI'
# organizationName :PRINTABLE:'MySQL AB'
# commonName       :PRINTABLE:'MySQL admin'
# Certificate is to be certified until Sep 13 14:22:46 2003 GMT
# (365 days)
# Sign the certificate? [y/n]:y
#
#
# 1 out of 1 certificate requests certified, commit? [y/n]y
# Write out database with 1 new entries
# Data Base Updated

#
# Create client request and key
#
openssl req -new -keyout $DIR/client-key.pem -out \
    $DIR/client-req.pem -days 3600 -config $DIR/openssl.cnf

# Sample output:
# Using configuration from /home/monty/openssl/openssl.cnf
# Generating a 1024 bit RSA private key
# ..+++++
# .....+++++
# writing new private key to '/home/monty/openssl/client-key.pem'
# Enter PEM pass phrase:
# Verifying password - Enter PEM pass phrase:
# -----
# You are about to be asked to enter information that will be
# incorporated into your certificate request.
# What you are about to enter is what is called a Distinguished Name
# or a DN.
# There are quite a few fields but you can leave some blank
# For some fields there will be a default value,
# If you enter '.', the field will be left blank.
# -----
# Country Name (2 letter code) [AU]:FI
# State or Province Name (full name) [Some-State]:.
# Locality Name (eg, city) []:
# Organization Name (eg, company) [Internet Widgits Pty Ltd]:MySQL AB
# Organizational Unit Name (eg, section) []:
# Common Name (eg, YOUR name) []:MySQL user
# Email Address []:
#
# Please enter the following 'extra' attributes
# to be sent with your certificate request
# A challenge password []:

```

```

# An optional company name []:
#
# Remove the passphrase from the key
#
openssl rsa -in $DIR/client-key.pem -out $DIR/client-key.pem
#
# Sign client cert
#
openssl ca -policy policy_anything -out $DIR/client-cert.pem \
-config $DIR/openssl.cnf -infiles $DIR/client-req.pem

# Sample output:
# Using configuration from /home/monty/openssl/openssl.cnf
# Enter PEM pass phrase:
# Check that the request matches the signature
# Signature ok
# The Subjects Distinguished Name is as follows
# countryName             :PRINTABLE:'FI'
# organizationName       :PRINTABLE:'MySQL AB'
# commonName              :PRINTABLE:'MySQL user'
# Certificate is to be certified until Sep 13 16:45:17 2003 GMT
# (365 days)
# Sign the certificate? [y/n]:y
#
#
# 1 out of 1 certificate requests certified, commit? [y/n]y
# Write out database with 1 new entries
# Data Base Updated

#
# Create a my.cnf file that you can use to test the certificates
#
cnf=""
cnf="$cnf [client]"
cnf="$cnf ssl-ca=$DIR/cacert.pem"
cnf="$cnf ssl-cert=$DIR/client-cert.pem"
cnf="$cnf ssl-key=$DIR/client-key.pem"
cnf="$cnf [mysqld]"
cnf="$cnf ssl-ca=$DIR/cacert.pem"
cnf="$cnf ssl-cert=$DIR/server-cert.pem"
cnf="$cnf ssl-key=$DIR/server-key.pem"
echo $cnf | replace " " '
' > $DIR/my.cnf

```

### Example 3: Creating SSL files on Windows

Download OpenSSL for Windows. An overview of available packages can be seen here: <http://www.slproweb.com/products/Win32OpenSSL.html>

Choose of the following packages, depending on your architecture (32-bit or 64-bit):

- Win32 OpenSSL v0.9.8j Light, available at: [http://www.slproweb.com/download/Win32OpenSSL\\_Light-0\\_9\\_8j.exe](http://www.slproweb.com/download/Win32OpenSSL_Light-0_9_8j.exe)
- Win64 OpenSSL v0.9.8j Light, available at: [http://www.slproweb.com/download/Win64OpenSSL\\_Light-0\\_9\\_8j.exe](http://www.slproweb.com/download/Win64OpenSSL_Light-0_9_8j.exe)

if a message occurs during setup indicating '*...critical component is missing: Microsoft Visual C++ 2008 Redistributables*', cancel the setup and download one of the following packages as well, again depending on your architecture (32-bit or 64-bit):

- Visual C++ 2008 Redistributables (x86), available at: <http://www.microsoft.com/downloads/details.aspx?familyid=9B2DA534-3E03-4391-8A4D-074B9F2BC1BF?isplaylang=en>
- Visual C++ 2008 Redistributables (x64), available at: <http://www.microsoft.com/downloads/details.aspx?familyid=bd2a6171-e2d6-4230-b809-9a8d7548c1b6?isplaylang=en>

After installing the additional package, restart the OpenSSL setup.

During installation, leave the default `C:\OpenSSL` as the install path, and also leave the default option '`Copy OpenSSL DLL files to the Windows system directory`' selected.

When the installation has finished, add `C:\OpenSSL\bin` to the Windows System Path variable of your server:

- On the Windows desktop, right-click on the My Computer icon, and select Properties.

- Next select the Advanced tab from the **SYSTEM PROPERTIES** menu that appears, and click the ENVIRONMENT VARIABLES button.
- Under **SYSTEM VARIABLES**, select Path, and then click the EDIT button. The **EDIT SYSTEM VARIABLE** dialogue should appear.
- Add '`;C:\OpenSSL\bin`' to the end (notice the semicolon).
- Press OK 3 times.
- Check that OpenSSL was correctly integrated into the Path variable by opening a new command console (`Start>Run>cmd.exe`) and verifying that OpenSSL is available:

```
Microsoft Windows [Version ...]
Copyright (c) 2006 Microsoft Corporation. All rights reserved.

C:\Windows\system32>cd \

C:\>openssl
OpenSSL> exit <<< If you see the OpenSSL prompt, installation was successful.

C:\>
```

Depending on your version of Windows, the preceding instructions might be slightly different.

After OpenSSL has been installed, use the instructions from Example 1 (shown earlier in this section), with the following changes:

- Change the follow Unix commands:

```
# Create clean environment
shell> rm -rf newcerts
shell> mkdir newcerts && cd newcerts
```

On Windows, use these commands instead:

```
# Create clean environment
shell> md c:\newcerts
shell> cd c:\newcerts
```

- When a '`\`' character is shown at the end of a command line, this '`\`' character must be removed and the command lines entered all on a single line.
- For references to `my.cnf` option files, substitute `my.ini` instead.

### Testing SSL connections

To test SSL connections, start the server as follows, where `$DIR` is the path name to the directory where the sample `my.cnf` option file is located:

```
shell> mysqld --defaults-file=$DIR/my.cnf &
```

Then invoke a client program using the same option file:

```
shell> mysql --defaults-file=$DIR/my.cnf
```

If you have a MySQL source distribution, you can also test your setup by modifying the preceding `my.cnf` file to refer to the demonstration certificate and key files in the `mysql-test/std_data` directory of the distribution.

## 5.5.8. Connecting to MySQL Remotely from Windows with SSH

This section describes how to get a secure connection to a remote MySQL server with SSH. The information was provided by David Carlson <[dcarlson@mplcomm.com](mailto:dcarlson@mplcomm.com)>.

1. Install an SSH client on your Windows machine. As a user, the best non-free one I have found is from **SecureCRT** from <http://www.vandyke.com/>. Another option is **f-secure** from <http://www.f-secure.com/>. You can also find some free ones on Google at <http://directory.google.com/Top/Computers/Internet/Protocols/SSH/Clients/Windows/>.
2. Start your Windows SSH client. Set `Host_Name = yourmysqlserver_URL_or_IP`. Set `userid=your_userid` to log in to your server. This `userid` value might not be the same as the user name of your MySQL account.

3. Set up port forwarding. Either do a remote forward (Set `local_port: 3306`, `remote_host: yourmysqlserver-name_or_ip`, `remote_port: 3306`) or a local forward (Set `port: 3306`, `host: localhost`, `remote port: 3306`).
4. Save everything, otherwise you will have to redo it the next time.
5. Log in to your server with the SSH session you just created.
6. On your Windows machine, start some ODBC application (such as Access).
7. Create a new file in Windows and link to MySQL using the ODBC driver the same way you normally do, except type in `localhost` for the MySQL host server, not `yourmysqlservername`.

At this point, you should have an ODBC connection to MySQL, encrypted using SSH.

## 5.5.9. Auditing MySQL Account Activity

Applications can use the following guidelines to perform auditing that ties database activity to MySQL accounts.

MySQL accounts correspond to rows in the `mysql.user` table. When a client connects successfully, the server authenticates the client to a particular row in this table. The `User` and `Host` column values in this row uniquely identify the account and correspond to the `'user_name'@'host_name'` format in which account names are written in SQL statements.

The account used to authenticate a client determines which privileges the client has. Normally, the `CURRENT_USER()` function can be invoked to determine which account this is for the client user. Its value is constructed from the `User` and `Host` columns of the `user` table row for the account.

However, there are circumstances under which the `CURRENT_USER()` value corresponds not to the client user but to a different account. This occurs in contexts when privilege checking is not based the client's account:

- Stored routines (procedures and functions) defined with the `SQL SECURITY DEFINER` characteristic
- Views defined with the `SQL SECURITY DEFINER` characteristic (as of MySQL 5.1.12)
- Triggers and events

In those contexts, privilege checking is done against the `DEFINER` account and `CURRENT_USER()` refers to that account, not to the account for the client who invoked the stored routine or view or who caused the trigger to activate. To determine the invoking user, you can call the `USER()` function, which returns a value indicating the actual user name provided by the client and the host from which the client connected. However, this value does not necessarily correspond directly to an account in the `user` table, because the `USER()` value never contains wildcards, whereas account values (as returned by `CURRENT_USER()`) may contain user name and host name wildcards.

For example, a blank user name matches any user, so an account of `'@localhost'` enables clients to connect as an anonymous user from the local host with any user name. If this case, if a client connects as `user1` from the local host, `USER()` and `CURRENT_USER()` return different values:

```
mysql> SELECT USER(), CURRENT_USER();
+-----+-----+
| USER() | CURRENT_USER() |
+-----+-----+
| user1@localhost | @localhost |
+-----+-----+
```

The host name part of an account can contain wildcards, too. If the host name contains a `'%'` or `'_'` pattern character or uses net-mask notation, the account can be used for clients connecting from multiple hosts and the `CURRENT_USER()` value will not indicate which one. For example, the account `'user2'@'%.example.com'` can be used by `user2` to connect from any host in the `example.com` domain. If `user2` connects from `remote.example.com`, `USER()` and `CURRENT_USER()` return different values:

```
mysql> SELECT USER(), CURRENT_USER();
+-----+-----+
| USER() | CURRENT_USER() |
+-----+-----+
| user2@remote.example.com | user2@%.example.com |
+-----+-----+
```

If an application must invoke `USER()` for user auditing (for example, if it does auditing from within triggers) but must also be able to associate the `USER()` value with an account in the `user` table, it is necessary to avoid accounts that contain wildcards in the

`User` or `Host` column. Specifically, do not allow `User` to be empty (which creates an anonymous-user account), and do not allow pattern characters or netmask notation in `Host` values. All accounts must have a non-empty `User` value and literal `Host` value.

With respect to the previous examples, the `'@'localhost'` and `'user2'@'%.example.com'` accounts should be changed not to use wildcards:

```
RENAME USER '@'localhost' TO 'user1'@'localhost';
RENAME USER 'user2'@'%.example.com' TO 'user2'@'remote.example.com';
```

If `user2` must be able to connect from several hosts in the `example.com` domain, there should be a separate account for each host.

To extract the user name or host name part from a `CURRENT_USER()` or `USER()` value, use the `SUBSTRING()` function:

```
mysql> SELECT SUBSTRING_INDEX(CURRENT_USER(), '@', 1);
+-----+
| SUBSTRING_INDEX(CURRENT_USER(), '@', 1) |
+-----+
| user1                                     |
+-----+

mysql> SELECT SUBSTRING_INDEX(CURRENT_USER(), '@', -1);
+-----+
| SUBSTRING_INDEX(CURRENT_USER(), '@', -1) |
+-----+
| localhost                                 |
+-----+
```

## 5.6. Running Multiple MySQL Servers on the Same Machine

In some cases, you might want to run multiple `mysqld` servers on the same machine. You might want to test a new MySQL release while leaving your existing production setup undisturbed. Or you might want to give different users access to different `mysqld` servers that they manage themselves. (For example, you might be an Internet Service Provider that wants to provide independent MySQL installations for different customers.)

To run multiple servers on a single machine, each server must have unique values for several operating parameters. These can be set on the command line or in option files. See [Section 4.2.3, “Specifying Program Options”](#).

At least the following options must be different for each server:

- `--port=port_num`

`--port` controls the port number for TCP/IP connections. (Alternatively, if the host has multiple network addresses, you can use `--bind-address` to cause different servers to listen to different interfaces.)

- `--socket=path`

`--socket` controls the Unix socket file path on Unix and the name of the named pipe on Windows. On Windows, it is necessary to specify distinct pipe names only for those servers that support named-pipe connections.

- `--shared-memory-base-name=name`

This option currently is used only on Windows. It designates the shared-memory name used by a Windows server to allow clients to connect via shared memory. It is necessary to specify distinct shared-memory names only for those servers that support shared-memory connections.

- `--pid-file=file_name`

This option is used only on Unix. It indicates the path name of the file in which the server writes its process ID.

If you use the following log file options, they must be different for each server:

- `--general_log` or `--log[=file_name]`
- `--log-bin[=file_name]`
- `--slow_query_log` or `--log-slow-queries[=file_name]`
- `--log-error[=file_name]`

Section 5.2.6, “[Server Log Maintenance](#)”, discusses the log file options further.

For better performance, you can specify the following options differently for each server, to spread the load between several physical disks:

- `--tmpdir=path`

Having different temporary directories is also recommended to make it easier to determine which MySQL server created any given temporary file.

With very limited exceptions, each server should use a different data directory, which is specified using the `--datadir=path` option.

### Warning

Normally, you should never have two servers that update data in the same databases. This may lead to unpleasant surprises if your operating system does not support fault-free system locking. If (despite this warning) you run multiple servers using the same data directory and they have logging enabled, you must use the appropriate options to specify log file names that are unique to each server. Otherwise, the servers try to log to the same files. Please note that this kind of setup only works with [MyISAM](#) and [MERGE](#) tables, and not with any of the other storage engines.

The warning against sharing a data directory among servers also applies in an NFS environment. Allowing multiple MySQL servers to access a common data directory over NFS is a *very bad idea*.

- The primary problem is that NFS is the speed bottleneck. It is not meant for such use.
- Another risk with NFS is that you must devise a way to ensure that two or more servers do not interfere with each other. Usually NFS file locking is handled by the `lockd` daemon, but at the moment there is no platform that performs locking 100% reliably in every situation.

Make it easy for yourself: Forget about sharing a data directory among servers over NFS. A better solution is to have one computer that contains several CPUs and use an operating system that handles threads efficiently.

If you have multiple MySQL installations in different locations, you can specify the base installation directory for each server with the `--basedir=path` option to cause each server to use a different data directory, log files, and PID file. (The defaults for all these values are determined relative to the base directory). In that case, the only other options you need to specify are the `--socket` and `--port` options. For example, suppose that you install different versions of MySQL using `tar` file binary distributions. These install in different locations, so you can start the server for each installation using the command `bin/mysqld_safe` under its corresponding base directory. `mysqld_safe` determines the proper `--basedir` option to pass to `mysqld`, and you need specify only the `--socket` and `--port` options to `mysqld_safe`.

As discussed in the following sections, it is possible to start additional servers by setting environment variables or by specifying appropriate command-line options. However, if you need to run multiple servers on a more permanent basis, it is more convenient to use option files to specify for each server those option values that must be unique to it. The `--defaults-file` option is useful for this purpose.

## 5.6.1. Running Multiple Servers on Windows

You can run multiple servers on Windows by starting them manually from the command line, each with appropriate operating parameters. On Windows NT-based systems, you also have the option of installing several servers as Windows services and running them that way. General instructions for running MySQL servers from the command line or as services are given in [Section 2.3, “Installing MySQL on Windows”](#). This section describes how to make sure that you start each server with different values for those startup options that must be unique per server, such as the data directory. These options are described in [Section 5.6, “Running Multiple MySQL Servers on the Same Machine”](#).

### 5.6.1.1. Starting Multiple Windows Servers at the Command Line

To start multiple servers manually from the command line, you can specify the appropriate options on the command line or in an option file. It is more convenient to place the options in an option file, but it is necessary to make sure that each server gets its own set of options. To do this, create an option file for each server and tell the server the file name with a `--defaults-file` option when you run it.

Suppose that you want to run `mysqld` on port 3307 with a data directory of `C:\mydata1`, and `mysqld-debug` on port 3308 with a data directory of `C:\mydata2`. (To do this, make sure that before you start the servers, each data directory exists and has its own copy of the `mysql` database that contains the grant tables.) Then create two option files. For example, create one file named `C:\my-opts1.cnf` that looks like this:

```
[mysqld]
datadir = C:/mydata1
port = 3307
```

Create a second file named `C:\my-opts2.cnf` that looks like this:

```
[mysqld]
datadir = C:/mydata2
port = 3308
```

Then start each server with its own option file:

```
C:\> C:\mysql\bin\mysqld --defaults-file=C:\my-opts1.cnf
C:\> C:\mysql\bin\mysqld-debug --defaults-file=C:\my-opts2.cnf
```

On NT, each server starts in the foreground (no new prompt appears until the server exits later), so you will need to issue those two commands in separate console windows.

To shut down the servers, you must connect to each using the appropriate port number:

```
C:\> C:\mysql\bin\mysqladmin --port=3307 shutdown
C:\> C:\mysql\bin\mysqladmin --port=3308 shutdown
```

Servers configured as just described allow clients to connect over TCP/IP. If your version of Windows supports named pipes and you also want to allow named-pipe connections, use the `mysqld-nt` (MySQL 5.1.20 and earlier), `mysqld` (MySQL 5.1.21 and later) or `mysqld-debug` server and specify options that enable the named pipe and specify its name. Each server that supports named-pipe connections must use a unique pipe name. For example, the `C:\my-opts1.cnf` file might be written like this:

```
[mysqld]
datadir = C:/mydata1
port = 3307
enable-named-pipe
socket = mypipel
```

Then start the server this way:

```
C:\> C:\mysql\bin\mysqld --defaults-file=C:\my-opts1.cnf
```

Modify `C:\my-opts2.cnf` similarly for use by the second server.

A similar procedure applies for servers that you want to support shared-memory connections. Enable such connections with the `--shared-memory` option and specify a unique shared-memory name for each server with the `--shared-memory-base-name` option.

### 5.6.1.2. Starting Multiple Windows Servers as Services

On NT-based systems, a MySQL server can run as a Windows service. The procedures for installing, controlling, and removing a single MySQL service are described in [Section 2.3.11, “Starting MySQL as a Windows Service”](#).

You can also install multiple MySQL servers as services. In this case, you must make sure that each server uses a different service name in addition to all the other parameters that must be unique for each server.

For the following instructions, assume that you want to run the `mysqld` server from two different versions of MySQL that are installed at `C:\mysql-5.0.19` and `C:\mysql-5.1.36`, respectively. (This might be the case if you are running 5.0.19 as your production server, but also want to conduct tests using 5.1.36.)

The following principles apply when installing a MySQL service with the `--install` or `--install-manual` option:

- If you specify no service name, the server uses the default service name of `MySQL` and the server reads options from the `[mysqld]` group in the standard option files.
- If you specify a service name after the `--install` option, the server ignores the `[mysqld]` option group and instead reads options from the group that has the same name as the service. The server reads options from the standard option files.
- If you specify a `--defaults-file` option after the service name, the server ignores the standard option files and reads options only from the `[mysqld]` group of the named file.

#### ■ Note



Before MySQL 4.0.17, only a server installed using the default service name (`MySQL`) or one installed explicitly with a service name of `mysqld` will read the `[mysqld]` group in the standard option files. As of 4.0.17, all servers read the `[mysqld]` group if they read the standard option files, even if they are installed using another service name. This allows you to use the `[mysqld]` group for options that should be used by all MySQL services, and an option group named after each service for use by the server installed with that service name.

Based on the preceding information, you have several ways to set up multiple services. The following instructions describe some examples. Before trying any of them, be sure that you shut down and remove any existing MySQL services first.

- **Approach 1:** Specify the options for all services in one of the standard option files. To do this, use a different service name for each server. Suppose that you want to run the 5.0.19 `mysqld` using the service name of `mysqld1` and the 5.1.36 `mysqld` using the service name `mysqld2`. In this case, you can use the `[mysqld1]` group for 5.0.19 and the `[mysqld2]` group for 5.1.36. For example, you can set up `C:\my.cnf` like this:

```
# options for mysqld1 service
[mysqld1]
basedir = C:/mysql-5.0.19
port = 3307
enable-named-pipe
socket = mypipe1

# options for mysqld2 service
[mysqld2]
basedir = C:/mysql-5.1.36
port = 3308
enable-named-pipe
socket = mypipe2
```

Install the services as follows, using the full server path names to ensure that Windows registers the correct executable program for each service:

```
C:\> C:/mysql-5.0.19/bin/mysqld --install mysqld1
C:\> C:/mysql-5.1.36/bin/mysqld --install mysqld2
```

To start the services, use the services manager, or use `NET START` with the appropriate service names:

```
C:\> NET START mysqld1
C:\> NET START mysqld2
```

To stop the services, use the services manager, or use `NET STOP` with the appropriate service names:

```
C:\> NET STOP mysqld1
C:\> NET STOP mysqld2
```

- **Approach 2:** Specify options for each server in separate files and use `--defaults-file` when you install the services to tell each server what file to use. In this case, each file should list options using a `[mysqld]` group.

With this approach, to specify options for the 5.0.19 `mysqld-nt`, create a file `C:\my-opts1.cnf` that looks like this:

```
[mysqld]
basedir = C:/mysql-5.0.19
port = 3307
enable-named-pipe
socket = mypipe1
```

For the 5.1.36 `mysqld`, create a file `C:\my-opts2.cnf` that looks like this:

```
[mysqld]
basedir = C:/mysql-5.1.36
port = 3308
enable-named-pipe
socket = mypipe2
```

Install the services as follows (enter each command on a single line):

```
C:\> C:/mysql-5.0.19/bin/mysqld --install mysqld1
--defaults-file=C:/my-opts1.cnf
C:\> C:/mysql-5.1.36/bin/mysqld --install mysqld2
--defaults-file=C:/my-opts2.cnf
```

To use a `--defaults-file` option when you install a MySQL server as a service, you must precede the option with the service name.

After installing the services, start and stop them the same way as in the preceding example.

To remove multiple services, use `mysqld --remove` for each one, specifying a service name following the `--remove` option. If the service name is the default (MySQL), you can omit it.

## 5.6.2. Running Multiple Servers on Unix

The easiest way to run multiple servers on Unix is to compile them with different TCP/IP ports and Unix socket files so that each one is listening on different network interfaces. Compiling in different base directories for each installation also results automatically in a separate, compiled-in data directory, log file, and PID file location for each server.

Assume that an existing 5.0.19 server is configured for the default TCP/IP port number (3306) and Unix socket file (`/tmp/mysql.sock`). To configure a new 5.1.36 server to have different operating parameters, use a `configure` command something like this:

```
shell> ./configure --with-tcp-port=port_number \
--with-unix-socket-path=file_name \
--prefix=/usr/local/mysql-5.1.36
```

Here, `port_number` and `file_name` must be different from the default TCP/IP port number and Unix socket file path name, and the `--prefix` value should specify an installation directory different from the one under which the existing MySQL installation is located.

If you have a MySQL server listening on a given port number, you can use the following command to find out what operating parameters it is using for several important configurable variables, including the base directory and Unix socket file name:

```
shell> mysqladmin --host=host_name --port=port_number variables
```

With the information displayed by that command, you can tell what option values *not* to use when configuring an additional server.

Note that if you specify `localhost` as a host name, `mysqladmin` defaults to using a Unix socket file connection rather than TCP/IP. From MySQL 4.1 onward, you can explicitly specify the connection protocol to use by using the `--protocol={TCP|SOCKET|PIPE|MEMORY}` option.

You don't have to compile a new MySQL server just to start with a different Unix socket file and TCP/IP port number. It is also possible to use the same server binary and start each invocation of it with different parameter values at runtime. One way to do so is by using command-line options:

```
shell> mysqld_safe --socket=file_name --port=port_number
```

To start a second server, provide different `--socket` and `--port` option values, and pass a `--datadir=path` option to `mysqld_safe` so that the server uses a different data directory.

Another way to achieve a similar effect is to use environment variables to set the Unix socket file name and TCP/IP port number:

```
shell> MYSQL_UNIX_PORT=/tmp/mysqld-new.sock
shell> MYSQL_TCP_PORT=3307
shell> export MYSQL_UNIX_PORT MYSQL_TCP_PORT
shell> mysql_install_db --user=mysql
shell> mysqld_safe --datadir=/path/to/datadir &
```

This is a quick way of starting a second server to use for testing. The nice thing about this method is that the environment variable settings apply to any client programs that you invoke from the same shell. Thus, connections for those clients are automatically directed to the second server.

Section 2.14, “Environment Variables”, includes a list of other environment variables you can use to affect `mysqld`.

For automatic server execution, the startup script that is executed at boot time should execute the following command once for each server with an appropriate option file path for each command:

```
shell> mysqld_safe --defaults-file=file_name
```

Each option file should contain option values specific to a given server.

On Unix, the `mysqld_multi` script is another way to start multiple servers. See Section 4.3.4, “`mysqld_multi` — Manage Multiple MySQL Servers”.

## 5.6.3. Using Client Programs in a Multiple-Server Environment

To connect with a client program to a MySQL server that is listening to different network interfaces from those compiled into your client, you can use one of the following methods:

- Start the client with `--host=host_name --port=port_number` to connect via TCP/IP to a remote server, with `--host=127.0.0.1 --port=port_number` to connect via TCP/IP to a local server, or with `--host=localhost --socket=file_name` to connect to a local server via a Unix socket file or a Windows named pipe.
- As of MySQL 4.1, start the client with `--protocol=TCP` to connect via TCP/IP, `--protocol=SOCKET` to connect via a Unix socket file, `--protocol=PIPE` to connect via a named pipe, or `--protocol=MEMORY` to connect via shared memory. For TCP/IP connections, you may also need to specify `--host` and `--port` options. For the other types of connections, you may need to specify a `--socket` option to specify a Unix socket file or Windows named-pipe name, or a `--shared-memory-base-name` option to specify the shared-memory name. Shared-memory connections are supported only on Windows.
- On Unix, set the `MYSQL_UNIX_PORT` and `MYSQL_TCP_PORT` environment variables to point to the Unix socket file and TCP/IP port number before you start your clients. If you normally use a specific socket file or port number, you can place commands to set these environment variables in your `.login` file so that they apply each time you log in. See [Section 2.14, “Environment Variables”](#).
- Specify the default Unix socket file and TCP/IP port number in the `[client]` group of an option file. For example, you can use `C:\my.cnf` on Windows, or the `.my.cnf` file in your home directory on Unix. See [Section 4.2.3.2, “Using Option Files”](#).
- In a C program, you can specify the socket file or port number arguments in the `mysql_real_connect()` call. You can also have the program read option files by calling `mysql_options()`. See [Section 20.10.3, “C API Function Descriptions”](#).
- If you are using the Perl `DBD::mysql` module, you can read options from MySQL option files. For example:

```
$dsn = "DBI:mysql:test;mysql_read_default_group=client;"  
      . "mysql_read_default_file=/usr/local/mysql/data/my.cnf";  
$dbh = DBI->connect($dsn, $user, $password);
```

See [Section 20.12, “MySQL Perl API”](#).

Other programming interfaces may provide similar capabilities for reading option files.

---

## Chapter 6. Backup and Recovery

It is important to back up your databases in case problems occur so that you can recover your data and be up and running again. MySQL offers a variety of backup strategies from which you can choose to select whatever methods best suit the requirements for your installation.

Briefly summarized, backup concepts with which you should be familiar include the following:

- Logical versus physical backups
- Online versus offline backups
- Local versus remote backups
- Snapshot backups
- Full versus incremental backups
- Point-in-time recovery
- Backup scheduling, compression, and encryption
- Table maintenance

More generally, the following discussion amplifies on the properties of different backup methods.

- **Logical versus physical (raw) backups.** Logical backups save information represented as logical database structure (`CREATE DATABASE`, `CREATE TABLE` statements) and content (`INSERT` statements or delimited-text files). Physical backups consist of raw copies of the directories and files that store database contents.

Logical backup methods have these characteristics:

- The backup is done by going through the MySQL server to obtain database structure and content information.
- Backup is slower than physical methods because the server must access database information, convert it to logical format, and send it to the backup program.
- Output is larger than for physical backup, particularly when saved in text format.
- Backup and restore granularity is available at the server level (all databases), database level (all tables in a particular database), or table level. This is true regardless of storage engine.
- The backup does not include log or configuration files, or other database-related files that are not part of databases.
- Backups stored in logical format are machine independent and highly portable.
- Logical backups are performed with the MySQL server running (the server is not taken offline).
- Logical backup tools include the `mysqldump` program and the `SELECT ... INTO OUTFILE` statement. These work for any storage engine, even `MEMORY`.

For restore, SQL-format dump files can be processed using the `mysql` client. To load delimited-text files, use the `LOAD DATA INFILE` statement or the `mysqlimport` client.

Physical backup methods have these characteristics:

- The backup consists of exact copies of database directories and files. Typically this is a copy of all or part of the MySQL data directory. Data from `MEMORY` tables cannot be backed up this way because their contents are not stored on disk.
- Physical backup methods are faster than logical because they involve only file copying without conversion.
- Output is more compact than for logical backup.
- Backup and restore granularity extends from the level of the entire data directory down to the level of individual files. This may or may not provide for table-level granularity, depending on storage engine. (Each `MyISAM` table corresponds uniquely to a set of files, but an `InnoDB` table shares file storage with other `InnoDB` tables.)
- In addition to databases, the backup can include any related files such as log or configuration files.

- Backups are portable only to other machines that have identical or similar hardware characteristics.
- Backups can be performed while the MySQL server is not running. If the server is running, it is necessary to perform appropriate locking so that the server does not change database contents during the backup.
- Physical backup tools include file system-level commands (such as `cp`, `scp`, `tar`, `rsync`), `mysqlhotcopy` for MyISAM tables, `ibbackup` for InnoDB tables, or `START BACKUP` for NDB tables.

For restore, files copied at the file system level or with `mysqlhotcopy` can be copied back to their original locations with file system commands; `ibback` restores InnoDB tables, and `ndb_restore` restores NDB tables.

- **Online versus offline backups.** Online backups take place while the MySQL server is running so that the database information can be obtained from the server. Offline backups take place while the server is stopped. (This distinction can also be described as “hot” versus “cold” backups; a “warm” backup is one where the server remains running but locked against modifying data while you access database files externally.)

Online backup methods have these characteristics:

- Less intrusive to other clients, which can connect to the MySQL server during the backup and may be able to access data depending on what operations they need to perform.
- Care must be taken to impose appropriate locking so that data modifications do not take place that compromise backup integrity.

Offline backup methods have these characteristics:

- Affects clients adversely because the server is unavailable during backup.
- Simpler backup procedure because there is no possibility of interference from client activity.
- **Local versus remote backups.** A local backup is performed on the same host where the MySQL server runs, whereas a remote backup is initiated from a different host.
  - `mysqldump` can connect to local or remote servers. For SQL output (`CREATE` and `INSERT` statements), local or remote dumps can be done and generate output on the client. For delimited-text output (with the `--tab` option), data files are created on the server host.
  - `mysqlhotcopy` performs only local backups: It connects to the server to lock it against data modifications and then copies local table files.
  - `SELECT ... INTO OUTFILE` can be initiated from a remote client host, but the output file is created on the server host.
  - Physical backup methods typically are initiated locally on the MySQL server host so that the server can be taken offline, although the destination for file copies might be remote.
- **Snapshot backups.** Some file system implementations enable “snapshots” to be taken. These provide logical copies of the file system at a given point in time, without having to physically copy the entire file system. (For example, the implementation may use copy-on-write techniques so that only parts of the file system modified after the snapshot time need be copied.) MySQL itself does not provide the capability for taking file system snapshots. It is available through third-party solutions such as Veritas or LVM.
- **Full versus incremental backups.** A full backup includes all data managed by a MySQL server at a given point in time. An incremental backup consists of the changes made to the data since the full backup. MySQL has different ways to perform full backups, such as those described in previous items. Incremental backups are made possible by enabling the server's binary log, which the server uses to record data changes.
- **Point-in-time recovery.** One use for the binary log is to achieve point-in-time recovery. This is done by recovering first from the backup files to restore the server to its state when the backup was made, and then by re-executing changes in subsequently written binary log files to redo data modifications up to the desired point in time.
- **Backup scheduling, compression, and encryption.** Backup scheduling is valuable for automating backup procedures. Compression of backup output reduces space requirements, and encryption of the output provides better security against unauthorized access of backed-up data. MySQL itself does not provide these capabilities. `ibbackup` can compress InnoDB backups, and compression or encryption of backup output can be achieved using file system utilities. Other third-party solutions may be available.
- **Table maintenance.** Data integrity can be compromised if tables become corrupt. MySQL provides programs for checking tables and repairing them should problems be found. These programs apply primarily to MyISAM tables. See [Section 6.4, “Table Maintenance and Crash Recovery”](#).

### Additional resources

Resources related to backup or to maintaining data availability include the following:

- A forum dedicated to backup issues is available at <http://forums.mysql.com/list.php?93>.
- The syntax of the SQL statements described here is given in [Chapter 12, \*SQL Statement Syntax\*](#).
- Details for `mysqldump`, `mysqlhotcopy`, and other MySQL backup programs can be found in [Chapter 4, \*MySQL Programs\*](#).
- For additional information about InnoDB backup procedures, see [Section 13.6.6, “Backing Up and Recovering an InnoDB Database”](#).
- Replication enables you to maintain identical data on multiple servers. This has several benefits, such as allowing client load to be distributed over servers, availability of data even if a given server is taken offline or fails, and the ability to make backups using a slave server without affecting the master. See [Chapter 16, \*Replication\*](#).
- MySQL Cluster provides a high-availability, high-redundancy version of MySQL adapted for the distributed computing environment. See [MySQL Cluster NDB 6.X/7.X](#). For information specifically about MySQL Cluster backup, see [Online Backup of MySQL Cluster](#).
- Distributed Replicated Block Device (DRBD) is another high-availability solution. It works by replicating a block device from a primary server to a secondary server at the block level. See [Chapter 14, \*High Availability and Scalability\*](#)

## 6.1. Database Backups

This section summarizes some general methods for making backups.

### Making Backups by Copying Files

MyISAM tables are stored as files, so it is easy to do a backup by copying files. To get a consistent backup, do a `LOCK TABLES` on the relevant tables, followed by `FLUSH TABLES` for the tables. See [Section 12.4.5, “LOCK TABLES and UNLOCK TABLES Syntax”](#), and [Section 12.5.6.3, “FLUSH Syntax”](#). You need only a read lock; this allows other clients to continue to query the tables while you are making a copy of the files in the database directory. The `FLUSH TABLES` statement is needed to ensure that the all active index pages are written to disk before you start the backup.

### Making Delimited-Text File Backups

To create a text file containing a table's data, you can use `SELECT * INTO OUTFILE 'file_name' FROM tbl_name`. The file is created on the MySQL server host, not the client host. For this statement, the output file cannot already exist because allowing files to be overwritten would constitute a security risk. See [Section 12.2.8, “SELECT Syntax”](#). This method works for any kind of data file, but saves only table data, not the table structure.

To reload the output file, use `LOAD DATA INFILE` or `mysqlimport`.

### Making Backups with `mysqldump` or `mysqlhotcopy`

Another technique for backing up a database is to use the `mysqldump` program or the `mysqlhotcopy` script. `mysqldump` is more general because it can back up all kinds of tables. `mysqlhotcopy` works only with some storage engines. (See [Section 4.5.4, “mysqldump — A Database Backup Program”](#), and [Section 4.6.9, “mysqlhotcopy — A Database Backup Program”](#).)

Create a full backup of your database:

```
shell> mysqldump --tab=/path/to/some/dir --opt db_name
```

Or:

```
shell> mysqlhotcopy db_name /path/to/some/dir
```

You can also create a binary backup simply by copying all table files (`*.frm`, `*.MYD`, and `*.MYI` files), as long as the server isn't updating anything. The `mysqlhotcopy` script uses this method. (But note that these methods do not work if your database contains InnoDB tables. InnoDB does not necessarily store table contents in database directories, and `mysqlhotcopy` works only for MyISAM and ISAM tables.)

For InnoDB tables, it is possible to perform an online backup that takes no locks on tables; see [Section 4.5.4, “mysqldump — A Database Backup Program”](#).

### Using the Binary Log to Enable Incremental Backups

MySQL supports incremental backups: You must start the server with the `--log-bin` option to enable binary logging; see [Section 5.2.4, “The Binary Log”](#). The binary log files provide you with the information you need to replicate changes to the database that are made subsequent to the point at which you performed a backup. At the moment you want to make an incremental backup (containing all changes that happened since the last full or incremental backup), you should rotate the binary log by using `FLUSH LOGS`. This done, you need to copy to the backup location all binary logs which range from the one of the moment of the last full or incremental backup to the last but one. These binary logs are the incremental backup; at restore time, you apply them as explained in [Section 6.3, “Point-in-Time Recovery”](#). The next time you do a full backup, you should also rotate the binary log using `FLUSH LOGS`, `mysqldump --flush-logs`, or `mysqlhotcopy --flushlog`. See [Section 4.5.4, “mysqldump — A Database Backup Program”](#), and [Section 4.6.9, “mysqlhotcopy — A Database Backup Program”](#).

### Backing Up Replication Slaves

If your MySQL server is a slave replication server, then regardless of the backup method you choose, you should also back up the `master.info` and `relay-log.info` files when you back up your slave's data. These files are always needed to resume replication after you restore the slave's data. If your slave is subject to replicating `LOAD DATA INFILE` commands, you should also back up any `SQL_LOAD-*` files that may exist in the directory specified by the `--slave-load-tmpdir` option. (This location defaults to the value of the `tmpdir` system variable if not specified.) The slave needs these files to resume replication of any interrupted `LOAD DATA INFILE` operations.

#### MySQL Enterprise

The MySQL Enterprise Monitor provides numerous advisors that issue immediate warnings should replication issues arise. For more information, see <http://www.mysql.com/products/enterprise/advisors.html>.

If you have performance problems with your master server while making backups, one strategy that can help is to set up replication and perform backups on the slave rather than on the master. See [Chapter 16, Replication](#).

### Recovering Corrupt Tables

If you have to restore `MyISAM` tables that have become corrupt, try to recover them using `REPAIR TABLE` or `myisamchk -r` first. That should work in 99.9% of all cases. If `myisamchk` fails, try the following procedure. It is assumed that you have enabled binary logging by starting MySQL with the `--log-bin` option.

1. Restore the original `mysqldump` backup, or binary backup.
2. Execute the following command to re-run the updates in the binary logs:

```
shell> mysqlbinlog binlog.[0-9]* | mysql
```

In some cases, you may want to re-run only certain binary logs, from certain positions (usually you want to re-run all binary logs from the date of the restored backup, excepting possibly some incorrect statements). See [Section 6.3, “Point-in-Time Recovery”](#).

### Making Backups Using a File System Snapshot

If you are using a Veritas file system, you can make a backup like this:

1. From a client program, execute `FLUSH TABLES WITH READ LOCK`.
2. From another shell, execute `mount vxfss snapshot`.
3. From the first client, execute `UNLOCK TABLES`.
4. Copy files from the snapshot.
5. Unmount the snapshot.

## 6.2. Example Backup and Recovery Strategy

This section discusses a procedure for performing backups that allows you to recover data after several types of crashes:

- Operating system crash
- Power failure



- File system crash
- Hardware problem (hard drive, motherboard, and so forth)

The example commands do not include options such as `--user` and `--password` for the `mysqldump` and `mysql` programs. You should include such options as necessary so that the MySQL server allows you to connect to it.

We assume that data is stored in the `InnoDB` storage engine, which has support for transactions and automatic crash recovery. We also assume that the MySQL server is under load at the time of the crash. If it were not, no recovery would ever be needed.

For cases of operating system crashes or power failures, we can assume that MySQL's disk data is available after a restart. The `InnoDB` data files might not contain consistent data due to the crash, but `InnoDB` reads its logs and finds in them the list of pending committed and non-committed transactions that have not been flushed to the data files. `InnoDB` automatically rolls back those transactions that were not committed, and flushes to its data files those that were committed. Information about this recovery process is conveyed to the user through the MySQL error log. The following is an example log excerpt:

```
InnoDB: Database was not shut down normally.
InnoDB: Starting recovery from log files...
InnoDB: Starting log scan based on checkpoint at
InnoDB: log sequence number 0 13674004
InnoDB: Doing recovery: scanned up to log sequence number 0 13739520
InnoDB: Doing recovery: scanned up to log sequence number 0 13805056
InnoDB: Doing recovery: scanned up to log sequence number 0 13870592
InnoDB: Doing recovery: scanned up to log sequence number 0 13936128
...
InnoDB: Doing recovery: scanned up to log sequence number 0 20555264
InnoDB: Doing recovery: scanned up to log sequence number 0 20620800
InnoDB: Doing recovery: scanned up to log sequence number 0 20664692
InnoDB: 1 uncommitted transaction(s) which must be rolled back
InnoDB: Starting rollback of uncommitted transactions
InnoDB: Rolling back trx no 16745
InnoDB: Rolling back of trx no 16745 completed
InnoDB: Rollback of uncommitted transactions completed
InnoDB: Starting an apply batch of log records to the database...
InnoDB: Apply batch completed
InnoDB: Started
mysqld: ready for connections
```

For the cases of file system crashes or hardware problems, we can assume that the MySQL disk data is *not* available after a restart. This means that MySQL fails to start successfully because some blocks of disk data are no longer readable. In this case, it is necessary to reformat the disk, install a new one, or otherwise correct the underlying problem. Then it is necessary to recover our MySQL data from backups, which means that we must already have made backups. To make sure that is the case, we should design a backup policy.

## 6.2.1. Backup Policy

We all know that backups must be scheduled periodically. A full backup (a snapshot of the data at a point in time) can be done in MySQL with several tools. For example, `InnoDB Hot Backup` provides online non-blocking physical backup of the `InnoDB` data files, and `mysqldump` provides online logical backup. This discussion uses `mysqldump`.

### MySQL Enterprise

For expert advice on backups and replication, subscribe to the MySQL Enterprise Monitor. For more information, see <http://www.mysql.com/products/enterprise/advisors.html>.

Assume that we make a backup on Sunday at 1 p.m., when load is low. The following command makes a full backup of all our `InnoDB` tables in all databases:

```
shell> mysqldump --single-transaction --all-databases > backup_sunday_1_PM.sql
```

This backup acquires a global read lock on all tables (using `FLUSH TABLES WITH READ LOCK`) at the beginning of the dump. As soon as this lock has been acquired, the binary log coordinates are read and the lock is released. If long updating statements are running when the `FLUSH` statement is issued, the MySQL server may get stalled until those statements finish. After that, the dump becomes lock-free and does not disturb reads and writes on the tables.

We assumed earlier that our tables are `InnoDB` tables, so `--single-transaction` uses a consistent read and guarantees that data seen by `mysqldump` does not change. (Changes made by other clients to `InnoDB` tables are not seen by the `mysqldump` process.) If we do also have other types of tables, we must assume that they are not changed during the backup. For example, for the `MyISAM` tables in the `mysql` database, we must assume that no administrative changes are being made to MySQL accounts during the backup.

The resulting `.sql` file produced by `mysqldump` contains a set of SQL `INSERT` statements that can be used to reload the dumped tables at a later time.



Full backups are necessary, but they are not always convenient. They produce large backup files and take time to generate. They are not optimal in the sense that each successive full backup includes all data, even that part that has not changed since the previous full backup. After we have made the initial full backup, it is more efficient to make incremental backups. They are smaller and take less time to produce. The tradeoff is that, at recovery time, you cannot restore your data just by reloading the full backup. You must also process the incremental backups to recover the incremental changes.

To make incremental backups, we need to save the incremental changes. The MySQL server should always be started with the `--log-bin` option so that it stores these changes in a file while it updates data. This option enables binary logging, so that the server writes each SQL statement that updates data into a file called a MySQL binary log. Looking at the data directory of a MySQL server that was started with the `--log-bin` option and that has been running for some days, we find these MySQL binary log files:

```
-rw-rw---- 1 guilhem guilhem 1277324 Nov 10 23:59 gbichot2-bin.000001
-rw-rw---- 1 guilhem guilhem      4 Nov 10 23:59 gbichot2-bin.000002
-rw-rw---- 1 guilhem guilhem    79 Nov 11 11:06 gbichot2-bin.000003
-rw-rw---- 1 guilhem guilhem   508 Nov 11 11:08 gbichot2-bin.000004
-rw-rw---- 1 guilhem guilhem 220047446 Nov 12 16:47 gbichot2-bin.000005
-rw-rw---- 1 guilhem guilhem   998412 Nov 14 10:08 gbichot2-bin.000006
-rw-rw---- 1 guilhem guilhem    361 Nov 14 10:07 gbichot2-bin.index
```

Each time it restarts, the MySQL server creates a new binary log file using the next number in the sequence. While the server is running, you can also tell it to close the current binary log file and begin a new one manually by issuing a `FLUSH LOGS SQL` statement or with a `mysqladmin flush-logs` command. `mysqldump` also has an option to flush the logs. The `.index` file in the data directory contains the list of all MySQL binary logs in the directory. This file is used for replication.

The MySQL binary logs are important for recovery because they form the set of incremental backups. If you make sure to flush the logs when you make your full backup, then any binary log files created afterward contain all the data changes made since the backup. Let's modify the previous `mysqldump` command a bit so that it flushes the MySQL binary logs at the moment of the full backup, and so that the dump file contains the name of the new current binary log:

```
shell> mysqldump --single-transaction --flush-logs --master-data=2 \
--all-databases > backup_sunday_1_PM.sql
```

After executing this command, the data directory contains a new binary log file, `gbichot2-bin.000007`. The resulting `.sql` file includes these lines:

```
-- Position to start replication or point-in-time recovery from
-- CHANGE MASTER TO MASTER_LOG_FILE='gbichot2-bin.000007',MASTER_LOG_POS=4;
```

Because the `mysqldump` command made a full backup, those lines mean two things:

- The `.sql` file contains all changes made before any changes written to the `gbichot2-bin.000007` binary log file or newer.
- All data changes logged after the backup are not present in the `.sql`, but are present in the `gbichot2-bin.000007` binary log file or newer.

On Monday at 1 p.m., we can create an incremental backup by flushing the logs to begin a new binary log file. For example, executing a `mysqladmin flush-logs` command creates `gbichot2-bin.000008`. All changes between the Sunday 1 p.m. full backup and Monday 1 p.m. will be in the `gbichot2-bin.000007` file. This incremental backup is important, so it is a good idea to copy it to a safe place. (For example, back it up on tape or DVD, or copy it to another machine.) On Tuesday at 1 p.m., execute another `mysqladmin flush-logs` command. All changes between Monday 1 p.m. and Tuesday 1 p.m. will be in the `gbichot2-bin.000008` file (which also should be copied somewhere safe).

The MySQL binary logs take up disk space. To free up space, purge them from time to time. One way to do this is by deleting the binary logs that are no longer needed, such as when we make a full backup:

```
shell> mysqldump --single-transaction --flush-logs --master-data=2 \
--all-databases --delete-master-logs > backup_sunday_1_PM.sql
```

### Note

Deleting the MySQL binary logs with `mysqldump --delete-master-logs` can be dangerous if your server is a replication master server, because slave servers might not yet fully have processed the contents of the binary log. The description for the `PURGE BINARY LOGS` statement explains what should be verified before deleting the MySQL binary logs. See [Section 12.6.1.1, “PURGE BINARY LOGS Syntax”](#).

## 6.2.2. Using Backups for Recovery

Now, suppose that we have a catastrophic crash on Wednesday at 8 a.m. that requires recovery from backups. To recover, first we restore the last full backup we have (the one from Sunday 1 p.m.). The full backup file is just a set of SQL statements, so restoring it is very easy:

```
shell> mysql < backup_sunday_1_PM.sql
```

At this point, the data is restored to its state as of Sunday 1 p.m.. To restore the changes made since then, we must use the incremental backups; that is, the `gbichot2-bin.000007` and `gbichot2-bin.000008` binary log files. Fetch the files if necessary from where they were backed up, and then process their contents like this:

```
shell> mysqlbinlog gbichot2-bin.000007 gbichot2-bin.000008 | mysql
```

We now have recovered the data to its state as of Tuesday 1 p.m., but still are missing the changes from that date to the date of the crash. To not lose them, we would have needed to have the MySQL server store its MySQL binary logs into a safe location (RAID disks, SAN, ...) different from the place where it stores its data files, so that these logs were not on the destroyed disk. (That is, we can start the server with a `--log-bin` option that specifies a location on a different physical device from the one on which the data directory resides. That way, the logs are safe even if the device containing the directory is lost.) If we had done this, we would have the `gbichot2-bin.000009` file at hand, and we could apply it using `mysqlbinlog` and `mysql` to restore the most recent data changes with no loss up to the moment of the crash.

### 6.2.3. Backup Strategy Summary

In case of an operating system crash or power failure, InnoDB itself does all the job of recovering data. But to make sure that you can sleep well, observe the following guidelines:

- Always run the MySQL server with the `--log-bin` option, or even `--log-bin=log_name`, where the log file name is located on some safe media different from the drive on which the data directory is located. If you have such safe media, this technique can also be good for disk load balancing (which results in a performance improvement).
- Make periodic full backups, using the `mysqldump` command shown earlier in Section 6.2.1, “Backup Policy”, that makes an online, non-blocking backup.
- Make periodic incremental backups by flushing the logs with `FLUSH LOGS` or `mysqladmin flush-logs`.

## 6.3. Point-in-Time Recovery

If a MySQL server was started with the `--log-bin` option to enable binary logging, you can use the `mysqlbinlog` utility to recover data from the binary log files, starting from a specified point in time (for example, since your last backup) until the present or another specified point in time. For information on enabling the binary log and using `mysqlbinlog`, see Section 5.2.4, “The Binary Log”, and Section 4.6.7, “`mysqlbinlog` — Utility for Processing Binary Log Files”.

#### MySQL Enterprise

For maximum data recovery, the MySQL Enterprise Monitor advises subscribers to synchronize to disk at each write. For more information, see <http://www.mysql.com/products/enterprise/advisors.html>.

To restore data from a binary log, you must know the location and name of the current binary log file. By default, the server creates binary log files in the data directory, but a path name can be specified with the `--log-bin` option to place the files in a different location. Typically the option is given in an option file (that is, `my.cnf` or `my.ini`, depending on your system). It can also be given on the command line when the server is started. To determine the name of the current binary log file, issue the following statement:

```
mysql> SHOW MASTER STATUS
```

If you prefer, you can execute the following command from the command line instead:

```
shell> mysql -u root -p -E -e "SHOW MASTER STATUS"
```

Enter the `root` password for your server when `mysql` prompts you for it.

To view the contents of a binary log, use `mysqlbinlog`. See Section 4.6.7, “`mysqlbinlog` — Utility for Processing Binary Log Files”.

### 6.3.1. Specifying Times for Recovery

To indicate the start and end times for recovery, specify the `--start-datetime` and `--stop-datetime` options for

`mysqlbinlog`, in `DATETIME` format. As an example, suppose that exactly at 10:00 a.m. on April 20, 2005 an SQL statement was executed that deleted a large table. To restore the table and data, you could restore the previous night's backup, and then execute the following command:

```
shell> mysqlbinlog --stop-datetime="2005-04-20 9:59:59" \
/var/log/mysql/bin.123456 | mysql -u root -p
```

This command recovers all of the data up until the date and time given by the `--stop-datetime` option. If you did not detect the erroneous SQL statement that was entered until hours later, you will probably also want to recover the activity that occurred afterward. Based on this, you could run `mysqlbinlog` again with a start date and time, like so:

```
shell> mysqlbinlog --start-datetime="2005-04-20 10:01:00" \
/var/log/mysql/bin.123456 | mysql -u root -p
```

In this command, the SQL statements logged from 10:01 a.m. on will be re-executed. The combination of restoring of the previous night's dump file and the two `mysqlbinlog` commands restores everything up until one second before 10:00 a.m. and everything from 10:01 a.m. on. You should examine the log to be sure of the exact times to specify for the commands. To display the log file contents without executing them, use this command:

```
shell> mysqlbinlog /var/log/mysql/bin.123456 > /tmp/mysql_restore.sql
```

Then open the file with a text editor to examine it.

### 6.3.2. Specifying Positions for Recovery

Instead of specifying dates and times, the `--start-position` and `--stop-position` options for `mysqlbinlog` can be used for specifying log positions. They work the same as the start and stop date options, except that you specify log position numbers rather than dates. Using positions may enable you to be more precise about which part of the log to recover, especially if many transactions occurred around the same time as a damaging SQL statement. To determine the position numbers, run `mysqlbinlog` for a range of times near the time when the unwanted transaction was executed, but redirect the results to a text file for examination. This can be done like so:

```
shell> mysqlbinlog --start-datetime="2005-04-20 9:55:00" \
--stop-datetime="2005-04-20 10:05:00" \
/var/log/mysql/bin.123456 > /tmp/mysql_restore.sql
```

This command creates a small text file in the `/tmp` directory that contains the SQL statements around the time that the deleterious SQL statement was executed. Open this file with a text editor and look for the statement that you don't want to repeat. Determine the positions in the binary log for stopping and resuming the recovery and make note of them. Positions are labeled as `log_pos` followed by a number. After restoring the previous backup file, use the position numbers to process the binary log file. For example, you would use commands something like these:

```
shell> mysqlbinlog --stop-position="368312" /var/log/mysql/bin.123456 \
| mysql -u root -p
shell> mysqlbinlog --start-position="368315" /var/log/mysql/bin.123456 \
| mysql -u root -p
```

The first command recovers all the transactions up until the stop position given. The second command recovers all transactions from the starting position given until the end of the binary log. Because the output of `mysqlbinlog` includes `SET TIMESTAMP` statements before each SQL statement recorded, the recovered data and related MySQL logs will reflect the original times at which the transactions were executed.

## 6.4. Table Maintenance and Crash Recovery

This section discusses how to use `myisamchk` to check or repair MyISAM tables (tables that have `.MYD` and `.MYI` files for storing data and indexes). For general `myisamchk` background, see Section 4.6.3, “`myisamchk` — MyISAM Table-Maintenance Utility”.

You can use `myisamchk` to get information about your database tables or to check, repair, or optimize them. The following sections describe how to perform these operations and how to set up a table maintenance schedule.

Even though table repair with `myisamchk` is quite secure, it is always a good idea to make a backup *before* doing a repair or any maintenance operation that could make a lot of changes to a table.

`myisamchk` operations that affect indexes can cause `FULLTEXT` indexes to be rebuilt with full-text parameters that are incompatible with the values used by the MySQL server. To avoid this problem, follow the guidelines in Section 4.6.3.1, “`myisamchk` General Options”.

In many cases, you may find it simpler to do MyISAM table maintenance using the SQL statements that perform operations that

`myisamchk` can do:

- To check or repair **MyISAM** tables, use `CHECK TABLE` or `REPAIR TABLE`.
- To optimize **MyISAM** tables, use `OPTIMIZE TABLE`.
- To analyze **MyISAM** tables, use `ANALYZE TABLE`.

These statements can be used directly or by means of the `mysqlcheck` client program. One advantage of these statements over `myisamchk` is that the server does all the work. With `myisamchk`, you must make sure that the server does not use the tables at the same time so that there is no unwanted interaction between `myisamchk` and the server. See [Section 12.5.2.1, “ANALYZE TABLE Syntax”](#), [Section 12.5.2.3, “CHECK TABLE Syntax”](#), [Section 12.5.2.5, “OPTIMIZE TABLE Syntax”](#), and [Section 12.5.2.6, “REPAIR TABLE Syntax”](#).

## 6.4.1. Using `myisamchk` for Crash Recovery

This section describes how to check for and deal with data corruption in MySQL databases. If your tables become corrupted frequently, you should try to find the reason why. See [Section B.1.4.2, “What to Do If MySQL Keeps Crashing”](#).

For an explanation of how **MyISAM** tables can become corrupted, see [Section 13.4.4, “MyISAM Table Problems”](#).

If you run `mysqld` with external locking disabled (which is the default as of MySQL 4.0), you cannot reliably use `myisamchk` to check a table when `mysqld` is using the same table. If you can be certain that no one will access the tables through `mysqld` while you run `myisamchk`, you only have to execute `mysqladmin flush-tables` before you start checking the tables. If you cannot guarantee this, you must stop `mysqld` while you check the tables. If you run `myisamchk` to check tables that `mysqld` is updating at the same time, you may get a warning that a table is corrupt even when it is not.

If the server is run with external locking enabled, you can use `myisamchk` to check tables at any time. In this case, if the server tries to update a table that `myisamchk` is using, the server will wait for `myisamchk` to finish before it continues.

If you use `myisamchk` to repair or optimize tables, you *must* always ensure that the `mysqld` server is not using the table (this also applies if external locking is disabled). If you do not stop `mysqld`, you should at least do a `mysqladmin flush-tables` before you run `myisamchk`. Your tables *may become corrupted* if the server and `myisamchk` access the tables simultaneously.

When performing crash recovery, it is important to understand that each **MyISAM** table `tbl_name` in a database corresponds to the three files in the database directory shown in the following table.

File	Purpose
<code>tbl_name.frm</code>	Definition (format) file
<code>tbl_name.MYD</code>	Data file
<code>tbl_name.MYI</code>	Index file

Each of these three file types is subject to corruption in various ways, but problems occur most often in data files and index files.

`myisamchk` works by creating a copy of the `.MYD` data file row by row. It ends the repair stage by removing the old `.MYD` file and renaming the new file to the original file name. If you use `--quick`, `myisamchk` does not create a temporary `.MYD` file, but instead assumes that the `.MYD` file is correct and generates only a new index file without touching the `.MYD` file. This is safe, because `myisamchk` automatically detects whether the `.MYD` file is corrupt and aborts the repair if it is. You can also specify the `--quick` option twice to `myisamchk`. In this case, `myisamchk` does not abort on some errors (such as duplicate-key errors) but instead tries to resolve them by modifying the `.MYD` file. Normally the use of two `--quick` options is useful only if you have too little free disk space to perform a normal repair. In this case, you should at least make a backup of the table before running `myisamchk`.

## 6.4.2. How to Check **MyISAM** Tables for Errors

To check a **MyISAM** table, use the following commands:

- `myisamchk tbl_name`

This finds 99.99% of all errors. What it cannot find is corruption that involves *only* the data file (which is very unusual). If you want to check a table, you should normally run `myisamchk` without options or with the `-s` (silent) option.

- `myisamchk -m tbl_name`

This finds 99.999% of all errors. It first checks all index entries for errors and then reads through all rows. It calculates a check-

sum for all key values in the rows and verifies that the checksum matches the checksum for the keys in the index tree.

- `myisamchk -e tbl_name`

This does a complete and thorough check of all data (`-e` means “extended check”). It does a check-read of every key for each row to verify that they indeed point to the correct row. This may take a long time for a large table that has many indexes. Normally, `myisamchk` stops after the first error it finds. If you want to obtain more information, you can add the `-v` (verbose) option. This causes `myisamchk` to keep going, up through a maximum of 20 errors.

- `myisamchk -e -i tbl_name`

This is like the previous command, but the `-i` option tells `myisamchk` to print additional statistical information.

In most cases, a simple `myisamchk` command with no arguments other than the table name is sufficient to check a table.

### 6.4.3. How to Repair Tables

The discussion in this section describes how to use `myisamchk` on MyISAM tables (extensions `.MYI` and `.MYD`).

You can also (and should, if possible) use the `CHECK TABLE` and `REPAIR TABLE` statements to check and repair MyISAM tables. See [Section 12.5.2.3, “CHECK TABLE Syntax”](#), and [Section 12.5.2.6, “REPAIR TABLE Syntax”](#).

Symptoms of corrupted tables include queries that abort unexpectedly and observable errors such as these:

- `tbl_name.frm` is locked against change
- Can't find file `tbl_name.MYI` (Errcode: `nnn`)
- Unexpected end of file
- Record file is crashed
- Got error `nnn` from table handler

To get more information about the error, run `pererror nnn`, where `nnn` is the error number. The following example shows how to use `pererror` to find the meanings for the most common error numbers that indicate a problem with a table:

```
shell> pererror 126 127 132 134 135 136 141 144 145
MySQL error code 126 = Index file is crashed
MySQL error code 127 = Record-file is crashed
MySQL error code 132 = Old database file
MySQL error code 134 = Record was already deleted (or record file crashed)
MySQL error code 135 = No more room in record file
MySQL error code 136 = No more room in index file
MySQL error code 141 = Duplicate unique key or constraint on write or update
MySQL error code 144 = Table is crashed and last repair failed
MySQL error code 145 = Table was marked as crashed and should be repaired
```

Note that error 135 (no more room in record file) and error 136 (no more room in index file) are not errors that can be fixed by a simple repair. In this case, you must use `ALTER TABLE` to increase the `MAX_ROWS` and `AVG_ROW_LENGTH` table option values:

```
ALTER TABLE tbl_name MAX_ROWS=xxx AVG_ROW_LENGTH=yyy;
```

If you do not know the current table option values, use `SHOW CREATE TABLE`.

For the other errors, you must repair your tables. `myisamchk` can usually detect and fix most problems that occur.

The repair process involves up to four stages, described here. Before you begin, you should change location to the database directory and check the permissions of the table files. On Unix, make sure that they are readable by the user that `mysqld` runs as (and to you, because you need to access the files you are checking). If it turns out you need to modify files, they must also be writable by you.

This section is for the cases where a table check fails (such as those described in [Section 6.4.2, “How to Check MyISAM Tables for Errors”](#)), or you want to use the extended features that `myisamchk` provides.

The options that you can use for table maintenance with `myisamchk` are described in [Section 4.6.3, “myisamchk — MyISAM Table-Maintenance Utility”](#).

If you are going to repair a table from the command line, you must first stop the `mysqld` server. Note that when you do `mysql-`

`admin shutdown` on a remote server, the `mysqld` server is still alive for a while after `mysqladmin` returns, until all statement-processing has stopped and all index changes have been flushed to disk.

### Stage 1: Checking your tables

Run `myisamchk *.MYI` or `myisamchk -e *.MYI` if you have more time. Use the `-s` (silent) option to suppress unnecessary information.

If the `mysqld` server is stopped, you should use the `--update-state` option to tell `myisamchk` to mark the table as “checked.”

You have to repair only those tables for which `myisamchk` announces an error. For such tables, proceed to Stage 2.

If you get unexpected errors when checking (such as `out of memory` errors), or if `myisamchk` crashes, go to Stage 3.

### Stage 2: Easy safe repair

First, try `myisamchk -r -q tbl_name` (`-r -q` means “quick recovery mode”). This attempts to repair the index file without touching the data file. If the data file contains everything that it should and the delete links point at the correct locations within the data file, this should work, and the table is fixed. Start repairing the next table. Otherwise, use the following procedure:

1. Make a backup of the data file before continuing.
2. Use `myisamchk -r tbl_name` (`-r` means “recovery mode”). This removes incorrect rows and deleted rows from the data file and reconstructs the index file.
3. If the preceding step fails, use `myisamchk --safe-recover tbl_name`. Safe recovery mode uses an old recovery method that handles a few cases that regular recovery mode does not (but is slower).

#### Note

If you want a repair operation to go much faster, you should set the values of the `sort_buffer_size` and `key_buffer_size` variables each to about 25% of your available memory when running `myisamchk`.

If you get unexpected errors when repairing (such as `out of memory` errors), or if `myisamchk` crashes, go to Stage 3.

### Stage 3: Difficult repair

You should reach this stage only if the first 16KB block in the index file is destroyed or contains incorrect information, or if the index file is missing. In this case, it is necessary to create a new index file. Do so as follows:

1. Move the data file to a safe place.
2. Use the table description file to create new (empty) data and index files:

```
shell> mysql db_name
mysql> SET autocommit=1;
mysql> TRUNCATE TABLE tbl_name;
mysql> quit
```

3. Copy the old data file back onto the newly created data file. (Do not just move the old file back onto the new file. You want to retain a copy in case something goes wrong.)

#### Important

If you are using replication, you should stop it prior to performing the above procedure, since it involves file system operations, and these are not logged by MySQL.

Go back to Stage 2. `myisamchk -r -q` should work. (This should not be an endless loop.)

You can also use the `REPAIR TABLE tbl_name USE_FRM` SQL statement, which performs the whole procedure automatically. There is also no possibility of unwanted interaction between a utility and the server, because the server does all the work when you use `REPAIR TABLE`. See [Section 12.5.2.6, “REPAIR TABLE Syntax”](#).

### Stage 4: Very difficult repair

You should reach this stage only if the `.frm` description file has also crashed. That should never happen, because the description file is not changed after the table is created:



1. Restore the description file from a backup and go back to Stage 3. You can also restore the index file and go back to Stage 2. In the latter case, you should start with `myisamchk -r`.
2. If you do not have a backup but know exactly how the table was created, create a copy of the table in another database. Remove the new data file, and then move the `.frm` description and `.MYI` index files from the other database to your crashed database. This gives you new description and index files, but leaves the `.MYD` data file alone. Go back to Stage 2 and attempt to reconstruct the index file.

## 6.4.4. Table Optimization

To coalesce fragmented rows and eliminate wasted space that results from deleting or updating rows, run `myisamchk` in recovery mode:

```
shell> myisamchk -r tbl_name
```

You can optimize a table in the same way by using the `OPTIMIZE TABLE` SQL statement. `OPTIMIZE TABLE` does a table repair and a key analysis, and also sorts the index tree so that key lookups are faster. There is also no possibility of unwanted interaction between a utility and the server, because the server does all the work when you use `OPTIMIZE TABLE`. See [Section 12.5.2.5, “OPTIMIZE TABLE Syntax”](#).

`myisamchk` has a number of other options that you can use to improve the performance of a table:

- `--analyze, -a`
- `--sort-index, -S`
- `--sort-records=index_num, -R index_num`

For a full description of all available options, see [Section 4.6.3, “myisamchk — MyISAM Table-Maintenance Utility”](#).

## 6.4.5. Getting Information About a Table

To obtain a description of a table or statistics about it, use the commands shown here. We explain some of the information in more detail later.

- `myisamchk -d tbl_name`

Runs `myisamchk` in “describe mode” to produce a description of your table. If you start the MySQL server with external locking disabled, `myisamchk` may report an error for a table that is updated while it runs. However, because `myisamchk` does not change the table in describe mode, there is no risk of destroying data.

- `myisamchk -d -v tbl_name`

Adding `-v` runs `myisamchk` in verbose mode so that it produces more information about what it is doing.

- `myisamchk -eis tbl_name`

Shows only the most important information from a table. This operation is slow because it must read the entire table.

- `myisamchk -eiv tbl_name`

This is like `-eis`, but tells you what is being done.

The `tbl_name` argument can be either the name of a `MyISAM` table or the name of its index file, as described in [Section 4.6.3, “myisamchk — MyISAM Table-Maintenance Utility”](#). Multiple `tbl_name` arguments can be given.

Sample output for some of these commands follows. They are based on a table with these data and index file sizes:

```
-rw-rw-r-- 1 monty tcx 317235748 Jan 12 17:30 company.MYD
-rw-rw-r-- 1 davida tcx 96482304 Jan 12 18:35 company.MYI
```

Example of `myisamchk -d` output:

```
MyISAM file: company.MYI
Record format: Fixed length
Data records: 1403698 Deleted blocks: 0
```

```
Recordlength: 226
```

```
table description:
Key Start Len Index Type
1 2 8 unique double
2 15 10 multip. text packed stripped
3 219 8 multip. double
4 63 10 multip. text packed stripped
5 167 2 multip. unsigned short
6 177 4 multip. unsigned long
7 155 4 multip. text
8 138 4 multip. unsigned long
9 177 4 multip. unsigned long
193 1 text
```

Example of `myisamchk -d -v` output:

```
MyISAM file: company
Record format: Fixed length
File-version: 1
Creation time: 1999-10-30 12:12:51
Recover time: 1999-10-31 19:13:01
Status: checked
Data records: 1403698 Deleted blocks: 0
Datafile parts: 1403698 Deleted data: 0
Datafile pointer (bytes): 3 Keyfile pointer (bytes): 3
Max datafile length: 3791650815 Max keyfile length: 4294967294
Recordlength: 226
```

```
table description:
Key Start Len Index Type Rec/key Root Blocksize
1 2 8 unique double 1 15845376 1024
2 15 10 multip. text packed stripped 2 25062400 1024
3 219 8 multip. double 73 40907776 1024
4 63 10 multip. text packed stripped 5 48097280 1024
5 167 2 multip. unsigned short 4840 55200768 1024
6 177 4 multip. unsigned long 1346 65145856 1024
7 155 4 multip. text 4995 75090944 1024
8 138 4 multip. unsigned long 87 85036032 1024
9 177 4 multip. unsigned long 178 96481280 1024
193 1 text
```

Example of `myisamchk -eis` output:

```
Checking MyISAM file: company
Key: 1: Keyblocks used: 97% Packed: 0% Max levels: 4
Key: 2: Keyblocks used: 98% Packed: 50% Max levels: 4
Key: 3: Keyblocks used: 97% Packed: 0% Max levels: 4
Key: 4: Keyblocks used: 99% Packed: 60% Max levels: 3
Key: 5: Keyblocks used: 99% Packed: 0% Max levels: 3
Key: 6: Keyblocks used: 99% Packed: 0% Max levels: 3
Key: 7: Keyblocks used: 99% Packed: 0% Max levels: 3
Key: 8: Keyblocks used: 99% Packed: 0% Max levels: 3
Key: 9: Keyblocks used: 98% Packed: 0% Max levels: 4
Total: Keyblocks used: 98% Packed: 17%

Records: 1403698 M.recordlength: 226
Packed: 0%
Recordspace used: 100% Empty space: 0%
Blocks/Record: 1.00
Record blocks: 1403698 Delete blocks: 0
Recorddata: 317235748 Deleted data: 0
Lost space: 0 Linkdata: 0

User time 1626.51, System time 232.36
Maximum resident set size 0, Integral resident set size 0
Non physical pagefaults 0, Physical pagefaults 627, Swaps 0
Blocks in 0 out 0, Messages in 0 out 0, Signals 0
Voluntary context switches 639, Involuntary context switches 28966
```

Example of `myisamchk -eiv` output:

```
Checking MyISAM file: company
Data records: 1403698 Deleted blocks: 0
- check file-size
- check delete-chain
block_size 1024:
index 1:
index 2:
index 3:
index 4:
index 5:
index 6:
index 7:
index 8:
index 9:
No recordlinks
- check index reference
- check data record references index: 1
Key: 1: Keyblocks used: 97% Packed: 0% Max levels: 4
- check data record references index: 2
```



```

Key: 2: Keyblocks used: 98% Packed: 50% Max levels: 4
- check data record references index: 3
Key: 3: Keyblocks used: 97% Packed: 0% Max levels: 4
- check data record references index: 4
Key: 4: Keyblocks used: 99% Packed: 60% Max levels: 3
- check data record references index: 5
Key: 5: Keyblocks used: 99% Packed: 0% Max levels: 3
- check data record references index: 6
Key: 6: Keyblocks used: 99% Packed: 0% Max levels: 3
- check data record references index: 7
Key: 7: Keyblocks used: 99% Packed: 0% Max levels: 3
- check data record references index: 8
Key: 8: Keyblocks used: 99% Packed: 0% Max levels: 3
- check data record references index: 9
Key: 9: Keyblocks used: 98% Packed: 0% Max levels: 4
Total: Keyblocks used: 9% Packed: 17%

- check records and index references
*** LOTS OF ROW NUMBERS DELETED ***

Records:          1403698  M.recordlength: 226  Packed:          0%
Recordspace used: 100%  Empty space:    0%  Blocks/Record: 1.00
Record blocks:    1403698  Delete blocks:  0
Recorddata:       317235748  Deleted data:   0
Lost space:       0        Linkdata:       0

User time 1639.63, System time 251.61
Maximum resident set size 0, Integral resident set size 0
Non physical pagefaults 0, Physical pagefaults 10580, Swaps 0
Blocks in 4 out 0, Messages in 0 out 0, Signals 0
Voluntary context switches 10604, Involuntary context switches 122798

```

Explanations for the types of information `myisamchk` produces are given here. “Keyfile” refers to the index file. “Record” and “row” are synonymous.

- `MyISAM file`  
Name of the `MyISAM` (index) file.
- `File-version`  
Version of `MyISAM` format. Currently always 2.
- `Creation time`  
When the data file was created.
- `Recover time`  
When the index/data file was last reconstructed.
- `Data records`  
How many rows are in the table.
- `Deleted blocks`  
How many deleted blocks still have reserved space. You can optimize your table to minimize this space. See [Section 6.4.4, “Table Optimization”](#).
- `Datafile parts`  
For dynamic-row format, this indicates how many data blocks there are. For an optimized table without fragmented rows, this is the same as `Data records`.
- `Deleted data`  
How many bytes of unreclaimed deleted data there are. You can optimize your table to minimize this space. See [Section 6.4.4, “Table Optimization”](#).
- `Datafile pointer`  
The size of the data file pointer, in bytes. It is usually 2, 3, 4, or 5 bytes. Most tables manage with 2 bytes, but this cannot be controlled from MySQL yet. For fixed tables, this is a row address. For dynamic tables, this is a byte address.
- `Keyfile pointer`  
The size of the index file pointer, in bytes. It is usually 1, 2, or 3 bytes. Most tables manage with 2 bytes, but this is calculated

automatically by MySQL. It is always a block address.

- `Max datafile length`

How long the table data file can become, in bytes.

- `Max keyfile length`

How long the table index file can become, in bytes.

- `Recordlength`

How much space each row takes, in bytes.

- `Record format`

The format used to store table rows. The preceding examples use `Fixed length`. Other possible values are `Compressed` and `Packed`.

- `table description`

A list of all keys in the table. For each key, `myisamchk` displays some low-level information:

- `Key`

This key's number.

- `Start`

Where in the row this portion of the index starts.

- `Len`

How long this portion of the index is. For packed numbers, this should always be the full length of the column. For strings, it may be shorter than the full length of the indexed column, because you can index a prefix of a string column.

- `Index`

Whether a key value can exist multiple times in the index. Possible values are `unique` or `multip.` (multiple).

- `Type`

What data type this portion of the index has. This is a `MyISAM` data type with the possible values `packed`, `stripped`, or `empty`.

- `Root`

Address of the root index block.

- `Blocksize`

The size of each index block. By default this is 1024, but the value may be changed at compile time when MySQL is built from source.

- `Rec/key`

This is a statistical value used by the optimizer. It tells how many rows there are per value for this index. A unique index always has a value of 1. This may be updated after a table is loaded (or greatly changed) with `myisamchk -a`. If this is not updated at all, a default value of 30 is given.

For the table shown in the examples, there are two `table description` lines for the ninth index. This indicates that it is a multiple-part index with two parts.

- `Keyblocks used`

What percentage of the keyblocks are used. When a table has just been reorganized with `myisamchk`, as for the table in the examples, the values are very high (very near theoretical maximum).

- `Packed`

MySQL tries to pack key values that have a common suffix. This can only be used for indexes on `CHAR` and `VARCHAR`

columns. For long indexed strings that have similar leftmost parts, this can significantly reduce the space used. In the third of the preceding examples, the fourth key is 10 characters long and a 60% reduction in space is achieved.

- `Max levels`  
How deep the B-tree for this key is. Large tables with long key values get high values.
- `Records`  
How many rows are in the table.
- `M.recordlength`  
The average row length. This is the exact row length for tables with fixed-length rows, because all rows have the same length.
- `Packed`  
MySQL strips spaces from the end of strings. The `Packed` value indicates the percentage of savings achieved by doing this.
- `Recordspace used`  
What percentage of the data file is used.
- `Empty space`  
What percentage of the data file is unused.
- `Blocks/Record`  
Average number of blocks per row (that is, how many links a fragmented row is composed of). This is always 1.0 for fixed-format tables. This value should stay as close to 1.0 as possible. If it gets too large, you can reorganize the table. See [Section 6.4.4, “Table Optimization”](#).
- `Recordblocks`  
How many blocks (links) are used. For fixed-format tables, this is the same as the number of rows.
- `Deleteblocks`  
How many blocks (links) are deleted.
- `Recorddata`  
How many bytes in the data file are used.
- `Deleted data`  
How many bytes in the data file are deleted (unused).
- `Lost space`  
If a row is updated to a shorter length, some space is lost. This is the sum of all such losses, in bytes.
- `Linkdata`  
When the dynamic table format is used, row fragments are linked with pointers (4 to 7 bytes each). `Linkdata` is the sum of the amount of storage used by all such pointers.

If a table has been compressed with `myisampack`, `myisamchk -d` prints additional information about each table column. See [Section 4.6.5, “myisampack — Generate Compressed, Read-Only MyISAM Tables”](#), for an example of this information and a description of what it means.

## 6.4.6. Setting Up a Table Maintenance Schedule

It is a good idea to perform table checks on a regular basis rather than waiting for problems to occur. One way to check and repair MyISAM tables is with the `CHECK TABLE` and `REPAIR TABLE` statements. See [Section 12.5.2.3, “CHECK TABLE Syntax”](#), and [Section 12.5.2.6, “REPAIR TABLE Syntax”](#).

Another way to check tables is to use `myisamchk`. For maintenance purposes, you can use `myisamchk -s`. The `-s` option (short for `--silent`) causes `myisamchk` to run in silent mode, printing messages only when errors occur.

It is also a good idea to enable automatic [MyISAM](#) table checking. For example, whenever the machine has done a restart in the middle of an update, you usually need to check each table that could have been affected before it is used further. (These are “expected crashed tables.”) To check [MyISAM](#) tables automatically, start the server with the `--myisam-recover` option. See [Section 5.1.2, “Server Command Options”](#).

You should also check your tables regularly during normal system operation. For example, you can run a [cron](#) job to check important tables once a week, using a line like this in a [crontab](#) file:

```
35 0 * * 0 /path/to/myisamchk --fast --silent /path/to/datadir/*/*.MYI
```

This prints out information about crashed tables so that you can examine and repair them as necessary.

We recommend that to start with, you execute `myisamchk -s` each night on all tables that have been updated during the last 24 hours. As you see that problems occur infrequently, you can back off the checking frequency to once a week or so.

Normally, MySQL tables need little maintenance. If you are performing many updates to [MyISAM](#) tables with dynamic-sized rows (tables with [VARCHAR](#), [BLOB](#), or [TEXT](#) columns) or have tables with many deleted rows you may want to defragment/reclaim space from the tables from time to time. You can do this by using `OPTIMIZE TABLE` on the tables in question. Alternatively, if you can stop the `mysqld` server for a while, change location into the data directory and use this command while the server is stopped:

```
shell> myisamchk -r -s --sort-index --sort_buffer_size=16M */*.MYI
```

---

# Chapter 7. Optimization

Optimization is a complex task because ultimately it requires understanding of the entire system to be optimized. Although it may be possible to perform some local optimizations with little knowledge of your system or application, the more optimal you want your system to become, the more you must know about it.

This chapter tries to explain and give some examples of different ways to optimize MySQL. Remember, however, that there are always additional ways to make the system even faster, although they may require increasing effort to achieve.

## 7.1. Optimization Overview

The most important factor in making a system fast is its basic design. You must also know what kinds of processing your system is doing, and what its bottlenecks are. In most cases, system bottlenecks arise from these sources:

- Disk seeks. It takes time for the disk to find a piece of data. With modern disks, the mean time for this is usually lower than 10ms, so we can in theory do about 100 seeks a second. This time improves slowly with new disks and is very hard to optimize for a single table. The way to optimize seek time is to distribute the data onto more than one disk.
- Disk reading and writing. When the disk is at the correct position, we need to read the data. With modern disks, one disk delivers at least 10–20MB/s throughput. This is easier to optimize than seeks because you can read in parallel from multiple disks.
- CPU cycles. When we have the data in main memory, we need to process it to get our result. Having small tables compared to the amount of memory is the most common limiting factor. But with small tables, speed is usually not the problem.
- Memory bandwidth. When the CPU needs more data than can fit in the CPU cache, main memory bandwidth becomes a bottleneck. This is an uncommon bottleneck for most systems, but one to be aware of.

### MySQL Enterprise

For instant notification of system bottlenecks subscribe to the MySQL Enterprise Monitor. For more information, see <http://www.mysql.com/products/enterprise/advisors.html>.

### 7.1.1. MySQL Design Limitations and Tradeoffs

When using the `MyISAM` storage engine, MySQL uses extremely fast table locking that allows multiple readers or a single writer. The biggest problem with this storage engine occurs when you have a steady stream of mixed updates and slow selects on a single table. If this is a problem for certain tables, you can use another storage engine for them. See [Chapter 13, Storage Engines](#).

MySQL can work with both transactional and non-transactional tables. To make it easier to work smoothly with non-transactional tables (which cannot roll back if something goes wrong), MySQL has the following rules. Note that these rules apply *only* when not running in strict SQL mode or if you use the `IGNORE` specifier for `INSERT` or `UPDATE`.

- All columns have default values.
- If you insert an inappropriate or out-of-range value into a column, MySQL sets the column to the “best possible value” instead of reporting an error. For numerical values, this is 0, the smallest possible value or the largest possible value. For strings, this is either the empty string or as much of the string as can be stored in the column.
- All calculated expressions return a value that can be used instead of signaling an error condition. For example, `1/0` returns `NULL`.

To change the preceding behaviors, you can enable stricter data handling by setting the server SQL mode appropriately. For more information about data handling, see [Section 1.7.6, “How MySQL Deals with Constraints”](#), [Section 5.1.7, “Server SQL Modes”](#), and [Section 12.2.5, “INSERT Syntax”](#).

### 7.1.2. Designing Applications for Portability

Because all SQL servers implement different parts of standard SQL, it takes work to write portable database applications. It is very easy to achieve portability for very simple selects and inserts, but becomes more difficult the more capabilities you require. If you want an application that is fast with many database systems, it becomes even more difficult.

All database systems have some weak points. That is, they have different design compromises that lead to different behavior.

To make a complex application portable, you need to determine which SQL servers it must work with, and then determine what features those servers support. You can use the MySQL `crash-me` program to find functions, types, and limits that you can use

with a selection of database servers. `crash-me` does not check for every possible feature, but it is still reasonably comprehensive, performing about 450 tests. An example of the type of information `crash-me` can provide is that you should not use column names that are longer than 18 characters if you want to be able to use Informix or DB2.

The `crash-me` program and the MySQL benchmarks are all very database independent. By taking a look at how they are written, you can get a feeling for what you must do to make your own applications database independent. The programs can be found in the `sql-bench` directory of MySQL source distributions. They are written in Perl and use the DBI database interface. Use of DBI in itself solves part of the portability problem because it provides database-independent access methods. See [Section 7.1.4](#), “The MySQL Benchmark Suite”.

If you strive for database independence, you need to get a good feeling for each SQL server's bottlenecks. For example, MySQL is very fast in retrieving and updating rows for `MyISAM` tables, but has a problem in mixing slow readers and writers on the same table. Transactional database systems in general are not very good at generating summary tables from log tables, because in this case row locking is almost useless.

#### MySQL Enterprise

For expert advice on choosing the database engine suitable to your circumstances subscribe to the MySQL Enterprise Monitor. For more information, see <http://www.mysql.com/products/enterprise/advisors.html>.

To make your application *really* database independent, you should define an easily extendable interface through which you manipulate your data. For example, C++ is available on most systems, so it makes sense to use a C++ class-based interface to the databases.

If you use some feature that is specific to a given database system (such as the `REPLACE` statement, which is specific to MySQL), you should implement the same feature for other SQL servers by coding an alternative method. Although the alternative might be slower, it enables the other servers to perform the same tasks.

With MySQL, you can use the `/*! */` syntax to add MySQL-specific keywords to a statement. The code inside `/*! */` is treated as a comment (and ignored) by most other SQL servers. For information about writing comments, see [Section 8.5](#), “Comment Syntax”.

If high performance is more important than exactness, as for some Web applications, it is possible to create an application layer that caches all results to give you even higher performance. By letting old results expire after a while, you can keep the cache reasonably fresh. This provides a method to handle high load spikes, in which case you can dynamically increase the cache size and set the expiration timeout higher until things get back to normal.

In this case, the table creation information should contain information about the initial cache size and how often the table should normally be refreshed.

An attractive alternative to implementing an application cache is to use the MySQL query cache. By enabling the query cache, the server handles the details of determining whether a query result can be reused. This simplifies your application. See [Section 7.5.5](#), “The MySQL Query Cache”.

### 7.1.3. What We Have Used MySQL For

This section describes an early application for MySQL.

During MySQL initial development, the features of MySQL were made to fit our largest customer, which handled data warehousing for a couple of the largest retailers in Sweden.

From all stores, we got weekly summaries of all bonus card transactions, and were expected to provide useful information for the store owners to help them find how their advertising campaigns were affecting their own customers.

The volume of data was quite huge (about seven million summary transactions per month), and we had data for 4–10 years that we needed to present to the users. We got weekly requests from our customers, who wanted instant access to new reports from this data.

We solved this problem by storing all information per month in compressed “transaction tables.” We had a set of simple macros that generated summary tables grouped by different criteria (product group, customer id, store, and so on) from the tables in which the transactions were stored. The reports were Web pages that were dynamically generated by a small Perl script. This script parsed a Web page, executed the SQL statements in it, and inserted the results. We would have used PHP or `mod_perl` instead, but they were not available at the time.

For graphical data, we wrote a simple tool in C that could process SQL query results and produce GIF images based on those results. This tool also was dynamically executed from the Perl script that parses the Web pages.

In most cases, a new report could be created simply by copying an existing script and modifying the SQL query that it used. In some cases, we needed to add more columns to an existing summary table or generate a new one. This also was quite simple because we kept all transaction-storage tables on disk. (This amounted to about 50GB of transaction tables and 200GB of other customer data.)

We also let our customers access the summary tables directly with ODBC so that the advanced users could experiment with the data themselves.

This system worked well and we had no problems handling the data with quite modest Sun Ultra SPARCstation hardware (2×200MHz). Eventually the system was migrated to Linux.

## 7.1.4. The MySQL Benchmark Suite

This benchmark suite is meant to tell any user what operations a given SQL implementation performs well or poorly. You can get a good idea for how the benchmarks work by looking at the code and results in the `sql-bench` directory in any MySQL source distribution.

Note that this benchmark is single-threaded, so it measures the minimum time for the operations performed. We plan to add multi-threaded tests to the benchmark suite in the future.

To use the benchmark suite, the following requirements must be satisfied:

- The benchmark suite is provided with MySQL source distributions. You can either download a released distribution from <http://dev.mysql.com/downloads/>, or use the current development source tree. (See [Section 2.10.3, “Installing from the Development Source Tree”](#).)
- The benchmark scripts are written in Perl and use the Perl DBI module to access database servers, so DBI must be installed. You also need the server-specific DBD drivers for each of the servers you want to test. For example, to test MySQL, PostgreSQL, and DB2, you must have the `DBD: :mysql`, `DBD: :Pg`, and `DBD: :DB2` modules installed. See [Section 2.15, “Perl Installation Notes”](#).

After you obtain a MySQL source distribution, you can find the benchmark suite located in its `sql-bench` directory. To run the benchmark tests, build MySQL, and then change location into the `sql-bench` directory and execute the `run-all-tests` script:

```
shell> cd sql-bench
shell> perl run-all-tests --server=server_name
```

`server_name` should be the name of one of the supported servers. To get a list of all options and supported servers, invoke this command:

```
shell> perl run-all-tests --help
```

The `crash-me` script also is located in the `sql-bench` directory. `crash-me` tries to determine what features a database system supports and what its capabilities and limitations are by actually running queries. For example, it determines:

- What data types are supported
- How many indexes are supported
- What functions are supported
- How big a query can be
- How big a `VARCHAR` column can be

For more information about benchmark results, visit <http://www.mysql.com/why-mysql/benchmarks/>.

## 7.1.5. Using Your Own Benchmarks

You should definitely benchmark your application and database to find out where the bottlenecks are. After fixing one bottleneck (or by replacing it with a “dummy” module), you can proceed to identify the next bottleneck. Even if the overall performance for your application currently is acceptable, you should at least make a plan for each bottleneck and decide how to solve it if someday you really need the extra performance.

For examples of portable benchmark programs, look at those in the MySQL benchmark suite. See [Section 7.1.4, “The MySQL Benchmark Suite”](#). You can take any program from this suite and modify it for your own needs. By doing this, you can try different solutions to your problem and test which really is fastest for you.

Another free benchmark suite is the Open Source Database Benchmark, available at <http://osdb.sourceforge.net/>.

It is very common for a problem to occur only when the system is very heavily loaded. We have had many customers who contact us when they have a (tested) system in production and have encountered load problems. In most cases, performance problems turn out to be due to issues of basic database design (for example, table scans are not good under high load) or problems with the operating system or libraries. Most of the time, these problems would be much easier to fix if the systems were not already in production.

To avoid problems like this, you should put some effort into benchmarking your whole application under the worst possible load:

- The `mysqlslap` program can be helpful for simulating a high load produced by multiple clients issuing queries simultaneously. See [Section 4.5.7, “mysqlslap — Load Emulation Client”](#).
- You can also try Super Smack, available at <http://jeremy.zawodny.com/mysql/super-smack/>.

As suggested by the names of these programs, they can bring a system to its knees, so make sure to use them only on your development systems.

## 7.2. Optimizing `SELECT` and Other Statements

First, one factor affects all statements: The more complex your permissions setup, the more overhead you have. Using simpler permissions when you issue `GRANT` statements enables MySQL to reduce permission-checking overhead when clients execute statements. For example, if you do not grant any table-level or column-level privileges, the server need not ever check the contents of the `tables_priv` and `columns_priv` tables. Similarly, if you place no resource limits on any accounts, the server does not have to perform resource counting. If you have a very high statement-processing load, it may be worth the time to use a simplified grant structure to reduce permission-checking overhead.

If your problem is with a specific MySQL expression or function, you can perform a timing test by invoking the `BENCHMARK()` function using the `mysql` client program. Its syntax is `BENCHMARK(loop_count, expression)`. The return value is always zero, but `mysql` prints a line displaying approximately how long the statement took to execute. For example:

```
mysql> SELECT BENCHMARK(1000000,1+1);
+-----+
| BENCHMARK(1000000,1+1) |
+-----+
| 0 |
+-----+
1 row in set (0.32 sec)
```

This result was obtained on a Pentium II 400MHz system. It shows that MySQL can execute 1,000,000 simple addition expressions in 0.32 seconds on that system.

All MySQL functions should be highly optimized, but there may be some exceptions. `BENCHMARK()` is an excellent tool for finding out if some function is a problem for your queries.

### 7.2.1. Optimizing Queries with `EXPLAIN`

The `EXPLAIN` statement can be used either as a synonym for `DESCRIBE` or as a way to obtain information about how MySQL executes a `SELECT` statement:

- `EXPLAIN tbl_name` is synonymous with `DESCRIBE tbl_name` or `SHOW COLUMNS FROM tbl_name`:

```
EXPLAIN tbl_name
```

- When you precede a `SELECT` statement with the keyword `EXPLAIN`, MySQL displays information from the optimizer about the query execution plan. That is, MySQL explains how it would process the `SELECT`, including information about how tables are joined and in which order:

```
EXPLAIN [EXTENDED | PARTITIONS] SELECT select_options
```

- `EXPLAIN PARTITIONS` is available beginning with MySQL 5.1.5. It is useful only when examining queries involving partitioned tables. For details, see [Section 17.3.4, “Obtaining Information About Partitions”](#).

This section describes the second use of `EXPLAIN` for obtaining query execution plan information. See also [Section 12.3.2, “EXPLAIN Syntax”](#). For a description of the `DESCRIBE` and `SHOW COLUMNS` statements, see [Section 12.3.1, “DESCRIBE Syntax”](#), and [Section 12.5.5.6, “SHOW COLUMNS Syntax”](#).

With the help of `EXPLAIN`, you can see where you should add indexes to tables to get a faster `SELECT` that uses indexes to find rows. You can also use `EXPLAIN` to check whether the optimizer joins the tables in an optimal order. To give a hint to the optim-



izer to use a join order corresponding to the order in which the tables are named in the `SELECT` statement, begin the statement with `SELECT STRAIGHT_JOIN` rather than just `SELECT`. (See [Section 12.2.8](#), “`SELECT Syntax`”.)

If you have a problem with indexes not being used when you believe that they should be, you should run `ANALYZE TABLE` to update table statistics such as cardinality of keys, that can affect the choices the optimizer makes. See [Section 12.5.2.1](#), “`ANALYZE TABLE Syntax`”.

`EXPLAIN` returns a row of information for each table used in the `SELECT` statement. The tables are listed in the output in the order that MySQL would read them while processing the query. MySQL resolves all joins using a *single-sweep multi-join* method. This means that MySQL reads a row from the first table, and then finds a matching row in the second table, the third table, and so on. When all tables are processed, MySQL outputs the selected columns and backtracks through the table list until a table is found for which there are more matching rows. The next row is read from this table and the process continues with the next table.

When the `EXTENDED` keyword is used, `EXPLAIN` produces extra information that can be viewed by issuing a `SHOW WARNINGS` statement following the `EXPLAIN` statement. This information displays how the optimizer qualifies table and column names in the `SELECT` statement, what the `SELECT` looks like after the application of rewriting and optimization rules, and possibly other notes about the optimization process. `EXPLAIN EXTENDED` also displays the `filtered` column as of MySQL 5.1.12.

**Note**

You cannot use the `EXTENDED` and `PARTITIONS` keywords together in the same `EXPLAIN` statement.

Each output row from `EXPLAIN` provides information about one table, and each row contains the following columns:

- `id`

The `SELECT` identifier. This is the sequential number of the `SELECT` within the query.

- `select_type`

The type of `SELECT`, which can be any of those shown in the following table.

<code>SIMPLE</code>	Simple <code>SELECT</code> (not using <code>UNION</code> or subqueries)
<code>PRIMARY</code>	Outermost <code>SELECT</code>
<code>UNION</code>	Second or later <code>SELECT</code> statement in a <code>UNION</code>
<code>DEPENDENT UNION</code>	Second or later <code>SELECT</code> statement in a <code>UNION</code> , dependent on outer query
<code>UNION RESULT</code>	Result of a <code>UNION</code> .
<code>SUBQUERY</code>	First <code>SELECT</code> in subquery
<code>DEPENDENT SUBQUERY</code>	First <code>SELECT</code> in subquery, dependent on outer query
<code>DERIVED</code>	Derived table <code>SELECT</code> (subquery in <code>FROM</code> clause)
<code>UNCACHEABLE SUBQUERY</code>	A subquery for which the result cannot be cached and must be re-evaluated for each row of the outer query
<code>UNCACHEABLE UNION</code>	The second or later select in a <code>UNION</code> that belongs to an uncacheable subquery (see <code>UNCACHEABLE SUBQUERY</code> )

`DEPENDENT` typically signifies the use of a correlated subquery. See [Section 12.2.9.7](#), “`Correlated Subqueries`”.

“`DEPENDENT SUBQUERY`” evaluation differs from `UNCACHEABLE SUBQUERY` evaluation. For “`DEPENDENT SUBQUERY`”, the subquery is re-evaluated only once for each set of different values of the variables from its outer context. For `UNCACHEABLE SUBQUERY`, the subquery is re-evaluated for each row of the outer context. Cacheability of subqueries is subject to the restrictions detailed in [Section 7.5.5.1](#), “`How the Query Cache Operates`”. For example, referring to user variables makes a subquery uncacheable.

- `table`

The table to which the row of output refers.

- `type`

The join type. The different join types are listed here, ordered from the best type to the worst:

- `system`

The table has only one row (= system table). This is a special case of the `const` join type.

- `const`

The table has at most one matching row, which is read at the start of the query. Because there is only one row, values from the column in this row can be regarded as constants by the rest of the optimizer. `const` tables are very fast because they are read only once.

`const` is used when you compare all parts of a `PRIMARY KEY` or `UNIQUE` index to constant values. In the following queries, `tbl_name` can be used as a `const` table:

```
SELECT * FROM tbl_name WHERE primary_key=1;
SELECT * FROM tbl_name
WHERE primary_key_part1=1 AND primary_key_part2=2;
```

- `eq_ref`

One row is read from this table for each combination of rows from the previous tables. Other than the `system` and `const` types, this is the best possible join type. It is used when all parts of an index are used by the join and the index is a `PRIMARY KEY` or `UNIQUE` index.

`eq_ref` can be used for indexed columns that are compared using the `=` operator. The comparison value can be a constant or an expression that uses columns from tables that are read before this table. In the following examples, MySQL can use an `eq_ref` join to process `ref_table`:

```
SELECT * FROM ref_table,other_table
WHERE ref_table.key_column=other_table.column;
SELECT * FROM ref_table,other_table
WHERE ref_table.key_column_part1=other_table.column
AND ref_table.key_column_part2=1;
```

- `ref`

All rows with matching index values are read from this table for each combination of rows from the previous tables. `ref` is used if the join uses only a leftmost prefix of the key or if the key is not a `PRIMARY KEY` or `UNIQUE` index (in other words, if the join cannot select a single row based on the key value). If the key that is used matches only a few rows, this is a good join type.

`ref` can be used for indexed columns that are compared using the `=` or `<=>` operator. In the following examples, MySQL can use a `ref` join to process `ref_table`:

```
SELECT * FROM ref_table WHERE key_column=expr;
SELECT * FROM ref_table,other_table
WHERE ref_table.key_column=other_table.column;
SELECT * FROM ref_table,other_table
WHERE ref_table.key_column_part1=other_table.column
AND ref_table.key_column_part2=1;
```

- `fulltext`

The join is performed using a `FULLTEXT` index.

- `ref_or_null`

This join type is like `ref`, but with the addition that MySQL does an extra search for rows that contain `NULL` values. This join type optimization is used most often in resolving subqueries. In the following examples, MySQL can use a `ref_or_null` join to process `ref_table`:

```
SELECT * FROM ref_table
WHERE key_column=expr OR key_column IS NULL;
```

See [Section 7.2.8, “IS NULL Optimization”](#).

- `index_merge`

This join type indicates that the Index Merge optimization is used. In this case, the `key` column in the output row contains a list of indexes used, and `key_len` contains a list of the longest key parts for the indexes used. For more information, see [Section 7.2.6, “Index Merge Optimization”](#).

- `unique_subquery`

This type replaces `ref` for some `IN` subqueries of the following form:

```
value IN (SELECT primary_key FROM single_table WHERE some_expr)
```

`unique_subquery` is just an index lookup function that replaces the subquery completely for better efficiency.

- `index_subquery`

This join type is similar to `unique_subquery`. It replaces `IN` subqueries, but it works for non-unique indexes in subqueries of the following form:

```
value IN (SELECT key_column FROM single_table WHERE some_expr)
```

- `range`

Only rows that are in a given range are retrieved, using an index to select the rows. The `key` column in the output row indicates which index is used. The `key_len` contains the longest key part that was used. The `ref` column is `NULL` for this type.

`range` can be used when a key column is compared to a constant using any of the `=`, `<>`, `>`, `>=`, `<`, `<=`, `IS NULL`, `<=>`, `BETWEEN`, or `IN()` operators:

```
SELECT * FROM tbl_name
  WHERE key_column = 10;

SELECT * FROM tbl_name
  WHERE key_column BETWEEN 10 and 20;

SELECT * FROM tbl_name
  WHERE key_column IN (10,20,30);

SELECT * FROM tbl_name
  WHERE key_part1= 10 AND key_part2 IN (10,20,30);
```

- `index`

This join type is the same as `ALL`, except that only the index tree is scanned. This usually is faster than `ALL` because the index file usually is smaller than the data file.

MySQL can use this join type when the query uses only columns that are part of a single index.

- `ALL`

A full table scan is done for each combination of rows from the previous tables. This is normally not good if the table is the first table not marked `const`, and usually *very* bad in all other cases. Normally, you can avoid `ALL` by adding indexes that allow row retrieval from the table based on constant values or column values from earlier tables.

- `possible_keys`

The `possible_keys` column indicates which indexes MySQL can choose from use to find the rows in this table. Note that this column is totally independent of the order of the tables as displayed in the output from `EXPLAIN`. That means that some of the keys in `possible_keys` might not be usable in practice with the generated table order.

If this column is `NULL`, there are no relevant indexes. In this case, you may be able to improve the performance of your query by examining the `WHERE` clause to check whether it refers to some column or columns that would be suitable for indexing. If so, create an appropriate index and check the query with `EXPLAIN` again. See [Section 12.1.7, “ALTER TABLE Syntax”](#).

To see what indexes a table has, use `SHOW INDEX FROM tbl_name`.

- `key`

The `key` column indicates the key (index) that MySQL actually decided to use. If MySQL decides to use one of the `possible_keys` indexes to look up rows, that index is listed as the `key` value.

It is possible that `key` will name an index that is not present in the `possible_keys` value. This can happen if none of the `possible_keys` indexes are suitable for looking up rows, but all the columns selected by the query are columns of some other index. That is, the named index covers the selected columns, so although it is not used to determine which rows to retrieve, an index scan is more efficient than a data row scan.

For `InnoDB`, a secondary index might cover the selected columns even if the query also selects the primary key because `InnoDB` stores the primary key value with each secondary index. If `key` is `NULL`, MySQL found no index to use for executing

the query more efficiently.

To force MySQL to use or ignore an index listed in the `possible_keys` column, use `FORCE INDEX`, `USE INDEX`, or `IGNORE INDEX` in your query. See [Section 12.2.8.2, “Index Hint Syntax”](#).

For `MyISAM` tables, running `ANALYZE TABLE` helps the optimizer choose better indexes. For `MyISAM` tables, `myisamchk --analyze` does the same. See [Section 12.5.2.1, “ANALYZE TABLE Syntax”](#), and [Section 6.4, “Table Maintenance and Crash Recovery”](#).

- `key_len`

The `key_len` column indicates the length of the key that MySQL decided to use. The length is `NULL` if the `key` column says `NULL`. Note that the value of `key_len` enables you to determine how many parts of a multiple-part key MySQL actually uses.

- `ref`

The `ref` column shows which columns or constants are compared to the index named in the `key` column to select rows from the table.

- `rows`

The `rows` column indicates the number of rows MySQL believes it must examine to execute the query.

For `InnoDB` tables, this number is an estimate, and may not always be exact.

- `filtered`

The `filtered` column indicates an estimated percentage of table rows that will be filtered by the table condition. That is, `rows` shows the estimated number of rows examined and `rows × filtered / 100` shows the number of rows that will be joined with previous tables. This column is displayed if you use `EXPLAIN EXTENDED`. (New in MySQL 5.1.12)

- `Extra`

This column contains additional information about how MySQL resolves the query. The following list explains the values that can appear in this column. If you want to make your queries as fast as possible, you should look out for `Extra` values of `Using filesort` and `Using temporary`.

- `Distinct`

MySQL is looking for distinct values, so it stops searching for more rows for the current row combination after it has found the first matching row.

- `Full scan on NULL key`

This occurs for subquery optimization as a fallback strategy when the optimizer cannot use an index-lookup access method.

- `Impossible WHERE noticed after reading const tables`

MySQL has read all `const` (and `system`) tables and notice that the `WHERE` clause is always false.

- `No tables`

The query has no `FROM` clause, or has a `FROM DUAL` clause.

- `Not exists`

MySQL was able to do a `LEFT JOIN` optimization on the query and does not examine more rows in this table for the previous row combination after it finds one row that matches the `LEFT JOIN` criteria. Here is an example of the type of query that can be optimized this way:

```
SELECT * FROM t1 LEFT JOIN t2 ON t1.id=t2.id
WHERE t2.id IS NULL;
```

Assume that `t2.id` is defined as `NOT NULL`. In this case, MySQL scans `t1` and looks up the rows in `t2` using the values of `t1.id`. If MySQL finds a matching row in `t2`, it knows that `t2.id` can never be `NULL`, and does not scan through the rest of the rows in `t2` that have the same `id` value. In other words, for each row in `t1`, MySQL needs to do only a single lookup in `t2`, regardless of how many rows actually match in `t2`.

- `Range checked for each record (index map: N)`

MySQL found no good index to use, but found that some of indexes might be used after column values from preceding

tables are known. For each row combination in the preceding tables, MySQL checks whether it is possible to use a `range` or `index_merge` access method to retrieve rows. This is not very fast, but is faster than performing a join with no index at all. The applicability criteria are as described in [Section 7.2.5, “Range Optimization”](#), and [Section 7.2.6, “Index Merge Optimization”](#), with the exception that all column values for the preceding table are known and considered to be constants.

Indexes are numbered beginning with 1, in the same order as shown by `SHOW INDEX` for the table. The index map value `N` is a bitmask value that indicates which indexes are candidates. For example, a value of `0x19` (binary 11001) means that indexes 1, 4, and 5 will be considered.

- `Scanned N databases`

This indicates how many directory scans the server performs when processing a query for `INFORMATION_SCHEMA` tables, as described in [Section 7.2.20, “INFORMATION\\_SCHEMA Optimization”](#). The value of `N` can be 0, 1, or `all`.

- `Select tables optimized away`

The query contained only aggregate functions (`MIN()`, `MAX()`) that were all resolved using an index, or `COUNT(*)` for `MyISAM`, and no `GROUP BY` clause. The optimizer determined that only one row should be returned.

- `Skip_open_table, Open_frm_only, Open_trigger_only, Open_full_table`

These values indicate file-opening optimizations that apply to queries for `INFORMATION_SCHEMA` tables, as described in [Section 7.2.20, “INFORMATION\\_SCHEMA Optimization”](#).

- `Skip_open_table`: Table files do not need to be opened. The information has already become available within the query by scanning the database directory.
- `Open_frm_only`: Only the table's `.frm` file need be opened.
- `Open_trigger_only`: Only the table's `.TRG` file need be opened.
- `Open_full_table`: The unoptimized information lookup. The `.frm`, `.MYD`, and `.MYI` files must be opened.

- `Using filesort`

MySQL must do an extra pass to find out how to retrieve the rows in sorted order. The sort is done by going through all rows according to the join type and storing the sort key and pointer to the row for all rows that match the `WHERE` clause. The keys then are sorted and the rows are retrieved in sorted order. See [Section 7.2.13, “ORDER BY Optimization”](#).

- `Using index`

The column information is retrieved from the table using only information in the index tree without having to do an additional seek to read the actual row. This strategy can be used when the query uses only columns that are part of a single index.

For `InnoDB` tables that have a user-defined clustered index, that index can be used even when `Using index` is absent from the `Extra` column. This is the case if `type` is `index` and `key` is `PRIMARY`.

- `Using index for group-by`

Similar to the `Using index` table access method, `Using index for group-by` indicates that MySQL found an index that can be used to retrieve all columns of a `GROUP BY` or `DISTINCT` query without any extra disk access to the actual table. Additionally, the index is used in the most efficient way so that for each group, only a few index entries are read. For details, see [Section 7.2.14, “GROUP BY Optimization”](#).

- `Using join buffer`

Tables from earlier joins are read in portions into the join buffer, and then their rows are used from the buffer to perform the join with the current table.

- `Using sort_union(...), Using union(...), Using intersect(...)`

These indicate how index scans are merged for the `index_merge` join type. See [Section 7.2.6, “Index Merge Optimization”](#).

- `Using temporary`

To resolve the query, MySQL needs to create a temporary table to hold the result. This typically happens if the query contains `GROUP BY` and `ORDER BY` clauses that list columns differently.

- [Using where](#)

A [WHERE](#) clause is used to restrict which rows to match against the next table or send to the client. Unless you specifically intend to fetch or examine all rows from the table, you may have something wrong in your query if the [Extra](#) value is not [Using where](#) and the table join type is [ALL](#) or [index](#).

- [Using where with pushed condition](#)

This item applies to [NDBCLUSTER](#) tables *only*. It means that MySQL Cluster is using the Condition Pushdown optimization to improve the efficiency of a direct comparison between a non-indexed column and a constant. In such cases, the condition is “pushed down” to the cluster’s data nodes and is evaluated on all data nodes simultaneously. This eliminates the need to send non-matching rows over the network, and can speed up such queries by a factor of 5 to 10 times over cases where Condition Pushdown could be but is not used. For more information, see [Section 7.2.7, “Condition Pushdown Optimization”](#).

You can get a good indication of how good a join is by taking the product of the values in the [rows](#) column of the [EXPLAIN](#) output. This should tell you roughly how many rows MySQL must examine to execute the query. If you restrict queries with the [max\\_join\\_size](#) system variable, this row product also is used to determine which multiple-table [SELECT](#) statements to execute and which to abort. See [Section 7.5.3, “Tuning Server Parameters”](#).

The following example shows how a multiple-table join can be optimized progressively based on the information provided by [EXPLAIN](#).

Suppose that you have the [SELECT](#) statement shown here and that you plan to examine it using [EXPLAIN](#):

```
EXPLAIN SELECT tt.TicketNumber, tt.TimeIn,
              tt.ProjectReference, tt.EstimatedShipDate,
              tt.ActualShipDate, tt.ClientID,
              tt.ServiceCodes, tt.RepetitiveID,
              tt.CurrentProcess, tt.CurrentDPPerson,
              tt.RecordVolume, tt.DPPrinted, et.COUNTRY,
              et_1.COUNTRY, do.CUSTNAME
FROM tt, et, et AS et_1, do
WHERE tt.SubmitTime IS NULL
      AND tt.ActualPC = et.EMPLOYID
      AND tt.AssignedPC = et_1.EMPLOYID
      AND tt.ClientID = do.CUSTNMBR;
```

For this example, make the following assumptions:

- The columns being compared have been declared as follows.

Table	Column	Data Type
tt	ActualPC	CHAR(10)
tt	AssignedPC	CHAR(10)
tt	ClientID	CHAR(10)
et	EMPLOYID	CHAR(15)
do	CUSTNMBR	CHAR(15)

- The tables have the following indexes.

Table	Index
tt	ActualPC
tt	AssignedPC
tt	ClientID
et	EMPLOYID (primary key)
do	CUSTNMBR (primary key)

- The `tt.ActualPC` values are not evenly distributed.

Initially, before any optimizations have been performed, the [EXPLAIN](#) statement produces the following information:

```
table type possible_keys key key_len ref rows Extra
```

et	ALL	PRIMARY	NULL	NULL	NULL	74	
do	ALL	PRIMARY	NULL	NULL	NULL	2135	
et_1	ALL	PRIMARY	NULL	NULL	NULL	74	
tt	ALL	AssignedPC, ClientID, ActualPC	NULL	NULL	NULL	3872	
Range checked for each record (index map: 0x23)							

Because `type` is `ALL` for each table, this output indicates that MySQL is generating a Cartesian product of all the tables; that is, every combination of rows. This takes quite a long time, because the product of the number of rows in each table must be examined. For the case at hand, this product is  $74 \times 2135 \times 74 \times 3872 = 45,268,558,720$  rows. If the tables were bigger, you can only imagine how long it would take.

One problem here is that MySQL can use indexes on columns more efficiently if they are declared as the same type and size. In this context, `VARCHAR` and `CHAR` are considered the same if they are declared as the same size. `tt.ActualPC` is declared as `CHAR(10)` and `et.EMPLOYID` is `CHAR(15)`, so there is a length mismatch.

To fix this disparity between column lengths, use `ALTER TABLE` to lengthen `ActualPC` from 10 characters to 15 characters:

```
mysql> ALTER TABLE tt MODIFY ActualPC VARCHAR(15);
```

Now `tt.ActualPC` and `et.EMPLOYID` are both `VARCHAR(15)`. Executing the `EXPLAIN` statement again produces this result:

table	type	possible_keys	key	key_len	ref	rows	Extra
tt	ALL	AssignedPC, ClientID, ActualPC	NULL	NULL	NULL	3872	Using where
do	ALL	PRIMARY	NULL	NULL	NULL	2135	
Range checked for each record (index map: 0x1)							
et_1	ALL	PRIMARY	NULL	NULL	NULL	74	
Range checked for each record (index map: 0x1)							
et	eq_ref	PRIMARY	PRIMARY	15	tt.ActualPC	1	

This is not perfect, but is much better: The product of the `rows` values is less by a factor of 74. This version executes in a couple of seconds.

A second alteration can be made to eliminate the column length mismatches for the `tt.AssignedPC = et_1.EMPLOYID` and `tt.ClientID = do.CUSTNMBR` comparisons:

```
mysql> ALTER TABLE tt MODIFY AssignedPC VARCHAR(15),
-> MODIFY ClientID VARCHAR(15);
```

After that modification, `EXPLAIN` produces the output shown here:

table	type	possible_keys	key	key_len	ref	rows	Extra
et	ALL	PRIMARY	NULL	NULL	NULL	74	
tt	ref	AssignedPC, ClientID, ActualPC	ActualPC	15	et.EMPLOYID	52	Using where
et_1	eq_ref	PRIMARY	PRIMARY	15	tt.AssignedPC	1	
do	eq_ref	PRIMARY	PRIMARY	15	tt.ClientID	1	

At this point, the query is optimized almost as well as possible. The remaining problem is that, by default, MySQL assumes that values in the `tt.ActualPC` column are evenly distributed, and that is not the case for the `tt` table. Fortunately, it is easy to tell MySQL to analyze the key distribution:

```
mysql> ANALYZE TABLE tt;
```

With the additional index information, the join is perfect and `EXPLAIN` produces this result:

table	type	possible_keys	key	key_len	ref	rows	Extra
tt	ALL	AssignedPC, ClientID, ActualPC	NULL	NULL	NULL	3872	Using where
et	eq_ref	PRIMARY	PRIMARY	15	tt.ActualPC	1	
et_1	eq_ref	PRIMARY	PRIMARY	15	tt.AssignedPC	1	
do	eq_ref	PRIMARY	PRIMARY	15	tt.ClientID	1	

Note that the `rows` column in the output from `EXPLAIN` is an educated guess from the MySQL join optimizer. You should check whether the numbers are even close to the truth by comparing the `rows` product with the actual number of rows that the query returns. If the numbers are quite different, you might get better performance by using `STRAIGHT_JOIN` in your `SELECT` statement and trying to list the tables in a different order in the `FROM` clause.

It is possible in some cases to execute statements that modify data when `EXPLAIN SELECT` is used with a subquery; for more in-



formation, see [Section 12.2.9.8, “Subqueries in the FROM clause”](#).

#### MySQL Enterprise

Subscribers to the MySQL Enterprise Monitor regularly receive expert advice on optimization. For more information, see <http://www.mysql.com/products/enterprise/advisors.html>.

## 7.2.2. Estimating Query Performance

In most cases, you can estimate query performance by counting disk seeks. For small tables, you can usually find a row in one disk seek (because the index is probably cached). For bigger tables, you can estimate that, using B-tree indexes, you need this many seeks to find a row:  $\log(\text{row\_count}) / \log(\text{index\_block\_length} / 3 \times 2 / (\text{index\_length} + \text{data\_pointer\_length})) + 1$ .

In MySQL, an index block is usually 1,024 bytes and the data pointer is usually four bytes. For a 500,000-row table with a key value length of three bytes (the size of `MEDIUMINT`), the formula indicates  $\log(500,000) / \log(1024/3 \times 2 / (3+4)) + 1 = 4$  seeks.

This index would require storage of about  $500,000 \times 7 \times 3/2 = 5.2\text{MB}$  (assuming a typical index buffer fill ratio of 2/3), so you probably have much of the index in memory and so need only one or two calls to read data to find the row.

For writes, however, you need four seek requests to find where to place a new index value and normally two seeks to update the index and write the row.

Note that the preceding discussion does not mean that your application performance slowly degenerates by  $\log N$ . As long as everything is cached by the OS or the MySQL server, things become only marginally slower as the table gets bigger. After the data gets too big to be cached, things start to go much slower until your applications are bound only by disk seeks (which increase by  $\log N$ ). To avoid this, increase the key cache size as the data grows. For `MyISAM` tables, the key cache size is controlled by the `key_buffer_size` system variable. See [Section 7.5.3, “Tuning Server Parameters”](#).

#### MySQL Enterprise

The MySQL Enterprise Monitor provides a number of advisors specifically designed to improve query performance. For more information, see <http://www.mysql.com/products/enterprise/advisors.html>.

## 7.2.3. Speed of `SELECT` Queries

In general, when you want to make a slow `SELECT ... WHERE` query faster, the first thing to check is whether you can add an index. All references between different tables should usually be done with indexes. You can use the `EXPLAIN` statement to determine which indexes are used for a `SELECT`. See [Section 7.2.1, “Optimizing Queries with EXPLAIN”](#), and [Section 7.4.4, “How MySQL Uses Indexes”](#).

Some general tips for speeding up queries on `MyISAM` tables:

- To help MySQL better optimize queries, use `ANALYZE TABLE` or run `myisamchk --analyze` on a table after it has been loaded with data. This updates a value for each index part that indicates the average number of rows that have the same value. (For unique indexes, this is always 1.) MySQL uses this to decide which index to choose when you join two tables based on a non-constant expression. You can check the result from the table analysis by using `SHOW INDEX FROM tbl_name` and examining the `Cardinality` value. `myisamchk --description --verbose` shows index distribution information.
- To sort an index and data according to an index, use `myisamchk --sort-index --sort-records=1` (assuming that you want to sort on index 1). This is a good way to make queries faster if you have a unique index from which you want to read all rows in order according to the index. The first time you sort a large table this way, it may take a long time.

## 7.2.4. `WHERE` Clause Optimization

This section discusses optimizations that can be made for processing `WHERE` clauses. The examples use `SELECT` statements, but the same optimizations apply for `WHERE` clauses in `DELETE` and `UPDATE` statements.

Work on the MySQL optimizer is ongoing, so this section is incomplete. MySQL performs a great many optimizations, not all of which are documented here.

Some of the optimizations performed by MySQL follow:

- Removal of unnecessary parentheses:

```
((a AND b) AND c OR ((a AND b) AND (c AND d)))
-> (a AND b AND c) OR (a AND b AND c AND d)
```



- Constant folding:

```
(a<b AND b=c) AND a=5
-> b>5 AND b=c AND a=5
```

- Constant condition removal (needed because of constant folding):

```
(B>=5 AND B=5) OR (B=6 AND 5=5) OR (B=7 AND 5=6)
-> B=5 OR B=6
```

- Constant expressions used by indexes are evaluated only once.
- `COUNT(*)` on a single table without a `WHERE` is retrieved directly from the table information for `MyISAM` and `MEMORY` tables. This is also done for any `NOT NULL` expression when used with only one table.
- Early detection of invalid constant expressions. MySQL quickly detects that some `SELECT` statements are impossible and returns no rows.
- `HAVING` is merged with `WHERE` if you do not use `GROUP BY` or aggregate functions (`COUNT()`, `MIN()`, and so on).
- For each table in a join, a simpler `WHERE` is constructed to get a fast `WHERE` evaluation for the table and also to skip rows as soon as possible.
- All constant tables are read first before any other tables in the query. A constant table is any of the following:
  - An empty table or a table with one row.
  - A table that is used with a `WHERE` clause on a `PRIMARY KEY` or a `UNIQUE` index, where all index parts are compared to constant expressions and are defined as `NOT NULL`.

All of the following tables are used as constant tables:

```
SELECT * FROM t WHERE primary_key=1;
SELECT * FROM t1,t2
WHERE t1.primary_key=1 AND t2.primary_key=t1.id;
```

- The best join combination for joining the tables is found by trying all possibilities. If all columns in `ORDER BY` and `GROUP BY` clauses come from the same table, that table is preferred first when joining.
- If there is an `ORDER BY` clause and a different `GROUP BY` clause, or if the `ORDER BY` or `GROUP BY` contains columns from tables other than the first table in the join queue, a temporary table is created.
- If you use the `SQL_SMALL_RESULT` option, MySQL uses an in-memory temporary table.
- Each table index is queried, and the best index is used unless the optimizer believes that it is more efficient to use a table scan. At one time, a scan was used based on whether the best index spanned more than 30% of the table, but a fixed percentage no longer determines the choice between using an index or a scan. The optimizer now is more complex and bases its estimate on additional factors such as table size, number of rows, and I/O block size.
- In some cases, MySQL can read rows from the index without even consulting the data file. If all columns used from the index are numeric, only the index tree is used to resolve the query.
- Before each row is output, those that do not match the `HAVING` clause are skipped.

Some examples of queries that are very fast:

```
SELECT COUNT(*) FROM tbl_name;
SELECT MIN(key_part1),MAX(key_part1) FROM tbl_name;
SELECT MAX(key_part2) FROM tbl_name
WHERE key_part1=constant;
SELECT ... FROM tbl_name
ORDER BY key_part1,key_part2,... LIMIT 10;
SELECT ... FROM tbl_name
ORDER BY key_part1 DESC, key_part2 DESC, ... LIMIT 10;
```

MySQL resolves the following queries using only the index tree, assuming that the indexed columns are numeric:

```
SELECT key_part1,key_part2 FROM tbl_name WHERE key_part1=val;
SELECT COUNT(*) FROM tbl_name
```

```
WHERE key_part1=val1 AND key_part2=val2;
SELECT key_part2 FROM tbl_name GROUP BY key_part1;
```

The following queries use indexing to retrieve the rows in sorted order without a separate sorting pass:

```
SELECT ... FROM tbl_name
ORDER BY key_part1,key_part2,... ;

SELECT ... FROM tbl_name
ORDER BY key_part1 DESC, key_part2 DESC, ... ;
```

## 7.2.5. Range Optimization

The [range](#) access method uses a single index to retrieve a subset of table rows that are contained within one or several index value intervals. It can be used for a single-part or multiple-part index. The following sections give a detailed description of how intervals are extracted from the [WHERE](#) clause.

### 7.2.5.1. The Range Access Method for Single-Part Indexes

For a single-part index, index value intervals can be conveniently represented by corresponding conditions in the [WHERE](#) clause, so we speak of *range conditions* rather than “intervals.”

The definition of a range condition for a single-part index is as follows:

- For both [BTREE](#) and [HASH](#) indexes, comparison of a key part with a constant value is a range condition when using the [=](#), [<=>](#), [IN\(\)](#), [IS NULL](#), or [IS NOT NULL](#) operators.
- For [BTREE](#) indexes, comparison of a key part with a constant value is a range condition when using the [>](#), [<](#), [>=](#), [<=](#), [BETWEEN](#), [!=](#), or [<>](#) operators, or [LIKE](#) comparisons if the argument to [LIKE](#) is a constant string that does not start with a wildcard character.
- For all types of indexes, multiple range conditions combined with [OR](#) or [AND](#) form a range condition.

“Constant value” in the preceding descriptions means one of the following:

- A constant from the query string
- A column of a [const](#) or [system](#) table from the same join
- The result of an uncorrelated subquery
- Any expression composed entirely from subexpressions of the preceding types

Here are some examples of queries with range conditions in the [WHERE](#) clause:

```
SELECT * FROM t1
WHERE key_col > 1
AND key_col < 10;

SELECT * FROM t1
WHERE key_col = 1
OR key_col IN (15,18,20);

SELECT * FROM t1
WHERE key_col LIKE 'ab%'
OR key_col BETWEEN 'bar' AND 'foo';
```

Note that some non-constant values may be converted to constants during the constant propagation phase.

MySQL tries to extract range conditions from the [WHERE](#) clause for each of the possible indexes. During the extraction process, conditions that cannot be used for constructing the range condition are dropped, conditions that produce overlapping ranges are combined, and conditions that produce empty ranges are removed.

Consider the following statement, where [key1](#) is an indexed column and [nonkey](#) is not indexed:

```
SELECT * FROM t1 WHERE
(key1 < 'abc' AND (key1 LIKE 'abcde%' OR key1 LIKE '%b')) OR
(key1 < 'bar' AND nonkey = 4) OR
(key1 < 'uux' AND key1 > 'z');
```

The extraction process for key `key1` is as follows:

1. Start with original `WHERE` clause:

```
(key1 < 'abc' AND (key1 LIKE 'abcde%' OR key1 LIKE '%b')) OR
(key1 < 'bar' AND nonkey = 4) OR
(key1 < 'uux' AND key1 > 'z')
```

2. Remove `nonkey = 4` and `key1 LIKE '%b'` because they cannot be used for a range scan. The correct way to remove them is to replace them with `TRUE`, so that we do not miss any matching rows when doing the range scan. Having replaced them with `TRUE`, we get:

```
(key1 < 'abc' AND (key1 LIKE 'abcde%' OR TRUE)) OR
(key1 < 'bar' AND TRUE) OR
(key1 < 'uux' AND key1 > 'z')
```

3. Collapse conditions that are always true or false:

- `(key1 LIKE 'abcde%' OR TRUE)` is always true
- `(key1 < 'uux' AND key1 > 'z')` is always false

Replacing these conditions with constants, we get:

```
(key1 < 'abc' AND TRUE) OR (key1 < 'bar' AND TRUE) OR (FALSE)
```

Removing unnecessary `TRUE` and `FALSE` constants, we obtain:

```
(key1 < 'abc') OR (key1 < 'bar')
```

4. Combining overlapping intervals into one yields the final condition to be used for the range scan:

```
(key1 < 'bar')
```

In general (and as demonstrated by the preceding example), the condition used for a range scan is less restrictive than the `WHERE` clause. MySQL performs an additional check to filter out rows that satisfy the range condition but not the full `WHERE` clause.

The range condition extraction algorithm can handle nested `AND/OR` constructs of arbitrary depth, and its output does not depend on the order in which conditions appear in `WHERE` clause.

Currently, MySQL does not support merging multiple ranges for the `range` access method for spatial indexes. To work around this limitation, you can use a `UNION` with identical `SELECT` statements, except that you put each spatial predicate in a different `SELECT`.

## 7.2.5.2. The Range Access Method for Multiple-Part Indexes

Range conditions on a multiple-part index are an extension of range conditions for a single-part index. A range condition on a multiple-part index restricts index rows to lie within one or several key tuple intervals. Key tuple intervals are defined over a set of key tuples, using ordering from the index.

For example, consider a multiple-part index defined as `key1(key_part1, key_part2, key_part3)`, and the following set of key tuples listed in key order:

<code>key_part1</code>	<code>key_part2</code>	<code>key_part3</code>
NULL	1	'abc'
NULL	1	'xyz'
NULL	2	'foo'
1	1	'abc'
1	1	'xyz'
1	2	'abc'
2	1	'aaa'

The condition `key_part1 = 1` defines this interval:

```
(1, -inf, -inf) <= (key_part1, key_part2, key_part3) < (1, +inf, +inf)
```

The interval covers the 4th, 5th, and 6th tuples in the preceding data set and can be used by the range access method.

By contrast, the condition `key_part3 = 'abc'` does not define a single interval and cannot be used by the range access meth-

od.

The following descriptions indicate how range conditions work for multiple-part indexes in greater detail.

- For **HASH** indexes, each interval containing identical values can be used. This means that the interval can be produced only for conditions in the following form:

```
key_part1 cmp const1
AND key_part2 cmp const2
AND ...
AND key_partN cmp constN;
```

Here, *const1*, *const2*, ... are constants, *cmp* is one of the =, <=>, or **IS NULL** comparison operators, and the conditions cover all index parts. (That is, there are *N* conditions, one for each part of an *N*-part index.) For example, the following is a range condition for a three-part **HASH** index:

```
key_part1 = 1 AND key_part2 IS NULL AND key_part3 = 'foo'
```

For the definition of what is considered to be a constant, see [Section 7.2.5.1, “The Range Access Method for Single-Part Indexes”](#).

- For a **BTREE** index, an interval might be usable for conditions combined with **AND**, where each condition compares a key part with a constant value using =, <=>, **IS NULL**, >, <, >=, <=, !=, <>, **BETWEEN**, or **LIKE** '*pattern*' (where '*pattern*' does not start with a wildcard). An interval can be used as long as it is possible to determine a single key tuple containing all rows that match the condition (or two intervals if <> or != is used). For example, for this condition:

```
key_part1 = 'foo' AND key_part2 >= 10 AND key_part3 > 10
```

The single interval is:

```
('foo',10,10) < (key_part1,key_part2,key_part3) < ('foo',+inf,+inf)
```

It is possible that the created interval contains more rows than the initial condition. For example, the preceding interval includes the value ('foo', 11, 0), which does not satisfy the original condition.

- If conditions that cover sets of rows contained within intervals are combined with **OR**, they form a condition that covers a set of rows contained within the union of their intervals. If the conditions are combined with **AND**, they form a condition that covers a set of rows contained within the intersection of their intervals. For example, for this condition on a two-part index:

```
(key_part1 = 1 AND key_part2 < 2) OR (key_part1 > 5)
```

The intervals are:

```
(1,-inf) < (key_part1,key_part2) < (1,2)
(5,-inf) < (key_part1,key_part2)
```

In this example, the interval on the first line uses one key part for the left bound and two key parts for the right bound. The interval on the second line uses only one key part. The *key\_len* column in the **EXPLAIN** output indicates the maximum length of the key prefix used.

In some cases, *key\_len* may indicate that a key part was used, but that might be not what you would expect. Suppose that *key\_part1* and *key\_part2* can be **NULL**. Then the *key\_len* column displays two key part lengths for the following condition:

```
key_part1 >= 1 AND key_part2 < 2
```

But, in fact, the condition is converted to this:

```
key_part1 >= 1 AND key_part2 IS NOT NULL
```

[Section 7.2.5.1, “The Range Access Method for Single-Part Indexes”](#), describes how optimizations are performed to combine or eliminate intervals for range conditions on a single-part index. Analogous steps are performed for range conditions on multiple-part indexes.

## 7.2.6. Index Merge Optimization

The *Index Merge* method is used to retrieve rows with several **range** scans and to merge their results into one. The merge can pro-

duce unions, intersections, or unions-of-intersections of its underlying scans. This access method merges index scans from a single table; it does not merge scans across multiple tables.

In `EXPLAIN` output, the Index Merge method appears as `index_merge` in the `type` column. In this case, the `key` column contains a list of indexes used, and `key_len` contains a list of the longest key parts for those indexes.

Examples:

```
SELECT * FROM tbl_name WHERE key1 = 10 OR key2 = 20;

SELECT * FROM tbl_name
  WHERE (key1 = 10 OR key2 = 20) AND non_key=30;

SELECT * FROM t1, t2
  WHERE (t1.key1 IN (1,2) OR t1.key2 LIKE 'value%')
  AND t2.key1=t1.some_col;

SELECT * FROM t1, t2
  WHERE t1.key1=1
  AND (t2.key1=t1.some_col OR t2.key2=t1.some_col2);
```

The Index Merge method has several access algorithms (seen in the `Extra` field of `EXPLAIN` output):

- Using `intersect(...)`
- Using `union(...)`
- Using `sort_union(...)`

The following sections describe these methods in greater detail.

### Note

The Index Merge optimization algorithm has the following known deficiencies:

- If a range scan is possible on some key, the optimizer will not consider using Index Merge Union or Index Merge Sort-Union algorithms. For example, consider this query:

```
SELECT * FROM t1 WHERE (goodkey1 < 10 OR goodkey2 < 20) AND badkey < 30;
```

For this query, two plans are possible:

- An Index Merge scan using the `(goodkey1 < 10 OR goodkey2 < 20)` condition.
- A range scan using the `badkey < 30` condition.

However, the optimizer considers only the second plan.

- If your query has a complex `WHERE` clause with deep `AND/OR` nesting and MySQL doesn't choose the optimal plan, try distributing terms using the following identity laws:

```
(x AND y) OR z = (x OR z) AND (y OR z)
(x OR y) AND z = (x AND z) OR (y AND z)
```

- Index Merge is not applicable to fulltext indexes. We plan to extend it to cover these in a future MySQL release.

The choice between different possible variants of the Index Merge access method and other access methods is based on cost estimates of various available options.

## 7.2.6.1. The Index Merge Intersection Access Algorithm

This access algorithm can be employed when a `WHERE` clause was converted to several range conditions on different keys combined with `AND`, and each condition is one of the following:

- In this form, where the index has exactly `N` parts (that is, all index parts are covered):

```
key_part1=const1 AND key_part2=const2 ... AND key_partN=constN
```

- Any range condition over a primary key of an `InnoDB` table.

Examples:

```
SELECT * FROM innodb_table WHERE primary_key < 10 AND key_coll=20;
SELECT * FROM tbl_name
WHERE (key1_part1=1 AND key1_part2=2) AND key2=2;
```

The Index Merge intersection algorithm performs simultaneous scans on all used indexes and produces the intersection of row sequences that it receives from the merged index scans.

If all columns used in the query are covered by the used indexes, full table rows are not retrieved (`EXPLAIN` output contains `Using index` in `Extra` field in this case). Here is an example of such a query:

```
SELECT COUNT(*) FROM t1 WHERE key1=1 AND key2=1;
```

If the used indexes don't cover all columns used in the query, full rows are retrieved only when the range conditions for all used keys are satisfied.

If one of the merged conditions is a condition over a primary key of an `InnoDB` table, it is not used for row retrieval, but is used to filter out rows retrieved using other conditions.

### 7.2.6.2. The Index Merge Union Access Algorithm

The applicability criteria for this algorithm are similar to those for the Index Merge method intersection algorithm. The algorithm can be employed when the table's `WHERE` clause was converted to several range conditions on different keys combined with `OR`, and each condition is one of the following:

- In this form, where the index has exactly *N* parts (that is, all index parts are covered):

```
key_part1=const1 AND key_part2=const2 ... AND key_partN=constN
```

- Any range condition over a primary key of an `InnoDB` table.
- A condition for which the Index Merge method intersection algorithm is applicable.

Examples:

```
SELECT * FROM t1 WHERE key1=1 OR key2=2 OR key3=3;
SELECT * FROM innodb_table WHERE (key1=1 AND key2=2) OR
(key3='foo' AND key4='bar') AND key5=5;
```

### 7.2.6.3. The Index Merge Sort-Union Access Algorithm

This access algorithm is employed when the `WHERE` clause was converted to several range conditions combined by `OR`, but for which the Index Merge method union algorithm is not applicable.

Examples:

```
SELECT * FROM tbl_name WHERE key_coll < 10 OR key_coll2 < 20;
SELECT * FROM tbl_name
WHERE (key_coll > 10 OR key_coll2 = 20) AND nonkey_col=30;
```

The difference between the sort-union algorithm and the union algorithm is that the sort-union algorithm must first fetch row IDs for all rows and sort them before returning any rows.

## 7.2.7. Condition Pushdown Optimization

This optimization improves the efficiency of a direct comparison between a non-indexed column and a constant. In such cases, the condition is “pushed down” to the storage engine for evaluation. In MySQL 5.1, this optimization can be used only by the `NDB-CLUSTER` storage engine, but we intend to implement it for additional storage engines in future versions of MySQL.

For MySQL Cluster this optimization can eliminate the need to send non-matching rows over the network between the cluster's data nodes and the MySQL Server that issued the query, and can speed up queries where it is used by a factor of 5 to 10 times over cases where condition pushdown could be but is not used.

Suppose that a MySQL Cluster table is defined as follows:

```
CREATE TABLE t1 (
  a INT,
  b INT,
  KEY(a)
) ENGINE=NDBCLUSTER;
```

Condition pushdown can be used with a query against this table such as the query shown here:

```
SELECT a,b FROM t1 WHERE b = 10;
```

This can be seen in the output of `EXPLAIN SELECT`:

```
mysql> EXPLAIN SELECT a,b FROM t1 WHERE b = 10\G
***** 1. row *****
      id: 1
    select_type: SIMPLE
      table: t1
       type: ALL
possible_keys: NULL
      key: NULL
     key_len: NULL
       ref: NULL
      rows: 10
  Extra: Using where with pushed condition
```

However, condition pushdown *cannot* be used with either of these two queries:

```
SELECT a,b FROM t1 WHERE a = 10;
SELECT a,b FROM t1 WHERE b + 1 = 10;
```

With regard to the first of these two queries, condition pushdown is not applicable because an index exists on column `a`. (An index access method would be more efficient and so would be chosen in preference to condition pushdown.) In the case of the second query, condition pushdown cannot be employed because the comparison involving the non-indexed column `b` is indirect. (However, condition pushdown could be applied if you were to reduce `b + 1 = 10` to `b = 9` in the `WHERE` clause.)

Condition pushdown may also be employed when an indexed column is compared with a constant using a `>` or `<` operator:

```
mysql> EXPLAIN SELECT a,b FROM t1 WHERE a<2\G
***** 1. row *****
      id: 1
    select_type: SIMPLE
      table: t1
       type: range
possible_keys: a
      key: a
     key_len: 5
       ref: NULL
      rows: 2
  Extra: Using where with pushed condition
```

Other comparisons which are supported for condition pushdown include the following:

- `column [NOT] LIKE pattern`  
`pattern` must be a string literal containing the pattern to be matched; for syntax, see [Section 11.4.1, “String Comparison Functions”](#).
- `column IS [NOT] NULL`
- `column IN (value_list)`  
 Each item in the `value_list` must be a constant, literal value.
- `column BETWEEN constant1 AND constant2`  
`constant1` and `constant2` must each be a constant, literal value.

In all of the cases in the preceding list, it is possible for the condition to be converted into the form of one or more direct comparisons between a column and a constant.

Condition pushdown capability is not used by default. To enable it, you can start `mysqld` with the `-engine-condition-pushdown` option, or you can execute either of the following statements at runtime:

```
SET engine_condition_pushdown=ON;
```

```
SET engine_condition_pushdown=1;
```

**Limitations.** Condition pushdown is subject to the following limitations:

- In MySQL 5.1, condition pushdown is supported by the `NDBCLUSTER` storage engine only.
- Columns may be compared with constants only; however, this includes expressions which evaluate to constant values.
- Columns used in comparisons cannot be of any of the `BLOB` or `TEXT` types.
- A string value to be compared with a column must use the same collation as the column.
- Joins are not directly supported; conditions involving multiple tables are pushed separately where possible. Use `EXPLAIN EXTENDED` to determine which conditions are actually pushed down.

## 7.2.8. IS NULL Optimization

MySQL can perform the same optimization on `col_name IS NULL` that it can use for `col_name = constant_value`. For example, MySQL can use indexes and ranges to search for `NULL` with `IS NULL`.

Examples:

```
SELECT * FROM tbl_name WHERE key_col IS NULL;
SELECT * FROM tbl_name WHERE key_col <=> NULL;
SELECT * FROM tbl_name
WHERE key_col=const1 OR key_col=const2 OR key_col IS NULL;
```

If a `WHERE` clause includes a `col_name IS NULL` condition for a column that is declared as `NOT NULL`, that expression is optimized away. This optimization does not occur in cases when the column might produce `NULL` anyway; for example, if it comes from a table on the right side of a `LEFT JOIN`.

MySQL can also optimize the combination `col_name = expr OR col_name IS NULL`, a form that is common in resolved subqueries. `EXPLAIN` shows `ref_or_null` when this optimization is used.

This optimization can handle one `IS NULL` for any key part.

Some examples of queries that are optimized, assuming that there is an index on columns `a` and `b` of table `t2`:

```
SELECT * FROM t1 WHERE t1.a=expr OR t1.a IS NULL;
SELECT * FROM t1, t2 WHERE t1.a=t2.a OR t2.a IS NULL;
SELECT * FROM t1, t2
WHERE (t1.a=t2.a OR t2.a IS NULL) AND t2.b=t1.b;
SELECT * FROM t1, t2
WHERE t1.a=t2.a AND (t2.b=t1.b OR t2.b IS NULL);
SELECT * FROM t1, t2
WHERE (t1.a=t2.a AND t2.a IS NULL AND ...)
OR (t1.a=t2.a AND t2.a IS NULL AND ...);
```

`ref_or_null` works by first doing a read on the reference key, and then a separate search for rows with a `NULL` key value.

Note that the optimization can handle only one `IS NULL` level. In the following query, MySQL uses key lookups only on the expression `(t1.a=t2.a AND t2.a IS NULL)` and is not able to use the key part on `b`:

```
SELECT * FROM t1, t2
WHERE (t1.a=t2.a AND t2.a IS NULL)
OR (t1.b=t2.b AND t2.b IS NULL);
```

## 7.2.9. LEFT JOIN and RIGHT JOIN Optimization

MySQL implements an `A LEFT JOIN B join_condition` as follows:

- Table `B` is set to depend on table `A` and all tables on which `A` depends.
- Table `A` is set to depend on all tables (except `B`) that are used in the `LEFT JOIN` condition.



- The `LEFT JOIN` condition is used to decide how to retrieve rows from table `B`. (In other words, any condition in the `WHERE` clause is not used.)
- All standard join optimizations are performed, with the exception that a table is always read after all tables on which it depends. If there is a circular dependence, MySQL issues an error.
- All standard `WHERE` optimizations are performed.
- If there is a row in `A` that matches the `WHERE` clause, but there is no row in `B` that matches the `ON` condition, an extra `B` row is generated with all columns set to `NULL`.
- If you use `LEFT JOIN` to find rows that do not exist in some table and you have the following test: `col_name IS NULL` in the `WHERE` part, where `col_name` is a column that is declared as `NOT NULL`, MySQL stops searching for more rows (for a particular key combination) after it has found one row that matches the `LEFT JOIN` condition.

The implementation of `RIGHT JOIN` is analogous to that of `LEFT JOIN` with the roles of the tables reversed.

The join optimizer calculates the order in which tables should be joined. The table read order forced by `LEFT JOIN` or `STRAIGHT_JOIN` helps the join optimizer do its work much more quickly, because there are fewer table permutations to check. Note that this means that if you do a query of the following type, MySQL does a full scan on `b` because the `LEFT JOIN` forces it to be read before `d`:

```
SELECT *
FROM a JOIN b LEFT JOIN c ON (c.key=a.key)
LEFT JOIN d ON (d.key=a.key)
WHERE b.key=d.key;
```

The fix in this case is reverse the order in which `a` and `b` are listed in the `FROM` clause:

```
SELECT *
FROM b JOIN a LEFT JOIN c ON (c.key=a.key)
LEFT JOIN d ON (d.key=a.key)
WHERE b.key=d.key;
```

For a `LEFT JOIN`, if the `WHERE` condition is always false for the generated `NULL` row, the `LEFT JOIN` is changed to a normal join. For example, the `WHERE` clause would be false in the following query if `t2.column1` were `NULL`:

```
SELECT * FROM t1 LEFT JOIN t2 ON (column1) WHERE t2.column2=5;
```

Therefore, it is safe to convert the query to a normal join:

```
SELECT * FROM t1, t2 WHERE t2.column2=5 AND t1.column1=t2.column1;
```

This can be made faster because MySQL can use table `t2` before table `t1` if doing so would result in a better query plan. To provide a hint about the table join order, use `STRAIGHT_JOIN`. (See [Section 12.2.8, “SELECT Syntax”](#).)

## 7.2.10. Nested-Loop Join Algorithms

MySQL executes joins between tables using a nested-loop algorithm or variations on it.

### Nested-Loop Join Algorithm

A simple nested-loop join (NLJ) algorithm reads rows from the first table in a loop one at a time, passing each row to a nested loop that processes the next table in the join. This process is repeated as many times as there remain tables to be joined.

Assume that a join between three tables `t1`, `t2`, and `t3` is to be executed using the following join types:

Table	Join Type
t1	range
t2	ref
t3	ALL

If a simple NLJ algorithm is used, the join would be processed like this:

```
for each row in t1 matching range {
  for each row in t2 matching reference key {
    for each row in t3 {
      if row satisfies join conditions,
        send to client
    }
  }
}
```

Because the NLJ algorithm passes rows one at a time from outer loops to inner loops, tables processed in the inner loops typically are read many times.

### Block Nested-Loop Join Algorithm

A Block Nested-Loop (BNL) Join algorithm uses buffering of rows read in outer loops to reduce the number of times that tables in inner loops must be read. For example, if 10 rows are read into a buffer and the buffer is passed to the next inner loop, each row read in the inner loop can be compared against all 10 rows in the buffer. This reduces the number of times the inner table must be read by an order of magnitude.

MySQL uses join buffering under these conditions:

- The `join_buffer_size` system variable determines the size of each join buffer.
- Join buffering can be used when the join is of type `ALL` or `index` (in other words, when no possible keys can be used, and a full scan is done, of either the data or index rows, respectively), or `range`.
- One buffer is allocated for each join that can be buffered, so a given query might be processed using multiple join buffers.
- A join buffer is never allocated for the first non-const table, even if it would be of type `ALL` or `index`.
- A join buffer is allocated prior to executing the join and freed after the query is done.
- Only columns of interest to the join are stored in the join buffer, not whole rows.

For the example join described previously for the NLJ algorithm (without buffering), the join would be done as follows using join buffering:

```
for each row in t1 matching range {
  for each row in t2 matching reference key {
    store used columns from t1, t2 in join buffer
    if buffer is full {
      for each row in t3 {
        for each t1, t2 combination in join buffer {
          if row satisfies join conditions,
            send to client
        }
      }
      empty buffer
    }
  }
}

if buffer is not empty {
  for each row in t3 {
    for each t1, t2 combination in join buffer {
      if row satisfies join conditions,
        send to client
    }
  }
}
```

If  $S$  is the size of each stored `t1, t2` combination in the join buffer and  $C$  is the number of combinations in the buffer, the number of times table `t3` is scanned is:

$$(S * C) / \text{join\_buffer\_size} + 1$$

One implication is that the number of `t3` scans decreases as the value of `join_buffer_size` increases, up to the point when `join_buffer_size` is large enough to hold all previous row combinations. At that point, there is no speed to be gained by making it larger.

## 7.2.11. Nested Join Optimization

The syntax for expressing joins allows nested joins. The following discussion refers to the join syntax described in [Section 12.2.8.1, “JOIN Syntax”](#).

The syntax of `table_factor` is extended in comparison with the SQL Standard. The latter accepts only `table_reference`, not a list of them inside a pair of parentheses. This is a conservative extension if we consider each comma in a list of `table_reference` items as equivalent to an inner join. For example:

```
SELECT * FROM t1 LEFT JOIN (t2, t3, t4)
ON (t2.a=t1.a AND t3.b=t1.b AND t4.c=t1.c)
```

is equivalent to:

```
SELECT * FROM t1 LEFT JOIN (t2 CROSS JOIN t3 CROSS JOIN t4)
ON (t2.a=t1.a AND t3.b=t1.b AND t4.c=t1.c)
```

In MySQL, `CROSS JOIN` is a syntactic equivalent to `INNER JOIN` (they can replace each other). In standard SQL, they are not equivalent. `INNER JOIN` is used with an `ON` clause; `CROSS JOIN` is used otherwise.

In general, parentheses can be ignored in join expressions containing only inner join operations. After removing parentheses and grouping operations to the left, the join expression:

```
t1 LEFT JOIN (t2 LEFT JOIN t3 ON t2.b=t3.b OR t2.b IS NULL)
ON t1.a=t2.a
```

transforms into the expression:

```
(t1 LEFT JOIN t2 ON t1.a=t2.a) LEFT JOIN t3
ON t2.b=t3.b OR t2.b IS NULL
```

Yet, the two expressions are not equivalent. To see this, suppose that the tables `t1`, `t2`, and `t3` have the following state:

- Table `t1` contains rows (1), (2)
- Table `t2` contains row (1,101)
- Table `t3` contains row (101)

In this case, the first expression returns a result set including the rows (1,1,101,101), (2,NULL,NULL,NULL), whereas the second expression returns the rows (1,1,101,101), (2,NULL,NULL,101):

```
mysql> SELECT *
-> FROM t1
-> LEFT JOIN
-> (t2 LEFT JOIN t3 ON t2.b=t3.b OR t2.b IS NULL)
-> ON t1.a=t2.a;
+----+----+----+----+
| a  | a  | b  | b  |
+----+----+----+----+
| 1  | 1  | 101| 101|
| 2  | NULL| NULL| NULL|
+----+----+----+----+

mysql> SELECT *
-> FROM (t1 LEFT JOIN t2 ON t1.a=t2.a)
-> LEFT JOIN t3
-> ON t2.b=t3.b OR t2.b IS NULL;
+----+----+----+----+
| a  | a  | b  | b  |
+----+----+----+----+
| 1  | 1  | 101| 101|
| 2  | NULL| NULL| 101|
+----+----+----+----+
```

In the following example, an outer join operation is used together with an inner join operation:

```
t1 LEFT JOIN (t2, t3) ON t1.a=t2.a
```

That expression cannot be transformed into the following expression:

```
t1 LEFT JOIN t2 ON t1.a=t2.a, t3.
```

For the given table states, the two expressions return different sets of rows:

```
mysql> SELECT *
-> FROM t1 LEFT JOIN (t2, t3) ON t1.a=t2.a;
+----+----+----+----+
| a  | a  | b  | b  |
+----+----+----+----+
| 1  | 1  | 101| 101|
| 2  | NULL| NULL| NULL|
+----+----+----+----+

mysql> SELECT *
-> FROM t1 LEFT JOIN t2 ON t1.a=t2.a, t3;
+----+----+----+----+
| a  | a  | b  | b  |
+----+----+----+----+
```

1	1	101	101
2	NULL	NULL	101

Therefore, if we omit parentheses in a join expression with outer join operators, we might change the result set for the original expression.

More exactly, we cannot ignore parentheses in the right operand of the left outer join operation and in the left operand of a right join operation. In other words, we cannot ignore parentheses for the inner table expressions of outer join operations. Parentheses for the other operand (operand for the outer table) can be ignored.

The following expression:

```
(t1,t2) LEFT JOIN t3 ON P(t2.b,t3.b)
```

is equivalent to this expression:

```
t1, t2 LEFT JOIN t3 ON P(t2.b,t3.b)
```

for any tables *t1, t2, t3* and any condition *P* over attributes *t2.b* and *t3.b*.

Whenever the order of execution of the join operations in a join expression (*join\_table*) is not from left to right, we talk about nested joins. Consider the following queries:

```
SELECT * FROM t1 LEFT JOIN (t2 LEFT JOIN t3 ON t2.b=t3.b) ON t1.a=t2.a
WHERE t1.a > 1

SELECT * FROM t1 LEFT JOIN (t2, t3) ON t1.a=t2.a
WHERE (t2.b=t3.b OR t2.b IS NULL) AND t1.a > 1
```

Those queries are considered to contain these nested joins:

```
t2 LEFT JOIN t3 ON t2.b=t3.b
t2, t3
```

The nested join is formed in the first query with a left join operation, whereas in the second query it is formed with an inner join operation.

In the first query, the parentheses can be omitted: The grammatical structure of the join expression will dictate the same order of execution for join operations. For the second query, the parentheses cannot be omitted, although the join expression here can be interpreted unambiguously without them. (In our extended syntax the parentheses in *(t2, t3)* of the second query are required, although theoretically the query could be parsed without them: We still would have unambiguous syntactical structure for the query because **LEFT JOIN** and **ON** would play the role of the left and right delimiters for the expression *(t2, t3)*.)

The preceding examples demonstrate these points:

- For join expressions involving only inner joins (and not outer joins), parentheses can be removed. You can remove parentheses and evaluate left to right (or, in fact, you can evaluate the tables in any order).
- The same is not true, in general, for outer joins or for outer joins mixed with inner joins. Removal of parentheses may change the result.

Queries with nested outer joins are executed in the same pipeline manner as queries with inner joins. More exactly, a variation of the nested-loop join algorithm is exploited. Recall by what algorithmic schema the nested-loop join executes a query. Suppose that we have a join query over 3 tables *T1, T2, T3* of the form:

```
SELECT * FROM T1 INNER JOIN T2 ON P1(T1,T2)
INNER JOIN T3 ON P2(T2,T3)
WHERE P(T1,T2,T3).
```

Here, *P1(T1, T2)* and *P2(T2, T3)* are some join conditions (on expressions), whereas *P(t1, t2, t3)* is a condition over columns of tables *T1, T2, T3*.

The nested-loop join algorithm would execute this query in the following manner:

```
FOR each row t1 in T1 {
  FOR each row t2 in T2 such that P1(t1,t2) {
    FOR each row t3 in T3 such that P2(t2,t3) {
      IF P(t1,t2,t3) {
        t:=t1||t2||t3; OUTPUT t;
      }
    }
  }
}
```

```
}
}
```

The notation `t1 || t2 || t3` means “a row constructed by concatenating the columns of rows `t1`, `t2`, and `t3`.” In some of the following examples, `NULL` where a row name appears means that `NULL` is used for each column of that row. For example, `t1 || t2 || NULL` means “a row constructed by concatenating the columns of rows `t1` and `t2`, and `NULL` for each column of `t3`.”

Now let's consider a query with nested outer joins:

```
SELECT * FROM T1 LEFT JOIN
      (T2 LEFT JOIN T3 ON P2(T2,T3))
      ON P1(T1,T2)
WHERE P(T1,T2,T3).
```

For this query, we modify the nested-loop pattern to get:

```
FOR each row t1 in T1 {
  BOOL f1:=FALSE;
  FOR each row t2 in T2 such that P1(t1,t2) {
    BOOL f2:=FALSE;
    FOR each row t3 in T3 such that P2(t2,t3) {
      IF P(t1,t2,t3) {
        t:=t1||t2||t3; OUTPUT t;
      }
      f2=TRUE;
      f1=TRUE;
    }
    IF (!f2) {
      IF P(t1,t2,NULL) {
        t:=t1||t2||NULL; OUTPUT t;
      }
      f1=TRUE;
    }
  }
  IF (!f1) {
    IF P(t1,NULL,NULL) {
      t:=t1||NULL||NULL; OUTPUT t;
    }
  }
}
```

In general, for any nested loop for the first inner table in an outer join operation, a flag is introduced that is turned off before the loop and is checked after the loop. The flag is turned on when for the current row from the outer table a match from the table representing the inner operand is found. If at the end of the loop cycle the flag is still off, no match has been found for the current row of the outer table. In this case, the row is complemented by `NULL` values for the columns of the inner tables. The result row is passed to the final check for the output or into the next nested loop, but only if the row satisfies the join condition of all embedded outer joins.

In our example, the outer join table expressed by the following expression is embedded:

```
(T2 LEFT JOIN T3 ON P2(T2,T3))
```

Note that for the query with inner joins, the optimizer could choose a different order of nested loops, such as this one:

```
FOR each row t3 in T3 {
  FOR each row t2 in T2 such that P2(t2,t3) {
    FOR each row t1 in T1 such that P1(t1,t2) {
      IF P(t1,t2,t3) {
        t:=t1||t2||t3; OUTPUT t;
      }
    }
  }
}
```

For the queries with outer joins, the optimizer can choose only such an order where loops for outer tables precede loops for inner tables. Thus, for our query with outer joins, only one nesting order is possible. For the following query, the optimizer will evaluate two different nestings:

```
SELECT * T1 LEFT JOIN (T2,T3) ON P1(T1,T2) AND P2(T1,T3)
WHERE P(T1,T2,T3)
```

The nestings are these:

```
FOR each row t1 in T1 {
  BOOL f1:=FALSE;
  FOR each row t2 in T2 such that P1(t1,t2) {
    FOR each row t3 in T3 such that P2(t1,t3) {
      IF P(t1,t2,t3) {
        t:=t1||t2||t3; OUTPUT t;
      }
    }
  }
}
```

```

    f1:=TRUE
  }
}
IF (!f1) {
  IF P(t1,NULL,NULL) {
    t:=t1||NULL||NULL; OUTPUT t;
  }
}
}

```

and:

```

FOR each row t1 in T1 {
  BOOL f1:=FALSE;
  FOR each row t3 in T3 such that P2(t1,t3) {
    FOR each row t2 in T2 such that P1(t1,t2) {
      IF P(t1,t2,t3) {
        t:=t1||t2||t3; OUTPUT t;
      }
      f1:=TRUE
    }
  }
  IF (!f1) {
    IF P(t1,NULL,NULL) {
      t:=t1||NULL||NULL; OUTPUT t;
    }
  }
}

```

In both nestings, **T1** must be processed in the outer loop because it is used in an outer join. **T2** and **T3** are used in an inner join, so that join must be processed in the inner loop. However, because the join is an inner join, **T2** and **T3** can be processed in either order.

When discussing the nested-loop algorithm for inner joins, we omitted some details whose impact on the performance of query execution may be huge. We did not mention so-called “pushed-down” conditions. Suppose that our **WHERE** condition  $P(T1, T2, T3)$  can be represented by a conjunctive formula:

```
P(T1,T2,T2) = C1(T1) AND C2(T2) AND C3(T3).
```

In this case, MySQL actually uses the following nested-loop schema for the execution of the query with inner joins:

```

FOR each row t1 in T1 such that C1(t1) {
  FOR each row t2 in T2 such that P1(t1,t2) AND C2(t2) {
    FOR each row t3 in T3 such that P2(t2,t3) AND C3(t3) {
      IF P(t1,t2,t3) {
        t:=t1||t2||t3; OUTPUT t;
      }
    }
  }
}

```

You see that each of the conjuncts  $C1(T1)$ ,  $C2(T2)$ ,  $C3(T3)$  are pushed out of the most inner loop to the most outer loop where it can be evaluated. If  $C1(T1)$  is a very restrictive condition, this condition pushdown may greatly reduce the number of rows from table **T1** passed to the inner loops. As a result, the execution time for the query may improve immensely.

For a query with outer joins, the **WHERE** condition is to be checked only after it has been found that the current row from the outer table has a match in the inner tables. Thus, the optimization of pushing conditions out of the inner nested loops cannot be applied directly to queries with outer joins. Here we have to introduce conditional pushed-down predicates guarded by the flags that are turned on when a match has been encountered.

For our example with outer joins with:

```
P(T1,T2,T3)=C1(T1) AND C(T2) AND C3(T3)
```

the nested-loop schema using guarded pushed-down conditions looks like this:

```

FOR each row t1 in T1 such that C1(t1) {
  BOOL f1:=FALSE;
  FOR each row t2 in T2
    such that P1(t1,t2) AND (f1?C2(t2):TRUE) {
    BOOL f2:=FALSE;
    FOR each row t3 in T3
      such that P2(t2,t3) AND (f1&&f2?C3(t3):TRUE) {
      IF (f1&&f2?TRUE:(C2(t2) AND C3(t3))) {
        t:=t1||t2||t3; OUTPUT t;
      }
      f2=TRUE;
      f1=TRUE;
    }
  }
  IF (!f2) {
    IF (f1?TRUE:C2(t2) && P(t1,t2,NULL)) {

```

```

        t:=t1||t2|NULL; OUTPUT t;
    }
    f1=TRUE;
}
}
IF (!f1 && P(t1,NULL,NULL)) {
    t:=t1|NULL|NULL; OUTPUT t;
}
}

```

In general, pushed-down predicates can be extracted from join conditions such as  $P_1(T_1, T_2)$  and  $P(T_2, T_3)$ . In this case, a pushed-down predicate is guarded also by a flag that prevents checking the predicate for the `NULL`-complemented row generated by the corresponding outer join operation.

Note that access by key from one inner table to another in the same nested join is prohibited if it is induced by a predicate from the `WHERE` condition. (We could use conditional key access in this case, but this technique is not employed yet in MySQL 5.1.)

## 7.2.12. Outer Join Simplification

Table expressions in the `FROM` clause of a query are simplified in many cases.

At the parser stage, queries with right outer joins operations are converted to equivalent queries containing only left join operations. In the general case, the conversion is performed according to the following rule:

```

(T1, ...) RIGHT JOIN (T2,...) ON P(T1,...,T2,...) =
(T2, ...) LEFT JOIN (T1,...) ON P(T1,...,T2,...)

```

All inner join expressions of the form `T1 INNER JOIN T2 ON P(T1, T2)` are replaced by the list `T1, T2, P(T1, T2)` being joined as a conjunct to the `WHERE` condition (or to the join condition of the embedding join, if there is any).

When the optimizer evaluates plans for join queries with outer join operation, it takes into consideration only the plans where, for each such operation, the outer tables are accessed before the inner tables. The optimizer options are limited because only such plans enables us to execute queries with outer joins operations by the nested loop schema.

Suppose that we have a query of the form:

```

SELECT * T1 LEFT JOIN T2 ON P1(T1,T2)
WHERE P(T1,T2) AND R(T2)

```

with `R(T2)` narrowing greatly the number of matching rows from table `T2`. If we executed the query as it is, the optimizer would have no other choice besides to access table `T1` before table `T2` that may lead to a very inefficient execution plan.

Fortunately, MySQL converts such a query into a query without an outer join operation if the `WHERE` condition is null-rejected. A condition is called null-rejected for an outer join operation if it evaluates to `FALSE` or to `UNKNOWN` for any `NULL`-complemented row built for the operation.

Thus, for this outer join:

```
T1 LEFT JOIN T2 ON T1.A=T2.A
```

Conditions such as these are null-rejected:

```

T2.B IS NOT NULL,
T2.B > 3,
T2.C <= T1.C,
T2.B < 2 OR T2.C > 1

```

Conditions such as these are not null-rejected:

```

T2.B IS NULL,
T1.B < 3 OR T2.B IS NOT NULL,
T1.B < 3 OR T2.B > 3

```

The general rules for checking whether a condition is null-rejected for an outer join operation are simple. A condition is null-rejected in the following cases:

- If it is of the form `A IS NOT NULL`, where `A` is an attribute of any of the inner tables
- If it is a predicate containing a reference to an inner table that evaluates to `UNKNOWN` when one of its arguments is `NULL`
- If it is a conjunction containing a null-rejected condition as a conjunct

- If it is a disjunction of null-rejected conditions

A condition can be null-rejected for one outer join operation in a query and not null-rejected for another. In the query:

```
SELECT * FROM T1 LEFT JOIN T2 ON T2.A=T1.A
           LEFT JOIN T3 ON T3.B=T1.B
WHERE T3.C > 0
```

the **WHERE** condition is null-rejected for the second outer join operation but is not null-rejected for the first one.

If the **WHERE** condition is null-rejected for an outer join operation in a query, the outer join operation is replaced by an inner join operation.

For example, the preceding query is replaced with the query:

```
SELECT * FROM T1 LEFT JOIN T2 ON T2.A=T1.A
           INNER JOIN T3 ON T3.B=T1.B
WHERE T3.C > 0
```

For the original query, the optimizer would evaluate plans compatible with only one access order **T1, T2, T3**. For the replacing query, it additionally considers the access sequence **T3, T1, T2**.

A conversion of one outer join operation may trigger a conversion of another. Thus, the query:

```
SELECT * FROM T1 LEFT JOIN T2 ON T2.A=T1.A
           LEFT JOIN T3 ON T3.B=T2.B
WHERE T3.C > 0
```

will be first converted to the query:

```
SELECT * FROM T1 LEFT JOIN T2 ON T2.A=T1.A
           INNER JOIN T3 ON T3.B=T2.B
WHERE T3.C > 0
```

which is equivalent to the query:

```
SELECT * FROM (T1 LEFT JOIN T2 ON T2.A=T1.A), T3
WHERE T3.C > 0 AND T3.B=T2.B
```

Now the remaining outer join operation can be replaced by an inner join, too, because the condition **T3.B=T2.B** is null-rejected and we get a query without outer joins at all:

```
SELECT * FROM (T1 INNER JOIN T2 ON T2.A=T1.A), T3
WHERE T3.C > 0 AND T3.B=T2.B
```

Sometimes we succeed in replacing an embedded outer join operation, but cannot convert the embedding outer join. The following query:

```
SELECT * FROM T1 LEFT JOIN
           (T2 LEFT JOIN T3 ON T3.B=T2.B)
           ON T2.A=T1.A
WHERE T3.C > 0
```

is converted to:

```
SELECT * FROM T1 LEFT JOIN
           (T2 INNER JOIN T3 ON T3.B=T2.B)
           ON T2.A=T1.A
WHERE T3.C > 0,
```

That can be rewritten only to the form still containing the embedding outer join operation:

```
SELECT * FROM T1 LEFT JOIN
           (T2, T3)
           ON (T2.A=T1.A AND T3.B=T2.B)
WHERE T3.C > 0.
```

When trying to convert an embedded outer join operation in a query, we must take into account the join condition for the embedding outer join together with the **WHERE** condition. In the query:

```
SELECT * FROM T1 LEFT JOIN
           (T2 LEFT JOIN T3 ON T3.B=T2.B)
```



```

        ON T2.A=T1.A AND T3.C=T1.C
WHERE T3.D > 0 OR T1.D > 0

```

the `WHERE` condition is not null-rejected for the embedded outer join, but the join condition of the embedding outer join `T2.A=T1.A AND T3.C=T1.C` is null-rejected. So the query can be converted to:

```

SELECT * FROM T1 LEFT JOIN
        (T2, T3)
        ON T2.A=T1.A AND T3.C=T1.C AND T3.B=T2.B
WHERE T3.D > 0 OR T1.D > 0

```

## 7.2.13. ORDER BY Optimization

In some cases, MySQL can use an index to satisfy an `ORDER BY` clause without doing any extra sorting.

The index can also be used even if the `ORDER BY` does not match the index exactly, as long as all of the unused portions of the index and all the extra `ORDER BY` columns are constants in the `WHERE` clause. The following queries use the index to resolve the `ORDER BY` part:

```

SELECT * FROM t1
ORDER BY key_part1, key_part2, ... ;

SELECT * FROM t1
WHERE key_part1=constant
ORDER BY key_part2;

SELECT * FROM t1
ORDER BY key_part1 DESC, key_part2 DESC;

SELECT * FROM t1
WHERE key_part1=1
ORDER BY key_part1 DESC, key_part2 DESC;

```

In some cases, MySQL *cannot* use indexes to resolve the `ORDER BY`, although it still uses indexes to find the rows that match the `WHERE` clause. These cases include the following:

- You use `ORDER BY` on different keys:

```
SELECT * FROM t1 ORDER BY key1, key2;
```

- You use `ORDER BY` on non-consecutive parts of a key:

```
SELECT * FROM t1 WHERE key2=constant ORDER BY key_part2;
```

- You mix `ASC` and `DESC`:

```
SELECT * FROM t1 ORDER BY key_part1 DESC, key_part2 ASC;
```

- The key used to fetch the rows is not the same as the one used in the `ORDER BY`:

```
SELECT * FROM t1 WHERE key2=constant ORDER BY key1;
```

- You use `ORDER BY` with an expression that includes terms other than the key column name:

```
SELECT * FROM t1 ORDER BY ABS(key);
SELECT * FROM t1 ORDER BY -key;
```

- You are joining many tables, and the columns in the `ORDER BY` are not all from the first non-constant table that is used to retrieve rows. (This is the first table in the `EXPLAIN` output that does not have a `const` join type.)
- You have different `ORDER BY` and `GROUP BY` expressions.
- You index only a prefix of a column named in the `ORDER BY` clause. In this case, the index cannot be used to fully resolve the sort order. For example, if you have a `CHAR(20)` column, but index only the first 10 bytes, the index cannot distinguish values past the 10th byte and a `filesort` will be needed.
- The type of table index used does not store rows in order. For example, this is true for a `HASH` index in a `MEMORY` table.

Availability of an index for sorting may be affected by the use of column aliases. Suppose that the column `t1.a` is indexed. In this statement, the name of the column in the select list is `a`. It refers to `t1.a`, so for the reference to `a` in the `ORDER BY`, the index

can be used:

```
SELECT a FROM t1 ORDER BY a;
```

In this statement, the name of the column in the select list is also `a`, but it is the alias name. It refers to `ABS(a)`, so for the reference to `a` in the `ORDER BY`, the index cannot be used:

```
SELECT ABS(a) AS a FROM t1 ORDER BY a;
```

In the following statement, the `ORDER BY` refers to a name that is not the name of a column in the select list. But there is a column in `t1` named `a`, so the `ORDER BY` uses that, and the index can be used. (The resulting sort order may be completely different from the order for `ABS(a)`, of course.)

```
SELECT ABS(a) AS b FROM t1 ORDER BY a;
```

By default, MySQL sorts all `GROUP BY col1, col2, ...` queries as if you specified `ORDER BY col1, col2, ...` in the query as well. If you include an `ORDER BY` clause explicitly that contains the same column list, MySQL optimizes it away without any speed penalty, although the sorting still occurs. If a query includes `GROUP BY` but you want to avoid the overhead of sorting the result, you can suppress sorting by specifying `ORDER BY NULL`. For example:

```
INSERT INTO foo
SELECT a, COUNT(*) FROM bar GROUP BY a ORDER BY NULL;
```

With `EXPLAIN SELECT ... ORDER BY`, you can check whether MySQL can use indexes to resolve the query. It cannot if you see `Using filesort` in the `Extra` column. See [Section 7.2.1, “Optimizing Queries with EXPLAIN”](#).

MySQL has two `filesort` algorithms for sorting and retrieving results. The original method uses only the `ORDER BY` columns. The modified method uses not just the `ORDER BY` columns, but all the columns used in the query.

The optimizer selects which `filesort` algorithm to use. It normally uses the modified algorithm except when `BLOB` or `TEXT` columns are involved, in which case it uses the original algorithm.

The original `filesort` algorithm works as follows:

1. Read all rows according to key or by table scanning. Rows that do not match the `WHERE` clause are skipped.
2. For each row, store a pair of values in a buffer (the sort key and the row pointer). The size of the buffer is the value of the `sort_buffer_size` system variable.
3. When the buffer gets full, run a `qsort` (quicksort) on it and store the result in a temporary file. Save a pointer to the sorted block. (If all pairs fit into the sort buffer, no temporary file is created.)
4. Repeat the preceding steps until all rows have been read.
5. Do a multi-merge of up to `MERGEBUFF` (7) regions to one block in another temporary file. Repeat until all blocks from the first file are in the second file.
6. Repeat the following until there are fewer than `MERGEBUFF2` (15) blocks left.
7. On the last multi-merge, only the pointer to the row (the last part of the sort key) is written to a result file.
8. Read the rows in sorted order by using the row pointers in the result file. To optimize this, we read in a big block of row pointers, sort them, and use them to read the rows in sorted order into a row buffer. The size of the buffer is the value of the `read_rnd_buffer_size` system variable. The code for this step is in the `sql/records.cc` source file.

One problem with this approach is that it reads rows twice: One time when evaluating the `WHERE` clause, and again after sorting the pair values. And even if the rows were accessed successively the first time (for example, if a table scan is done), the second time they are accessed randomly. (The sort keys are ordered, but the row positions are not.)

The modified `filesort` algorithm incorporates an optimization such that it records not only the sort key value and row position, but also the columns required for the query. This avoids reading the rows twice. The modified `filesort` algorithm works like this:

1. Read the rows that match the `WHERE` clause.
2. For each row, record a tuple of values consisting of the sort key value and row position, and also the columns required for the query.

3. Sort the tuples by sort key value
4. Retrieve the rows in sorted order, but read the required columns directly from the sorted tuples rather than by accessing the table a second time.

Using the modified `filesort` algorithm, the tuples are longer than the pairs used in the original method, and fewer of them fit in the sort buffer (the size of which is given by `sort_buffer_size`). As a result, it is possible for the extra I/O to make the modified approach slower, not faster. To avoid a slowdown, the optimization is used only if the total size of the extra columns in the sort tuple does not exceed the value of the `max_length_for_sort_data` system variable. (A symptom of setting the value of this variable too high is that you should see high disk activity and low CPU activity.)

For slow queries for which `filesort` is not used, you might try lowering `max_length_for_sort_data` to a value that is appropriate to trigger a `filesort`.

If you want to increase `ORDER BY` speed, check whether you can get MySQL to use indexes rather than an extra sorting phase. If this is not possible, you can try the following strategies:

- Increase the size of the `sort_buffer_size` variable.
- Increase the size of the `read_rnd_buffer_size` variable.
- Use less RAM per row by declaring columns only as large as they need to be to hold the values stored in them. For example, `CHAR(16)` is better than `CHAR(200)` if values never exceed 16 characters.
- Change `tmpdir` to point to a dedicated file system with large amounts of free space. Also, this option accepts several paths that are used in round-robin fashion, so you can use this feature to spread the load across several directories. Paths should be separated by colon characters (":") on Unix and semicolon characters(";") on Windows, NetWare, and OS/2. The paths should be for directories in file systems that are located on different *physical* disks, not different partitions on the same disk.

## 7.2.14. GROUP BY Optimization

The most general way to satisfy a `GROUP BY` clause is to scan the whole table and create a new temporary table where all rows from each group are consecutive, and then use this temporary table to discover groups and apply aggregate functions (if any). In some cases, MySQL is able to do much better than that and to avoid creation of temporary tables by using index access.

The most important preconditions for using indexes for `GROUP BY` are that all `GROUP BY` columns reference attributes from the same index, and that the index stores its keys in order (for example, this is a `BTREE` index and not a `HASH` index). Whether use of temporary tables can be replaced by index access also depends on which parts of an index are used in a query, the conditions specified for these parts, and the selected aggregate functions.

In MySQL, `GROUP BY` is used for sorting, so the server may also apply `ORDER BY` optimizations to grouping. See [Section 7.2.13, “ORDER BY Optimization”](#).

There are two ways to execute a `GROUP BY` query via index access, as detailed in the following sections. In the first method, the grouping operation is applied together with all range predicates (if any). The second method first performs a range scan, and then groups the resulting tuples.

### 7.2.14.1. Loose index scan

The most efficient way to process `GROUP BY` is when the index is used to directly retrieve the group columns. With this access method, MySQL uses the property of some index types that the keys are ordered (for example, `BTREE`). This property enables use of lookup groups in an index without having to consider all keys in the index that satisfy all `WHERE` conditions. This access method considers only a fraction of the keys in an index, so it is called a *loose index scan*. When there is no `WHERE` clause, a loose index scan reads as many keys as the number of groups, which may be a much smaller number than that of all keys. If the `WHERE` clause contains range predicates (see the discussion of the `range` join type in [Section 7.2.1, “Optimizing Queries with EXPLAIN”](#)), a loose index scan looks up the first key of each group that satisfies the range conditions, and again reads the least possible number of keys. This is possible under the following conditions:

- The query is over a single table.
- The `GROUP BY` includes the first consecutive parts of the index. (If, instead of `GROUP BY`, the query has a `DISTINCT` clause, all distinct attributes refer to the beginning of the index.)
- The only aggregate functions used (if any) are `MIN()` and `MAX()`, and all of them refer to the same column.
- Any other parts of the index than those from the `GROUP BY` referenced in the query must be constants (that is, they must be

referenced in equalities with constants), except for the argument of `MIN()` or `MAX()` functions.

The `EXPLAIN` output for such queries shows `Using index for group-by` in the `Extra` column.

The following queries fall into this category, assuming that there is an index `idx(c1,c2,c3)` on table `t1(c1,c2,c3,c4)`:

```
SELECT c1, c2 FROM t1 GROUP BY c1, c2;
SELECT DISTINCT c1, c2 FROM t1;
SELECT c1, MIN(c2) FROM t1 GROUP BY c1;
SELECT c1, c2 FROM t1 WHERE c1 < const GROUP BY c1, c2;
SELECT MAX(c3), MIN(c3), c1, c2 FROM t1 WHERE c2 > const GROUP BY c1, c2;
SELECT c2 FROM t1 WHERE c1 < const GROUP BY c1, c2;
SELECT c1, c2 FROM t1 WHERE c3 = const GROUP BY c1, c2;
```

The following queries cannot be executed with this quick select method, for the reasons given:

- There are aggregate functions other than `MIN()` or `MAX()`, for example:

```
SELECT c1, SUM(c2) FROM t1 GROUP BY c1;
```

- The columns in the `GROUP BY` clause do not refer to the beginning of the index, as shown here:

```
SELECT c1,c2 FROM t1 GROUP BY c2, c3;
```

- The query refers to a part of a key that comes after the `GROUP BY` part, and for which there is no equality with a constant, an example being:

```
SELECT c1,c3 FROM t1 GROUP BY c1, c2;
```

## 7.2.14.2. Tight index scan

A tight index scan may be either a full index scan or a range index scan, depending on the query conditions.

When the conditions for a loose index scan are not met, it is still possible to avoid creation of temporary tables for `GROUP BY` queries. If there are range conditions in the `WHERE` clause, this method reads only the keys that satisfy these conditions. Otherwise, it performs an index scan. Because this method reads all keys in each range defined by the `WHERE` clause, or scans the whole index if there are no range conditions, we term it a *tight index scan*. Notice that with a tight index scan, the grouping operation is performed only after all keys that satisfy the range conditions have been found.

For this method to work, it is sufficient that there is a constant equality condition for all columns in a query referring to parts of the key coming before or in between parts of the `GROUP BY` key. The constants from the equality conditions fill in any “gaps” in the search keys so that it is possible to form complete prefixes of the index. These index prefixes then can be used for index lookups. If we require sorting of the `GROUP BY` result, and it is possible to form search keys that are prefixes of the index, MySQL also avoids extra sorting operations because searching with prefixes in an ordered index already retrieves all the keys in order.

The following queries do not work with the loose index scan access method described earlier, but still work with the tight index scan access method (assuming that there is an index `idx(c1,c2,c3)` on table `t1(c1,c2,c3,c4)`).

- There is a gap in the `GROUP BY`, but it is covered by the condition `c2 = 'a'`:

```
SELECT c1, c2, c3 FROM t1 WHERE c2 = 'a' GROUP BY c1, c3;
```

- The `GROUP BY` does not begin with the first part of the key, but there is a condition that provides a constant for that part:

```
SELECT c1, c2, c3 FROM t1 WHERE c1 = 'a' GROUP BY c2, c3;
```

## 7.2.15. DISTINCT Optimization

`DISTINCT` combined with `ORDER BY` needs a temporary table in many cases.

Because `DISTINCT` may use `GROUP BY`, you should be aware of how MySQL works with columns in `ORDER BY` or `HAVING` clauses that are not part of the selected columns. See [Section 11.12.3, “GROUP BY and HAVING with Hidden Columns”](#).

In most cases, a `DISTINCT` clause can be considered as a special case of `GROUP BY`. For example, the following two queries are

equivalent:

```
SELECT DISTINCT c1, c2, c3 FROM t1
WHERE c1 > const;

SELECT c1, c2, c3 FROM t1
WHERE c1 > const GROUP BY c1, c2, c3;
```

Due to this equivalence, the optimizations applicable to `GROUP BY` queries can be also applied to queries with a `DISTINCT` clause. Thus, for more details on the optimization possibilities for `DISTINCT` queries, see [Section 7.2.14, “GROUP BY Optimization”](#).

When combining `LIMIT row_count` with `DISTINCT`, MySQL stops as soon as it finds `row_count` unique rows.

If you do not use columns from all tables named in a query, MySQL stops scanning any unused tables as soon as it finds the first match. In the following case, assuming that `t1` is used before `t2` (which you can check with `EXPLAIN`), MySQL stops reading from `t2` (for any particular row in `t1`) when it finds the first row in `t2`:

```
SELECT DISTINCT t1.a FROM t1, t2 where t1.a=t2.a;
```

## 7.2.16. Optimizing `IN/=ANY` Subqueries

Certain optimizations are applicable to comparisons that use the `IN` operator to test subquery results (or that use `=ANY`, which is equivalent). This section discusses these optimizations, particularly with regard to the challenges that `NULL` values present. Suggestions on what you can do to help the optimizer are given at the end of the discussion.

Consider the following subquery comparison:

```
outer_expr IN (SELECT inner_expr FROM ... WHERE subquery_where)
```

MySQL evaluates queries “from outside to inside.” That is, it first obtains the value of the outer expression `outer_expr`, and then runs the subquery and captures the rows that it produces.

A very useful optimization is to “inform” the subquery that the only rows of interest are those where the inner expression `inner_expr` is equal to `outer_expr`. This is done by pushing down an appropriate equality into the subquery’s `WHERE` clause. That is, the comparison is converted to this:

```
EXISTS (SELECT 1 FROM ... WHERE subquery_where AND outer_expr=inner_expr)
```

After the conversion, MySQL can use the pushed-down equality to limit the number of rows that it must examine when evaluating the subquery.

More generally, a comparison of `N` values to a subquery that returns `N`-value rows is subject to the same conversion. If `oe_i` and `ie_i` represent corresponding outer and inner expression values, this subquery comparison:

```
(oe_1, ..., oe_N) IN
(SELECT ie_1, ..., ie_N FROM ... WHERE subquery_where)
```

Becomes:

```
EXISTS (SELECT 1 FROM ... WHERE subquery_where
        AND oe_1 = ie_1
        AND ...
        AND oe_N = ie_N)
```

The following discussion assumes a single pair of outer and inner expression values for simplicity.

The conversion just described has its limitations. It is valid only if we ignore possible `NULL` values. That is, the “pushdown” strategy works as long as both of these two conditions are true:

- `outer_expr` and `inner_expr` cannot be `NULL`.
- You do not need to distinguish `NULL` from `FALSE` subquery results. (If the subquery is a part of an `OR` or `AND` expression in the `WHERE` clause, MySQL assumes that you don’t care.)

When either or both of those conditions do not hold, optimization is more complex.

Suppose that `outer_expr` is known to be a non-`NULL` value but the subquery does not produce a row such that `outer_expr = inner_expr`. Then `outer_expr IN (SELECT ...)` evaluates as follows:

- `NULL`, if the `SELECT` produces any row where `inner_expr` is `NULL`
- `FALSE`, if the `SELECT` produces only non-`NULL` values or produces nothing

In this situation, the approach of looking for rows with `outer_expr = inner_expr` is no longer valid. It is necessary to look for such rows, but if none are found, also look for rows where `inner_expr` is `NULL`. Roughly speaking, the subquery can be converted to:

```
EXISTS (SELECT 1 FROM ... WHERE subquery_where AND
        (outer_expr=inner_expr OR inner_expr IS NULL))
```

The need to evaluate the extra `IS NULL` condition is why MySQL has the `ref_or_null` access method:

```
mysql> EXPLAIN
-> SELECT outer_expr IN (SELECT t2.maybe_null_key
->                        FROM t2, t3 WHERE ...)
-> FROM t1;
***** 1. row *****
      id: 1
  select_type: PRIMARY
      table: t1
  ...
***** 2. row *****
      id: 2
  select_type: DEPENDENT SUBQUERY
      table: t2
      type: ref_or_null
possible_keys: maybe_null_key
      key: maybe_null_key
      key_len: 5
      ref: func
      rows: 2
  Extra: Using where; Using index
  ...
```

The `unique_subquery` and `index_subquery` subquery-specific access methods also have or-null variants. However, they are not visible in `EXPLAIN` output, so you must use `EXPLAIN EXTENDED` followed by `SHOW WARNINGS` (note the `checking NULL` in the warning message):

```
mysql> EXPLAIN EXTENDED
-> SELECT outer_expr IN (SELECT maybe_null_key FROM t2) FROM t1\G
***** 1. row *****
      id: 1
  select_type: PRIMARY
      table: t1
  ...
***** 2. row *****
      id: 2
  select_type: DEPENDENT SUBQUERY
      table: t2
      type: index_subquery
possible_keys: maybe_null_key
      key: maybe_null_key
      key_len: 5
      ref: func
      rows: 2
  Extra: Using index

mysql> SHOW WARNINGS\G
***** 1. row *****
  Level: Note
  Code: 1003
  Message: select (`test`.`t1`.`outer_expr`,
  (((`test`.`t1`.`outer_expr`) in t2 on
  maybe_null_key checking NULL))) AS `outer_expr` IN (SELECT
  maybe_null_key FROM t2)` from `test`.`t1`
```

The additional `OR ... IS NULL` condition makes query execution slightly more complicated (and some optimizations within the subquery become inapplicable), but generally this is tolerable.

The situation is much worse when `outer_expr` can be `NULL`. According to the SQL interpretation of `NULL` as “unknown value,” `NULL IN (SELECT inner_expr ...)` should evaluate to:

- `NULL`, if the `SELECT` produces any rows
- `FALSE`, if the `SELECT` produces no rows

For proper evaluation, it is necessary to be able to check whether the `SELECT` has produced any rows at all, so `outer_expr = inner_expr` cannot be pushed down into the subquery. This is a problem, because many real world subqueries become very

slow unless the equality can be pushed down.

Essentially, there must be different ways to execute the subquery depending on the value of `outer_expr`. In MySQL 5.1 before 5.1.16, the optimizer chose speed over distinguishing a `NULL` from `FALSE` result, so for some queries, you might get a `FALSE` result rather than `NULL`.

As of MySQL 5.1.16, the optimizer chooses SQL compliance over speed, so it accounts for the possibility that `outer_expr` might be `NULL`.

If `outer_expr` is `NULL`, to evaluate the following expression, it is necessary to run the `SELECT` to determine whether it produces any rows:

```
NULL IN (SELECT inner_expr FROM ... WHERE subquery_where)
```

It is necessary to run the original `SELECT` here, without any pushed-down equalities of the kind mentioned earlier.

On the other hand, when `outer_expr` is not `NULL`, it is absolutely essential that this comparison:

```
outer_expr IN (SELECT inner_expr FROM ... WHERE subquery_where)
```

be converted to this expression that uses a pushed-down condition:

```
EXISTS (SELECT 1 FROM ... WHERE subquery_where AND outer_expr=inner_expr)
```

Without this conversion, subqueries will be slow. To solve the dilemma of whether to push down or not push down conditions into the subquery, the conditions are wrapped in “trigger” functions. Thus, an expression of the following form:

```
outer_expr IN (SELECT inner_expr FROM ... WHERE subquery_where)
```

is converted into:

```
EXISTS (SELECT 1 FROM ... WHERE subquery_where
        AND trigcond(outer_expr=inner_expr))
```

More generally, if the subquery comparison is based on several pairs of outer and inner expressions, the conversion takes this comparison:

```
(oe_1, ..., oe_N) IN (SELECT ie_1, ..., ie_N FROM ... WHERE subquery_where)
```

and converts it to this expression:

```
EXISTS (SELECT 1 FROM ... WHERE subquery_where
        AND trigcond(oe_1=ie_1)
        AND ...
        AND trigcond(oe_N=ie_N)
    )
```

Each `trigcond(X)` is a special function that evaluates to the following values:

- `X` when the “linked” outer expression `oe_i` is not `NULL`
- `TRUE` when the “linked” outer expression `oe_i` is `NULL`

Note that trigger functions are *not* triggers of the kind that you create with `CREATE TRIGGER`.

Equalities that are wrapped into `trigcond()` functions are not first class predicates for the query optimizer. Most optimizations cannot deal with predicates that may be turned on and off at query execution time, so they assume any `trigcond(X)` to be an unknown function and ignore it. At the moment, triggered equalities can be used by those optimizations:

- Reference optimizations: `trigcond(X=Y [OR Y IS NULL])` can be used to construct `ref`, `eq_ref`, or `ref_or_null` table accesses.
- Index lookup-based subquery execution engines: `trigcond(X=Y)` can be used to construct `unique_subquery` or `index_subquery` accesses.
- Table-condition generator: If the subquery is a join of several tables, the triggered condition will be checked as soon as possible.

When the optimizer uses a triggered condition to create some kind of index lookup-based access (as for the first two items of the preceding list), it must have a fallback strategy for the case when the condition is turned off. This fallback strategy is always the same: Do a full table scan. In `EXPLAIN` output, the fallback shows up as `Full scan on NULL key` in the `Extra` column:

```
mysql> EXPLAIN SELECT t1.col1,
-> t1.col1 IN (SELECT t2.key1 FROM t2 WHERE t2.col2=t1.col2) FROM t1\G
***** 1. row *****
      id: 1
  select_type: PRIMARY
     table: t1
      ...
***** 2. row *****
      id: 2
  select_type: DEPENDENT SUBQUERY
     table: t2
    type: index_subquery
possible_keys: key1
         key: key1
    key_len: 5
         ref: func
         rows: 2
     Extra: Using where; Full scan on NULL key
```

If you run `EXPLAIN EXTENDED` followed by `SHOW WARNINGS`, you can see the triggered condition:

```
***** 1. row *****
Level: Note
Code: 1003
Message: select `test`.`t1`.`col1` AS `coll`,
<in_optimizer>(`test`.`t1`.`col1`,
<exists>(<index_lookup>(<cache>(`test`.`t1`.`col1`) in t2
on key1 checking NULL
where (`test`.`t2`.`col2` = `test`.`t1`.`col2`) having
trigcond(<is_not_null_test>(`test`.`t2`.`key1`)))) AS
`t1.col1 IN (select t2.key1 from t2 where t2.col2=t1.col2)`
from `test`.`t1`
```

The use of triggered conditions has some performance implications. A `NULL IN (SELECT ...)` expression now may cause a full table scan (which is slow) when it previously did not. This is the price paid for correct results (the goal of the trigger-condition strategy was to improve compliance and not speed).

For multiple-table subqueries, execution of `NULL IN (SELECT ...)` will be particularly slow because the join optimizer doesn't optimize for the case where the outer expression is `NULL`. It assumes that subquery evaluations with `NULL` on the left side are very rare, even if there are statistics that indicate otherwise. On the other hand, if the outer expression might be `NULL` but never actually is, there is no performance penalty.

To help the query optimizer better execute your queries, use these tips:

- A column must be declared as `NOT NULL` if it really is. (This also helps other aspects of the optimizer.)
- If you don't need to distinguish a `NULL` from `FALSE` subquery result, you can easily avoid the slow execution path. Replace a comparison that looks like this:

```
outer_expr IN (SELECT inner_expr FROM ...)
```

with this expression:

```
(outer_expr IS NOT NULL) AND (outer_expr IN (SELECT inner_expr FROM ...))
```

Then `NULL IN (SELECT ...)` will never be evaluated because MySQL stops evaluating `AND` parts as soon as the expression result is clear.

## 7.2.17. LIMIT Optimization

In some cases, MySQL handles a query differently when you are using `LIMIT row_count` and not using `HAVING`:

- If you are selecting only a few rows with `LIMIT`, MySQL uses indexes in some cases when normally it would prefer to do a full table scan.
- If you use `LIMIT row_count` with `ORDER BY`, MySQL ends the sorting as soon as it has found the first `row_count` rows of the sorted result, rather than sorting the entire result. If ordering is done by using an index, this is very fast. If a filesort must be done, all rows that match the query without the `LIMIT` clause must be selected, and most or all of them must be sorted, before it can be ascertained that the first `row_count` rows have been found. In either case, after the initial rows have been found,



there is no need to sort any remainder of the result set, and MySQL does not do so.

- When combining `LIMIT row_count` with `DISTINCT`, MySQL stops as soon as it finds `row_count` unique rows.
- In some cases, a `GROUP BY` can be resolved by reading the key in order (or doing a sort on the key) and then calculating summaries until the key value changes. In this case, `LIMIT row_count` does not calculate any unnecessary `GROUP BY` values.
- As soon as MySQL has sent the required number of rows to the client, it aborts the query unless you are using `SQL_CALC_FOUND_ROWS`.
- `LIMIT 0` quickly returns an empty set. This can be useful for checking the validity of a query. When using one of the MySQL APIs, it can also be employed for obtaining the types of the result columns. (This trick does not work in the MySQL Monitor (the `mysql` program), which merely displays `Empty set` in such cases; you should instead use `SHOW COLUMNS` or `DESCRIBE` for this purpose.)
- When the server uses temporary tables to resolve the query, it uses the `LIMIT row_count` clause to calculate how much space is required.

## 7.2.18. Using `optimizer_switch` to Control the Optimizer

The `optimizer_switch` system variable enables control over optimizer behavior.

As of MySQL 5.1.34, the value of the `optimizer_switch` system variable is a set of flags, each of which has a value of `on` or `off` to indicate whether the corresponding optimizer behavior is enabled or disabled. This variable has global and session values and be changed at runtime. The global default can be set at server startup.

To see the current set of optimizer flags, select the variable value:

```
mysql> SELECT @@optimizer_switch\G
***** 1. row *****
@@optimizer_switch: index_merge=on,index_merge_union=on,
                    index_merge_sort_union=on,
                    index_merge_intersection=on
```

To change the value of `optimizer_switch`, assign a value consisting of a comma-separated list of one or more commands:

```
SET [GLOBAL|SESSION] optimizer_switch='command[,command]...';
```

Each `command` value should have one of the forms shown in the following table.

Command Syntax	Meaning
<code>default</code>	Reset every optimization to its default value
<code>opt_name=default</code>	Set the named optimization to its default value
<code>opt_name=off</code>	Disable the named optimization
<code>opt_name=on</code>	Enable the named optimization

The order of the commands in the value does not matter, although `default` is executed first if present. Specifying any given `opt_name` more than once in the value is not allowed and causes an error. Any errors in the value cause the entire statement to fail with an error and the current value of `optimizer_switch` remains unchanged.

The following table lists the allowable `opt_name` flag names.

Flag Name	Meaning
<code>index_merge</code>	Controls all Index Merge optimizations
<code>index_merge_union</code>	Controls the Index Merge Union Access optimization
<code>index_merge_sort_union</code>	Controls the Index Merge Sort-Union Access optimization
<code>index_merge_intersection</code>	Controls the Index Merge Intersection Access optimization

For information about Index Merge, see [Section 7.2.6, “Index Merge Optimization”](#).

When you assign a value to `optimizer_switch`, flags that are not mentioned keep their current values. This makes it possible to enable or disable specific optimizer behaviors in a single statement without affecting other behaviors. The statement does not depend on what other optimizer flags exist and what their values are. Suppose that all Index Merge optimizations are enabled:

```
mysql> SELECT @@optimizer_switch\G
***** 1. row *****
@@optimizer_switch: index_merge=on,index_merge_union=on,
                    index_merge_sort_union=on,
                    index_merge_intersection=on
1 row in set (0.00 sec)
```

If the server is using the Index Merge Union or Index Merge Sort-Union access methods for certain queries and you want to check whether the optimizer will perform better without them, set the variable value like this:

```
mysql> SET optimizer_switch='index_merge_union=off,index_merge_sort_union=off';
Query OK, 0 rows affected (0.00 sec)

mysql> SELECT @@optimizer_switch\G
***** 1. row *****
@@optimizer_switch: index_merge=on,index_merge_union=off,
                    index_merge_sort_union=off,
                    index_merge_intersection=on
1 row in set (0.00 sec)
```

## 7.2.19. How to Avoid Table Scans

The output from `EXPLAIN` shows `ALL` in the `type` column when MySQL uses a table scan to resolve a query. This usually happens under the following conditions:

- The table is so small that it is faster to perform a table scan than to bother with a key lookup. This is common for tables with fewer than 10 rows and a short row length.
- There are no usable restrictions in the `ON` or `WHERE` clause for indexed columns.
- You are comparing indexed columns with constant values and MySQL has calculated (based on the index tree) that the constants cover too large a part of the table and that a table scan would be faster. See [Section 7.2.4, “WHERE Clause Optimization”](#).
- You are using a key with low cardinality (many rows match the key value) through another column. In this case, MySQL assumes that by using the key it probably will do many key lookups and that a table scan would be faster.

### MySQL Enterprise

For expert advice on avoiding excessive table scans subscribe to the MySQL Enterprise Monitor. For more information, see <http://www.mysql.com/products/enterprise/advisors.html>.

For small tables, a table scan often is appropriate and the performance impact is negligible. For large tables, try the following techniques to avoid having the optimizer incorrectly choose a table scan:

- Use `ANALYZE TABLE tbl_name` to update the key distributions for the scanned table. See [Section 12.5.2.1, “ANALYZE TABLE Syntax”](#).
- Use `FORCE INDEX` for the scanned table to tell MySQL that table scans are very expensive compared to using the given index:

```
SELECT * FROM t1, t2 FORCE INDEX (index_for_column)
WHERE t1.col_name=t2.col_name;
```

See [Section 12.2.8.2, “Index Hint Syntax”](#).

- Start `mysqld` with the `--max-seeks-for-key=1000` option or use `SET max_seeks_for_key=1000` to tell the optimizer to assume that no key scan causes more than 1,000 key seeks. See [Section 5.1.3, “Server System Variables”](#).

## 7.2.20. INFORMATION\_SCHEMA Optimization

As of MySQL 5.1.23, the implementation of `INFORMATION_SCHEMA` is such that certain types of queries for `INFORMATION_SCHEMA` tables can be optimized to execute more quickly. This section provides guidelines on writing queries that take advantage of these optimizations. In general, the strategies outlined here minimize the need for the server to access the file system to obtain the information that makes up the contents of `INFORMATION_SCHEMA` tables. By writing queries that enable the server to avoid directory scans or opening table files, you will obtain better performance.

### 1) Try to use constant lookup values for database and table names in the WHERE clause

You can take advantage of this principle as follows:

- To look up databases or tables, use expressions that evaluate to a constant, such as literal values, functions that return a constant, or scalar subqueries.
- Avoid queries that use a non-constant database name lookup value (or no lookup value) because they require a scan of the data directory to find matching database directory names.
- Within a database, avoid queries that use a non-constant table name lookup value (or no lookup value) because they require a scan of the database directory to find matching table files.

This principle applies to the `INFORMATION_SCHEMA` tables shown in the following table, which shows the columns for which a constant lookup value enables the server to avoid a directory scan. For example, if you are selecting from `TABLES`, using a constant lookup value for `TABLE_SCHEMA` in the `WHERE` clause enables a data directory scan to be avoided.

Table	Column to specify to avoid data directory scan	Column to specify to avoid database directory scan
<code>COLUMNS</code>	<code>TABLE_SCHEMA</code>	<code>TABLE_NAME</code>
<code>KEY_COLUMN_USAGE</code>	<code>TABLE_SCHEMA</code>	<code>TABLE_NAME</code>
<code>PARTITIONS</code>	<code>TABLE_SCHEMA</code>	<code>TABLE_NAME</code>
<code>REFERENTIAL_CONSTRAINTS</code>	<code>CONSTRAINT_SCHEMA</code>	<code>TABLE_NAME</code>
<code>STATISTICS</code>	<code>TABLE_SCHEMA</code>	<code>TABLE_NAME</code>
<code>TABLES</code>	<code>TABLE_SCHEMA</code>	<code>TABLE_NAME</code>
<code>TABLE_CONSTRAINTS</code>	<code>TABLE_SCHEMA</code>	<code>TABLE_NAME</code>
<code>TRIGGERS</code>	<code>EVENT_OBJECT_SCHEMA</code>	<code>EVENT_OBJECT_TABLE</code>
<code>VIEWS</code>	<code>TABLE_SCHEMA</code>	<code>TABLE_NAME</code>

The benefit of a query that is limited to a specific constant database name is that checks need be made only for the named database directory. Example:

```
SELECT TABLE_NAME FROM INFORMATION_SCHEMA.TABLES
WHERE TABLE_SCHEMA = 'test';
```

Use of the literal database name `test` enables the server to check only the `test` database directory, regardless of how many databases there might be. By contrast, the following query is less efficient because it requires a scan of the data directory to determine which database names match the pattern `'test%'`:

```
SELECT TABLE_NAME FROM INFORMATION_SCHEMA.TABLES
WHERE TABLE_SCHEMA LIKE 'test%';
```

For a query that is limited to a specific constant table name, checks need be made only for the named table within the corresponding database directory. Example:

```
SELECT TABLE_NAME FROM INFORMATION_SCHEMA.TABLES
WHERE TABLE_SCHEMA = 'test' AND TABLE_NAME = 't1';
```

Use of the literal table name `t1` enables the server to check only the files for the `t1` table, regardless of how many tables there might be in the `test` database. By contrast, the following query requires a scan of the `test` database directory to determine which table names match the pattern `'t%'`:

```
SELECT TABLE_NAME FROM INFORMATION_SCHEMA.TABLES
WHERE TABLE_SCHEMA = 'test' AND TABLE_NAME LIKE 't%';
```

The following query requires a scan of the database directory to determine matching database names for the pattern `'test%'`, and for each matching database, it requires a scan of the database directory to determine matching table names for the pattern `'t%'`:

```
SELECT TABLE_NAME FROM INFORMATION_SCHEMA.TABLES
WHERE TABLE_SCHEMA = 'test%' AND TABLE_NAME LIKE 't%';
```

## 2) Write queries that minimize the number of table files that must be opened

For queries that refer to certain `INFORMATION_SCHEMA` table columns, several optimizations are available that minimize the number of table files that must be opened. Example:

```
SELECT TABLE_NAME, ENGINE FROM INFORMATION_SCHEMA.TABLES
WHERE TABLE_SCHEMA = 'test';
```

In this case, after the server has scanned the database directory to determine the names of the tables in the database, those names become available with no further file system lookups. Thus, `TABLE_NAME` requires no files to be opened. The `ENGINE` (storage engine) value can be determined by opening the table's `.frm` file, without touching other table files such as the `.MYD` or `.MYI` file.

Some values, such as `INDEX_LENGTH` for `MyISAM` tables, require opening the `.MYD` or `.MYI` file as well.

The file-opening optimization types are denoted thus:

- `SKIP_OPEN_TABLE`: Table files do not need to be opened. The information has already become available within the query by scanning the database directory.
- `OPEN_FRM_ONLY`: Only the table's `.frm` file need be opened.
- `OPEN_TRIGGER_ONLY`: Only the table's `.TRG` file need be opened.
- `OPEN_FULL_TABLE`: The unoptimized information lookup. The `.frm`, `.MYD`, and `.MYI` files must be opened.

The following list indicates how the preceding optimization types apply to `INFORMATION_SCHEMA` table columns. For tables and columns not named, none of the optimizations apply.

- `COLUMNS`: `OPEN_FRM_ONLY` applies to all columns
- `KEY_COLUMN_USAGE`: `OPEN_FULL_TABLE` applies to all columns
- `PARTITIONS`: `OPEN_FULL_TABLE` applies to all columns
- `REFERENTIAL_CONSTRAINTS`: `OPEN_FULL_TABLE` applies to all columns
- `STATISTICS`:

Column	Optimization type
<code>TABLE_CATALOG</code>	<code>OPEN_FRM_ONLY</code>
<code>TABLE_SCHEMA</code>	<code>OPEN_FRM_ONLY</code>
<code>TABLE_NAME</code>	<code>OPEN_FRM_ONLY</code>
<code>NON_UNIQUE</code>	<code>OPEN_FRM_ONLY</code>
<code>INDEX_SCHEMA</code>	<code>OPEN_FRM_ONLY</code>
<code>INDEX_NAME</code>	<code>OPEN_FRM_ONLY</code>
<code>SEQ_IN_INDEX</code>	<code>OPEN_FRM_ONLY</code>
<code>COLUMN_NAME</code>	<code>OPEN_FRM_ONLY</code>
<code>COLLATION</code>	<code>OPEN_FRM_ONLY</code>
<code>CARDINALITY</code>	<code>OPEN_FULL_TABLE</code>
<code>SUB_PART</code>	<code>OPEN_FRM_ONLY</code>
<code>PACKED</code>	<code>OPEN_FRM_ONLY</code>
<code>NULLABLE</code>	<code>OPEN_FRM_ONLY</code>
<code>INDEX_TYPE</code>	<code>OPEN_FULL_TABLE</code>
<code>COMMENT</code>	<code>OPEN_FRM_ONLY</code>

- `TABLES`:

Column	Optimization type
<code>TABLE_CATALOG</code>	<code>SKIP_OPEN_TABLE</code>
<code>TABLE_SCHEMA</code>	<code>SKIP_OPEN_TABLE</code>
<code>TABLE_NAME</code>	<code>SKIP_OPEN_TABLE</code>
<code>TABLE_TYPE</code>	<code>OPEN_FRM_ONLY</code>
<code>ENGINE</code>	<code>OPEN_FRM_ONLY</code>

VERSION	OPEN_FRM_ONLY
ROW_FORMAT	OPEN_FULL_TABLE
TABLE_ROWS	OPEN_FULL_TABLE
AVG_ROW_LENGTH	OPEN_FULL_TABLE
DATA_LENGTH	OPEN_FULL_TABLE
MAX_DATA_LENGTH	OPEN_FULL_TABLE
INDEX_LENGTH	OPEN_FULL_TABLE
DATA_FREE	OPEN_FULL_TABLE
AUTO_INCREMENT	OPEN_FULL_TABLE
CREATE_TIME	OPEN_FULL_TABLE
UPDATE_TIME	OPEN_FULL_TABLE
CHECK_TIME	OPEN_FULL_TABLE
TABLE_COLLATION	OPEN_FRM_ONLY
CHECKSUM	OPEN_FULL_TABLE
CREATE_OPTIONS	OPEN_FRM_ONLY
TABLE_COMMENT	OPEN_FRM_ONLY

- TABLE\_CONSTRAINTS: OPEN\_FULL\_TABLE applies to all columns
- TRIGGERS: OPEN\_FULL\_TABLE applies to all columns
- VIEWS:

Column	Optimization type
TABLE_CATALOG	OPEN_FRM_ONLY
TABLE_SCHEMA	OPEN_FRM_ONLY
TABLE_NAME	OPEN_FRM_ONLY
VIEW_DEFINITION	OPEN_FULL_TABLE
CHECK_OPTION	OPEN_FULL_TABLE
IS_UPDATABLE	OPEN_FULL_TABLE
DEFINER	OPEN_FULL_TABLE
SECURITY_TYPE	OPEN_FULL_TABLE
CHARACTER_SET_CLIENT	OPEN_FULL_TABLE
COLLATION_CONNECTION	OPEN_FULL_TABLE

**3) Use EXPLAIN to determine whether the server can use INFORMATION\_SCHEMA optimizations for a query**

The Extra value in EXPLAIN output indicates which, if any, of the optimizations described earlier the server can use to evaluate INFORMATION\_SCHEMA queries. The following examples demonstrate the kinds of information you can expect to see in the Extra value.

```
mysql> EXPLAIN SELECT TABLE_NAME FROM INFORMATION_SCHEMA.VIEWS WHERE
-> TABLE_SCHEMA = 'test' AND TABLE_NAME = 'v1'\G
***** 1. row *****
   id: 1
  select_type: SIMPLE
    table: VIEWS
     type: ALL
possible_keys: NULL
      key: TABLE_SCHEMA, TABLE_NAME
    key_len: NULL
       ref: NULL
      rows: NULL
   Extra: Using where; Open_frm_only; Scanned 0 databases
```

Use of constant database and table lookup values enables the server to avoid directory scans. For references to VIEWS.TABLE\_NAME, only the .frm file need be opened.

```
mysql> EXPLAIN SELECT TABLE_NAME, ROW_FORMAT FROM INFORMATION_SCHEMA.TABLES\G
***** 1. row *****
      id: 1
    select_type: SIMPLE
      table: TABLES
       type: ALL
possible_keys: NULL
         key: NULL
      key_len: NULL
         ref: NULL
        rows: NULL
      Extra: Open_full_table; Scanned all databases
```

No lookup values are provided (there is no `WHERE` clause), so the server must scan the data directory and each database directory. For each table thus identified, the table name and row format are selected. `TABLE_NAME` requires no further table files to be opened (the `SKIP_OPEN_TABLE` optimization applies). `ROW_FORMAT` requires all table files to be opened (`OPEN_FULL_TABLE` applies). `EXPLAIN` reports `OPEN_FULL_TABLE` because it is more expensive than `SKIP_OPEN_TABLE`.

```
mysql> EXPLAIN SELECT TABLE_NAME, TABLE_TYPE FROM INFORMATION_SCHEMA.TABLES
-> WHERE TABLE_SCHEMA = 'test'\G
***** 1. row *****
      id: 1
    select_type: SIMPLE
      table: TABLES
       type: ALL
possible_keys: NULL
         key: TABLE_SCHEMA
      key_len: NULL
         ref: NULL
        rows: NULL
      Extra: Using where; Open_frm_only; Scanned 1 database
```

No table name lookup value is provided, so the server must scan the `test` database directory. For the `TABLE_NAME` and `TABLE_TYPE` columns, the `SKIP_OPEN_TABLE` and `OPEN_FRM_ONLY` optimizations apply, respectively. `EXPLAIN` reports `OPEN_FRM_ONLY` because it is more expensive.

```
mysql> EXPLAIN SELECT B.TABLE_NAME
-> FROM INFORMATION_SCHEMA.TABLES AS A, INFORMATION_SCHEMA.COLUMNS AS B
-> WHERE A.TABLE_SCHEMA = 'test'
-> AND A.TABLE_NAME = 't1'
-> AND B.TABLE_NAME = A.TABLE_NAME\G
***** 1. row *****
      id: 1
    select_type: SIMPLE
      table: A
       type: ALL
possible_keys: NULL
         key: TABLE_SCHEMA, TABLE_NAME
      key_len: NULL
         ref: NULL
        rows: NULL
      Extra: Using where; Skip_open_table; Scanned 0 databases
***** 2. row *****
      id: 1
    select_type: SIMPLE
      table: B
       type: ALL
possible_keys: NULL
         key: NULL
      key_len: NULL
         ref: NULL
        rows: NULL
      Extra: Using where; Open_frm_only; Scanned all databases;
           Using join buffer
```

For the first `EXPLAIN` output row: Constant database and table lookup values enable the server to avoid directory scans for `TABLES` values. References to `TABLES.TABLE_NAME` require no further table files.

For the second `EXPLAIN` output row: All `COLUMNS` table values are `OPEN_FRM_ONLY` lookups, so `COLUMNS.TABLE_NAME` requires the `.frm` file to be opened.

```
mysql> EXPLAIN SELECT * FROM INFORMATION_SCHEMA.COLLATIONS\G
***** 1. row *****
      id: 1
    select_type: SIMPLE
      table: COLLATIONS
       type: ALL
possible_keys: NULL
         key: NULL
      key_len: NULL
         ref: NULL
        rows: NULL
      Extra:
```

In this case, no optimizations apply because `COLLATIONS` is not one of the `INFORMATION_SCHEMA` tables for which optimizations are available.

## 7.2.21. Speed of `INSERT` Statements

The time required for inserting a row is determined by the following factors, where the numbers indicate approximate proportions:

- Connecting: (3)
- Sending query to server: (2)
- Parsing query: (2)
- Inserting row: ( $1 \times$  size of row)
- Inserting indexes: ( $1 \times$  number of indexes)
- Closing: (1)

This does not take into consideration the initial overhead to open tables, which is done once for each concurrently running query.

The size of the table slows down the insertion of indexes by  $\log N$ , assuming B-tree indexes.

You can use the following methods to speed up inserts:

- If you are inserting many rows from the same client at the same time, use `INSERT` statements with multiple `VALUES` lists to insert several rows at a time. This is considerably faster (many times faster in some cases) than using separate single-row `INSERT` statements. If you are adding data to a non-empty table, you can tune the `bulk_insert_buffer_size` variable to make data insertion even faster. See [Section 5.1.3, “Server System Variables”](#).
- If multiple clients are inserting a lot of rows, you can get higher speed by using the `INSERT DELAYED` statement. See [Section 12.2.5.2, “INSERT DELAYED Syntax”](#).
- For a `MyISAM` table, you can use concurrent inserts to add rows at the same time that `SELECT` statements are running, if there are no deleted rows in middle of the data file. See [Section 7.3.3, “Concurrent Inserts”](#).
- When loading a table from a text file, use `LOAD DATA INFILE`. This is usually 20 times faster than using `INSERT` statements. See [Section 12.2.6, “LOAD DATA INFILE Syntax”](#).
- With some extra work, it is possible to make `LOAD DATA INFILE` run even faster for a `MyISAM` table when the table has many indexes. Use the following procedure:
  1. Optionally create the table with `CREATE TABLE`.
  2. Execute a `FLUSH TABLES` statement or a `mysqladmin flush-tables` command.
  3. Use `myisamchk --keys-used=0 -rq /path/to/db/tbl_name`. This removes all use of indexes for the table.
  4. Insert data into the table with `LOAD DATA INFILE`. This does not update any indexes and therefore is very fast.
  5. If you intend only to read from the table in the future, use `myisampack` to compress it. See [Section 13.4.3.3, “Compressed Table Characteristics”](#).
  6. Re-create the indexes with `myisamchk -rq /path/to/db/tbl_name`. This creates the index tree in memory before writing it to disk, which is much faster than updating the index during `LOAD DATA INFILE` because it avoids lots of disk seeks. The resulting index tree is also perfectly balanced.
  7. Execute a `FLUSH TABLES` statement or a `mysqladmin flush-tables` command.

`LOAD DATA INFILE` performs the preceding optimization automatically if the `MyISAM` table into which you insert data is empty. The main difference between automatic optimization and using the procedure explicitly is that you can let `myisamchk` allocate much more temporary memory for the index creation than you might want the server to allocate for index re-creation when it executes the `LOAD DATA INFILE` statement.

You can also disable or enable the non-unique indexes for a `MyISAM` table by using the following statements rather than `myisamchk`. If you use these statements, you can skip the `FLUSH TABLE` operations:

```
ALTER TABLE tbl_name DISABLE KEYS;
ALTER TABLE tbl_name ENABLE KEYS;
```

- To speed up `INSERT` operations that are performed with multiple statements for non-transactional tables, lock your tables:

```
LOCK TABLES a WRITE;
INSERT INTO a VALUES (1,23),(2,34),(4,33);
INSERT INTO a VALUES (8,26),(6,29);
...
UNLOCK TABLES;
```

This benefits performance because the index buffer is flushed to disk only once, after all `INSERT` statements have completed. Normally, there would be as many index buffer flushes as there are `INSERT` statements. Explicit locking statements are not needed if you can insert all rows with a single `INSERT`.

To obtain faster insertions for transactional tables, you should use `START TRANSACTION` and `COMMIT` instead of `LOCK TABLES`.

Locking also lowers the total time for multiple-connection tests, although the maximum wait time for individual connections might go up because they wait for locks. Suppose that five clients attempt to perform inserts simultaneously as follows:

- Connection 1 does 1000 inserts
- Connections 2, 3, and 4 do 1 insert
- Connection 5 does 1000 inserts

If you do not use locking, connections 2, 3, and 4 finish before 1 and 5. If you use locking, connections 2, 3, and 4 probably do not finish before 1 or 5, but the total time should be about 40% faster.

`INSERT`, `UPDATE`, and `DELETE` operations are very fast in MySQL, but you can obtain better overall performance by adding locks around everything that does more than about five successive inserts or updates. If you do very many successive inserts, you could do a `LOCK TABLES` followed by an `UNLOCK TABLES` once in a while (each 1,000 rows or so) to allow other threads access to the table. This would still result in a nice performance gain.

`INSERT` is still much slower for loading data than `LOAD DATA INFILE`, even when using the strategies just outlined.

- To increase performance for `MyISAM` tables, for both `LOAD DATA INFILE` and `INSERT`, enlarge the key cache by increasing the `key_buffer_size` system variable. See [Section 7.5.3, “Tuning Server Parameters”](#).

#### MySQL Enterprise

For more advice on optimizing the performance of your server, subscribe to the MySQL Enterprise Monitor. Numerous advisors are dedicated to monitoring performance. For more information, see <http://www.mysql.com/products/enterprise/advisors.html>.

## 7.2.22. Speed of `UPDATE` Statements

An update statement is optimized like a `SELECT` query with the additional overhead of a write. The speed of the write depends on the amount of data being updated and the number of indexes that are updated. Indexes that are not changed do not get updated.

Another way to get fast updates is to delay updates and then do many updates in a row later. Performing multiple updates together is much quicker than doing one at a time if you lock the table.

For a `MyISAM` table that uses dynamic row format, updating a row to a longer total length may split the row. If you do this often, it is very important to use `OPTIMIZE TABLE` occasionally. See [Section 12.5.2.5, “OPTIMIZE TABLE Syntax”](#).

## 7.2.23. Speed of `DELETE` Statements

The time required to delete individual rows is exactly proportional to the number of indexes. To delete rows more quickly, you can increase the size of the key cache by increasing the `key_buffer_size` system variable. See [Section 7.5.3, “Tuning Server Parameters”](#).

To delete all rows from a table, `TRUNCATE TABLE tbl_name` is faster than `DELETE FROM tbl_name`. Truncate operations are not transaction-safe; an error occurs when attempting one in the course of an active transaction or active table lock. See [Section 12.2.10, “TRUNCATE Syntax”](#).

## 7.2.24. Other Optimization Tips



This section lists a number of miscellaneous tips for improving query processing speed:

- Use persistent connections to the database to avoid connection overhead. If you cannot use persistent connections and you are initiating many new connections to the database, you may want to change the value of the `thread_cache_size` variable. See [Section 7.5.3, “Tuning Server Parameters”](#).
- Always check whether all your queries really use the indexes that you have created in the tables. In MySQL, you can do this with the `EXPLAIN` statement. See [Section 7.2.1, “Optimizing Queries with EXPLAIN”](#).
- Try to avoid complex `SELECT` queries on `MyISAM` tables that are updated frequently, to avoid problems with table locking that occur due to contention between readers and writers.
- `MyISAM` supports concurrent inserts: If a table has no free blocks in the middle of the data file, you can `INSERT` new rows into it at the same time that other threads are reading from the table. If it is important to be able to do this, you should consider using the table in ways that avoid deleting rows. Another possibility is to run `OPTIMIZE TABLE` to defragment the table after you have deleted a lot of rows from it. This behavior is altered by setting the `concurrent_insert` variable. You can force new rows to be appended (and therefore allow concurrent inserts), even in tables that have deleted rows. See [Section 7.3.3, “Concurrent Inserts”](#).

**MySQL Enterprise**

For optimization tips geared to your specific circumstances subscribe to the MySQL Enterprise Monitor. For more information, see <http://www.mysql.com/products/enterprise/advisors.html>.

- To fix any compression issues that may have occurred with `ARCHIVE` tables, you can use `OPTIMIZE TABLE`. See [Section 13.11, “The ARCHIVE Storage Engine”](#).
- Use `ALTER TABLE ... ORDER BY expr1, expr2, ...` if you usually retrieve rows in `expr1`, `expr2`, ... order. By using this option after extensive changes to the table, you may be able to get higher performance.
- In some cases, it may make sense to introduce a column that is “hashed” based on information from other columns. If this column is short, reasonably unique, and indexed, it may be much faster than a “wide” index on many columns. In MySQL, it is very easy to use this extra column:

```
SELECT * FROM tbl_name
WHERE hash_col=MD5(CONCAT(col1,col2))
AND col1='constant' AND col2='constant';
```

- For `MyISAM` tables that change frequently, you should try to avoid all variable-length columns (`VARCHAR`, `BLOB`, and `TEXT`). The table uses dynamic row format if it includes even a single variable-length column. See [Chapter 13, Storage Engines](#).
- It is normally not useful to split a table into different tables just because the rows become large. In accessing a row, the biggest performance hit is the disk seek needed to find the first byte of the row. After finding the data, most modern disks can read the entire row fast enough for most applications. The only cases where splitting up a table makes an appreciable difference is if it is a `MyISAM` table using dynamic row format that you can change to a fixed row size, or if you very often need to scan the table but do not need most of the columns. See [Chapter 13, Storage Engines](#).
- If you often need to calculate results such as counts based on information from a lot of rows, it may be preferable to introduce a new table and update the counter in real time. An update of the following form is very fast:

```
UPDATE tbl_name SET count_col=count_col+1 WHERE key_col=constant;
```

This is very important when you use MySQL storage engines such as `MyISAM` that has only table-level locking (multiple readers with single writers). This also gives better performance with most database systems, because the row locking manager in this case has less to do.

- If you need to collect statistics from large log tables, use summary tables instead of scanning the entire log table. Maintaining the summaries should be much faster than trying to calculate statistics “live.” Regenerating new summary tables from the logs when things change (depending on business decisions) is faster than changing the running application.
- If possible, you should classify reports as “live” or as “statistical,” where data needed for statistical reports is created only from summary tables that are generated periodically from the live data.
- Take advantage of the fact that columns have default values. Insert values explicitly only when the value to be inserted differs from the default. This reduces the parsing that MySQL must do and improves the insert speed.
- In some cases, it is convenient to pack and store data into a `BLOB` column. In this case, you must provide code in your application to pack and unpack information, but this may save a lot of accesses at some stage. This is practical when you have data that does not conform well to a rows-and-columns table structure.

- 
- Normally, you should try to keep all data non-redundant (observing what is referred to in database theory as *third normal form*). However, there may be situations in which it can be advantageous to duplicate information or create summary tables to gain more speed.
  - Stored routines or UDFs (user-defined functions) may be a good way to gain performance for some tasks. See [Section 18.2, “Using Stored Routines \(Procedures and Functions\)”](#), and [Section 21.3, “Adding New Functions to MySQL”](#), for more information.
  - You can increase performance by caching queries or answers in your application and then executing many inserts or updates together. If your database system supports table locks, this should help to ensure that the index cache is only flushed once after all updates. You can also take advantage of MySQL's query cache to achieve similar results; see [Section 7.5.5, “The MySQL Query Cache”](#).
  - Use `INSERT DELAYED` when you do not need to know when your data is written. This reduces the overall insertion impact because many rows can be written with a single disk write.
  - Use `INSERT LOW_PRIORITY` when you want to give `SELECT` statements higher priority than your inserts.

Use `SELECT HIGH_PRIORITY` to get retrievals that jump the queue. That is, the `SELECT` is executed even if there is another client waiting to do a write.

`LOW_PRIORITY` and `HIGH_PRIORITY` have an effect only for storage engines that use only table-level locking (`MyISAM`, `MEMORY`, `MERGE`).

- Use multiple-row `INSERT` statements to store many rows with one SQL statement. Many SQL servers support this, including MySQL.
- Use `LOAD DATA INFILE` to load large amounts of data. This is faster than using `INSERT` statements.
- Use `AUTO_INCREMENT` columns so that each row in a table can be identified by a single unique value.
- Use `OPTIMIZE TABLE` once in a while to avoid fragmentation with dynamic-format `MyISAM` tables. See [Section 13.4.3, “MyISAM Table Storage Formats”](#).
- Use `MEMORY` tables when possible to get more speed. See [Section 13.8, “The MEMORY \(HEAP\) Storage Engine”](#). `MEMORY` tables are useful for non-critical data that is accessed often, such as information about the last displayed banner for users who don't have cookies enabled in their Web browser. User sessions are another alternative available in many Web application environments for handling volatile state data.
- With Web servers, images and other binary assets should normally be stored as files. That is, store only a reference to the file rather than the file itself in the database. Most Web servers are better at caching files than database contents, so using files is generally faster.
- Columns with identical information in different tables should be declared to have identical data types so that joins based on the corresponding columns will be faster.
- Try to keep column names simple. For example, in a table named `customer`, use a column name of `name` instead of `customer_name`. To make your names portable to other SQL servers, you should keep them shorter than 18 characters.
- If you need really high speed, you should take a look at the low-level interfaces for data storage that the different SQL servers support. For example, by accessing the MySQL `MyISAM` storage engine directly, you could get a speed increase of two to five times compared to using the SQL interface. To be able to do this, the data must be on the same server as the application, and usually it should only be accessed by one process (because external file locking is really slow). One could eliminate these problems by introducing low-level `MyISAM` commands in the MySQL server (this could be one easy way to get more performance if needed). By carefully designing the database interface, it should be quite easy to support this type of optimization.
- If you are using numerical data, it is faster in many cases to access information from a database (using a live connection) than to access a text file. Information in the database is likely to be stored in a more compact format than in the text file, so accessing it involves fewer disk accesses. You also save code in your application because you need not parse your text files to find line and column boundaries.
- Replication can provide a performance benefit for some operations. You can distribute client retrievals among replication servers to split up the load. To avoid slowing down the master while making backups, you can make backups using a slave server. See [Chapter 16, Replication](#).
- Declaring a `MyISAM` table with the `DELAY_KEY_WRITE=1` table option makes index updates faster because they are not flushed to disk until the table is closed. The downside is that if something kills the server while such a table is open, you should ensure that the table is okay by running the server with the `--myisam-recover` option, or by running `myisamchk` before restarting the server. (However, even in this case, you should not lose anything by using `DELAY_KEY_WRITE`, because the key information can always be generated from the data rows.)

## 7.3. Locking Issues

MySQL manages contention for table contents using locking:

- Internal locking is performed within the MySQL server itself to manage contention for table contents by multiple threads. This type of locking is internal because it is performed entirely by the server and involves no other programs. See [Section 7.3.1, “Internal Locking Methods”](#).
- External locking occurs when the server and other programs lock table files to coordinate among themselves which program can access the tables at which time. See [Section 7.3.4, “External Locking”](#).

### 7.3.1. Internal Locking Methods

This section discusses internal locking; that is, locking performed within the MySQL server itself to manage contention for table contents by multiple sessions. This type of locking is internal because it is performed entirely by the server and involves no other programs. External locking occurs when the server and other programs lock table files to coordinate among themselves which program can access the tables at which time. See [Section 7.3.4, “External Locking”](#).

MySQL uses table-level locking for [MyISAM](#), [MEMORY](#), and [MERGE](#) tables, and row-level locking for [InnoDB](#) tables.

In many cases, you can make an educated guess about which locking type is best for an application, but generally it is difficult to say that a given lock type is better than another. Everything depends on the application and different parts of an application may require different lock types.

To decide whether you want to use a storage engine with row-level locking, you should look at what your application does and what mix of select and update statements it uses. For example, most Web applications perform many selects, relatively few deletes, updates based mainly on key values, and inserts into a few specific tables. The base MySQL [MyISAM](#) setup is very well tuned for this.

#### MySQL Enterprise

The MySQL Enterprise Monitor provides expert advice on when to use table-level locking and when to use row-level locking. To subscribe see <http://www.mysql.com/products/enterprise/advisors.html>.

Table locking in MySQL is deadlock-free for storage engines that use table-level locking. Deadlock avoidance is managed by always requesting all needed locks at once at the beginning of a query and always locking the tables in the same order.

MySQL grants table write locks as follows:

1. If there are no locks on the table, put a write lock on it.
2. Otherwise, put the lock request in the write lock queue.

MySQL grants table read locks as follows:

1. If there are no write locks on the table, put a read lock on it.
2. Otherwise, put the lock request in the read lock queue.

Table updates are given higher priority than table retrievals. Therefore, when a lock is released, the lock is made available to the requests in the write lock queue and then to the requests in the read lock queue. This ensures that updates to a table are not “starved” even if there is heavy [SELECT](#) activity for the table. However, if you have many updates for a table, [SELECT](#) statements wait until there are no more updates.

For information on altering the priority of reads and writes, see [Section 7.3.2, “Table Locking Issues”](#).

You can analyze the table lock contention on your system by checking the `Table_locks_immediate` and `Table_locks_waited` status variables, which indicate the number of times that requests for table locks could be granted immediately and the number that had to wait, respectively:

```
mysql> SHOW STATUS LIKE 'Table%';
+-----+-----+
| Variable_name | Value |
+-----+-----+
| Table_locks_immediate | 1151552 |
| Table_locks_waited | 15324 |
+-----+-----+
```

The `MyISAM` storage engine supports concurrent inserts to reduce contention between readers and writers for a given table: If a `MyISAM` table has no free blocks in the middle of the data file, rows are always inserted at the end of the data file. In this case, you can freely mix concurrent `INSERT` and `SELECT` statements for a `MyISAM` table without locks. That is, you can insert rows into a `MyISAM` table at the same time other clients are reading from it. Holes can result from rows having been deleted from or updated in the middle of the table. If there are holes, concurrent inserts are disabled but are enabled again automatically when all holes have been filled with new data.. This behavior is altered by the `concurrent_insert` system variable. See [Section 7.3.3](#), “Concurrent Inserts”.

If you acquire a table lock explicitly with `LOCK TABLES`, you can request a `READ LOCAL` lock rather than a `READ` lock to enable other sessions to perform concurrent inserts while you have the table locked.

To perform many `INSERT` and `SELECT` operations on a table `real_table` when concurrent inserts are not possible, you can insert rows into a temporary table `temp_table` and update the real table with the rows from the temporary table periodically. This can be done with the following code:

```
mysql> LOCK TABLES real_table WRITE, temp_table WRITE;
mysql> INSERT INTO real_table SELECT * FROM temp_table;
mysql> DELETE FROM temp_table;
mysql> UNLOCK TABLES;
```

`InnoDB` uses row locks. Deadlocks are possible for `InnoDB` because it automatically acquires locks during the processing of SQL statements, not at the start of the transaction.

Advantages of row-level locking:

- Fewer lock conflicts when different sessions access different rows
- Fewer changes for rollbacks
- Possible to lock a single row for a long time

Disadvantages of row-level locking:

- Requires more memory than table-level locks
- Slower than table-level locks when used on a large part of the table because you must acquire many more locks
- Slower than other locks if you often do `GROUP BY` operations on a large part of the data or if you must scan the entire table frequently

Generally, table locks are superior to row-level locks in the following cases:

- Most statements for the table are reads
- Statements for the table are a mix of reads and writes, where writes are updates or deletes for a single row that can be fetched with one key read:

```
UPDATE tbl_name SET column=value WHERE unique_key_col=key_value;
DELETE FROM tbl_name WHERE unique_key_col=key_value;
```

- `SELECT` combined with concurrent `INSERT` statements, and very few `UPDATE` or `DELETE` statements
- Many scans or `GROUP BY` operations on the entire table without any writers

With higher-level locks, you can more easily tune applications by supporting locks of different types, because the lock overhead is less than for row-level locks.

Options other than row-level locking:

- Versioning (such as that used in MySQL for concurrent inserts) where it is possible to have one writer at the same time as many readers. This means that the database or table supports different views for the data depending on when access begins. Other common terms for this are “time travel,” “copy on write,” or “copy on demand.”
- Copy on demand is in many cases superior to row-level locking. However, in the worst case, it can use much more memory than using normal locks.

- Instead of using row-level locks, you can employ application-level locks, such as those provided by `GET_LOCK()` and `RELEASE_LOCK()` in MySQL. These are advisory locks, so they work only with applications that cooperate with each other. See Section 11.11.4, “Miscellaneous Functions”.

## 7.3.2. Table Locking Issues

To achieve a very high lock speed, MySQL uses table locking (instead of page, row, or column locking) for all storage engines except `InnoDB` and `NDBCLUSTER`.

For `InnoDB` tables, MySQL uses table locking only if you explicitly lock the table with `LOCK TABLES`. For this storage engine, we recommend that you not use `LOCK TABLES` at all, because `InnoDB` uses automatic row-level locking to ensure transaction isolation.

For large tables, table locking is often better than row locking, but there are some disadvantages:

- Table locking enables many sessions to read from a table at the same time, but if a session wants to write to a table, it must first get exclusive access. During the update, all other sessions that want to access this particular table must wait until the update is done.
- Table locking causes problems in cases such as when a session is waiting because the disk is full and free space needs to become available before the session can proceed. In this case, all sessions that want to access the problem table are also put in a waiting state until more disk space is made available.

Table locking is also disadvantageous under the following scenario:

- A session issues a `SELECT` that takes a long time to run.
- Another session then issues an `UPDATE` on the same table. This session waits until the `SELECT` is finished.
- Another session issues another `SELECT` statement on the same table. Because `UPDATE` has higher priority than `SELECT`, this `SELECT` waits for the `UPDATE` to finish, *after* waiting for the first `SELECT` to finish.

The following items describe some ways to avoid or reduce contention caused by table locking:

- Try to get the `SELECT` statements to run faster so that they lock tables for a shorter time. You might have to create some summary tables to do this.
- Start `mysqld` with `--low-priority-updates`. For storage engines that use only table-level locking (`MyISAM`, `MEMORY`, `MERGE`), this gives all statements that update (modify) a table lower priority than `SELECT` statements. In this case, the second `SELECT` statement in the preceding scenario would execute before the `UPDATE` statement, and would not need to wait for the first `SELECT` to finish.
- To specify that all updates issued in a specific connection should be done with low priority, use the `SET LOW_PRIORITY_UPDATES=1` statement. See Section 5.1.4, “Session System Variables”.
- To give a specific `INSERT`, `UPDATE`, or `DELETE` statement lower priority, use the `LOW_PRIORITY` attribute.
- To give a specific `SELECT` statement higher priority, use the `HIGH_PRIORITY` attribute. See Section 12.2.8, “SELECT Syntax”.
- Start `mysqld` with a low value for the `max_write_lock_count` system variable to force MySQL to temporarily elevate the priority of all `SELECT` statements that are waiting for a table after a specific number of inserts to the table occur. This allows `READ` locks after a certain number of `WRITE` locks.
- If you have problems with `INSERT` combined with `SELECT`, consider switching to `MyISAM` tables, which support concurrent `SELECT` and `INSERT` statements. (See Section 7.3.3, “Concurrent Inserts”.)
- If you mix inserts and deletes on the same table, `INSERT DELAYED` may be of great help. See Section 12.2.5.2, “INSERT DELAYED Syntax”.
- If you have problems with mixed `SELECT` and `DELETE` statements, the `LIMIT` option to `DELETE` may help. See Section 12.2.2, “DELETE Syntax”.
- Using `SQL_BUFFER_RESULT` with `SELECT` statements can help to make the duration of table locks shorter. See Section 12.2.8, “SELECT Syntax”.

- You could change the locking code in `mysys/thr_lock.c` to use a single queue. In this case, write locks and read locks would have the same priority, which might help some applications.

Here are some tips concerning table locks in MySQL:

- Concurrent users are not a problem if you do not mix updates with selects that need to examine many rows in the same table.
- You can use `LOCK TABLES` to increase speed, because many updates within a single lock is much faster than updating without locks. Splitting table contents into separate tables may also help.
- If you encounter speed problems with table locks in MySQL, you may be able to improve performance by converting some of your tables to `InnoDB`. See [Section 13.6, “The InnoDB Storage Engine”](#).

#### MySQL Enterprise

Lock contention can seriously degrade performance. The MySQL Enterprise Monitor provides expert advice on avoiding this problem. To subscribe, see <http://www.mysql.com/products/enterprise/advisors.html>.

### 7.3.3. Concurrent Inserts

The `MyISAM` storage engine supports concurrent inserts to reduce contention between readers and writers for a given table: If a `MyISAM` table has no holes in the data file (deleted rows in the middle), inserts can be performed to add rows to the end of the table at the same time that `SELECT` statements are reading rows from the table.

The `concurrent_insert` system variable can be set to modify the concurrent-insert processing. By default, the variable is set to 1 and concurrent inserts are handled as just described. If `concurrent_insert` is set to 0, concurrent inserts are disabled. If the variable is set to 2, concurrent inserts at the end of the table are allowed even for tables that have deleted rows. See also the description of the `concurrent_insert` system variable.

Under circumstances where concurrent inserts can be used, there is seldom any need to use the `DELAYED` modifier for `INSERT` statements. See [Section 12.2.5.2, “INSERT DELAYED Syntax”](#).

If you are using the binary log, concurrent inserts are converted to normal inserts for `CREATE ... SELECT` or `INSERT ... SELECT` statements. This is done to ensure that you can re-create an exact copy of your tables by applying the log during a backup operation. See [Section 5.2.4, “The Binary Log”](#). In addition, for those statements a read lock is placed on the selected-from table such that inserts into that table are blocked. The effect is that concurrent inserts for that table must wait as well.

With `LOAD DATA INFILE`, if you specify `CONCURRENT` with a `MyISAM` table that satisfies the condition for concurrent inserts (that is, it contains no free blocks in the middle), other sessions can retrieve data from the table while `LOAD DATA` is executing. Use of the `CONCURRENT` option affects the performance of `LOAD DATA` a bit, even if no other session is using the table at the same time.

If you specify `HIGH_PRIORITY`, it overrides the effect of the `--low-priority-updates` option if the server was started with that option. It also causes concurrent inserts not to be used.

For `LOCK TABLE`, the difference between `READ LOCAL` and `READ` is that `READ LOCAL` allows non-conflicting `INSERT` statements (concurrent inserts) to execute while the lock is held. However, this cannot be used if you are going to manipulate the database using processes external to the server while you hold the lock.

### 7.3.4. External Locking

External locking is the use of file system locking to manage contention for database tables by multiple processes. External locking is used in situations where a single process such as the MySQL server cannot be assumed to be the only process that requires access to tables. Here are some examples:

- If you run multiple servers that use the same database directory (not recommended), each server must have external locking enabled.
- If you use `myisamchk` to perform table maintenance operations on `MyISAM` tables, you must either ensure that the server is not running, or that the server has external locking enabled so that it locks table files as necessary to coordinate with `myisamchk` for access to the tables. The same is true for use of `myisampack` to pack `MyISAM` tables.

If the server is run with external locking enabled, you can use `myisamchk` at any time for read operations such as checking tables. In this case, if the server tries to update a table that `myisamchk` is using, the server will wait for `myisamchk` to finish before it continues.

If you use `myisamchk` for write operations such as repairing or optimizing tables, or if you use `myisampack` to pack tables,



you *must* always ensure that the `mysqld` server is not using the table. If you don't stop `mysqld`, you should at least do a `mysqldadmin flush-tables` before you run `myisamchk`. Your tables *may become corrupted* if the server and `myisamchk` access the tables simultaneously.

With external locking in effect, each process that requires access to a table acquires a file system lock for the table files before proceeding to access the table. If all necessary locks cannot be acquired, the process is blocked from accessing the table until the locks can be obtained (after the process that currently holds the locks releases them).

External locking affects server performance because the server must sometimes wait for other processes before it can access tables.

External locking is unnecessary if you run a single server to access a given data directory (which is the usual case) and if no other programs such as `myisamchk` need to modify tables while the server is running. If you only *read* tables with other programs, external locking is not required, although `myisamchk` might report warnings if the server changes tables while `myisamchk` is reading them.

With external locking disabled, to use `myisamchk`, you must either stop the server while `myisamchk` executes or else lock and flush the tables before running `myisamchk`. (See [Section 7.5.2, “System Factors and Startup Parameter Tuning”](#).) To avoid this requirement, use the `CHECK TABLE` and `REPAIR TABLE` statements to check and repair `MyISAM` tables.

For `mysqld`, external locking is controlled by the value of the `skip_external_locking` system variable. When this variable is enabled, external locking is disabled, and vice versa. From MySQL 4.0 on, external locking is disabled by default. Before MySQL 4.0, external locking is enabled by default on Linux or when MySQL is configured to use MIT-pthreads.

Use of external locking can be controlled at server startup by using the `--external-locking` or `--skip-external-locking` option.

If you do use external locking option to enable updates to `MyISAM` tables from many MySQL processes, you must ensure that the following conditions are satisfied:

- You should not use the query cache for queries that use tables that are updated by another process.
- You should not start the server with the `--delay-key-write=ALL` option or use the `DELAY_KEY_WRITE=1` table option for any shared tables. Otherwise, index corruption can occur.

The easiest way to satisfy these conditions is to always use `--external-locking` together with `--delay-key-write=OFF` and `--query-cache-size=0`. (This is not done by default because in many setups it is useful to have a mixture of the preceding options.)

## 7.4. Optimizing Database Structure

### 7.4.1. Make Your Data as Small as Possible

One of the most basic optimizations is to design your tables to take as little space on the disk as possible. This can result in huge improvements because disk reads are faster, and smaller tables normally require less main memory while their contents are being actively processed during query execution. Indexing also is a lesser resource burden if done on smaller columns.

MySQL supports many different storage engines (table types) and row formats. For each table, you can decide which storage and indexing method to use. Choosing the proper table format for your application may give you a big performance gain. See [Chapter 13, Storage Engines](#).

You can get better performance for a table and minimize storage space by using the techniques listed here:

- Use the most efficient (smallest) data types possible. MySQL has many specialized types that save disk space and memory. For example, use the smaller integer types if possible to get smaller tables. `MEDIUMINT` is often a better choice than `INT` because a `MEDIUMINT` column uses 25% less space.
- Declare columns to be `NOT NULL` if possible. It makes everything faster and you save one bit per column. If you really need `NULL` in your application, you should definitely use it. Just avoid having it on all columns by default.
- For `MyISAM` tables, if you do not have any variable-length columns (`VARCHAR`, `TEXT`, or `BLOB` columns), a fixed-size row format is used. This is faster but unfortunately may waste some space. See [Section 13.4.3, “MyISAM Table Storage Formats”](#). You can hint that you want to have fixed length rows even if you have `VARCHAR` columns with the `CREATE TABLE` option `ROW_FORMAT=FIXED`.
- `InnoDB` tables use a compact storage format. In versions of MySQL earlier than 5.0.3, `InnoDB` rows contain some redundant information, such as the number of columns and the length of each column, even for fixed-size columns. By default, tables are

created in the compact format (`ROW_FORMAT=COMPACT`). If you wish to downgrade to older versions of MySQL, you can request the old format with `ROW_FORMAT=REDUNDANT`.

The presence of the compact row format decreases row storage space by about 20% at the cost of increasing CPU use for some operations. If your workload is a typical one that is limited by cache hit rates and disk speed it is likely to be faster. If it is a rare case that is limited by CPU speed, it might be slower.

The compact `InnoDB` format also changes how `CHAR` columns containing UTF-8 data are stored. With `ROW_FORMAT=REDUNDANT`, a UTF-8 `CHAR(N)` occupies  $3 \times N$  bytes, given that the maximum length of a UTF-8 encoded character is three bytes. Many languages can be written primarily using single-byte UTF-8 characters, so a fixed storage length often wastes space. With `ROW_FORMAT=COMPACT` format, `InnoDB` allocates a variable amount of storage in the range from  $N$  to  $3 \times N$  bytes for these columns by stripping trailing spaces if necessary. The minimum storage length is kept as  $N$  bytes to facilitate in-place updates in typical cases.

- The primary index of a table should be as short as possible. This makes identification of each row easy and efficient.
- Create only the indexes that you really need. Indexes are good for retrieval but bad when you need to store data quickly. If you access a table mostly by searching on a combination of columns, create an index on them. The first part of the index should be the column most used. If you *always* use many columns when selecting from the table, you should use the column with more duplicates first to obtain better compression of the index.
- If it is very likely that a string column has a unique prefix on the first number of characters, it is better to index only this prefix, using MySQL's support for creating an index on the leftmost part of the column (see [Section 12.1.13](#), “`CREATE INDEX Syntax`”). Shorter indexes are faster, not only because they require less disk space, but because they also give you more hits in the index cache, and thus fewer disk seeks. See [Section 7.5.3](#), “`Tuning Server Parameters`”.
- In some circumstances, it can be beneficial to split into two a table that is scanned very often. This is especially true if it is a dynamic-format table and it is possible to use a smaller static format table that can be used to find the relevant rows when scanning the table.

## 7.4.2. Column Indexes

All MySQL data types can be indexed. Use of indexes on the relevant columns is the best way to improve the performance of `SELECT` operations.

The maximum number of indexes per table and the maximum index length is defined per storage engine. See [Chapter 13](#), *Storage Engines*. All storage engines support at least 16 indexes per table and a total index length of at least 256 bytes. Most storage engines have higher limits.

With `col_name(N)` syntax in an index specification, you can create an index that uses only the first  $N$  characters of a string column. Indexing only a prefix of column values in this way can make the index file much smaller. When you index a `BLOB` or `TEXT` column, you *must* specify a prefix length for the index. For example:

```
CREATE TABLE test (blob_col BLOB, INDEX(blob_col(10)));
```

Prefixes can be up to 1000 bytes long (767 bytes for `InnoDB` tables). Note that prefix limits are measured in bytes, whereas the prefix length in `CREATE TABLE` statements is interpreted as number of characters. *Be sure to take this into account when specifying a prefix length for a column that uses a multi-byte character set.*

You can also create `FULLTEXT` indexes. These are used for full-text searches. Only the `MyISAM` storage engine supports `FULLTEXT` indexes and only for `CHAR`, `VARCHAR`, and `TEXT` columns. Indexing always takes place over the entire column and column prefix indexing is not supported. For details, see [Section 11.8](#), “`Full-Text Search Functions`”.

You can also create indexes on spatial data types. Currently, only `MyISAM` supports R-tree indexes on spatial types. Other storage engines use B-trees for indexing spatial types (except for `ARCHIVE` and `NDBCLUSTER`, which do not support spatial type indexing).

The `MEMORY` storage engine uses `HASH` indexes by default, but also supports `BTREE` indexes.

## 7.4.3. Multiple-Column Indexes

MySQL can create composite indexes (that is, indexes on multiple columns). An index may consist of up to 15 columns. For certain data types, you can index a prefix of the column (see [Section 7.4.2](#), “`Column Indexes`”).

A multiple-column index can be considered a sorted array containing values that are created by concatenating the values of the indexed columns.

MySQL uses multiple-column indexes in such a way that queries are fast when you specify a known quantity for the first column



of the index in a [WHERE](#) clause, even if you do not specify values for the other columns.

Suppose that a table has the following specification:

```
CREATE TABLE test (
  id          INT NOT NULL,
  last_name   CHAR(30) NOT NULL,
  first_name  CHAR(30) NOT NULL,
  PRIMARY KEY (id),
  INDEX name  (last_name,first_name)
);
```

The [name](#) index is an index over the [last\\_name](#) and [first\\_name](#) columns. The index can be used for queries that specify values in a known range for [last\\_name](#), or for both [last\\_name](#) and [first\\_name](#). Therefore, the [name](#) index is used in the following queries:

```
SELECT * FROM test WHERE last_name='Widenius';

SELECT * FROM test
  WHERE last_name='Widenius' AND first_name='Michael';

SELECT * FROM test
  WHERE last_name='Widenius'
    AND (first_name='Michael' OR first_name='Monty');

SELECT * FROM test
  WHERE last_name='Widenius'
    AND first_name >='M' AND first_name < 'N';
```

However, the [name](#) index is *not* used in the following queries:

```
SELECT * FROM test WHERE first_name='Michael';

SELECT * FROM test
  WHERE last_name='Widenius' OR first_name='Michael';
```

The manner in which MySQL uses indexes to improve query performance is discussed further in [Section 7.4.4, “How MySQL Uses Indexes”](#).

## 7.4.4. How MySQL Uses Indexes

Indexes are used to find rows with specific column values quickly. Without an index, MySQL must begin with the first row and then read through the entire table to find the relevant rows. The larger the table, the more this costs. If the table has an index for the columns in question, MySQL can quickly determine the position to seek to in the middle of the data file without having to look at all the data. If a table has 1,000 rows, this is at least 100 times faster than reading sequentially. If you need to access most of the rows, it is faster to read sequentially, because this minimizes disk seeks.

Most MySQL indexes ([PRIMARY KEY](#), [UNIQUE](#), [INDEX](#), and [FULLTEXT](#)) are stored in B-trees. Exceptions are that indexes on spatial data types use R-trees, and that [MEMORY](#) tables also support hash indexes.

Strings are automatically prefix- and end-space compressed. See [Section 12.1.13, “CREATE INDEX Syntax”](#).

In general, indexes are used as described in the following discussion. Characteristics specific to hash indexes (as used in [MEMORY](#) tables) are described at the end of this section.

MySQL uses indexes for these operations:

- To find the rows matching a [WHERE](#) clause quickly.
- To eliminate rows from consideration. If there is a choice between multiple indexes, MySQL normally uses the index that finds the smallest number of rows.
- To retrieve rows from other tables when performing joins. MySQL can use indexes on columns more efficiently if they are declared as the same type and size. In this context, [VARCHAR](#) and [CHAR](#) are considered the same if they are declared as the same size. For example, [VARCHAR\(10\)](#) and [CHAR\(10\)](#) are the same size, but [VARCHAR\(10\)](#) and [CHAR\(15\)](#) are not.

Comparison of dissimilar columns may prevent use of indexes if values cannot be compared directly without conversion. Suppose that a numeric column is compared to a string column. For a given value such as 1 in the numeric column, it might compare equal to any number of values in the string column such as '1', ' 1', '00001', or '01.e1'. This rules out use of any indexes for the string column.

- To find the [MIN\(\)](#) or [MAX\(\)](#) value for a specific indexed column [key\\_col](#). This is optimized by a preprocessor that checks whether you are using [WHERE key\\_part\\_N = constant](#) on all key parts that occur before [key\\_col](#) in the index. In this

case, MySQL does a single key lookup for each `MIN()` or `MAX()` expression and replaces it with a constant. If all expressions are replaced with constants, the query returns at once. For example:

```
SELECT MIN(key_part2),MAX(key_part2)
FROM tbl_name WHERE key_part1=10;
```

- To sort or group a table if the sorting or grouping is done on a leftmost prefix of a usable key (for example, `ORDER BY key_part1, key_part2`). If all key parts are followed by `DESC`, the key is read in reverse order. See [Section 7.2.13, “ORDER BY Optimization”](#), and [Section 7.2.14, “GROUP BY Optimization”](#).
- In some cases, a query can be optimized to retrieve values without consulting the data rows. If a query uses only columns from a table that are numeric and that form a leftmost prefix for some key, the selected values may be retrieved from the index tree for greater speed:

```
SELECT key_part3 FROM tbl_name
WHERE key_part1=1
```

Suppose that you issue the following `SELECT` statement:

```
mysql> SELECT * FROM tbl_name WHERE col1=val1 AND col2=val2;
```

If a multiple-column index exists on `col1` and `col2`, the appropriate rows can be fetched directly. If separate single-column indexes exist on `col1` and `col2`, the optimizer will attempt to use the Index Merge optimization (see [Section 7.2.6, “Index Merge Optimization”](#)), or attempt to find the most restrictive index by deciding which index finds fewer rows and using that index to fetch the rows.

If the table has a multiple-column index, any leftmost prefix of the index can be used by the optimizer to find rows. For example, if you have a three-column index on `(col1, col2, col3)`, you have indexed search capabilities on `(col1)`, `(col1, col2)`, and `(col1, col2, col3)`.

MySQL cannot use an index if the columns do not form a leftmost prefix of the index. Suppose that you have the `SELECT` statements shown here:

```
SELECT * FROM tbl_name WHERE col1=val1;
SELECT * FROM tbl_name WHERE col1=val1 AND col2=val2;

SELECT * FROM tbl_name WHERE col2=val2;
SELECT * FROM tbl_name WHERE col2=val2 AND col3=val3;
```

If an index exists on `(col1, col2, col3)`, only the first two queries use the index. The third and fourth queries do involve indexed columns, but `(col2)` and `(col2, col3)` are not leftmost prefixes of `(col1, col2, col3)`.

A B-tree index can be used for column comparisons in expressions that use the `=`, `>`, `>=`, `<`, `<=`, or `BETWEEN` operators. The index also can be used for `LIKE` comparisons if the argument to `LIKE` is a constant string that does not start with a wildcard character. For example, the following `SELECT` statements use indexes:

```
SELECT * FROM tbl_name WHERE key_col LIKE 'Patrick%';
SELECT * FROM tbl_name WHERE key_col LIKE 'Pat%ck%';
```

In the first statement, only rows with `'Patrick' <= key_col < 'Patricl'` are considered. In the second statement, only rows with `'Pat' <= key_col < 'Pau'` are considered.

The following `SELECT` statements do not use indexes:

```
SELECT * FROM tbl_name WHERE key_col LIKE '%Patrick%';
SELECT * FROM tbl_name WHERE key_col LIKE other_col;
```

In the first statement, the `LIKE` value begins with a wildcard character. In the second statement, the `LIKE` value is not a constant.

If you use `... LIKE '%string%'` and `string` is longer than three characters, MySQL uses the *Turbo Boyer-Moore algorithm* to initialize the pattern for the string and then uses this pattern to perform the search more quickly.

A search using `col_name IS NULL` employs indexes if `col_name` is indexed.

Any index that does not span all `AND` levels in the `WHERE` clause is not used to optimize the query. In other words, to be able to use an index, a prefix of the index must be used in every `AND` group.

The following `WHERE` clauses use indexes:

```
... WHERE index_part1=1 AND index_part2=2 AND other_column=3
```

```

/* index = 1 OR index = 2 */
... WHERE index=1 OR A=10 AND index=2
/* optimized like "index_part1='hello'" */
... WHERE index_part1='hello' AND index_part3=5
/* Can use index on index1 but not on index2 or index3 */
... WHERE index1=1 AND index2=2 OR index1=3 AND index3=3;

```

These `WHERE` clauses do *not* use indexes:

```

/* index_part1 is not used */
... WHERE index_part2=1 AND index_part3=2

/* Index is not used in both parts of the WHERE clause */
... WHERE index=1 OR A=10

/* No index spans all rows */
... WHERE index_part1=1 OR index_part2=10

```

Sometimes MySQL does not use an index, even if one is available. One circumstance under which this occurs is when the optimizer estimates that using the index would require MySQL to access a very large percentage of the rows in the table. (In this case, a table scan is likely to be much faster because it requires fewer seeks.) However, if such a query uses `LIMIT` to retrieve only some of the rows, MySQL uses an index anyway, because it can much more quickly find the few rows to return in the result.

Hash indexes have somewhat different characteristics from those just discussed:

- They are used only for equality comparisons that use the `=` or `<=>` operators (but are *very* fast). They are not used for comparison operators such as `<` that find a range of values.
- The optimizer cannot use a hash index to speed up `ORDER BY` operations. (This type of index cannot be used to search for the next entry in order.)
- MySQL cannot determine approximately how many rows there are between two values (this is used by the range optimizer to decide which index to use). This may affect some queries if you change a `MyISAM` table to a hash-indexed `MEMORY` table.
- Only whole keys can be used to search for a row. (With a B-tree index, any leftmost prefix of the key can be used to find rows.)

#### MySQL Enterprise

Often, it is not possible to predict exactly what indexes will be required or will be most efficient — actual table usage is the best indicator. The MySQL Enterprise Monitor provides expert advice on this topic. For more information, see <http://www.mysql.com/products/enterprise/advisors.html>.

## 7.4.5. The `MyISAM` Key Cache

To minimize disk I/O, the `MyISAM` storage engine exploits a strategy that is used by many database management systems. It employs a cache mechanism to keep the most frequently accessed table blocks in memory:

- For index blocks, a special structure called the *key cache* (or *key buffer*) is maintained. The structure contains a number of block buffers where the most-used index blocks are placed.
- For data blocks, MySQL uses no special cache. Instead it relies on the native operating system file system cache.

This section first describes the basic operation of the `MyISAM` key cache. Then it discusses features that improve key cache performance and that enable you to better control cache operation:

- Multiple sessions can access the cache concurrently.
- You can set up multiple key caches and assign table indexes to specific caches.

To control the size of the key cache, use the `key_buffer_size` system variable. If this variable is set equal to zero, no key cache is used. The key cache also is not used if the `key_buffer_size` value is too small to allocate the minimal number of block buffers (8).

#### MySQL Enterprise

For expert advice on identifying the optimum size for `key_buffer_size`, subscribe to the MySQL Enterprise Monitor. See <http://www.mysql.com/products/enterprise/advisors.html>.

When the key cache is not operational, index files are accessed using only the native file system buffering provided by the operating system. (In other words, table index blocks are accessed using the same strategy as that employed for table data blocks.)

An index block is a contiguous unit of access to the [MyISAM](#) index files. Usually the size of an index block is equal to the size of nodes of the index B-tree. (Indexes are represented on disk using a B-tree data structure. Nodes at the bottom of the tree are leaf nodes. Nodes above the leaf nodes are non-leaf nodes.)

All block buffers in a key cache structure are the same size. This size can be equal to, greater than, or less than the size of a table index block. Usually one these two values is a multiple of the other.

When data from any table index block must be accessed, the server first checks whether it is available in some block buffer of the key cache. If it is, the server accesses data in the key cache rather than on disk. That is, it reads from the cache or writes into it rather than reading from or writing to disk. Otherwise, the server chooses a cache block buffer containing a different table index block (or blocks) and replaces the data there by a copy of required table index block. As soon as the new index block is in the cache, the index data can be accessed.

If it happens that a block selected for replacement has been modified, the block is considered “dirty.” In this case, prior to being replaced, its contents are flushed to the table index from which it came.

Usually the server follows an *LRU (Least Recently Used)* strategy: When choosing a block for replacement, it selects the least recently used index block. To make this choice easier, the key cache module maintains a special queue (*LRU chain*) of all used blocks. When a block is accessed, it is placed at the end of the queue. When blocks need to be replaced, blocks at the beginning of the queue are the least recently used and become the first candidates for eviction.

### 7.4.5.1. Shared Key Cache Access

Threads can access key cache buffers simultaneously, subject to the following conditions:

- A buffer that is not being updated can be accessed by multiple sessions.
- A buffer that is being updated causes sessions that need to use it to wait until the update is complete.
- Multiple sessions can initiate requests that result in cache block replacements, as long as they do not interfere with each other (that is, as long as they need different index blocks, and thus cause different cache blocks to be replaced).

Shared access to the key cache enables the server to improve throughput significantly.

### 7.4.5.2. Multiple Key Caches

Shared access to the key cache improves performance but does not eliminate contention among sessions entirely. They still compete for control structures that manage access to the key cache buffers. To reduce key cache access contention further, MySQL also provides multiple key caches. This feature enables you to assign different table indexes to different key caches.

Where there are multiple key caches, the server must know which cache to use when processing queries for a given [MyISAM](#) table. By default, all [MyISAM](#) table indexes are cached in the default key cache. To assign table indexes to a specific key cache, use the `CACHE INDEX` statement (see [Section 12.5.6.2, “CACHE INDEX Syntax”](#)). For example, the following statement assigns indexes from the tables `t1`, `t2`, and `t3` to the key cache named `hot_cache`:

```
mysql> CACHE INDEX t1, t2, t3 IN hot_cache;
+-----+-----+-----+-----+
| Table | Op           | Msg_type | Msg_text |
+-----+-----+-----+-----+
| test.t1 | assign_to_keycache | status   | OK       |
| test.t2 | assign_to_keycache | status   | OK       |
| test.t3 | assign_to_keycache | status   | OK       |
+-----+-----+-----+-----+
```

The key cache referred to in a `CACHE INDEX` statement can be created by setting its size with a `SET GLOBAL` parameter setting statement or by using server startup options. For example:

```
mysql> SET GLOBAL keycache1.key_buffer_size=128*1024;
```

To destroy a key cache, set its size to zero:

```
mysql> SET GLOBAL keycache1.key_buffer_size=0;
```

Note that you cannot destroy the default key cache. Any attempt to do this will be ignored:

```
mysql> SET GLOBAL key_buffer_size = 0;
mysql> SHOW VARIABLES LIKE 'key_buffer_size';
+-----+-----+
| Variable_name | Value |
+-----+-----+
```

```
| key_buffer_size | 8384512 |
+-----+-----+
```

Key cache variables are structured system variables that have a name and components. For `keycachel.key_buffer_size`, `keycachel` is the cache variable name and `key_buffer_size` is the cache component. See Section 5.1.5.1, “Structured System Variables”, for a description of the syntax used for referring to structured key cache system variables.

By default, table indexes are assigned to the main (default) key cache created at the server startup. When a key cache is destroyed, all indexes assigned to it are reassigned to the default key cache.

For a busy server, we recommend a strategy that uses three key caches:

- A “hot” key cache that takes up 20% of the space allocated for all key caches. Use this for tables that are heavily used for searches but that are not updated.
- A “cold” key cache that takes up 20% of the space allocated for all key caches. Use this cache for medium-sized, intensively modified tables, such as temporary tables.
- A “warm” key cache that takes up 60% of the key cache space. Employ this as the default key cache, to be used by default for all other tables.

One reason the use of three key caches is beneficial is that access to one key cache structure does not block access to the others. Statements that access tables assigned to one cache do not compete with statements that access tables assigned to another cache. Performance gains occur for other reasons as well:

- The hot cache is used only for retrieval queries, so its contents are never modified. Consequently, whenever an index block needs to be pulled in from disk, the contents of the cache block chosen for replacement need not be flushed first.
- For an index assigned to the hot cache, if there are no queries requiring an index scan, there is a high probability that the index blocks corresponding to non-leaf nodes of the index B-tree remain in the cache.
- An update operation most frequently executed for temporary tables is performed much faster when the updated node is in the cache and need not be read in from disk first. If the size of the indexes of the temporary tables are comparable with the size of cold key cache, the probability is very high that the updated node is in the cache.

`CACHE INDEX` sets up an association between a table and a key cache, but the association is lost each time the server restarts. If you want the association to take effect each time the server starts, one way to accomplish this is to use an option file: Include variable settings that configure your key caches, and an `init-file` option that names a file containing `CACHE INDEX` statements to be executed. For example:

```
key_buffer_size = 4G
hot_cache.key_buffer_size = 2G
cold_cache.key_buffer_size = 2G
init_file=/path/to/data-directory/mysql_d_init.sql
```

### MySQL Enterprise

For advice on how best to configure your `my.cnf/my.ini` option file subscribe to MySQL Enterprise Monitor. Recommendations are based on actual table usage. For more information, see <http://www.mysql.com/products/enterprise/advisors.html>.

The statements in `mysql_d_init.sql` are executed each time the server starts. The file should contain one SQL statement per line. The following example assigns several tables each to `hot_cache` and `cold_cache`:

```
CACHE INDEX db1.t1, db1.t2, db2.t3 IN hot_cache
CACHE INDEX db1.t4, db2.t5, db2.t6 IN cold_cache
```

### 7.4.5.3. Midpoint Insertion Strategy

By default, the key cache management system uses the LRU strategy for choosing key cache blocks to be evicted, but it also supports a more sophisticated method called the *midpoint insertion strategy*.

When using the midpoint insertion strategy, the LRU chain is divided into two parts: a hot sub-chain and a warm sub-chain. The division point between two parts is not fixed, but the key cache management system takes care that the warm part is not “too short,” always containing at least `key_cache_division_limit` percent of the key cache blocks. `key_cache_division_limit` is a component of structured key cache variables, so its value is a parameter that can be set per cache.

When an index block is read from a table into the key cache, it is placed at the end of the warm sub-chain. After a certain number

of hits (accesses of the block), it is promoted to the hot sub-chain. At present, the number of hits required to promote a block (3) is the same for all index blocks.

A block promoted into the hot sub-chain is placed at the end of the chain. The block then circulates within this sub-chain. If the block stays at the beginning of the sub-chain for a long enough time, it is demoted to the warm chain. This time is determined by the value of the `key_cache_age_threshold` component of the key cache.

The threshold value prescribes that, for a key cache containing  $N$  blocks, the block at the beginning of the hot sub-chain not accessed within the last  $N \times \text{key\_cache\_age\_threshold} / 100$  hits is to be moved to the beginning of the warm sub-chain. It then becomes the first candidate for eviction, because blocks for replacement always are taken from the beginning of the warm sub-chain.

The midpoint insertion strategy allows you to keep more-valued blocks always in the cache. If you prefer to use the plain LRU strategy, leave the `key_cache_division_limit` value set to its default of 100.

The midpoint insertion strategy helps to improve performance when execution of a query that requires an index scan effectively pushes out of the cache all the index blocks corresponding to valuable high-level B-tree nodes. To avoid this, you must use a midpoint insertion strategy with the `key_cache_division_limit` set to much less than 100. Then valuable frequently hit nodes are preserved in the hot sub-chain during an index scan operation as well.

### 7.4.5.4. Index Preloading

If there are enough blocks in a key cache to hold blocks of an entire index, or at least the blocks corresponding to its non-leaf nodes, it makes sense to preload the key cache with index blocks before starting to use it. Preloading allows you to put the table index blocks into a key cache buffer in the most efficient way: by reading the index blocks from disk sequentially.

Without preloading, the blocks are still placed into the key cache as needed by queries. Although the blocks will stay in the cache, because there are enough buffers for all of them, they are fetched from disk in random order, and not sequentially.

To preload an index into a cache, use the `LOAD INDEX INTO CACHE` statement. For example, the following statement preloads nodes (index blocks) of indexes of the tables `t1` and `t2`:

```
mysql> LOAD INDEX INTO CACHE t1, t2 IGNORE LEAVES;
```

Table	Op	Msg_type	Msg_text
test.t1	preload_keys	status	OK
test.t2	preload_keys	status	OK

The `IGNORE LEAVES` modifier causes only blocks for the non-leaf nodes of the index to be preloaded. Thus, the statement shown preloads all index blocks from `t1`, but only blocks for the non-leaf nodes from `t2`.

If an index has been assigned to a key cache using a `CACHE INDEX` statement, preloading places index blocks into that cache. Otherwise, the index is loaded into the default key cache.

### 7.4.5.5. Key Cache Block Size

It is possible to specify the size of the block buffers for an individual key cache using the `key_cache_block_size` variable. This permits tuning of the performance of I/O operations for index files.

The best performance for I/O operations is achieved when the size of read buffers is equal to the size of the native operating system I/O buffers. But setting the size of key nodes equal to the size of the I/O buffer does not always ensure the best overall performance. When reading the big leaf nodes, the server pulls in a lot of unnecessary data, effectively preventing reading other leaf nodes.

To control the size of blocks in the `.MYI` index file of `MyISAM` tables, use the `--myisam-block-size` option at server startup.

### 7.4.5.6. Restructuring a Key Cache

A key cache can be restructured at any time by updating its parameter values. For example:

```
mysql> SET GLOBAL cold_cache.key_buffer_size=4*1024*1024;
```

If you assign to either the `key_buffer_size` or `key_cache_block_size` key cache component a value that differs from the component's current value, the server destroys the cache's old structure and creates a new one based on the new values. If the cache contains any dirty blocks, the server saves them to disk before destroying and re-creating the cache. Restructuring does not occur if you change other key cache parameters.

When restructuring a key cache, the server first flushes the contents of any dirty buffers to disk. After that, the cache contents become unavailable. However, restructuring does not block queries that need to use indexes assigned to the cache. Instead, the server

directly accesses the table indexes using native file system caching. File system caching is not as efficient as using a key cache, so although queries execute, a slowdown can be anticipated. After the cache has been restructured, it becomes available again for caching indexes assigned to it, and the use of file system caching for the indexes ceases.

## 7.4.6. MyISAM Index Statistics Collection

Storage engines collect statistics about tables for use by the optimizer. Table statistics are based on value groups, where a value group is a set of rows with the same key prefix value. For optimizer purposes, an important statistic is the average value group size.

MySQL uses the average value group size in the following ways:

- To estimate how many rows must be read for each `ref` access
- To estimate how many row a partial join will produce; that is, the number of rows that an operation of this form will produce:

```
(...) JOIN tbl_name ON tbl_name.key = expr
```

As the average value group size for an index increases, the index is less useful for those two purposes because the average number of rows per lookup increases: For the index to be good for optimization purposes, it is best that each index value target a small number of rows in the table. When a given index value yields a large number of rows, the index is less useful and MySQL is less likely to use it.

The average value group size is related to table cardinality, which is the number of value groups. The `SHOW INDEX` statement displays a cardinality value based on  $N/S$ , where  $N$  is the number of rows in the table and  $S$  is the average value group size. That ratio yields an approximate number of value groups in the table.

For a join based on the `<=>` comparison operator, `NULL` is not treated differently from any other value: `NULL <=> NULL`, just as `N <=> N` for any other  $N$ .

However, for a join based on the `=` operator, `NULL` is different from non-`NULL` values: `expr1 = expr2` is not true when `expr1` or `expr2` (or both) are `NULL`. This affects `ref` accesses for comparisons of the form `tbl_name.key = expr`: MySQL will not access the table if the current value of `expr` is `NULL`, because the comparison cannot be true.

For `=` comparisons, it does not matter how many `NULL` values are in the table. For optimization purposes, the relevant value is the average size of the non-`NULL` value groups. However, MySQL does not currently allow that average size to be collected or used.

For `MyISAM` tables, you have some control over collection of table statistics by means of the `myisam_stats_method` system variable. This variable has three possible values, which differ as follows:

- When `myisam_stats_method` is `nulls_equal`, all `NULL` values are treated as identical (that is, they all form a single value group).  
If the `NULL` value group size is much higher than the average non-`NULL` value group size, this method skews the average value group size upward. This makes index appear to the optimizer to be less useful than it really is for joins that look for non-`NULL` values. Consequently, the `nulls_equal` method may cause the optimizer not to use the index for `ref` accesses when it should.
- When `myisam_stats_method` is `nulls_unequal`, `NULL` values are not considered the same. Instead, each `NULL` value forms a separate value group of size 1.  
If you have many `NULL` values, this method skews the average value group size downward. If the average non-`NULL` value group size is large, counting `NULL` values each as a group of size 1 causes the optimizer to overestimate the value of the index for joins that look for non-`NULL` values. Consequently, the `nulls_unequal` method may cause the optimizer to use this index for `ref` lookups when other methods may be better.
- When `myisam_stats_method` is `nulls_ignored`, `NULL` values are ignored.

If you tend to use many joins that use `<=>` rather than `=`, `NULL` values are not special in comparisons and one `NULL` is equal to another. In this case, `nulls_equal` is the appropriate statistics method.

The `myisam_stats_method` system variable has global and session values. Setting the global value affects `MyISAM` statistics collection for all `MyISAM` tables. Setting the session value affects statistics collection only for the current client connection. This means that you can force a table's statistics to be regenerated with a given method without affecting other clients by setting the session value of `myisam_stats_method`.

To regenerate table statistics, you can use any of the following methods:



- Execute `myisamchk --stats_method=method_name --analyze`
- Change the table to cause its statistics to go out of date (for example, insert a row and then delete it), and then set `myisam_stats_method` and issue an `ANALYZE TABLE` statement

Some caveats regarding the use of `myisam_stats_method`:

- You can force table statistics to be collected explicitly, as just described. However, MySQL may also collect statistics automatically. For example, if during the course of executing statements for a table, some of those statements modify the table, MySQL may collect statistics. (This may occur for bulk inserts or deletes, or some `ALTER TABLE` statements, for example.) If this happens, the statistics are collected using whatever value `myisam_stats_method` has at the time. Thus, if you collect statistics using one method, but `myisam_stats_method` is set to the other method when a table's statistics are collected automatically later, the other method will be used.
- There is no way to tell which method was used to generate statistics for a given `MyISAM` table.
- `myisam_stats_method` applies only to `MyISAM` tables. Other storage engines have only one method for collecting table statistics. Usually it is closer to the `nulls_equal` method.

## 7.4.7. How MySQL Opens and Closes Tables

When you execute a `mysqladmin status` command, you should see something like this:

```
Uptime: 426 Running threads: 1 Questions: 11082
Reloads: 1 Open tables: 12
```

The `Open tables` value of 12 can be somewhat puzzling if you have only six tables.

MySQL is multi-threaded, so there may be many clients issuing queries for a given table simultaneously. To minimize the problem with multiple client sessions having different states on the same table, the table is opened independently by each concurrent session. This uses additional memory but normally increases performance. With `MyISAM` tables, one extra file descriptor is required for the data file for each client that has the table open. (By contrast, the index file descriptor is shared between all sessions.)

### Note

`table_open_cache` was previously known as `table_cache` in MySQL 5.1.2 and earlier.

The `table_open_cache`, `max_connections`, and `max_tmp_tables` system variables affect the maximum number of files the server keeps open. If you increase one or more of these values, you may run up against a limit imposed by your operating system on the per-process number of open file descriptors. Many operating systems allow you to increase the open-files limit, although the method varies widely from system to system. Consult your operating system documentation to determine whether it is possible to increase the limit and how to do so.

`table_open_cache` is related to `max_connections`. For example, for 200 concurrent running connections, you should have a table cache size of at least  $200 \times N$ , where  $N$  is the maximum number of tables per join in any of the queries which you execute. You must also reserve some extra file descriptors for temporary tables and files.

Make sure that your operating system can handle the number of open file descriptors implied by the `table_open_cache` setting. If `table_open_cache` is set too high, MySQL may run out of file descriptors and refuse connections, fail to perform queries, and be very unreliable. You also have to take into account that the `MyISAM` storage engine needs two file descriptors for each unique open table. You can increase the number of file descriptors available to MySQL using the `--open-files-limit` startup option to `mysqld`. See [Section B.1.2.18](#), “`'FILE' NOT FOUND and Similar Errors`”.

The cache of open tables is kept at a level of `table_open_cache` entries. The default value is 64; this can be changed with the `--table_open_cache` option to `mysqld`. Note that MySQL may temporarily open more tables than this to execute queries.

### MySQL Enterprise

Performance may suffer if `table_open_cache` is set too low. For expert advice on the optimum value for this variable, subscribe to the MySQL Enterprise Monitor. For more information, see <http://www.mysql.com/products/enterprise/advisors.html>.

MySQL closes an unused table and removes it from the table cache under the following circumstances:

- When the cache is full and a thread tries to open a table that is not in the cache.
- When the cache contains more than `table_open_cache` entries and a table in the cache is no longer being used by any



threads.

- When a table flushing operation occurs. This happens when someone issues a `FLUSH TABLES` statement or executes a `mysqladmin flush-tables` or `mysqladmin refresh` command.

When the table cache fills up, the server uses the following procedure to locate a cache entry to use:

- Tables that are not currently in use are released, beginning with the table least recently used.
- If a new table needs to be opened, but the cache is full and no tables can be released, the cache is temporarily extended as necessary. When the cache is in a temporarily extended state and a table goes from a used to unused state, the table is closed and released from the cache.

A `MyISAM` table is opened for each concurrent access. This means the table needs to be opened twice if two threads access the same table or if a thread accesses the table twice in the same query (for example, by joining the table to itself). Each concurrent open requires an entry in the table cache. The first open of any `MyISAM` table takes two file descriptors: one for the data file and one for the index file. Each additional use of the table takes only one file descriptor for the data file. The index file descriptor is shared among all threads.

If you are opening a table with the `HANDLER tbl_name OPEN` statement, a dedicated table object is allocated for the thread. This table object is not shared by other threads and is not closed until the thread calls `HANDLER tbl_name CLOSE` or the thread terminates. When this happens, the table is put back in the table cache (if the cache is not full). See [Section 12.2.4, “HANDLER Syntax”](#).

You can determine whether your table cache is too small by checking the `mysqld` status variable `Opened_tables`, which indicates the number of table-opening operations since the server started:

```
mysql> SHOW GLOBAL STATUS LIKE 'Opened_tables';
+-----+-----+
| Variable_name | Value |
+-----+-----+
| Opened_tables | 2741  |
+-----+-----+
```

If the value is very large or increases rapidly, even when you have not issued many `FLUSH TABLES` statements, you should increase the table cache size. See [Section 5.1.3, “Server System Variables”](#), and [Section 5.1.6, “Server Status Variables”](#).

## 7.4.8. Disadvantages of Creating Many Tables in the Same Database

If you have many `MyISAM` tables in the same database directory, open, close, and create operations are slow. If you execute `SELECT` statements on many different tables, there is a little overhead when the table cache is full, because for every table that has to be opened, another must be closed. You can reduce this overhead by increasing the number of entries allowed in the table cache.

## 7.5. Optimizing the MySQL Server

### 7.5.1. How Compiling and Linking Affects the Speed of MySQL

Most of the following tests were performed on Linux with the MySQL benchmarks, but they should give some indication for other operating systems and workloads.

You obtain the fastest executables when you link with `-static`.

On Linux, it is best to compile the server with `pgcc` and `-O3`. You need about 200MB memory to compile `sql_yacc.cc` with these options, because `gcc` or `pgcc` needs a great deal of memory to make all functions inline. You should also set `CXX=gcc` when configuring MySQL to avoid inclusion of the `libstdc++` library, which is not needed. Note that with some versions of `pgcc`, the resulting binary runs only on true Pentium processors, even if you use the compiler option indicating that you want the resulting code to work on all x586-type processors (such as AMD).

By using a better compiler and compilation options, you can obtain a 10–30% speed increase in applications. This is particularly important if you compile the MySQL server yourself.

When we tested both the Cygnus CodeFusion and Fujitsu compilers, neither was sufficiently bug-free to allow MySQL to be compiled with optimizations enabled.

The standard MySQL binary distributions are compiled with support for all character sets. When you compile MySQL yourself, you should include support only for the character sets that you are going to use. This is controlled by the `--with-charset` option to `configure`.

Here is a list of some measurements that we have made:

- If you use `pgcc` and compile everything with `-O6`, the `mysqld` server is 1% faster than with `gcc 2.95.2`.
- If you link dynamically (without `-static`), the result is 13% slower on Linux. Note that you still can use a dynamically linked MySQL library for your client applications. It is the server that is most critical for performance.
- For a connection from a client to a server running on the same host, if you connect using TCP/IP rather than a Unix socket file, performance is 7.5% slower. (On Unix, if you connect to the host name `localhost`, MySQL uses a socket file by default.)
- For TCP/IP connections from a client to a server, connecting to a remote server on another host is 8–11% slower than connecting to a server on the same host, even for connections faster than 100Mb/s Ethernet.
- When running our benchmark tests using secure connections (all data encrypted with internal SSL support) performance was 55% slower than with unencrypted connections.
- If you compile with `--with-debug=full`, most queries are 20% slower. Some queries may take substantially longer; for example, the MySQL benchmarks run 35% slower. If you use `--with-debug` (without `=full`), the speed decrease is only 15%. For a version of `mysqld` that has been compiled with `--with-debug=full`, you can disable memory checking at runtime by starting it with the `--skip-safemalloc` option. The execution speed should then be close to that obtained when configuring with `--with-debug`.
- On a Sun UltraSPARC-IIe, a server compiled with Forte 5.0 is 4% faster than one compiled with `gcc 3.2`.
- On a Sun UltraSPARC-IIe, a server compiled with Forte 5.0 is 4% faster in 32-bit mode than in 64-bit mode.
- Compiling with `gcc 2.95.2` for UltraSPARC with the `-mcpu=v8 -Wa,-xarch=v8plusa` options gives 4% more performance.
- On Solaris 2.5.1, MIT-pthreads is 8–12% slower than Solaris native threads on a single processor. With greater loads or more CPUs, the difference should be larger.
- Compiling on Linux-x86 using `gcc` without frame pointers (`-fomit-frame-pointer` or `-fomit-frame-pointer -ffixed-ebp`) makes `mysqld` 1–4% faster.

Binary MySQL distributions for Linux that are provided by MySQL AB used to be compiled with `pgcc`. We had to go back to regular `gcc` due to a bug in `pgcc` that would generate binaries that do not run on AMD. We will continue using `gcc` until that bug is resolved. In the meantime, if you have a non-AMD machine, you can build a faster binary by compiling with `pgcc`. The standard MySQL Linux binary is linked statically to make it faster and more portable.

## 7.5.2. System Factors and Startup Parameter Tuning

We start with system-level factors, because some of these decisions must be made very early to achieve large performance gains. In other cases, a quick look at this section may suffice. However, it is always nice to have a sense of how much can be gained by changing factors that apply at this level.

The operating system to use is very important. To get the best use of multiple-CPU machines, you should use Solaris (because its threads implementation works well) or Linux (because the 2.4 and later kernels have good SMP support). Note that older Linux kernels have a 2GB filesize limit by default. If you have such a kernel and a need for files larger than 2GB, you should get the Large File Support (LFS) patch for the ext2 file system. Other file systems such as ReiserFS and XFS do not have this 2GB limitation.

Before using MySQL in production, we advise you to test it on your intended platform.

Other tips:

- If you have enough RAM, you could remove all swap devices. Some operating systems use a swap device in some contexts even if you have free memory.
- Avoid external locking. Since MySQL 4.0, the default has been for external locking to be disabled on all systems. The `-external-locking` and `--skip-external-locking` options explicitly enable and disable external locking.

Note that disabling external locking does not affect MySQL's functionality as long as you run only one server. Just remember to take down the server (or lock and flush the relevant tables) before you run `myisamchk`. On some systems it is mandatory to disable external locking because it does not work, anyway.

The only case in which you cannot disable external locking is when you run multiple MySQL *servers* (not clients) on the same data, or if you run `myisamchk` to check (not repair) a table without telling the server to flush and lock the tables first. Note

that using multiple MySQL servers to access the same data concurrently is generally *not* recommended, except when using MySQL Cluster.

The `LOCK TABLES` and `UNLOCK TABLES` statements use internal locking, so you can use them even if external locking is disabled.

### 7.5.3. Tuning Server Parameters

You can determine the default buffer sizes used by the `mysqld` server using this command:

```
shell> mysqld --verbose --help
```

This command produces a list of all `mysqld` options and configurable system variables. The output includes the default variable values and looks something like this:

```

abort-slave-event-count          0
allow-suspicious-udfs           FALSE
auto-increment-increment       1
auto-increment-offset          1
automatic-sp-privileges        TRUE
back_log                        50
basedir                         /home/jon/bin/mysql-5.1/
bind-address                    (No default value)
binlog-row-event-max-size       1024
binlog_cache_size               32768
binlog_format                   (No default value)
bulk_insert_buffer_size         8388608
character-set-client-handshake  TRUE
character-set-filesystem        binary
character-set-server            latin1
character-sets-dir              /home/jon/bin/mysql-5.1/share/mysqlCharsets/
chroot                          (No default value)
collation-server                latin1_swedish_ci
completion-type                 0
concurrent-insert               1
connect_timeout                 10
console                         FALSE
datadir                         .
datetime_format                 %Y-%m-%d %H:%i:%s
date_format                     %Y-%m-%d
default-character-set            latin1
default-collation                latin1_swedish_ci
default-storage-engine           MyISAM
default-table-type               MyISAM
default-time-zone                (No default value)
default_week_format              0
delayed_insert_limit            100
delayed_insert_timeout           300
delayed_queue_size              1000
disconnect-slave-event-count     0
div_precision_increment          4
enable-locking                   FALSE
engine-condition-pushdown        TRUE
expire_logs_days                 0
external-locking                 FALSE
flush_time                       0
ft_max_word_len                  84
ft_min_word_len                  4
ft_query_expansion_limit         20
ft_stopword_file                 (No default value)
gdb                              FALSE
general_log                      FALSE
general_log_file                 (No default value)
group_concat_max_len             1024
help                             TRUE
init-connect                     (No default value)
init-file                       (No default value)
init-slave                      (No default value)
innodb                           TRUE
innodb-adaptive-hash-index       TRUE
innodb-additional-mem-pool-size  1048576
innodb-autoextend-increment      8
innodb-autoinc-lock-mode         1
innodb-buffer-pool-size          8388608
innodb-checksums                 TRUE
innodb-commit-concurrency        0
innodb-concurrency-tickets       500
innodb-data-file-path            (No default value)
innodb-data-home-dir            (No default value)
innodb-doublewrite               TRUE
innodb-fast-shutdown             1
innodb-file-io-threads           4
innodb-file-per-table            FALSE
innodb-flush-log-at-trx-commit  1
innodb-flush-method              (No default value)
innodb-force-recovery            0
innodb-lock-wait-timeout         50
innodb-locks-unsafe-for-binlog  FALSE
innodb-log-buffer-size           1048576

```

```

innodb-log-file-size          5242880
innodb-log-files-in-group     2
innodb-log-group-home-dir    (No default value)
innodb-max-dirty-pages-pct   90
innodb-max-purge-lag         0
innodb-mirrored-log-groups   1
innodb-open-files            300
innodb-rollback-on-timeout   FALSE
innodb-stats-on-metadata     TRUE
innodb-status-file           FALSE
innodb-support-xa            TRUE
innodb-sync-spin-loops       20
innodb-table-locks           TRUE
innodb-thread-concurrency     8
innodb-thread-sleep-delay    10000
interactive_timeout           28800
join_buffer_size             131072
keep_files_on_create         FALSE
key_buffer_size              8384512
key_cache_age_threshold      300
key_cache_block_size         1024
key_cache_division_limit     100
language                     /home/jon/bin/mysql-5.1/share/mysql/english/
large-pages                   FALSE
lc-time-names                 en_US
local-infile                  TRUE
log                           (No default value)
log-bin                       (No default value)
log-bin-index                 (No default value)
log-bin-trust-function-creators  FALSE
log-bin-trust-routine-creators  FALSE
log-error                     myisam.log
log-output                    FILE
log-queries-not-using-indexes  FALSE
log-short-format              FALSE
log-slave-updates             FALSE
log-slow-admin-statements     FALSE
log-slow-slave-statements     FALSE
log-tc                        tc.log
log-tc-size                   24576
log-update                    (No default value)
log-warnings                  1
log_slow_queries              (No default value)
long_query_time               10
low-priority-updates          FALSE
lower_case_table_names        0
master-connect-retry          60
master-host                   (No default value)
master-info-file              master.info
master-password               (No default value)
master-port                   3306
master-retry-count            86400
master-ssl                    FALSE
master-ssl-ca                 (No default value)
master-ssl-capath             (No default value)
master-ssl-cert               (No default value)
master-ssl-cipher             (No default value)
master-ssl-key                (No default value)
master-user                   test
max-binlog-dump-events        0
max_allowed_packet            1048576
max_binlog_cache_size         18446744073709547520
max_binlog_size               1073741824
max_connections               151
max_connect_errors            10
max_delayed_threads           20
max_error_count               64
max_heap_table_size           16777216
max_join_size                 18446744073709551615
max_length_for_sort_data      1024
max_prepared_stmt_count       16382
max_relay_log_size            0
max_seeks_for_key             18446744073709551615
max_sort_length               1024
max_sp_recursion_depth        0
max_tmp_tables                32
max_user_connections          0
max_write_lock_count          18446744073709551615
memlock                       FALSE
min_examined_row_limit       0
multi_range_count             256
myisam-recover                OFF
myisam_block_size             1024
myisam_data_pointer_size      6
myisam_max_extra_sort_file_size 2147483648
myisam_max_sort_file_size     9223372036853727232
myisam_repair_threads         1
myisam_sort_buffer_size       8388608
myisam_stats_method           nulls_unequal
myisam_use_mmap               FALSE
ndb-autoincrement-prefetch-sz 1
ndb-cache-check-time          0
ndb-connectstring             (No default value)
ndb-extra-logging             0
ndb-force-send                TRUE
ndb-index-stat-enable         FALSE

```

```

ndb-mgmd-host          (No default value)
ndb-nodeid             0
ndb-optimized-node-selection TRUE
ndb-report-thresh-binlog-epoch-slip 3
ndb-report-thresh-binlog-mem-usage 10
ndb-shm                FALSE
ndb-use-copying-alter-table FALSE
ndb-use-exact-count    TRUE
ndb-use-transactions   TRUE
ndb_force_send         TRUE
ndb_use_exact_count    TRUE
ndb_use_transactions   TRUE
net_buffer_length      16384
net_read_timeout       30
net_retry_count        10
net_write_timeout      60
new                    FALSE
old                    FALSE
old-alter-table        FALSE
old-passwords          FALSE
old-style-user-limits FALSE
open_files_limit       1024
optimizer_prune_level 1
optimizer_search_depth 62
pid-file               /home/jon/bin/mysql-5.1/var/tonfisk.pid
plugin-load            (No default value)
plugin_dir             /home/jon/bin/mysql-5.1/lib/mysql/plugin
port                   3306
port-open-timeout      0
preload_buffer_size    32768
profiling_history_size 15
query_alloc_block_size 8192
query_cache_limit      1048576
query_cache_min_res_unit 4096
query_cache_size       0
query_cache_type       1
query_cache_wlock_invalidate FALSE
query_prealloc_size    8192
range_alloc_block_size 4096
read_buffer_size       131072
read_only              FALSE
read_rnd_buffer_size   262144
record_buffer          131072
relay-log              (No default value)
relay-log-index        (No default value)
relay-log-info-file    relay-log.info
relay_log_purge        TRUE
relay_log_space_limit  0
replicate-same-server-id FALSE
report-host            (No default value)
report-password        (No default value)
report-port            3306
report-user            (No default value)
rpl-recovery-rank      0
safe-user-create       FALSE
secure-auth            FALSE
secure-file-priv       (No default value)
server-id              0
show-slave-auth-info   FALSE
skip-grant-tables      FALSE
skip-slave-start       FALSE
slave-exec-mode        STRICT
slave-load-tmpdir      /tmp
slave_compressed_protocol FALSE
slave_net_timeout      3600
slave_transaction_retries 10
slow-query-log         FALSE
slow_launch_time       2
slow_query_log_file    (No default value)
socket                 /tmp/mysql.sock
sort_buffer_size        2097144
sporadic-binlog-dump-fail FALSE
sql-mode               OFF
symbolic-links         TRUE
sync-binlog            0
sync_frm               TRUE
sysdate-is-now         FALSE
table_cache            64
table_definition_cache 256
table_lock_wait_timeout 50
table_open_cache       64
tc-heuristic-recover   (No default value)
temp-pool              TRUE
thread_cache_size      0
thread_concurrency     10
thread_stack           262144
timed_mutexes          FALSE
time_format            %H:%i:%s
tmpdir                 (No default value)
tmp_table_size         16777216
transaction_alloc_block_size 8192
transaction_prealloc_size 4096
updatable_views_with_limit 1
use-symbolic-links     TRUE
verbose                TRUE
wait_timeout           28800
warnings               1

```

For a `mysqld` server that is currently running, you can see the current values of its system variables by connecting to it and issuing this statement:

```
mysql> SHOW VARIABLES;
```

You can also see some statistical and status indicators for a running server by issuing this statement:

```
mysql> SHOW STATUS;
```

System variable and status information also can be obtained using `mysqladmin`:

```
shell> mysqladmin variables
shell> mysqladmin extended-status
```

For a full description of all system and status variables, see [Section 5.1.3, “Server System Variables”](#), and [Section 5.1.6, “Server Status Variables”](#).

MySQL uses algorithms that are very scalable, so you can usually run with very little memory. However, normally you get better performance by giving MySQL more memory.

When tuning a MySQL server, the two most important variables to configure are `key_buffer_size` and `table_open_cache`. You should first feel confident that you have these set appropriately before trying to change any other variables.

The following examples indicate some typical variable values for different runtime configurations.

- If you have at least 256MB of memory and many tables and want maximum performance with a moderate number of clients, you should use something like this:

```
shell> mysqld_safe --key_buffer_size=64M --table_open_cache=256 \
--sort_buffer_size=4M --read_buffer_size=1M &
```

- If you have only 128MB of memory and only a few tables, but you still do a lot of sorting, you can use something like this:

```
shell> mysqld_safe --key_buffer_size=16M --sort_buffer_size=1M
```

If there are very many simultaneous connections, swapping problems may occur unless `mysqld` has been configured to use very little memory for each connection. `mysqld` performs better if you have enough memory for all connections.

- With little memory and lots of connections, use something like this:

```
shell> mysqld_safe --key_buffer_size=512K --sort_buffer_size=100K \
--read_buffer_size=100K &
```

Or even this:

```
shell> mysqld_safe --key_buffer_size=512K --sort_buffer_size=16K \
--table_open_cache=32 --read_buffer_size=8K \
--net_buffer_length=1K &
```

If you are performing `GROUP BY` or `ORDER BY` operations on tables that are much larger than your available memory, you should increase the value of `read_rnd_buffer_size` to speed up the reading of rows following sorting operations.

You can make use of the example option files included with your MySQL distribution; see [Section 4.2.3.2.2, “Preconfigured Option Files”](#).

If you specify an option on the command line for `mysqld` or `mysqld_safe`, it remains in effect only for that invocation of the server. To use the option every time the server runs, put it in an option file.

To see the effects of a parameter change, do something like this:

```
shell> mysqld --key_buffer_size=32M --verbose --help
```

The variable values are listed near the end of the output. Make sure that the `--verbose` and `--help` options are last. Otherwise, the effect of any options listed after them on the command line are not reflected in the output.

For information on tuning the InnoDB storage engine, see [Section 13.6.13.1, “InnoDB Performance Tuning Tips”](#).

### MySQL Enterprise

For expert advice on tuning system parameters subscribe to the MySQL Enterprise Monitor. For more information, see <http://www.mysql.com/products/enterprise/advisors.html>.

## 7.5.4. Controlling Query Optimizer Performance

The task of the query optimizer is to find an optimal plan for executing an SQL query. Because the difference in performance between “good” and “bad” plans can be orders of magnitude (that is, seconds versus hours or even days), most query optimizers, including that of MySQL, perform a more or less exhaustive search for an optimal plan among all possible query evaluation plans. For join queries, the number of possible plans investigated by the MySQL optimizer grows exponentially with the number of tables referenced in a query. For small numbers of tables (typically less than 7–10) this is not a problem. However, when larger queries are submitted, the time spent in query optimization may easily become the major bottleneck in the server's performance.

A more flexible method for query optimization allows the user to control how exhaustive the optimizer is in its search for an optimal query evaluation plan. The general idea is that the fewer plans that are investigated by the optimizer, the less time it spends in compiling a query. On the other hand, because the optimizer skips some plans, it may miss finding an optimal plan.

The behavior of the optimizer with respect to the number of plans it evaluates can be controlled via two system variables:

- The `optimizer_prune_level` variable tells the optimizer to skip certain plans based on estimates of the number of rows accessed for each table. Our experience shows that this kind of “educated guess” rarely misses optimal plans, and may dramatically reduce query compilation times. That is why this option is on (`optimizer_prune_level=1`) by default. However, if you believe that the optimizer missed a better query plan, this option can be switched off (`optimizer_prune_level=0`) with the risk that query compilation may take much longer. Note that, even with the use of this heuristic, the optimizer still explores a roughly exponential number of plans.
- The `optimizer_search_depth` variable tells how far into the “future” of each incomplete plan the optimizer should look to evaluate whether it should be expanded further. Smaller values of `optimizer_search_depth` may result in orders of magnitude smaller query compilation times. For example, queries with 12, 13, or more tables may easily require hours and even days to compile if `optimizer_search_depth` is close to the number of tables in the query. At the same time, if compiled with `optimizer_search_depth` equal to 3 or 4, the optimizer may compile in less than a minute for the same query. If you are unsure of what a reasonable value is for `optimizer_search_depth`, this variable can be set to 0 to tell the optimizer to determine the value automatically.

## 7.5.5. The MySQL Query Cache

The query cache stores the text of a `SELECT` statement together with the corresponding result that was sent to the client. If an identical statement is received later, the server retrieves the results from the query cache rather than parsing and executing the statement again. The query cache is shared among sessions, so a result set generated by one client can be sent in response to the same query issued by another client.

The query cache is extremely useful in an environment where you have tables that do not change very often and for which the server receives many identical queries. This is a typical situation for many Web servers that generate many dynamic pages based on database content.

The query cache does not return stale data. When tables are modified, any relevant entries in the query cache are flushed.

### Note

The query cache does not work in an environment where you have multiple `mysqld` servers updating the same `MyISAM` tables.

### Note

As of MySQL 5.1.17, the query cache is used for prepared statements under the conditions described in [Section 7.5.5.1, “How the Query Cache Operates”](#). Before 5.1.17, the query cache is not used for prepared statements.

Some performance data for the query cache follows. These results were generated by running the MySQL benchmark suite on a Linux Alpha 2×500MHz system with 2GB RAM and a 64MB query cache.

- If all the queries you are performing are simple (such as selecting a row from a table with one row), but still differ so that the queries cannot be cached, the overhead for having the query cache active is 13%. This could be regarded as the worst case scenario. In real life, queries tend to be much more complicated, so the overhead normally is significantly lower.

- Searches for a single row in a single-row table are 238% faster with the query cache than without it. This can be regarded as close to the minimum speedup to be expected for a query that is cached.

To disable the query cache at server startup, set the `query_cache_size` system variable to 0. By disabling the query cache code, there is no noticeable overhead. If you build MySQL from source, query cache capabilities can be excluded from the server entirely by invoking `configure` with the `--without-query-cache` option.

The query cache offers the potential for substantial performance improvement, but you should not assume that it will do so under all circumstances. With some query cache configurations or server workloads, you might actually see a performance decrease:

- Be cautious about sizing the query cache excessively large, which increases the overhead required to maintain the cache, possibly beyond the benefit of enabling it. Sizes in tens of megabytes are usually beneficial. Sizes in the hundreds of megabytes might not be.
- Server workload has a significant effect on query cache efficiency. A query mix consisting almost entirely of a fixed set of `SELECT` statements is much more likely to benefit from enabling the cache than a mix in which frequent `INSERT` statements cause continual invalidation of results in the cache. In some cases, a workaround is to use the `SQL_NO_CACHE` option to prevent results from even entering the cache for `SELECT` statements that use frequently modified tables. (See [Section 7.5.5.2, “Query Cache SELECT Options”](#).)

To verify that enabling the query cache is beneficial, test the operation of your MySQL server with the cache enabled and disabled. Then retest periodically because query cache efficiency may change as server workload changes.

### 7.5.5.1. How the Query Cache Operates

This section describes how the query cache works when it is operational. [Section 7.5.5.3, “Query Cache Configuration”](#), describes how to control whether it is operational.

Incoming queries are compared to those in the query cache before parsing, so the following two queries are regarded as different by the query cache:

```
SELECT * FROM tbl_name
Select * from tbl_name
```

Queries must be *exactly* the same (byte for byte) to be seen as identical. In addition, query strings that are identical may be treated as different for other reasons. Queries that use different databases, different protocol versions, or different default character sets are considered different queries and are cached separately.

The cache is not used for queries of the following types:

- Queries that are a subquery of an outer query
- Queries executed within the body of a stored function, trigger, or event

Before a query result is fetched from the query cache, MySQL checks whether the user has `SELECT` privilege for all databases and tables involved. If this is not the case, the cached result is not used.

If a query result is returned from query cache, the server increments the `Qcache_hits` status variable, not `Com_select`. See [Section 7.5.5.4, “Query Cache Status and Maintenance”](#).

If a table changes, all cached queries that use the table become invalid and are removed from the cache. This includes queries that use `MERGE` tables that map to the changed table. A table can be changed by many types of statements, such as `INSERT`, `UPDATE`, `DELETE`, `TRUNCATE`, `ALTER TABLE`, `DROP TABLE`, or `DROP DATABASE`.

The query cache also works within transactions when using `InnoDB` tables.

In MySQL 5.1, the result from a `SELECT` query on a view is cached.

The query cache works for `SELECT SQL_CALC_FOUND_ROWS ...` queries and stores a value that is returned by a following `SELECT FOUND_ROWS()` query. `FOUND_ROWS()` returns the correct value even if the preceding query was fetched from the cache because the number of found rows is also stored in the cache. The `SELECT FOUND_ROWS()` query itself cannot be cached.

Before MySQL 5.1.17, prepared statements do not use the query cache. Beginning with 5.1.17, prepared statements use the query cache under certain conditions, which differ depending on the preparation method:



- Statements that are issued via the binary protocol using `mysql_stmt_prepare()` and `mysql_stmt_execute()`. See [Section 20.10.4, “C API Prepared Statements”](#).

For a prepared statement executed via the binary protocol, comparison with statements in the query cache is based on the text of the statement after expansion of `?` parameter markers. The statement is compared only with other cached statements that were executed via the binary protocol. That is, for query cache purposes, statements issued via the binary protocol are distinct from statements issued via the text protocol.

- Statements that are issued via the text (nonbinary) protocol using `PREPARE` and `EXECUTE`. See [Section 12.7, “SQL Syntax for Prepared Statements”](#). These are denoted SQL PS statements here.

Before MySQL 5.1.21, for a prepared statement executed via `PREPARE` and `EXECUTE`, it is not cached if it contains any `?` parameter markers. In that case, the statement after parameter expansion contains references to user variables, which prevents caching, even for non-prepared statements. If the statement contains no parameter markers, the statement is compared with statements in the query cache that were executed via the text protocol (that is, it is compared with other SQL PS statements and non-prepared statements). As of MySQL 5.1.21, this limitation is lifted and prepared statements that contain parameter markers can be cached because expansion directly substitutes the user variable values.

A query cannot be cached if it contains any of the functions shown in the following table.

<code>BENCHMARK()</code>	<code>CONNECTION_ID()</code>	<code>CONVERT_TZ()</code>
<code>CURDATE()</code>	<code>CURRENT_DATE()</code>	<code>CURRENT_TIME()</code>
<code>CURRENT_TIMESTAMP()</code>	<code>CURTIME()</code>	<code>DATABASE()</code>
<code>ENCRYPT()</code> with one parameter	<code>FOUND_ROWS()</code>	<code>GET_LOCK()</code>
<code>LAST_INSERT_ID()</code>	<code>LOAD_FILE()</code>	<code>MASTER_POS_WAIT()</code>
<code>NOW()</code>	<code>RAND()</code>	<code>RELEASE_LOCK()</code>
<code>SLEEP()</code>	<code>SYSDATE()</code>	<code>UNIX_TIMESTAMP()</code> with no parameters
<code>USER()</code>	<code>UUID()</code>	<code>UUID_SHORT()</code>

A query also is not cached under these conditions:

- It refers to user-defined functions (UDFs) or stored functions.
- It refers to user variables or local stored program variables.
- It refers to tables in the `mysql` or `INFORMATION_SCHEMA` system database.
- It is of any of the following forms:

```
SELECT ... LOCK IN SHARE MODE
SELECT ... FOR UPDATE
SELECT ... INTO OUTFILE ...
SELECT ... INTO DUMPFILE ...
SELECT * FROM ... WHERE autoincrement_col IS NULL
```

The last form is not cached because it is used as the ODBC workaround for obtaining the last insert ID value. See the MyODBC section of [Chapter 20, Connectors and APIs](#).

- It uses `TEMPORARY` tables.
- It does not use any tables.
- It generates warnings.
- The user has a column-level privilege for any of the involved tables.

### 7.5.5.2. Query Cache `SELECT` Options

Two query cache-related options may be specified in `SELECT` statements:

- `SQL_CACHE`

The query result is cached if it is cacheable and the value of the `query_cache_type` system variable is `ON` or `DEMAND`.

- `SQL_NO_CACHE`

The query result is not cached.

Examples:

```
SELECT SQL_CACHE id, name FROM customer;
SELECT SQL_NO_CACHE id, name FROM customer;
```

### 7.5.5.3. Query Cache Configuration

The `have_query_cache` server system variable indicates whether the query cache is available:

```
mysql> SHOW VARIABLES LIKE 'have_query_cache';
+-----+-----+
| Variable_name | Value |
+-----+-----+
| have_query_cache | YES |
+-----+-----+
```

When using a standard MySQL binary, this value is always `YES`, even if query caching is disabled.

Several other system variables control query cache operation. These can be set in an option file or on the command line when starting `mysqld`. The query cache system variables all have names that begin with `query_cache_`. They are described briefly in [Section 5.1.3, “Server System Variables”](#), with additional configuration information given here.

To set the size of the query cache, set the `query_cache_size` system variable. Setting it to 0 disables the query cache. The default size is 0, so the query cache is disabled by default.

#### MySQL Enterprise

For expert advice on configuring the query cache subscribe to the MySQL Enterprise Monitor. For more information, see <http://www.mysql.com/products/enterprise/advisors.html>.

#### Note

When using the Windows Configuration Wizard to install or configure MySQL, the default value for `query_cache_size` will be configured automatically for you based on the different configuration types available. When using the Windows Configuration Wizard, the query cache may be enabled (that is, set to a nonzero value) due to the selected configuration. The query cache is also controlled by the setting of the `query_cache_type` variable. You should check the values of these variables as set in your `my.ini` file after configuration has taken place.

When you set `query_cache_size` to a nonzero value, keep in mind that the query cache needs a minimum size of about 40KB to allocate its structures. (The exact size depends on system architecture.) If you set the value too small, you'll get a warning, as in this example:

```
mysql> SET GLOBAL query_cache_size = 40000;
Query OK, 0 rows affected, 1 warning (0.00 sec)

mysql> SHOW WARNINGS\G
***** 1. row *****
Level: Warning
Code: 1282
Message: Query cache failed to set size 39936;
        new query cache size is 0

mysql> SET GLOBAL query_cache_size = 41984;
Query OK, 0 rows affected (0.00 sec)

mysql> SHOW VARIABLES LIKE 'query_cache_size';
+-----+-----+
| Variable_name | Value |
+-----+-----+
| query_cache_size | 41984 |
+-----+-----+
```

For the query cache to actually be able to hold any query results, its size must be set larger:

```
mysql> SET GLOBAL query_cache_size = 1000000;
Query OK, 0 rows affected (0.04 sec)

mysql> SHOW VARIABLES LIKE 'query_cache_size';
+-----+-----+
| Variable_name | Value |
+-----+-----+
```

```
| query_cache_size | 999424 |
+-----+-----+
1 row in set (0.00 sec)
```

The `query_cache_size` value is aligned to the nearest 1024 byte block. The value reported may therefore be different from the value that you assign.

If the query cache size is greater than 0, the `query_cache_type` variable influences how it works. This variable can be set to the following values:

- A value of `0` or `OFF` prevents caching or retrieval of cached results.
- A value of `1` or `ON` allows caching except of those statements that begin with `SELECT SQL_NO_CACHE`.
- A value of `2` or `DEMAND` causes caching of only those statements that begin with `SELECT SQL_CACHE`.

Setting the `GLOBAL query_cache_type` value determines query cache behavior for all clients that connect after the change is made. Individual clients can control cache behavior for their own connection by setting the `SESSION query_cache_type` value. For example, a client can disable use of the query cache for its own queries like this:

```
mysql> SET SESSION query_cache_type = OFF;
```

If you set `query_cache_type` at server startup (rather than at runtime with a `SET` statement), only the numeric values are allowed.

To control the maximum size of individual query results that can be cached, set the `query_cache_limit` system variable. The default value is 1MB.

### Note

You can set the maximum size that can be specified for the query cache at run time with the `SET` statement by using the `--maximum-query-cache-size=32M` option on the command line or in the configuration file.

When a query is to be cached, its result (the data sent to the client) is stored in the query cache during result retrieval. Therefore the data usually is not handled in one big chunk. The query cache allocates blocks for storing this data on demand, so when one block is filled, a new block is allocated. Because memory allocation operation is costly (timewise), the query cache allocates blocks with a minimum size given by the `query_cache_min_res_unit` system variable. When a query is executed, the last result block is trimmed to the actual data size so that unused memory is freed. Depending on the types of queries your server executes, you might find it helpful to tune the value of `query_cache_min_res_unit`:

- The default value of `query_cache_min_res_unit` is 4KB. This should be adequate for most cases.
- If you have a lot of queries with small results, the default block size may lead to memory fragmentation, as indicated by a large number of free blocks. Fragmentation can force the query cache to prune (delete) queries from the cache due to lack of memory. In this case, you should decrease the value of `query_cache_min_res_unit`. The number of free blocks and queries removed due to pruning are given by the values of the `Qcache_free_blocks` and `Qcache_lowmem_prunes` status variables.
- If most of your queries have large results (check the `Qcache_total_blocks` and `Qcache_queries_in_cache` status variables), you can increase performance by increasing `query_cache_min_res_unit`. However, be careful to not make it too large (see the previous item).

### MySQL Enterprise

If the query cache is under-utilized, performance will suffer. Advice on avoiding this problem is provided to subscribers to the MySQL Enterprise Monitor. For more information, see <http://www.mysql.com/products/enterprise/advisors.html>.

## 7.5.5.4. Query Cache Status and Maintenance

You can check whether the query cache is present in your MySQL server using the following statement:

```
mysql> SHOW VARIABLES LIKE 'have_query_cache';
+-----+-----+
| Variable_name | Value |
+-----+-----+
| have_query_cache | YES  |
+-----+-----+
```

You can defragment the query cache to better utilize its memory with the `FLUSH QUERY CACHE` statement. The statement does not remove any queries from the cache.

The `RESET QUERY CACHE` statement removes all query results from the query cache. The `FLUSH TABLES` statement also does this.

To monitor query cache performance, use `SHOW STATUS` to view the cache status variables:

```
mysql> SHOW STATUS LIKE 'Qcache%';
+-----+-----+
| Variable_name | Value |
+-----+-----+
| Qcache_free_blocks | 36 |
| Qcache_free_memory | 138488 |
| Qcache_hits | 79570 |
| Qcache_inserts | 27087 |
| Qcache_lowmem_prunes | 3114 |
| Qcache_not_cached | 22989 |
| Qcache_queries_in_cache | 415 |
| Qcache_total_blocks | 912 |
+-----+-----+
```

Descriptions of each of these variables are given in [Section 5.1.6, “Server Status Variables”](#). Some uses for them are described here.

The total number of `SELECT` queries is given by this formula:

```
Com_select
+ Qcache_hits
+ queries with errors found by parser
```

The `Com_select` value is given by this formula:

```
Qcache_inserts
+ Qcache_not_cached
+ queries with errors found during the column-privileges check
```

The query cache uses variable-length blocks, so `Qcache_total_blocks` and `Qcache_free_blocks` may indicate query cache memory fragmentation. After `FLUSH QUERY CACHE`, only a single free block remains.

Every cached query requires a minimum of two blocks (one for the query text and one or more for the query results). Also, every table that is used by a query requires one block. However, if two or more queries use the same table, only one table block needs to be allocated.

The information provided by the `Qcache_lowmem_prunes` status variable can help you tune the query cache size. It counts the number of queries that have been removed from the cache to free up memory for caching new queries. The query cache uses a least recently used (LRU) strategy to decide which queries to remove from the cache. Tuning information is given in [Section 7.5.5.3, “Query Cache Configuration”](#).

## 7.5.6. Examining Thread Information

When you are attempting to ascertain what your MySQL server is doing, it can be helpful to examine the process list, which is the set of threads currently executing within the server. Process list information is available from these sources:

- The `SHOW [FULL] PROCESSLIST` statement ([Section 12.5.5.31, “SHOW PROCESSLIST Syntax”](#))
- The `SHOW PROFILE` statement ([Section 12.5.5.33, “SHOW PROFILES Syntax”](#))
- The `INFORMATION_SCHEMA PROCESSLIST` table ([Section 19.22, “The INFORMATION\\_SCHEMA PROCESSLIST Table”](#))
- The `mysqladmin processlist` command ([Section 4.5.2, “mysqladmin — Client for Administering a MySQL Server”](#))

You can always view information about your own threads. To view information about threads being executed for other accounts, you must have the `PROCESS` privilege.

Each process list entry contains several pieces of information:

- `Id` is the connection identifier for the client associated with the thread.
- `User` and `Host` indicate the account associated with the thread.

- `db` is the default database for the thread, or `NULL` if none is selected.
- `Command` and `State` indicate what the thread is doing.

Most states correspond to very quick operations. If a thread stays in a given state for many seconds, there might be a problem that needs to be investigated.

- `Time` indicates how long the thread has been in its current state. The thread's notion of the current time may be altered in some cases: The thread can change the time with `SET TIMESTAMP = value`. For a thread running on a slave that is processing events from the master, the thread time is set to the time found in the events and thus reflects current time on the master and not the slave.
- `Info` contains the text of the statement being executed by the thread, or `NULL` if it is not executing one. By default, this value contains only the first 100 characters of the statement. To see the complete statements, use `SHOW FULL PROCESSLIST`.

The following sections list the possible `Command` values, and `State` values grouped by category. The meaning for some of these values is self-evident. For others, additional description is provided.

### 7.5.6.1. Thread Command Values

A thread can have any of the following `Command` values:

- `Binlog Dump`  
This is a thread on a master server for sending binary log contents to a slave server.
- `Change user`  
The thread is executing a change-user operation.
- `Close stmt`  
The thread is closing a prepared statement.
- `Connect`  
A replication slave is connected to its master.
- `Connect Out`  
A replication slave is connecting to its master.
- `Create DB`  
The thread is executing a create-database operation.
- `Daemon`  
This thread is internal to the server, not a thread that services a client connection.
- `Debug`  
The thread is generating debugging information.
- `Delayed insert`  
The thread is a delayed-insert handler.
- `Drop DB`  
The thread is executing a drop-database operation.
- `Error`
- `Execute`  
The thread is executing a prepared statement.
- `Fetch`

The thread is fetching the results from executing a prepared statement.

- `Field List`

The thread is retrieving information for table columns.

- `Init DB`

The thread is selecting a default database.

- `Kill`

The thread is killing another thread.

- `Long Data`

The thread is retrieving long data in the result of executing a prepared statement.

- `Ping`

The thread is handling a server-ping request.

- `Prepare`

The thread is preparing a prepared statement.

- `Processlist`

The thread is producing information about server threads.

- `Query`

The thread is executing a statement.

- `Quit`

The thread is terminating.

- `Refresh`

The thread is flushing table, logs, or caches, or resetting status variable or replication server information.

- `Register Slave`

The thread is registering a slave server.

- `Reset stmt`

The thread is resetting a prepared statement.

- `Set option`

The thread is setting or resetting a client statement-execution option.

- `Shutdown`

The thread is shutting down the server.

- `Sleep`

The thread is waiting for the client to send a new statement to it.

- `Statistics`

The thread is producing server-status information.

- `Table Dump`

The thread is sending table contents to a slave server.

- `Time`

Unused.

### 7.5.6.2. General Thread States

The following list describes thread `State` values that are associated with general query processing and not more specialized activities such as replication. Many of these are useful only for finding bugs in the server.

- `After create`

Occurs when the thread creates a table (including internal temporary tables), at the end of the function that creates the table. This state is used even if the table could not be created due to some error.
- `Analyzing`

The thread is calculating a `MyISAM` table key distributions (for example, for `ANALYZE TABLE`).
- `checking permissions`

The thread is checking whether the server has the required privileges to execute the statement.
- `Checking table`

The thread is performing a table check operation.
- `cleaning up`

The thread has processed one command and is preparing to free memory and reset certain state variables.
- `closing tables`

Means that the thread is flushing the changed table data to disk and closing the used tables. This should be a fast operation. If not, you should verify that you do not have a full disk and that the disk is not in very heavy use.
- `converting HEAP to MyISAM`

The thread is converting an internal temporary table from a `MEMORY` table to an on-disk `MyISAM` table.
- `copy to tmp table`

The thread is processing an `ALTER TABLE` statement. This state occurs after the table with the new structure has been created but before rows are copied into it.
- `Copying to group table`

If a statement has different `ORDER BY` and `GROUP BY` criteria, the rows are sorted by group and copied to a temporary table.
- `Copying to tmp table`

The server is copying to a temporary table in memory.
- `Copying to tmp table on disk`

The server is copying to a temporary table on disk. The temporary result set was larger than `tmp_table_size` and the thread is changing the temporary table from in-memory to disk-based format to save memory.
- `Creating index`

The thread is processing `ALTER TABLE ... ENABLE KEYS` for a `MyISAM` table.
- `Creating sort index`

The thread is processing a `SELECT` that is resolved using an internal temporary table.
- `creating table`

The thread is creating a table. This includes creation of temporary tables.
- `Creating tmp table`

The thread is creating a temporary table in memory or on disk. If the table is created in memory but later is converted to an on-disk table, the state during that operation will be `Copying to tmp table on disk`.

- `deleting from main table`

The server is executing the first part of a multiple-table delete. It is deleting only from the first table, and saving columns and offsets to be used for deleting from the other (reference) tables.

- `deleting from reference tables`

The server is executing the second part of a multiple-table delete and deleting the matched rows from the other tables.

- `discard_or_import_tablespace`

The thread is processing an `ALTER TABLE ... DISCARD TABLESPACE` or `ALTER TABLE ... IMPORT TABLESPACE` statement.

- `end`

This occurs at the end but before the cleanup of `ALTER TABLE`, `CREATE VIEW`, `DELETE`, `INSERT`, `SELECT`, or `UPDATE` statements.

- `executing`

The thread has begun executing a statement.

- `Execution of init_command`

The thread is executing statements in the value of the `init_command` system variable.

- `freeing items`

The thread has executed a command. This state is usually followed by `cleaning up`.

- `Flushing tables`

The thread is executing `FLUSH TABLES` and is waiting for all threads to close their tables.

- `FULLTEXT initialization`

The server is preparing to perform a natural-language full-text search.

- `init`

This occurs before the initialization of `ALTER TABLE`, `DELETE`, `INSERT`, `SELECT`, or `UPDATE` statements.

- `Killed`

Someone has sent a `KILL` statement to the thread and it should abort next time it checks the kill flag. The flag is checked in each major loop in MySQL, but in some cases it might still take a short time for the thread to die. If the thread is locked by some other thread, the kill takes effect as soon as the other thread releases its lock.

- `Locked`

The query is locked by another query.

- `logging slow query`

The thread is writing a statement to the slow-query log.

- `NULL`

This state is used for the `SHOW PROCESSLIST` state.

- `login`

The initial state for a connection thread until the client has been authenticated successfully.

- `Opening tables`, `Opening table`

The thread is trying to open a table. This is should be very fast procedure, unless something prevents opening. For example, an



`ALTER TABLE` or a `LOCK TABLE` statement can prevent opening a table until the statement is finished.

- `preparing`  
This state occurs during query optimization.
- `Purging old relay logs`  
The thread is removing unneeded relay log files.
- `query end`  
This state occurs after processing a query but before the `freeing items` state.
- `Reading from net`  
The server is reading a packet from the network.
- `Removing duplicates`  
The query was using `SELECT DISTINCT` in such a way that MySQL could not optimize away the distinct operation at an early stage. Because of this, MySQL requires an extra stage to remove all duplicated rows before sending the result to the client.
- `removing tmp table`  
The thread is removing an internal temporary table after processing a `SELECT` statement. This state is not used if no temporary table was created.
- `rename`  
The thread is renaming a table.
- `rename result table`  
The thread is processing an `ALTER TABLE` statement, has created the new table, and is renaming it to replace the original table.
- `Reopen tables`  
The thread got a lock for the table, but noticed after getting the lock that the underlying table structure changed. It has freed the lock, closed the table, and is trying to reopen it.
- `Repair by sorting`  
The repair code is using a sort to create indexes.
- `Repair done`  
The thread has completed a multi-threaded repair for a `MyISAM` table.
- `Repair with keycache`  
The repair code is using creating keys one by one through the key cache. This is much slower than `Repair by sorting`.
- `Rolling back`  
The thread is rolling back a transaction.
- `Saving state`  
For `MyISAM` table operations such as repair or analysis, the thread is saving the new table state to the `.MYI` file header. State includes information such as number of rows, the `AUTO_INCREMENT` counter, and key distributions.
- `Searching rows for update`  
The thread is doing a first phase to find all matching rows before updating them. This has to be done if the `UPDATE` is changing the index that is used to find the involved rows.
- `Sending data`  
The thread is processing rows for a `SELECT` statement and also is sending data to the client.

- `setup`

The thread is beginning an `ALTER TABLE` operation.
- `Sorting for group`

The thread is doing a sort to satisfy a `GROUP BY`.
- `Sorting for order`

The thread is doing a sort to satisfy a `ORDER BY`.
- `Sorting index`

The thread is sorting index pages for more efficient access during a `MyISAM` table optimization operation.
- `Sorting result`

For a `SELECT` statement, this is similar to `Creating sort index`, but for non-temporary tables.
- `statistics`

The server is calculating statistics to develop a query execution plan.
- `System lock`

The thread is going to request or is waiting for an internal or external system lock for the table. If this state is being caused by requests for external locks and you are not using multiple `mysqld` servers that are accessing the same tables, you can disable external system locks with the `--skip-external-locking` option. However, external locking is disabled by default, so it is likely that this option will have no effect.
- `Table lock`

The next thread state after `System lock`. The thread has acquired an external lock and is going to request an internal table lock.
- `Updating`

The thread is searching for rows to update and is updating them.
- `updating main table`

The server is executing the first part of a multiple-table update. It is updating only the first table, and saving columns and offsets to be used for updating the other (reference) tables.
- `updating reference tables`

The server is executing the second part of a multiple-table update and updating the matched rows from the other tables.
- `User lock`

The thread is going to request or is waiting for an advisory lock requested with a `GET_LOCK( )` call. For `SHOW PROFILE`, this state means the thread is requesting the lock (not waiting for it).
- `Waiting for tables,Waiting for table`

The thread got a notification that the underlying structure for a table has changed and it needs to reopen the table to get the new structure. However, to reopen the table, it must wait until all other threads have closed the table in question.

This notification takes place if another thread has used `FLUSH TABLES` or one of the following statements on the table in question: `FLUSH TABLES tbl_name`, `ALTER TABLE`, `RENAME TABLE`, `REPAIR TABLE`, `ANALYZE TABLE`, or `OPTIMIZE TABLE`.
- `Waiting on cond`

A generic state in which the thread is waiting for a condition to become true. No specific state information is available.
- `Writing to net`

The server is writing a packet to the network.

### 7.5.6.3. Delayed-Insert Thread States

These thread states are associated with processing for `DELAYED` inserts (see [Section 12.2.5.2, “INSERT DELAYED Syntax”](#)). Some states are associated with connection threads that process `INSERT DELAYED` statements from clients. Other states are associated with delayed-insert handler threads that insert the rows. There is a delayed-insert handler thread for each table for which `INSERT DELAYED` statements are issued.

States associated with a connection thread that processes an `INSERT DELAYED` statement from the client:

- `allocating local table`

The thread is preparing to feed rows to the delayed-insert handler thread.
- `Creating delayed handler`

The thread is creating a handler for `DELAYED` inserts.
- `got handler lock`

This occurs before the `allocating local table` state and after the `waiting for handler lock` state, when the connection thread gets access to the delayed-insert handler thread.
- `got old table`

This occurs after the `waiting for handler open` state. The delayed-insert handler thread has signaled that it has ended its initialization phase, which includes opening the table for delayed inserts.
- `storing row into queue`

The thread is adding a new row to the list of rows that the delayed-insert handler thread must insert.
- `update`
- `waiting for delay_list`

This occurs during the initialization phase when the thread is trying to find the delayed-insert handler thread for the table, and before attempting to gain access to the list of delayed-insert threads.
- `waiting for handler insert`

An `INSERT DELAYED` handler has processed all pending inserts and is waiting for new ones.
- `waiting for handler lock`

This occurs before the `allocating local table` state when the connection thread waits for access to the delayed-insert handler thread.
- `waiting for handler open`

This occurs after the `Creating delayed handler` state and before the `got old table` state. The delayed-insert handler thread has just been started, and the connection thread is waiting for it to initialize.

States associated with a delayed-insert handler thread that inserts the rows:

- `insert`

The state that occurs just before inserting rows into the table.
- `reschedule`

After inserting a number of rows, the delayed-insert thread sleeps to let other threads do work.
- `upgrading lock`

A delayed-insert handler is trying to get a lock for the table to insert rows.
- `Waiting for INSERT`

A delayed-insert handler is waiting for a connection thread to add rows to the queue (see `storing row into queue`).

### 7.5.6.4. Replication Master Thread States

The following list shows the most common states you may see in the `State` column for the master's `Binlog Dump` thread. If you see no `Binlog Dump` threads on a master server, this means that replication is not running — that is, that no slaves are currently connected.

- `Sending binlog event to slave`

Binary logs consist of *events*, where an event is usually an update plus some other information. The thread has read an event from the binary log and is now sending it to the slave.

- `Finished reading one binlog; switching to next binlog`

The thread has finished reading a binary log file and is opening the next one to send to the slave.

- `Has sent all binlog to slave; waiting for binlog to be updated`

The thread has read all outstanding updates from the binary logs and sent them to the slave. The thread is now idle, waiting for new events to appear in the binary log resulting from new updates occurring on the master.

- `Waiting to finalize termination`

A very brief state that occurs as the thread is stopping.

### 7.5.6.5. Replication Slave I/O Thread States

The following list shows the most common states you see in the `State` column for a slave server I/O thread. This state also appears in the `Slave_IO_State` column displayed by `SHOW SLAVE STATUS`, so you can get a good view of what is happening by using that statement.

- `Waiting for master update`

The initial state before `Connecting to master`.

- `Connecting to master`

The thread is attempting to connect to the master.

- `Checking master version`

A state that occurs very briefly, after the connection to the master is established.

- `Registering slave on master`

A state that occurs very briefly after the connection to the master is established.

- `Requesting binlog dump`

A state that occurs very briefly, after the connection to the master is established. The thread sends to the master a request for the contents of its binary logs, starting from the requested binary log file name and position.

- `Waiting to reconnect after a failed binlog dump request`

If the binary log dump request failed (due to disconnection), the thread goes into this state while it sleeps, then tries to reconnect periodically. The interval between retries can be specified using the `CHANGE MASTER TO` statement or the `--master-connect-retry` option.

- `Reconnecting after a failed binlog dump request`

The thread is trying to reconnect to the master.

- `Waiting for master to send event`

The thread has connected to the master and is waiting for binary log events to arrive. This can last for a long time if the master is idle. If the wait lasts for `slave_net_timeout` seconds, a timeout occurs. At that point, the thread considers the connection to be broken and makes an attempt to reconnect.

- `Queueing master event to the relay log`

The thread has read an event and is copying it to the relay log so that the SQL thread can process it.

- `Waiting to reconnect after a failed master event read`

An error occurred while reading (due to disconnection). The thread is sleeping for the number of seconds set by the `CHANGE MASTER TO` statement or `--master-connect-retry` option (default 60) before attempting to reconnect.

- `Reconnecting after a failed master event read`

The thread is trying to reconnect to the master. When connection is established again, the state becomes `Waiting for master to send event`.

- `Waiting for the slave SQL thread to free enough relay log space`

You are using a nonzero `relay_log_space_limit` value, and the relay logs have grown large enough that their combined size exceeds this value. The I/O thread is waiting until the SQL thread frees enough space by processing relay log contents so that it can delete some relay log files.

- `Waiting for slave mutex on exit`

A state that occurs briefly as the thread is stopping.

### 7.5.6.6. Replication Slave SQL Thread States

The following list shows the most common states you may see in the `State` column for a slave server SQL thread:

- `Waiting for the next event in relay log`

The initial state before `Reading event from the relay log`.

- `Reading event from the relay log`

The thread has read an event from the relay log so that the event can be processed.

- `Has read all relay log; waiting for the slave I/O thread to update it`

The thread has processed all events in the relay log files, and is now waiting for the I/O thread to write new events to the relay log.

- `Making temp file`

The thread is executing a `LOAD DATA INFILE` statement and is creating a temporary file containing the data from which the slave will read rows.

- `Waiting for slave mutex on exit`

A very brief state that occurs as the thread is stopping.

The `State` column for the I/O thread may also show the text of a statement. This indicates that the thread has read an event from the relay log, extracted the statement from it, and is executing it.

### 7.5.6.7. Replication Slave Connection Thread States

These thread states occur on a replication slave but are associated with connection threads, not with the I/O or SQL threads.

- `Changing master`

The thread is processing a `CHANGE MASTER TO` statement.

- `Creating table from master dump`

The slave is creating a table using the `CREATE TABLE` statement contained in the dump from the master. Used for `LOAD TABLE FROM MASTER` and `LOAD DATA FROM MASTER`.

- `Killing slave`

The thread is processing a `SLAVE STOP` statement.

- `Opening master dump table`

This state occurs after `Creating table from master dump`.

- `Reading master dump table data`

This state occurs after `Opening master dump table`.

- `Rebuilding the index on master dump table`

This state occurs after `Reading master dump table data`.

- `starting slave`

The thread is starting the slave threads after processing a successful `LOAD DATA FROM MASTER` load operation.

### 7.5.6.8. MySQL Cluster Thread States

- `Committing events to binlog`
- `Opening mysql.ndb_apply_status`
- `Processing events`

The thread is processing events for binary logging.

- `Processing events from schema table`

The thread is doing the work of schema replication.

- `Shutting down`
- `Syncing ndb table schema operation and binlog`

This is used to have a correct binary log of schema operations for NDB.

- `Waiting for event from ndbcluster`

The server is acting as an SQL node in a MySQL Cluster, and is connected to a cluster management node.

- `Waiting for first event from ndbcluster`
- `Waiting for ndbcluster binlog update to reach current position`
- `Waiting for ndbcluster to start`
- `Waiting for schema epoch`

The thread is waiting for a schema epoch (that is, a global checkpoint).

### 7.5.6.9. Event Scheduler Thread States

These states occur for the Event Scheduler thread, threads that are created to execute scheduled events, or threads that terminate the scheduler.

- `Clearing`

The scheduler thread or a thread that was executing an event is terminating and is about to end.

- `Initialized`

The scheduler thread or a thread that will execute an event has been initialized.

- `Waiting for next activation`

The scheduler has a non-empty event queue but the next activation is in the future.

- [Waiting for scheduler to stop](#)

The thread issued `SET GLOBAL event_scheduler=OFF` and is waiting for the scheduler to stop.

- [Waiting on empty queue](#)

The scheduler's event queue is empty and it is sleeping.

## 7.5.7. How MySQL Uses Threads for Client Connections

Connection manager threads handle client connection requests on the network interfaces that the server listens to. On all platforms, one manager thread handles TCP/IP connection requests. On Unix, this manager thread also handles Unix socket file connection requests. On Windows, a manager thread handles shared-memory connection requests, and another handles named-pipe connection requests. The server does not create threads to handle interfaces that it does not listen to. For example, a Windows server that does not have support for named-pipe connections enabled does not create a thread to handle them.

Connection manager threads associate each client connection with a thread dedicated to it that handles authentication and request processing for that connection. Manager threads create a new thread when necessary but try to avoid doing so by consulting the thread cache first to see whether it contains a thread that can be used for the connection. When a connection ends, its thread is returned to the thread cache if the cache is not full.

In this connection thread model, there are as many threads as there are clients currently connected, which has some disadvantages when server workload must scale to handle large numbers of connections. For example, thread creation and disposal becomes expensive. Also, each thread requires server and kernel resources, such as stack space. To accommodate a large number of simultaneous connections, the stack size per thread must be kept small, leading to a situation where it is either too small or the server consumes large amounts of memory. Exhaustion of other resources can occur as well, and scheduling overhead can become significant.

To control and monitor how the server manages threads that handle client connections, several system and status variables are relevant. (See [Section 5.1.3, “Server System Variables”](#), and [Section 5.1.6, “Server Status Variables”](#).)

The thread cache has a size determined by the `thread_cache_size` system variable. The default value is 0 (no caching), which causes a thread to be set up for each new connection and disposed of when the connection terminates. Set `thread_cache_size` to `N` to allow `N` inactive connection threads to be cached. `thread_cache_size` can be set at server startup or changed while the server runs. A connection thread becomes inactive when the client connection with which it was associated terminates.

To monitor the number of threads in the cache and how many threads have been created because a thread could not be taken from the cache, monitor the `Threads_cached` and `Threads_created` status variables.

You can set `max_connections` at server startup or at runtime to control the maximum number of clients that can connect simultaneously.

When the thread stack is too small, this limits the complexity of the SQL statements which the server can handle, the recursion depth of stored procedures, and other memory-consuming actions. To set a stack size of `N` bytes for each thread, start the server with `--thread_stack=N`.

## 7.5.8. How MySQL Uses Memory

The following list indicates some of the ways that the `mysqld` server uses memory. Where applicable, the name of the system variable relevant to the memory use is given:

- The key buffer is shared by all threads; its size is determined by the `key_buffer_size` variable. Other buffers used by the server are allocated as needed. See [Section 7.5.3, “Tuning Server Parameters”](#).
- Each thread that is used to manage client connections uses some thread-specific space. The following list indicates these and which variables control their size:
  - A stack (default 192KB, variable `thread_stack`)
  - A connection buffer (variable `net_buffer_length`)
  - A result buffer (variable `net_buffer_length`)

The connection buffer and result buffer both begin with a size given by `net_buffer_length` but are dynamically enlarged up to `max_allowed_packet` bytes as needed. The result buffer shrinks to `net_buffer_length` after each SQL statement. While a statement is running, a copy of the current statement string is also allocated.

- All threads share the same base memory.
- When a thread is no longer needed, the memory allocated to it is released and returned to the system unless the thread goes back into the thread cache. In that case, the memory remains allocated.
- Before MySQL 5.1.4, only compressed `MyISAM` tables are memory mapped. As of MySQL 5.1.4, the `myisam_use_mmap` system variable can be set to 1 to enable memory-mapping for all `MyISAM` tables.
- Each request that performs a sequential scan of a table allocates a *read buffer* (variable `read_buffer_size`).
- When reading rows in an arbitrary sequence (for example, following a sort), a *random-read buffer* (variable `read_rnd_buffer_size`) may be allocated in order to avoid disk seeks.
- All joins are executed in a single pass, and most joins can be done without even using a temporary table. Most temporary tables are memory-based hash tables. Temporary tables with a large row length (calculated as the sum of all column lengths) or that contain `BLOB` columns are stored on disk.

If an internal heap table exceeds the size of `tmp_table_size`, MySQL handles this automatically by changing the in-memory heap table to a disk-based `MyISAM` table as necessary. You can also increase the temporary table size by setting the `tmp_table_size` option to `mysqld`, or by setting the SQL option `sql_big_tables` in the client program. See [Section 5.1.4, “Session System Variables”](#).

#### MySQL Enterprise

Subscribers to the MySQL Enterprise Monitor are alerted when temporary tables exceed `tmp_table_size`. Advisors make recommendations for the optimum value of `tmp_table_size` based on actual table usage. For more information about the MySQL Enterprise Monitor please see <http://www.mysql.com/products/enterprise/advisors.html>.

- Most requests that perform a sort allocate a sort buffer and zero to two temporary files depending on the result set size. See [Section B.1.4.4, “Where MySQL Stores Temporary Files”](#).
- Almost all parsing and calculating is done in a local memory store. No memory overhead is needed for small items, so the normal slow memory allocation and freeing is avoided. Memory is allocated only for unexpectedly large strings. This is done with `malloc()` and `free()`.
- For each `MyISAM` table that is opened, the index file is opened once; the data file is opened once for each concurrently running thread. For each concurrent thread, a table structure, column structures for each column, and a buffer of size  $3 \times N$  are allocated (where  $N$  is the maximum row length, not counting `BLOB` columns). A `BLOB` column requires five to eight bytes plus the length of the `BLOB` data. The `MyISAM` storage engine maintains one extra row buffer for internal use.
- For each table having `BLOB` columns, a buffer is enlarged dynamically to read in larger `BLOB` values. If you scan a table, a buffer as large as the largest `BLOB` value is allocated.
- Handler structures for all in-use tables are saved in a cache and managed as a FIFO. By default, the cache has 64 entries. If a table has been used by two running threads at the same time, the cache contains two entries for the table. See [Section 7.4.7, “How MySQL Opens and Closes Tables”](#).
- A `FLUSH TABLES` statement or `mysqladmin flush-tables` command closes all tables that are not in use at once and marks all in-use tables to be closed when the currently executing thread finishes. This effectively frees most in-use memory. `FLUSH TABLES` does not return until all tables have been closed.
- The server caches information in memory as a result of `GRANT`, `CREATE USER`, `CREATE SERVER`, and `INSTALL PLUGIN` statements. This memory is not released by the corresponding `REVOKE`, `DROP USER`, `DROP SERVER`, and `UNINSTALL PLUGIN` statements, so for a server that executes many instances of the statements that cause caching, there will be an increase in memory use. This cached memory can be freed with `FLUSH PRIVILEGES`.

`ps` and other system status programs may report that `mysqld` uses a lot of memory. This may be caused by thread stacks on different memory addresses. For example, the Solaris version of `ps` counts the unused memory between stacks as used memory. You can verify this by checking available swap with `swap -s`. We test `mysqld` with several memory-leakage detectors (both commercial and Open Source), so there should be no memory leaks.

## 7.5.9. Enabling Large Page Support

Some hardware/operating system architectures support memory pages greater than the default (usually 4KB). The actual implementation of this support depends on the underlying hardware and operating system. Applications that perform a lot of memory accesses may obtain performance improvements by using large pages due to reduced Translation Lookaside Buffer (TLB) misses.

In MySQL, large pages can be used by InnoDB, to allocate memory for its buffer pool and additional memory pool.



Currently, MySQL supports only the Linux implementation of large page support (which is called HugeTLB in Linux).

Before large pages can be used on Linux, the kernel must be enabled to support them and it is necessary to configure the HugeTLB memory pool. For reference, the HugeTBL API is documented in the [Documentation/vm/hugetlbpage.txt](#) file of your Linux sources.

The kernel for some recent systems such as Red Hat Enterprise Linux appear to have the large pages feature enabled by default. To check whether this is true for your kernel, use the following command and look for output lines containing “huge”:

```
shell> cat /proc/meminfo | grep -i huge
HugePages_Total:      0
HugePages_Free:       0
HugePages_Rsvd:       0
HugePages_Surp:       0
Hugepagesize:         4096 kB
```

The non-empty command output indicates that large page support is present, but the zero values indicate that no pages are configured for use.

If your kernel needs to be reconfigured to support large pages, consult the [hugetlbpage.txt](#) file for instructions.

Assuming that your Linux kernel has large page support enabled, configure it for use by MySQL using the following commands. Normally, you put these in an `rc` file or equivalent startup file that is executed during the system boot sequence, so that the commands execute each time the system starts. The commands should execute early in the boot sequence, before the MySQL server starts. Be sure to change the allocation numbers and the group number as appropriate for your system.

```
# Set the number of pages to be used.
# Each page is normally 2MB, so a value of 20 = 40MB.
# This command actually allocates memory, so this much
# memory must be available.
echo 20 > /proc/sys/vm/nr_hugepages

# Set the group number that is allowed to access this
# memory (102 in this case). The mysql user must be a
# member of this group.
echo 102 > /proc/sys/vm/hugetlb_shm_group

# Increase the amount of shmem allowed per segment
# (12G in this case).
echo 1560281088 > /proc/sys/kernel/shmmax

# Increase total amount of shared memory. The value
# is the number of pages. At 4KB/page, 4194304 = 16GB.
echo 4194304 > /proc/sys/kernel/shmall
```

For MySQL usage, you normally want the value of `shmmax` to be close to the value of `shmall`.

To verify the large page configuration, check `/proc/meminfo` again as described previously. Now you should see some nonzero values:

```
shell> cat /proc/meminfo | grep -i huge
HugePages_Total:      20
HugePages_Free:       20
HugePages_Rsvd:       0
HugePages_Surp:       0
Hugepagesize:         4096 kB
```

The final step to make use of the `hugetlb_shm_group` is to give the `mysql` user an “unlimited” value for the memlock limit. This can be done either by editing `/etc/security/limits.conf` or by adding the following command to your `mysqld_safe` script:

```
ulimit -l unlimited
```

Adding the `ulimit` command to `mysqld_safe` causes the `root` user to set the memlock limit to `unlimited` before switching to the `mysql` user. (This assumes that `mysqld_safe` is started by `root`.)

Large page support in MySQL is disabled by default. To enable it, start the server with the `--large-pages` option. For example, you can use the following lines in your server's `my.cnf` file:

```
[mysqld]
large-pages
```

With this option, `InnoDB` uses large pages automatically for its buffer pool and additional memory pool. If `InnoDB` cannot do this, it falls back to use of traditional memory and writes a warning to the error log: `WARNING: USING CONVENTIONAL MEMORY POOL`

You can verify that large pages are being used by checking `/proc/meminfo` again:

```
shell> cat /proc/meminfo | grep -i huge
HugePages_Total:      20
HugePages_Free:       20
HugePages_Rsvd:       2
HugePages_Surp:       0
Hugepagesize:         4096 kB
```

## 7.5.10. How MySQL Uses Internal Temporary Tables

In some cases, the server creates internal temporary tables while processing queries. A temporary table can be held in memory and processed by the `MEMORY` storage engine, or stored on disk and processed by the `MyISAM` storage engine. Temporary tables can be created under conditions such as these:

- If there is an `ORDER BY` clause and a different `GROUP BY` clause, or if the `ORDER BY` or `GROUP BY` contains columns from tables other than the first table in the join queue, a temporary table is created.
- If you use the `SQL_SMALL_RESULT` option, MySQL uses an in-memory temporary table.
- `DISTINCT` combined with `ORDER BY` may require a temporary table.

You can tell whether a query requires a temporary table by using `EXPLAIN` and checking the `Extra` column to see whether it says `Using temporary`. See Section 7.2.1, “Optimizing Queries with `EXPLAIN`”.

Some conditions prevent the use of a `MEMORY` temporary table, in which case the server uses a `MyISAM` table instead:

- Presence of a `TEXT` or `BLOB` column in the table
- Presence of any column in a `GROUP BY` or `DISTINCT` clause larger than 512 bytes
- Presence of any column larger than 512 bytes in the `SELECT` list, if `UNION` or `UNION ALL` is used.

A temporary table that is created initially as a `MEMORY` table might be converted to a `MyISAM` table and stored on disk if it becomes too large. The `max_heap_table_size` system variable determines how large `MEMORY` tables are allowed to grow. It applies to all `MEMORY` tables, including those created with `CREATE TABLE`. However, for internal `MEMORY` tables, the actual maximum size is determined by `max_heap_table_size` in combination with `tmp_table_size`: Whichever value is smaller is the one that applies. If the size of an internal `MEMORY` table exceeds the limit, MySQL automatically converts it to an on-disk `MyISAM` table.

## 7.5.11. How MySQL Uses DNS

When a new client connects to `mysqld`, `mysqld` spawns a new thread to handle the request. This thread first checks whether the host name is in the host name cache. If not, the thread attempts to resolve the host name:

- The thread takes the IP address and resolves it to a host name (using `gethostbyaddr()`). It then takes that host name and resolves it back to the IP address (using `gethostbyname()`) and compares to ensure it is the original IP address.
- If the operating system supports the thread-safe `gethostbyaddr_r()` and `gethostbyname_r()` calls, the thread uses them to perform host name resolution.
- If the operating system does not support the thread-safe calls, the thread locks a mutex and calls `gethostbyaddr()` and `gethostbyname()` instead. In this case, no other thread can resolve host names that are not in the host name cache until the first thread unlocks the mutex.

You can disable DNS host name lookups by starting `mysqld` with the `--skip-name-resolve` option. However, in this case, you can use only IP numbers in the MySQL grant tables.

If you have a very slow DNS and many hosts, you can get more performance by either disabling DNS lookups with `--skip-name-resolve` or by increasing the `HOST_CACHE_SIZE` define (default value: 128) and recompiling `mysqld`.

You can disable the host name cache by starting the server with the `--skip-host-cache` option. To clear the host name cache, issue a `FLUSH HOSTS` statement or execute the `mysqladmin flush-hosts` command.

To disallow TCP/IP connections entirely, start `mysqld` with the `--skip-networking` option.

## 7.6. Disk Issues

- Disk seeks are a huge performance bottleneck. This problem becomes more apparent when the amount of data starts to grow so large that effective caching becomes impossible. For large databases where you access data more or less randomly, you can be sure that you need at least one disk seek to read and a couple of disk seeks to write things. To minimize this problem, use disks with low seek times.
- Increase the number of available disk spindles (and thereby reduce the seek overhead) by either symlinking files to different disks or striping the disks:

- Using symbolic links

This means that, for `MyISAM` tables, you symlink the index file and data files from their usual location in the data directory to another disk (that may also be striped). This makes both the seek and read times better, assuming that the disk is not used for other purposes as well. See [Section 7.6.1, “Using Symbolic Links”](#).

- Striping

Striping means that you have many disks and put the first block on the first disk, the second block on the second disk, and the  $N$ -th block on the  $(N \bmod \text{number\_of\_disks})$  disk, and so on. This means if your normal data size is less than the stripe size (or perfectly aligned), you get much better performance. Striping is very dependent on the operating system and the stripe size, so benchmark your application with different stripe sizes. See [Section 7.1.5, “Using Your Own Benchmarks”](#).

The speed difference for striping is *very* dependent on the parameters. Depending on how you set the striping parameters and number of disks, you may get differences measured in orders of magnitude. You have to choose to optimize for random or sequential access.

- For reliability, you may want to use RAID 0+1 (striping plus mirroring), but in this case, you need  $2 \times N$  drives to hold  $N$  drives of data. This is probably the best option if you have the money for it. However, you may also have to invest in some volume-management software to handle it efficiently.
- A good option is to vary the RAID level according to how critical a type of data is. For example, store semi-important data that can be regenerated on a RAID 0 disk, but store really important data such as host information and logs on a RAID 0+1 or RAID  $N$  disk. RAID  $N$  can be a problem if you have many writes, due to the time required to update the parity bits.
- On Linux, you can get much more performance by using `hdparm` to configure your disk's interface. (Up to 100% under load is not uncommon.) The following `hdparm` options should be quite good for MySQL, and probably for many other applications:

```
hdparm -m 16 -d 1
```

Note that performance and reliability when using this command depend on your hardware, so we strongly suggest that you test your system thoroughly after using `hdparm`. Please consult the `hdparm` manual page for more information. If `hdparm` is not used wisely, file system corruption may result, so back up everything before experimenting!

- You can also set the parameters for the file system that the database uses:

If you do not need to know when files were last accessed (which is not really useful on a database server), you can mount your file systems with the `-o noatime` option. That skips updates to the last access time in inodes on the file system, which avoids some disk seeks.

On many operating systems, you can set a file system to be updated asynchronously by mounting it with the `-o async` option. If your computer is reasonably stable, this should give you more performance without sacrificing too much reliability. (This flag is on by default on Linux.)

### 7.6.1. Using Symbolic Links

You can move tables and databases from the database directory to other locations and replace them with symbolic links to the new locations. You might want to do this, for example, to move a database to a file system with more free space or increase the speed of your system by spreading your tables to different disk.

The recommended way to do this is simply to symlink databases to a different disk. Symlink tables only as a last resort.

#### 7.6.1.1. Using Symbolic Links for Databases on Unix

On Unix, the way to symlink a database is first to create a directory on some disk where you have free space and then to create a symlink to it from the MySQL data directory.

```
shell> mkdir /drl/databases/test
shell> ln -s /drl/databases/test /path/to/datadir
```

MySQL does not support linking one directory to multiple databases. Replacing a database directory with a symbolic link works as long as you do not make a symbolic link between databases. Suppose that you have a database `db1` under the MySQL data directory, and then make a symlink `db2` that points to `db1`:

```
shell> cd /path/to/datadir
shell> ln -s db1 db2
```

The result is that, or any table `tbl_a` in `db1`, there also appears to be a table `tbl_a` in `db2`. If one client updates `db1.tbl_a` and another client updates `db2.tbl_a`, problems are likely to occur.

However, if you really need to do this, it is possible by altering the source file `mysys/my_symlink.c`, in which you should look for the following statement:

```
if (!(MyFlags & MY_RESOLVE_LINK) ||
    (!lstat(filename, &stat_buff) && S_ISLNK(stat_buff.st_mode)))
```

Change the statement to this:

```
if (1)
```

### 7.6.1.2. Using Symbolic Links for Tables on Unix

You should not symlink tables on systems that do not have a fully operational `realpath()` call. (Linux and Solaris support `realpath()`.) You can check whether your system supports symbolic links by issuing a `SHOW VARIABLES LIKE 'have_symlink'` statement.

Symlinks are fully supported only for `MyISAM` tables. For files used by tables for other storage engines, you may get strange problems if you try to use symbolic links.

The handling of symbolic links for `MyISAM` tables works as follows:

- In the data directory, you always have the table format (`.frm`) file, the data (`.MYD`) file, and the index (`.MYI`) file. The data file and index file can be moved elsewhere and replaced in the data directory by symlinks. The format file cannot.
- You can symlink the data file and the index file independently to different directories.
- You can instruct a running MySQL server to perform the symlinking by using the `DATA DIRECTORY` and `INDEX DIRECTORY` options to `CREATE TABLE`. See [Section 12.1.17, “CREATE TABLE Syntax”](#). Alternatively, symlinking can be accomplished manually from the command line using `ln -s` if `mysqld` is not running.

#### Note

Beginning with MySQL 5.1.24, the path used with either or both of the `DATA DIRECTORY` and `INDEX DIRECTORY` options may not include the MySQL `data` directory. ([Bug#32167](#))

- `myisamchk` does not replace a symlink with the data file or index file. It works directly on the file to which the symlink points. Any temporary files are created in the directory where the data file or index file is located. The same is true for the `ALTER TABLE`, `OPTIMIZE TABLE`, and `REPAIR TABLE` statements.

#### Note

When you drop a table that is using symlinks, *both the symlink and the file to which the symlink points are dropped*. This is an extremely good reason why you should *not* run `mysqld` as the system `root` or allow system users to have write access to MySQL database directories.

- If you rename a table with `ALTER TABLE ... RENAME` or `RENAME TABLE` and you do not move the table to another database, the symlinks in the database directory are renamed to the new names and the data file and index file are renamed accordingly.
- If you use `ALTER TABLE ... RENAME` or `RENAME TABLE` to move a table to another database, the table is moved to the other database directory. If the table name changed, the symlinks in the new database directory are renamed to the new names and the data file and index file are renamed accordingly.
- If you are not using symlinks, you should use the `--skip-symbolic-links` option to `mysqld` to ensure that no one can use `mysqld` to drop or rename a file outside of the data directory.

Table symlink operations that are not yet supported:

- `ALTER TABLE` ignores the `DATA DIRECTORY` and `INDEX DIRECTORY` table options.
- `BACKUP TABLE` and `RESTORE TABLE` do not respect symbolic links.
- The `.frm` file must *never* be a symbolic link (as indicated previously, only the data and index files can be symbolic links). Attempting to do this (for example, to make synonyms) produces incorrect results. Suppose that you have a database `db1` under the MySQL data directory, a table `tbl1` in this database, and in the `db1` directory you make a symlink `tbl2` that points to `tbl1`:

```
shell> cd /path/to/datadir/db1
shell> ln -s tbl1.frm tbl2.frm
shell> ln -s tbl1.MYD tbl2.MYD
shell> ln -s tbl1.MYI tbl2.MYI
```

Problems result if one thread reads `db1.tbl1` and another thread updates `db1.tbl2`:

- The query cache is “fooled” (it has no way of knowing that `tbl1` has not been updated, so it returns outdated results).
- `ALTER` statements on `tbl2` fail.

### 7.6.1.3. Using Symbolic Links for Databases on Windows

Symbolic links are enabled by default for all Windows servers. This enables you to put a database directory on a different disk by setting up a symbolic link to it. This is similar to the way that database symbolic links work on Unix, although the procedure for setting up the link is different. If you do not need symbolic links, you can disable them using the `--skip-symbolic-links` option.

On Windows, create a symbolic link to a MySQL database by creating a file in the data directory that contains the path to the destination directory. The file should be named `db_name.sym`, where `db_name` is the database name.

Suppose that the MySQL data directory is `C:\mysql\data` and you want to have database `foo` located at `D:\data\foo`. Set up a symlink using this procedure

1. Make sure that the `D:\data\foo` directory exists by creating it if necessary. If you already have a database directory named `foo` in the data directory, you should move it to `D:\data`. Otherwise, the symbolic link will be ineffective. To avoid problems, make sure that the server is not running when you move the database directory.
2. Create a text file `C:\mysql\data\foo.sym` that contains the path name `D:\data\foo\`.

#### Note

The path name to the new database and tables should be absolute. If you specify a relative path, the location will be relative to the `foo.sym` file.

After this, all tables created in the database `foo` are created in `D:\data\foo`.

The following limitations apply to the use of `.sym` files for database symbolic linking on Windows:

- The symbolic link is not used if a directory with the same name as the database exists in the MySQL data directory.
- The `--innodb_file_per_table` option cannot be used.
- If you run `mysqld` as a service, you cannot use a mapped drive to a remote server as the destination of the symbolic link. As a workaround, you can use the full path (`\\servername\path\`).

---

# Chapter 8. Language Structure

This chapter discusses the rules for writing the following elements of SQL statements when using MySQL:

- Literal values such as strings and numbers
- Identifiers such as database, table, and column names
- Reserved words
- User-defined and system variables
- Comments

## 8.1. Literal Values

This section describes how to write literal values in MySQL. These include strings, numbers, hexadecimal values, boolean values, and `NULL`. The section also covers the various nuances and “gotchas” that you may run into when dealing with these basic types in MySQL.

### 8.1.1. Strings

A string is a sequence of bytes or characters, enclosed within either single quote (“’”) or double quote (“””) characters. Examples:

```
'a string'
"another string"
```

Quoted strings placed next to each other are concatenated to a single string. The following lines are equivalent:

```
'a string'
'a' ' ' 'string'
```

If the `ANSI_QUOTES` SQL mode is enabled, string literals can be quoted only within single quotes because a string quoted within double quotes is interpreted as an identifier.

A *binary string* is a string of bytes that has no character set or collation. A *nonbinary string* is a string of characters that has a character set and collation. For both types of strings, comparisons are based on the numeric values of the string unit. For binary strings, the unit is the byte. For nonbinary strings the unit is the character and some character sets allow multi-byte characters. Character value ordering is a function of the string collation.

String literals may have an optional character set introducer and `COLLATE` clause:

```
[_charset_name]'string' [COLLATE collation_name]
```

Examples:

```
SELECT _latin1'string';
SELECT _latin1'string' COLLATE latin1_danish_ci;
```

You can use `N'literal'` (or `n'literal'`) to create a string in the national character set. These statements are equivalent:

```
SELECT N'some text';
SELECT n'some text';
SELECT _utf8'some text';
```

For more information about these forms of string syntax, see [Section 9.1.3.5, “Character String Literal Character Set and Collation”](#), and [Section 9.1.3.6, “National Character Set”](#).

Within a string, certain sequences have special meaning unless the `NO_BACKSLASH_ESCAPES` SQL mode is enabled. Each of these sequences begins with a backslash (“\”), known as the *escape character*. MySQL recognizes the following escape sequences.

<code>\0</code>	An ASCII NUL (0x00) character.
<code>\'</code>	A single quote (“'”) character.
<code>\"</code>	A double quote (“””) character.
<code>\b</code>	A backspace character.

<code>\n</code>	A newline (linefeed) character.
<code>\r</code>	A carriage return character.
<code>\t</code>	A tab character.
<code>\Z</code>	ASCII 26 (Control-Z). See note following the table.
<code>\\</code>	A backslash (“\”) character.
<code>\%</code>	A “%” character. See note following the table.
<code>\_</code>	A “_” character. See note following the table.

For all other escape sequences, backslash is ignored. That is, the escaped character is interpreted as if it was not escaped. For example, “\x” is just “x”.

These sequences are case sensitive. For example, “\b” is interpreted as a backspace, but “\B” is interpreted as “B”.

The ASCII 26 character can be encoded as “\Z” to enable you to work around the problem that ASCII 26 stands for END-OF-FILE on Windows. ASCII 26 within a file causes problems if you try to use `mysql db_name < file_name`.

Escape processing is done according to the character set indicated by the `character_set_connection` system variable. This is true even for strings that are preceded by an introducer that indicates a different character set, as discussed in [Section 9.1.3.5, “Character String Literal Character Set and Collation”](#).

The “\%” and “\\_” sequences are used to search for literal instances of “%” and “\_” in pattern-matching contexts where they would otherwise be interpreted as wildcard characters. See the description of the `LIKE` operator in [Section 11.4.1, “String Comparison Functions”](#). If you use “\%” or “\\_” in non-pattern-matching contexts, they evaluate to the strings “\%” and “\\_”, not to “%” and “\_”.

There are several ways to include quote characters within a string:

- A “'” inside a string quoted with “'” may be written as “' '”.
- A “” inside a string quoted with “” may be written as “ ””.
- Precede the quote character by an escape character (“\”).
- A “'” inside a string quoted with “” needs no special treatment and need not be doubled or escaped. In the same way, “” inside a string quoted with “'” needs no special treatment.

The following `SELECT` statements demonstrate how quoting and escaping work:

```
mysql> SELECT 'hello', "hello", "'hello'", 'hel'lo', '\hello';
+-----+-----+-----+-----+
| hello | "hello" | "'hello'" | hel'lo | '\hello' |
+-----+-----+-----+-----+

mysql> SELECT "hello", "'hello'", "'hello'", "hel"lo", "\"hello";
+-----+-----+-----+-----+
| hello | 'hello' | "'hello'" | hel"lo | "\"hello" |
+-----+-----+-----+-----+

mysql> SELECT 'This\nIs\nFour\nLines';
+-----+
| This
| Is
| Four
| Lines |
+-----+

mysql> SELECT 'disappearing\ backslash';
+-----+
| disappearing backslash |
+-----+
```

If you want to insert binary data into a string column (such as a `BLOB` column), the following characters must be represented by escape sequences.

<code>NUL</code>	<code>NUL</code> byte (0x00). Represent this character by “\0” (a backslash followed by an ASCII “0” character).
<code>\</code>	Backslash (ASCII 92). Represent this character by “\\”.
<code>'</code>	Single quote (ASCII 39). Represent this character by “\ '”.
<code>"</code>	Double quote (ASCII 34). Represent this character by “\ ””.

When writing application programs, any string that might contain any of these special characters must be properly escaped before the string is used as a data value in an SQL statement that is sent to the MySQL server. You can do this in two ways:

- Process the string with a function that escapes the special characters. In a C program, you can use the `mysql_real_escape_string()` C API function to escape characters. See [Section 20.10.3.53](#), “`mysql_real_escape_string()`”. The Perl DBI interface provides a `quote` method to convert special characters to the proper escape sequences. See [Section 20.12](#), “MySQL Perl API”. Other language interfaces may provide a similar capability.
- As an alternative to explicitly escaping special characters, many MySQL APIs provide a placeholder capability that enables you to insert special markers into a statement string, and then bind data values to them when you issue the statement. In this case, the API takes care of escaping special characters in the values for you.

## 8.1.2. Numbers

Integers are represented as a sequence of digits. Floats use “.” as a decimal separator. Either type of number may be preceded by “-” or “+” to indicate a negative or positive value, respectively

Examples of valid integers:

```
1221
0
-32
```

Examples of valid floating-point numbers:

```
294.42
-32032.6809e+10
148.00
```

An integer may be used in a floating-point context; it is interpreted as the equivalent floating-point number.

## 8.1.3. Hexadecimal Values

MySQL supports hexadecimal values, written using `X'val'`, `x'val'`, or `0xval` format, where `val` contains hexadecimal digits (`0..9, A..F`). Lettercase of the digits does not matter. For values written using `X'val'` or `x'val'` format, `val` must contain an even number of digits. For values written using `0xval` syntax, values that contain an odd number of digits are treated as having an extra leading 0. For example, `0x0a` and `0xaaa` are interpreted as `0x0a` and `0x0aaa`.

In numeric contexts, hexadecimal values act like integers (64-bit precision). In string contexts, they act like binary strings, where each pair of hex digits is converted to a character:

```
mysql> SELECT X'4D7953514C';
-> 'MySQL'
mysql> SELECT 0x0a+0;
-> 10
mysql> SELECT 0x5061756c;
-> 'Paul'
```

The default type of a hexadecimal value is a string. If you want to ensure that the value is treated as a number, you can use `CAST(... AS UNSIGNED)`:

```
mysql> SELECT 0x41, CAST(0x41 AS UNSIGNED);
-> 'A', 65
```

The `X'hexstring'` syntax is based on standard SQL. The `0x` syntax is based on ODBC. Hexadecimal strings are often used by ODBC to supply values for `BLOB` columns.

You can convert a string or a number to a string in hexadecimal format with the `HEX()` function:

```
mysql> SELECT HEX('cat');
-> '636174'
mysql> SELECT 0x636174;
-> 'cat'
```

## 8.1.4. Boolean Values

The constants `TRUE` and `FALSE` evaluate to 1 and 0, respectively. The constant names can be written in any lettercase.

```
mysql> SELECT TRUE, true, FALSE, false;
```



```
-> 1, 1, 0, 0
```

## 8.1.5. Bit-Field Values

Bit-field values can be written using `b'value'` or `0bvalue` notation. *value* is a binary value written using zeros and ones.

Bit-field notation is convenient for specifying values to be assigned to `BIT` columns:

```
mysql> CREATE TABLE t (b BIT(8));
mysql> INSERT INTO t SET b = b'11111111';
mysql> INSERT INTO t SET b = b'1010';
mysql> INSERT INTO t SET b = b'0101';
```

Bit values are returned as binary values. To display them in printable form, add `0` or use a conversion function such as `BIN()`. High-order `0` bits are not displayed in the converted value.

```
mysql> SELECT b+0, BIN(b+0), OCT(b+0), HEX(b+0) FROM t;
+-----+-----+-----+-----+
| b+0 | BIN(b+0) | OCT(b+0) | HEX(b+0) |
+-----+-----+-----+-----+
| 255 | 11111111 | 377      | FF       |
| 10  | 1010     | 12       | A        |
| 5   | 101      | 5        | 5        |
+-----+-----+-----+-----+
```

Bit values assigned to user variables are treated as binary strings. To assign a bit value as a number to a user variable, use `CAST()` or `+0`:

```
mysql> SET @v1 = 0b1000001;
mysql> SET @v2 = CAST(0b1000001 AS UNSIGNED), @v3 = 0b1000001+0;
mysql> SELECT @v1, @v2, @v3;
+-----+-----+-----+
| @v1 | @v2 | @v3 |
+-----+-----+-----+
| A   | 65  | 65  |
+-----+-----+-----+
```

## 8.1.6. NULL Values

The `NULL` value means “no data.” `NULL` can be written in any lettercase. A synonym is `\N` (case sensitive).

For text file import or export operations performed with `LOAD DATA INFILE` or `SELECT ... INTO OUTFILE`, `NULL` is represented by the `\N` sequence. See [Section 12.2.6, “LOAD DATA INFILE Syntax”](#).

Be aware that the `NULL` value is different from values such as `0` for numeric types or the empty string for string types. For more information, see [Section B.1.5.3, “Problems with NULL Values”](#).

## 8.2. Schema Object Names

Certain objects within MySQL, including database, table, index, column, alias, view, stored procedure, partition, tablespace, and other object names are known as identifiers. This section describes the allowable syntax for identifiers in MySQL. [Section 8.2.2, “Identifier Case Sensitivity”](#), describes which types of identifiers are case sensitive and under what conditions.

An identifier may be quoted or unquoted. If an identifier contains special characters or is a reserved word, you *must* quote it whenever you refer to it. The set of alphanumeric characters from the current character set, “\_”, and “\$” are not special. Reserved words are listed at [Section 8.3, “Reserved Words”](#). (Exception: A reserved word that follows a period in a qualified name must be an identifier, so it need not be quoted.)

The identifier quote character is the backtick (“`”):

```
mysql> SELECT * FROM `select` WHERE `select`.id > 100;
```

If the `ANSI_QUOTES` SQL mode is enabled, it is also allowable to quote identifiers within double quotes:

```
mysql> CREATE TABLE "test" (col INT);
ERROR 1064: You have an error in your SQL syntax...
mysql> SET sql_mode='ANSI_QUOTES';
mysql> CREATE TABLE "test" (col INT);
Query OK, 0 rows affected (0.00 sec)
```

The `ANSI_QUOTES` mode causes the server to interpret double-quoted strings as identifiers. Consequently, when this mode is enabled, string literals must be enclosed within single quotes. They cannot be enclosed within double quotes. The server SQL mode is controlled as described in [Section 5.1.7, “Server SQL Modes”](#).

Identifier quote characters can be included within an identifier if you quote the identifier. If the character to be included within the identifier is the same as that used to quote the identifier itself, then you need to double the character. The following statement creates a table named `a`b`` that contains a column named `c`d``:

```
mysql> CREATE TABLE `a``b` (`c`d` INT);
```

Aliases may be quoted either as identifiers or as strings:

```
mysql> SELECT 1 AS `one`, 2 AS 'two';
+-----+-----+
| one | two |
+-----+-----+
| 1 | 2 |
+-----+-----+
```

Identifiers may begin with a digit but unless quoted may not consist solely of digits.

It is recommended that you do not use names that begin with `Me` or `MeN`, where `M` and `N` are integers. For example, avoid using `1e` as an identifier, because an expression such as `1e+3` is ambiguous. Depending on context, it might be interpreted as the expression `1e + 3` or as the number `1e+3`.

Be careful when using `MD5()` to produce table names because it can produce names in illegal or ambiguous formats such as those just described.

A user variable cannot be used directly in an SQL statement as an identifier or as part of an identifier. See [Section 8.4, “User-Defined Variables”](#), for more information and examples of workarounds.

There are some restrictions on the characters that may appear in identifiers:

- No identifier can contain ASCII NUL (`0x00`).
- Database, table, and column names should not end with space characters.
- Before MySQL 5.1.6, database and table names cannot contain `/`, `\`, `.`, or characters that are not allowed in file names.

As of MySQL 5.1.6, special characters in database and table names are encoded in the corresponding file system names as described in [Section 8.2.3, “Mapping of Identifiers to File Names”](#). If you have databases or tables from an older version of MySQL that contain special characters and for which the underlying directory names or file names have not been updated to use the new encoding, the server displays their names with a prefix of `#mysql150#`. For information about referring to such names or converting them to the newer encoding, see that section.

The following table describes the maximum length for each type of identifier.

Identifier	Maximum Length (characters)
Database	64
Table	64
Column	64
Index	64
Constraint	64
Stored Function or Procedure	64
Trigger	64
View	64
Event	64
Tablespace	64
Log File Group	64
Alias	256

Identifiers are stored using Unicode (UTF-8). This applies to identifiers in table definitions that are stored in `.frm` files and to identifiers stored in the grant tables in the `mysql` database. The sizes of the identifier string columns in the grant tables are measured in characters. You can use multi-byte characters without reducing the number of characters allowed for values stored in these columns, something not true prior to MySQL 4.1. The allowable Unicode characters are those in the Basic Multilingual Plane (BMP). Supplementary characters are not allowed.

## 8.2.1. Identifier Qualifiers

MySQL allows names that consist of a single identifier or multiple identifiers. The components of a multiple-part name must be separated by period (“.”) characters. The initial parts of a multiple-part name act as qualifiers that affect the context within which the final identifier is interpreted.

In MySQL, you can refer to a table column using any of the following forms.

Column Reference	Meaning
<i>col_name</i>	The column <i>col_name</i> from whichever table used in the statement contains a column of that name.
<i>tbl_name.col_name</i>	The column <i>col_name</i> from table <i>tbl_name</i> of the default database.
<i>db_name.tbl_name.col_name</i>	The column <i>col_name</i> from table <i>tbl_name</i> of the database <i>db_name</i> .

If any components of a multiple-part name require quoting, quote them individually rather than quoting the name as a whole. For example, write ``my-table`.`my-column``, not ``my-table.my-column``.

A reserved word that follows a period in a qualified name must be an identifier, so in that context it need not be quoted.

You need not specify a *tbl\_name* or *db\_name.tbl\_name* prefix for a column reference in a statement unless the reference would be ambiguous. Suppose that tables *t1* and *t2* each contain a column *c*, and you retrieve *c* in a `SELECT` statement that uses both *t1* and *t2*. In this case, *c* is ambiguous because it is not unique among the tables used in the statement. You must qualify it with a table name as `t1.c` or `t2.c` to indicate which table you mean. Similarly, to retrieve from a table *t* in database *db1* and from a table *t* in database *db2* in the same statement, you must refer to columns in those tables as `db1.t.col_name` and `db2.t.col_name`.

The syntax `.tbl_name` means the table *tbl\_name* in the default database. This syntax is accepted for ODBC compatibility because some ODBC programs prefix table names with a “.” character.

## 8.2.2. Identifier Case Sensitivity

In MySQL, databases correspond to directories within the data directory. Each table within a database corresponds to at least one file within the database directory (and possibly more, depending on the storage engine). Triggers also correspond to files. Consequently, the case sensitivity of the underlying operating system plays a part in the case sensitivity of database and table names. This means database, table, and trigger names are not case sensitive in Windows, but are case sensitive in most varieties of Unix. One notable exception is Mac OS X, which is Unix-based but uses a default file system type (HFS+) that is not case sensitive. However, Mac OS X also supports UFS volumes, which are case sensitive just as on any Unix. See [Section 1.7.4, “MySQL Extensions to Standard SQL”](#). The `lower_case_table_names` system variable also affects how the server handles identifier case sensitivity, as described later in this section.

### MySQL Enterprise

`lower_case_table_names` is just one of the system variables monitored by the MySQL Enterprise Monitor. For information about subscribing to this service, see <http://www.mysql.com/products/enterprise/advisors.html>.

### Note

Although database, table, and trigger names are not case sensitive on some platforms, you should not refer to one of these using different cases within the same statement. The following statement would not work because it refers to a table both as `my_table` and as `MY_TABLE`:

```
mysql> SELECT * FROM my_table WHERE MY_TABLE.col=1;
```

Column, index, stored routine, and event names are not case sensitive on any platform, nor are column aliases.

However, names of triggers and logfile groups are case sensitive. This differs from standard SQL.

By default, table aliases are case sensitive on Unix, but not so on Windows or Mac OS X. The following statement would not work on Unix, because it refers to the alias both as `a` and as `A`:

```
mysql> SELECT col_name FROM tbl_name AS a
-> WHERE a.col_name = 1 OR A.col_name = 2;
```

However, this same statement is permitted on Windows. To avoid problems caused by such differences, it is best to adopt a consistent convention, such as always creating and referring to databases and tables using lowercase names. This convention is recommended for maximum portability and ease of use.

How table and database names are stored on disk and used in MySQL is affected by the `lower_case_table_names` system variable, which you can set when starting `mysqld`. `lower_case_table_names` can take the values shown in the following table. This variable does *not* affect case sensitivity of trigger identifiers. On Unix, the default value of `lower_case_table_names` is 0. On Windows the default value is 1. On Mac OS X, the default value is 2.

Value	Meaning
0	Table and database names are stored on disk using the lettercase specified in the <code>CREATE TABLE</code> or <code>CREATE DATABASE</code> statement. Name comparisons are case sensitive. Note that if you force this variable to 0 with <code>--lower-case-table-names=0</code> on a case-insensitive file system and access <code>MyISAM</code> table names using different lettercases, index corruption may result.
1	Table names are stored in lowercase on disk and name comparisons are not case sensitive. MySQL converts all table names to lowercase on storage and lookup. This behavior also applies to database names and table aliases.
2	Table and database names are stored on disk using the lettercase specified in the <code>CREATE TABLE</code> or <code>CREATE DATABASE</code> statement, but MySQL converts them to lowercase on lookup. Name comparisons are not case sensitive. This works <i>only</i> on file systems that are not case sensitive! <code>InnoDB</code> table names are stored in lowercase, as for <code>lower_case_table_names=1</code> .

If you are using MySQL on only one platform, you do not normally have to change the `lower_case_table_names` variable from its default value. However, you may encounter difficulties if you want to transfer tables between platforms that differ in file system case sensitivity. For example, on Unix, you can have two different tables named `my_table` and `MY_TABLE`, but on Windows these two names are considered identical. To avoid data transfer problems arising from lettercase of database or table names, you have two options:

- Use `lower_case_table_names=1` on all systems. The main disadvantage with this is that when you use `SHOW TABLES` or `SHOW DATABASES`, you do not see the names in their original lettercase.
- Use `lower_case_table_names=0` on Unix and `lower_case_table_names=2` on Windows. This preserves the lettercase of database and table names. The disadvantage of this is that you must ensure that your statements always refer to your database and table names with the correct lettercase on Windows. If you transfer your statements to Unix, where lettercase is significant, they do not work if the lettercase is incorrect.

**Exception:** If you are using `InnoDB` tables and you are trying to avoid these data transfer problems, you should set `lower_case_table_names` to 1 on all platforms to force names to be converted to lowercase.

If you plan to set the `lower_case_table_names` system variable to 1 on Unix, you must first convert your old database and table names to lowercase before stopping `mysqld` and restarting it with the new variable setting.

Object names may be considered duplicates if their uppercase forms are equal according to a binary collation. That is true for names of cursors, conditions, functions, procedures, savepoints, stored routine parameters, stored program local variables, and plugins. It is not true for names of columns, constraints, databases, partitions, statements prepared with `PREPARE`, tables, triggers, users, and user-defined variables.

### 8.2.3. Mapping of Identifiers to File Names

There is a correspondence between database and table identifiers and names in the file system. For the basic structure, MySQL represents each database as a directory in the data directory, and each table by one or more files in the appropriate database directory. For the table format files (`.FRM`), the data is always stored in this structure and location.

For the data and index files, the exact representation on disk is storage engine specific. These files may be stored in the same location as the `FRM` files, or the information may be stored separate file. `InnoDB` data is stored in the `InnoDB` data files. If you are using tablespaces with `InnoDB`, then the specific tablespace files you create are used instead.

Before MySQL 5.1.6, there are some limitations on the characters that can be used in identifiers for database objects that correspond to file system objects. For example, path name separator characters are disallowed, and `“.”` is disallowed because it begins the extension for table files.

As of MySQL 5.1.6, any character is legal in database or table identifiers except ASCII NUL (`0x00`). MySQL encodes any characters that are problematic in the corresponding file system objects when it creates database directories or table files:

- Basic Latin letters (`a..zA..Z`) and digits (`0..9`) are encoded as is. Consequently, their case sensitivity directly depends on file system features.
- All other national letters from alphabets that have uppercase/lowercase mapping are encoded as follows:

Code range	Pattern	Number	Used	Unused	Blocks

Hex Range	Encoding	Start	End	Count	Character Count	Description
00C0..017F	@][0..4][g..z]	5*20=	100	97	3	Latin1 Supplement + Ext A
0370..03FF	@][5..9][g..z]	5*20=	100	88	12	Greek + Coptic
0400..052F	@][g..z][0..6]	20*7=	140	140	137	Cyrillic
0530..058F	@][g..z][7..8]	20*2=	40	38	2	Armenian
2160..217F	@][g..z][9]	20*1=	20	16	4	Number Forms
0180..02AF	@][g..z][a..k]	28*11=	220	203	17	Latin Ext B + IPA
1E00..0EFF	@][g..z][l..r]	20*7=	140	136	4	Latin Additional Extended
1F00..1FFF	@][g..z][s..z]	20*8=	160	144	16	Greek Extended
....	@][a..f][g..z]	6*20=	120	0	120	RESERVED
24B6..24E9	@][@][a..z]		26	26	0	Enclosed Alphanumerics
FF21..FF5A	@][a..z][@]		26	26	0	Full Width forms

One of the bytes in the sequence encodes lettercase. For example: [LATIN CAPITAL LETTER A WITH GRAVE](#) is encoded as @0G, whereas [LATIN SMALL LETTER A WITH GRAVE](#) is encoded as @0g. Here the third byte (G or g) indicates lettercase. (On a case-insensitive file system, both letters will be treated as the same.)

For some blocks, such as Cyrillic, the second byte determines lettercase. For other blocks, such as Latin1 Supplement, the third byte determines lettercase. If two bytes in the sequence are letters (as in Greek Extended), the leftmost letter character stands for lettercase. All other letter bytes must be in lowercase.

- All non-letter characters, as well as letters from alphabets that do not have uppercase/lowercase mapping (such as Hebrew) are encoded using hexadecimal representation using lowercase letters for hex digits `a..f`:

```
0x003F -> @003f
0xFFFF -> @ffff
```

The hexadecimal values correspond to character values in the `ucs2` double-byte character set.

On Windows, some names such as `nul`, `prn`, and `aux` cannot be used as file names because they are reserved as device names. As of MySQL 5.1.10, these are allowable names in MySQL. They are encoded by appending `@@@` to the name when the server creates the corresponding file or directory. This occurs on all platforms for portability of the corresponding database object between platforms.

If you have databases or tables from a version of MySQL older than 5.1.6 that contain special characters and for which the underlying directory names or file names have not been updated to use the new encoding, the server displays their names with a prefix of `#mysql150#` in the output from `INFORMATION_SCHEMA` tables or `SHOW` statements. For example, if you have a table named `a@b` and its name encoding has not been updated, `SHOW TABLES` displays it like this:

```
mysql> SHOW TABLES;
+-----+
| Tables_in_test |
+-----+
| #mysql150#a@b |
+-----+
```

To refer to such a name for which the encoding has not been updated, you must supply the `#mysql150#` prefix:

```
mysql> SHOW COLUMNS FROM `a@b`;
ERROR 1146 (42S02): Table 'test.a@b' doesn't exist

mysql> SHOW COLUMNS FROM `#mysql150#a@b`;
+-----+
| Field | Type      | Null | Key | Default | Extra |
+-----+
| i     | int(11)  | YES  |     | NULL    |      |
+-----+
```

To update old names to eliminate the need to use the special prefix to refer to them, re-encode them with `mysqlcheck`. The following command updates all names to the new encoding:

```
shell> mysqlcheck --check-upgrade --fix-db-names --fix-table-names --all-databases
```

To check only specific databases or tables, omit `--all-databases` and provide the appropriate database or table arguments. For information about `mysqlcheck` invocation syntax, see [Section 4.5.3, “mysqlcheck — A Table Maintenance Program”](#).

### Note

The `#mysql150#` prefix is intended only to be used internally by the server. You should not create databases or tables with names that use this prefix.

Also, `mysqlcheck` cannot fix names that contain literal instances of the `@` character that is used for encoding special characters. If you have databases or tables that contain this character, use `mysqldump` to dump them before upgrad-

ing to MySQL 5.1.6 or later, and then reload the dump file after upgrading.

## 8.2.4. Function Name Parsing and Resolution

MySQL 5.1 supports built-in (native) functions, user-defined functions (UDFs), and stored functions. This section describes how the server recognizes whether the name of a built-in function is used as a function call or as an identifier, and how the server determines which function to use in cases when functions of different types exist with a given name.

### Built-In Function Name Parsing

The parser uses default rules for parsing names of built-in functions. These rules can be changed by enabling the `IGNORE_SPACE` SQL mode.

When the parser encounters a word that is the name of a built-in function, it must determine whether the name signifies a function call or is instead a non-expression reference to an identifier such as a table or column name. For example, in the following statements, the first reference to `count` is a function call, whereas the second reference is a table name:

```
SELECT COUNT(*) FROM mytable;
CREATE TABLE count (i INT);
```

The parser should recognize the name of a built-in function as indicating a function call only when parsing what is expected to be an expression. That is, in non-expression context, function names are permitted as identifiers.

However, some built-in functions have special parsing or implementation considerations, so the parser uses the following rules by default to distinguish whether their names are being used as function calls or as identifiers in non-expression context:

- To use the name as a function call in an expression, there must be no whitespace between the name and the following “(” parenthesis character.
- Conversely, to use the function name as an identifier, it must not be followed immediately by a parenthesis.

The requirement that function calls be written with no whitespace between the name and the parenthesis applies only to the built-in functions that have special considerations. `COUNT` is one such name. The exact list of function names for which following whitespace determines their interpretation are those listed in the `sql_functions[]` array of the `sql/lex.h` source file. Before MySQL 5.1, these are rather numerous (about 200), so you may find it easiest to treat the no-whitespace requirement as applying to all function calls. In MySQL 5.1, parser improvements reduce to about 30 the number of affected function names.

For functions not listed in the `sql_functions[]` array, whitespace does not matter. They are interpreted as function calls only when used in expression context and may be used freely as identifiers otherwise. `ASCII` is one such name. However, for these non-affected function names, interpretation may vary in expression context: `func_name ()` is interpreted as a built-in function if there is one with the given name; if not, `func_name ()` is interpreted as a user-defined function or stored function if one exists with that name.

The `IGNORE_SPACE` SQL mode can be used to modify how the parser treats function names that are whitespace-sensitive:

- With `IGNORE_SPACE` disabled, the parser interprets the name as a function call when there is no whitespace between the name and the following parenthesis. This occurs even when the function name is used in non-expression context:

```
mysql> CREATE TABLE count(i INT);
ERROR 1064 (42000): You have an error in your SQL syntax ...
near 'count(i INT)'
```

To eliminate the error and cause the name to be treated as an identifier, either use whitespace following the name or write it as a quoted identifier (or both):

```
CREATE TABLE count (i INT);
CREATE TABLE `count` (i INT);
CREATE TABLE `count` (i INT);
```

- With `IGNORE_SPACE` enabled, the parser loosens the requirement that there be no whitespace between the function name and the following parenthesis. This provides more flexibility in writing function calls. For example, either of the following function calls are legal:

```
SELECT COUNT(*) FROM mytable;
SELECT COUNT (*) FROM mytable;
```

However, enabling `IGNORE_SPACE` also has the side effect that the parser treats the affected function names as reserved words (see [Section 8.3, “Reserved Words”](#)). This means that a space following the name no longer signifies its use as an identi-

fier. The name can be used in function calls with or without following whitespace, but causes a syntax error in non-expression context unless it is quoted. For example, with `IGNORE_SPACE` enabled, both of the following statements fail with a syntax error because the parser interprets `count` as a reserved word:

```
CREATE TABLE count(i INT);
CREATE TABLE count (i INT);
```

To use the function name in non-expression context, write it as a quoted identifier:

```
CREATE TABLE `count`(i INT);
CREATE TABLE `count` (i INT);
```

To enable the `IGNORE_SPACE` SQL mode, use this statement:

```
SET sql_mode = 'IGNORE_SPACE';
```

`IGNORE_SPACE` is also enabled by certain other composite modes such as `ANSI` that include it in their value:

```
SET sql_mode = 'ANSI';
```

Check [Section 5.1.7, “Server SQL Modes”](#), to see which composite modes enable `IGNORE_SPACE`.

To minimize the dependency of SQL code on the `IGNORE_SPACE` setting, use these guidelines:

- Avoid creating UDFs or stored functions that have the same name as a built-in function.
- Avoid using function names in non-expression context. For example, these statements use `count` (one of the affected function names affected by `IGNORE_SPACE`), so they fail with or without whitespace following the name if `IGNORE_SPACE` is enabled:

```
CREATE TABLE count(i INT);
CREATE TABLE count (i INT);
```

If you must use a function name in non-expression context, write it as a quoted identifier:

```
CREATE TABLE `count`(i INT);
CREATE TABLE `count` (i INT);
```

The number of function names affected by `IGNORE_SPACE` was reduced significantly in MySQL 5.1.13, from about 200 to about 30. As of MySQL 5.1.13, only the following functions are still affected by the `IGNORE_SPACE` setting.

<code>ADDDATE</code>	<code>BIT_AND</code>	<code>BIT_OR</code>	<code>BIT_XOR</code>
<code>CAST</code>	<code>COUNT</code>	<code>CURDATE</code>	<code>CURTIME</code>
<code>DATE_ADD</code>	<code>DATE_SUB</code>	<code>EXTRACT</code>	<code>GROUP_CONCAT</code>
<code>MAX</code>	<code>MID</code>	<code>MIN</code>	<code>NOW</code>
<code>POSITION</code>	<code>SESSION_USER</code>	<code>STD</code>	<code>STDDEV</code>
<code>STDDEV_POP</code>	<code>STDDEV_SAMP</code>	<code>SUBDATE</code>	<code>SUBSTR</code>
<code>SUBSTRING</code>	<code>SUM</code>	<code>SYSDATE</code>	<code>SYSTEM_USER</code>
<code>TRIM</code>	<code>VARIANCE</code>	<code>VAR_POP</code>	<code>VAR_SAMP</code>

For earlier versions of MySQL, check the contents of the `sql_functions[]` array in the `sql/lex.h` source file to see which functions are affected by `IGNORE_SPACE`.

**Incompatibility warning:** The change in MySQL 5.1.13 that reduces the number of function names affected by `IGNORE_SPACE` improves the consistency of parser operation. However, it also introduces the possibility of incompatibility for old SQL code that relies on the following conditions:

- `IGNORE_SPACE` is disabled.
- The presence or absence of whitespace following a function name is used to distinguish between a built-in function and stored function that have the same name, such as `PI()` versus `PI ()`.



For functions that are no longer affected by `IGNORE_SPACE` as of MySQL 5.1.13, that strategy no longer works. Either of the following approaches can be used if you have code that is subject to the preceding incompatibility:

- If a stored function has a name that conflicts with a built-in function, refer to the stored function with a schema name qualifier, regardless of whether whitespace is present. For example, write `schema_name.PI()` or `schema_name.PI ()`.
- Alternatively, rename the stored function to use a non-conflicting name and change invocations of the function to use the new name.

### Function Name Resolution

The following rules describe how the server resolves references to function names for function creation and invocation:

- Built-in functions and user-defined functions

As of MySQL 5.1.14, an error occurs if you try to create a UDF with the same name as a built-in function. Before 5.1.14, a UDF can be created with the same name as a built-in function but the UDF cannot be invoked because the parser resolves invocations of the function to refer to the built-in function. For example, if you create a UDF named `ABS`, references to `ABS()` invoke the built-in function.

- Built-in functions and stored functions

It is possible to create a stored function with the same name as a built-in function, but to invoke the stored function it is necessary to qualify it with a schema name. For example, if you create a stored function named `PI` in the `test` schema, you invoke it as `test.PI()` because the server resolves `PI()` as a reference to the built-in function. As of 5.1.14, the server creates a warning if the stored function name collides with a built-in function name. The warning can be displayed with `SHOW WARNINGS`.

- User-defined functions and stored functions

User-defined functions and stored functions share the same namespace, so you cannot create a UDF and a stored function with the same name.

The preceding function name resolution rules have implications for upgrading to versions of MySQL that implement new built-in functions:

- If you have already created a user-defined function with a given name and upgrade MySQL to a version that implements a new built-in function with the same name, the UDF becomes inaccessible. To correct this, use `DROP FUNCTION` to drop the UDF, and then use `CREATE FUNCTION` to re-create the UDF with a different non-conflicting name.
- If a new version of MySQL implements a built-in function with the same name as an existing stored function, you have two choices: Rename the stored function to use a non-conflicting name, or change calls to the function so that they use a schema qualifier (that is, use `schema_name.func_name()` syntax).

## 8.3. Reserved Words

Certain words such as `SELECT`, `DELETE`, or `BIGINT` are reserved and require special treatment for use as identifiers such as table and column names. This may also be true for the names of built-in functions.

Reserved words are permitted as identifiers if you quote them as described in [Section 8.2, “Schema Object Names”](#):

```
mysql> CREATE TABLE interval (begin INT, end INT);
ERROR 1064 (42000): You have an error in your SQL syntax ...
near 'interval (begin INT, end INT)'
```

```
mysql> CREATE TABLE `interval` (begin INT, end INT);
Query OK, 0 rows affected (0.01 sec)
```

Exception: A word that follows a period in a qualified name must be an identifier, so it need not be quoted even if it is reserved:

```
mysql> CREATE TABLE mydb.interval (begin INT, end INT);
Query OK, 0 rows affected (0.01 sec)
```

Names of built-in functions are permitted as identifiers but may require care to be used as such. For example, `COUNT` is acceptable as a column name. However, by default, no whitespace is allowed in function invocations between the function name and the fol-



lowing “ ( ” character. This requirement enables the parser to distinguish whether the name is used in a function call or in non-function context. For further detail on recognition of function names, see [Section 8.2.4, “Function Name Parsing and Resolution”](#).

The words in the following table are explicitly reserved in MySQL 5.1. In addition, `_FILENAME` is reserved. At some point, you might upgrade to a higher version, so it is a good idea to have a look at future reserved words, too. You can find these in the manuals that cover higher versions of MySQL. Most of the words in the table are forbidden by standard SQL as column or table names (for example, `GROUP`). A few are reserved because MySQL needs them and uses a `yacc` parser. A reserved word can be used as an identifier if you quote it.

For a more detailed list of reserved words, including differences between versions, see [Reserved Words in MySQL 5.1](#).

ACCESSIBLE	ADD	ALL
ALTER	ANALYZE	AND
AS	ASC	ASENSITIVE
BEFORE	BETWEEN	BIGINT
BINARY	BLOB	BOTH
BY	CALL	CASCADE
CASE	CHANGE	CHAR
CHARACTER	CHECK	COLLATE
COLUMN	CONDITION	CONSTRAINT
CONTINUE	CONVERT	CREATE
CROSS	CURRENT_DATE	CURRENT_TIME
CURRENT_TIMESTAMP	CURRENT_USER	CURSOR
DATABASE	DATABASES	DAY_HOUR
DAY_MICROSECOND	DAY_MINUTE	DAY_SECOND
DEC	DECIMAL	DECLARE
DEFAULT	DELAYED	DELETE
DESC	DESCRIBE	DETERMINISTIC
DISTINCT	DISTINCTROW	DIV
DOUBLE	DROP	DUAL
EACH	ELSE	ELSEIF
ENCLOSED	ESCAPED	EXISTS
EXIT	EXPLAIN	FALSE
FETCH	FLOAT	FLOAT4
FLOAT8	FOR	FORCE
FOREIGN	FROM	FULLTEXT
GRANT	GROUP	HAVING
HIGH_PRIORITY	HOURL_MICROSECOND	HOURL_MINUTE
HOURL_SECOND	IF	IGNORE
IN	INDEX	INFILE
INNER	INOUT	INSENSITIVE
INSERT	INT	INT1
INT2	INT3	INT4
INT8	INTEGER	INTERVAL
INTO	IS	ITERATE
JOIN	KEY	KEYS
KILL	LEADING	LEAVE
LEFT	LIKE	LIMIT
LINEAR	LINES	LOAD
LOCALTIME	LOCALTIMESTAMP	LOCK
LONG	LONGBLOB	LONGTEXT
LOOP	LOW_PRIORITY	MAS- TER_SSL_VERIFY_SERVER_CERT

MATCH	MEDIUMBLOB	MEDIUMINT
MEDIUMTEXT	MIDDLEINT	MINUTE_MICROSECOND
MINUTE_SECOND	MOD	MODIFIES
NATURAL	NOT	NO_WRITE_TO_BINLOG
NULL	NUMERIC	ON
OPTIMIZE	OPTION	OPTIONALLY
OR	ORDER	OUT
OUTER	OUTFILE	PRECISION
PRIMARY	PROCEDURE	PURGE
RANGE	READ	READS
READ_WRITE	REAL	REFERENCES
REGEXP	RELEASE	RENAME
REPEAT	REPLACE	REQUIRE
RESTRICT	RETURN	REVOKE
RIGHT	RLIKE	SCHEMA
SCHEMAS	SECOND_MICROSECOND	SELECT
SENSITIVE	SEPARATOR	SET
SHOW	SMALLINT	SPATIAL
SPECIFIC	SQL	SQLEXCEPTION
SQLSTATE	SQLWARNING	SQL_BIG_RESULT
SQL_CALC_FOUND_ROWS	SQL_SMALL_RESULT	SSL
STARTING	STRAIGHT_JOIN	TABLE
TERMINATED	THEN	TINYBLOB
TINYINT	TINYTEXT	TO
TRAILING	TRIGGER	TRUE
UNDO	UNION	UNIQUE
UNLOCK	UNSIGNED	UPDATE
USAGE	USE	USING
UTC_DATE	UTC_TIME	UTC_TIMESTAMP
VALUES	VARBINARY	VARCHAR
VARCHARACTER	VARYING	WHEN
WHERE	WHILE	WITH
WRITE	XOR	YEAR_MONTH
ZEROFILL		

The following are new reserved words in MySQL 5.1:

ACCESSIBLE	LINEAR	MAS- TER_SSL_VERIFY_SERVER_CERT
RANGE	READ_ONLY	READ_WRITE

MySQL allows some keywords to be used as unquoted identifiers because many people previously used them. Examples are those in the following list:

- ACTION
- BIT
- DATE
- ENUM

- NO
- TEXT
- TIME
- TIMESTAMP

## 8.4. User-Defined Variables

You can store a value in a user-defined variable and then refer to it later. This enables you to pass values from one statement to another. *User-defined variables are connection-specific.* That is, a user variable defined by one client cannot be seen or used by other clients. All variables for a given client connection are automatically freed when that client exits.

User variables are written as `@var_name`, where the variable name `var_name` may consist of alphanumeric characters from the current character set, “.”, “\_”, and “\$”. The default character set is `latin1` (cp1252 West European). This may be changed with the `--character-set-server` option to `mysqld`. See [Section 9.2, “The Character Set Used for Data and Sorting”](#). A user variable name can contain other characters if you quote it as a string or identifier (for example, `@'my-var'`, `@"my-var"`, or `@`my-var``).

User variable names not case sensitive in MySQL 5.0 and up.

One way to set a user-defined variable is by issuing a `SET` statement:

```
SET @var_name = expr [, @var_name = expr] ...
```

For `SET`, either `=` or `:=` can be used as the assignment operator.

You can also assign a value to a user variable in statements other than `SET`. In this case, the assignment operator must be `:=` and not `=` because `=` is treated as a comparison operator in non-`SET` statements:

```
mysql> SET @t1=0, @t2=0, @t3=0;
mysql> SELECT @t1:=(@t2:=1)+@t3:=4,@t1,@t2,@t3;
+-----+-----+-----+-----+
| @t1:=(@t2:=1)+@t3:=4 | @t1 | @t2 | @t3 |
+-----+-----+-----+-----+
|                    5 |    5 |    1 |    4 |
+-----+-----+-----+-----+
```

User variables can be assigned a value from a limited set of data types: integer, decimal, floating-point, binary or nonbinary string, or `NULL` value. Assignment of decimal and real values does not preserve the precision or scale of the value. A value of a type other than one of the allowable types is converted to an allowable type. For example, a value having a temporal or spatial data type is converted to a binary string.

If a user variable is assigned a nonbinary (character) string value, it has the same character set and collation as the string. The coercibility of user variables is implicit. (This is the same coercibility as for table column values.)

Bit values assigned to user variables are treated as binary strings. To assign a bit value as a number to a user variable, use `CAST()` or `+0`:

```
mysql> SET @v1 = b'1000001';
mysql> SET @v2 = CAST(b'1000001' AS UNSIGNED), @v3 = b'1000001'+0;
mysql> SELECT @v1, @v2, @v3;
+-----+-----+-----+
| @v1 | @v2 | @v3 |
+-----+-----+-----+
| A   | 65  | 65  |
+-----+-----+-----+
```

If the value of a user variable is selected in a result set, it is returned to the client as a string.

User variables may be used in contexts where expressions are allowed. This does not currently include contexts that explicitly require a literal value, such as in the `LIMIT` clause of a `SELECT` statement, or the `IGNORE N LINES` clause of a `LOAD DATA` statement.

If you refer to a variable that has not been initialized, it has a value of `NULL` and a type of string.

### Note

In a `SELECT` statement, each expression is evaluated only when sent to the client. This means that in a `HAVING`, `GROUP BY`, or `ORDER BY` clause, you cannot refer to an expression that involves variables that are set in the `SE-`

■ **LECT** list. For example, the following statement does *not* work as expected:

```
mysql> SELECT (@aa:=id) AS a, (@aa+3) AS b FROM tbl_name HAVING b=5;
```

The reference to `b` in the `HAVING` clause refers to an alias for an expression in the `SELECT` list that uses `@aa`. This does not work as expected: `@aa` contains the value of `id` from the previous selected row, not from the current row.

The order of evaluation for user variables is undefined and may change based on the elements contained within a given query. In `SELECT @a, @a := @a+1 ...`, you might think that MySQL will evaluate `@a` first and then do an assignment second, but changing the query (for example, by adding a `GROUP BY`, `HAVING`, or `ORDER BY` clause) may change the order of evaluation.

The general rule is never to assign a value to a user variable in one part of a statement *and* use the same variable in some other part of the same statement. You might get the results you expect, but this is not guaranteed.

Another issue with setting a variable and using it in the same statement is that the default result type of a variable is based on the type of the variable at the start of the statement. The following example illustrates this:

```
mysql> SET @a='test';
mysql> SELECT @a,(@a:=20) FROM tbl_name;
```

For this `SELECT` statement, MySQL reports to the client that column one is a string and converts all accesses of `@a` to strings, even though `@a` is set to a number for the second row. After the `SELECT` statement executes, `@a` is regarded as a number for the next statement.

To avoid problems with this behavior, either do not set and use the same variable within a single statement, or else set the variable to `0`, `0.0`, or `' '` to define its type before you use it.

User variables are intended to provide data values. They cannot be used directly in an SQL statement as an identifier or as part of an identifier, such as in contexts where a table or database name is expected, or as a reserved word such as `SELECT`. This is true even if the variable is quoted, as shown in the following example:

```
mysql> SELECT c1 FROM t;
+----+
| c1 |
+----+
| 0 |
+----+
| 1 |
+----+
2 rows in set (0.00 sec)

mysql> SET @col = "c1";
Query OK, 0 rows affected (0.00 sec)

mysql> SELECT @col FROM t;
+-----+
| @col |
+-----+
| c1 |
+-----+
1 row in set (0.00 sec)

mysql> SELECT `@col` FROM t;
ERROR 1054 (42S22): UNKNOWN COLUMN '@COL' IN 'FIELD LIST'

mysql> SET @col = "`c1`";
Query OK, 0 rows affected (0.00 sec)

mysql> SELECT @col FROM t;
+-----+
| @col |
+-----+
| `c1` |
+-----+
1 row in set (0.00 sec)
```

An exception to this principle that user variables cannot be used to provide identifiers is that if you are constructing a string for use as a prepared statement to be executed later. In this case, user variables can be used to provide any part of the statement. The following example illustrates how this can be done:

```
mysql> SET @c = "c1";
Query OK, 0 rows affected (0.00 sec)

mysql> SET @s = CONCAT("SELECT ", @c, " FROM t");
Query OK, 0 rows affected (0.00 sec)

mysql> PREPARE stmt FROM @s;
Query OK, 0 rows affected (0.04 sec)
Statement prepared

mysql> EXECUTE stmt;
+----+
| c1 |
```

```

+----+
|  0  |
+----+
|  1  |
+----+
2 rows in set (0.00 sec)

mysql> DEALLOCATE PREPARE stmt;
Query OK, 0 rows affected (0.00 sec)

```

See [Section 12.7, “SQL Syntax for Prepared Statements”](#), for more information.

A similar technique can be used in application programs to construct SQL statements using program variables, as shown here using PHP 5:

```

<?php
    $mysqli = new mysqli("localhost", "user", "pass", "test");

    if( mysqli_connect_errno() )
        die("Connection failed: %s\n", mysqli_connect_error());

    $col = "c1";

    $query = "SELECT $col FROM t";

    $result = $mysqli->query($query);

    while($row = $result->fetch_assoc())
    {
        echo "<p>" . $row["$col"] . "</p>\n";
    }

    $result->close();

    $mysqli->close();
?>

```

Assembling an SQL statement in this fashion is sometimes known as “Dynamic SQL”.

## 8.5. Comment Syntax

MySQL Server supports three comment styles:

- From a “#” character to the end of the line.
- From a “-- ” sequence to the end of the line. In MySQL, the “-- ” (double-dash) comment style requires the second dash to be followed by at least one whitespace or control character (such as a space, tab, newline, and so on). This syntax differs slightly from standard SQL comment syntax, as discussed in [Section 1.7.5.6, “-- as the Start of a Comment”](#).
- From a /\* sequence to the following \*/ sequence, as in the C programming language. This syntax allows a comment to extend over multiple lines because the beginning and closing sequences need not be on the same line.

The following example demonstrates all three comment styles:

```

mysql> SELECT 1+1;      # This comment continues to the end of line
mysql> SELECT 1+1;    -- This comment continues to the end of line
mysql> SELECT 1 /* this is an in-line comment */ + 1;
mysql> SELECT 1+
/*
this is a
multiple-line comment
*/
1;

```

Nested comments are not supported.

MySQL Server supports some variants of C-style comments. These enable you to write code that includes MySQL extensions, but is still portable, by using comments of the following form:

```

/*! MySQL-specific code */

```

In this case, MySQL Server parses and executes the code within the comment as it would any other SQL statement, but other SQL servers will ignore the extensions. For example, MySQL Server recognizes the [STRAIGHT\\_JOIN](#) keyword in the following statement, but other servers will not:

```

SELECT /*! STRAIGHT_JOIN */ col1 FROM table1,table2 WHERE ...

```

If you add a version number after the “!” character, the syntax within the comment is executed only if the MySQL version is greater than or equal to the specified version number. The `TEMPORARY` keyword in the following comment is executed only by servers from MySQL 3.23.02 or higher:

```
CREATE /*!32302 TEMPORARY */ TABLE t (a INT);
```

The comment syntax just described applies to how the `mysqld` server parses SQL statements. The `mysql` client program also performs some parsing of statements before sending them to the server. (It does this to determine statement boundaries within a multiple-statement input line.)

The use of short-form `mysql` commands such as `\C` within multi-line `/* ... */` comments is not supported.

---

# Chapter 9. Internationalization and Localization

This chapter covers issues of internationalization (MySQL's capabilities for adapting to local use) and localization (selecting particular local conventions):

- MySQL support for character sets in SQL statements.
- How to configure the server to support different character sets.
- Selecting the language for error messages.
- How to set the server's time zone and enable per-connection time zone support.
- Selecting the locale for day and month names.

## 9.1. Character Set Support

MySQL includes character set support that enables you to store data using a variety of character sets and perform comparisons according to a variety of collations. You can specify character sets at the server, database, table, and column level. MySQL supports the use of character sets for the [MyISAM](#), [MEMORY](#), [NDBCLUSTER](#), and [InnoDB](#) storage engines.

This chapter discusses the following topics:

- What are character sets and collations?
- The multiple-level default system for character set assignment
- Syntax for specifying character sets and collations
- Affected functions and operations
- Unicode support
- The character sets and collations that are available, with notes

Character set issues affect not only data storage, but also communication between client programs and the MySQL server. If you want the client program to communicate with the server using a character set different from the default, you'll need to indicate which one. For example, to use the `utf8` Unicode character set, issue this statement after connecting to the server:

```
SET NAMES 'utf8';
```

For more information about configuring character sets for application use and character set-related issues in client/server communication, see [Section 9.1.5, "Configuring the Character Set and Collation for Applications"](#), and [Section 9.1.4, "Connection Character Sets and Collations"](#).

### 9.1.1. Character Sets and Collations in General

A *character set* is a set of symbols and encodings. A *collation* is a set of rules for comparing characters in a character set. Let's make the distinction clear with an example of an imaginary character set.

Suppose that we have an alphabet with four letters: "A", "B", "a", "b". We give each letter a number: "A" = 0, "B" = 1, "a" = 2, "b" = 3. The letter "A" is a symbol, the number 0 is the **encoding** for "A", and the combination of all four letters and their encodings is a **character set**.

Suppose that we want to compare two string values, "A" and "B". The simplest way to do this is to look at the encodings: 0 for "A" and 1 for "B". Because 0 is less than 1, we say "A" is less than "B". What we've just done is apply a collation to our character set. The collation is a set of rules (only one rule in this case): "compare the encodings." We call this simplest of all possible collations a *binary* collation.

But what if we want to say that the lowercase and uppercase letters are equivalent? Then we would have at least two rules: (1) treat the lowercase letters "a" and "b" as equivalent to "A" and "B"; (2) then compare the encodings. We call this a *case-insensitive* collation. It is a little more complex than a binary collation.

In real life, most character sets have many characters: not just "A" and "B" but whole alphabets, sometimes multiple alphabets or eastern writing systems with thousands of characters, along with many special symbols and punctuation marks. Also in real life,

most collations have many rules, not just for whether to distinguish lettercase, but also for whether to distinguish accents (an “accent” is a mark attached to a character as in German “ö”), and for multiple-character mappings (such as the rule that “ö” = “oe” in one of the two German collations).

MySQL can do these things for you:

- Store strings using a variety of character sets
- Compare strings using a variety of collations
- Mix strings with different character sets or collations in the same server, the same database, or even the same table
- Allow specification of character set and collation at any level

In these respects, MySQL is far ahead of most other database management systems. However, to use these features effectively, you need to know what character sets and collations are available, how to change the defaults, and how they affect the behavior of string operators and functions.

## 9.1.2. Character Sets and Collations in MySQL

The MySQL server can support multiple character sets. To list the available character sets, use the `SHOW CHARACTER SET` statement. A partial listing follows. For more complete information, see [Section 9.1.12, “Character Sets and Collations That MySQL Supports”](#).

```
mysql> SHOW CHARACTER SET;
```

Charset	Description	Default collation	Maxlen
big5	Big5 Traditional Chinese	big5_chinese_ci	2
dec8	DEC West European	dec8_swedish_ci	1
cp850	DOS West European	cp850_general_ci	1
hp8	HP West European	hp8_english_ci	1
koi8r	KOI8-R Relcom Russian	koi8r_general_ci	1
latin1	cp1252 West European	latin1_swedish_ci	1
latin2	ISO 8859-2 Central European	latin2_general_ci	1
swe7	7bit Swedish	swe7_swedish_ci	1
ascii	US ASCII	ascii_general_ci	1
ujis	EUC-JP Japanese	ujis_japanese_ci	3
sjis	Shift-JIS Japanese	sjis_japanese_ci	2
hebrew	ISO 8859-8 Hebrew	hebrew_general_ci	1
tis620	TIS620 Thai	tis620_thai_ci	1
euckr	EUC-KR Korean	euckr_korean_ci	2
koi8u	KOI8-U Ukrainian	koi8u_general_ci	1
gb2312	GB2312 Simplified Chinese	gb2312_chinese_ci	2
greek	ISO 8859-7 Greek	greek_general_ci	1
cp1250	Windows Central European	cp1250_general_ci	1
gbk	GBK Simplified Chinese	gbk_chinese_ci	2
latin5	ISO 8859-9 Turkish	latin5_turkish_ci	1
...			

Any given character set always has at least one collation. It may have several collations. To list the collations for a character set, use the `SHOW COLLATION` statement. For example, to see the collations for the `latin1` (cp1252 West European) character set, use this statement to find those collation names that begin with `latin1`:

```
mysql> SHOW COLLATION LIKE 'latin1%';
```

Collation	Charset	Id	Default	Compiled	Sortlen
latin1_german1_ci	latin1	5			0
latin1_swedish_ci	latin1	8	Yes	Yes	1
latin1_danish_ci	latin1	15			0
latin1_german2_ci	latin1	31		Yes	2
latin1_bin	latin1	47		Yes	1
latin1_general_ci	latin1	48			0
latin1_general_cs	latin1	49			0
latin1_spanish_ci	latin1	94			0

The `latin1` collations have the following meanings.

Collation	Meaning
<code>latin1_german1_ci</code>	German DIN-1
<code>latin1_swedish_ci</code>	Swedish/Finnish
<code>latin1_danish_ci</code>	Danish/Norwegian
<code>latin1_german2_ci</code>	German DIN-2
<code>latin1_bin</code>	Binary according to <code>latin1</code> encoding



<code>latin1_general_ci</code>	Multilingual (Western European)
<code>latin1_general_cs</code>	Multilingual (ISO Western European), case sensitive
<code>latin1_spanish_ci</code>	Modern Spanish

Collations have these general characteristics:

- Two different character sets cannot have the same collation.
- Each character set has one collation that is the *default collation*. For example, the default collation for `latin1` is `latin1_swedish_ci`. The output for `SHOW CHARACTER SET` indicates which collation is the default for each displayed character set.
- There is a convention for collation names: They start with the name of the character set with which they are associated, they usually include a language name, and they end with `_ci` (case insensitive), `_cs` (case sensitive), or `_bin` (binary).

In cases where a character set has multiple collations, it might not be clear which collation is most suitable for a given application. To avoid choosing the wrong collation, it can be helpful to perform some comparisons with representative data values to make sure that a given collation sorts values the way you expect.

[Collation-Charts.Org](http://Collation-Charts.Org) is a useful site for information that shows how one collation compares to another.

### 9.1.3. Specifying Character Sets and Collations

There are default settings for character sets and collations at four levels: server, database, table, and column. The description in the following sections may appear complex, but it has been found in practice that multiple-level defaulting leads to natural and obvious results.

`CHARACTER SET` is used in clauses that specify a character set. `CHARSET` can be used as a synonym for `CHARACTER SET`.

Character set issues affect not only data storage, but also communication between client programs and the MySQL server. If you want the client program to communicate with the server using a character set different from the default, you'll need to indicate which one. For example, to use the `utf8` Unicode character set, issue this statement after connecting to the server:

```
SET NAMES 'utf8';
```

For more information about character set-related issues in client/server communication, see [Section 9.1.4, “Connection Character Sets and Collations”](#).

#### 9.1.3.1. Server Character Set and Collation

MySQL Server has a server character set and a server collation. These can be set at server startup on the command line or in an option file and changed at runtime.

Initially, the server character set and collation depend on the options that you use when you start `mysqld`. You can use `--character-set-server` for the character set. Along with it, you can add `--collation-server` for the collation. If you don't specify a character set, that is the same as saying `--character-set-server=latin1`. If you specify only a character set (for example, `latin1`) but not a collation, that is the same as saying `--character-set-server=latin1 --collation-server=latin1_swedish_ci` because `latin1_swedish_ci` is the default collation for `latin1`. Therefore, the following three commands all have the same effect:

```
shell> mysql
shell> mysql --character-set-server=latin1
shell> mysql --character-set-server=latin1 \
    --collation-server=latin1_swedish_ci
```

One way to change the settings is by recompiling. If you want to change the default server character set and collation when building from sources, use: `--with-charset` and `--with-collation` as arguments for `configure`. For example:

```
shell> ./configure --with-charset=latin1
```

Or:

```
shell> ./configure --with-charset=latin1 \
    --with-collation=latin1_german1_ci
```

Both `mysqld` and `configure` verify that the character set/collation combination is valid. If not, each program displays an error message and terminates.

The server character set and collation are used as default values if the database character set and collation are not specified in `CREATE DATABASE` statements. They have no other purpose.

The current server character set and collation can be determined from the values of the `character_set_server` and `collation_server` system variables. These variables can be changed at runtime.

### 9.1.3.2. Database Character Set and Collation

Every database has a database character set and a database collation. The `CREATE DATABASE` and `ALTER DATABASE` statements have optional clauses for specifying the database character set and collation:

```
CREATE DATABASE db_name
  [[DEFAULT] CHARACTER SET charset_name]
  [[DEFAULT] COLLATE collation_name]

ALTER DATABASE db_name
  [[DEFAULT] CHARACTER SET charset_name]
  [[DEFAULT] COLLATE collation_name]
```

The keyword `SCHEMA` can be used instead of `DATABASE`.

All database options are stored in a text file named `db.opt` that can be found in the database directory.

The `CHARACTER SET` and `COLLATE` clauses make it possible to create databases with different character sets and collations on the same MySQL server.

Example:

```
CREATE DATABASE db_name CHARACTER SET latin1 COLLATE latin1_swedish_ci;
```

MySQL chooses the database character set and database collation in the following manner:

- If both `CHARACTER SET X` and `COLLATE Y` are specified, character set `X` and collation `Y` are used.
- If `CHARACTER SET X` is specified without `COLLATE`, character set `X` and its default collation are used. To see the default collation for each character set, use the `SHOW COLLATION` statement.
- If `COLLATE Y` is specified without `CHARACTER SET`, the character set associated with `Y` and collation `Y` are used.
- Otherwise, the server character set and server collation are used.

The database character set and collation are used as default values for table definitions if the table character set and collation are not specified in `CREATE TABLE` statements. The database character set also is used by `LOAD DATA INFILE`. The character set and collation have no other purposes.

The character set and collation for the default database can be determined from the values of the `character_set_database` and `collation_database` system variables. The server sets these variables whenever the default database changes. If there is no default database, the variables have the same value as the corresponding server-level system variables, `character_set_server` and `collation_server`.

### 9.1.3.3. Table Character Set and Collation

Every table has a table character set and a table collation. The `CREATE TABLE` and `ALTER TABLE` statements have optional clauses for specifying the table character set and collation:

```
CREATE TABLE tbl_name (column_list)
  [[DEFAULT] CHARACTER SET charset_name]
  [COLLATE collation_name]

ALTER TABLE tbl_name
  [[DEFAULT] CHARACTER SET charset_name]
  [COLLATE collation_name]
```

Example:

```
CREATE TABLE t1 ( ... )
CHARACTER SET latin1 COLLATE latin1_danish_ci;
```

MySQL chooses the table character set and collation in the following manner:

- If both `CHARACTER SET X` and `COLLATE Y` are specified, character set `X` and collation `Y` are used.
- If `CHARACTER SET X` is specified without `COLLATE`, character set `X` and its default collation are used. To see the default collation for each character set, use the `SHOW COLLATION` statement.
- If `COLLATE Y` is specified without `CHARACTER SET`, the character set associated with `Y` and collation `Y` are used.
- Otherwise, the database character set and collation are used.

The table character set and collation are used as default values for column definitions if the column character set and collation are not specified in individual column definitions. The table character set and collation are MySQL extensions; there are no such things in standard SQL.

### 9.1.3.4. Column Character Set and Collation

Every “character” column (that is, a column of type `CHAR`, `VARCHAR`, or `TEXT`) has a column character set and a column collation. Column definition syntax for `CREATE TABLE` and `ALTER TABLE` has optional clauses for specifying the column character set and collation:

```
col_name {CHAR | VARCHAR | TEXT} (col_length)
[CHARACTER SET charset_name]
[COLLATE collation_name]
```

These clauses can also be used for `ENUM` and `SET` columns:

```
col_name {ENUM | SET} (val_list)
[CHARACTER SET charset_name]
[COLLATE collation_name]
```

Examples:

```
CREATE TABLE t1
(
  col1 VARCHAR(5)
  CHARACTER SET latin1
  COLLATE latin1_german1_ci
);
ALTER TABLE t1 MODIFY
col1 VARCHAR(5)
CHARACTER SET latin1
COLLATE latin1_swedish_ci;
```

MySQL chooses the column character set and collation in the following manner:

- If both `CHARACTER SET X` and `COLLATE Y` are specified, character set `X` and collation `Y` are used.

```
CREATE TABLE t1
(
  col1 CHAR(10) CHARACTER SET utf8 COLLATE utf8_unicode_ci
) CHARACTER SET latin1 COLLATE latin1_bin;
```

The character set and collation are specified for the column, so they are used. The column has character set `utf8` and collation `utf8_unicode_ci`.

- If `CHARACTER SET X` is specified without `COLLATE`, character set `X` and its default collation are used.

```
CREATE TABLE t1
(
  col1 CHAR(10) CHARACTER SET utf8
) CHARACTER SET latin1 COLLATE latin1_bin;
```

The character set is specified for the column, but the collation is not. The column has character set `utf8` and the default collation for `utf8`, which is `utf8_general_ci`. To see the default collation for each character set, use the `SHOW COLLATION` statement.

- If `COLLATE Y` is specified without `CHARACTER SET`, the character set associated with `Y` and collation `Y` are used.

```
CREATE TABLE t1
(
```

```
coll CHAR(10) COLLATE utf8_polish_ci
) CHARACTER SET latin1 COLLATE latin1_bin;
```

The collation is specified for the column, but the character set is not. The column has collation `utf8_polish_ci` and the character set is the one associated with the collation, which is `utf8`.

- Otherwise, the table character set and collation are used.

```
CREATE TABLE t1
(
  coll CHAR(10)
) CHARACTER SET latin1 COLLATE latin1_bin;
```

Neither the character set nor collation are specified for the column, so the table defaults are used. The column has character set `latin1` and collation `latin1_bin`.

The `CHARACTER SET` and `COLLATE` clauses are standard SQL.

If you use `ALTER TABLE` to convert a column from one character set to another, MySQL attempts to map the data values, but if the character sets are incompatible, there may be data loss.

### 9.1.3.5. Character String Literal Character Set and Collation

Every character string literal has a character set and a collation.

A character string literal may have an optional character set introducer and `COLLATE` clause:

```
[_charset_name]'string' [COLLATE collation_name]
```

Examples:

```
SELECT 'string';
SELECT _latin1'string';
SELECT _latin1'string' COLLATE latin1_danish_ci;
```

For the simple statement `SELECT 'string'`, the string has the character set and collation defined by the `character_set_connection` and `collation_connection` system variables.

The `_charset_name` expression is formally called an *introducer*. It tells the parser, “the string that is about to follow uses character set *X*.” Because this has confused people in the past, we emphasize that an introducer does not change the string to the introducer character set like `CONVERT()` would do. It does not change the string's value, although padding may occur. The introducer is just a signal. An introducer is also legal before standard hex literal and numeric hex literal notation (`x'literal'` and `0xn`), or before bit-field literal notation (`b'literal'` and `0bn`).

Examples:

```
SELECT _latin1 x'AABBCC';
SELECT _latin1 0xAABBCC;
SELECT _latin1 b'1100011';
SELECT _latin1 0b1100011;
```

MySQL determines a literal's character set and collation in the following manner:

- If both `_X` and `COLLATE Y` are specified, character set *X* and collation *Y* are used.
- If `_X` is specified but `COLLATE` is not specified, character set *X* and its default collation are used. To see the default collation for each character set, use the `SHOW COLLATION` statement.
- Otherwise, the character set and collation given by the `character_set_connection` and `collation_connection` system variables are used.

Examples:

- A string with `latin1` character set and `latin1_german1_ci` collation:

```
SELECT _latin1'Müller' COLLATE latin1_german1_ci;
```

- A string with `latin1` character set and its default collation (that is, `latin1_swedish_ci`):

```
SELECT _latin1'Müller';
```

- A string with the connection default character set and collation:

```
SELECT 'Müller';
```

Character set introducers and the `COLLATE` clause are implemented according to standard SQL specifications.

An introducer indicates the character set for the following string, but does not change now how the parser performs escape processing within the string. Escapes are always interpreted by the parser according to the character set given by `character_set_connection`.

The following examples show that escape processing occurs using `character_set_connection` even in the presence of an introducer. The examples use `SET NAMES` (which changes `character_set_connection`, as discussed in [Section 9.1.4, “Connection Character Sets and Collations”](#)), and display the resulting strings using the `HEX()` function so that the exact string contents can be seen.

Example 1:

```
mysql> SET NAMES latin1;
Query OK, 0 rows affected (0.01 sec)

mysql> SELECT HEX('\n'), HEX(_sjis'\n');
+-----+-----+
| HEX('\n') | HEX(_sjis'\n') |
+-----+-----+
| E00A      | E00A            |
+-----+-----+
1 row in set (0.00 sec)
```

Here, “`à`” (hex value `E0`) is followed by “`\n`”, the escape sequence for newline. The escape sequence is interpreted using the `character_set_connection` value of `latin1` to produce a literal newline (hex value `0A`). This happens even for the second string. That is, the introducer of `_sjis` does not affect the parser's escape processing.

Example 2:

```
mysql> SET NAMES sjis;
Query OK, 0 rows affected (0.00 sec)

mysql> SELECT HEX('\n'), HEX(_latin1'\n');
+-----+-----+
| HEX('\n') | HEX(_latin1'\n') |
+-----+-----+
| E05C6E    | E05C6E           |
+-----+-----+
1 row in set (0.04 sec)
```

Here, `character_set_connection` is `sjis`, a character set in which the sequence of “`à`” followed by “`\`” (hex values `05` and `5C`) is a valid multi-byte character. Hence, the first two bytes of the string are interpreted as a single `sjis` character, and the “`\`” is not interpreted as an escape character. The following “`n`” (hex value `6E`) is not interpreted as part of an escape sequence. This is true even for the second string; the introducer of `_latin1` does not affect escape processing.

### 9.1.3.6. National Character Set

Standard SQL defines `NCHAR` or `NATIONAL CHAR` as a way to indicate that a `CHAR` column should use some predefined character set. MySQL 5.1 uses `utf8` as this predefined character set. For example, these data type declarations are equivalent:

```
CHAR(10) CHARACTER SET utf8
NATIONAL CHARACTER(10)
NCHAR(10)
```

As are these:

```
VARCHAR(10) CHARACTER SET utf8
NATIONAL VARCHAR(10)
NCHAR VARCHAR(10)
NATIONAL CHARACTER VARYING(10)
NATIONAL CHAR VARYING(10)
```

You can use `N'literal'` (or `n'literal'`) to create a string in the national character set. These statements are equivalent:

```
SELECT N'some text';
```

```
SELECT n'some text';
SELECT _utf8'some text';
```

For information on upgrading character sets to MySQL 5.1 from versions prior to 4.1, see the *MySQL 3.23, 4.0, 4.1 Reference Manual*.

### 9.1.3.7. Examples of Character Set and Collation Assignment

The following examples show how MySQL determines default character set and collation values.

#### Example 1: Table and Column Definition

```
CREATE TABLE t1
(
  c1 CHAR(10) CHARACTER SET latin1 COLLATE latin1_german1_ci
) DEFAULT CHARACTER SET latin2 COLLATE latin2_bin;
```

Here we have a column with a `latin1` character set and a `latin1_german1_ci` collation. The definition is explicit, so that is straightforward. Notice that there is no problem with storing a `latin1` column in a `latin2` table.

#### Example 2: Table and Column Definition

```
CREATE TABLE t1
(
  c1 CHAR(10) CHARACTER SET latin1
) DEFAULT CHARACTER SET latin1 COLLATE latin1_danish_ci;
```

This time we have a column with a `latin1` character set and a default collation. Although it might seem natural, the default collation is not taken from the table level. Instead, because the default collation for `latin1` is always `latin1_swedish_ci`, column `c1` has a collation of `latin1_swedish_ci` (not `latin1_danish_ci`).

#### Example 3: Table and Column Definition

```
CREATE TABLE t1
(
  c1 CHAR(10)
) DEFAULT CHARACTER SET latin1 COLLATE latin1_danish_ci;
```

We have a column with a default character set and a default collation. In this circumstance, MySQL checks the table level to determine the column character set and collation. Consequently, the character set for column `c1` is `latin1` and its collation is `latin1_danish_ci`.

#### Example 4: Database, Table, and Column Definition

```
CREATE DATABASE d1
  DEFAULT CHARACTER SET latin2 COLLATE latin2_czech_ci;
USE d1;
CREATE TABLE t1
(
  c1 CHAR(10)
);
```

We create a column without specifying its character set and collation. We're also not specifying a character set and a collation at the table level. In this circumstance, MySQL checks the database level to determine the table settings, which thereafter become the column settings.) Consequently, the character set for column `c1` is `latin2` and its collation is `latin2_czech_ci`.

### 9.1.3.8. Compatibility with Other DBMSs

For MaxDB compatibility these two statements are the same:

```
CREATE TABLE t1 (f1 CHAR(N) UNICODE);
CREATE TABLE t1 (f1 CHAR(N) CHARACTER SET ucs2);
```

## 9.1.4. Connection Character Sets and Collations

Several character set and collation system variables relate to a client's interaction with the server. Some of these have been mentioned in earlier sections:

- The server character set and collation can be determined from the values of the `character_set_server` and `collation_server` system variables.

- The character set and collation of the default database can be determined from the values of the `character_set_database` and `collation_database` system variables.

Additional character set and collation system variables are involved in handling traffic for the connection between a client and the server. Every client has connection-related character set and collation system variables.

Consider what a “connection” is: It is what you make when you connect to the server. The client sends SQL statements, such as queries, over the connection to the server. The server sends responses, such as result sets, over the connection back to the client. This leads to several questions about character set and collation handling for client connections, each of which can be answered in terms of system variables:

- What character set is the statement in when it leaves the client?

The server takes the `character_set_client` system variable to be the character set in which statements are sent by the client.

- What character set should the server translate a statement to after receiving it?

For this, the server uses the `character_set_connection` and `collation_connection` system variables. It converts statements sent by the client from `character_set_client` to `character_set_connection` (except for string literals that have an introducer such as `_latin1` or `_utf8`). `collation_connection` is important for comparisons of literal strings. For comparisons of strings with column values, `collation_connection` does not matter because columns have their own collation, which has a higher collation precedence.

- What character set should the server translate to before shipping result sets or error messages back to the client?

The `character_set_results` system variable indicates the character set in which the server returns query results to the client. This includes result data such as column values, and result metadata such as column names.

You can fine-tune the settings for these variables, or you can depend on the defaults (in which case, you can skip the rest of this section). If you do not use the defaults, you must change the character settings *for each connection to the server*.

There are two statements that affect the connection character sets:

```
SET NAMES 'charset_name'
SET CHARACTER SET charset_name
```

`SET NAMES` indicates what character set the client will use to send SQL statements to the server. Thus, `SET NAMES 'cp1251'` tells the server “future incoming messages from this client are in character set `cp1251`.” It also specifies the character set that the server should use for sending results back to the client. (For example, it indicates what character set to use for column values if you use a `SELECT` statement.)

A `SET NAMES 'x'` statement is equivalent to these three statements:

```
SET character_set_client = x;
SET character_set_results = x;
SET character_set_connection = x;
```

Setting `character_set_connection` to `x` also sets `collation_connection` to the default collation for `x`. It is not necessary to set that collation explicitly. To specify a particular collation for the character sets, use the optional `COLLATE` clause:

```
SET NAMES 'charset_name' COLLATE 'collation_name'
```

`SET CHARACTER SET` is similar to `SET NAMES` but sets `character_set_connection` and `collation_connection` to `character_set_database` and `collation_database`. A `SET CHARACTER SET x` statement is equivalent to these three statements:

```
SET character_set_client = x;
SET character_set_results = x;
SET collation_connection = @@collation_database;
```

Setting `collation_connection` also sets `character_set_connection` to the character set associated with the collation (equivalent to executing `SET character_set_connection = @@character_set_database`). It is not necessary to set `character_set_connection` explicitly.

When a client connects, it sends to the server the name of the character set that it wants to use. The server uses the name to set the `character_set_client`, `character_set_results`, and `character_set_connection` system variables. In effect, the server performs a `SET NAMES` operation using the character set name.

With the `mysql` client, it is not necessary to execute `SET NAMES` every time you start up if you want to use a character set different from the default. You can add the `--default-character-set` option setting to your `mysql` statement line, or in your option file. For example, the following option file setting changes the three character set variables set to `koi8r` each time you invoke `mysql`:

```
[mysql]
default-character-set=koi8r
```

If you are using the `mysql` client with auto-reconnect enabled (which is not recommended), it is preferable to use the `charset` command rather than `SET NAMES`. For example:

```
mysql> charset utf8
Charset changed
```

The `charset` command issues a `SET NAMES` statement, and also changes the default character set that is used if `mysql` reconnects after the connection has dropped.

Example: Suppose that `column1` is defined as `CHAR(5) CHARACTER SET latin2`. If you do not say `SET NAMES` or `SET CHARACTER SET`, then for `SELECT column1 FROM t`, the server sends back all the values for `column1` using the character set that the client specified when it connected. On the other hand, if you say `SET NAMES 'latin1'` or `SET CHARACTER SET latin1` before issuing the `SELECT` statement, the server converts the `latin2` values to `latin1` just before sending results back. Conversion may be lossy if there are characters that are not in both character sets.

If you do not want the server to perform any conversion of result sets, set `character_set_results` to `NULL` or `binary`:

```
SET character_set_results = NULL;
```

### Note

`ucs2` cannot be used as a client character set, which means that it does not work for `SET NAMES` or `SET CHARACTER SET`.

To see the values of the character set and collation system variables that apply to your connection, use these statements:

```
SHOW VARIABLES LIKE 'character_set%';
SHOW VARIABLES LIKE 'collation%';
```

You must also consider the environment within which your MySQL applications execute. See [Section 9.1.5, “Configuring the Character Set and Collation for Applications”](#).

## 9.1.5. Configuring the Character Set and Collation for Applications

For applications that store data using the default MySQL character set and collation (`latin1`, `latin1_swedish_ci`), no special configuration should be needed. If applications require data storage using a different character set or collation, you can configure character set information several ways:

- Specify character settings per database. For example, applications that use one database might require `utf8`, whereas applications that use another database might require `sjis`.
- Specify character settings at server startup. This causes the server to use the given settings for all applications that do not make other arrangements.
- Specify character settings at configuration time, if you build MySQL from source. This causes the server to use the given settings for all applications, without having to specify them at server startup.

When different applications require different character settings, the per-database technique provides a good deal of flexibility. If most or all applications use the same character set, specifying character settings at server startup or configuration time may be most convenient.

For the per-database or server-startup techniques, the settings control the character set for data storage. Applications must also tell the server which character set to use for client/server communications, as described in the following instructions.

The examples shown here assume use of the `utf8` character set and `utf8_general_ci` collation.

**Specify character settings per database.** To create a database such that its tables will use a given default character set and collation for data storage, use a `CREATE DATABASE` statement like this:

```
CREATE DATABASE mydb
```



```
DEFAULT CHARACTER SET utf8
DEFAULT COLLATE utf8_general_ci;
```

Tables created in the database will use `utf8` and `utf8_general_ci` by default for any character columns.

Applications that use the database should also configure their connection to the server each time they connect. This can be done by executing a `SET NAMES 'utf8'` statement after connecting. The statement can be used regardless of connection method: The `mysql` client, PHP scripts, and so forth.

In some cases, it may be possible to configure the connection to use the desired character set some other way. For example, for connections made using `mysql`, you can specify the `--default-character-set=utf8` command-line option to achieve the same effect as `SET NAMES 'utf8'`.

For more information about configuring client connections, see [Section 9.1.4, “Connection Character Sets and Collations”](#).

**Specify character settings at server startup.** To select a character set and collation at server startup, use the `--character-set-server` and `--collation-server` options. For example, to specify the options in an option file, include these lines:

```
[mysqld]
character-set-server=utf8
collation-server=utf8_general_ci
```

These settings apply server-wide and apply as the defaults for databases created by any application, and for tables created in those databases.

It is still necessary for applications to configure their connection using `SET NAMES` or equivalent after they connect, as described previously. You might be tempted to start the server with the `--init_connect="SET NAMES 'utf8' "` option to cause `SET NAMES` to be executed automatically for each client that connects. However, this will yield inconsistent results because the `init_connect` value is not executed for users who have the `SUPER` privilege.

**Specify character settings at MySQL configuration time.** To select a character set and collation when you configure and build MySQL from source, use the `--with-charset` and `--with-collation` options:

```
shell> ./configure --with-charset=utf8 --with-collation=utf8_general_ci
```

The resulting server uses `utf8` and `utf8_general_ci` as the default for databases and tables and for client connections. It is unnecessary to use `--character-set-server` and `--collation-server` at server startup. It is also unnecessary for applications to configure their connection using `SET NAMES` or equivalent after they connect to the server.

Regardless of how you configure the MySQL character set for application use, you must also consider the environment within which those applications execute. If you will send statements using UTF-8 text taken from a file that you create in an editor, you should edit the file with the locale of your environment set to UTF-8 so that the file's encoding is correct and so that the operating system handles it correctly. If you use the `mysql` client from within a terminal window, the window must be configured to use UTF-8 or characters may not display properly. For a script that executes in a Web environment, the script must handle character encoding properly for its interaction with the MySQL server, and it must generate pages that correctly indicate the encoding so that browsers know how to display the content of the pages. For example, you can include this `<meta>` tag within your `<head>` element:

```
<meta http-equiv="Content-Type" content="text/html; charset=utf-8" />
```

## 9.1.6. Collation Issues

The following sections discuss various aspects of character set collations.

### 9.1.6.1. Using `COLLATE` in SQL Statements

With the `COLLATE` clause, you can override whatever the default collation is for a comparison. `COLLATE` may be used in various parts of SQL statements. Here are some examples:

- With `ORDER BY`:

```
SELECT k
FROM t1
ORDER BY k COLLATE latin1_german2_ci;
```

- With `AS`:

```
SELECT k COLLATE latin1_german2_ci AS k1
```

```
FROM t1
ORDER BY k1;
```

- With **GROUP BY**:

```
SELECT k
FROM t1
GROUP BY k COLLATE latin1_german2_ci;
```

- With aggregate functions:

```
SELECT MAX(k COLLATE latin1_german2_ci)
FROM t1;
```

- With **DISTINCT**:

```
SELECT DISTINCT k COLLATE latin1_german2_ci
FROM t1;
```

- With **WHERE**:

```
SELECT *
FROM t1
WHERE _latin1 'Müller' COLLATE latin1_german2_ci = k;
```

```
SELECT *
FROM t1
WHERE k LIKE _latin1 'Müller' COLLATE latin1_german2_ci;
```

- With **HAVING**:

```
SELECT k
FROM t1
GROUP BY k
HAVING k = _latin1 'Müller' COLLATE latin1_german2_ci;
```

### 9.1.6.2. COLLATE Clause Precedence

The **COLLATE** clause has high precedence (higher than `| |`), so the following two expressions are equivalent:

```
x | | y COLLATE z
x | | (y COLLATE z)
```

### 9.1.6.3. BINARY Operator

The **BINARY** operator casts the string following it to a binary string. This is an easy way to force a comparison to be done byte by byte rather than character by character. **BINARY** also causes trailing spaces to be significant.

```
mysql> SELECT 'a' = 'A';
-> 1
mysql> SELECT BINARY 'a' = 'A';
-> 0
mysql> SELECT 'a' = 'a ';
-> 1
mysql> SELECT BINARY 'a' = 'a ';
-> 0
```

**BINARY** *str* is shorthand for `CAST(str AS BINARY)`.

The **BINARY** attribute in character column definitions has a different effect. A character column defined with the **BINARY** attribute is assigned the binary collation of the column's character set. Every character set has a binary collation. For example, the binary collation for the `latin1` character set is `latin1_bin`, so if the table default character set is `latin1`, these two column definitions are equivalent:

```
CHAR(10) BINARY
CHAR(10) CHARACTER SET latin1 COLLATE latin1_bin
```

The effect of **BINARY** as a column attribute differs from its effect prior to MySQL 4.1. Formerly, **BINARY** resulted in a column that was treated as a binary string. A binary string is a string of bytes that has no character set or collation, which differs from a nonbinary character string that has a binary collation. For both types of strings, comparisons are based on the numeric values of the

string unit, but for nonbinary strings the unit is the character and some character sets allow multi-byte characters. [Section 10.4.2, “The BINARY and VARBINARY Types”](#).

The use of `CHARACTER SET binary` in the definition of a `CHAR`, `VARCHAR`, or `TEXT` column causes the column to be treated as a binary data type. For example, the following pairs of definitions are equivalent:

```
CHAR(10) CHARACTER SET binary
BINARY(10)

VARCHAR(10) CHARACTER SET binary
VARBINARY(10)

TEXT CHARACTER SET binary
BLOB
```

#### 9.1.6.4. The `_bin` and `binary` Collations

This section describes how `_bin` collations for nonbinary strings differ from the `binary` “collation” for binary strings.

Nonbinary strings (as stored in the `CHAR`, `VARCHAR`, and `TEXT` data types) have a character set and collation. A given character set can have several collations, each of which defines a particular sorting and comparison order for the characters in the set. One of these is the binary collation for the character set, indicated by a `_bin` suffix in the collation name. For example, `latin1` and `utf8` have binary collations named `latin1_bin` and `utf8_bin`.

Binary strings (as stored in the `BINARY`, `VARBINARY`, and `BLOB` data types) have no character set or collation in the sense that nonbinary strings do. (Applied to a binary string, the `CHARSET()` and `COLLATION()` functions both return a value of `binary`.) Binary strings are sequences of bytes and the numeric values of those bytes determine sort order.

The `_bin` collations differ from the `binary` collation in several respects.

**The unit for sorting and comparison.** Binary strings are sequences of bytes. Sorting and comparison is always based on numeric byte values. Nonbinary strings are sequences of characters, which might be multi-byte. Collations for nonbinary strings define an ordering of the character values for sorting and comparison. For the `_bin` collation, this ordering is based solely on numeric values of the characters (which is similar to ordering for binary strings except that a `_bin` collation must take into account that a character might contain multiple bytes). For other collations, character ordering might take additional factors such as lettercase into account.

**Character set conversion.** A nonbinary string has a character set and is converted to another character set in many cases, even when the string has a `_bin` collation:

- When assigning column values from another column that has a different character set:

```
UPDATE t1 SET utf8_bin_column=latin1_column;
INSERT INTO t1 (latin1_column) SELECT utf8_bin_column FROM t2;
```

- When assigning column values for `INSERT` or `UPDATE` using a string literal:

```
SET NAMES latin1;
INSERT INTO t1 (utf8_bin_column) VALUES ('string-in-latin1');
```

- When sending results from the server to a client:

```
SET NAMES latin1;
SELECT utf8_bin_column FROM t2;
```

For binary string columns, no conversion occurs. For the preceding cases, the string value is copied byte-wise.

**Lettercase conversion.** Collations provide information about lettercase of characters, so characters in a nonbinary string can be converted from one lettercase to another, even for `_bin` collations that ignore lettercase for ordering:

```
mysql> SET NAMES latin1 COLLATE latin1_bin;
Query OK, 0 rows affected (0.02 sec)

mysql> SELECT LOWER('aA'), UPPER('zZ');
+-----+-----+
| LOWER('aA') | UPPER('zZ') |
+-----+-----+
| aa          | ZZ          |
+-----+-----+
1 row in set (0.13 sec)
```

The concept of lettercase does not apply to bytes in a binary string. To perform lettercase conversion, the string must be converted to a nonbinary string:

```
mysql> SET NAMES binary;
Query OK, 0 rows affected (0.00 sec)

mysql> SELECT LOWER('aA'), LOWER(CONVERT('aA' USING latin1));
+-----+-----+
| LOWER('aA') | LOWER(CONVERT('aA' USING latin1)) |
+-----+-----+
| aA          | aa                                |
+-----+-----+
1 row in set (0.00 sec)
```

**Trailing space handling in comparisons.** Nonbinary strings have `PADSPACE` behavior for all collations, including `_bin` collations. Trailing spaces are insignificant in comparisons:

```
mysql> SET NAMES utf8 COLLATE utf8_bin;
Query OK, 0 rows affected (0.00 sec)

mysql> SELECT 'a ' = 'a';
+-----+
| 'a ' = 'a' |
+-----+
|           1 |
+-----+
1 row in set (0.00 sec)
```

For binary strings, all characters are significant in comparisons, including trailing spaces:

```
mysql> SET NAMES binary;
Query OK, 0 rows affected (0.00 sec)

mysql> SELECT 'a ' = 'a';
+-----+
| 'a ' = 'a' |
+-----+
|           0 |
+-----+
1 row in set (0.00 sec)
```

**Trailing space handling for inserts and retrievals.** `CHAR(N)` columns store nonbinary strings. Values shorter than `N` characters are extended with spaces on insertion. For retrieval, trailing spaces are removed.

`BINARY(N)` columns store binary strings. Values shorter than `N` bytes are extended with `0x00` bytes on insertion. For retrieval, nothing is removed; a value of the declared length is always returned.

```
mysql> CREATE TABLE t1 (
->   a CHAR(10) CHARACTER SET utf8 COLLATE utf8_bin,
->   b BINARY(10)
-> );
Query OK, 0 rows affected (0.09 sec)

mysql> INSERT INTO t1 VALUES ('a','a');
Query OK, 1 row affected (0.01 sec)

mysql> SELECT HEX(a), HEX(b) FROM t1;
+-----+-----+
| HEX(a) | HEX(b) |
+-----+-----+
| 61     | 61000000000000000000 |
+-----+-----+
1 row in set (0.04 sec)
```

### 9.1.6.5. Special Cases Where Collation Determination Is Tricky

In the great majority of statements, it is obvious what collation MySQL uses to resolve a comparison operation. For example, in the following cases, it should be clear that the collation is the collation of column `x`:

```
SELECT x FROM T ORDER BY x;
SELECT x FROM T WHERE x = x;
SELECT DISTINCT x FROM T;
```

However, when multiple operands are involved, there can be ambiguity. For example:

```
SELECT x FROM T WHERE x = 'Y';
```

Should this query use the collation of the column `x`, or of the string literal `'Y'`?

Standard SQL resolves such questions using what used to be called “coercibility” rules. Basically, this means: Both `x` and `'Y'` have collations, so which collation takes precedence? This can be difficult to resolve, but the following rules cover most situations:

- An explicit `COLLATE` clause has a coercibility of 0. (Not coercible at all.)
- The concatenation of two strings with different collations has a coercibility of 1.
- The collation of a column or a stored routine parameter or local variable has a coercibility of 2.
- A “system constant” (the string returned by functions such as `USER()` or `VERSION()`) has a coercibility of 3.
- A literal's collation has a coercibility of 4.
- `NULL` or an expression that is derived from `NULL` has a coercibility of 5.

The preceding coercibility values are current for MySQL 5.1.

Those rules resolve ambiguities in the following manner:

- Use the collation with the lowest coercibility value.
- If both sides have the same coercibility, then:
  - If both sides are Unicode, or both sides are not Unicode, it is an error.
  - If one of the sides has a Unicode character set, and another side has a non-Unicode character set, the side with Unicode character set wins, and automatic character set conversion is applied to the non-Unicode side. For example, the following statement will not return an error:

```
SELECT CONCAT(utf8_column, latin1_column) FROM t1;
```

It will return a result, and the character set of the result will be `utf8`. The collation of the result will be the collation of `utf8_column`. Values of `latin1_column` will be automatically converted to `utf8` before concatenating.

- For an operation with operands from the same character set but that mix a `_bin` collation and a `_ci` or `_cs` collation, the `_bin` collation is used. This is similar to how operations that mix nonbinary and binary strings evaluate the operands as binary strings, except that it is for collations rather than data types.

Although automatic conversion is not in the SQL standard, the SQL standard document does say that every character set is (in terms of supported characters) a “subset” of Unicode. Because it is a well-known principle that “what applies to a superset can apply to a subset,” we believe that a collation for Unicode can apply for comparisons with non-Unicode strings.

Examples:

<code>column1 = 'A'</code>	Use collation of <code>column1</code>
<code>column1 = 'A' COLLATE x</code>	Use collation of <code>'A' COLLATE x</code>
<code>column1 COLLATE x = 'A' COLLATE y</code>	Error

The `COERCIBILITY()` function can be used to determine the coercibility of a string expression:

```
mysql> SELECT COERCIBILITY('A' COLLATE latin1_swedish_ci);
-> 0
mysql> SELECT COERCIBILITY(VERSION());
-> 3
mysql> SELECT COERCIBILITY('A');
-> 4
```

See [Section 11.11.3, “Information Functions”](#).

### 9.1.6.6. Collations Must Be for the Right Character Set

Each character set has one or more collations, but each collation is associated with one and only one character set. Therefore, the following statement causes an error message because the `latin2_bin` collation is not legal with the `latin1` character set:

```
mysql> SELECT _latin1 'x' COLLATE latin2_bin;
ERROR 1253 (42000): COLLATION 'latin2_bin' is not valid
for CHARACTER SET 'latin1'
```

### 9.1.6.7. Examples of the Effect of Collation

**Example 1: Sorting German Umlauts**

Suppose that column `X` in table `T` has these `latin1` column values:

```
Muffler
Müller
MX Systems
MySQL
```

Suppose also that the column values are retrieved using the following statement:

```
SELECT X FROM T ORDER BY X COLLATE collation_name;
```

The following table shows the resulting order of the values if we use `ORDER BY` with different collations.

<code>latin1_swedish_ci</code>	<code>latin1_german1_ci</code>	<code>latin1_german2_ci</code>
Muffler	Muffler	Müller
MX Systems	Müller	Muffler
Müller	MX Systems	MX Systems
MySQL	MySQL	MySQL

The character that causes the different sort orders in this example is the U with two dots over it (ü), which the Germans call “U-umlaut.”

- The first column shows the result of the `SELECT` using the Swedish/Finnish collating rule, which says that U-umlaut sorts with Y.
- The second column shows the result of the `SELECT` using the German DIN-1 rule, which says that U-umlaut sorts with U.
- The third column shows the result of the `SELECT` using the German DIN-2 rule, which says that U-umlaut sorts with UE.

**Example 2: Searching for German Umlauts**

Suppose that you have three tables that differ only by the character set and collation used:

```
mysql> CREATE TABLE german1 (
->   c CHAR(10)
-> ) CHARACTER SET latin1 COLLATE latin1_german1_ci;
mysql> CREATE TABLE german2 (
->   c CHAR(10)
-> ) CHARACTER SET latin1 COLLATE latin1_german2_ci;
mysql> CREATE TABLE germanutf8 (
->   c CHAR(10)
-> ) CHARACTER SET utf8 COLLATE utf8_unicode_ci;
```

Each table contains two records:

```
mysql> INSERT INTO german1 VALUES ('Bar'), ('Bär');
mysql> INSERT INTO german2 VALUES ('Bar'), ('Bär');
mysql> INSERT INTO germanutf8 VALUES ('Bar'), ('Bär');
```

Two of the above collations have an `A = Ä` equality, and one has no such equality (`latin1_german2_ci`). For that reason, you'll get these results in comparisons:

```
mysql> SELECT * FROM german1 WHERE c = 'Bär';
+-----+
| c      |
+-----+
| Bar    |
| Bär    |
+-----+
mysql> SELECT * FROM german2 WHERE c = 'Bär';
+-----+
| c      |
+-----+
| Bär    |
+-----+
mysql> SELECT * FROM germanutf8 WHERE c = 'Bär';
+-----+
| c      |
+-----+
| Bar    |
| Bär    |
+-----+
```

```
+-----+
```

This is not a bug but rather a consequence of the sorting that `latin1_german1_ci` or `utf8_unicode_ci` do (the sorting shown is done according to the German DIN 5007 standard).

## 9.1.7. String Repertoire

The *repertoire* of a character set is the collection of characters in the set.

As of MySQL 5.1.21, string expressions have a repertoire attribute, which can have two values:

- **ASCII**: The expression can contain only characters in the Unicode range `U+0000` to `U+007F`.
- **UNICODE**: The expression can contain characters in the Unicode range `U+0000` to `U+FFFF`.

The **ASCII** range is a subset of **UNICODE** range, so a string with **ASCII** repertoire can be converted safely without loss of information to the character set of any string with **UNICODE** repertoire or to a character set that is a superset of **ASCII**. (All MySQL character sets are supersets of **ASCII** with the exception of `swe7`, which reuses some punctuation characters for Swedish accented characters.) The use of repertoire enables character set conversion in expressions for many cases where MySQL would otherwise return an “illegal mix of collations” error.

The following discussion provides examples of expressions and their repertoires, and describes how the use of repertoire changes string expression evaluation:

- The repertoire for string constants depends on string content:

```
SET NAMES utf8; SELECT 'abc';
SELECT _utf8'def';
SELECT N'MySQL';
```

Although the character set is `utf8` in each of the preceding cases, the strings do not actually contain any characters outside the ASCII range, so their repertoire is **ASCII** rather than **UNICODE**.

- Columns having the `ascii` character set have **ASCII** repertoire because of their character set. In the following table, `c1` has **ASCII** repertoire:

```
CREATE TABLE t1 (c1 CHAR(1) CHARACTER SET ascii);
```

The following example illustrates how repertoire enables a result to be determined in a case where an error occurs without repertoire:

```
CREATE TABLE t1 (
  c1 CHAR(1) CHARACTER SET latin1,
  c2 CHAR(1) CHARACTER SET ascii
);
INSERT INTO t1 VALUES ('a','b');
SELECT CONCAT(c1,c2) FROM t1;
```

Without repertoire, this error occurs:

```
ERROR 1267 (HY000): Illegal mix of collations (latin1_swedish_ci,IMPLICIT)
and (ascii_general_ci,IMPLICIT) for operation 'concat'
```

Using repertoire, subset to superset (`ascii` to `latin1`) conversion can occur and a result is returned:

```
+-----+
| CONCAT(c1,c2) |
+-----+
| ab            |
+-----+
```

- Functions with one string argument inherit the repertoire of their argument. The result of `UPPER(_utf8'abc')` has **ASCII** repertoire, because its argument has **ASCII** repertoire.
- For functions that return a string but do not have string arguments and use `character_set_connection` as the result character set, the result repertoire is **ASCII** if `character_set_connection` is `ascii`, and **UNICODE** otherwise:

```
FORMAT(numeric_column, 4);
```

Use of repertoire changes how MySQL evaluates the following example:

```
SET NAMES ascii;
CREATE TABLE t1 (a INT, b VARCHAR(10) CHARACTER SET latin1);
INSERT INTO t1 VALUES (1, 'b');
SELECT CONCAT(FORMAT(a, 4), b) FROM t1;
```

Without repertoire, this error occurs:

```
ERROR 1267 (HY000): Illegal mix of collations (ascii_general_ci,COERCIBLE)
and (latin1_swedish_ci,IMPLICIT) for operation 'concat'
```

With repertoire, a result is returned:

```
+-----+
| CONCAT(FORMAT(a, 4), b) |
+-----+
| 1.0000b                 |
+-----+
```

- Functions with two or more string arguments use the “widest” argument repertoire for the result repertoire ([UNICODE](#) is wider than [ASCII](#)). Consider the following `CONCAT()` calls:

```
CONCAT(_ucs2 0x0041, _ucs2 0x0042)
CONCAT(_ucs2 0x0041, _ucs2 0x00C2)
```

For the first call, the repertoire is [ASCII](#) because both arguments are within the range of the `ascii` character set. For the second call, the repertoire is [UNICODE](#) because the second argument is outside the `ascii` character set range.

- The repertoire for function return values is determined based only on the repertoire of the arguments that affect the result's character set and collation.

```
IF(column1 < column2, 'smaller', 'greater')
```

The result repertoire is [ASCII](#) because the two string arguments (the second argument and the third argument) both have [ASCII](#) repertoire. The first argument does not matter for the result repertoire, even if the expression uses string values.

## 9.1.8. Operations Affected by Character Set Support

This section describes operations that take character set information into account.

### 9.1.8.1. Result Strings

MySQL has many operators and functions that return a string. This section answers the question: What is the character set and collation of such a string?

For simple functions that take string input and return a string result as output, the output's character set and collation are the same as those of the principal input value. For example, `UPPER(X)` returns a string whose character string and collation are the same as that of `X`. The same applies for `INSTR()`, `LCASE()`, `LOWER()`, `LTRIM()`, `MID()`, `REPEAT()`, `REPLACE()`, `REVERSE()`, `RIGHT()`, `RPAD()`, `RTRIM()`, `SOUNDEX()`, `SUBSTRING()`, `TRIM()`, `UCASE()`, and `UPPER()`.

Note: The `REPLACE()` function, unlike all other functions, always ignores the collation of the string input and performs a case-sensitive comparison.

If a string input or function result is a binary string, the string has no character set or collation. This can be checked by using the `CHARSET()` and `COLLATION()` functions, both of which return `binary` to indicate that their argument is a binary string:

```
mysql> SELECT CHARSET(BINARY 'a'), COLLATION(BINARY 'a');
+-----+-----+
| CHARSET(BINARY 'a') | COLLATION(BINARY 'a') |
+-----+-----+
| binary              | binary                |
+-----+-----+
```

For operations that combine multiple string inputs and return a single string output, the “aggregation rules” of standard SQL apply for determining the collation of the result:

- If an explicit `COLLATE X` occurs, use `X`.



- If explicit `COLLATE X` and `COLLATE Y` occur, raise an error.
- Otherwise, if all collations are `X`, use `X`.
- Otherwise, the result has no collation.

For example, with `CASE ... WHEN a THEN b WHEN b THEN c COLLATE X END`, the resulting collation is `X`. The same applies for `UNION`, `|`, `CONCAT()`, `ELT()`, `GREATEST()`, `IF()`, and `LEAST()`.

For operations that convert to character data, the character set and collation of the strings that result from the operations are defined by the `character_set_connection` and `collation_connection` system variables. This applies only to `CAST()`, `CONV()`, `FORMAT()`, `HEX()`, and `SPACE()`.

If you are uncertain about the character set or collation of the result returned by a string function, you can use the `CHARSET()` or `COLLATION()` function to find out:

```
mysql> SELECT USER(), CHARSET(USER()), COLLATION(USER());
+-----+-----+-----+
| USER()          | CHARSET(USER()) | COLLATION(USER()) |
+-----+-----+-----+
| test@localhost | utf8            | utf8_general_ci   |
+-----+-----+-----+
```

### 9.1.8.2. CONVERT() and CAST()

`CONVERT()` provides a way to convert data between different character sets. The syntax is:

```
CONVERT(expr USING transcoding_name)
```

In MySQL, transcoding names are the same as the corresponding character set names.

Examples:

```
SELECT CONVERT(_latin1'Müller' USING utf8);
INSERT INTO utf8table (utf8column)
  SELECT CONVERT(latin1field USING utf8) FROM latin1table;
```

`CONVERT(... USING ...)` is implemented according to the standard SQL specification.

You may also use `CAST()` to convert a string to a different character set. The syntax is:

```
CAST(character_string AS character_data_type CHARACTER SET charset_name)
```

Example:

```
SELECT CAST(_latin1'test' AS CHAR CHARACTER SET utf8);
```

If you use `CAST()` without specifying `CHARACTER SET`, the resulting character set and collation are defined by the `character_set_connection` and `collation_connection` system variables. If you use `CAST()` with `CHARACTER SET X`, the resulting character set and collation are `X` and the default collation of `X`.

You may not use a `COLLATE` clause inside a `CAST()`, but you may use it outside. That is, `CAST(... COLLATE ...)` is illegal, but `CAST(...) COLLATE ...` is legal.

Example:

```
SELECT CAST(_latin1'test' AS CHAR CHARACTER SET utf8) COLLATE utf8_bin;
```

### 9.1.8.3. SHOW Statements and INFORMATION\_SCHEMA

Several `SHOW` statements provide additional character set information. These include `SHOW CHARACTER SET`, `SHOW COLLATION`, `SHOW CREATE DATABASE`, `SHOW CREATE TABLE` and `SHOW COLUMNS`. These statements are described here briefly. For more information, see [Section 12.5.5, “SHOW Syntax”](#).

`INFORMATION_SCHEMA` has several tables that contain information similar to that displayed by the `SHOW` statements. For example, the `CHARACTER_SETS` and `COLLATIONS` tables contain the information displayed by `SHOW CHARACTER SET` and `SHOW COLLATION`. See [Chapter 19, INFORMATION\\_SCHEMA Tables](#).

The `SHOW CHARACTER SET` command shows all available character sets. It takes an optional `LIKE` clause that indicates which

character set names to match. For example:

```
mysql> SHOW CHARACTER SET LIKE 'latin%';
```

Charset	Description	Default collation	Maxlen
latin1	cp1252 West European	latin1_swedish_ci	1
latin2	ISO 8859-2 Central European	latin2_general_ci	1
latin5	ISO 8859-9 Turkish	latin5_turkish_ci	1
latin7	ISO 8859-13 Baltic	latin7_general_ci	1

The output from `SHOW COLLATION` includes all available character sets. It takes an optional `LIKE` clause that indicates which collation names to match. For example:

```
mysql> SHOW COLLATION LIKE 'latin1%';
```

Collation	Charset	Id	Default	Compiled	Sortlen
latin1_german1_ci	latin1	5			0
latin1_swedish_ci	latin1	8	Yes	Yes	0
latin1_danish_ci	latin1	15			0
latin1_german2_ci	latin1	31		Yes	2
latin1_bin	latin1	47		Yes	0
latin1_general_ci	latin1	48			0
latin1_general_cs	latin1	49			0
latin1_spanish_ci	latin1	94			0

`SHOW CREATE DATABASE` displays the `CREATE DATABASE` statement that creates a given database:

```
mysql> SHOW CREATE DATABASE test;
```

Database	Create Database
test	CREATE DATABASE `test` /*!40100 DEFAULT CHARACTER SET latin1 */

If no `COLLATE` clause is shown, the default collation for the character set applies.

`SHOW CREATE TABLE` is similar, but displays the `CREATE TABLE` statement to create a given table. The column definitions indicate any character set specifications, and the table options include character set information.

The `SHOW COLUMNS` statement displays the collations of a table's columns when invoked as `SHOW FULL COLUMNS`. Columns with `CHAR`, `VARCHAR`, or `TEXT` data types have collations. Numeric and other non-character types have no collation (indicated by `NULL` as the `Collation` value). For example:

```
mysql> SHOW FULL COLUMNS FROM person\G
***** 1. row *****
Field: id
Type: smallint(5) unsigned
Collation: NULL
Null: NO
Key: PRI
Default: NULL
Extra: auto_increment
Privileges: select,insert,update,references
Comment:
***** 2. row *****
Field: name
Type: char(60)
Collation: latin1_swedish_ci
Null: NO
Key:
Default:
Extra:
Privileges: select,insert,update,references
Comment:
```

The character set is not part of the display but is implied by the collation name.

## 9.1.9. Unicode Support

MySQL 5.1 supports two character sets for storing Unicode data:

- `ucs2`, the UCS-2 encoding of the Unicode character set using 16 bits per character
- `utf8`, a UTF-8 encoding of the Unicode character set using one to three bytes per character

These two character sets support the characters from the Basic Multilingual Plane (BMP) of Unicode Version 3.0. BMP characters have these characteristics:

- Their code values are between 0 and 65535 (or `U+0000 .. U+FFFF`)
- They can be encoded with a fixed 16-bit word, as in `ucs2`
- They can be encoded with 8, 16, or 24 bits, as in `utf8`
- They are sufficient for almost all characters in major languages

The `ucs2` and `utf8` character sets do not support supplementary characters that lie outside the BMP.

A similar set of collations is available for each Unicode character set. For example, each has a Danish collation, the names of which are `ucs2_danish_ci` and `utf8_danish_ci`. All Unicode collations are listed at [Section 9.1.12.1, “Unicode Character Sets”](#).

In UCS-2, every character is represented by a two-byte Unicode code with the most significant byte first. For example: `LATIN CAPITAL LETTER A` has the code `0x0041` and it is stored as a two-byte sequence: `0x00 0x41`. `CYRILLIC SMALL LETTER YERU` (Unicode `0x044B`) is stored as a two-byte sequence: `0x04 0x4B`. For Unicode characters and their codes, please refer to the [Unicode Home Page](#).

The MySQL implementation of UCS-2 stores characters in big-endian byte order and does not use a byte order mark (BOM) at the beginning of UCS-2 values. Other database systems might use little-endian byte order or a BOM, in which case, conversion of UCS-2 values will need to be performed when transferring data between those systems and MySQL.

UTF-8 (Unicode Transformation Format with 8-bit units) is an alternative way to store Unicode data. It is implemented according to RFC 3629. RFC 3629 describes encoding sequences that take from one to four bytes. Currently, MySQL support for UTF-8 does not include four-byte sequences. (An older standard for UTF-8 encoding is given by RFC 2279, which describes UTF-8 sequences that take from one to six bytes. RFC 3629 renders RFC 2279 obsolete; for this reason, sequences with five and six bytes are no longer used.)

The idea of UTF-8 is that various Unicode characters are encoded using byte sequences of different lengths:

- Basic Latin letters, digits, and punctuation signs use one byte.
- Most European and Middle East script letters fit into a two-byte sequence: extended Latin letters (with tilde, macron, acute, grave and other accents), Cyrillic, Greek, Armenian, Hebrew, Arabic, Syriac, and others.
- Korean, Chinese, and Japanese ideographs use three-byte sequences.

MySQL uses no BOM for UTF-8 values.

**Tip:** To save space with UTF-8, use `VARCHAR` instead of `CHAR`. Otherwise, MySQL must reserve three bytes for each character in a `CHAR CHARACTER SET utf8` column because that is the maximum possible length. For example, MySQL must reserve 30 bytes for a `CHAR(10) CHARACTER SET utf8` column.

UCS-2 cannot be used as a client character set, which means that `SET NAMES 'ucs2'` does not work. (See [Section 9.1.4, “Connection Character Sets and Collations”](#).)

Client applications that need to communicate with the server using Unicode should set the client character set accordingly; for example, by issuing a `SET NAMES 'utf8'` statement. `ucs2` cannot be used as a client character set, which means that it does not work for `SET NAMES` or `SET CHARACTER SET`. (See [Section 9.1.4, “Connection Character Sets and Collations”](#).)

## 9.1.10. UTF-8 for Metadata

*Metadata* is “the data about the data.” Anything that *describes* the database — as opposed to being the *contents* of the database — is metadata. Thus column names, database names, user names, version names, and most of the string results from `SHOW` are metadata. This is also true of the contents of tables in `INFORMATION_SCHEMA`, because those tables by definition contain information about database objects.

Representation of metadata must satisfy these requirements:

- All metadata must be in the same character set. Otherwise, neither the `SHOW` commands nor `SELECT` statements for tables in `INFORMATION_SCHEMA` would work properly because different rows in the same column of the results of these operations would be in different character sets.

- Metadata must include all characters in all languages. Otherwise, users would not be able to name columns and tables using their own languages.

To satisfy both requirements, MySQL stores metadata in a Unicode character set, namely UTF-8. This does not cause any disruption if you never use accented or non-Latin characters. But if you do, you should be aware that metadata is in UTF-8.

The metadata requirements mean that the return values of the `USER()`, `CURRENT_USER()`, `SESSION_USER()`, `SYSTEM_USER()`, `DATABASE()`, and `VERSION()` functions have the UTF-8 character set by default.

The server sets the `character_set_system` system variable to the name of the metadata character set:

```
mysql> SHOW VARIABLES LIKE 'character_set_system';
+-----+-----+
| Variable_name | Value |
+-----+-----+
| character_set_system | utf8 |
+-----+-----+
```

Storage of metadata using Unicode does *not* mean that the server returns headers of columns and the results of `DESCRIBE` functions in the `character_set_system` character set by default. When you use `SELECT column1 FROM t`, the name `column1` itself is returned from the server to the client in the character set determined by the value of the `character_set_results` system variable, which has a default value of `latin1`. If you want the server to pass metadata results back in a different character set, use the `SET NAMES` statement to force the server to perform character set conversion. `SET NAMES` sets the `character_set_results` and other related system variables. (See [Section 9.1.4, “Connection Character Sets and Collations”](#).) Alternatively, a client program can perform the conversion after receiving the result from the server. It is more efficient for the client perform the conversion, but this option is not always available for all clients.

If `character_set_results` is set to `NULL`, no conversion is performed and the server returns metadata using its original character set (the set indicated by `character_set_system`).

Error messages returned from the server to the client are converted to the client character set automatically, as with metadata.

If you are using (for example) the `USER()` function for comparison or assignment within a single statement, don't worry. MySQL performs some automatic conversion for you.

```
SELECT * FROM t1 WHERE USER() = latin1_column;
```

This works because the contents of `latin1_column` are automatically converted to UTF-8 before the comparison.

```
INSERT INTO t1 (latin1_column) SELECT USER();
```

This works because the contents of `USER()` are automatically converted to `latin1` before the assignment.

Although automatic conversion is not in the SQL standard, the SQL standard document does say that every character set is (in terms of supported characters) a “subset” of Unicode. Because it is a well-known principle that “what applies to a superset can apply to a subset,” we believe that a collation for Unicode can apply for comparisons with non-Unicode strings. For more information about coercion of strings, see [Section 9.1.6.5, “Special Cases Where Collation Determination Is Tricky”](#).

## 9.1.11. Column Character Set Conversion

To convert a binary or nonbinary string column to use a particular character set, use `ALTER TABLE`. For successful conversion to occur, one of the following conditions must apply:

- If the column has a binary data type (`BINARY`, `VARBINARY`, `BLOB`), all the values that it contains must be encoded using a single character set (the character set you're converting the column to). If you use a binary column to store information in multiple character sets, MySQL has no way to know which values use which character set and cannot convert the data properly.
- If the column has a nonbinary data type (`CHAR`, `VARCHAR`, `TEXT`), its contents should be encoded in the column's character set, not some other character set. If the contents are encoded in a different character set, you can convert the column to use a binary data type first, and then to a nonbinary column with the desired character set.

Suppose that a table `t` has a binary column named `col1` defined as `VARBINARY(50)`. Assuming that the information in the column is encoded using a single character set, you can convert it to a nonbinary column that has that character set. For example, if `col1` contains binary data representing characters in the `greek` character set, you can convert it as follows:

```
ALTER TABLE t MODIFY col1 VARCHAR(50) CHARACTER SET greek;
```

If your original column has a type of `BINARY(50)`, you could convert it to `CHAR(50)`, but the resulting values will be padded with `0x00` bytes at the end, which may be undesirable. To remove these bytes, use the `TRIM()` function:

```
UPDATE t SET col1 = TRIM(TRAILING 0x00 FROM col1);
```

Suppose that table `t` has a nonbinary column named `col1` defined as `CHAR(50) CHARACTER SET latin1` but you want to convert it to use `utf8` so that you can store values from many languages. The following statement accomplishes this:

```
ALTER TABLE t MODIFY col1 CHAR(50) CHARACTER SET utf8;
```

Conversion may be lossy if the column contains characters that are not in both character sets.

A special case occurs if you have old tables from MySQL 4.0 or earlier where a nonbinary column contains values that actually are encoded in a character set different from the server's default character set. For example, an application might have stored `sjis` values in a column, even though MySQL's default character set was `latin1`. It is possible to convert the column to use the proper character set but an additional step is required. Suppose that the server's default character set was `latin1` and `col1` is defined as `CHAR(50)` but its contents are `sjis` values. The first step is to convert the column to a binary data type, which removes the existing character set information without performing any character conversion:

```
ALTER TABLE t MODIFY col1 BLOB;
```

The next step is to convert the column to a nonbinary data type with the proper character set:

```
ALTER TABLE t MODIFY col1 CHAR(50) CHARACTER SET sjis;
```

This procedure requires that the table not have been modified already with statements such as `INSERT` or `UPDATE` after an upgrade to MySQL 4.1 or later. In that case, MySQL would store new values in the column using `latin1`, and the column will contain a mix of `sjis` and `latin1` values and cannot be converted properly.

If you specified attributes when creating a column initially, you should also specify them when altering the table with `ALTER TABLE`. For example, if you specified `NOT NULL` and an explicit `DEFAULT` value, you should also provide them in the `ALTER TABLE` statement. Otherwise, the resulting column definition will not include those attributes.

## 9.1.12. Character Sets and Collations That MySQL Supports

MySQL supports 70+ collations for 30+ character sets. This section indicates which character sets MySQL supports. There is one subsection for each group of related character sets. For each character set, the allowable collations are listed.

You can always list the available character sets and their default collations with the `SHOW CHARACTER SET` statement:

```
mysql> SHOW CHARACTER SET;
```

Charset	Description	Default collation
big5	Big5 Traditional Chinese	big5_chinese_ci
dec8	DEC West European	dec8_swedish_ci
cp850	DOS West European	cp850_general_ci
hp8	HP West European	hp8_english_ci
koi8r	KOI8-R Relcom Russian	koi8r_general_ci
latin1	cp1252 West European	latin1_swedish_ci
latin2	ISO 8859-2 Central European	latin2_general_ci
swe7	7bit Swedish	swe7_swedish_ci
ascii	US ASCII	ascii_general_ci
ujis	EUC-JP Japanese	ujis_japanese_ci
sjis	Shift-JIS Japanese	sjis_japanese_ci
hebrew	ISO 8859-8 Hebrew	hebrew_general_ci
tis620	TIS620 Thai	tis620_thai_ci
euckr	EUC-KR Korean	euckr_korean_ci
koi8u	KOI8-U Ukrainian	koi8u_general_ci
gb2312	GB2312 Simplified Chinese	gb2312_chinese_ci
greek	ISO 8859-7 Greek	greek_general_ci
cp1250	Windows Central European	cp1250_general_ci
gbk	GBK Simplified Chinese	gbk_chinese_ci
latin5	ISO 8859-9 Turkish	latin5_turkish_ci
armscii8	ARMSSCII-8 Armenian	armscii8_general_ci
utf8	UTF-8 Unicode	utf8_general_ci
ucs2	UCS-2 Unicode	ucs2_general_ci
cp866	DOS Russian	cp866_general_ci
keybcs2	DOS Kamenicky Czech-Slovak	keybcs2_general_ci
macce	Mac Central European	macce_general_ci
macroman	Mac West European	macroman_general_ci
cp852	DOS Central European	cp852_general_ci
latin7	ISO 8859-13 Baltic	latin7_general_ci
cp1251	Windows Cyrillic	cp1251_general_ci
cp1256	Windows Arabic	cp1256_general_ci
cp1257	Windows Baltic	cp1257_general_ci
binary	Binary pseudo charset	binary
geostd8	GEOSTD8 Georgian	geostd8_general_ci
cp932	SJIS for Windows Japanese	cp932_japanese_ci

```
| eucjpm | UJIS for Windows Japanese | eucjpm_japanese_ci |  
+-----+-----+-----+
```

In cases where a character set has multiple collations, it might not be clear which collation is most suitable for a given application. To avoid choosing the wrong collation, it can be helpful to perform some comparisons with representative data values to make sure that a given collation sorts values the way you expect.

[Collation-Charts.Org](http://Collation-Charts.Org) is a useful site for information that shows how one collation compares to another.

### 9.1.12.1. Unicode Character Sets

MySQL 5.1 has two Unicode character sets:

- `ucs2`, the UCS-2 encoding of the Unicode character set using 16 bits per character
- `utf8`, a UTF-8 encoding of the Unicode character set using one to three bytes per character

You can store text in about 650 languages using these character sets. This section lists the collations available for each Unicode character set. For general information about the character sets, see [Section 9.1.9, “Unicode Support”](#).

A similar set of collations is available for each Unicode character set. These are shown in the following list, where `xxx` represents the character set name. For example, `xxx_danish_ci` represents the Danish collations, the specific names of which are `ucs2_danish_ci` and `utf8_danish_ci`.

- `xxx_bin`
- `xxx_czech_ci`
- `xxx_danish_ci`
- `xxx_esperanto_ci`
- `xxx_estonian_ci`
- `xxx_general_ci` (default)
- `xxx_hungarian_ci`
- `xxx_icelandic_ci`
- `xxx_latvian_ci`
- `xxx_lithuanian_ci`
- `xxx_persian_ci`
- `xxx_polish_ci`
- `xxx_roman_ci`
- `xxx_romanian_ci`
- `xxx_slovak_ci`
- `xxx_slovenian_ci`
- `xxx_spanish2_ci`
- `xxx_spanish_ci`
- `xxx_swedish_ci`
- `xxx_turkish_ci`
- `xxx_unicode_ci`

The `xxx_hungarian_ci` collations were added in MySQL 5.1.5.

MySQL implements the `xxx_unicode_ci` collations according to the Unicode Collation Algorithm (UCA) described at <http://www.unicode.org/reports/tr10/>. The collation uses the version-4.0.0 UCA weight keys: <http://www.unicode.org/Public/UC4.0.0/allkeys-4.0.0.txt>. Currently, the `xxx_unicode_ci` collations have only partial support for the Unicode Collation Algorithm. Some characters are not supported yet. Also, combining marks are not fully supported. This affects primarily Vietnamese, Yoruba, and some smaller languages such as Navajo. The following discussion uses `utf8_unicode_ci` for concreteness.

For any Unicode character set, operations performed using the `_general_ci` collation are faster than those for the `_unicode_ci` collation. For example, comparisons for the `utf8_general_ci` collation are faster, but slightly less correct, than comparisons for `utf8_unicode_ci`. The reason for this is that `utf8_unicode_ci` supports mappings such as expansions; that is, when one character compares as equal to combinations of other characters. For example, in German and some other languages “ß” is equal to “ss”. `utf8_unicode_ci` also supports contractions and ignorable characters. `utf8_general_ci` is a legacy collation that does not support expansions, contractions, or ignorable characters. It can make only one-to-one comparisons between characters.

To further illustrate, the following equalities hold in both `utf8_general_ci` and `utf8_unicode_ci` (for the effect this has in comparisons or when doing searches, see [Section 9.1.6.7, “Examples of the Effect of Collation”](#)):

```
Ä = A
Ö = O
Û = U
```

A difference between the collations is that this is true for `utf8_general_ci`:

```
ß = s
```

Whereas this is true for `utf8_unicode_ci`:

```
ß = ss
```

MySQL implements language-specific collations for the `utf8` character set only if the ordering with `utf8_unicode_ci` does not work well for a language. For example, `utf8_unicode_ci` works fine for German and French, so there is no need to create special `utf8` collations for these two languages.

`utf8_general_ci` also is satisfactory for both German and French, except that “ß” is equal to “s”, and not to “ss”. If this is acceptable for your application, then you should use `utf8_general_ci` because it is faster. Otherwise, use `utf8_unicode_ci` because it is more accurate.

`utf8_swedish_ci`, like other `utf8` language-specific collations, is derived from `utf8_unicode_ci` with additional language rules. For example, in Swedish, the following relationship holds, which is not something expected by a German or French speaker:

```
Û = Y < Ö
```

The `xxx_spanish_ci` and `xxx_spanish2_ci` collations correspond to modern Spanish and traditional Spanish, respectively. In both collations, “ñ” (n-tilde) is a separate letter between “n” and “o”. In addition, for traditional Spanish, “ch” is a separate letter between “c” and “d”, and “ll” is a separate letter between “l” and “m”.

In the `xxx_roman_ci` collations, I and J compare as equal, and U and V compare as equal.

For additional information about Unicode collations in MySQL, see [Collation-Charts.Org \(utf8\)](#).

### 9.1.12.2. West European Character Sets

Western European character sets cover most West European languages, such as French, Spanish, Catalan, Basque, Portuguese, Italian, Albanian, Dutch, German, Danish, Swedish, Norwegian, Finnish, Faroese, Icelandic, Irish, Scottish, and English.

- `ascii` (US ASCII) collations:
  - `ascii_bin`
  - `ascii_general_ci` (default)
- `cp850` (DOS West European) collations:
  - `cp850_bin`
  - `cp850_general_ci` (default)

- `dec8` (DEC Western European) collations:
  - `dec8_bin`
  - `dec8_swedish_ci` (default)
- `hp8` (HP Western European) collations:
  - `hp8_bin`
  - `hp8_english_ci` (default)
- `latin1` (cp1252 West European) collations:
  - `latin1_bin`
  - `latin1_danish_ci`
  - `latin1_general_ci`
  - `latin1_general_cs`
  - `latin1_german1_ci`
  - `latin1_german2_ci`
  - `latin1_spanish_ci`
  - `latin1_swedish_ci` (default)

`latin1` is the default character set. MySQL's `latin1` is the same as the Windows `cp1252` character set. This means it is the same as the official [ISO 8859-1](#) or IANA (Internet Assigned Numbers Authority) `latin1`, except that IANA `latin1` treats the code points between `0x80` and `0x9f` as “undefined,” whereas `cp1252`, and therefore MySQL's `latin1`, assign characters for those positions. For example, `0x80` is the Euro sign. For the “undefined” entries in `cp1252`, MySQL translates `0x81` to Unicode `0x0081`, `0x8d` to `0x008d`, `0x8f` to `0x008f`, `0x90` to `0x0090`, and `0x9d` to `0x009d`.

The `latin1_swedish_ci` collation is the default that probably is used by the majority of MySQL customers. Although it is frequently said that it is based on the Swedish/Finnish collation rules, there are Swedes and Finns who disagree with this statement.

The `latin1_german1_ci` and `latin1_german2_ci` collations are based on the DIN-1 and DIN-2 standards, where DIN stands for *Deutsches Institut für Normung* (the German equivalent of ANSI). DIN-1 is called the “dictionary collation” and DIN-2 is called the “phone book collation.” For an example of the effect this has in comparisons or when doing searches, see [Section 9.1.6.7, “Examples of the Effect of Collation”](#).

- `latin1_german1_ci` (dictionary) rules:

```

Ä = A
Ö = O
Û = U
ß = s

```

- `latin1_german2_ci` (phone-book) rules:

```

Ä = AE
Ö = OE
Û = UE
ß = ss

```

For an example of the effect this has in comparisons or when doing searches, see [Section 9.1.6.7, “Examples of the Effect of Collation”](#).

In the `latin1_spanish_ci` collation, “ñ” (n-tilde) is a separate letter between “n” and “o”.

- `macroman` (Mac West European) collations:
  - `macroman_bin`
  - `macroman_general_ci` (default)
- `swe7` (7bit Swedish) collations:



- `swe7_bin`
- `swe7_swedish_ci` (default)

For additional information about Western European collations in MySQL, see [Collation-Charts.Org](#) ([ascii](#), [cp850](#), [dec8](#), [hp8](#), [latin1](#), [macroman](#), [swe7](#)).

### 9.1.12.3. Central European Character Sets

MySQL provides some support for character sets used in the Czech Republic, Slovakia, Hungary, Romania, Slovenia, Croatia, Poland, and Serbia (Latin).

- `cp1250` (Windows Central European) collations:
  - `cp1250_bin`
  - `cp1250_croatian_ci`
  - `cp1250_czech_cs`
  - `cp1250_general_ci` (default)
  - `cp1250_polish_ci`
- `cp852` (DOS Central European) collations:
  - `cp852_bin`
  - `cp852_general_ci` (default)
- `keybcs2` (DOS Kamenicky Czech-Slovak) collations:
  - `keybcs2_bin`
  - `keybcs2_general_ci` (default)
- `latin2` (ISO 8859-2 Central European) collations:
  - `latin2_bin`
  - `latin2_croatian_ci`
  - `latin2_czech_cs`
  - `latin2_general_ci` (default)
  - `latin2_hungarian_ci`
- `macce` (Mac Central European) collations:
  - `macce_bin`
  - `macce_general_ci` (default)

For additional information about Central European collations in MySQL, see [Collation-Charts.Org](#) ([cp1250](#), [cp852](#), [keybcs2](#), [latin2](#), [macce](#)).

### 9.1.12.4. South European and Middle East Character Sets

South European and Middle Eastern character sets supported by MySQL include Armenian, Arabic, Georgian, Greek, Hebrew, and Turkish.

- `armscii8` (ARMScii-8 Armenian) collations:
  - `armscii8_bin`
  - `armscii8_general_ci` (default)

- `cp1256` (Windows Arabic) collations:
  - `cp1256_bin`
  - `cp1256_general_ci` (default)
- `geostd8` (GEOSTD8 Georgian) collations:
  - `geostd8_bin`
  - `geostd8_general_ci` (default)
- `greek` (ISO 8859-7 Greek) collations:
  - `greek_bin`
  - `greek_general_ci` (default)
- `hebrew` (ISO 8859-8 Hebrew) collations:
  - `hebrew_bin`
  - `hebrew_general_ci` (default)
- `latin5` (ISO 8859-9 Turkish) collations:
  - `latin5_bin`
  - `latin5_turkish_ci` (default)

For additional information about South European and Middle Eastern collations in MySQL, see Collation-Charts.Org ([armscii8](#), [cp1256](#), [geostd8](#), [greek](#), [hebrew](#), [latin5](#)).

### 9.1.12.5. Baltic Character Sets

The Baltic character sets cover Estonian, Latvian, and Lithuanian languages.

- `cp1257` (Windows Baltic) collations:
  - `cp1257_bin`
  - `cp1257_general_ci` (default)
  - `cp1257_lithuanian_ci`
- `latin7` (ISO 8859-13 Baltic) collations:
  - `latin7_bin`
  - `latin7_estonian_cs`
  - `latin7_general_ci` (default)
  - `latin7_general_cs`

For additional information about Baltic collations in MySQL, see Collation-Charts.Org ([cp1257](#), [latin7](#)).

### 9.1.12.6. Cyrillic Character Sets

The Cyrillic character sets and collations are for use with Belarusian, Bulgarian, Russian, Ukrainian, and Serbian (Cyrillic) languages.

- `cp1251` (Windows Cyrillic) collations:
  - `cp1251_bin`
  - `cp1251_bulgarian_ci`

- `cp1251_general_ci` (default)
- `cp1251_general_cs`
- `cp1251_ukrainian_ci`
- `cp866` (DOS Russian) collations:
  - `cp866_bin`
  - `cp866_general_ci` (default)
- `koi8r` (KOI8-R Relcom Russian) collations:
  - `koi8r_bin`
  - `koi8r_general_ci` (default)
- `koi8u` (KOI8-U Ukrainian) collations:
  - `koi8u_bin`
  - `koi8u_general_ci` (default)

For additional information about Cyrillic collations in MySQL, see [Collation-Charts.Org](#) ([cp1251](#), [cp866](#), [koi8r](#), [koi8u](#)). ).

### 9.1.12.7. Asian Character Sets

The Asian character sets that we support include Chinese, Japanese, Korean, and Thai. These can be complicated. For example, the Chinese sets must allow for thousands of different characters. See [Section 9.1.12.7.1, “The cp932 Character Set”](#), for additional information about the `cp932` and `sjis` character sets.

For answers to some common questions and problems relating support for Asian character sets in MySQL, see [Section A.11, “MySQL 5.1 FAQ — MySQL Chinese, Japanese, and Korean Character Sets”](#).

- `big5` (Big5 Traditional Chinese) collations:
  - `big5_bin`
  - `big5_chinese_ci` (default)
- `cp932` (SJIS for Windows Japanese) collations:
  - `cp932_bin`
  - `cp932_japanese_ci` (default)
- `eucjpms` (UJIS for Windows Japanese) collations:
  - `eucjpms_bin`
  - `eucjpms_japanese_ci` (default)
- `euckr` (EUC-KR Korean) collations:
  - `euckr_bin`
  - `euckr_korean_ci` (default)
- `gb2312` (GB2312 Simplified Chinese) collations:
  - `gb2312_bin`
  - `gb2312_chinese_ci` (default)
- `gbk` (GBK Simplified Chinese) collations:
  - `gbk_bin`

- `gbk_chinese_ci` (default)
- `sjis` (Shift-JIS Japanese) collations:
  - `sjis_bin`
  - `sjis_japanese_ci` (default)
- `tis620` (TIS620 Thai) collations:
  - `tis620_bin`
  - `tis620_thai_ci` (default)
- `ujis` (EUC-JP Japanese) collations:
  - `ujis_bin`
  - `ujis_japanese_ci` (default)

The `big5_chinese_ci` collation sorts on number of strokes.

For additional information about Asian collations in MySQL, see Collation-Charts.Org ([big5](http://www.collation-charts.org), [cp932](http://www.collation-charts.org), [eucjpm](http://www.collation-charts.org), [euckr](http://www.collation-charts.org), [gb2312](http://www.collation-charts.org), [gbk](http://www.collation-charts.org), [sjis](http://www.collation-charts.org), [tis620](http://www.collation-charts.org), [ujis](http://www.collation-charts.org)).

### 9.1.12.7.1. The `cp932` Character Set

#### Why is `cp932` needed?

In MySQL, the `sjis` character set corresponds to the `Shift_JIS` character set defined by IANA, which supports JIS X0201 and JIS X0208 characters. (See <http://www.iana.org/assignments/character-sets>.)

However, the meaning of “SHIFT JIS” as a descriptive term has become very vague and it often includes the extensions to `Shift_JIS` that are defined by various vendors.

For example, “SHIFT JIS” used in Japanese Windows environments is a Microsoft extension of `Shift_JIS` and its exact name is `Microsoft Windows Codepage : 932` or `cp932`. In addition to the characters supported by `Shift_JIS`, `cp932` supports extension characters such as NEC special characters, NEC selected — IBM extended characters, and IBM extended characters.

Many Japanese users have experienced problems using these extension characters. These problems stem from the following factors:

- MySQL automatically converts character sets.
- Character sets are converted via Unicode (`ucs2`).
- The `sjis` character set does not support the conversion of these extension characters.
- There are several conversion rules from so-called “SHIFT JIS” to Unicode, and some characters are converted to Unicode differently depending on the conversion rule. MySQL supports only one of these rules (described later).

The MySQL `cp932` character set is designed to solve these problems.

Because MySQL supports character set conversion, it is important to separate IANA `Shift_JIS` and `cp932` into two different character sets because they provide different conversion rules.

#### How does `cp932` differ from `sjis`?

The `cp932` character set differs from `sjis` in the following ways:

- `cp932` supports NEC special characters, NEC selected — IBM extended characters, and IBM selected characters.
- Some `cp932` characters have two different code points, both of which convert to the same Unicode code point. When converting from Unicode back to `cp932`, one of the code points must be selected. For this “round trip conversion,” the rule recommended by Microsoft is used. (See <http://support.microsoft.com/kb/170559/EN-US/>.)

The conversion rule works like this:

- If the character is in both JIS X 0208 and NEC special characters, use the code point of JIS X 0208.
- If the character is in both NEC special characters and IBM selected characters, use the code point of NEC special characters.
- If the character is in both IBM selected characters and NEC selected — IBM extended characters, use the code point of IBM extended characters.

The table shown at <http://www.microsoft.com/globaldev/reference/dbcs/932.htm> provides information about the Unicode values of `cp932` characters. For `cp932` table entries with characters under which a four-digit number appears, the number represents the corresponding Unicode (`ucs2`) encoding. For table entries with an underlined two-digit value appears, there is a range of `cp932` character values that begin with those two digits. Clicking such a table entry takes you to a page that displays the Unicode value for each of the `cp932` characters that begin with those digits.

The following links are of special interest. They correspond to the encodings for the following sets of characters:

- NEC special characters:

[http://www.microsoft.com/globaldev/reference/dbcs/932/932\\_87.htm](http://www.microsoft.com/globaldev/reference/dbcs/932/932_87.htm)

- NEC selected — IBM extended characters:

[http://www.microsoft.com/globaldev/reference/dbcs/932/932\\_ED.htm](http://www.microsoft.com/globaldev/reference/dbcs/932/932_ED.htm)  
[http://www.microsoft.com/globaldev/reference/dbcs/932/932\\_EE.htm](http://www.microsoft.com/globaldev/reference/dbcs/932/932_EE.htm)

- IBM selected characters:

[http://www.microsoft.com/globaldev/reference/dbcs/932/932\\_FA.htm](http://www.microsoft.com/globaldev/reference/dbcs/932/932_FA.htm)  
[http://www.microsoft.com/globaldev/reference/dbcs/932/932\\_FB.htm](http://www.microsoft.com/globaldev/reference/dbcs/932/932_FB.htm)  
[http://www.microsoft.com/globaldev/reference/dbcs/932/932\\_FC.htm](http://www.microsoft.com/globaldev/reference/dbcs/932/932_FC.htm)

- `cp932` supports conversion of user-defined characters in combination with `ucjpm`s, and solves the problems with `sjis/ujis` conversion. For details, please refer to <http://www.opengroup.or.jp/jvc/cde/sjis-ucjpm.html>.

For some characters, conversion to and from `ucs2` is different for `sjis` and `cp932`. The following tables illustrate these differences.

Conversion to `ucs2`:

<code>sjis/cp932</code> Value	<code>sjis</code> -> <code>ucs2</code> Conversion	<code>cp932</code> -> <code>ucs2</code> Conversion
5C	005C	005C
7E	007E	007E
815C	2015	2015
815F	005C	FF3C
8160	301C	FF5E
8161	2016	2225
817C	2212	FF0D
8191	00A2	FFE0
8192	00A3	FFE1
81CA	00AC	FFE2

Conversion from `ucs2`:

<code>ucs2</code> value	<code>ucs2</code> -> <code>sjis</code> Conversion	<code>ucs2</code> -> <code>cp932</code> Conversion
005C	815F	5C
007E	7E	7E
00A2	8191	3F
00A3	8192	3F
00AC	81CA	3F
2015	815C	815C

2016	8161	3F
2212	817C	3F
2225	3F	8161
301C	8160	3F
FF0D	3F	817C
FF3C	3F	815F
FF5E	3F	8160
FFE0	3F	8191
FFE1	3F	8192
FFE2	3F	81CA

Users of any Japanese character sets should be aware that using `--character-set-client-handshake` (or `--skip-character-set-client-handshake`) has an important effect. See [Section 5.1.2, “Server Command Options”](#).

## 9.2. The Character Set Used for Data and Sorting

By default, MySQL uses the `latin1` (cp1252 West European) character set and the `latin1_swedish_ci` collation that sorts according to Swedish/Finnish rules. These defaults are suitable for the United States and most of Western Europe.

All MySQL binary distributions are compiled with `--with-extra-charsets=complex`. This adds code to all standard programs that enables them to handle `latin1` and all multi-byte character sets within the binary. Other character sets are loaded from a character-set definition file when needed.

The character set determines what characters are allowed in identifiers. The collation determines how strings are sorted by the `ORDER BY` and `GROUP BY` clauses of the `SELECT` statement.

You can change the default server character set and collation with the `--character-set-server` and `--collation-server` options when you start the server. The collation must be a legal collation for the default character set. (Use the `SHOW COLLATION` statement to determine which collations are available for each character set.) See [Section 5.1.2, “Server Command Options”](#).

The character sets available depend on the `--with-charset=charset_name` and `--with-extra-charsets=list-of-charsets | complex | all | none` options to `configure`, and the character set configuration files listed in `SHAREDIR/charsets/Index`. See [Section 2.10.2, “Typical configure Options”](#).

If you change the character set when running MySQL, that may also change the sort order. Consequently, you must run `mysis-amchk -r -q --set-collation=collation_name` on all `MyISAM` tables, or your indexes may not be ordered correctly.

When a client connects to a MySQL server, the server indicates to the client what the server's default character set is. The client switches to this character set for this connection.

You should use `mysql_real_escape_string()` when escaping strings for an SQL query. `mysql_real_escape_string()` is identical to the old `mysql_escape_string()` function, except that it takes the `MYSQL` connection handle as the first parameter so that the appropriate character set can be taken into account when escaping characters.

If the client is compiled with paths that differ from where the server is installed and the user who configured MySQL didn't include all character sets in the MySQL binary, you must tell the client where it can find the additional character sets it needs if the server runs with a different character set from the client. You can do this by specifying a `--character-sets-dir` option to indicate the path to the directory in which the dynamic MySQL character sets are stored. For example, you can put the following in an option file:

```
[client]
character-sets-dir=/usr/local/mysql/share/mysql/charsets
```

You can force the client to use specific character set as follows:

```
[client]
default-character-set=charset_name
```

This is normally unnecessary, however.

## 9.2.1. Using the German Character Set

In MySQL 5.1, character set and collation are specified separately. This means that if you want German sort order, you should select the `latin1` character set and either the `latin1_german1_ci` or `latin1_german2_ci` collation. For example, to start the server with the `latin1_german1_ci` collation, use the `--character-set-server=latin1` and `--collation-server=latin1_german1_ci` options.

For information on the differences between these two collations, see [Section 9.1.12.2, “West European Character Sets”](#).

## 9.3. Setting the Error Message Language

By default, `mysqld` produces error messages in English, but they can also be displayed in any of these other languages: Czech, Danish, Dutch, Estonian, French, German, Greek, Hungarian, Italian, Japanese, Korean, Norwegian, Norwegian-ny, Polish, Portuguese, Romanian, Russian, Slovak, Spanish, or Swedish.

To start `mysqld` with a particular language for error messages, use the `--language` or `-L` option. The option value can be a language name or the full path to the error message file. For example:

```
shell> mysqld --language=swedish
```

Or:

```
shell> mysqld --language=/usr/local/share/swedish
```

The language name should be specified in lowercase.

By default, the language files are located in the `share/LANGUAGE` directory under the MySQL base directory.

You can also change the content of the error messages produced by the server. Details can be found in the MySQL Internals manual, available at [http://forge.mysql.com/wiki/MySQL\\_Internals\\_Error\\_Messages](http://forge.mysql.com/wiki/MySQL_Internals_Error_Messages). If you upgrade to a newer version of MySQL after changing the error messages, remember to repeat your changes after the upgrade.

## 9.4. Adding a New Character Set

This section discusses the procedure for adding a new character set to MySQL. You must have a MySQL source distribution to use these instructions. The proper procedure depends on whether the character set is simple or complex:

- If the character set does not need to use special string collating routines for sorting and does not need multi-byte character support, it is simple.
- If the character set needs either of those features, it is complex.

For example, `greek` and `swe7` are simple character sets, whereas `big5` and `czech` are complex character sets.

In the following instructions, `MYSET` represents the name of the character set that you want to add.

1. Add a `<charset>` element for `MYSET` to the `sql/share/charsets/Index.xml` file. Use the existing contents in the file as a guide to adding new contents.

The `<charset>` element must list all the collations for the character set. These must include at least a binary collation and a default collation. The default collation is usually named using a suffix of `general_ci` (general, case insensitive). It is possible for the binary collation to be the default collation, but usually they are different. The default collation should have a `primary` flag. The binary collation should have a `binary` flag.

You must assign a unique ID number to each collation, chosen from the range 1 to 254. To find the maximum of the currently used collation IDs, use this query:

```
SELECT MAX(ID) FROM INFORMATION_SCHEMA.COLLATIONS;
```

2. This step depends on whether you are adding a simple or complex character set. A simple character set requires only a configuration file, whereas a complex character set requires C source file that defines collation functions, multi-byte functions, or both.

For a simple character set, create a configuration file, `MYSET.xml`, that describes the character set properties. Create this file in the `sql/share/charsets` directory. (You can use a copy of `latin1.xml` as the basis for this file.) The syntax for the file is very simple:

- Comments are written as ordinary XML comments (`<!-- text -->`).
- Words within `<map>` array elements are separated by arbitrary amounts of whitespace.
- Each word within `<map>` array elements must be a number in hexadecimal format.
- The `<map>` array element for the `<ctype>` element has 257 words. The other `<map>` array elements after that have 256 words. See [Section 9.4.1, “The Character Definition Arrays”](#).
- For each collation listed in the `<charset>` element for the character set in `Index.xml`, `MYSET.xml` must contain a `<collation>` element that defines the character ordering.

For a complex character set, create a C source file that describes the character set properties and defines the support routines necessary to properly perform operations on the character set:

- Create the file `ctype-MYSET.c` in the `strings` directory. Look at one of the existing `ctype-*.c` files (such as `ctype-big5.c`) to see what needs to be defined. The arrays in your file must have names like `ctype_MYSET`, `to_lower_MYSET`, and so on. These correspond to the arrays for a simple character set. See [Section 9.4.1, “The Character Definition Arrays”](#).
  - For each collation listed in the `<charset>` element for the character set in `Index.xml`, the `ctype-MYSET.c` file must provide an implementation of the collation.
  - If you need string collating functions, see [Section 9.4.2, “String Collating Support”](#).
  - If you need multi-byte character support, see [Section 9.4.3, “Multi-Byte Character Support”](#).
- Follow these steps to modify the configuration information. Use the existing configuration information as a guide to adding information for `MYSYS`. The example here assumes that the character set has default and binary collations, but more lines will be needed if `MYSET` has additional collations.
    - Edit `mysys/charset-def.c`, and “register” the collations for the new character set.

Add these lines to the “declaration” section:

```
#ifndef HAVE_CHARSET_MYSET
extern CHARSET_INFO my_charset_MYSET_general_ci;
extern CHARSET_INFO my_charset_MYSET_bin;
#endif
```

Add these lines to the “registration” section:

```
#ifndef HAVE_CHARSET_MYSET
add_compiled_collation(&my_charset_MYSET_general_ci);
add_compiled_collation(&my_charset_MYSET_bin);
#endif
```

- If the character set uses `ctype-MYSET.c`, edit `strings/Makefile.am` and add `ctype-MYSET.c` to each definition of the `CSRCS` variable, and to the `EXTRA_DIST` variable.
  - If the character set uses `ctype-MYSET.c`, edit `libmysql/Makefile.shared` and add `ctype-MYSET.lo` to the `mystringsobjects` definition.
- Edit `config/ac-macros/character_sets.m4`:
    - Add `MYSET` to one of the `define(CHARSETS_AVAILABLE...)` lines in alphabetic order.
    - Add `MYSET` to `CHARSETS_COMPLEX`. This is needed even for simple character sets, or `configure` will not recognize `--with-charset=MYSET`.
    - Add `MYSET` to the first `case` control structure. Omit the `USE_MB` and `USE_MB_IDENT` lines for 8-bit character sets.

```
MYSET)
AC_DEFINE(HAVE_CHARSET_MYSET, 1, [Define to enable charset MYSET])
AC_DEFINE([USE_MB], 1, [Use multi-byte character routines])
AC_DEFINE(USE_MB_IDENT, 1)
;;
```

- Add `MYSET` to the second `case` control structure:

```
MYSET)
```



```
default_charset_default_collation="MYSET_general_ci"
default_charset_collations="MYSET_general_ci MYSET_bin"
;;
```

4. Reconfigure, recompile, and test.

## 9.4.1. The Character Definition Arrays

Each simple character set has a configuration file located in the `sql/shareCharsets` directory. The file is named `MYSET.xml`. It uses `<map>` array elements to list character set properties. `<map>` elements appear within these elements:

- `<ctype>` defines attributes for each character
- `<lower>` and `<upper>` list the lowercase and uppercase characters
- `<unicode>` maps 8-bit character values to Unicode values
- `<collation>` elements indicate character ordering for comparisons and sorts, one element per collation (binary collations need no `<map>` element because the character codes themselves provide the ordering)

For a complex character set as implemented in a `ctype-MYSET.c` file in the `strings` directory, there are corresponding arrays: `ctype_MYSET[]`, `to_lower_MYSET[]`, and so forth. Not every complex character set has all of the arrays. See the existing `ctype-*.c` files for examples. See the `CHARSET_INFO.txt` file in the `strings` directory for additional information.

The `ctype` array is indexed by character value + 1 and has 257 elements. This is an old legacy convention for handling EOF. The other arrays are indexed by character value and have 256 elements.

`ctype` array elements are bit values. Each element describes the attributes of a single character in the character set. Each attribute is associated with a bitmask, as defined in `include/m_ctype.h`:

```
#define _MY_U 01 /* Upper case */
#define _MY_L 02 /* Lower case */
#define _MY_NMR 04 /* Numeral (digit) */
#define _MY_SPC 010 /* Spacing character */
#define _MY_PNT 020 /* Punctuation */
#define _MY_CTR 040 /* Control character */
#define _MY_B 0100 /* Blank */
#define _MY_X 0200 /* hexadecimal digit */
```

The `ctype` value for a given character should be the union of the applicable bitmask values that describe the character. For example, 'A' is an uppercase character (`_MY_U`) as well as a hexadecimal digit (`_MY_X`), so its `ctype` value should be defined like this:

```
ctype['A'+1] = _MY_U | _MY_X = 01 | 0200 = 0201
```

The bitmask values in `m_ctype.h` are octal values, but the elements of the `ctype` array in `MYSET.xml` should be written as hexadecimal values.

The `lower` and `upper` arrays hold the lowercase and uppercase characters corresponding to each member of the character set. For example:

```
lower['A'] should contain 'a'
upper['a'] should contain 'A'
```

Each `collation` array is a map indicating how characters should be ordered for comparison and sorting purposes. MySQL sorts characters based on the values of this information. In some cases, this is the same as the `upper` array, which means that sorting is case-insensitive. For more complicated sorting rules (for complex character sets), see the discussion of string collating in [Section 9.4.2, "String Collating Support"](#).

## 9.4.2. String Collating Support

For simple character sets, sorting rules are specified in the `MYSET.xml` configuration file using `<map>` array elements within `<collation>` elements. If the sorting rules for your language are too complex to be handled with simple arrays, you need to define string collating functions in the `ctype-MYSET.c` source file in the `strings` directory.

The existing character sets provide the best documentation and examples to show how these functions are implemented. Look at

the `ctype-*.c` files in the `strings` directory, such as the files for the `big5`, `czech`, `gbk`, `sjis`, and `tis160` character sets. Take a look at the `MY_COLLATION_HANDLER` structures to see how they are used, and see the `CHARSET_INFO.txt` file in the `strings` directory for additional information.

### 9.4.3. Multi-Byte Character Support

If you want to add support for a new character set that includes multi-byte characters, you need to use multi-byte character functions in the `ctype-MYSET.c` source file in the `strings` directory.

The existing character sets provide the best documentation and examples to show how these functions are implemented. Look at the `ctype-*.c` files in the `strings` directory, such as the files for the `euc_kr`, `gb2312`, `gbk`, `sjis`, and `ujis` character sets. Take a look at the `MY_CHARSET_HANDLER` structures to see how they are used, and see the `CHARSET_INFO.txt` file in the `strings` directory for additional information.

## 9.5. How to Add a New Collation to a Character Set

A collation is a set of rules that defines how to compare and sort character strings. Each collation in MySQL belongs to a single character set. Every character set has at least one collation, and most have two or more collations.

A collation orders characters based on weights. Each character in a character set maps to a weight. Characters with equal weights compare as equal, and characters with unequal weights compare according to the relative magnitude of their weights.

MySQL supports several collation implementations, as discussed in [Section 9.5.1, “Collation Implementation Types”](#). Some of these can be added to MySQL without recompiling:

- Simple collations for 8-bit character sets
- UCA-based collations for Unicode character sets
- Binary (`xxx_bin`) collations

The following discussion describes how to add collations of the first two types to existing character sets. All existing character sets already have a binary collation, so there is no need here to describe how to add one.

Summary of the procedure for adding a new collation:

1. Choose a collation ID
2. Add configuration information that names the collation and describes the character-ordering rules
3. Restart the server
4. Verify that the collation is present

The instructions here cover only collations that can be added without recompiling MySQL. To add a collation that does require recompiling (as implemented by means of functions in a C source file), use the instructions in [Section 9.4, “Adding a New Character Set”](#). However, instead of adding all the information required for a complete character set, just modify the appropriate files for an existing character set. That is, based on what is already present for the character set's current collations, add new data structures, functions, and configuration information for the new collation. For an example, see the MySQL Blog article in the following list of additional resources.

#### Additional resources

- The Unicode Collation Algorithm (UCA) specification: <http://www.unicode.org/reports/tr10/>
- The Locale Data Markup Language (LDML) specification: <http://www.unicode.org/reports/tr35/>
- MySQL University session “How to Add a Collation”: [http://forge.mysql.com/wiki/How\\_to\\_Add\\_a\\_Collation](http://forge.mysql.com/wiki/How_to_Add_a_Collation)
- MySQL Blog article “Instructions for adding a new Unicode collation”: <http://blogs.mysql.com/peterg/2008/05/19/instructions-for-adding-a-new-unicode-collation/>

### 9.5.1. Collation Implementation Types

MySQL implements several types of collations:

### Simple collations for 8-bit character sets

This kind of collation is implemented using an array of 256 weights that defines a one-to-one mapping from character codes to weights. `latin1_swedish_ci` is an example. It is a case-insensitive collation, so the uppercase and lowercase versions of a character have the same weights and they compare as equal.

```
mysql> SET NAMES 'latin1' COLLATE 'latin1_swedish_ci';
Query OK, 0 rows affected (0.00 sec)

mysql> SELECT 'a' = 'A';
+-----+
| 'a' = 'A' |
+-----+
|          1 |
+-----+
1 row in set (0.00 sec)
```

### Complex collations for 8-bit character sets

This kind of collation is implemented using functions in a C source file that define how to order characters, as described in [Section 9.4, “Adding a New Character Set”](#).

### Collations for non-Unicode multi-byte character sets

For this type of collation, 8-bit (single-byte) and multi-byte characters are handled differently. For 8-bit characters, character codes map to weights in case-insensitive fashion. (For example, the single-byte characters 'a' and 'A' both have a weight of `0x41`.) For multi-byte characters, there are two types of relationship between character codes and weights:

- Weights equal character codes. `sjis_japanese_ci` is an example of this kind of collation. The multi-byte character 'ぢ' has a character code of `0x82C0`, and the weight is also `0x82C0`.
- Character codes map one-to-one to weights, but a code is not necessarily equal to the weight. `gbk_chinese_ci` is an example of this kind of collation. The multi-byte character '腦' has a character code of `0x81B0` but a weight of `0xC286`.

### Collations for Unicode multi-byte character sets

Some of these collations are based on the Unicode Collation Algorithm (UCA), others are not.

Non-UCA collations have a one-to-one mapping from character code to weight. In MySQL, such collations are case insensitive and accent insensitive. `utf8_general_ci` is an example: 'a', 'A', 'À', and 'á' each have different character codes but all have a weight of `0x0041` and compare as equal.

```
mysql> SET NAMES 'utf8' COLLATE 'utf8_general_ci';
Query OK, 0 rows affected (0.00 sec)

mysql> SELECT 'a' = 'A', 'a' = 'À', 'a' = 'á';
+-----+-----+-----+
| 'a' = 'A' | 'a' = 'À' | 'a' = 'á' |
+-----+-----+-----+
|          1 |          1 |          1 |
+-----+-----+-----+
1 row in set (0.06 sec)
```

UCA-based collations in MySQL have these properties:

- If a character has weights, each weight uses 2 bytes (16 bits)
- A character may have zero weights (or an empty weight). In this case, the character is ignorable. Example: "U+0000 NULL" does not have a weight and is ignorable.
- A character may have one weight. Example: 'a' has a weight of `0x00E33`.
- A character may have many weights. This is an expansion. Example: The German letter 'ß' (SZ LEAGUE, or SHARP S) has a weight of `0x0FEA0FEA`.
- Many characters may have one weight. This is a contraction. Example: 'ch' is a single letter in Czech and has a weight of `0x0EE2`.

A many-characters-to-many-weights mapping is also possible (this is contraction with expansion), but is not supported by MySQL.

### Miscellaneous collations

There are also a few collations that do not fall into any of the previous categories.

## 9.5.2. Choosing a Collation ID

Each collation must have a unique ID. To add a new collation, you must choose an ID value that is not currently used. The value must be in the range from 1 to 254. The collation ID that you choose will show up in these contexts:

- The `Id` column of `SHOW COLLATION` output
- The `ID` column of the `INFORMATION_SCHEMA.COLLATIONS` table
- The `charsetnr` member of the `MYSQL_FIELD` C API data structure
- The `number` member of the `MY_CHARSET_INFO` data structure returned by the `mysql_get_character_set_info()` C API function

To determine the largest currently used ID, issue the following statement:

```
mysql> SELECT MAX(ID) FROM INFORMATION_SCHEMA.COLLATIONS;
+-----+
| MAX(ID) |
+-----+
|      210 |
+-----+
```

For the output just shown, you could choose an ID higher than 210 for the new collation.

To display a list of all currently used IDs, issue this statement:

```
mysql> SELECT ID FROM INFORMATION_SCHEMA.COLLATIONS ORDER BY ID;
+-----+
| ID |
+-----+
| 1 |
| 2 |
| .. |
| 52 |
| 53 |
| 57 |
| 58 |
| .. |
| 98 |
| 99 |
| 128 |
| 129 |
| .. |
| 210 |
+-----+
```

In this case, you can either choose an unused ID from within the current range of IDs, or choose an ID that is higher than the current maximum ID. For example, in the output just shown, there are unused IDs between 53 and 57, and between 99 and 128. Or you could choose an ID higher than 210.

### Warning

If you upgrade MySQL, you may find that the collation ID you choose has been assigned to a collation included in the new MySQL distribution. In this case, you will need to choose a new value for your own collation.

In addition, before upgrading, you should save the configuration files that you change. If you upgrade in place, the process will replace the your modified files.

## 9.5.3. Adding a Simple Collation to an 8-Bit Character Set

To add a simple collation for an 8-bit character set without recompiling MySQL, use the following procedure. The example adds a collation named `latin1_test_ci` to the `latin1` character set.

1. Choose a collation ID, as shown in [Section 9.5.2, “Choosing a Collation ID”](#). The following steps use an ID of 56.
2. You will need to modify the `index.xml` and `latin1.xml` configuration files. These files will be located in the directory named by the `character_sets_dir` system variable. You can check the variable value as follows, although the path

name might be different on your system:

```
mysql> SHOW VARIABLES LIKE 'character_sets_dir';
+-----+-----+
| Variable_name | Value                               |
+-----+-----+
| character_sets_dir | /user/local/mysql/share/mysql/charsets/ |
+-----+-----+
```

3. Choose a name for the collation and list it in the `Index.xml` file. Find the `<charset>` element for the character set to which the collation is being added, and add a `<collation>` element that indicates the collation name and ID. For example:

```
<charset name="latin1">
  ...
  <!-- associate collation name with its ID -->
  <collation name="latin1_test_ci" id="56"/>
  ...
</charset>
```

4. In the `latin1.xml` configuration file, add a `<collation>` element that names the collation and that contains a `<map>` element that defines a character code-to-weight mapping table. Each word within the `<map>` element must be a number in hexadecimal format.

```
<collation name="latin1_test_ci">
<map>
00 01 02 03 04 05 06 07 08 09 0A 0B 0C 0D 0E 0F
10 11 12 13 14 15 16 17 18 19 1A 1B 1C 1D 1E 1F
20 21 22 23 24 25 26 27 28 29 2A 2B 2C 2D 2E 2F
30 31 32 33 34 35 36 37 38 39 3A 3B 3C 3D 3E 3F
40 41 42 43 44 45 46 47 48 49 4A 4B 4C 4D 4E 4F
50 51 52 53 54 55 56 57 58 59 5A 5B 5C 5D 5E 5F
60 41 42 43 44 45 46 47 48 49 4A 4B 4C 4D 4E 4F
50 51 52 53 54 55 56 57 58 59 5A 7B 7C 7D 7E 7F
80 81 82 83 84 85 86 87 88 89 8A 8B 8C 8D 8E 8F
90 91 92 93 94 95 96 97 98 99 9A 9B 9C 9D 9E 9F
A0 A1 A2 A3 A4 A5 A6 A7 A8 A9 AA AB AC AD AE AF
B0 B1 B2 B3 B4 B5 B6 B7 B8 B9 BA BB BC BD BE BF
41 41 41 41 5B 5D 5B 43 45 45 45 45 49 49 49 49
44 4E 4F 4F 4F 4F 5C D7 5C 55 55 55 59 59 59 59
41 41 41 41 5B 5D 5B 43 45 45 45 45 49 49 49 49
44 4E 4F 4F 4F 4F 5C F7 5C 55 55 55 59 59 59 59
</map>
</collation>
```

5. Restart the server and use this statement to verify that the collation is present:

```
mysql> SHOW COLLATION LIKE 'latin1_test_ci';
+-----+-----+-----+-----+-----+-----+
| Collation | Charset | Id | Default | Compiled | Sortlen |
+-----+-----+-----+-----+-----+-----+
| latin1_test_ci | latin1 | 56 | | | 1 |
+-----+-----+-----+-----+-----+-----+
```

## 9.5.4. Adding a UCA Collation to a Unicode Character Set

UCA collations for Unicode character sets can be added to MySQL without recompiling by using a subset of the Locale Data Markup Language (LDML), which is available at <http://www.unicode.org/reports/tr35/>. In 5.1, this method of adding collations is supported as of MySQL 5.1.20. With this method, you begin with an existing “base” collation. Then you describe the new collation in terms of how it differs from the base collation, rather than defining the entire collation. The following table lists the base collations for the Unicode character sets.

Character Set	Base Collation
utf8	utf8_unicode_ci
ucs2	ucs2_unicode_ci

The following brief summary describes the LDML characteristics required for understanding the procedure for adding a collation given later in this section:

- LDML has reset rules and shift rules.
- Characters named in these rules can be written in `\unnnn` format, where `nnnn` is the hexadecimal Unicode code point value. Basic Latin letters `A-Z` and `a-z` can also be written literally (this is a MySQL limitation; the LDML specification allows literal non-Latin1 characters in the rules). Only characters in the Basic Multilingual Plane can be specified. This notation does not ap-

ply to characters outside the BMP range of 0000 to FFFF.

- A reset rule does not specify any ordering in and of itself. Instead, it “resets” the ordering for subsequent shift rules to cause them to be taken in relation to a given character. Either of the following rules resets subsequent shift rules to be taken in relation to the letter 'A':

```
<reset>A</reset>
<reset>\u0041</reset>
```

- Shift rules define primary, secondary, and tertiary differences of a character from another character. They are specified using <p>, <s>, and <t> elements. Either of the following rules specifies a primary shift rule for the 'G' character:

```
<p>G</p>
<p>\u0047</p>
```

- Use primary differences to distinguish separate letters.
- Use secondary differences to distinguish accent variations.
- Use tertiary differences to distinguish lettercase variations.

To add a UCA collation for a Unicode character set without recompiling MySQL, use the following procedure. The example adds a collation named `utf8_phone_ci` to the `utf8` character set. The collation is designed for a scenario involving a Web application for which users post their names and phone numbers. Phone numbers can be given in very different formats:

```
+7-12345-67
+7-12-345-67
+7 12 345 67
+7 (12) 345 67
+71234567
```

The problem raised by dealing with these kinds of values is that the varying allowable formats make searching for a specific phone number very difficult. The solution is to define a new collation that reorders punctuation characters, making them ignorable.

1. Choose a collation ID, as shown in [Section 9.5.2, “Choosing a Collation ID”](#). The following steps use an ID of 252.
2. You will need to modify the `Index.xml` configuration file. This file will be located in the directory named by the `character_sets_dir` system variable. You can check the variable value as follows, although the path name might be different on your system:

```
mysql> SHOW VARIABLES LIKE 'character_sets_dir';
+-----+-----+
| Variable_name | Value                               |
+-----+-----+
| character_sets_dir | /user/local/mysql/share/mysql/charsets/ |
+-----+-----+
```

3. Choose a name for the collation and list it in the `Index.xml` file. In addition, you'll need to provide the collation ordering rules. Find the `<charset>` element for the character set to which the collation is being added, and add a `<collation>` element that indicates the collation name and ID. Within the `<collation>` element, provide a `<rules>` element containing the ordering rules:

```
<charset name="utf8">
...
<!-- associate collation name with its ID -->
<collation name="utf8_phone_ci" id="252">
  <rules>
    <reset>\u0000</reset>
    <s>\u0020</s> <!-- space -->
    <s>\u0028</s> <!-- left parenthesis -->
    <s>\u0029</s> <!-- right parenthesis -->
    <s>\u002B</s> <!-- plus -->
    <s>\u002D</s> <!-- hyphen -->
  </rules>
</collation>
...
</charset>
```

4. If you want a similar collation for other Unicode character sets, add other `<collation>` elements. For example, to define `ucs2_phone_ci`, add a `<collation>` element to the `<charset name="ucs2">` element. Remember that each collation must have its own unique ID.

5. Restart the server and use this statement to verify that the collation is present:

```
mysql> SHOW COLLATION LIKE 'utf8_phone_ci';
```

Collation	Charset	Id	Default	Compiled	Sortlen
utf8_phone_ci	utf8	252			8

Now we can test the collation to make sure that it has the desired properties.

Create a table containing some sample phone numbers using the new collation:

```
mysql> CREATE TABLE phonebook (
->   name VARCHAR(64),
->   phone VARCHAR(64) CHARACTER SET utf8 COLLATE utf8_phone_ci
-> );
Query OK, 0 rows affected (0.09 sec)

mysql> INSERT INTO phonebook VALUES ('Svoj','+7 912 800 80 02');
Query OK, 1 row affected (0.00 sec)

mysql> INSERT INTO phonebook VALUES ('Hf','+7 (912) 800 80 04');
Query OK, 1 row affected (0.00 sec)

mysql> INSERT INTO phonebook VALUES ('Bar','+7-912-800-80-01');
Query OK, 1 row affected (0.00 sec)

mysql> INSERT INTO phonebook VALUES ('Ramil','(7912) 800 80 03');
Query OK, 1 row affected (0.00 sec)

mysql> INSERT INTO phonebook VALUES ('Sanja','+380 (912) 8008005');
Query OK, 1 row affected (0.00 sec)
```

Run some queries to see whether the ignored punctuation characters are in fact ignored for sorting and comparisons:

```
mysql> SELECT * FROM phonebook ORDER BY phone;
```

name	phone
Sanja	+380 (912) 8008005
Bar	+7-912-800-80-01
Svoj	+7 912 800 80 02
Ramil	(7912) 800 80 03
Hf	+7 (912) 800 80 04

5 rows in set (0.00 sec)

```
mysql> SELECT * FROM phonebook WHERE phone='+7(912)800-80-01';
```

name	phone
Bar	+7-912-800-80-01

1 row in set (0.00 sec)

```
mysql> SELECT * FROM phonebook WHERE phone='79128008001';
```

name	phone
Bar	+7-912-800-80-01

1 row in set (0.00 sec)

```
mysql> SELECT * FROM phonebook WHERE phone='7 9 1 2 8 0 0 8 0 0 1';
```

name	phone
Bar	+7-912-800-80-01

1 row in set (0.00 sec)

## 9.6. Problems With Character Sets

If you try to use a character set that is not compiled into your binary, you might run into the following problems:

- Your program uses an incorrect path to determine where the character sets are stored (which is typically the `share/mysql/charsets` or `share/charsets` directory under the MySQL installation directory). This can be fixed by using the `--character-sets-dir` option when you run the program in question. For example, to specify a directory to be used by MySQL client programs, list it in the `[client]` group of your option file. The examples given here show what the setting might look like for Unix or Windows, respectively:

```
[client]
```

```
character-sets-dir=/usr/local/mysql/share/mysql/charsets
[client]
character-sets-dir="C:/Program Files/MySQL/MySQL Server 5.1/share/charsets"
```

- The character set is a complex character set that cannot be loaded dynamically. In this case, you must recompile the program with support for the character set.

For Unicode character sets, you can define collations without recompiling by using LDML notation. See [Section 9.5.4, “Adding a UCA Collation to a Unicode Character Set”](#).

- The character set is a dynamic character set, but you do not have a configuration file for it. In this case, you should install the configuration file for the character set from a new MySQL distribution.
- If your character set index file does not contain the name for the character set, your program displays an error message. The file is named `Index.xml` and the message is:

```
Character set 'charset_name' is not a compiled character set and is not
specified in the '/usr/share/mysql/charsets/Index.xml' file
```

To solve this problem, you should either get a new index file or manually add the name of any missing character sets to the current file.

For `MyISAM` tables, you can check the character set name and number for a table with `myisamchk -dvv tbl_name`.

## 9.7. MySQL Server Time Zone Support

The MySQL server maintains several time zone settings:

- The system time zone. When the server starts, it attempts to determine the time zone of the host machine and uses it to set the `system_time_zone` system variable. The value does not change thereafter.

You can set the system time zone for MySQL Server at startup with the `--timezone=timezone_name` option to `mysqld_safe`. You can also set it by setting the `TZ` environment variable before you start `mysqld`. The allowable values for `--timezone` or `TZ` are system-dependent. Consult your operating system documentation to see what values are acceptable.

- The server's current time zone. The global `time_zone` system variable indicates the time zone the server currently is operating in. The initial value for `time_zone` is `'SYSTEM'`, which indicates that the server time zone is the same as the system time zone.

The initial global server time zone value can be specified explicitly at startup with the `--default-time-zone=timezone` option on the command line, or you can use the following line in an option file:

```
default-time-zone='timezone'
```

If you have the `SUPER` privilege, you can set the global server time zone value at runtime with this statement:

```
mysql> SET GLOBAL time_zone = timezone;
```

- Per-connection time zones. Each client that connects has its own time zone setting, given by the session `time_zone` variable. Initially, the session variable takes its value from the global `time_zone` variable, but the client can change its own time zone with this statement:

```
mysql> SET time_zone = timezone;
```

The current session time zone setting affects display and storage of time values that are zone-sensitive. This includes the values displayed by functions such as `NOW()` or `CURTIME()`, and values stored in and retrieved from `TIMESTAMP` columns. Values for `TIMESTAMP` columns are converted from the current time zone to UTC for storage, and from UTC to the current time zone for retrieval.

The current time zone setting does not affect values displayed by functions such as `UTC_TIMESTAMP()` or values in `DATE`, `TIME`, or `DATETIME` columns. Nor are values in those data types stored in UTC; the time zone applies for them only when converting from `TIMESTAMP` values. If you want locale-specific arithmetic for `DATE`, `TIME`, or `DATETIME` values, convert them to UTC, perform the arithmetic, and then convert back.



The current values of the global and client-specific time zones can be retrieved like this:

```
mysql> SELECT @@global.time_zone, @@session.time_zone;
```

`timezone` values can be given in several formats, none of which are case sensitive:

- The value `'SYSTEM'` indicates that the time zone should be the same as the system time zone.
- The value can be given as a string indicating an offset from UTC, such as `'+10:00'` or `'-6:00'`.
- The value can be given as a named time zone, such as `'Europe/Helsinki'`, `'US/Eastern'`, or `'MET'`. Named time zones can be used only if the time zone information tables in the `mysql` database have been created and populated.

The MySQL installation procedure creates the time zone tables in the `mysql` database, but does not load them. You must do so manually using the following instructions. (If you are upgrading to MySQL 4.1.3 or later from an earlier version, you can create the tables by upgrading your `mysql` database. Use the instructions in [Section 4.4.8, “mysql\\_upgrade — Check Tables for MySQL Upgrade”](#). After creating the tables, you can load them.)

### Note

Loading the time zone information is not necessarily a one-time operation because the information changes occasionally. For example, the rules for Daylight Saving Time in the United States, Mexico, and parts of Canada changed in 2007. When such changes occur, applications that use the old rules become out of date and you may find it necessary to reload the time zone tables to keep the information used by your MySQL server current. See the notes at the end of this section.

If your system has its own `zoneinfo` database (the set of files describing time zones), you should use the `mysql_tzinfo_to_sql` program for filling the time zone tables. Examples of such systems are Linux, FreeBSD, Sun Solaris, and Mac OS X. One likely location for these files is the `/usr/share/zoneinfo` directory. If your system does not have a `zoneinfo` database, you can use the downloadable package described later in this section.

The `mysql_tzinfo_to_sql` program is used to load the time zone tables. On the command line, pass the `zoneinfo` directory path name to `mysql_tzinfo_to_sql` and send the output into the `mysql` program. For example:

```
shell> mysql_tzinfo_to_sql /usr/share/zoneinfo | mysql -u root mysql
```

`mysql_tzinfo_to_sql` reads your system's time zone files and generates SQL statements from them. `mysql` processes those statements to load the time zone tables.

`mysql_tzinfo_to_sql` also can be used to load a single time zone file or to generate leap second information:

- To load a single time zone file `tz_file` that corresponds to a time zone name `tz_name`, invoke `mysql_tzinfo_to_sql` like this:

```
shell> mysql_tzinfo_to_sql tz_file tz_name | mysql -u root mysql
```

With this approach, you must execute a separate command to load the time zone file for each named zone that the server needs to know about.

- If your time zone needs to account for leap seconds, initialize the leap second information like this, where `tz_file` is the name of your time zone file:

```
shell> mysql_tzinfo_to_sql --leap tz_file | mysql -u root mysql
```

- After running `mysql_tzinfo_to_sql`, it is best to restart the server so that it does not continue to use any previously cached time zone data.

If your system is one that has no `zoneinfo` database (for example, Windows or HP-UX), you can use the package of pre-built time zone tables that is available for download at the MySQL Developer Zone:

```
http://dev.mysql.com/downloads/timezones.html
```

This time zone package contains `.frm`, `.MYD`, and `.MYI` files for the `MyISAM` time zone tables. These tables should be part of the `mysql` database, so you should place the files in the `mysql` subdirectory of your MySQL server's data directory. The server should be stopped while you do this and restarted afterward.

**Warning**

Do not use the downloadable package if your system has a zoneinfo database. Use the `mysql_tzinfo_to_sql` utility instead. Otherwise, you may cause a difference in datetime handling between MySQL and other applications on your system.

For information about time zone settings in replication setup, please see [Section 16.3.1, “Replication Features and Issues”](#).

## 9.7.1. Staying Current with Time Zone Changes

As mentioned earlier, when the time zone rules change, applications that use the old rules become out of date. To stay current, it is necessary to make sure that your system uses current time zone information is used. For MySQL, there are two factors to consider in staying current:

- The operating system time affects the value that the MySQL server uses for times if its time zone is set to `SYSTEM`. Make sure that your operating system is using the latest time zone information. For most operating systems, the latest update or service pack prepares your system for the time changes. Check the Web site for your operating system vendor for an update that addresses the time changes.
- If you replace the system's `/etc/localtime` timezone file with a version that uses rules differing from those in effect at `mysqld` startup, you should restart `mysqld` so that it uses the updated rules. Otherwise, `mysqld` might not notice when the system changes its time.
- If you use named time zones with MySQL, make sure that the time zone tables in the `mysql` database are up to date. If your system has its own zoneinfo database, you should reload the MySQL time zone tables whenever the zoneinfo database is updated, using the instructions given earlier in this section. For systems that do not have their own zoneinfo database, check the MySQL Developer Zone for updates. When a new update is available, download it and use it to replace your current time zone tables. `mysqld` caches time zone information that it looks up, so after replacing the time zone tables, you should restart `mysqld` to make sure that it does not continue to serve outdated time zone data.

If you are uncertain whether named time zones are available, for use either as the server's time zone setting or by clients that set their own time zone, check whether your time zone tables are empty. The following query determines whether the table that contains time zone names has any rows:

```
mysql> SELECT COUNT(*) FROM mysql.time_zone_name;
+-----+
| COUNT(*) |
+-----+
|          0 |
+-----+
```

A count of zero indicates that the table is empty. In this case, no one can be using named time zones, and you don't need to update the tables. A count greater than zero indicates that the table is not empty and that its contents are available to be used for named time zone support. In this case, you should be sure to reload your time zone tables so that anyone who uses named time zones will get correct query results.

To check whether your MySQL installation is updated properly for a change in Daylight Saving Time rules, use a test like the one following. The example uses values that are appropriate for the 2007 DST 1-hour change that occurs in the United States on March 11 at 2 a.m.

The test uses these two queries:

```
SELECT CONVERT_TZ('2007-03-11 2:00:00', 'US/Eastern', 'US/Central');
SELECT CONVERT_TZ('2007-03-11 3:00:00', 'US/Eastern', 'US/Central');
```

The two time values indicate the times at which the DST change occurs, and the use of named time zones requires that the time zone tables be used. The desired result is that both queries return the same result (the input time, converted to the equivalent value in the 'US/Central' time zone).

Before updating the time zone tables, you would see an incorrect result like this:

```
mysql> SELECT CONVERT_TZ('2007-03-11 2:00:00', 'US/Eastern', 'US/Central');
+-----+
| CONVERT_TZ('2007-03-11 2:00:00', 'US/Eastern', 'US/Central') |
+-----+
| 2007-03-11 01:00:00 |
+-----+

mysql> SELECT CONVERT_TZ('2007-03-11 3:00:00', 'US/Eastern', 'US/Central');
+-----+
| CONVERT_TZ('2007-03-11 3:00:00', 'US/Eastern', 'US/Central') |
+-----+
```

```
| 2007-03-11 02:00:00 |
+-----+-----+
```

After updating the tables, you should see the correct result:

```
mysql> SELECT CONVERT_TZ('2007-03-11 2:00:00','US/Eastern','US/Central');
+-----+-----+
| CONVERT_TZ('2007-03-11 2:00:00','US/Eastern','US/Central') |
+-----+-----+
| 2007-03-11 01:00:00 |
+-----+-----+

mysql> SELECT CONVERT_TZ('2007-03-11 3:00:00','US/Eastern','US/Central');
+-----+-----+
| CONVERT_TZ('2007-03-11 3:00:00','US/Eastern','US/Central') |
+-----+-----+
| 2007-03-11 01:00:00 |
+-----+-----+
```

## 9.7.2. Time Zone Leap Second Support

Before MySQL 5.1.31, if the operating system is configured to return leap seconds from OS time calls or if the MySQL server uses a time zone definition that has leap seconds, functions such as `NOW()` could return a value having a time part that ends with `:59:60` or `:59:61`. If such values are inserted into a table, they would be dumped as is by `mysqldump` but considered invalid when reloaded, leading to backup/restore problems.

As of MySQL 5.1.31, leap second values are returned with a time part that ends with `:59:59`. This means that a function such as `NOW()` can return the same value for two or three consecutive seconds during the leap second. It remains true that literal temporal values having a time part that ends with `:59:60` or `:59:61` are considered invalid.

If it is necessary to search for `TIMESTAMP` values one second before the leap second, anomalous results may be obtained if you use a comparison with `'YYYY-MM-DD hh:mm:ss'` values:

```
mysql> CREATE TABLE t1 (a INT, ts TIMESTAMP DEFAULT NOW(), PRIMARY KEY (ts));
Query OK, 0 rows affected (0.11 sec)

mysql> # Simulate NOW() = '2009-01-01 02:59:59'
mysql> SET timestamp = 1230768022;
Query OK, 0 rows affected (0.00 sec)

mysql> INSERT INTO t1 (a) VALUES (1);
Query OK, 1 row affected (0.07 sec)

mysql> # Simulate NOW() = '2009-01-01 02:59:60'
mysql> SET timestamp = 1230768023;
Query OK, 0 rows affected (0.00 sec)

mysql> INSERT INTO t1 (a) VALUES (2);
Query OK, 1 row affected (0.02 sec)

mysql> SELECT * FROM t1;
+-----+-----+
| a | ts |
+-----+-----+
| 1 | 2008-12-31 18:00:22 |
| 2 | 2008-12-31 18:00:23 |
+-----+-----+
2 rows in set (0.02 sec)

mysql> SELECT * FROM t1 WHERE ts = '2009-01-01 02:59:59';
Empty set (0.03 sec)
```

To work around this, you can use a comparison based on the UTC value actually stored in column, which has the leap second correction applied:

```
mysql> SELECT * FROM t1 WHERE UNIX_TIMESTAMP(ts) = 1230768023;
+-----+-----+
| a | ts |
+-----+-----+
| 2 | 2008-12-31 18:00:23 |
+-----+-----+
1 row in set (0.02 sec)
```

## 9.8. MySQL Server Locale Support

Beginning with MySQL 5.1.12, the locale indicated by the `lc_time_names` system variable controls the language used to display day and month names and abbreviations. This variable affects the output from the `DATE_FORMAT()`, `DAYNAME()` and `MONTHNAME()` functions.

Locale names are POSIX-style values such as `'ja_JP'` or `'pt_BR'`. The default value is `'en_US'` regardless of your system's locale setting, but you can set the value at server startup or set the `GLOBAL` value if you have the `SUPER` privilege. Any client can

examine the value of `lc_time_names` or set its `SESSION` value to affect the locale for its own connection.

```
mysql> SET NAMES 'utf8';
Query OK, 0 rows affected (0.09 sec)

mysql> SELECT @@lc_time_names;
+-----+
| @@lc_time_names |
+-----+
| en_US           |
+-----+
1 row in set (0.00 sec)

mysql> SELECT DAYNAME('2010-01-01'), MONTHNAME('2010-01-01');
+-----+-----+
| DAYNAME('2010-01-01') | MONTHNAME('2010-01-01') |
+-----+-----+
| Friday                | January                  |
+-----+-----+
1 row in set (0.00 sec)

mysql> SELECT DATE_FORMAT('2010-01-01','%W %a %M %b');
+-----+
| DATE_FORMAT('2010-01-01','%W %a %M %b') |
+-----+
| Friday Fri January Jan                  |
+-----+
1 row in set (0.00 sec)

mysql> SET lc_time_names = 'es_MX';
Query OK, 0 rows affected (0.00 sec)

mysql> SELECT @@lc_time_names;
+-----+
| @@lc_time_names |
+-----+
| es_MX           |
+-----+
1 row in set (0.00 sec)

mysql> SELECT DAYNAME('2010-01-01'), MONTHNAME('2010-01-01');
+-----+-----+
| DAYNAME('2010-01-01') | MONTHNAME('2010-01-01') |
+-----+-----+
| viernes                | enero                    |
+-----+-----+
1 row in set (0.00 sec)

mysql> SELECT DATE_FORMAT('2010-01-01','%W %a %M %b');
+-----+
| DATE_FORMAT('2010-01-01','%W %a %M %b') |
+-----+
| viernes vie enero ene                    |
+-----+
1 row in set (0.00 sec)
```

The day or month name for each of the affected functions is converted from `utf8` to the character set indicated by the `character_set_connection` system variable.

`lc_time_names` may be set to any of the following locale values.

<code>ar_AE</code> : Arabic - United Arab Emirates	<code>ar_BH</code> : Arabic - Bahrain
<code>ar_DZ</code> : Arabic - Algeria	<code>ar_EG</code> : Arabic - Egypt
<code>ar_IN</code> : Arabic - Iran	<code>ar_IQ</code> : Arabic - Iraq
<code>ar_JO</code> : Arabic - Jordan	<code>ar_KW</code> : Arabic - Kuwait
<code>ar_LB</code> : Arabic - Lebanon	<code>ar_LY</code> : Arabic - Libya
<code>ar_MA</code> : Arabic - Morocco	<code>ar_OM</code> : Arabic - Oman
<code>ar_QA</code> : Arabic - Qatar	<code>ar_SA</code> : Arabic - Saudi Arabia
<code>ar_SD</code> : Arabic - Sudan	<code>ar_SY</code> : Arabic - Syria
<code>ar_TN</code> : Arabic - Tunisia	<code>ar_YE</code> : Arabic - Yemen
<code>be_BY</code> : Belarusian - Belarus	<code>bg_BG</code> : Bulgarian - Bulgaria
<code>ca_ES</code> : Catalan - Catalan	<code>cs_CZ</code> : Czech - Czech Republic
<code>da_DK</code> : Danish - Denmark	<code>de_AT</code> : German - Austria
<code>de_BE</code> : German - Belgium	<code>de_CH</code> : German - Switzerland
<code>de_DE</code> : German - Germany	<code>de_LU</code> : German - Luxembourg
<code>EE</code> : Estonian - Estonia	<code>en_AU</code> : English - Australia
<code>en_CA</code> : English - Canada	<code>en_GB</code> : English - United Kingdom
<code>en_IN</code> : English - India	<code>en_NZ</code> : English - New Zealand

en_PH: English - Philippines	en_US: English - United States
en_ZA: English - South Africa	en_ZW: English - Zimbabwe
es_AR: Spanish - Argentina	es_BO: Spanish - Bolivia
es_CL: Spanish - Chile	es_CO: Spanish - Columbia
es_CR: Spanish - Costa Rica	es_DO: Spanish - Dominican Republic
es_EC: Spanish - Ecuador	es_ES: Spanish - Spain
es_GT: Spanish - Guatemala	es_HN: Spanish - Honduras
es_MX: Spanish - Mexico	es_NI: Spanish - Nicaragua
es_PA: Spanish - Panama	es_PE: Spanish - Peru
es_PR: Spanish - Puerto Rico	es_PY: Spanish - Paraguay
es_SV: Spanish - El Salvador	es_US: Spanish - United States
es_UY: Spanish - Uruguay	es_VE: Spanish - Venezuela
eu_ES: Basque - Basque	fi_FI: Finnish - Finland
fo_FO: Faroese - Faroe Islands	fr_BE: French - Belgium
fr_CA: French - Canada	fr_CH: French - Switzerland
fr_FR: French - France	fr_LU: French - Luxembourg
gl_ES: Galician - Galician	gu_IN: Gujarati - India
he_IL: Hebrew - Israel	hi_IN: Hindi - India
hr_HR: Croatian - Croatia	hu_HU: Hungarian - Hungary
id_ID: Indonesian - Indonesia	is_IS: Icelandic - Iceland
it_CH: Italian - Switzerland	it_IT: Italian - Italy
ja_JP: Japanese - Japan	ko_KR: Korean - Korea
lt_LT: Lithuanian - Lithuania	lv_LV: Latvian - Latvia
mk_MK: Macedonian - FYROM	mn_MN: Mongolia - Mongolian
ms_MY: Malay - Malaysia	nb_NO: Norwegian(Bokml) - Norway
nl_BE: Dutch - Belgium	nl_NL: Dutch - The Netherlands
no_NO: Norwegian - Norway	pl_PL: Polish - Poland
pt_BR: Portugese - Brazil	pt_PT: Portugese - Portugal
ro_RO: Romanian - Romania	ru_RU: Russian - Russia
ru_UA: Russian - Ukraine	sk_SK: Slovak - Slovakia
sl_SI: Slovenian - Slovenia	sq_AL: Albanian - Albania
sr_YU: Serbian - Yugoslavia	sv_FI: Swedish - Finland
sv_SE: Swedish - Sweden	ta_IN: Tamil - India
te_IN: Telugu - India	th_TH: Thai - Thailand
tr_TR: Turkish - Turkey	uk_UA: Ukrainian - Ukraine
ur_PK: Urdu - Pakistan	vi_VN: Vietnamese - Vietnam
zh_CN: Chinese - Peoples Republic of China	zh_HK: Chinese - Hong Kong SAR
zh_TW: Chinese - Taiwan	

lc\_time\_names currently does not affect the STR\_TO\_DATE ( ) or GET\_FORMAT ( ) function.

---

# Chapter 10. Data Types

MySQL supports a number of data types in several categories: numeric types, date and time types, and string (character) types. This chapter first gives an overview of these data types, and then provides a more detailed description of the properties of the types in each category, and a summary of the data type storage requirements. The initial overview is intentionally brief. The more detailed descriptions later in the chapter should be consulted for additional information about particular data types, such as the allowable formats in which you can specify values.

MySQL also supports extensions for handling spatial data. [Section 11.13, “Spatial Extensions”](#), provides information about these data types.

Data type descriptions use these conventions:

- *M* indicates the maximum display width for integer types. For floating-point and fixed-point types, *M* is the total number of digits that can be stored. For string types, *M* is the maximum length. The maximum allowable value of *M* depends on the data type.
- *D* applies to floating-point and fixed-point types and indicates the number of digits following the decimal point. The maximum possible value is 30, but should be no greater than *M*–2.
- Square brackets (“[” and “]”) indicate optional parts of type definitions.

## 10.1. Data Type Overview

### 10.1.1. Overview of Numeric Types

A summary of the numeric data types follows. For additional information about properties of the numeric types, see [Section 10.2, “Numeric Types”](#). Storage requirements are given in [Section 10.5, “Data Type Storage Requirements”](#).

*M* indicates the maximum display width for integer types. The maximum legal display width is 255. Display width is unrelated to the range of values a type can contain, as described in [Section 10.2, “Numeric Types”](#). For floating-point and fixed-point types, *M* is the total number of digits that can be stored.

If you specify `ZEROFILL` for a numeric column, MySQL automatically adds the `UNSIGNED` attribute to the column.

Numeric data types that allow the `UNSIGNED` attribute also allow `SIGNED`. However, these data types are signed by default, so the `SIGNED` attribute has no effect.

`SERIAL` is an alias for `BIGINT UNSIGNED NOT NULL AUTO_INCREMENT UNIQUE`.

`SERIAL DEFAULT VALUE` in the definition of an integer column is an alias for `NOT NULL AUTO_INCREMENT UNIQUE`.

#### Warning

When you use subtraction between integer values where one is of type `UNSIGNED`, the result is unsigned unless the `NO_UNSIGNED_SUBTRACTION` SQL mode is enabled. See [Section 11.9, “Cast Functions and Operators”](#).

- `BIT[ (M) ]`

A bit-field type. *M* indicates the number of bits per value, from 1 to 64. The default is 1 if *M* is omitted.

- `TINYINT[ (M) ] [UNSIGNED] [ZEROFILL]`

A very small integer. The signed range is `-128` to `127`. The unsigned range is `0` to `255`.

- `BOOL`, `BOOLEAN`

These types are synonyms for `TINYINT(1)`. A value of zero is considered false. Nonzero values are considered true:

```
mysql> SELECT IF(0, 'true', 'false');
+-----+
| IF(0, 'true', 'false') |
+-----+
| false                  |
+-----+

mysql> SELECT IF(1, 'true', 'false');
+-----+
| IF(1, 'true', 'false') |
+-----+
```

```

| true |
+-----+
mysql> SELECT IF(2, 'true', 'false');
+-----+
| IF(2, 'true', 'false') |
+-----+
| true |
+-----+

```

However, the values `TRUE` and `FALSE` are merely aliases for `1` and `0`, respectively, as shown here:

```

mysql> SELECT IF(0 = FALSE, 'true', 'false');
+-----+
| IF(0 = FALSE, 'true', 'false') |
+-----+
| true |
+-----+

mysql> SELECT IF(1 = TRUE, 'true', 'false');
+-----+
| IF(1 = TRUE, 'true', 'false') |
+-----+
| true |
+-----+

mysql> SELECT IF(2 = TRUE, 'true', 'false');
+-----+
| IF(2 = TRUE, 'true', 'false') |
+-----+
| false |
+-----+

mysql> SELECT IF(2 = FALSE, 'true', 'false');
+-----+
| IF(2 = FALSE, 'true', 'false') |
+-----+
| false |
+-----+

```

The last two statements display the results shown because `2` is equal to neither `1` nor `0`.

We intend to implement full boolean type handling, in accordance with standard SQL, in a future MySQL release.

- `SMALLINT[(M)] [UNSIGNED] [ZEROFILL]`

A small integer. The signed range is `-32768` to `32767`. The unsigned range is `0` to `65535`.

- `MEDIUMINT[(M)] [UNSIGNED] [ZEROFILL]`

A medium-sized integer. The signed range is `-8388608` to `8388607`. The unsigned range is `0` to `16777215`.

- `INT[(M)] [UNSIGNED] [ZEROFILL]`

A normal-size integer. The signed range is `-2147483648` to `2147483647`. The unsigned range is `0` to `4294967295`.

- `INTEGER[(M)] [UNSIGNED] [ZEROFILL]`

This type is a synonym for `INT`.

- `BIGINT[(M)] [UNSIGNED] [ZEROFILL]`

A large integer. The signed range is `-9223372036854775808` to `9223372036854775807`. The unsigned range is `0` to `18446744073709551615`.

`SERIAL` is an alias for `BIGINT UNSIGNED NOT NULL AUTO_INCREMENT UNIQUE`.

Some things you should be aware of with respect to `BIGINT` columns:

- All arithmetic is done using signed `BIGINT` or `DOUBLE` values, so you should not use unsigned big integers larger than `9223372036854775807` (63 bits) except with bit functions! If you do that, some of the last digits in the result may be wrong because of rounding errors when converting a `BIGINT` value to a `DOUBLE`.

MySQL can handle `BIGINT` in the following cases:

- When using integers to store large unsigned values in a `BIGINT` column.
- In `MIN(col_name)` or `MAX(col_name)`, where `col_name` refers to a `BIGINT` column.

- When using operators (+, -, \*, and so on) where both operands are integers.
  - You can always store an exact integer value in a `BIGINT` column by storing it using a string. In this case, MySQL performs a string-to-number conversion that involves no intermediate double-precision representation.
  - The -, +, and \* operators use `BIGINT` arithmetic when both operands are integer values. This means that if you multiply two big integers (or results from functions that return integers), you may get unexpected results when the result is larger than `9223372036854775807`.
- `FLOAT[(M,D)] [UNSIGNED] [ZEROFILL]`  
 A small (single-precision) floating-point number. Allowable values are `-3.402823466E+38` to `-1.175494351E-38`, `0`, and `1.175494351E-38` to `3.402823466E+38`. These are the theoretical limits, based on the IEEE standard. The actual range might be slightly smaller depending on your hardware or operating system.  
*M* is the total number of digits and *D* is the number of digits following the decimal point. If *M* and *D* are omitted, values are stored to the limits allowed by the hardware. A single-precision floating-point number is accurate to approximately 7 decimal places.  
`UNSIGNED`, if specified, disallows negative values.  
 Using `FLOAT` might give you some unexpected problems because all calculations in MySQL are done with double precision. See [Section B.1.5.7, “Solving Problems with No Matching Rows”](#).
  - `DOUBLE[(M,D)] [UNSIGNED] [ZEROFILL]`  
 A normal-size (double-precision) floating-point number. Allowable values are `-1.7976931348623157E+308` to `-2.2250738585072014E-308`, `0`, and `2.2250738585072014E-308` to `1.7976931348623157E+308`. These are the theoretical limits, based on the IEEE standard. The actual range might be slightly smaller depending on your hardware or operating system.  
*M* is the total number of digits and *D* is the number of digits following the decimal point. If *M* and *D* are omitted, values are stored to the limits allowed by the hardware. A double-precision floating-point number is accurate to approximately 15 decimal places.  
`UNSIGNED`, if specified, disallows negative values.
  - `DOUBLE PRECISION[(M,D)] [UNSIGNED] [ZEROFILL]`, `REAL[(M,D)] [UNSIGNED] [ZEROFILL]`  
 These types are synonyms for `DOUBLE`. Exception: If the `REAL_AS_FLOAT` SQL mode is enabled, `REAL` is a synonym for `FLOAT` rather than `DOUBLE`.
  - `FLOAT(p) [UNSIGNED] [ZEROFILL]`  
 A floating-point number. *p* represents the precision in bits, but MySQL uses this value only to determine whether to use `FLOAT` or `DOUBLE` for the resulting data type. If *p* is from 0 to 24, the data type becomes `FLOAT` with no *M* or *D* values. If *p* is from 25 to 53, the data type becomes `DOUBLE` with no *M* or *D* values. The range of the resulting column is the same as for the single-precision `FLOAT` or double-precision `DOUBLE` data types described earlier in this section.  
`FLOAT(p)` syntax is provided for ODBC compatibility.
  - `DECIMAL[(M[,D])] [UNSIGNED] [ZEROFILL]`  
 A packed “exact” fixed-point number. *M* is the total number of digits (the precision) and *D* is the number of digits after the decimal point (the scale). The decimal point and (for negative numbers) the “-” sign are not counted in *M*. If *D* is 0, values have no decimal point or fractional part. The maximum number of digits (*M*) for `DECIMAL` is 65. The maximum number of supported decimals (*D*) is 30. If *D* is omitted, the default is 0. If *M* is omitted, the default is 10.  
`UNSIGNED`, if specified, disallows negative values.  
 All basic calculations (+, -, \*, /) with `DECIMAL` columns are done with a precision of 65 digits.
  - `DEC[(M[,D])] [UNSIGNED] [ZEROFILL]`, `NUMERIC[(M[,D])] [UNSIGNED] [ZEROFILL]`, `FIXED[(M[,D])] [UNSIGNED] [ZEROFILL]`  
 These types are synonyms for `DECIMAL`. The `FIXED` synonym is available for compatibility with other database systems.

## 10.1.2. Overview of Date and Time Types



A summary of the temporal data types follows. For additional information about properties of the temporal types, see [Section 10.3, “Date and Time Types”](#). Storage requirements are given in [Section 10.5, “Data Type Storage Requirements”](#). Functions that operate on temporal values are described at [Section 11.6, “Date and Time Functions”](#).

For the `DATETIME` and `DATE` range descriptions, “supported” means that although earlier values might work, there is no guarantee.

- `DATE`

A date. The supported range is '1000-01-01' to '9999-12-31'. MySQL displays `DATE` values in 'YYYY-MM-DD' format, but allows assignment of values to `DATE` columns using either strings or numbers.

- `DATETIME`

A date and time combination. The supported range is '1000-01-01 00:00:00' to '9999-12-31 23:59:59'. MySQL displays `DATETIME` values in 'YYYY-MM-DD HH:MM:SS' format, but allows assignment of values to `DATETIME` columns using either strings or numbers.

- `TIMESTAMP`

A timestamp. The range is '1970-01-01 00:00:01' UTC to '2038-01-09 03:14:07' UTC. `TIMESTAMP` values are stored as the number of seconds since the epoch ('1970-01-01 00:00:00' UTC). A `TIMESTAMP` cannot represent the value '1970-01-01 00:00:00' because that is equivalent to 0 seconds from the epoch and the value 0 is reserved for representing '0000-00-00 00:00:00', the “zero” `TIMESTAMP` value.

A `TIMESTAMP` column is useful for recording the date and time of an `INSERT` or `UPDATE` operation. By default, the first `TIMESTAMP` column in a table is automatically set to the date and time of the most recent operation if you do not assign it a value yourself. You can also set any `TIMESTAMP` column to the current date and time by assigning it a `NULL` value. Variations on automatic initialization and update properties are described in [Section 10.3.1.1, “TIMESTAMP Properties”](#).

A `TIMESTAMP` value is returned as a string in the format 'YYYY-MM-DD HH:MM:SS' with a display width fixed at 19 characters. To obtain the value as a number, you should add `+0` to the timestamp column.

### Note

The `TIMESTAMP` format that was used prior to MySQL 4.1 is not supported in MySQL 5.1; see *MySQL 3.23, 4.0, 4.1 Reference Manual* for information regarding the old format.

- `TIME`

A time. The range is '-838:59:59' to '838:59:59'. MySQL displays `TIME` values in 'HH:MM:SS' format, but allows assignment of values to `TIME` columns using either strings or numbers.

- `YEAR[(2|4)]`

A year in two-digit or four-digit format. The default is four-digit format. In four-digit format, the allowable values are 1901 to 2155, and 0000. In two-digit format, the allowable values are 70 to 69, representing years from 1970 to 2069. MySQL displays `YEAR` values in `YYYY` format, but allows you to assign values to `YEAR` columns using either strings or numbers.

The `SUM()` and `AVG()` aggregate functions do not work with temporal values. (They convert the values to numbers, which loses the part after the first non-numeric character.) To work around this problem, you can convert to numeric units, perform the aggregate operation, and convert back to a temporal value. Examples:

```
SELECT SEC_TO_TIME(SUM(TIME_TO_SEC(time_col))) FROM tbl_name;  
SELECT FROM_DAYS(SUM(TO_DAYS(date_col))) FROM tbl_name;
```

## 10.1.3. Overview of String Types

A summary of the string data types follows. For additional information about properties of the string types, see [Section 10.4, “String Types”](#). Storage requirements are given in [Section 10.5, “Data Type Storage Requirements”](#).

In some cases, MySQL may change a string column to a type different from that given in a `CREATE TABLE` or `ALTER TABLE` statement. See [Section 12.1.17.1, “Silent Column Specification Changes”](#).

MySQL interprets length specifications in character column definitions in character units. This applies to `CHAR`, `VARCHAR`, and the `TEXT` types.

Column definitions for many string data types can include attributes that specify the character set or collation of the column. These

attributes apply to the `CHAR`, `VARCHAR`, the `TEXT` types, `ENUM`, and `SET` data types:

- The `CHARACTER SET` attribute specifies the character set, and the `COLLATE` attribute specifies a collation for the character set. For example:

```
CREATE TABLE t
(
  c1 VARCHAR(20) CHARACTER SET utf8,
  c2 TEXT CHARACTER SET latin1 COLLATE latin1_general_cs
);
```

This table definition creates a column named `c1` that has a character set of `utf8` with the default collation for that character set, and a column named `c2` that has a character set of `latin1` and a case-sensitive collation.

The rules for assigning the character set and collation when either or both of the `CHARACTER SET` and `COLLATE` attributes are missing are described in [Section 9.1.3.4, “Column Character Set and Collation”](#).

`CHARSET` is a synonym for `CHARACTER SET`.

- Specifying the `CHARACTER SET binary` attribute for a character data type causes the column to be created as the corresponding binary data type: `CHAR` becomes `BINARY`, `VARCHAR` becomes `VARBINARY`, and `TEXT` becomes `BLOB`. For the `ENUM` and `SET` data types, this does not occur; they are created as declared. Suppose that you specify a table using this definition:

```
CREATE TABLE t
(
  c1 VARCHAR(10) CHARACTER SET binary,
  c2 TEXT CHARACTER SET binary,
  c3 ENUM('a','b','c') CHARACTER SET binary
);
```

The resulting table has this definition:

```
CREATE TABLE t
(
  c1 VARBINARY(10),
  c2 BLOB,
  c3 ENUM('a','b','c') CHARACTER SET binary
);
```

- The `ASCII` attribute is shorthand for `CHARACTER SET latin1`.
- The `UNICODE` attribute is shorthand for `CHARACTER SET ucs2`.
- The `BINARY` attribute is shorthand for specifying the binary collation of the column character set. In this case, sorting and comparison are based on numeric character values.

Character column sorting and comparison are based on the character set assigned to the column. For the `CHAR`, `VARCHAR`, `TEXT`, `ENUM`, and `SET` data types, you can declare a column with a binary collation or the `BINARY` attribute to cause sorting and comparison to use the underlying character code values rather than a lexical ordering.

[Section 9.1, “Character Set Support”](#), provides additional information about use of character sets in MySQL.

- `[NATIONAL] CHAR(M) [CHARACTER SET charset_name] [COLLATE collation_name]`

A fixed-length string that is always right-padded with spaces to the specified length when stored. *M* represents the column length in characters. The range of *M* is 0 to 255. If *M* is omitted, the length is 1.

### Note

Trailing spaces are removed when `CHAR` values are retrieved unless the `PAD_CHAR_TO_FULL_LENGTH` SQL mode is enabled.

`CHAR` is shorthand for `CHARACTER`. `NATIONAL CHAR` (or its equivalent short form, `NCHAR`) is the standard SQL way to define that a `CHAR` column should use some predefined character set. MySQL 4.1 and up uses `utf8` as this predefined character set. [Section 9.1.3.6, “National Character Set”](#).

The `CHAR BYTE` data type is an alias for the `BINARY` data type. This is a compatibility feature.

MySQL allows you to create a column of type `CHAR(0)`. This is useful primarily when you have to be compliant with old applications that depend on the existence of a column but that do not actually use its value. `CHAR(0)` is also quite nice when you

need a column that can take only two values: A column that is defined as `CHAR(0) NULL` occupies only one bit and can take only the values `NULL` and `' '` (the empty string).

- `[NATIONAL] VARCHAR(M) [CHARACTER SET charset_name] [COLLATE collation_name]`

A variable-length string. *M* represents the maximum column length in characters. The range of *M* is 0 to 65,535. The effective maximum length of a `VARCHAR` is subject to the maximum row size (65,535 bytes, which is shared among all columns) and the character set used. For example, `utf8` characters can require up to three bytes per character, so a `VARCHAR` column that uses the `utf8` character set can be declared to be a maximum of 21,844 characters.

MySQL stores `VARCHAR` values as a one-byte or two-byte length prefix plus data. The length prefix indicates the number of bytes in the value. A `VARCHAR` column uses one length byte if values require no more than 255 bytes, two length bytes if values may require more than 255 bytes.

### Note

MySQL 5.1 follows the standard SQL specification, and does *not* remove trailing spaces from `VARCHAR` values.

`VARCHAR` is shorthand for `CHARACTER VARYING`. `NATIONAL VARCHAR` is the standard SQL way to define that a `VARCHAR` column should use some predefined character set. MySQL 4.1 and up uses `utf8` as this predefined character set. Section 9.1.3.6, “National Character Set”. `NVARCHAR` is shorthand for `NATIONAL VARCHAR`.

- `BINARY(M)`

The `BINARY` type is similar to the `CHAR` type, but stores binary byte strings rather than nonbinary character strings. *M* represents the column length in bytes.

- `VARBINARY(M)`

The `VARBINARY` type is similar to the `VARCHAR` type, but stores binary byte strings rather than nonbinary character strings. *M* represents the maximum column length in bytes.

- `TINYBLOB`

A `BLOB` column with a maximum length of 255 ( $2^8 - 1$ ) bytes. Each `TINYBLOB` value is stored using a one-byte length prefix that indicates the number of bytes in the value.

- `TINYTEXT [CHARACTER SET charset_name] [COLLATE collation_name]`

A `TEXT` column with a maximum length of 255 ( $2^8 - 1$ ) characters. The effective maximum length is less if the value contains multi-byte characters. Each `TINYTEXT` value is stored using a one-byte length prefix that indicates the number of bytes in the value.

- `BLOB(M)`

A `BLOB` column with a maximum length of 65,535 ( $2^{16} - 1$ ) bytes. Each `BLOB` value is stored using a two-byte length prefix that indicates the number of bytes in the value.

An optional length *M* can be given for this type. If this is done, MySQL creates the column as the smallest `BLOB` type large enough to hold values *M* bytes long.

- `TEXT(M) [CHARACTER SET charset_name] [COLLATE collation_name]`

A `TEXT` column with a maximum length of 65,535 ( $2^{16} - 1$ ) characters. The effective maximum length is less if the value contains multi-byte characters. Each `TEXT` value is stored using a two-byte length prefix that indicates the number of bytes in the value.

An optional length *M* can be given for this type. If this is done, MySQL creates the column as the smallest `TEXT` type large enough to hold values *M* characters long.

- `MEDIUMBLOB`

A `BLOB` column with a maximum length of 16,777,215 ( $2^{24} - 1$ ) bytes. Each `MEDIUMBLOB` value is stored using a three-byte length prefix that indicates the number of bytes in the value.

- `MEDIUMTEXT [CHARACTER SET charset_name] [COLLATE collation_name]`

A `TEXT` column with a maximum length of 16,777,215 ( $2^{24} - 1$ ) characters. The effective maximum length is less if the value contains multi-byte characters. Each `MEDIUMTEXT` value is stored using a three-byte length prefix that indicates the number of bytes in the value.

- `LONGBLOB`

A `BLOB` column with a maximum length of 4,294,967,295 or 4GB ( $2^{32} - 1$ ) bytes. The effective maximum length of `LONGBLOB` columns depends on the configured maximum packet size in the client/server protocol and available memory. Each `LONGBLOB` value is stored using a four-byte length prefix that indicates the number of bytes in the value.

- `LONGTEXT [CHARACTER SET charset_name] [COLLATE collation_name]`

A `TEXT` column with a maximum length of 4,294,967,295 or 4GB ( $2^{32} - 1$ ) characters. The effective maximum length is less if the value contains multi-byte characters. The effective maximum length of `LONGTEXT` columns also depends on the configured maximum packet size in the client/server protocol and available memory. Each `LONGTEXT` value is stored using a four-byte length prefix that indicates the number of bytes in the value.

- `ENUM('value1','value2',...) [CHARACTER SET charset_name] [COLLATE collation_name]`

An enumeration. A string object that can have only one value, chosen from the list of values `'value1'`, `'value2'`, ..., `NULL` or the special `'` error value. An `ENUM` column can have a maximum of 65,535 distinct values. `ENUM` values are represented internally as integers.

- `SET('value1','value2',...) [CHARACTER SET charset_name] [COLLATE collation_name]`

A set. A string object that can have zero or more values, each of which must be chosen from the list of values `'value1'`, `'value2'`, ... A `SET` column can have a maximum of 64 members. `SET` values are represented internally as integers.

### 10.1.4. Data Type Default Values

The `DEFAULT value` clause in a data type specification indicates a default value for a column. With one exception, the default value must be a constant; it cannot be a function or an expression. This means, for example, that you cannot set the default for a date column to be the value of a function such as `NOW()` or `CURRENT_DATE`. The exception is that you can specify `CURRENT_TIMESTAMP` as the default for a `TIMESTAMP` column. See [Section 10.3.1.1, “TIMESTAMP Properties”](#).

`BLOB` and `TEXT` columns cannot be assigned a default value.

If a column definition includes no explicit `DEFAULT` value, MySQL determines the default value as follows:

If the column can take `NULL` as a value, the column is defined with an explicit `DEFAULT NULL` clause.

If the column cannot take `NULL` as the value, MySQL defines the column with no explicit `DEFAULT` clause. For data entry, if an `INSERT` or `REPLACE` statement includes no value for the column, or an `UPDATE` statement sets the column to `NULL`, MySQL handles the column according to the SQL mode in effect at the time:

- If strict SQL mode is not enabled, MySQL sets the column to the implicit default value for the column data type.
- If strict mode is enabled, an error occurs for transactional tables and the statement is rolled back. For non-transactional tables, an error occurs, but if this happens for the second or subsequent row of a multiple-row statement, the preceding rows will have been inserted.

Suppose that a table `t` is defined as follows:

```
CREATE TABLE t (i INT NOT NULL);
```

In this case, `i` has no explicit default, so in strict mode each of the following statements produce an error and no row is inserted. When not using strict mode, only the third statement produces an error; the implicit default is inserted for the first two statements, but the third fails because `DEFAULT(i)` cannot produce a value:

```
INSERT INTO t VALUES();
INSERT INTO t VALUES(DEFAULT);
INSERT INTO t VALUES(DEFAULT(i));
```

See [Section 5.1.7, “Server SQL Modes”](#).

For a given table, you can use the `SHOW CREATE TABLE` statement to see which columns have an explicit `DEFAULT` clause.

Implicit defaults are defined as follows:

- For numeric types, the default is `0`, with the exception that for integer or floating-point types declared with the

`AUTO_INCREMENT` attribute, the default is the next value in the sequence.

- For date and time types other than `TIMESTAMP`, the default is the appropriate “zero” value for the type. For the first `TIMESTAMP` column in a table, the default value is the current date and time. See [Section 10.3, “Date and Time Types”](#).
- For string types other than `ENUM`, the default value is the empty string. For `ENUM`, the default is the first enumeration value.

`SERIAL DEFAULT VALUE` in the definition of an integer column is an alias for `NOT NULL AUTO_INCREMENT UNIQUE`.

## 10.2. Numeric Types

MySQL supports all of the standard SQL numeric data types. These types include the exact numeric data types (`INTEGER`, `SMALLINT`, `DECIMAL`, and `NUMERIC`), as well as the approximate numeric data types (`FLOAT`, `REAL`, and `DOUBLE PRECISION`). The keyword `INT` is a synonym for `INTEGER`, and the keyword `DEC` is a synonym for `DECIMAL`. For numeric type storage requirements, see [Section 10.5, “Data Type Storage Requirements”](#).

The numeric types used for the results of calculations depends on the operations being performed and the numeric types of the operands; for more information, see [Section 11.5.1, “Arithmetic Operators”](#).

The `BIT` data type stores bit-field values and is supported for `MyISAM`, `MEMORY`, `InnoDB`, and `NDBCLUSTER` tables.

As an extension to the SQL standard, MySQL also supports the integer types `TINYINT`, `MEDIUMINT`, and `BIGINT`. The following table shows the required storage and range for each of the integer types.

Type	Bytes	Minimum Value (Signed/Unsigned)	Maximum Value (Signed/Unsigned)
<code>TINYINT</code>	1	-128 0	127 255
<code>SMALLINT</code>	2	-32768 0	32767 65535
<code>MEDIUMINT</code>	3	-8388608 0	8388607 16777215
<code>INT</code>	4	-2147483648 0	2147483647 4294967295
<code>BIGINT</code>	8	-9223372036854775808 0	9223372036854775807 18446744073709551615

Another extension is supported by MySQL for optionally specifying the display width of integer data types in parentheses following the base keyword for the type (for example, `INT(4)`). This optional display width may be used by applications to display integer values having a width less than the width specified for the column by left-padding them with spaces. (That is, this width is present in the metadata returned with result sets. Whether it is used or not is up to the application.)

The display width does *not* constrain the range of values that can be stored in the column, nor the number of digits that are displayed for values having a width exceeding that specified for the column. For example, a column specified as `SMALLINT(3)` has the usual `SMALLINT` range of `-32768` to `32767`, and values outside the range allowed by three characters are displayed using more than three characters.

When used in conjunction with the optional extension attribute `ZEROFILL`, the default padding of spaces is replaced with zeros. For example, for a column declared as `INT(5) ZEROFILL`, a value of `4` is retrieved as `00004`. Note that if you store larger values than the display width in an integer column, you may experience problems when MySQL generates temporary tables for some complicated joins, because in these cases MySQL assumes that the data fits into the original column width.

### Note

The `ZEROFILL` attribute is ignored when a column is involved in expressions or `UNION` queries.

All integer types can have an optional (non-standard) attribute `UNSIGNED`. Unsigned values can be used when you want to allow only non-negative numbers in a column and you need a larger upper numeric range for the column. For example, if an `INT` column is `UNSIGNED`, the size of the column's range is the same but its endpoints shift from `-2147483648` and `2147483647` up to `0` and `4294967295`.

Floating-point and fixed-point types also can be `UNSIGNED`. As with integer types, this attribute prevents negative values from be-

ing stored in the column. However, unlike the integer types, the upper range of column values remains the same.

If you specify `ZEROFILL` for a numeric column, MySQL automatically adds the `UNSIGNED` attribute to the column.

Integer or floating-point data types can have the additional attribute `AUTO_INCREMENT`. When you insert a value of `NULL` (recommended) or `0` into an indexed `AUTO_INCREMENT` column, the column is set to the next sequence value. Typically this is `value+1`, where `value` is the largest value for the column currently in the table. `AUTO_INCREMENT` sequences begin with `1`.

For floating-point data types, MySQL uses four bytes for single-precision values and eight bytes for double-precision values.

The `FLOAT` and `DOUBLE` data types are used to represent approximate numeric data values. For `FLOAT`, the SQL standard allows an optional specification of the precision (but not the range of the exponent) in bits following the keyword `FLOAT` in parentheses. MySQL also supports this optional precision specification, but the precision value is used only to determine storage size. A precision from 0 to 23 results in a four-byte single-precision `FLOAT` column. A precision from 24 to 53 results in an eight-byte double-precision `DOUBLE` column.

MySQL allows a non-standard syntax: `FLOAT(M,D)` or `REAL(M,D)` or `DOUBLE PRECISION(M,D)`. Here, “`(M,D)`” means that values can be stored with up to `M` digits in total, of which `D` digits may be after the decimal point. For example, a column defined as `FLOAT(7,4)` will look like `-999.9999` when displayed. MySQL performs rounding when storing values, so if you insert `999.00009` into a `FLOAT(7,4)` column, the approximate result is `999.0001`.

MySQL treats `DOUBLE` as a synonym for `DOUBLE PRECISION` (a non-standard extension). MySQL also treats `REAL` as a synonym for `DOUBLE PRECISION` (a non-standard variation), unless the `REAL_AS_FLOAT` SQL mode is enabled.

For maximum portability, code requiring storage of approximate numeric data values should use `FLOAT` or `DOUBLE PRECISION` with no specification of precision or number of digits.

The `DECIMAL` and `NUMERIC` data types are used to store exact numeric data values. In MySQL, `NUMERIC` is implemented as `DECIMAL`. These types are used to store values for which it is important to preserve exact precision, for example with monetary data.

MySQL 5.1 stores `DECIMAL` and `NUMERIC` values in binary format. Before MySQL 5.0.3, they were stored as strings. See [Section 11.14, “Precision Math”](#).

When declaring a `DECIMAL` or `NUMERIC` column, the precision and scale can be (and usually is) specified; for example:

```
salary DECIMAL(5,2)
```

In this example, `5` is the precision and `2` is the scale. The precision represents the number of significant digits that are stored for values, and the scale represents the number of digits that can be stored following the decimal point. If the scale is `0`, `DECIMAL` and `NUMERIC` values contain no decimal point or fractional part.

Standard SQL requires that the `salary` column be able to store any value with five digits and two decimals. In this case, therefore, the range of values that can be stored in the `salary` column is from `-999.99` to `999.99`.

In standard SQL, the syntax `DECIMAL(M)` is equivalent to `DECIMAL(M,0)`. Similarly, the syntax `DECIMAL` is equivalent to `DECIMAL(M,0)`, where the implementation is allowed to decide the value of `M`. MySQL supports both of these variant forms of the `DECIMAL` and `NUMERIC` syntax. The default value of `M` is `10`.

The maximum number of digits for `DECIMAL` or `NUMERIC` is `65`, but the actual range for a given `DECIMAL` or `NUMERIC` column can be constrained by the precision or scale for a given column. When such a column is assigned a value with more digits following the decimal point than are allowed by the specified scale, the value is converted to that scale. (The precise behavior is operating system-specific, but generally the effect is truncation to the allowable number of digits.)

The `BIT` data type is used to store bit-field values. A type of `BIT(M)` allows for storage of `M`-bit values. `M` can range from `1` to `64`.

To specify bit values, `b'value'` notation can be used. `value` is a binary value written using zeros and ones. For example, `b'111'` and `b'1000000'` represent `7` and `128`, respectively. See [Section 8.1.5, “Bit-Field Values”](#).

If you assign a value to a `BIT(M)` column that is less than `M` bits long, the value is padded on the left with zeros. For example, assigning a value of `b'101'` to a `BIT(6)` column is, in effect, the same as assigning `b'000101'`.

When asked to store a value in a numeric column that is outside the data type's allowable range, MySQL's behavior depends on the SQL mode in effect at the time. For example, if no restrictive modes are enabled, MySQL clips the value to the appropriate endpoint of the range and stores the resulting value instead. However, if strict SQL mode is enabled, MySQL rejects a value that is out of range with an error, and the insert fails, in accordance with the SQL standard.

In non-strict mode, when an out-of-range value is assigned to an integer column, MySQL stores the value representing the corresponding endpoint of the column data type range. If you store `256` into a `TINYINT` or `TINYINT UNSIGNED` column, MySQL stores `127` or `255`, respectively. When a floating-point or fixed-point column is assigned a value that exceeds the range implied by the specified (or default) precision and scale, MySQL stores the value representing the corresponding endpoint of that range.



Subtraction between integer values, where one is of type `UNSIGNED`, produces an unsigned result by default. If the result would otherwise have been negative, it becomes the maximum integer value. If the `NO_UNSIGNED_SUBTRACTION` SQL mode is enabled, the result is negative.

```
mysql> SET SQL_MODE = '';
mysql> SELECT CAST(0 AS UNSIGNED) - 1;
+-----+
| CAST(0 AS UNSIGNED) - 1 |
+-----+
| 18446744073709551615 |
+-----+

mysql> SET SQL_MODE = 'NO_UNSIGNED_SUBTRACTION';
mysql> SELECT CAST(0 AS UNSIGNED) - 1;
+-----+
| CAST(0 AS UNSIGNED) - 1 |
+-----+
| -1 |
+-----+
```

If the result of such an operation is used to update an `UNSIGNED` integer column, the result is clipped to the maximum value for the column type, or clipped to 0 if `NO_UNSIGNED_SUBTRACTION` is enabled. If strict SQL mode is enabled, an error occurs and the column remains unchanged.

Conversions that occur due to clipping when MySQL is not operating in strict mode are reported as warnings for `ALTER TABLE`, `LOAD DATA INFILE`, `UPDATE`, and multiple-row `INSERT` statements. When MySQL is operating in strict mode, these statements fail, and some or all of the values will not be inserted or changed, depending on whether the table is a transactional table and other factors. For details, see [Section 5.1.7, “Server SQL Modes”](#).

## 10.3. Date and Time Types

The date and time types for representing temporal values are `DATETIME`, `DATE`, `TIMESTAMP`, `TIME`, and `YEAR`. Each temporal type has a range of legal values, as well as a “zero” value that may be used when you specify an illegal value that MySQL cannot represent. The `TIMESTAMP` type has special automatic updating behavior, described later on. For temporal type storage requirements, see [Section 10.5, “Data Type Storage Requirements”](#).

MySQL gives warnings or errors if you try to insert an illegal date. By setting the SQL mode to the appropriate value, you can specify more exactly what kind of dates you want MySQL to support. (See [Section 5.1.7, “Server SQL Modes”](#).) You can get MySQL to accept certain dates, such as `'2009-11-31'`, by using the `ALLOW_INVALID_DATES` SQL mode. This is useful when you want to store a “possibly wrong” value which the user has specified (for example, in a web form) in the database for future processing. Under this mode, MySQL verifies only that the month is in the range from 0 to 12 and that the day is in the range from 0 to 31. These ranges are defined to include zero because MySQL allows you to store dates where the day or month and day are zero in a `DATE` or `DATETIME` column. This is extremely useful for applications that need to store a birthdate for which you do not know the exact date. In this case, you simply store the date as `'2009-00-00'` or `'2009-01-00'`. If you store dates such as these, you should not expect to get correct results for functions such as `DATE_SUB()` or `DATE_ADD()` that require complete dates. (If you do *not* want to allow zero in dates, you can use the `NO_ZERO_IN_DATE` SQL mode).

Prior to MySQL 5.1.18, when `DATE` values are compared with `DATETIME` values, the time portion of the `DATETIME` value is ignored, or the comparison could be performed as a string compare. Starting from MySQL 5.1.18, a `DATE` value is coerced to the `DATETIME` type by adding the time portion as `'00:00:00'`. To mimic the old behavior, use the `CAST()` function to cause the comparison operands to be treated as previously. For example:

```
date_col = CAST(NOW() AS DATE)
```

MySQL also allows you to store `'0000-00-00'` as a “dummy date” (if you are not using the `NO_ZERO_DATE` SQL mode). This is in some cases more convenient (and uses less data and index space) than using `NULL` values.

Here are some general considerations to keep in mind when working with date and time types:

- MySQL retrieves values for a given date or time type in a standard output format, but it attempts to interpret a variety of formats for input values that you supply (for example, when you specify a value to be assigned to or compared to a date or time type). Only the formats described in the following sections are supported. It is expected that you supply legal values. Unpredictable results may occur if you use values in other formats.
- Dates containing two-digit year values are ambiguous because the century is unknown. MySQL interprets two-digit year values using the following rules:
  - Year values in the range `70-99` are converted to `1970-1999`.
  - Year values in the range `00-69` are converted to `2000-2069`.
- Although MySQL tries to interpret values in several formats, dates always must be given in year-month-day order (for example,

'98-09-04'), rather than in the month-day-year or day-month-year orders commonly used elsewhere (for example, '09-04-98', '04-09-98').

- MySQL automatically converts a date or time type value to a number if the value is used in a numeric context and vice versa.
- By default, when MySQL encounters a value for a date or time type that is out of range or otherwise illegal for the type (as described at the beginning of this section), it converts the value to the “zero” value for that type. The exception is that out-of-range `TIME` values are clipped to the appropriate endpoint of the `TIME` range.

The following table shows the format of the “zero” value for each type. Note that the use of these values produces warnings if the `NO_ZERO_DATE` SQL mode is enabled.

Data Type	“Zero” Value
<code>DATETIME</code>	'0000-00-00 00:00:00'
<code>DATE</code>	'0000-00-00'
<code>TIMESTAMP</code>	'0000-00-00 00:00:00'
<code>TIME</code>	'00:00:00'
<code>YEAR</code>	0000

- The “zero” values are special, but you can store or refer to them explicitly using the values shown in the table. You can also do this using the values '0' or 0, which are easier to write.
- “Zero” date or time values used through MyODBC are converted automatically to `NULL` in MyODBC 2.50.12 and above, because ODBC cannot handle such values.

### 10.3.1. The `DATETIME`, `DATE`, and `TIMESTAMP` Types

The `DATETIME`, `DATE`, and `TIMESTAMP` types are related. This section describes their characteristics, how they are similar, and how they differ.

The `DATETIME` type is used when you need values that contain both date and time information. MySQL retrieves and displays `DATETIME` values in 'YYYY-MM-DD HH:MM:SS' format. The supported range is '1000-01-01 00:00:00' to '9999-12-31 23:59:59'.

The `DATE` type is used when you need only a date value, without a time part. MySQL retrieves and displays `DATE` values in 'YYYY-MM-DD' format. The supported range is '1000-01-01' to '9999-12-31'.

For the `DATETIME` and `DATE` range descriptions, “supported” means that although earlier values might work, there is no guarantee.

The `TIMESTAMP` data type has a range of '1970-01-01 00:00:01' UTC to '2038-01-09 03:14:07' UTC. It has varying properties, depending on the MySQL version and the SQL mode the server is running in. These properties are described later in this section.

You can specify `DATETIME`, `DATE`, and `TIMESTAMP` values using any of a common set of formats:

- As a string in either 'YYYY-MM-DD HH:MM:SS' or 'YY-MM-DD HH:MM:SS' format. A “relaxed” syntax is allowed: Any punctuation character may be used as the delimiter between date parts or time parts. For example, '98-12-31 11:30:45', '98.12.31 11+30+45', '98/12/31 11\*30\*45', and '98@12@31 11^30^45' are equivalent.
- As a string in either 'YYYY-MM-DD' or 'YY-MM-DD' format. A “relaxed” syntax is allowed here, too. For example, '98-12-31', '98.12.31', '98/12/31', and '98@12@31' are equivalent.
- As a string with no delimiters in either 'YYYYMMDDHHMMSS' or 'YYMMDDHHMMSS' format, provided that the string makes sense as a date. For example, '20070523091528' and '070523091528' are interpreted as '2007-05-23 09:15:28', but '071122129015' is illegal (it has a nonsensical minute part) and becomes '0000-00-00 00:00:00'.
- As a string with no delimiters in either 'YYYYMMDD' or 'YYMMDD' format, provided that the string makes sense as a date. For example, '20070523' and '070523' are interpreted as '2007-05-23', but '071332' is illegal (it has nonsensical month and day parts) and becomes '0000-00-00'.
- As a number in either `YYYYMMDDHHMMSS` or `YYMMDDHHMMSS` format, provided that the number makes sense as a date. For example, 19830905132800 and 830905132800 are interpreted as '1983-09-05 13:28:00'.



- As a number in either `YYYYMMDD` or `YYMMDD` format, provided that the number makes sense as a date. For example, `19830905` and `830905` are interpreted as `'1983-09-05'`.
- As the result of a function that returns a value that is acceptable in a `DATETIME`, `DATE`, or `TIMESTAMP` context, such as `NOW()` or `CURRENT_DATE`.

A microseconds part is allowable in temporal values in some contexts, such as in literal values, and in the arguments to or return values from some temporal functions. Microseconds are specified as a trailing `.uuuuuu` part in the value. Example:

```
mysql> SELECT MICROSECOND('2010-12-10 14:12:09.019473');
+-----+
| MICROSECOND('2010-12-10 14:12:09.019473') |
+-----+
| 19473 |
+-----+
```

However, microseconds cannot be stored into a column of any temporal data type. Any microseconds part is discarded.

Conversion of `TIME` or `DATETIME` values to numeric form (for example, by adding `+0`) results in a double value with a micro-seconds part of `.000000`:

```
mysql> SELECT CURTIME(), CURTIME()+0;
+-----+-----+
| CURTIME() | CURTIME()+0 |
+-----+-----+
| 10:41:36 | 104136.000000 |
+-----+-----+
mysql> SELECT NOW(), NOW()+0;
+-----+-----+
| NOW() | NOW()+0 |
+-----+-----+
| 2007-11-30 10:41:47 | 20071130104147.000000 |
+-----+-----+
```

Illegal `DATETIME`, `DATE`, or `TIMESTAMP` values are converted to the “zero” value of the appropriate type (`'0000-00-00 00:00:00'` or `'0000-00-00'`).

For values specified as strings that include date part delimiters, it is not necessary to specify two digits for month or day values that are less than 10. `'1979-6-9'` is the same as `'1979-06-09'`. Similarly, for values specified as strings that include time part delimiters, it is not necessary to specify two digits for hour, minute, or second values that are less than 10. `'1979-10-30 1:2:3'` is the same as `'1979-10-30 01:02:03'`.

Values specified as numbers should be 6, 8, 12, or 14 digits long. If a number is 8 or 14 digits long, it is assumed to be in `YYYYMMDD` or `YYYYMMDDHHMMSS` format and that the year is given by the first 4 digits. If the number is 6 or 12 digits long, it is assumed to be in `YYMMDD` or `YYMMDDHHMMSS` format and that the year is given by the first 2 digits. Numbers that are not one of these lengths are interpreted as though padded with leading zeros to the closest length.

Values specified as non-delimited strings are interpreted using their length as given. If the string is 8 or 14 characters long, the year is assumed to be given by the first 4 characters. Otherwise, the year is assumed to be given by the first 2 characters. The string is interpreted from left to right to find year, month, day, hour, minute, and second values, for as many parts as are present in the string. This means you should not use strings that have fewer than 6 characters. For example, if you specify `'9903'`, thinking that represents March, 1999, MySQL inserts a “zero” date value into your table. This occurs because the year and month values are `99` and `03`, but the day part is completely missing, so the value is not a legal date. However, you can explicitly specify a value of zero to represent missing month or day parts. For example, you can use `'990300'` to insert the value `'1999-03-00'`.

You can to some extent assign values of one date type to an object of a different date type. However, there may be some alteration of the value or loss of information:

- If you assign a `DATE` value to a `DATETIME` or `TIMESTAMP` object, the time part of the resulting value is set to `'00:00:00'` because the `DATE` value contains no time information.
- If you assign a `DATETIME` or `TIMESTAMP` value to a `DATE` object, the time part of the resulting value is deleted because the `DATE` type stores no time information.
- Remember that although `DATETIME`, `DATE`, and `TIMESTAMP` values all can be specified using the same set of formats, the types do not all have the same range of values. For example, `TIMESTAMP` values cannot be earlier than 1970 UTC or later than `'2038-01-09 03:14:07'` UTC. This means that a date such as `'1968-01-01'`, while legal as a `DATETIME` or `DATE` value, is not valid as a `TIMESTAMP` value and is converted to 0.

Be aware of certain problems when specifying date values:

- The relaxed format allowed for values specified as strings can be deceiving. For example, a value such as `'10:11:12'` might look like a time value because of the “:” delimiter, but if used in a date context is interpreted as the year `'2010-11-12'`. The value `'10:45:15'` is converted to `'0000-00-00'` because `'45'` is not a legal month.
- The server requires that month and day values be legal, and not merely in the range 1 to 12 and 1 to 31, respectively. With strict mode disabled, invalid dates such as `'2004-04-31'` are converted to `'0000-00-00'` and a warning is generated. With strict mode enabled, invalid dates generate an error. To allow such dates, enable `ALLOW_INVALID_DATES`. See [Section 5.1.7, “Server SQL Modes”](#), for more information.
- MySQL does not accept timestamp values that include a zero in the day or month column or values that are not a valid date. The sole exception to this rule is the special value `'0000-00-00 00:00:00'`.
- Dates containing two-digit year values are ambiguous because the century is unknown. MySQL interprets two-digit year values using the following rules:
  - Year values in the range `00-69` are converted to `2000-2069`.
  - Year values in the range `70-99` are converted to `1970-1999`.

### 10.3.1.1. **TIMESTAMP** Properties

`TIMESTAMP` columns are displayed in the same format as `DATETIME` columns. In other words, the display width is fixed at 19 characters, and the format is `'YYYY-MM-DD HH:MM:SS'`.

`TIMESTAMP` values are converted from the current time zone to UTC for storage, and converted back from UTC to the current time zone for retrieval. (This occurs only for the `TIMESTAMP` data type, not for other types such as `DATETIME`.) By default, the current time zone for each connection is the server's time. The time zone can be set on a per-connection basis, as described in [Section 9.7, “MySQL Server Time Zone Support”](#). As long as the time zone setting remains constant, you get back the same value you store. If you store a `TIMESTAMP` value, and then change the time zone and retrieve the value, the retrieved value is different from the value you stored. This occurs because the same time zone was not used for conversion in both directions. The current time zone is available as the value of the `time_zone` system variable.

The `TIMESTAMP` data type offers automatic initialization and updating. You can choose whether to use these properties and which column should have them:

- For one `TIMESTAMP` column in a table, you can assign the current timestamp as the default value and the auto-update value. It is possible to have the current timestamp be the default value for initializing the column, for the auto-update value, or both. It is not possible to have the current timestamp be the default value for one column and the auto-update value for another column.
- Any single `TIMESTAMP` column in a table can be used as the one that is initialized to the current date and time, or updated automatically. This need not be the first `TIMESTAMP` column.
- If a `DEFAULT` value is specified for the first `TIMESTAMP` column in a table, it is not ignored. The default can be `CURRENT_TIMESTAMP` or a constant date and time value.
- In a `CREATE TABLE` statement, the first `TIMESTAMP` column can be declared in any of the following ways:
  - With both `DEFAULT CURRENT_TIMESTAMP` and `ON UPDATE CURRENT_TIMESTAMP` clauses, the column has the current timestamp for its default value, and is automatically updated.
  - With neither `DEFAULT` nor `ON UPDATE` clauses, it is the same as `DEFAULT CURRENT_TIMESTAMP ON UPDATE CURRENT_TIMESTAMP`.
  - With a `DEFAULT CURRENT_TIMESTAMP` clause and no `ON UPDATE` clause, the column has the current timestamp for its default value but is not automatically updated.
  - With no `DEFAULT` clause and with an `ON UPDATE CURRENT_TIMESTAMP` clause, the column has a default of 0 and is automatically updated.
  - With a constant `DEFAULT` value, the column has the given default and is not automatically initialized to the current timestamp. If the column also has an `ON UPDATE CURRENT_TIMESTAMP` clause, it is automatically updated; otherwise, it has a constant default and is not automatically updated.

In other words, you can use the current timestamp for both the initial value and the auto-update value, or either one, or neither. (For example, you can specify `ON UPDATE` to enable auto-update without also having the column auto-initialized.) The following column definitions demonstrate each of the possibilities:

- Auto-initialization and auto-update:

```
ts TIMESTAMP DEFAULT CURRENT_TIMESTAMP ON UPDATE CURRENT_TIMESTAMP
```

- Auto-initialization only:

```
ts TIMESTAMP DEFAULT CURRENT_TIMESTAMP
```

- Auto-update only:

```
ts TIMESTAMP DEFAULT 0 ON UPDATE CURRENT_TIMESTAMP
```

- Neither:

```
ts TIMESTAMP DEFAULT 0
```

- To specify automatic default or updating for a `TIMESTAMP` column other than the first one, you must suppress the automatic initialization and update behaviors for the first `TIMESTAMP` column by explicitly assigning it a constant `DEFAULT` value (for example, `DEFAULT 0` or `DEFAULT '2003-01-01 00:00:00'`). Then, for the other `TIMESTAMP` column, the rules are the same as for the first `TIMESTAMP` column, except that if you omit both of the `DEFAULT` and `ON UPDATE` clauses, no automatic initialization or updating occurs.

Example:

```
CREATE TABLE t (
  ts1 TIMESTAMP DEFAULT 0,
  ts2 TIMESTAMP DEFAULT CURRENT_TIMESTAMP
  ON UPDATE CURRENT_TIMESTAMP);
```

- `CURRENT_TIMESTAMP` or any of its synonyms (`CURRENT_TIMESTAMP()`, `NOW()`, `LOCALTIME`, `LOCALTIME()`, `LOCALTIMESTAMP`, or `LOCALTIMESTAMP()`) can be used in the `DEFAULT` and `ON UPDATE` clauses. They all mean “the current timestamp.” (`UTC_TIMESTAMP` is not allowed. Its range of values does not align with those of the `TIMESTAMP` column anyway unless the current time zone is `UTC`.)
- The order of the `DEFAULT` and `ON UPDATE` attributes does not matter. If both `DEFAULT` and `ON UPDATE` are specified for a `TIMESTAMP` column, either can precede the other. For example, these statements are equivalent:

```
CREATE TABLE t (ts TIMESTAMP);
CREATE TABLE t (ts TIMESTAMP DEFAULT CURRENT_TIMESTAMP
ON UPDATE CURRENT_TIMESTAMP);
CREATE TABLE t (ts TIMESTAMP ON UPDATE CURRENT_TIMESTAMP
DEFAULT CURRENT_TIMESTAMP);
```

## Note

The examples that use `DEFAULT 0` will not work if the `NO_ZERO_DATE` SQL mode is enabled because that mode causes “zero” date values (specified as `0`, `'0000-00-00'`, or `'0000-00-00 00:00:00'`) to be rejected. Be aware that the `TRADITIONAL SQL` mode includes `NO_ZERO_DATE`.

`TIMESTAMP` columns are `NOT NULL` by default, cannot contain `NULL` values, and assigning `NULL` assigns the current timestamp. However, a `TIMESTAMP` column can be allowed to contain `NULL` by declaring it with the `NULL` attribute. In this case, the default value also becomes `NULL` unless overridden with a `DEFAULT` clause that specifies a different default value. `DEFAULT NULL` can be used to explicitly specify `NULL` as the default value. (For a `TIMESTAMP` column not declared with the `NULL` attribute, `DEFAULT NULL` is illegal.) If a `TIMESTAMP` column allows `NULL` values, assigning `NULL` sets it to `NULL`, not to the current timestamp.

The following table contains several `TIMESTAMP` columns that allow `NULL` values:

```
CREATE TABLE t
(
  ts1 TIMESTAMP NULL DEFAULT NULL,
  ts2 TIMESTAMP NULL DEFAULT 0,
  ts3 TIMESTAMP NULL DEFAULT CURRENT_TIMESTAMP
);
```

Note that a `TIMESTAMP` column that allows `NULL` values will *not* take on the current timestamp except under one of the following conditions:

- Its default value is defined as `CURRENT_TIMESTAMP`

- `NOW()` or `CURRENT_TIMESTAMP` is inserted into the column

In other words, a `TIMESTAMP` column defined as `NULL` will auto-initialize only if it is created using a definition such as the following:

```
CREATE TABLE t (ts TIMESTAMP NULL DEFAULT CURRENT_TIMESTAMP);
```

Otherwise — that is, if the `TIMESTAMP` column is defined to allow `NULL` values but not using `DEFAULT CURRENT_TIMESTAMP`, as shown here...

```
CREATE TABLE t1 (ts TIMESTAMP NULL DEFAULT NULL);
CREATE TABLE t2 (ts TIMESTAMP NULL DEFAULT '0000-00-00 00:00:00');
```

...then you must explicitly insert a value corresponding to the current date and time. For example:

```
INSERT INTO t1 VALUES (NOW());
INSERT INTO t2 VALUES (CURRENT_TIMESTAMP);
```

### Note

The MySQL server can be run with the `MAXDB` SQL mode enabled. When the server runs with this mode enabled, `TIMESTAMP` is identical with `DATETIME`. That is, if this mode is enabled at the time that a table is created, `TIMESTAMP` columns are created as `DATETIME` columns. As a result, such columns use `DATETIME` display format, have the same range of values, and there is no automatic initialization or updating to the current date and time.

To enable `MAXDB` mode, set the server SQL mode to `MAXDB` at startup using the `--sql-mode=MAXDB` server option or by setting the global `sql_mode` variable at runtime:

```
mysql> SET GLOBAL sql_mode=MAXDB;
```

A client can cause the server to run in `MAXDB` mode for its own connection as follows:

```
mysql> SET SESSION sql_mode=MAXDB;
```

## 10.3.2. The `TIME` Type

MySQL retrieves and displays `TIME` values in `'HH:MM:SS'` format (or `'HHH:MM:SS'` format for large hours values). `TIME` values may range from `'-838:59:59'` to `'838:59:59'`. The hours part may be so large because the `TIME` type can be used not only to represent a time of day (which must be less than 24 hours), but also elapsed time or a time interval between two events (which may be much greater than 24 hours, or even negative).

You can specify `TIME` values in a variety of formats:

- As a string in `'D HH:MM:SS.fraction'` format. You can also use one of the following “relaxed” syntaxes: `'HH:MM:SS.fraction'`, `'HH:MM:SS'`, `'HH:MM'`, `'D HH:MM:SS'`, `'D HH:MM'`, `'D HH'`, or `'SS'`. Here `D` represents days and can have a value from 0 to 34. Note that MySQL does not store the fraction part.
- As a string with no delimiters in `'HHMMSS'` format, provided that it makes sense as a time. For example, `'101112'` is understood as `'10:11:12'`, but `'109712'` is illegal (it has a nonsensical minute part) and becomes `'00:00:00'`.
- As a number in `HHMMSS` format, provided that it makes sense as a time. For example, `101112` is understood as `'10:11:12'`. The following alternative formats are also understood: `SS`, `MMSS`, `HHMMSS`, `HHMMSS.fraction`. Note that MySQL does not store the fraction part.
- As the result of a function that returns a value that is acceptable in a `TIME` context, such as `CURRENT_TIME`.

A trailing `.uuuuuu` microseconds part of `TIME` values is allowed under the same conditions as for other temporal values, as described in Section 10.3.1, “The `DATETIME`, `DATE`, and `TIMESTAMP` Types”. This includes the property that any microseconds part is discarded from values stored into `TIME` columns.

For `TIME` values specified as strings that include a time part delimiter, it is not necessary to specify two digits for hours, minutes, or seconds values that are less than 10. `'8:3:2'` is the same as `'08:03:02'`.

Be careful about assigning abbreviated values to a `TIME` column. Without colons, MySQL interprets values using the assumption that the two rightmost digits represent seconds. (MySQL interprets `TIME` values as elapsed time rather than as time of day.) For example, you might think of `'1112'` and `1112` as meaning `'11:12:00'` (12 minutes after 11 o'clock), but MySQL interprets

them as '00:11:12' (11 minutes, 12 seconds). Similarly, '12' and 12 are interpreted as '00:00:12'. `TIME` values with colons, by contrast, are always treated as time of the day. That is, '11:12' mean '11:12:00', not '00:11:12'.

By default, values that lie outside the `TIME` range but are otherwise legal are clipped to the closest endpoint of the range. For example, '-850:00:00' and '850:00:00' are converted to '-838:59:59' and '838:59:59'. Illegal `TIME` values are converted to '00:00:00'. Note that because '00:00:00' is itself a legal `TIME` value, there is no way to tell, from a value of '00:00:00' stored in a table, whether the original value was specified as '00:00:00' or whether it was illegal.

For more restrictive treatment of invalid `TIME` values, enable strict SQL mode to cause errors to occur. See [Section 5.1.7, “Server SQL Modes”](#).

### 10.3.3. The `YEAR` Type

The `YEAR` type is a one-byte type used for representing years. It can be declared as `YEAR(2)` or `YEAR(4)` to specify a display width of two or four characters. The default is four characters if no width is given.

For four-digit format, MySQL displays `YEAR` values in `YYYY` format, with a range of 1901 to 2155. For two-digit format, MySQL displays values with a range of 70 (1970) to 69 (2069).

You can specify input `YEAR` values in a variety of formats:

- As a four-digit string in the range '1901' to '2155'.
- As a four-digit number in the range 1901 to 2155.
- As a two-digit string in the range '00' to '99'. Values in the ranges '00' to '69' and '70' to '99' are converted to `YEAR` values in the ranges 2000 to 2069 and 1970 to 1999.
- As a two-digit number in the range 1 to 99. Values in the ranges 1 to 69 and 70 to 99 are converted to `YEAR` values in the ranges 2001 to 2069 and 1970 to 1999. Note that the range for two-digit numbers is slightly different from the range for two-digit strings, because you cannot specify zero directly as a number and have it be interpreted as 2000. You must specify it as a string '0' or '00' or it is interpreted as 0000.
- As the result of a function that returns a value that is acceptable in a `YEAR` context, such as `NOW()`.

Illegal `YEAR` values are converted to 0000.

### 10.3.4. Year 2000 Issues and Date Types

MySQL Server itself has no problems with Year 2000 (Y2K) compliance:

- MySQL Server uses Unix time functions that handle dates into the year 2038 for `TIMESTAMP` values. For `DATE` and `DATE-TIME` values, dates through the year 9999 are accepted.
- All MySQL date functions are implemented in one source file, `sql/time.cc`, and are coded very carefully to be year 2000-safe.
- In MySQL, the `YEAR` data type can store the years 0 and 1901 to 2155 in one byte and display them using two or four digits. All two-digit years are considered to be in the range 1970 to 2069, which means that if you store 01 in a `YEAR` column, MySQL Server treats it as 2001.

Although MySQL Server itself is Y2K-safe, you may run into problems if you use it with applications that are not Y2K-safe. For example, many old applications store or manipulate years using two-digit values (which are ambiguous) rather than four-digit values. This problem may be compounded by applications that use values such as 00 or 99 as “missing” value indicators. Unfortunately, these problems may be difficult to fix because different applications may be written by different programmers, each of whom may use a different set of conventions and date-handling functions.

Thus, even though MySQL Server has no Y2K problems, *it is the application's responsibility to provide unambiguous input*. Any value containing a two-digit year is ambiguous, because the century is unknown. Such values must be interpreted into four-digit form because MySQL stores years internally using four digits.

For `DATETIME`, `DATE`, `TIMESTAMP`, and `YEAR` types, MySQL interprets dates with ambiguous year values using the following rules:

- Year values in the range 00–69 are converted to 2000–2069.

- Year values in the range 70–99 are converted to 1970–1999.

Remember that these rules are only heuristics that provide reasonable guesses as to what your data values mean. If the rules used by MySQL do not produce the correct values, you should provide unambiguous input containing four-digit year values.

`ORDER BY` properly sorts `YEAR` values that have two-digit years.

Some functions like `MIN()` and `MAX()` convert a `YEAR` to a number. This means that a value with a two-digit year does not work properly with these functions. The fix in this case is to convert the `TIMESTAMP` or `YEAR` to four-digit year format.

## 10.4. String Types

The string types are `CHAR`, `VARCHAR`, `BINARY`, `VARBINARY`, `BLOB`, `TEXT`, `ENUM`, and `SET`. This section describes how these types work and how to use them in your queries. For string type storage requirements, see [Section 10.5, “Data Type Storage Requirements”](#).

### 10.4.1. The `CHAR` and `VARCHAR` Types

The `CHAR` and `VARCHAR` types are similar, but differ in the way they are stored and retrieved. They also differ in maximum length and in whether trailing spaces are retained.

The `CHAR` and `VARCHAR` types are declared with a length that indicates the maximum number of characters you want to store. For example, `CHAR(30)` can hold up to 30 characters.

The length of a `CHAR` column is fixed to the length that you declare when you create the table. The length can be any value from 0 to 255. When `CHAR` values are stored, they are right-padded with spaces to the specified length. When `CHAR` values are retrieved, trailing spaces are removed unless the `PAD_CHAR_TO_FULL_LENGTH` SQL mode is enabled.

Values in `VARCHAR` columns are variable-length strings. The length can be specified as a value from 0 to 65,535. The effective maximum length of a `VARCHAR` is subject to the maximum row size (65,535 bytes, which is shared among all columns) and the character set used.

In contrast to `CHAR`, `VARCHAR` values are stored as a one-byte or two-byte length prefix plus data. The length prefix indicates the number of bytes in the value. A column uses one length byte if values require no more than 255 bytes, two length bytes if values may require more than 255 bytes.

If strict SQL mode is not enabled and you assign a value to a `CHAR` or `VARCHAR` column that exceeds the column's maximum length, the value is truncated to fit and a warning is generated. For truncation of non-space characters, you can cause an error to occur (rather than a warning) and suppress insertion of the value by using strict SQL mode. See [Section 5.1.7, “Server SQL Modes”](#).

For `VARCHAR` columns, trailing spaces in excess of the column length are truncated prior to insertion and a warning is generated, regardless of the SQL mode in use. For `CHAR` columns, truncation of excess trailing spaces from inserted values is performed silently regardless of the SQL mode.

`VARCHAR` values are not padded when they are stored. Trailing spaces are retained when values are stored and retrieved, in conformance with standard SQL.

The following table illustrates the differences between `CHAR` and `VARCHAR` by showing the result of storing various string values into `CHAR(4)` and `VARCHAR(4)` columns (assuming that the column uses a single-byte character set such as `latin1`).

Value	<code>CHAR(4)</code>	Storage Required	<code>VARCHAR(4)</code>	Storage Required
' '	'   '	4 bytes	' '	1 byte
'ab'	'ab  '	4 bytes	'ab'	3 bytes
'abcd'	'abcd'	4 bytes	'abcd'	5 bytes
'abcdefgh'	'abcd'	4 bytes	'abcd'	5 bytes

The values shown as stored in the last row of the table apply *only when not using strict mode*; if MySQL is running in strict mode, values that exceed the column length are *not stored*, and an error results.

If a given value is stored into the `CHAR(4)` and `VARCHAR(4)` columns, the values retrieved from the columns are not always the same because trailing spaces are removed from `CHAR` columns upon retrieval. The following example illustrates this difference:

```
mysql> CREATE TABLE vc (v VARCHAR(4), c CHAR(4));
Query OK, 0 rows affected (0.01 sec)

mysql> INSERT INTO vc VALUES ('ab ', 'ab ');
Query OK, 1 row affected (0.00 sec)
```



```
mysql> SELECT CONCAT('(', v, ')'), CONCAT('(', c, ')') FROM vc;
+-----+-----+
| CONCAT('(', v, ')') | CONCAT('(', c, ')') |
+-----+-----+
| (ab )              | (ab)                 |
+-----+-----+
1 row in set (0.06 sec)
```

Values in [CHAR](#) and [VARCHAR](#) columns are sorted and compared according to the character set collation assigned to the column.

All MySQL collations are of type [PADSPACE](#). This means that all [CHAR](#) and [VARCHAR](#) values in MySQL are compared without regard to any trailing spaces. For example:

```
mysql> CREATE TABLE names (myname CHAR(10), yourname VARCHAR(10));
Query OK, 0 rows affected (0.09 sec)

mysql> INSERT INTO names VALUES ('Monty ', 'Monty ');
Query OK, 1 row affected (0.00 sec)

mysql> SELECT myname = 'Monty ', yourname = 'Monty ' FROM names;
+-----+-----+
| myname = 'Monty ' | yourname = 'Monty ' |
+-----+-----+
| 1                  | 1                    |
+-----+-----+
1 row in set (0.00 sec)
```

This is true for all MySQL versions, and that it is not affected by the server SQL mode.

For those cases where trailing pad characters are stripped or comparisons ignore them, if a column has an index that requires unique values, inserting into the column values that differ only in number of trailing pad characters will result in a duplicate-key error. For example, if a table contains 'a', an attempt to store 'a ' causes a duplicate-key error.

## 10.4.2. The [BINARY](#) and [VARBINARY](#) Types

The [BINARY](#) and [VARBINARY](#) types are similar to [CHAR](#) and [VARCHAR](#), except that they contain binary strings rather than non-binary strings. That is, they contain byte strings rather than character strings. This means that they have no character set, and sorting and comparison are based on the numeric values of the bytes in the values.

The allowable maximum length is the same for [BINARY](#) and [VARBINARY](#) as it is for [CHAR](#) and [VARCHAR](#), except that the length for [BINARY](#) and [VARBINARY](#) is a length in bytes rather than in characters.

The [BINARY](#) and [VARBINARY](#) data types are distinct from the [CHAR BINARY](#) and [VARCHAR BINARY](#) data types. For the latter types, the [BINARY](#) attribute does not cause the column to be treated as a binary string column. Instead, it causes the binary collation for the column character set to be used, and the column itself contains nonbinary character strings rather than binary byte strings. For example, [CHAR\(5\) BINARY](#) is treated as [CHAR\(5\) CHARACTER SET latin1 COLLATE latin1\\_bin](#), assuming that the default character set is [latin1](#). This differs from [BINARY\(5\)](#), which stores 5-bytes binary strings that have no character set or collation. For information about differences between nonbinary string binary collations and binary strings, see [Section 9.1.6.4, “The `\_bin` and `binary` Collations”](#).

If strict SQL mode is not enabled and you assign a value to a [BINARY](#) or [VARBINARY](#) column that exceeds the column's maximum length, the value is truncated to fit and a warning is generated. For cases of truncation, you can cause an error to occur (rather than a warning) and suppress insertion of the value by using strict SQL mode. See [Section 5.1.7, “Server SQL Modes”](#).

When [BINARY](#) values are stored, they are right-padded with the pad value to the specified length. The pad value is `0x00` (the zero byte). Values are right-padded with `0x00` on insert, and no trailing bytes are removed on select. All bytes are significant in comparisons, including [ORDER BY](#) and [DISTINCT](#) operations. `0x00` bytes and spaces are different in comparisons, with `0x00 < space`.

Example: For a [BINARY\(3\)](#) column, 'a ' becomes 'a \0' when inserted. 'a\0' becomes 'a\0\0' when inserted. Both inserted values remain unchanged when selected.

For [VARBINARY](#), there is no padding on insert and no bytes are stripped on select. All bytes are significant in comparisons, including [ORDER BY](#) and [DISTINCT](#) operations. `0x00` bytes and spaces are different in comparisons, with `0x00 < space`.

For those cases where trailing pad bytes are stripped or comparisons ignore them, if a column has an index that requires unique values, inserting into the column values that differ only in number of trailing pad bytes will result in a duplicate-key error. For example, if a table contains 'a', an attempt to store 'a\0' causes a duplicate-key error.

You should consider the preceding padding and stripping characteristics carefully if you plan to use the [BINARY](#) data type for storing binary data and you require that the value retrieved be exactly the same as the value stored. The following example illustrates how `0x00`-padding of [BINARY](#) values affects column value comparisons:

```
mysql> CREATE TABLE t (c BINARY(3));
Query OK, 0 rows affected (0.01 sec)
```

```
mysql> INSERT INTO t SET c = 'a';
Query OK, 1 row affected (0.01 sec)

mysql> SELECT HEX(c), c = 'a', c = 'a\0\0' from t;
+-----+-----+-----+
| HEX(c) | c = 'a' | c = 'a\0\0' |
+-----+-----+-----+
| 610000 | 0       | 1           |
+-----+-----+-----+
1 row in set (0.09 sec)
```

If the value retrieved must be the same as the value specified for storage with no padding, it might be preferable to use `VARBINARY` or one of the `BLOB` data types instead.

### 10.4.3. The `BLOB` and `TEXT` Types

A `BLOB` is a binary large object that can hold a variable amount of data. The four `BLOB` types are `TINYBLOB`, `BLOB`, `MEDIUMBLOB`, and `LONGBLOB`. These differ only in the maximum length of the values they can hold. The four `TEXT` types are `TINYTEXT`, `TEXT`, `MEDIUMTEXT`, and `LONGTEXT`. These correspond to the four `BLOB` types and have the same maximum lengths and storage requirements. See [Section 10.5, “Data Type Storage Requirements”](#).

`BLOB` columns are treated as binary strings (byte strings). `TEXT` columns are treated as nonbinary strings (character strings). `BLOB` columns have no character set, and sorting and comparison are based on the numeric values of the bytes in column values. `TEXT` columns have a character set, and values are sorted and compared based on the collation of the character set.

If strict SQL mode is not enabled and you assign a value to a `BLOB` or `TEXT` column that exceeds the column's maximum length, the value is truncated to fit and a warning is generated. For truncation of non-space characters, you can cause an error to occur (rather than a warning) and suppress insertion of the value by using strict SQL mode. See [Section 5.1.7, “Server SQL Modes”](#).

Beginning with MySQL 5.1.24, truncation of excess trailing spaces from values to be inserted into `TEXT` columns always generates a warning, regardless of the SQL mode. ([Bug#30059](#))

If a `TEXT` column is indexed, index entry comparisons are space-padded at the end. This means that, if the index requires unique values, duplicate-key errors will occur for values that differ only in the number of trailing spaces. For example, if a table contains 'a', an attempt to store 'a ' causes a duplicate-key error. This is not true for `BLOB` columns.

In most respects, you can regard a `BLOB` column as a `VARBINARY` column that can be as large as you like. Similarly, you can regard a `TEXT` column as a `VARCHAR` column. `BLOB` and `TEXT` differ from `VARBINARY` and `VARCHAR` in the following ways:

- For indexes on `BLOB` and `TEXT` columns, you must specify an index prefix length. For `CHAR` and `VARCHAR`, a prefix length is optional. See [Section 7.4.2, “Column Indexes”](#).
- `BLOB` and `TEXT` columns cannot have `DEFAULT` values.

`LONG` and `LONG VARCHAR` map to the `MEDIUMTEXT` data type. This is a compatibility feature. If you use the `BINARY` attribute with a `TEXT` data type, the column is assigned the binary collation of the column character set.

MySQL Connector/ODBC defines `BLOB` values as `LONGVARBINARY` and `TEXT` values as `LONGVARCHAR`.

Because `BLOB` and `TEXT` values can be extremely long, you might encounter some constraints in using them:

- Only the first `max_sort_length` bytes of the column are used when sorting. The default value of `max_sort_length` is 1024. This value can be changed using the `--max_sort_length=N` option when starting the `mysqld` server. See [Section 5.1.3, “Server System Variables”](#).

You can make more bytes significant in sorting or grouping by increasing the value of `max_sort_length` at runtime. Any client can change the value of its session `max_sort_length` variable:

```
mysql> SET max_sort_length = 2000;
mysql> SELECT id, comment FROM t
-> ORDER BY comment;
```

Another way to use `GROUP BY` or `ORDER BY` on a `BLOB` or `TEXT` column containing long values when you want more than `max_sort_length` bytes to be significant is to convert the column value into a fixed-length object. The standard way to do this is with the `SUBSTRING()` function. For example, the following statement causes 2000 bytes of the `comment` column to be taken into account for sorting:

```
mysql> SELECT id, SUBSTRING(comment,1,2000) FROM t
-> ORDER BY SUBSTRING(comment,1,2000);
```



- The maximum size of a `BLOB` or `TEXT` object is determined by its type, but the largest value you actually can transmit between the client and server is determined by the amount of available memory and the size of the communications buffers. You can change the message buffer size by changing the value of the `max_allowed_packet` variable, but you must do so for both the server and your client program. For example, both `mysql` and `mysqldump` allow you to change the client-side `max_allowed_packet` value. See [Section 7.5.3, “Tuning Server Parameters”](#), [Section 4.5.1, “mysql — The MySQL Command-Line Tool”](#), and [Section 4.5.4, “mysqldump — A Database Backup Program”](#). You may also want to compare the packet sizes and the size of the data objects you are storing with the storage requirements, see [Section 10.5, “Data Type Storage Requirements”](#)

Each `BLOB` or `TEXT` value is represented internally by a separately allocated object. This is in contrast to all other data types, for which storage is allocated once per column when the table is opened.

In some cases, it may be desirable to store binary data such as media files in `BLOB` or `TEXT` columns. You may find MySQL's string handling functions useful for working with such data. See [Section 11.4, “String Functions”](#). For security and other reasons, it is usually preferable to do so using application code rather than allowing application users the `FILE` privilege. You can discuss specifics for various languages and platforms in the MySQL Forums (<http://forums.mysql.com/>).

## 10.4.4. The `ENUM` Type

An `ENUM` is a string object with a value chosen from a list of allowed values that are enumerated explicitly in the column specification at table creation time.

An enumeration value must be a quoted string literal; it may not be an expression, even one that evaluates to a string value. For example, you can create a table with an `ENUM` column like this:

```
CREATE TABLE sizes (
  name ENUM('small', 'medium', 'large')
);
```

However, this version of the previous `CREATE TABLE` statement does *not* work:

```
CREATE TABLE sizes (
  cl ENUM('small', CONCAT('med','ium'), 'large')
);
```

You also may not employ a user variable as an enumeration value. This pair of statements do *not* work:

```
SET @mysize = 'medium';
CREATE TABLE sizes (
  name ENUM('small', @mysize, 'large')
);
```

If you wish to use a number as an enumeration value, you must enclose it in quotes.

Duplicate values in the definition cause a warning, or an error if strict SQL mode is enabled.

The value may also be the empty string (' ') or `NULL` under certain circumstances:

- If you insert an invalid value into an `ENUM` (that is, a string not present in the list of allowed values), the empty string is inserted instead as a special error value. This string can be distinguished from a “normal” empty string by the fact that this string has the numerical value 0. More about this later.

If strict SQL mode is enabled, attempts to insert invalid `ENUM` values result in an error.

- If an `ENUM` column is declared to allow `NULL`, the `NULL` value is a legal value for the column, and the default value is `NULL`. If an `ENUM` column is declared `NOT NULL`, its default value is the first element of the list of allowed values.

Each enumeration value has an index:

- Values from the list of allowable elements in the column specification are numbered beginning with 1.
- The index value of the empty string error value is 0. This means that you can use the following `SELECT` statement to find rows into which invalid `ENUM` values were assigned:

```
mysql> SELECT * FROM tbl_name WHERE enum_col=0;
```

- The index of the `NULL` value is `NULL`.
- The term “index” here refers only to position within the list of enumeration values. It has nothing to do with table indexes.

For example, a column specified as `ENUM('one', 'two', 'three')` can have any of the values shown here. The index of each value is also shown.

Value	Index
<code>NULL</code>	<code>NULL</code>
<code>'</code>	0
<code>'one'</code>	1
<code>'two'</code>	2
<code>'three'</code>	3

An enumeration can have a maximum of 65,535 elements.

Trailing spaces are automatically deleted from `ENUM` member values in the table definition when a table is created.

When retrieved, values stored into an `ENUM` column are displayed using the lettercase that was used in the column definition. Note that `ENUM` columns can be assigned a character set and collation. For binary or case-sensitive collations, lettercase is taken into account when assigning values to the column.

If you retrieve an `ENUM` value in a numeric context, the column value's index is returned. For example, you can retrieve numeric values from an `ENUM` column like this:

```
mysql> SELECT enum_col+0 FROM tbl_name;
```

If you store a number into an `ENUM` column, the number is treated as the index into the possible values, and the value stored is the enumeration member with that index. (However, this does *not* work with `LOAD DATA`, which treats all input as strings.) If the numeric value is quoted, it is still interpreted as an index if there is no matching string in the list of enumeration values. For these reasons, it is not advisable to define an `ENUM` column with enumeration values that look like numbers, because this can easily become confusing. For example, the following column has enumeration members with string values of `'0'`, `'1'`, and `'2'`, but numeric index values of 1, 2, and 3:

```
numbers ENUM('0','1','2')
```

If you store `2`, it is interpreted as an index value, and becomes `'1'` (the value with index 2). If you store `'2'`, it matches an enumeration value, so it is stored as `'2'`. If you store `'3'`, it does not match any enumeration value, so it is treated as an index and becomes `'2'` (the value with index 3).

```
mysql> INSERT INTO t (numbers) VALUES(2),('2'),('3');
mysql> SELECT * FROM t;
```

```
+-----+
| numbers |
+-----+
| 1       |
| 2       |
| 2       |
+-----+
```

`ENUM` values are sorted according to the order in which the enumeration members were listed in the column specification. (In other words, `ENUM` values are sorted according to their index numbers.) For example, `'a'` sorts before `'b'` for `ENUM('a', 'b')`, but `'b'` sorts before `'a'` for `ENUM('b', 'a')`. The empty string sorts before non-empty strings, and `NULL` values sort before all other enumeration values. To prevent unexpected results, specify the `ENUM` list in alphabetical order. You can also use `GROUP BY CAST(col AS CHAR)` or `GROUP BY CONCAT(col)` to make sure that the column is sorted lexically rather than by index number.

Functions such as `SUM()` or `AVG()` that expect a numeric argument cast the argument to a number if necessary. For `ENUM` values, the cast operation causes the index number to be used.

If you want to determine all possible values for an `ENUM` column, use `SHOW COLUMNS FROM tbl_name LIKE enum_col` and parse the `ENUM` definition in the `Type` column of the output.

## 10.4.5. The `SET` Type

A `SET` is a string object that can have zero or more values, each of which must be chosen from a list of allowed values specified

when the table is created. `SET` column values that consist of multiple set members are specified with members separated by commas (“,”). A consequence of this is that `SET` member values should not themselves contain commas.

For example, a column specified as `SET('one', 'two') NOT NULL` can have any of these values:

```
' '
'one'
'two'
'one,two'
```

A `SET` can have a maximum of 64 different members.

Duplicate values in the definition cause a warning, or an error if strict SQL mode is enabled.

Trailing spaces are automatically deleted from `SET` member values in the table definition when a table is created.

When retrieved, values stored in a `SET` column are displayed using the lettercase that was used in the column definition. Note that `SET` columns can be assigned a character set and collation. For binary or case-sensitive collations, lettercase is taken into account when assigning values to the column.

MySQL stores `SET` values numerically, with the low-order bit of the stored value corresponding to the first set member. If you retrieve a `SET` value in a numeric context, the value retrieved has bits set corresponding to the set members that make up the column value. For example, you can retrieve numeric values from a `SET` column like this:

```
mysql> SELECT set_col+0 FROM tbl_name;
```

If a number is stored into a `SET` column, the bits that are set in the binary representation of the number determine the set members in the column value. For a column specified as `SET('a', 'b', 'c', 'd')`, the members have the following decimal and binary values.

SET Member	Decimal Value	Binary Value
'a'	1	0001
'b'	2	0010
'c'	4	0100
'd'	8	1000

If you assign a value of 9 to this column, that is 1001 in binary, so the first and fourth `SET` value members 'a' and 'd' are selected and the resulting value is 'a,d'.

For a value containing more than one `SET` element, it does not matter what order the elements are listed in when you insert the value. It also does not matter how many times a given element is listed in the value. When the value is retrieved later, each element in the value appears once, with elements listed according to the order in which they were specified at table creation time. For example, suppose that a column is specified as `SET('a', 'b', 'c', 'd')`:

```
mysql> CREATE TABLE myset (col SET('a', 'b', 'c', 'd'));
```

If you insert the values 'a,d', 'd,a', 'a,d,d', 'a,d,a', and 'd,a,d':

```
mysql> INSERT INTO myset (col) VALUES
-> ('a,d'), ('d,a'), ('a,d,a'), ('a,d,d'), ('d,a,d');
Query OK, 5 rows affected (0.01 sec)
Records: 5 Duplicates: 0 Warnings: 0
```

Then all of these values appear as 'a,d' when retrieved:

```
mysql> SELECT col FROM myset;
+-----+
| col   |
+-----+
| a,d   |
| a,d   |
| a,d   |
| a,d   |
| a,d   |
+-----+
5 rows in set (0.04 sec)
```

If you set a `SET` column to an unsupported value, the value is ignored and a warning is issued:

```
mysql> INSERT INTO myset (col) VALUES ('a,d,d,s');
Query OK, 1 row affected, 1 warning (0.03 sec)
```

```
mysql> SHOW WARNINGS;
+-----+-----+-----+
| Level | Code | Message                                     |
+-----+-----+-----+
| Warning | 1265 | Data truncated for column 'col' at row 1 |
+-----+-----+-----+
1 row in set (0.04 sec)

mysql> SELECT col FROM myset;
+-----+
| col |
+-----+
| a,d |
| a,d |
| a,d |
| a,d |
| a,d |
| a,d |
+-----+
6 rows in set (0.01 sec)
```

If strict SQL mode is enabled, attempts to insert invalid `SET` values result in an error.

`SET` values are sorted numerically. `NULL` values sort before non-`NULL` `SET` values.

Functions such as `SUM()` or `AVG()` that expect a numeric argument cast the argument to a number if necessary. For `SET` values, the cast operation causes the numeric value to be used.

Normally, you search for `SET` values using the `FIND_IN_SET()` function or the `LIKE` operator:

```
mysql> SELECT * FROM tbl_name WHERE FIND_IN_SET('value',set_col)>0;
mysql> SELECT * FROM tbl_name WHERE set_col LIKE '%value%';
```

The first statement finds rows where `set_col` contains the `value` set member. The second is similar, but not the same: It finds rows where `set_col` contains `value` anywhere, even as a substring of another set member.

The following statements also are legal:

```
mysql> SELECT * FROM tbl_name WHERE set_col & 1;
mysql> SELECT * FROM tbl_name WHERE set_col = 'val1,val2';
```

The first of these statements looks for values containing the first set member. The second looks for an exact match. Be careful with comparisons of the second type. Comparing set values to `'val1,val2'` returns different results than comparing values to `'val2,val1'`. You should specify the values in the same order they are listed in the column definition.

If you want to determine all possible values for a `SET` column, use `SHOW COLUMNS FROM tbl_name LIKE set_col` and parse the `SET` definition in the `Type` column of the output.

## 10.5. Data Type Storage Requirements

The storage requirements for each of the data types supported by MySQL are listed here by category.

The maximum size of a row in a `MyISAM` table is 65,535 bytes. (However, each `BLOB` or `TEXT` column contributes only 9-12 bytes toward this size.) This limitation may be shared by other storage engines as well. See [Chapter 13, Storage Engines](#), for more information.

### Important

For tables using the `NDBCLUSTER` storage engine, there is the factor of *4-byte alignment* to be taken into account when calculating storage requirements. This means that all `NDB` data storage is done in multiples of 4 bytes. Thus, a column value that would take 15 bytes in a table using a storage engine other than `NDB` requires 16 bytes in an `NDB` table. This requirement applies in addition to any other considerations that are discussed in this section. For example, in `NDBCLUSTER` tables, the `TINYINT`, `SMALLINT`, `MEDIUMINT`, and `INTEGER (INT)` column types each require 4 bytes storage per record due to the alignment factor.

An exception to this rule is the `BIT` type, which is *not* 4-byte aligned. In MySQL Cluster tables, a `BIT(M)` column takes  $M$  bits of storage space. However, if a table definition contains 1 or more `BIT` columns (up to 32 `BIT` columns), then `NDBCLUSTER` reserves 4 bytes (32 bits) per row for these. If a table definition contains more than 32 `BIT` columns (up to 64 such columns), then `NDBCLUSTER` reserves 8 bytes (that is, 64 bits) per row.

In addition, while a `NULL` itself does not require any storage space, `NDBCLUSTER` reserves 4 bytes per row if the table definition contains any columns defined as `NULL`, up to 32 `NULL` columns. (If a MySQL Cluster table is defined with more than 32 `NULL` columns up to 64 `NULL` columns, then 8 bytes per row is reserved.)

When calculating storage requirements for MySQL Cluster tables, you must also remember that every table using the `NDB-`

**CLUSTER** storage engine requires a primary key; if no primary key is defined by the user, then a “hidden” primary key will be created by **NDB**. This hidden primary key consumes 31-35 bytes per table record.

You may find the `ndb_size.pl` utility to be useful for estimating **NDB** storage requirements. This Perl script connects to a current MySQL (non-Cluster) database and creates a report on how much space that database would require if it used the **NDB-CLUSTER** storage engine. See `ndb_size.pl`, for more information.

### Storage Requirements for Numeric Types

Data Type	Storage Required
<code>TINYINT</code>	1 byte
<code>SMALLINT</code>	2 bytes
<code>MEDIUMINT</code>	3 bytes
<code>INT, INTEGER</code>	4 bytes
<code>BIGINT</code>	8 bytes
<code>FLOAT(p)</code>	4 bytes if $0 \leq p \leq 24$ , 8 bytes if $25 \leq p \leq 53$
<code>FLOAT</code>	4 bytes
<code>DOUBLE [PRECISION], REAL</code>	8 bytes
<code>DECIMAL(M,D), NUMERIC(M,D)</code>	Varies; see following discussion
<code>BIT(M)</code>	approximately $(M+7)/8$ bytes

Values for **DECIMAL** (and **NUMERIC**) columns are represented using a binary format that packs nine decimal (base 10) digits into four bytes. Storage for the integer and fractional parts of each value are determined separately. Each multiple of nine digits requires four bytes, and the “leftover” digits require some fraction of four bytes. The storage required for excess digits is given by the following table.

Leftover Digits	Number of Bytes
0	0
1	1
2	1
3	2
4	2
5	3
6	3
7	4
8	4

### Storage Requirements for Date and Time Types

Data Type	Storage Required
<code>DATE</code>	3 bytes
<code>TIME</code>	3 bytes
<code>DATETIME</code>	8 bytes
<code>TIMESTAMP</code>	4 bytes
<code>YEAR</code>	1 byte

The storage requirements shown in the table arise from the way that MySQL represents temporal values:

- **DATE**: A three-byte integer packed as  $DD + MM \times 32 + YYYY \times 16 \times 32$
- **TIME**: A three-byte integer packed as  $DD \times 24 \times 3600 + HH \times 3600 + MM \times 60 + SS$
- **DATETIME**: Eight bytes:
  - A four-byte integer packed as  $YYYY \times 10000 + MM \times 100 + DD$

- A four-byte integer packed as  $HH \times 10000 + MM \times 100 + SS$
- **TIMESTAMP**: A four-byte integer representing seconds UTC since the epoch ('1970-01-01 00:00:00' UTC)
- **YEAR**: A one-byte integer

### Storage Requirements for String Types

In the following table,  $M$  represents the declared column length in characters for nonbinary string types and bytes for binary string types.  $L$  represents the actual length in bytes of a given string value.

Data Type	Storage Required
<b>CHAR</b> ( $M$ )	$M \times w$ bytes, $0 \leq M \leq 255$ , where $w$ is the number of bytes required for the maximum-length character in the character set
<b>BINARY</b> ( $M$ )	$M$ bytes, $0 \leq M \leq 255$
<b>VARCHAR</b> ( $M$ ), <b>VARBINARY</b> ( $M$ )	$L + 1$ bytes if column values require 0 – 255 bytes, $L + 2$ bytes if values may require more than 255 bytes
<b>TINYBLOB</b> , <b>TINYTEXT</b>	$L + 1$ bytes, where $L < 2^8$
<b>BLOB</b> , <b>TEXT</b>	$L + 2$ bytes, where $L < 2^{16}$
<b>MEDIUMBLOB</b> , <b>MEDIUMTEXT</b>	$L + 3$ bytes, where $L < 2^{24}$
<b>LONGBLOB</b> , <b>LONGTEXT</b>	$L + 4$ bytes, where $L < 2^{32}$
<b>ENUM</b> ('value1', 'value2', ...)	1 or 2 bytes, depending on the number of enumeration values (65,535 values maximum)
<b>SET</b> ('value1', 'value2', ...)	1, 2, 3, 4, or 8 bytes, depending on the number of set members (64 members maximum)

Variable-length string types are stored using a length prefix plus data. The length prefix requires from one to four bytes depending on the data type, and the value of the prefix is  $L$  (the byte length of the string). For example, storage for a **MEDIUMTEXT** value requires  $L$  bytes to store the value plus three bytes to store the length of the value.

To calculate the number of bytes used to store a particular **CHAR**, **VARCHAR**, or **TEXT** column value, you must take into account the character set used for that column and whether the value contains multi-byte characters. In particular, when using the **utf8** Unicode character set, you must keep in mind that not all **utf8** characters use the same number of bytes and can require up to three bytes per character. For a breakdown of the storage used for different categories of **utf8** characters, see [Section 9.1.9, “Unicode Support”](#).

**VARCHAR**, **VARBINARY**, and the **BLOB** and **TEXT** types are variable-length types. For each, the storage requirements depend on these factors:

- The actual length of the column value
- The column's maximum possible length
- The character set used for the column, because some character sets contain multi-byte characters

For example, a **VARCHAR(255)** column can hold a string with a maximum length of 255 characters. Assuming that the column uses the **latin1** character set (one byte per character), the actual storage required is the length of the string ( $L$ ), plus one byte to record the length of the string. For the string 'abcd',  $L$  is 4 and the storage requirement is five bytes. If the same column is instead declared to use the **ucs2** double-byte character set, the storage requirement is 10 bytes: The length of 'abcd' is eight bytes and the column requires two bytes to store lengths because the maximum length is greater than 255 (up to 510 bytes).

#### Note

The effective maximum number of *bytes* that can be stored in a **VARCHAR** or **VARBINARY** column is subject to the maximum row size of 65,535 bytes, which is shared among all columns. For a **VARCHAR** column that stores multi-byte characters, the effective maximum number of *characters* is less. For example, **utf8** characters can require up to three bytes per character, so a **VARCHAR** column that uses the **utf8** character set can be declared to be a maximum of 21,844 characters.

The **NDBCLUSTER** storage engine in MySQL 5.1 supports variable-width columns. This means that a **VARCHAR** column in a MySQL Cluster table requires the same amount of storage as it would using any other storage engine, with the exception that such

values are 4-byte aligned. Thus, the string 'abcd' stored in a `VARCHAR(50)` column using the `latin1` character set requires 8 bytes (rather than 6 bytes for the same column value in a `MyISAM` table). This represents a change in behavior from earlier versions of `NDBCLUSTER`, where a `VARCHAR(50)` column would require 52 bytes storage per record regardless of the length of the string being stored.

`TEXT` and `BLOB` columns are implemented differently in the NDB Cluster storage engine, wherein each row in a `TEXT` column is made up of two separate parts. One of these is of fixed size (256 bytes), and is actually stored in the original table. The other consists of any data in excess of 256 bytes, which is stored in a hidden table. The rows in this second table are always 2,000 bytes long. This means that the size of a `TEXT` column is 256 if  $size \leq 256$  (where  $size$  represents the size of the row); otherwise, the size is  $256 + size + (2000 - (size - 256) \% 2000)$ .

The size of an `ENUM` object is determined by the number of different enumeration values. One byte is used for enumerations with up to 255 possible values. Two bytes are used for enumerations having between 256 and 65,535 possible values. See [Section 10.4.4, “The ENUM Type”](#).

The size of a `SET` object is determined by the number of different set members. If the set size is  $N$ , the object occupies  $(N+7) / 8$  bytes, rounded up to 1, 2, 3, 4, or 8 bytes. A `SET` can have a maximum of 64 members. See [Section 10.4.5, “The SET Type”](#).

## 10.6. Choosing the Right Type for a Column

For optimum storage, you should try to use the most precise type in all cases. For example, if an integer column is used for values in the range from 1 to 99999, `MEDIUMINT UNSIGNED` is the best type. Of the types that represent all the required values, this type uses the least amount of storage.

All basic calculations (+, -, \*, and /) with `DECIMAL` columns are done with precision of 65 decimal (base 10) digits. See [Section 10.1.1, “Overview of Numeric Types”](#).

If accuracy is not too important or if speed is the highest priority, the `DOUBLE` type may be good enough. For high precision, you can always convert to a fixed-point type stored in a `BIGINT`. This allows you to do all calculations with 64-bit integers and then convert results back to floating-point values as necessary.

`PROCEDURE ANALYSE` can be used to obtain suggestions for optimal column data types. For more information, see [Section 21.4.1, “PROCEDURE ANALYSE”](#).

## 10.7. Using Data Types from Other Database Engines

To facilitate the use of code written for SQL implementations from other vendors, MySQL maps data types as shown in the following table. These mappings make it easier to import table definitions from other database systems into MySQL.

Other Vendor Type	MySQL Type
<code>BOOL</code>	<code>TINYINT</code>
<code>BOOLEAN</code>	<code>TINYINT</code>
<code>CHARACTER VARYING(M)</code>	<code>VARCHAR(M)</code>
<code>FIXED</code>	<code>DECIMAL</code>
<code>FLOAT4</code>	<code>FLOAT</code>
<code>FLOAT8</code>	<code>DOUBLE</code>
<code>INT1</code>	<code>TINYINT</code>
<code>INT2</code>	<code>SMALLINT</code>
<code>INT3</code>	<code>MEDIUMINT</code>
<code>INT4</code>	<code>INT</code>
<code>INT8</code>	<code>BIGINT</code>
<code>LONG VARBINARY</code>	<code>MEDIUMBLOB</code>
<code>LONG VARCHAR</code>	<code>MEDIUMTEXT</code>
<code>LONG</code>	<code>MEDIUMTEXT</code>
<code>MIDDLEINT</code>	<code>MEDIUMINT</code>
<code>NUMERIC</code>	<code>DECIMAL</code>

Data type mapping occurs at table creation time, after which the original type specifications are discarded. If you create a table with types used by other vendors and then issue a `DESCRIBE tbl_name` statement, MySQL reports the table structure using the equivalent MySQL types. For example:

```
mysql> CREATE TABLE t (a BOOL, b FLOAT8, c LONG VARCHAR, d NUMERIC);
```

Query OK, 0 rows affected (0.00 sec)

mysql> DESCRIBE t;

Field	Type	Null	Key	Default	Extra
a	tinyint(1)	YES		NULL	
b	double	YES		NULL	
c	mediumtext	YES		NULL	
d	decimal(10,0)	YES		NULL	

4 rows in set (0.01 sec)



# Chapter 11. Functions and Operators

Expressions can be used at several points in SQL statements, such as in the `ORDER BY` or `HAVING` clauses of `SELECT` statements, in the `WHERE` clause of a `SELECT`, `DELETE`, or `UPDATE` statement, or in `SET` statements. Expressions can be written using literal values, column values, `NULL`, built-in functions, stored functions, user-defined functions, and operators. This chapter describes the functions and operators that are allowed for writing expressions in MySQL. Instructions for writing stored functions and user-defined functions are given in [Section 18.2, “Using Stored Routines \(Procedures and Functions\)”](#), and [Section 21.3, “Adding New Functions to MySQL”](#). See [Section 8.2.4, “Function Name Parsing and Resolution”](#), for the rules describing how the server interprets references to different kinds of functions.

An expression that contains `NULL` always produces a `NULL` value unless otherwise indicated in the documentation for a particular function or operator.

## Note

By default, there must be no whitespace between a function name and the parenthesis following it. This helps the MySQL parser distinguish between function calls and references to tables or columns that happen to have the same name as a function. However, spaces around function arguments are permitted.

You can tell the MySQL server to accept spaces after function names by starting it with the `--sql-mode=IGNORE_SPACE` option. (See [Section 5.1.7, “Server SQL Modes”](#).) Individual client programs can request this behavior by using the `CLIENT_IGNORE_SPACE` option for `mysql_real_connect()`. In either case, all function names become reserved words.

For the sake of brevity, most examples in this chapter display the output from the `mysql` program in abbreviated form. Rather than showing examples in this format:

```
mysql> SELECT MOD(29,9);
+-----+
| mod(29,9) |
+-----+
|          2 |
+-----+
1 rows in set (0.00 sec)
```

This format is used instead:

```
mysql> SELECT MOD(29,9);
-> 2
```

## 11.1. Operator and Function Reference

### Note

This table is part of an ongoing process to expand and simplify the information provided on these elements. Further improvements to the table, and corresponding descriptions will be applied over the coming months.

Name	Description
<code>ABS()</code>	Return the absolute value
<code>ACOS()</code>	Return the arc cosine
<code>ADDDATE()</code> (v4.1.1)	Add dates
<code>ADDTIME()</code> (v4.1.1)	Add time
<code>AES_DECRYPT()</code>	Decrypt using AES
<code>AES_ENCRYPT()</code>	Encrypt using AES
<code>AND, &amp;&amp;</code>	Logical AND
<code>ASCII()</code>	Return numeric value of left-most character
<code>ASIN()</code>	Return the arc sine
<code>ATAN2(), ATAN()</code>	Return the arc tangent of the two arguments
<code>ATAN()</code>	Return the arc tangent
<code>AVG()</code>	Return the average value of the argument
<code>BENCHMARK()</code>	Repeatedly execute an expression
<code>BETWEEN ... AND ...</code>	Check whether a value is within a range of values
<code>BIN()</code>	Return a string representation of the argument

Name	Description
<code>BINARY</code>	Cast a string to a binary string
<code>BIT_AND()</code>	Return bitwise and
<code>BIT_COUNT()</code>	Return the number of bits that are set
<code>BIT_LENGTH()</code>	Return length of argument in bits
<code>BIT_OR()</code>	Return bitwise or
<code>BIT_XOR()</code> (v4.1.1)	Return bitwise xor
<code>&amp;</code>	Bitwise AND
<code>~</code>	Invert bits
<code> </code>	Bitwise OR
<code>^</code>	Bitwise XOR
<code>CASE</code>	Case operator
<code>CAST()</code>	Cast a value as a certain type
<code>CEIL()</code>	Return the smallest integer value not less than the argument
<code>CEILING()</code>	Return the smallest integer value not less than the argument
<code>CHAR_LENGTH()</code>	Return number of characters in argument
<code>CHAR()</code>	Return the character for each integer passed
<code>CHARACTER_LENGTH()</code>	A synonym for <code>CHAR_LENGTH()</code>
<code>CHARSET()</code> (v4.1.0)	Return the character set of the argument
<code>COALESCE()</code>	Return the first non-NULL argument
<code>COERCIBILITY()</code> (v4.1.1)	Return the collation coercibility value of the string argument
<code>COLLATION()</code> (v4.1.0)	Return the collation of the string argument
<code>COMPRESS()</code> (v4.1.1)	Return result as a binary string
<code>CONCAT_WS()</code>	Return concatenate with separator
<code>CONCAT()</code>	Return concatenated string
<code>CONNECTION_ID()</code>	Return the connection ID (thread ID) for the connection
<code>CONV()</code>	Convert numbers between different number bases
<code>CONVERT_TZ()</code> (v4.1.3)	Convert from one timezone to another
<code>Convert()</code>	Cast a value as a certain type
<code>COS()</code>	Return the cosine
<code>COT()</code>	Return the cotangent
<code>COUNT(DISTINCT)</code>	Return the count of a number of different values
<code>COUNT()</code>	Return a count of the number of rows returned
<code>CRC32()</code> (v4.1.0)	Compute a cyclic redundancy check value
<code>CURDATE()</code>	Return the current date
<code>CURRENT_DATE()</code> , <code>CURRENT_DATE</code>	Synonyms for <code>CURDATE()</code>
<code>CURRENT_TIME()</code> , <code>CURRENT_TIME</code>	Synonyms for <code>CURTIME()</code>
<code>CURRENT_TIMESTAMP()</code> , <code>CURRENT_TIMESTAMP</code>	Synonyms for <code>NOW()</code>
<code>CURRENT_USER()</code> , <code>CURRENT_USER</code>	Return the user name and host name combination
<code>CURTIME()</code>	Return the current time
<code>DATABASE()</code>	Return the default (current) database name
<code>DATE_ADD()</code>	Add two dates
<code>DATE_FORMAT()</code>	Format date as specified
<code>DATE_SUB()</code>	Subtract two dates
<code>DATE()</code> (v4.1.1)	Extract the date part of a date or datetime expression
<code>DATEDIFF()</code> (v4.1.1)	Subtract two dates
<code>DAY()</code> (v4.1.1)	Synonym for <code>DAYOFMONTH()</code>
<code>DAYNAME()</code> (v4.1.21)	Return the name of the weekday

Name	Description
DAYOFMONTH ( )	Return the day of the month (0-31)
DAYOFWEEK ( )	Return the weekday index of the argument
DAYOFYEAR ( )	Return the day of the year (1-366)
DECODE ( )	Decodes a string encrypted using ENCODE()
DEFAULT ( )	Return the default value for a table column
DEGREES ( )	Convert radians to degrees
DES_DECRYPT ( )	Decrypt a string
DES_ENCRYPT ( )	Encrypt a string
DIV(v4.1.0)	Integer division
/	Division operator
ELT ( )	Return string at index number
ENCODE ( )	Encode a string
ENCRYPT ( )	Encrypt a string
<=>	NULL-safe equal to operator
=	Equal operator
EXP ( )	Raise to the power of
EXPORT_SET ( )	Return a string such that for every bit set in the value bits, you get an on string and for every unset bit, you get an off string
EXTRACT	Extract part of a date
ExtractValue ( ) (v5.1.5)	Extracts a value from an XML string using XPath notation
FIELD ( )	Return the index (position) of the first argument in the subsequent arguments
FIND_IN_SET ( )	Return the index position of the first argument within the second argument
FLOOR ( )	Return the largest integer value not greater than the argument
FORMAT ( )	Return a number formatted to specified number of decimal places
FOUND_ROWS ( )	For a SELECT with a LIMIT clause, the number of rows that would be returned were there no LIMIT clause
FROM_DAYS ( )	Convert a day number to a date
FROM_UNIXTIME ( )	Format UNIX timestamp as a date
GET_FORMAT ( ) (v4.1.1)	Return a date format string
GET_LOCK ( )	Get a named lock
>=	Greater than or equal operator
>	Greater than operator
GREATEST ( )	Return the largest argument
GROUP_CONCAT ( ) (v4.1)	Return a concatenated string
HEX ( )	Return a hexadecimal representation of a decimal or string value
HOUR ( )	Extract the hour
IF ( )	If/else construct
IFNULL ( )	Null if/else construct
IN ( )	Check whether a value is within a set of values
INET_ATON ( )	Return the numeric value of an IP address
INET_NTOA ( )	Return the IP address from a numeric value
INSERT ( )	Insert a substring at the specified position up to the specified number of characters
INSTR ( )	Return the index of the first occurrence of substring
INTERVAL ( )	Return the index of the argument that is less than the first argument
IS_FREE_LOCK ( )	Checks whether the named lock is free
IS NOT NULL	NOT NULL value test
IS NOT	Test a value against a boolean

Name	Description
IS NULL	NULL value test
IS_USED_LOCK ( ) (v4.1.0)	Checks whether the named lock is in use. Return connection identifier if true.
IS	Test a value against a boolean
ISNULL ( )	Test whether the argument is NULL
LAST_DAY(v4.1.1)	Return the last day of the month for the argument
LAST_INSERT_ID ( )	Value of the AUTOINCREMENT column for the last INSERT
LCASE ( )	Synonym for LOWER()
LEAST ( )	Return the smallest argument
<<	Left shift
LEFT ( )	Return the leftmost number of characters as specified
LENGTH ( )	Return the length of a string in bytes
<=	Less than or equal operator
<	Less than operator
LIKE	Simple pattern matching
LN ( )	Return the natural logarithm of the argument
LOAD_FILE ( )	Load the named file
LOCALTIME ( ), LOCALTIME	Synonym for NOW()
LOCALTIMESTAMP, LOCALTIMESTAMP ( ) (v4.0.6)	Synonym for NOW()
LOCATE ( )	Return the position of the first occurrence of substring
LOG10 ( )	Return the base-10 logarithm of the argument
LOG2 ( )	Return the base-2 logarithm of the argument
LOG ( )	Return the natural logarithm of the first argument
LOWER ( )	Return the argument in lowercase
LPAD ( )	Return the string argument, left-padded with the specified string
LTRIM ( )	Remove leading spaces
MAKE_SET ( )	Return a set of comma-separated strings that have the corresponding bit in bits set
MAKEDATE ( ) (v4.1.1)	Create a date from the year and day of year
MAKETIME(v4.1.1)	MAKETIME()
MASTER_POS_WAIT ( )	Block until the slave has read and applied all updates up to the specified position
MATCH	Perform full-text search
MAX ( )	Return the maximum value
MD5 ( )	Calculate MD5 checksum
MICROSECOND ( ) (v4.1.1)	Return the microseconds from argument
MID ( )	Return a substring starting from the specified position
MIN ( )	Return the minimum value
-	Minus operator
MINUTE ( )	Return the minute from the argument
MOD ( )	Return the remainder
%	Modulo operator
MONTH ( )	Return the month from the date passed
MONTHNAME ( ) (v4.1.21)	Return the name of the month
NAME_CONST ( ) (v5.0.12)	Causes the column to have the given name
NOT BETWEEN ... AND ...	Check whether a value is not within a range of values
!=, <>	Not equal operator
NOT IN ( )	Check whether a value is not within a set of values

Name	Description
NOT LIKE	Negation of simple pattern matching
NOT REGEXP	Negation of REGEXP
NOT, !	Negates value
NOW( )	Return the current date and time
NULLIF( )	Return NULL if expr1 = expr2
OCT( )	Return an octal representation of a decimal number
OCTET_LENGTH( )	A synonym for LENGTH()
OLD_PASSWORD( )(v4.1)	Return the value of the old (pre-4.1) implementation of PASSWORD
, OR	Logical OR
ORD( )	Return character code for leftmost character of the argument
PASSWORD( )	Calculate and return a password string
PERIOD_ADD( )	Add a period to a year-month
PERIOD_DIFF( )	Return the number of months between periods
PI( )	Return the value of pi
+	Addition operator
POSITION( )	A synonym for LOCATE()
POW( )	Return the argument raised to the specified power
POWER( )	Return the argument raised to the specified power
PROCEDURE ANALYSE( )	Analyze the results of a query
QUARTER( )	Return the quarter from a date argument
QUOTE( )	Escape the argument for use in an SQL statement
RADIANS( )	Return argument converted to radians
RAND( )	Return a random floating-point value
REGEXP	Pattern matching using regular expressions
RELEASE_LOCK( )	Releases the named lock
REPEAT( )	Repeat a string the specified number of times
REPLACE( )	Replace occurrences of a specified string
REVERSE( )	Reverse the characters in a string
>>	Right shift
RIGHT( )	Return the specified rightmost number of characters
RLIKE	Synonym for REGEXP
ROUND( )	Round the argument
ROW_COUNT( )(v5.0.1)	The number of rows updated
RPAD( )	Append string the specified number of times
RTRIM( )	Remove trailing spaces
SCHEMA( )(v5.0.2)	A synonym for DATABASE()
SEC_TO_TIME( )	Converts seconds to 'HH:MM:SS' format
SECOND( )	Return the second (0-59)
SESSION_USER( )	Synonym for USER()
SHA1( ), SHA( )	Calculate an SHA-1 160-bit checksum
SIGN( )	Return the sign of the argument
SIN( )	Return the sine of the argument
SLEEP( )(v5.0.12)	Sleep for a number of seconds
SOUNDEX( )	Return a soundex string
SOUNDS LIKE(v4.1.0)	Compare sounds
SPACE( )	Return a string of the specified number of spaces
SQRT( )	Return the square root of the argument

Name	Description
STD ( )	Return the population standard deviation
STDDEV_POP ( ) (v5.0.3)	Return the population standard deviation
STDDEV_SAMP ( ) (v5.0.3)	Return the sample standard deviation
STDDEV ( )	Return the population standard deviation
STR_TO_DATE ( ) (v4.1.1)	Convert a string to a date
STRCMP ( )	Compare two strings
SUBDATE ( )	A synonym for DATE_SUB() when invoked with three arguments
SUBSTR ( )	Return the substring as specified
SUBSTRING_INDEX ( )	Return a substring from a string before the specified number of occurrences of the delimiter
SUBSTRING ( )	Return the substring as specified
SUBTIME ( ) (v4.1.1)	Subtract times
SUM ( )	Return the sum
SYSDATE ( )	Return the time at which the function executes
SYSTEM_USER ( )	Synonym for USER()
TAN ( )	Return the tangent of the argument
TIME_FORMAT ( )	Format as time
TIME_TO_SEC ( )	Return the argument converted to seconds
TIME ( ) (v4.1.1)	Extract the time portion of the expression passed
TIMEDIFF ( ) (v4.1.1)	Subtract time
*	Times operator
TIMESTAMP ( ) (v4.1.1)	With a single argument, this function returns the date or datetime expression; with two arguments, the sum of the arguments
TIMESTAMPADD ( ) (v5.0.0)	Add an interval to a datetime expression
TIMESTAMPDIFF ( ) (v5.0.0)	Subtract an interval from a datetime expression
TO_DAYS ( )	Return the date argument converted to days
TRIM ( )	Remove leading and trailing spaces
TRUNCATE ( )	Truncate to specified number of decimal places
UCASE ( )	Synonym for UPPER()
-	Change the sign of the argument
UNCOMPRESS ( ) (v4.1.1)	Uncompress a string compressed
UNCOMPRESSED_LENGTH ( ) (v4.1.1)	Return the length of a string before compression
UNHEX ( ) (v4.1.2)	Convert each pair of hexadecimal digits to a character
UNIX_TIMESTAMP ( )	Return a UNIX timestamp
UpdateXML ( ) (v5.1.5)	Return replaced XML fragment
UPPER ( )	Convert to uppercase
USER ( )	Return the current user name and host name
UTC_DATE ( ) (v4.1.1)	Return the current UTC date
UTC_TIME ( ) (v4.1.1)	Return the current UTC time
UTC_TIMESTAMP ( ) (v4.1.1)	Return the current UTC date and time
UUID_SHORT ( ) (v5.1.20)	Return an integer-valued universal identifier
UUID ( ) (v4.1.2)	Return a Universal Unique Identifier (UUID)
VALUES ( ) (v4.1.1)	Defines the values to be used during an INSERT
VAR_POP ( ) (v5.0.3)	Return the population standard variance
VAR_SAMP ( ) (v5.0.3)	Return the sample variance
VARIANCE ( ) (v4.1)	Return the population standard variance
VERSION ( )	Returns a string that indicates the MySQL server version
WEEK ( )	Return the week number

Name	Description
WEEKDAY ( )	Return the weekday index
WEEKOFYEAR ( ) (v4.1.1)	Return the calendar week of the date (0-53)
XOR	Logical XOR
YEAR ( )	Return the year
YEARWEEK ( )	Return the year and week

## 11.2. Operators

Name	Description
AND, &&	Logical AND
BETWEEN ... AND ...	Check whether a value is within a range of values
BINARY	Cast a string to a binary string
&	Bitwise AND
~	Invert bits
	Bitwise OR
^	Bitwise XOR
CASE	Case operator
DIV(v4.1.0)	Integer division
/	Division operator
<=>	NULL-safe equal to operator
=	Equal operator
>=	Greater than or equal operator
>	Greater than operator
IS NOT NULL	NOT NULL value test
IS NOT	Test a value against a boolean
IS NULL	NULL value test
IS	Test a value against a boolean
<<	Left shift
<=	Less than or equal operator
<	Less than operator
LIKE	Simple pattern matching
-	Minus operator
%	Modulo operator
NOT BETWEEN ... AND ...	Check whether a value is not within a range of values
!=, <>	Not equal operator
NOT LIKE	Negation of simple pattern matching
NOT REGEXP	Negation of REGEXP
NOT, !	Negates value
, OR	Logical OR
+	Addition operator
REGEXP	Pattern matching using regular expressions
>>	Right shift
RLIKE	Synonym for REGEXP
SOUNDS LIKE(v4.1.0)	Compare sounds
*	Times operator
-	Change the sign of the argument
XOR	Logical XOR

## 11.2.1. Operator Precedence

Operator precedences are shown in the following list, from highest precedence to the lowest. Operators that are shown together on a line have the same precedence.

```

INTERVAL
BINARY, COLLATE
!
- (unary minus), ~ (unary bit inversion)
^
*, /, DIV, %, MOD
-, +
<<, >>
&
|
=, <=>, >=, >, <=, <, <>, !=, IS, LIKE, REGEXP, IN
BETWEEN, CASE, WHEN, THEN, ELSE
NOT
&&, AND
XOR
||, OR
:=
    
```

The `||` operator has a precedence between `^` and the unary operators if the `PIPES_AS_CONCAT` SQL mode is enabled.

### Note

If the `HIGH_NOT_PRECEDENCE` SQL mode is enabled, the precedence of `NOT` is the same as that of the `!` operator. See [Section 5.1.7, “Server SQL Modes”](#).

The precedence of operators determines the order of evaluation of terms in an expression. To override this order and group terms explicitly, use parentheses. For example:

```

mysql> SELECT 1+2*3;
-> 7
mysql> SELECT (1+2)*3;
-> 9
    
```

## 11.2.2. Type Conversion in Expression Evaluation

When an operator is used with operands of different types, type conversion occurs to make the operands compatible. Some conversions occur implicitly. For example, MySQL automatically converts numbers to strings as necessary, and vice versa.

```

mysql> SELECT 1+'1';
-> 2
mysql> SELECT CONCAT(2,' test');
-> '2 test'
    
```

It is also possible to perform explicit conversions. If you want to convert a number to a string explicitly, use the `CAST()` or `CONCAT()` function (`CAST()` is preferable):

```

mysql> SELECT 38.8, CAST(38.8 AS CHAR);
-> 38.8, '38.8'
mysql> SELECT 38.8, CONCAT(38.8);
-> 38.8, '38.8'
    
```

The following rules describe how conversion occurs for comparison operations:

- If one or both arguments are `NULL`, the result of the comparison is `NULL`, except for the `NULL`-safe `<=>` equality comparison operator. For `NULL <=> NULL`, the result is true.
- If both arguments in a comparison operation are strings, they are compared as strings.
- If both arguments are integers, they are compared as integers.
- Hexadecimal values are treated as binary strings if not compared to a number.
- If one of the arguments is a `TIMESTAMP` or `DATETIME` column and the other argument is a constant, the constant is converted to a timestamp before the comparison is performed. This is done to be more ODBC-friendly. Note that this is not done for the arguments to `IN()`! To be safe, always use complete datetime, date, or time strings when doing comparisons.
- In all other cases, the arguments are compared as floating-point (real) numbers.

The following examples illustrate conversion of strings to numbers for comparison operations:



```
mysql> SELECT 1 > '6x';
-> 0
mysql> SELECT 7 > '6x';
-> 1
mysql> SELECT 0 > 'x6';
-> 0
mysql> SELECT 0 = 'x6';
-> 1
```

Note that when you are comparing a string column with a number, MySQL cannot use an index on the column to look up the value quickly. If *str\_col* is an indexed string column, the index cannot be used when performing the lookup in the following statement:

```
SELECT * FROM tbl_name WHERE str_col=1;
```

The reason for this is that there are many different strings that may convert to the value 1, such as '1', ' 1', or '1a'.

Comparisons that use floating-point numbers (or values that are converted to floating-point numbers) are approximate because such numbers are inexact. This might lead to results that appear inconsistent:

```
mysql> SELECT '18015376320243458' = 18015376320243458;
-> 1
mysql> SELECT '18015376320243459' = 18015376320243459;
-> 0
```

Such results can occur because the values are converted to floating-point numbers, which have only 53 bits of precision and are subject to rounding:

```
mysql> SELECT '18015376320243459'+0.0;
-> 1.8015376320243e+16
```

Furthermore, the conversion from string to floating-point and from integer to floating-point do not necessarily occur the same way. The integer may be converted to floating-point by the CPU, whereas the string is converted digit by digit in an operation that involves floating-point multiplications.

The results shown will vary on different systems, and can be affected by factors such as computer architecture or the compiler version or optimization level. One way to avoid such problems is to use `CAST()` so that a value will not be converted implicitly to a float-point number:

```
mysql> SELECT CAST('18015376320243459' AS UNSIGNED) = 18015376320243459;
-> 1
```

For more information about floating-point comparisons, see [Section B.1.5.8, “Problems with Floating-Point Comparisons”](#).

### 11.2.3. Comparison Functions and Operators

Name	Description
<code>BETWEEN ... AND ...</code>	Check whether a value is within a range of values
<code>COALESCE()</code>	Return the first non-NULL argument
<code>&lt;=&gt;</code>	NULL-safe equal to operator
<code>=</code>	Equal operator
<code>&gt;=</code>	Greater than or equal operator
<code>&gt;</code>	Greater than operator
<code>GREATEST()</code>	Return the largest argument
<code>IN()</code>	Check whether a value is within a set of values
<code>INTERVAL()</code>	Return the index of the argument that is less than the first argument
<code>IS NOT NULL</code>	NOT NULL value test
<code>IS NOT</code>	Test a value against a boolean
<code>IS NULL</code>	NULL value test
<code>IS</code>	Test a value against a boolean
<code>ISNULL()</code>	Test whether the argument is NULL
<code>LEAST()</code>	Return the smallest argument
<code>&lt;=</code>	Less than or equal operator

Name	Description
<	Less than operator
LIKE	Simple pattern matching
NOT BETWEEN ... AND ...	Check whether a value is not within a range of values
!=, <>	Not equal operator
NOT IN()	Check whether a value is not within a set of values
NOT LIKE	Negation of simple pattern matching
STRCMP()	Compare two strings

Comparison operations result in a value of 1 (TRUE), 0 (FALSE), or NULL. These operations work for both numbers and strings. Strings are automatically converted to numbers and numbers to strings as necessary.

The following relational comparison operators can be used to compare not only scalar operands, but row operands:

```
= > < >= <= <> !=
```

For examples of row comparisons, see [Section 12.2.9.5, “Row Subqueries”](#).

Some of the functions in this section return values other than 1 (TRUE), 0 (FALSE), or NULL. For example, LEAST() and GREATEST(). However, the value they return is based on comparison operations performed according to the rules described in [Section 11.2.2, “Type Conversion in Expression Evaluation”](#).

To convert a value to a specific type for comparison purposes, you can use the CAST() function. String values can be converted to a different character set using CONVERT(). See [Section 11.9, “Cast Functions and Operators”](#).

By default, string comparisons are not case sensitive and use the current character set. The default is latin1 (cp1252 West European), which also works well for English.

- =

Equal:

```
mysql> SELECT 1 = 0;
-> 0
mysql> SELECT '0' = 0;
-> 1
mysql> SELECT '0.0' = 0;
-> 1
mysql> SELECT '0.01' = 0;
-> 0
mysql> SELECT '.01' = 0.01;
-> 1
```

- <=>

NULL-safe equal. This operator performs an equality comparison like the = operator, but returns 1 rather than NULL if both operands are NULL, and 0 rather than NULL if one operand is NULL.

```
mysql> SELECT 1 <=> 1, NULL <=> NULL, 1 <=> NULL;
-> 1, 1, 0
mysql> SELECT 1 = 1, NULL = NULL, 1 = NULL;
-> 1, NULL, NULL
```

- <>, !=

Not equal:

```
mysql> SELECT '.01' <> '0.01';
-> 1
mysql> SELECT .01 <> '0.01';
-> 0
mysql> SELECT 'zapp' <> 'zappp';
-> 1
```

- <=

Less than or equal:

```
mysql> SELECT 0.1 <= 2;
```

```
-> 1
```

- <

Less than:

```
mysql> SELECT 2 < 2;
-> 0
```

- >=

Greater than or equal:

```
mysql> SELECT 2 >= 2;
-> 1
```

- >

Greater than:

```
mysql> SELECT 2 > 2;
-> 0
```

- IS *boolean\_value*

Tests a value against a boolean value, where *boolean\_value* can be TRUE, FALSE, or UNKNOWN.

```
mysql> SELECT 1 IS TRUE, 0 IS FALSE, NULL IS UNKNOWN;
-> 1, 1, 1
```

- IS NOT *boolean\_value*

Tests a value against a boolean value, where *boolean\_value* can be TRUE, FALSE, or UNKNOWN.

```
mysql> SELECT 1 IS NOT UNKNOWN, 0 IS NOT UNKNOWN, NULL IS NOT UNKNOWN;
-> 1, 1, 0
```

- IS NULL

Tests whether a value is NULL.

```
mysql> SELECT 1 IS NULL, 0 IS NULL, NULL IS NULL;
-> 0, 0, 1
```

To work well with ODBC programs, MySQL supports the following extra features when using IS NULL:

- You can find the row that contains the most recent AUTO\_INCREMENT value by issuing a statement of the following form immediately after generating the value:

```
SELECT * FROM tbl_name WHERE auto_col IS NULL
```

This behavior can be disabled by setting `sql_auto_is_null = 0`. See [Section 5.1.4, “Session System Variables”](#).

- For DATE and DATETIME columns that are declared as NOT NULL, you can find the special date '0000-00-00' by using a statement like this:

```
SELECT * FROM tbl_name WHERE date_column IS NULL
```

This is needed to get some ODBC applications to work because ODBC does not support a '0000-00-00' date value.

- IS NOT NULL

Tests whether a value is not NULL.

```
mysql> SELECT 1 IS NOT NULL, 0 IS NOT NULL, NULL IS NOT NULL;
-> 1, 1, 0
```

- *expr* BETWEEN *min* AND *max*

If *expr* is greater than or equal to *min* and *expr* is less than or equal to *max*, `BETWEEN` returns 1, otherwise it returns 0. This is equivalent to the expression `(min <= expr AND expr <= max)` if all the arguments are of the same type. Otherwise type conversion takes place according to the rules described in [Section 11.2.2, “Type Conversion in Expression Evaluation”](#), but applied to all the three arguments.

```
mysql> SELECT 2 BETWEEN 1 AND 3, 2 BETWEEN 3 AND 1;
-> 1, 0
mysql> SELECT 1 BETWEEN 2 AND 3;
-> 0
mysql> SELECT 'b' BETWEEN 'a' AND 'c';
-> 1
mysql> SELECT 2 BETWEEN 2 AND '3';
-> 1
mysql> SELECT 2 BETWEEN 2 AND 'x-3';
-> 0
```

For best results when using `BETWEEN` with date or time values, you should use `CAST()` to explicitly convert the values to the desired data type. Examples: If you compare a `DATETIME` to two `DATE` values, convert the `DATE` values to `DATETIME` values. If you use a string constant such as `'2001-1-1'` in a comparison to a `DATE`, cast the string to a `DATE`.

- `expr NOT BETWEEN min AND max`

This is the same as `NOT (expr BETWEEN min AND max)`.

- `COALESCE(value, ...)`

Returns the first non-`NULL` value in the list, or `NULL` if there are no non-`NULL` values.

```
mysql> SELECT COALESCE(NULL,1);
-> 1
mysql> SELECT COALESCE(NULL,NULL,NULL);
-> NULL
```

- `GREATEST(value1,value2,...)`

With two or more arguments, returns the largest (maximum-valued) argument. The arguments are compared using the same rules as for `LEAST()`.

```
mysql> SELECT GREATEST(2,0);
-> 2
mysql> SELECT GREATEST(34.0,3.0,5.0,767.0);
-> 767.0
mysql> SELECT GREATEST('B','A','C');
-> 'C'
```

`GREATEST()` returns `NULL` if any argument is `NULL`.

- `expr IN (value, ...)`

Returns 1 if *expr* is equal to any of the values in the `IN` list, else returns 0. If all values are constants, they are evaluated according to the type of *expr* and sorted. The search for the item then is done using a binary search. This means `IN` is very quick if the `IN` value list consists entirely of constants. Otherwise, type conversion takes place according to the rules described in [Section 11.2.2, “Type Conversion in Expression Evaluation”](#), but applied to all the arguments.

```
mysql> SELECT 2 IN (0,3,5,7);
-> 0
mysql> SELECT 'wefwf' IN ('wee','wefwf','weg');
-> 1
```

You should never mix quoted and unquoted values in an `IN` list because the comparison rules for quoted values (such as strings) and unquoted values (such as numbers) differ. Mixing types may therefore lead to inconsistent results. For example, do not write an `IN` expression like this:

```
SELECT val1 FROM tbl1 WHERE val1 IN (1,2,'a');
```

Instead, write it like this:

```
SELECT val1 FROM tbl1 WHERE val1 IN ('1','2','a');
```

The number of values in the `IN` list is only limited by the `max_allowed_packet` value.

To comply with the SQL standard, `IN` returns `NULL` not only if the expression on the left hand side is `NULL`, but also if no match is found in the list and one of the expressions in the list is `NULL`.

`IN()` syntax can also be used to write certain types of subqueries. See [Section 12.2.9.3, “Subqueries with ANY, IN, and SOME”](#).

- `expr NOT IN (value, ...)`

This is the same as `NOT (expr IN (value, ...))`.

- `ISNULL(expr)`

If `expr` is `NULL`, `ISNULL()` returns `1`, otherwise it returns `0`.

```
mysql> SELECT ISNULL(1+1);
-> 0
mysql> SELECT ISNULL(1/0);
-> 1
```

`ISNULL()` can be used instead of `=` to test whether a value is `NULL`. (Comparing a value to `NULL` using `=` always yields false.)

The `ISNULL()` function shares some special behaviors with the `IS NULL` comparison operator. See the description of `IS NULL`.

- `INTERVAL(N, N1, N2, N3, ...)`

Returns `0` if  $N < N1$ , `1` if  $N < N2$  and so on or `-1` if `N` is `NULL`. All arguments are treated as integers. It is required that  $N1 < N2 < N3 < \dots < Nn$  for this function to work correctly. This is because a binary search is used (very fast).

```
mysql> SELECT INTERVAL(23, 1, 15, 17, 30, 44, 200);
-> 3
mysql> SELECT INTERVAL(10, 1, 10, 100, 1000);
-> 2
mysql> SELECT INTERVAL(22, 23, 30, 44, 200);
-> 0
```

- `LEAST(value1, value2, ...)`

With two or more arguments, returns the smallest (minimum-valued) argument. The arguments are compared using the following rules:

- If the return value is used in an `INTEGER` context or all arguments are integer-valued, they are compared as integers.
- If the return value is used in a `REAL` context or all arguments are real-valued, they are compared as reals.
- If any argument is a case-sensitive string, the arguments are compared as case-sensitive strings.
- In all other cases, the arguments are compared as case-insensitive strings.

`LEAST()` returns `NULL` if any argument is `NULL`.

```
mysql> SELECT LEAST(2,0);
-> 0
mysql> SELECT LEAST(34.0,3.0,5.0,767.0);
-> 3.0
mysql> SELECT LEAST('B','A','C');
-> 'A'
```

Note that the preceding conversion rules can produce strange results in some borderline cases:

```
mysql> SELECT CAST(LEAST(3600, 9223372036854775808.0) as SIGNED);
-> -9223372036854775808
```

This happens because MySQL reads `9223372036854775808.0` in an integer context. The integer representation is not good enough to hold the value, so it wraps to a signed integer.

## 11.2.4. Logical Operators

Name	Description
<code>AND, &amp;&amp;</code>	Logical AND
<code>NOT, !</code>	Negates value
<code>  , OR</code>	Logical OR

Name	Description
XOR	Logical XOR

In SQL, all logical operators evaluate to **TRUE**, **FALSE**, or **NULL** (**UNKNOWN**). In MySQL, these are implemented as 1 (**TRUE**), 0 (**FALSE**), and **NULL**. Most of this is common to different SQL database servers, although some servers may return any nonzero value for **TRUE**.

Note that MySQL evaluates any nonzero or non-**NULL** value to **TRUE**. For example, the following statements all assess to **TRUE**:

```
mysql> SELECT 10 IS TRUE;
-> 1
mysql> SELECT -10 IS TRUE;
-> 1
mysql> SELECT 'string' IS NOT NULL;
-> 1
```

- **NOT, !**

Logical NOT. Evaluates to 1 if the operand is 0, to 0 if the operand is nonzero, and **NOT NULL** returns **NULL**.

```
mysql> SELECT NOT 10;
-> 0
mysql> SELECT NOT 0;
-> 1
mysql> SELECT NOT NULL;
-> NULL
mysql> SELECT ! (1+1);
-> 0
mysql> SELECT ! 1+1;
-> 1
```

The last example produces 1 because the expression evaluates the same way as  $(!1)+1$ .

- **AND, &&**

Logical AND. Evaluates to 1 if all operands are nonzero and not **NULL**, to 0 if one or more operands are 0, otherwise **NULL** is returned.

```
mysql> SELECT 1 && 1;
-> 1
mysql> SELECT 1 && 0;
-> 0
mysql> SELECT 1 && NULL;
-> NULL
mysql> SELECT 0 && NULL;
-> 0
mysql> SELECT NULL && 0;
-> 0
```

- **OR, ||**

Logical OR. When both operands are non-**NULL**, the result is 1 if any operand is nonzero, and 0 otherwise. With a **NULL** operand, the result is 1 if the other operand is nonzero, and **NULL** otherwise. If both operands are **NULL**, the result is **NULL**.

```
mysql> SELECT 1 || 1;
-> 1
mysql> SELECT 1 || 0;
-> 1
mysql> SELECT 0 || 0;
-> 0
mysql> SELECT 0 || NULL;
-> NULL
mysql> SELECT 1 || NULL;
-> 1
```

- **XOR**

Logical XOR. Returns **NULL** if either operand is **NULL**. For non-**NULL** operands, evaluates to 1 if an odd number of operands is nonzero, otherwise 0 is returned.

```
mysql> SELECT 1 XOR 1;
-> 0
mysql> SELECT 1 XOR 0;
-> 1
mysql> SELECT 1 XOR NULL;
-> NULL
mysql> SELECT 1 XOR 1 XOR 1;
-> 1
```

```
-> 1
```

`a XOR b` is mathematically equal to `(a AND (NOT b)) OR ((NOT a) and b)`.

## 11.3. Control Flow Functions

Name	Description
<code>CASE</code>	Case operator
<code>IF()</code>	If/else construct
<code>IFNULL()</code>	Null if/else construct
<code>NULLIF()</code>	Return NULL if <code>expr1 = expr2</code>

- `CASE value WHEN [compare_value] THEN result [WHEN [compare_value] THEN result ...] [ELSE result] END`

```
CASE WHEN [condition] THEN result [WHEN [condition] THEN result ...] [ELSE result] END
```

The first version returns the *result* where *value=compare\_value*. The second version returns the result for the first condition that is true. If there was no matching result value, the result after `ELSE` is returned, or `NULL` if there is no `ELSE` part.

```
mysql> SELECT CASE 1 WHEN 1 THEN 'one'
->      WHEN 2 THEN 'two' ELSE 'more' END;
-> 'one'
mysql> SELECT CASE WHEN 1>0 THEN 'true' ELSE 'false' END;
-> 'true'
mysql> SELECT CASE BINARY 'B'
->      WHEN 'a' THEN 1 WHEN 'b' THEN 2 END;
-> NULL
```

The default return type of a `CASE` expression is the compatible aggregated type of all return values, but also depends on the context in which it is used. If used in a string context, the result is returned as a string. If used in a numeric context, then the result is returned as a decimal, real, or integer value.

### Note

The syntax of the `CASE expression` shown here differs slightly from that of the SQL `CASE statement` described in [Section 12.8.6.2, “CASE Statement”](#), for use inside stored programs. The `CASE` statement cannot have an `ELSE NULL` clause, and it is terminated with `END CASE` instead of `END`.

- `IF(expr1, expr2, expr3)`

If `expr1` is `TRUE` (`expr1 <> 0` and `expr1 <> NULL`) then `IF()` returns `expr2`; otherwise it returns `expr3`. `IF()` returns a numeric or string value, depending on the context in which it is used.

```
mysql> SELECT IF(1>2,2,3);
-> 3
mysql> SELECT IF(1<2,'yes','no');
-> 'yes'
mysql> SELECT IF(STRCMP('test','test1'),'no','yes');
-> 'no'
```

If only one of `expr2` or `expr3` is explicitly `NULL`, the result type of the `IF()` function is the type of the non-`NULL` expression.

The default return type of `IF()` (which may matter when it is stored into a temporary table) is calculated as follows.

Expression	Return Value
<code>expr2</code> or <code>expr3</code> returns a string	string
<code>expr2</code> or <code>expr3</code> returns a floating-point value	floating-point
<code>expr2</code> or <code>expr3</code> returns an integer	integer

If `expr2` and `expr3` are both strings, the result is case sensitive if either string is case sensitive.

**Note**

There is also an *IF statement*, which differs from the *IF () function* described here. See [Section 12.8.6.1, “IF Statement”](#).

- `IFNULL(expr1,expr2)`

If *expr1* is not `NULL`, `IFNULL()` returns *expr1*; otherwise it returns *expr2*. `IFNULL()` returns a numeric or string value, depending on the context in which it is used.

```
mysql> SELECT IFNULL(1,0);
-> 1
mysql> SELECT IFNULL(NULL,10);
-> 10
mysql> SELECT IFNULL(1/0,10);
-> 10
mysql> SELECT IFNULL(1/0,'yes');
-> 'yes'
```

The default result value of `IFNULL(expr1,expr2)` is the more “general” of the two expressions, in the order `STRING`, `REAL`, or `INTEGER`. Consider the case of a table based on expressions or where MySQL must internally store a value returned by `IFNULL()` in a temporary table:

```
mysql> CREATE TABLE tmp SELECT IFNULL(1,'test') AS test;
mysql> DESCRIBE tmp;
+-----+-----+-----+-----+-----+-----+
| Field | Type          | Null | Key | Default | Extra |
+-----+-----+-----+-----+-----+-----+
| test  | varbinary(4)  | NO   |     |         |       |
+-----+-----+-----+-----+-----+-----+
```

In this example, the type of the `test` column is `CHAR(4)`.

- `NULLIF(expr1,expr2)`

Returns `NULL` if *expr1* = *expr2* is true, otherwise returns *expr1*. This is the same as `CASE WHEN expr1 = expr2 THEN NULL ELSE expr1 END`.

```
mysql> SELECT NULLIF(1,1);
-> NULL
mysql> SELECT NULLIF(1,2);
-> 1
```

Note that MySQL evaluates *expr1* twice if the arguments are not equal.

## 11.4. String Functions

Name	Description
<code>ASCII()</code>	Return numeric value of left-most character
<code>BIN()</code>	Return a string representation of the argument
<code>BIT_LENGTH()</code>	Return length of argument in bits
<code>CHAR_LENGTH()</code>	Return number of characters in argument
<code>CHAR()</code>	Return the character for each integer passed
<code>CHARACTER_LENGTH()</code>	A synonym for <code>CHAR_LENGTH()</code>
<code>CONCAT_WS()</code>	Return concatenate with separator
<code>CONCAT()</code>	Return concatenated string
<code>ELT()</code>	Return string at index number
<code>EXPORT_SET()</code>	Return a string such that for every bit set in the value bits, you get an on string and for every unset bit, you get an off string
<code>FIELD()</code>	Return the index (position) of the first argument in the subsequent arguments
<code>FIND_IN_SET()</code>	Return the index position of the first argument within the second argument
<code>FORMAT()</code>	Return a number formatted to specified number of decimal places
<code>HEX()</code>	Return a hexadecimal representation of a decimal or string value
<code>INSERT()</code>	Insert a substring at the specified position up to the specified number of char-



Name	Description
	acters
INSTR ( )	Return the index of the first occurrence of substring
LCASE ( )	Synonym for LOWER()
LEFT ( )	Return the leftmost number of characters as specified
LENGTH ( )	Return the length of a string in bytes
LIKE	Simple pattern matching
LOAD_FILE ( )	Load the named file
LOCATE ( )	Return the position of the first occurrence of substring
LOWER ( )	Return the argument in lowercase
LPAD ( )	Return the string argument, left-padded with the specified string
LTRIM ( )	Remove leading spaces
MAKE_SET ( )	Return a set of comma-separated strings that have the corresponding bit in bits set
MATCH	Perform full-text search
MID ( )	Return a substring starting from the specified position
NOT LIKE	Negation of simple pattern matching
NOT REGEXP	Negation of REGEXP
OCTET_LENGTH ( )	A synonym for LENGTH()
ORD ( )	Return character code for leftmost character of the argument
POSITION ( )	A synonym for LOCATE()
QUOTE ( )	Escape the argument for use in an SQL statement
REGEXP	Pattern matching using regular expressions
REPEAT ( )	Repeat a string the specified number of times
REPLACE ( )	Replace occurrences of a specified string
REVERSE ( )	Reverse the characters in a string
RIGHT ( )	Return the specified rightmost number of characters
RLIKE	Synonym for REGEXP
RPAD ( )	Append string the specified number of times
RTRIM ( )	Remove trailing spaces
SOUNDEX ( )	Return a soundex string
SOUNDS LIKE(v4.1.0)	Compare sounds
SPACE ( )	Return a string of the specified number of spaces
STRCMP ( )	Compare two strings
SUBSTR ( )	Return the substring as specified
SUBSTRING_INDEX ( )	Return a substring from a string before the specified number of occurrences of the delimiter
SUBSTRING ( )	Return the substring as specified
TRIM ( )	Remove leading and trailing spaces
UCASE ( )	Synonym for UPPER()
UNHEX ( ) (v4.1.2)	Convert each pair of hexadecimal digits to a character
UPPER ( )	Convert to uppercase

String-valued functions return `NULL` if the length of the result would be greater than the value of the `max_allowed_packet` system variable. See [Section 7.5.3, “Tuning Server Parameters”](#).

For functions that operate on string positions, the first position is numbered 1.

For functions that take length arguments, non-integer arguments are rounded to the nearest integer.

- `ASCII(str)`

Returns the numeric value of the leftmost character of the string *str*. Returns 0 if *str* is the empty string. Returns `NULL` if *str* is `NULL`. `ASCII()` works for 8-bit characters.

```
mysql> SELECT ASCII('2');
      -> 50
mysql> SELECT ASCII(2);
      -> 50
mysql> SELECT ASCII('dx');
      -> 100
```

See also the `ORD()` function.

- `BIN(N)`

Returns a string representation of the binary value of *N*, where *N* is a longlong (`BIGINT`) number. This is equivalent to `CONV(N, 10, 2)`. Returns `NULL` if *N* is `NULL`.

```
mysql> SELECT BIN(12);
      -> '1100'
```

- `BIT_LENGTH(str)`

Returns the length of the string *str* in bits.

```
mysql> SELECT BIT_LENGTH('text');
      -> 32
```

- `CHAR(N, ... [USING charset_name])`

`CHAR()` interprets each argument *N* as an integer and returns a string consisting of the characters given by the code values of those integers. `NULL` values are skipped.

```
mysql> SELECT CHAR(77,121,83,81,'76');
      -> 'MySQL'
mysql> SELECT CHAR(77,77.3,'77.3');
      -> 'MMM'
```

`CHAR()` arguments larger than 255 are converted into multiple result bytes. For example, `CHAR(256)` is equivalent to `CHAR(1,0)`, and `CHAR(256*256)` is equivalent to `CHAR(1,0,0)`:

```
mysql> SELECT HEX(CHAR(1,0)), HEX(CHAR(256));
+-----+-----+
| HEX(CHAR(1,0)) | HEX(CHAR(256)) |
+-----+-----+
| 0100          | 0100          |
+-----+-----+
mysql> SELECT HEX(CHAR(1,0,0)), HEX(CHAR(256*256));
+-----+-----+
| HEX(CHAR(1,0,0)) | HEX(CHAR(256*256)) |
+-----+-----+
| 010000         | 010000         |
+-----+-----+
```

By default, `CHAR()` returns a binary string. To produce a string in a given character set, use the optional `USING` clause:

```
mysql> SELECT CHARSET(CHAR(0x65)), CHARSET(CHAR(0x65 USING utf8));
+-----+-----+
| CHARSET(CHAR(0x65)) | CHARSET(CHAR(0x65 USING utf8)) |
+-----+-----+
| binary              | utf8                             |
+-----+-----+
```

If `USING` is given and the result string is illegal for the given character set, a warning is issued. Also, if strict SQL mode is enabled, the result from `CHAR()` becomes `NULL`.

- `CHAR_LENGTH(str)`

Returns the length of the string *str*, measured in characters. A multi-byte character counts as a single character. This means that for a string containing five two-byte characters, `LENGTH()` returns 10, whereas `CHAR_LENGTH()` returns 5.

- `CHARACTER_LENGTH(str)`

`CHARACTER_LENGTH()` is a synonym for `CHAR_LENGTH()`.

- `CONCAT(str1, str2, ...)`

Returns the string that results from concatenating the arguments. May have one or more arguments. If all arguments are nonbinary strings, the result is a nonbinary string. If the arguments include any binary strings, the result is a binary string. A numeric argument is converted to its equivalent binary string form; if you want to avoid that, you can use an explicit type cast, as in this example:

```
SELECT CONCAT(CAST(int_col AS CHAR), char_col);
```

`CONCAT()` returns `NULL` if any argument is `NULL`.

```
mysql> SELECT CONCAT('My', 'S', 'QL');
-> 'MySQL'
mysql> SELECT CONCAT('My', NULL, 'QL');
-> NULL
mysql> SELECT CONCAT(14.3);
-> '14.3'
```

For quoted strings, concatenation can be performed by placing the strings next to each other:

```
mysql> SELECT 'My' 'S' 'QL';
-> 'MySQL'
```

- `CONCAT_WS(separator, str1, str2, ...)`

`CONCAT_WS()` stands for Concatenate With Separator and is a special form of `CONCAT()`. The first argument is the separator for the rest of the arguments. The separator is added between the strings to be concatenated. The separator can be a string, as can the rest of the arguments. If the separator is `NULL`, the result is `NULL`.

```
mysql> SELECT CONCAT_WS(',', 'First name', 'Second name', 'Last Name');
-> 'First name,Second name,Last Name'
mysql> SELECT CONCAT_WS(',', 'First name', NULL, 'Last Name');
-> 'First name,Last Name'
```

`CONCAT_WS()` does not skip empty strings. However, it does skip any `NULL` values after the separator argument.

- `ELT(N, str1, str2, str3, ...)`

Returns `str1` if `N = 1`, `str2` if `N = 2`, and so on. Returns `NULL` if `N` is less than 1 or greater than the number of arguments. `ELT()` is the complement of `FIELD()`.

```
mysql> SELECT ELT(1, 'ej', 'Heja', 'hej', 'foo');
-> 'ej'
mysql> SELECT ELT(4, 'ej', 'Heja', 'hej', 'foo');
-> 'foo'
```

- `EXPORT_SET(bits, on, off[, separator[, number_of_bits]])`

Returns a string such that for every bit set in the value `bits`, you get an `on` string and for every bit not set in the value, you get an `off` string. Bits in `bits` are examined from right to left (from low-order to high-order bits). Strings are added to the result from left to right, separated by the `separator` string (the default being the comma character “,”). The number of bits examined is given by `number_of_bits` (defaults to 64).

```
mysql> SELECT EXPORT_SET(5, 'Y', 'N', ',', 4);
-> 'Y,N,Y,N'
mysql> SELECT EXPORT_SET(6, '1', '0', ',', 10);
-> '0,1,1,0,0,0,0,0,0,0'
```

- `FIELD(str, str1, str2, str3, ...)`

Returns the index (position) of `str` in the `str1, str2, str3, ...` list. Returns 0 if `str` is not found.

If all arguments to `FIELD()` are strings, all arguments are compared as strings. If all arguments are numbers, they are compared as numbers. Otherwise, the arguments are compared as double.

If `str` is `NULL`, the return value is 0 because `NULL` fails equality comparison with any value. `FIELD()` is the complement of `ELT()`.

```
mysql> SELECT FIELD('ej', 'Hej', 'ej', 'Heja', 'hej', 'foo');
-> 2
mysql> SELECT FIELD('fo', 'Hej', 'ej', 'Heja', 'hej', 'foo');
-> 0
```

- `FIND_IN_SET(str, strlist)`

Returns a value in the range of 1 to *N* if the string *str* is in the string list *strlist* consisting of *N* substrings. A string list is a string composed of substrings separated by “,” characters. If the first argument is a constant string and the second is a column of type `SET`, the `FIND_IN_SET()` function is optimized to use bit arithmetic. Returns 0 if *str* is not in *strlist* or if *strlist* is the empty string. Returns `NULL` if either argument is `NULL`. This function does not work properly if the first argument contains a comma (“,”) character.

```
mysql> SELECT FIND_IN_SET('b','a,b,c,d');
-> 2
```

- `FORMAT(X, D)`

Formats the number *X* to a format like '#,###,###.##', rounded to *D* decimal places, and returns the result as a string. If *D* is 0, the result has no decimal point or fractional part.

```
mysql> SELECT FORMAT(12332.123456, 4);
-> '12,332.1235'
mysql> SELECT FORMAT(12332.1,4);
-> '12,332.1000'
mysql> SELECT FORMAT(12332.2,0);
-> '12,332'
```

- `HEX(N_or_S)`

If *N\_or\_S* is a number, returns a string representation of the hexadecimal value of *N*, where *N* is a longlong (`BIGINT`) number. This is equivalent to `CONV(N, 10, 16)`.

If *N\_or\_S* is a string, returns a hexadecimal string representation of *N\_or\_S* where each character in *N\_or\_S* is converted to two hexadecimal digits. The inverse of this operation is performed by the `UNHEX()` function.

```
mysql> SELECT HEX(255);
-> 'FF'
mysql> SELECT HEX(0x616263);
-> 'abc'
mysql> SELECT HEX('abc');
-> 616263
```

- `INSERT(str, pos, len, newstr)`

Returns the string *str*, with the substring beginning at position *pos* and *len* characters long replaced by the string *newstr*. Returns the original string if *pos* is not within the length of the string. Replaces the rest of the string from position *pos* if *len* is not within the length of the rest of the string. Returns `NULL` if any argument is `NULL`.

```
mysql> SELECT INSERT('Quadratic', 3, 4, 'What');
-> 'QuWhattic'
mysql> SELECT INSERT('Quadratic', -1, 4, 'What');
-> 'Quadratic'
mysql> SELECT INSERT('Quadratic', 3, 100, 'What');
-> 'QuWhat'
```

This function is multi-byte safe.

- `INSTR(str, substr)`

Returns the position of the first occurrence of substring *substr* in string *str*. This is the same as the two-argument form of `LOCATE()`, except that the order of the arguments is reversed.

```
mysql> SELECT INSTR('foobarbar', 'bar');
-> 4
mysql> SELECT INSTR('xbar', 'foobar');
-> 0
```

This function is multi-byte safe, and is case sensitive only if at least one argument is a binary string.

- `LCASE(str)`

`LCASE()` is a synonym for `LOWER()`.

- `LEFT(str, len)`

Returns the leftmost *len* characters from the string *str*, or `NULL` if any argument is `NULL`.

```
mysql> SELECT LEFT('foobarbar', 5);
-> 'fooba'
```

- `LENGTH(str)`

Returns the length of the string *str*, measured in bytes. A multi-byte character counts as multiple bytes. This means that for a string containing five two-byte characters, `LENGTH()` returns 10, whereas `CHAR_LENGTH()` returns 5.

```
mysql> SELECT LENGTH('text');
-> 4
```

- `LOAD_FILE(file_name)`

Reads the file and returns the file contents as a string. To use this function, the file must be located on the server host, you must specify the full path name to the file, and you must have the `FILE` privilege. The file must be readable by all and its size less than `max_allowed_packet` bytes. If the `secure_file_priv` system variable is set to a non-empty directory name, the file to be loaded must be located in that directory.

If the file does not exist or cannot be read because one of the preceding conditions is not satisfied, the function returns `NULL`.

As of MySQL 5.1.6, the `character_set_filesystem` system variable controls interpretation of file names that are given as literal strings.

```
mysql> UPDATE t
      SET blob_col=LOAD_FILE('/tmp/picture')
      WHERE id=1;
```

- `LOCATE(substr,str)`, `LOCATE(substr,str,pos)`

The first syntax returns the position of the first occurrence of substring *substr* in string *str*. The second syntax returns the position of the first occurrence of substring *substr* in string *str*, starting at position *pos*. Returns 0 if *substr* is not in *str*.

```
mysql> SELECT LOCATE('bar', 'foobarbar');
-> 4
mysql> SELECT LOCATE('xbar', 'foobar');
-> 0
mysql> SELECT LOCATE('bar', 'foobarbar', 5);
-> 7
```

This function is multi-byte safe, and is case-sensitive only if at least one argument is a binary string.

- `LOWER(str)`

Returns the string *str* with all characters changed to lowercase according to the current character set mapping. The default is `latin1` (cp1252 West European).

```
mysql> SELECT LOWER('QUADRATICALLY');
-> 'quadratically'
```

`LOWER()` (and `UPPER()`) are ineffective when applied to binary strings (`BINARY`, `VARBINARY`, `BLOB`). To perform letter-case conversion, convert the string to a nonbinary string:

```
mysql> SET @str = BINARY 'New York';
mysql> SELECT LOWER(@str), LOWER(CONVERT(@str USING latin1));
+-----+-----+
| LOWER(@str) | LOWER(CONVERT(@str USING latin1)) |
+-----+-----+
| New York   | new york                           |
+-----+-----+
```

This function is multi-byte safe.

- `LPAD(str,len,padstr)`

Returns the string *str*, left-padded with the string *padstr* to a length of *len* characters. If *str* is longer than *len*, the return value is shortened to *len* characters.

```
mysql> SELECT LPAD('hi',4,'??');
-> '??hi'
mysql> SELECT LPAD('hi',1,'??');
-> 'h'
```

- `LTRIM(str)`

Returns the string *str* with leading space characters removed.

```
mysql> SELECT LTRIM('  barbar');
-> 'barbar'
```

This function is multi-byte safe.

- `MAKE_SET(bits, str1, str2, ...)`

Returns a set value (a string containing substrings separated by “,” characters) consisting of the strings that have the corresponding bit in *bits* set. *str1* corresponds to bit 0, *str2* to bit 1, and so on. `NULL` values in *str1*, *str2*, ... are not appended to the result.

```
mysql> SELECT MAKE_SET(1, 'a', 'b', 'c');
-> 'a'
mysql> SELECT MAKE_SET(1 | 4, 'hello', 'nice', 'world');
-> 'hello,world'
mysql> SELECT MAKE_SET(1 | 4, 'hello', 'nice', NULL, 'world');
-> 'hello'
mysql> SELECT MAKE_SET(0, 'a', 'b', 'c');
-> ''
```

- `MID(str, pos, len)`

`MID(str, pos, len)` is a synonym for `SUBSTRING(str, pos, len)`.

- `OCTET_LENGTH(str)`

`OCTET_LENGTH()` is a synonym for `LENGTH()`.

- `ORD(str)`

If the leftmost character of the string *str* is a multi-byte character, returns the code for that character, calculated from the numeric values of its constituent bytes using this formula:

```
(1st byte code)
+ (2nd byte code × 256)
+ (3rd byte code × 2562) ...
```

If the leftmost character is not a multi-byte character, `ORD()` returns the same value as the `ASCII()` function.

```
mysql> SELECT ORD('2');
-> 50
```

- `POSITION(substr IN str)`

`POSITION(substr IN str)` is a synonym for `LOCATE(substr, str)`.

- `QUOTE(str)`

Quotes a string to produce a result that can be used as a properly escaped data value in an SQL statement. The string is returned enclosed by single quotes and with each instance of single quote (“'”), backslash (“\”), ASCII `NUL`, and Control-Z preceded by a backslash. If the argument is `NULL`, the return value is the word “NULL” without enclosing single quotes.

```
mysql> SELECT QUOTE('Don\'t!');
-> 'Don\'t!'
mysql> SELECT QUOTE(NULL);
-> NULL
```

- `REPEAT(str, count)`

Returns a string consisting of the string *str* repeated *count* times. If *count* is less than 1, returns an empty string. Returns `NULL` if *str* or *count* are `NULL`.

```
mysql> SELECT REPEAT('MySQL', 3);
-> 'MySQLMySQLMySQL'
```

- `REPLACE(str, from_str, to_str)`

Returns the string *str* with all occurrences of the string *from\_str* replaced by the string *to\_str*. `REPLACE()` performs a case-sensitive match when searching for *from\_str*.

```
mysql> SELECT REPLACE('www.mysql.com', 'w', 'Ww');
-> 'WwWwWw.mysql.com'
```

This function is multi-byte safe.

- `REVERSE(str)`

Returns the string `str` with the order of the characters reversed.

```
mysql> SELECT REVERSE('abc');
-> 'cba'
```

This function is multi-byte safe.

- `RIGHT(str, len)`

Returns the rightmost `len` characters from the string `str`, or `NULL` if any argument is `NULL`.

```
mysql> SELECT RIGHT('foobarbar', 4);
-> 'rbar'
```

This function is multi-byte safe.

- `RPAD(str, len, padstr)`

Returns the string `str`, right-padded with the string `padstr` to a length of `len` characters. If `str` is longer than `len`, the return value is shortened to `len` characters.

```
mysql> SELECT RPAD('hi', 5, '?');
-> 'hi???'
mysql> SELECT RPAD('hi', 1, '?');
-> 'h'
```

This function is multi-byte safe.

- `RTRIM(str)`

Returns the string `str` with trailing space characters removed.

```
mysql> SELECT RTRIM('barbar ');
-> 'barbar'
```

This function is multi-byte safe.

- `SOUNDEX(str)`

Returns a soundex string from `str`. Two strings that sound almost the same should have identical soundex strings. A standard soundex string is four characters long, but the `SOUNDEX()` function returns an arbitrarily long string. You can use `SUBSTRING()` on the result to get a standard soundex string. All non-alphabetic characters in `str` are ignored. All international alphabetic characters outside the A-Z range are treated as vowels.

### Important

When using `SOUNDEX()`, you should be aware of the following limitations:

- This function, as currently implemented, is intended to work well with strings that are in the English language only. Strings in other languages may not produce reliable results.
- This function is not guaranteed to provide consistent results with strings that use multi-byte character sets, including `utf-8`.

We hope to remove these limitations in a future release. See [Bug#22638](#) for more information.

```
mysql> SELECT SOUNDEX('Hello');
-> 'H400'
mysql> SELECT SOUNDEX('Quadratically');
-> 'Q36324'
```

### Note

This function implements the original Soundex algorithm, not the more popular enhanced version (also described by D. Knuth). The difference is that original version discards vowels first and duplicates second, whereas the enhanced version discards duplicates first and vowels second.

- `expr1 SOUNDS LIKE expr2`

This is the same as `SOUNDEX(expr1) = SOUNDEX(expr2)`.

- `SPACE(N)`

Returns a string consisting of *N* space characters.

```
mysql> SELECT SPACE(6);
-> '      '
```

- `SUBSTR(str, pos)`, `SUBSTR(str FROM pos)`, `SUBSTR(str, pos, len)`, `SUBSTR(str FROM pos FOR len)`

`SUBSTR()` is a synonym for `SUBSTRING()`.

- `SUBSTRING(str, pos)`, `SUBSTRING(str FROM pos)`, `SUBSTRING(str, pos, len)`, `SUBSTRING(str FROM pos FOR len)`

The forms without a *len* argument return a substring from string *str* starting at position *pos*. The forms with a *len* argument return a substring *len* characters long from string *str*, starting at position *pos*. The forms that use `FROM` are standard SQL syntax. It is also possible to use a negative value for *pos*. In this case, the beginning of the substring is *pos* characters from the end of the string, rather than the beginning. A negative value may be used for *pos* in any of the forms of this function.

For all forms of `SUBSTRING()`, the position of the first character in the string from which the substring is to be extracted is reckoned as 1.

```
mysql> SELECT SUBSTRING('Quadratically',5);
-> 'ratically'
mysql> SELECT SUBSTRING('foobarbar' FROM 4);
-> 'barbar'
mysql> SELECT SUBSTRING('Quadratically',5,6);
-> 'ratica'
mysql> SELECT SUBSTRING('Sakila', -3);
-> 'ila'
mysql> SELECT SUBSTRING('Sakila', -5, 3);
-> 'aki'
mysql> SELECT SUBSTRING('Sakila' FROM -4 FOR 2);
-> 'ki'
```

This function is multi-byte safe.

If *len* is less than 1, the result is the empty string.

- `SUBSTRING_INDEX(str, delim, count)`

Returns the substring from string *str* before *count* occurrences of the delimiter *delim*. If *count* is positive, everything to the left of the final delimiter (counting from the left) is returned. If *count* is negative, everything to the right of the final delimiter (counting from the right) is returned. `SUBSTRING_INDEX()` performs a case-sensitive match when searching for *delim*.

```
mysql> SELECT SUBSTRING_INDEX('www.mysql.com', '.', 2);
-> 'www.mysql'
mysql> SELECT SUBSTRING_INDEX('www.mysql.com', '.', -2);
-> 'mysql.com'
```

This function is multi-byte safe.

- `TRIM([{BOTH | LEADING | TRAILING} [remstr] FROM] str)`, `TRIM([remstr FROM] str)`

Returns the string *str* with all *remstr* prefixes or suffixes removed. If none of the specifiers `BOTH`, `LEADING`, or `TRAILING` is given, `BOTH` is assumed. *remstr* is optional and, if not specified, spaces are removed.

```
mysql> SELECT TRIM(' bar ');
-> 'bar'
mysql> SELECT TRIM(LEADING 'x' FROM 'xxxbarxxx');
-> 'barxxx'
mysql> SELECT TRIM(BOTH 'x' FROM 'xxxbarxxx');
-> 'bar'
mysql> SELECT TRIM(TRAILING 'xyz' FROM 'barxyz');
-> 'barx'
```



This function is multi-byte safe.

- `UCASE(str)`

`UCASE()` is a synonym for `UPPER()`.

- `UNHEX(str)`

Performs the inverse operation of `HEX(str)`. That is, it interprets each pair of hexadecimal digits in the argument as a number and converts it to the character represented by the number. The resulting characters are returned as a binary string.

```
mysql> SELECT UNHEX('4D7953514C');
-> 'MySQL'
mysql> SELECT 0x4D7953514C;
-> 'MySQL'
mysql> SELECT UNHEX(HEX('string'));
-> 'string'
mysql> SELECT HEX(UNHEX('1267'));
-> '1267'
```

The characters in the argument string must be legal hexadecimal digits: '0' .. '9', 'A' .. 'F', 'a' .. 'f'. If `UNHEX()` encounters any non-hexadecimal digits in the argument, it returns `NULL`:

```
mysql> SELECT UNHEX('GG');
+-----+
| UNHEX('GG') |
+-----+
| NULL        |
+-----+
```

A `NULL` result can occur if the argument to `UNHEX()` is a `BINARY` column, because values are padded with `0x00` bytes when stored but those bytes are not stripped on retrieval. For example 'aa' is stored into a `CHAR(3)` column as 'aa ' and retrieved as 'aa' (with the trailing pad space stripped), so `UNHEX()` for the column value returns 'A'. By contrast 'aa' is stored into a `BINARY(3)` column as 'aa\0' and retrieved as 'aa\0' (with the trailing pad `0x00` byte not stripped). '\0' is not a legal hexadecimal digit, so `UNHEX()` for the column value returns `NULL`.

- `UPPER(str)`

Returns the string *str* with all characters changed to uppercase according to the current character set mapping. The default is `latin1` (cp1252 West European).

```
mysql> SELECT UPPER('Hej');
-> 'HEJ'
```

`UPPER()` is ineffective when applied to binary strings (`BINARY`, `VARBINARY`, `BLOB`). The description of `LOWER()` shows how to perform lettercase conversion of binary strings.

This function is multi-byte safe.

### 11.4.1. String Comparison Functions

Name	Description
<code>LIKE</code>	Simple pattern matching
<code>NOT LIKE</code>	Negation of simple pattern matching
<code>STRCMP()</code>	Compare two strings

If a string function is given a binary string as an argument, the resulting string is also a binary string. A number converted to a string is treated as a binary string. This affects only comparisons.

Normally, if any expression in a string comparison is case sensitive, the comparison is performed in case-sensitive fashion.

- `expr LIKE pat [ESCAPE 'escape_char']`

Pattern matching using SQL simple regular expression comparison. Returns 1 (`TRUE`) or 0 (`FALSE`). If either *expr* or *pat* is `NULL`, the result is `NULL`.

The pattern need not be a literal string. For example, it can be specified as a string expression or table column.

Per the SQL standard, `LIKE` performs matching on a per-character basis, thus it can produce results different from the `=` comparison operator:

```
mysql> SELECT 'ä' LIKE 'ae' COLLATE latin1_german2_ci;
+-----+
| 'ä' LIKE 'ae' COLLATE latin1_german2_ci |
+-----+
| 0 |
+-----+
mysql> SELECT 'ä' = 'ae' COLLATE latin1_german2_ci;
+-----+
| 'ä' = 'ae' COLLATE latin1_german2_ci |
+-----+
| 1 |
+-----+
```

In particular, trailing spaces are significant, which is not true for `CHAR` or `VARCHAR` comparisons performed with the `=` operator:

```
mysql> SELECT 'a' = 'a ', 'a' LIKE 'a ';
+-----+-----+
| 'a' = 'a ' | 'a' LIKE 'a ' |
+-----+-----+
| 1 | 0 |
+-----+-----+
1 row in set (0.00 sec)
```

With `LIKE` you can use the following two wildcard characters in the pattern.

Character	Description
<code>%</code>	Matches any number of characters, even zero characters
<code>_</code>	Matches exactly one character

```
mysql> SELECT 'David!' LIKE 'David_';
-> 1
mysql> SELECT 'David!' LIKE '%D%v%';
-> 1
```

To test for literal instances of a wildcard character, precede it by the escape character. If you do not specify the `ESCAPE` character, `"\"` is assumed.

String	Description
<code>\%</code>	Matches one <code>"%"</code> character
<code>\_</code>	Matches one <code>"_"</code> character

```
mysql> SELECT 'David!' LIKE 'David\>';
-> 0
mysql> SELECT 'David_' LIKE 'David\_';
-> 1
```

To specify a different escape character, use the `ESCAPE` clause:

```
mysql> SELECT 'David_' LIKE 'David|_' ESCAPE '|';
-> 1
```

The escape sequence should be empty or one character long. As of MySQL 5.1.2, if the `NO_BACKSLASH_ESCAPES` SQL mode is enabled, the sequence cannot be empty.

The following two statements illustrate that string comparisons are not case sensitive unless one of the operands is a binary string:

```
mysql> SELECT 'abc' LIKE 'ABC';
-> 1
mysql> SELECT 'abc' LIKE BINARY 'ABC';
-> 0
```

In MySQL, `LIKE` is allowed on numeric expressions. (This is an extension to the standard SQL `LIKE`.)

```
mysql> SELECT 10 LIKE '1%';
-> 1
```

**Note**

Because MySQL uses C escape syntax in strings (for example, “\n” to represent a newline character), you must double any “\” that you use in `LIKE` strings. For example, to search for “\n”, specify it as “\\n”. To search for “\”, specify it as “\\”; this is because the backslashes are stripped once by the parser and again when the pattern match is made, leaving a single backslash to be matched against. (Exception: At the end of the pattern string, backslash can be specified as “\”. At the end of the string, backslash stands for itself because there is nothing following to escape.)

- `expr NOT LIKE pat [ESCAPE 'escape_char']`

This is the same as `NOT (expr LIKE pat [ESCAPE 'escape_char'])`.

**Note**

Aggregate queries involving `NOT LIKE` comparisons with columns containing `NULL` may yield unexpected results. For example, consider the following table and data:

```
CREATE TABLE foo (bar VARCHAR(10));
INSERT INTO foo VALUES (NULL), (NULL);
```

The query `SELECT COUNT(*) FROM foo WHERE bar LIKE '%baz%'`; returns 0. You might assume that `SELECT COUNT(*) FROM foo WHERE bar NOT LIKE '%baz%'`; would return 2. However, this is not the case: The second query returns 0. This is because `NULL NOT LIKE expr` always returns `NULL`, regardless of the value of `expr`. The same is true for aggregate queries involving `NULL` and comparisons using `NOT RLIKE` or `NOT REGEXP`. In such cases, you must test explicitly for `NOT NULL` using `OR` (and not `AND`), as shown here:

```
SELECT COUNT(*) FROM foo WHERE bar NOT LIKE '%baz%' OR bar IS NULL;
```

- `STRCMP(expr1,expr2)`

`STRCMP()` returns 0 if the strings are the same, -1 if the first argument is smaller than the second according to the current sort order, and 1 otherwise.

```
mysql> SELECT STRCMP('text', 'text2');
-> -1
mysql> SELECT STRCMP('text2', 'text');
-> 1
mysql> SELECT STRCMP('text', 'text');
-> 0
```

`STRCMP()` uses the current character set when performing comparisons. This makes the default comparison behavior case insensitive unless one or both of the operands are binary strings.

## 11.4.2. Regular Expressions

Name	Description
<code>NOT REGEXP</code>	Negation of <code>REGEXP</code>
<code>REGEXP</code>	Pattern matching using regular expressions
<code>RLIKE</code>	Synonym for <code>REGEXP</code>

A regular expression is a powerful way of specifying a pattern for a complex search.

MySQL uses Henry Spencer's implementation of regular expressions, which is aimed at conformance with POSIX 1003.2. See [Section 1.8, “Credits”](#). MySQL uses the extended version to support pattern-matching operations performed with the `REGEXP` operator in SQL statements.

This section summarizes, with examples, the special characters and constructs that can be used in MySQL for `REGEXP` operations. It does not contain all the details that can be found in Henry Spencer's `regex(7)` manual page. That manual page is included in MySQL source distributions, in the `regex.7` file under the `regex` directory. See also [Section 3.3.4.7, “Pattern Matching”](#).

- `expr NOT REGEXP pat,expr NOT RLIKE pat`

This is the same as `NOT (expr REGEXP pat)`.

- `expr REGEXP pat, expr RLIKE pat`

Performs a pattern match of a string expression `expr` against a pattern `pat`. The pattern can be an extended regular expression. The syntax for regular expressions is discussed in [Section 11.4.2, “Regular Expressions”](#). Returns 1 if `expr` matches `pat`; otherwise it returns 0. If either `expr` or `pat` is NULL, the result is NULL. `RLIKE` is a synonym for `REGEXP`, provided for `MySQL` compatibility.

The pattern need not be a literal string. For example, it can be specified as a string expression or table column.

### Note

Because MySQL uses the C escape syntax in strings (for example, “\n” to represent the newline character), you must double any “\” that you use in your `REGEXP` strings.

`REGEXP` is not case sensitive, except when used with binary strings.

```
mysql> SELECT 'Monty!' REGEXP 'm%y%';
-> 0
mysql> SELECT 'Monty!' REGEXP '.*';
-> 1
mysql> SELECT 'new*\n*line' REGEXP 'new\\.*\\*line';
-> 1
mysql> SELECT 'a' REGEXP 'A', 'a' REGEXP BINARY 'A';
-> 1 0
mysql> SELECT 'a' REGEXP '^[a-d]';
-> 1
```

`REGEXP` and `RLIKE` use the current character set when deciding the type of a character. The default is `latin1` (cp1252 West European).

### Warning

The `REGEXP` and `RLIKE` operators work in byte-wise fashion, so they are not multi-byte safe and may produce unexpected results with multi-byte character sets. In addition, these operators compare characters by their byte values and accented characters may not compare as equal even if a given collation treats them as equal.

A regular expression describes a set of strings. The simplest regular expression is one that has no special characters in it. For example, the regular expression `hello` matches `hello` and nothing else.

Non-trivial regular expressions use certain special constructs so that they can match more than one string. For example, the regular expression `hello|word` matches either the string `hello` or the string `word`.

As a more complex example, the regular expression `B[an]*s` matches any of the strings `Bananas`, `Baaaaas`, `Bs`, and any other string starting with a `B`, ending with an `s`, and containing any number of `a` or `n` characters in between.

A regular expression for the `REGEXP` operator may use any of the following special characters and constructs:

- `^`

Match the beginning of a string.

```
mysql> SELECT 'fo\nfo' REGEXP '^fo$';
-> 0
mysql> SELECT 'fofo' REGEXP '^fo';
-> 1
```

- `$`

Match the end of a string.

```
mysql> SELECT 'fo\no' REGEXP '^fo\no$';
-> 1
mysql> SELECT 'fo\no' REGEXP '^fo$';
-> 0
```

- `.`

Match any character (including carriage return and newline).

```
mysql> SELECT 'fofo' REGEXP '^f.*$';
-> 1
mysql> SELECT 'fo\r\nfo' REGEXP '^f.*$';
-> 1
```

- `a*`

Match any sequence of zero or more `a` characters.

```
mysql> SELECT 'Ban' REGEXP '^Ba*n';          -> 1
mysql> SELECT 'Baaan' REGEXP '^Ba*n';       -> 1
mysql> SELECT 'Bn' REGEXP '^Ba*n';          -> 1
```

- `a+`

Match any sequence of one or more `a` characters.

```
mysql> SELECT 'Ban' REGEXP '^Ba+n';         -> 1
mysql> SELECT 'Bn' REGEXP '^Ba+n';         -> 0
```

- `a?`

Match either zero or one `a` character.

```
mysql> SELECT 'Bn' REGEXP '^Ba?n';         -> 1
mysql> SELECT 'Ban' REGEXP '^Ba?n';       -> 1
mysql> SELECT 'Baan' REGEXP '^Ba?n';     -> 0
```

- `de|abc`

Match either of the sequences `de` or `abc`.

```
mysql> SELECT 'pi' REGEXP 'pi|apa';        -> 1
mysql> SELECT 'axe' REGEXP 'pi|apa';      -> 0
mysql> SELECT 'apa' REGEXP 'pi|apa';      -> 1
mysql> SELECT 'apa' REGEXP '^ (pi|apa)$'; -> 1
mysql> SELECT 'pi' REGEXP '^ (pi|apa)$';  -> 1
mysql> SELECT 'pix' REGEXP '^ (pi|apa)$'; -> 0
```

- `(abc)*`

Match zero or more instances of the sequence `abc`.

```
mysql> SELECT 'pi' REGEXP '^ (pi)*$';     -> 1
mysql> SELECT 'pip' REGEXP '^ (pi)*$';    -> 0
mysql> SELECT 'pipi' REGEXP '^ (pi)*$';   -> 1
```

- `{1}, {2, 3}`

`{n}` or `{m, n}` notation provides a more general way of writing regular expressions that match many occurrences of the previous atom (or “piece”) of the pattern. `m` and `n` are integers.

- `a*`

Can be written as `a{0, }`.

- `a+`

Can be written as `a{1, }`.

- `a?`

Can be written as `a{0, 1}`.

To be more precise, `a{n}` matches exactly `n` instances of `a`. `a{n, }` matches `n` or more instances of `a`. `a{m, n}` matches `m` through `n` instances of `a`, inclusive.

`m` and `n` must be in the range from 0 to `RE_DUP_MAX` (default 255), inclusive. If both `m` and `n` are given, `m` must be less than or equal to `n`.

```
mysql> SELECT 'abcde' REGEXP 'a[bcd]{2}e'; -> 0
mysql> SELECT 'abcde' REGEXP 'a[bcd]{3}e'; -> 1
mysql> SELECT 'abcde' REGEXP 'a[bcd]{1,10}e'; -> 1
```

- `[a-dX], [^a-dX]`

Matches any character that is (or is not, if `^` is used) either `a`, `b`, `c`, `d` or `X`. A `-` character between two other characters forms a range that matches all characters from the first character to the second. For example, `[0-9]` matches any decimal digit. To include a literal `]` character, it must immediately follow the opening bracket `[`. To include a literal `-` character, it must be written first or last. Any character that does not have a defined special meaning inside a `[ ]` pair matches only itself.

```
mysql> SELECT 'aXbc' REGEXP '[a-dXYZ]';          -> 1
mysql> SELECT 'aXbc' REGEXP '^[a-dXYZ]$';       -> 0
mysql> SELECT 'aXbc' REGEXP '[a-dXYZ]+$';      -> 1
mysql> SELECT 'aXbc' REGEXP '^^[a-dXYZ]+$';    -> 0
mysql> SELECT 'gheis' REGEXP '^^[a-dXYZ]+$';   -> 1
mysql> SELECT 'gheisa' REGEXP '^^[a-dXYZ]+$';  -> 0
```

- [.characters.]

Within a bracket expression (written using [ and ]), matches the sequence of characters of that collating element. `characters` is either a single character or a character name like `newline`. The following table lists the allowable character names.

The following table shows the allowable character names and the characters that they match. For characters given as numeric values, the values are represented in octal.

Name	Character	Name	Character
NUL	0	SOH	001
STX	002	ETX	003
EOT	004	ENQ	005
ACK	006	BEL	007
alert	007	BS	010
backspace	'\b'	HT	011
tab	'\t'	LF	012
newline	'\n'	VT	013
vertical-tab	'\v'	FF	014
form-feed	'\f'	CR	015
carriage-return	'\r'	SO	016
SI	017	DLE	020
DC1	021	DC2	022
DC3	023	DC4	024
NAK	025	SYN	026
ETB	027	CAN	030
EM	031	SUB	032
ESC	033	IS4	034
FS	034	IS3	035
GS	035	IS2	036
RS	036	IS1	037
US	037	space	' '
exclamation-mark	'!'	quotation-mark	'\"'
number-sign	'#'	dollar-sign	'\$'
percent-sign	'%'	ampersand	'&'
apostrophe	'\''	left-parenthesis	'('
right-parenthesis	')'	asterisk	'*'
plus-sign	'+'	comma	','
hyphen	'-'	hyphen-minus	'-'
period	'.'	full-stop	'.'
slash	'/'	solidus	'/'
zero	'0'	one	'1'
two	'2'	three	'3'
four	'4'	five	'5'
six	'6'	seven	'7'
eight	'8'	nine	'9'
colon	':'	semicolon	';'

less-than-sign	'<'	equals-sign	'='
greater-than-sign	'>'	question-mark	'?'
commercial-at	'@'	left-square-bracket	'['
backslash	'\'	reverse-solidus	'\/'
right-square-bracket	']'	circumflex	'^'
circumflex-accent	'^'	underscore	'_'
low-line	'_'	grave-accent	'`'
left-brace	'{'	left-curly-bracket	'{'
vertical-line	' '	right-brace	'}'
right-curly-bracket	'}'	tilde	'~'
DEL	177		

```
mysql> SELECT '~' REGEXP '[[.~.]]';          -> 1
mysql> SELECT '~' REGEXP '[[.tilde.]]';     -> 1
```

- [=character\_class=]

Within a bracket expression (written using [ and ]), [=character\_class=] represents an equivalence class. It matches all characters with the same collation value, including itself. For example, if o and (+) are the members of an equivalence class, then [[=o=]], [[=(+)=]], and [o(+)] are all synonymous. An equivalence class may not be used as an endpoint of a range.

- [:character\_class:]

Within a bracket expression (written using [ and ]), [:character\_class:] represents a character class that matches all characters belonging to that class. The following table lists the standard class names. These names stand for the character classes defined in the ctype(3) manual page. A particular locale may provide other class names. A character class may not be used as an endpoint of a range.

alnum	Alphanumeric characters
alpha	Alphabetic characters
blank	Whitespace characters
cntrl	Control characters
digit	Digit characters
graph	Graphic characters
lower	Lowercase alphabetic characters
print	Graphic or space characters
punct	Punctuation characters
space	Space, tab, newline, and carriage return
upper	Uppercase alphabetic characters
xdigit	Hexadecimal digit characters

```
mysql> SELECT 'justalnums' REGEXP '[:alnum:]+';          -> 1
mysql> SELECT '!!!' REGEXP '[:alnum:]+';                -> 0
```

- [[:<:]], [[:>:]]

These markers stand for word boundaries. They match the beginning and end of words, respectively. A word is a sequence of word characters that is not preceded by or followed by word characters. A word character is an alphanumeric character in the alnum class or an underscore (\_).

```
mysql> SELECT 'a word a' REGEXP '[:<:]word[:>:]';      -> 1
mysql> SELECT 'a xword a' REGEXP '[:<:]word[:>:]';     -> 0
```

To use a literal instance of a special character in a regular expression, precede it by two backslash (\) characters. The MySQL parser interprets one of the backslashes, and the regular expression library interprets the other. For example, to match the string 1+2

that contains the special + character, only the last of the following regular expressions is the correct one:

```
mysql> SELECT '1+2' REGEXP '1+2';      -> 0
mysql> SELECT '1+2' REGEXP '1\\+2';    -> 0
mysql> SELECT '1+2' REGEXP '1\\\\+2';   -> 1
```

## 11.5. Numeric Functions

Name	Description
ABS ( )	Return the absolute value
ACOS ( )	Return the arc cosine
ASIN ( )	Return the arc sine
ATAN2 ( ), ATAN ( )	Return the arc tangent of the two arguments
ATAN ( )	Return the arc tangent
CEIL ( )	Return the smallest integer value not less than the argument
CEILING ( )	Return the smallest integer value not less than the argument
CONV ( )	Convert numbers between different number bases
COS ( )	Return the cosine
COT ( )	Return the cotangent
CRC32 ( ) (v4.1.0)	Compute a cyclic redundancy check value
DEGREES ( )	Convert radians to degrees
DIV (v4.1.0)	Integer division
/	Division operator
EXP ( )	Raise to the power of
FLOOR ( )	Return the largest integer value not greater than the argument
LN ( )	Return the natural logarithm of the argument
LOG10 ( )	Return the base-10 logarithm of the argument
LOG2 ( )	Return the base-2 logarithm of the argument
LOG ( )	Return the natural logarithm of the first argument
-	Minus operator
MOD ( )	Return the remainder
%	Modulo operator
OCT ( )	Return an octal representation of a decimal number
PI ( )	Return the value of pi
+	Addition operator
POW ( )	Return the argument raised to the specified power
POWER ( )	Return the argument raised to the specified power
RADIANS ( )	Return argument converted to radians
RAND ( )	Return a random floating-point value
ROUND ( )	Round the argument
SIGN ( )	Return the sign of the argument
SIN ( )	Return the sine of the argument
SQRT ( )	Return the square root of the argument
TAN ( )	Return the tangent of the argument
*	Times operator
TRUNCATE ( )	Truncate to specified number of decimal places
-	Change the sign of the argument

### 11.5.1. Arithmetic Operators



Name	Description
<code>DIV(v4.1.0)</code>	Integer division
<code>/</code>	Division operator
<code>-</code>	Minus operator
<code>%</code>	Modulo operator
<code>+</code>	Addition operator
<code>*</code>	Times operator
<code>-</code>	Change the sign of the argument

The usual arithmetic operators are available. The result is determined according to the following rules:

- In the case of `-`, `+`, and `*`, the result is calculated with `BIGINT` (64-bit) precision if both arguments are integers.
- If one of the arguments is an unsigned integer, and the other argument is also an integer, the result is an unsigned integer.
- If any of the operands of a `+`, `-`, `/`, `*`, `%` is a real or string value, then the precision of the result is the precision of the argument with the maximum precision.
- In division performed with `/`, the scale of the result when using two exact values is the scale of the first argument plus the value of the `div_precision_increment` system variable (which is 4 by default). For example, the result of the expression `5.05 / 0.014` has a scale of six decimal places (`360.714286`).

These rules are applied for each operation, such that nested calculations imply the precision of each component. Hence, `(14620 / 9432456) / (24250 / 9432456)`, would resolve first to `(0.0014) / (0.0026)`, with the final result having 8 decimal places (`0.60288653`).

Because of these rules and the way they are applied, care should be taken to ensure that components and sub-components of a calculation use the appropriate level of precision. See [Section 11.9, “Cast Functions and Operators”](#).

- `+`

Addition:

```
mysql> SELECT 3+5;
-> 8
```

- `-`

Subtraction:

```
mysql> SELECT 3-5;
-> -2
```

- `-`

Unary minus. This operator changes the sign of the argument.

```
mysql> SELECT - 2;
-> -2
```

### Note

If this operator is used with a `BIGINT`, the return value is also a `BIGINT`. This means that you should avoid using `-` on integers that may have the value of  $-2^{63}$ .

- `*`

Multiplication:

```
mysql> SELECT 3*5;
-> 15
mysql> SELECT 18014398509481984*18014398509481984.0;
-> 324518553658426726783156020576256.0
mysql> SELECT 18014398509481984*18014398509481984;
-> 0
```

The result of the last expression is incorrect because the result of the integer multiplication exceeds the 64-bit range of `BIGINT` calculations. (See [Section 10.2, “Numeric Types”](#).)

- /

Division:

```
mysql> SELECT 3/5;
-> 0.60
```

Division by zero produces a `NULL` result:

```
mysql> SELECT 102/(1-1);
-> NULL
```

A division is calculated with `BIGINT` arithmetic only if performed in a context where its result is converted to an integer.

- DIV

Integer division. Similar to `FLOOR()`, but is safe with `BIGINT` values. Incorrect results may occur for non-integer operands that exceed `BIGINT` range.

```
mysql> SELECT 5 DIV 2;
-> 2
```

- $N \% M$

Modulo operation. Returns the remainder of  $N$  divided by  $M$ . For more information, see the description for the `MOD()` function in [Section 11.5.2, “Mathematical Functions”](#).

## 11.5.2. Mathematical Functions

Name	Description
<code>ABS()</code>	Return the absolute value
<code>ACOS()</code>	Return the arc cosine
<code>ASIN()</code>	Return the arc sine
<code>ATAN2(), ATAN()</code>	Return the arc tangent of the two arguments
<code>ATAN()</code>	Return the arc tangent
<code>CEIL()</code>	Return the smallest integer value not less than the argument
<code>CEILING()</code>	Return the smallest integer value not less than the argument
<code>CONV()</code>	Convert numbers between different number bases
<code>COS()</code>	Return the cosine
<code>COT()</code>	Return the cotangent
<code>CRC32()</code> (v4.1.0)	Compute a cyclic redundancy check value
<code>DEGREES()</code>	Convert radians to degrees
<code>EXP()</code>	Raise to the power of
<code>FLOOR()</code>	Return the largest integer value not greater than the argument
<code>LN()</code>	Return the natural logarithm of the argument
<code>LOG10()</code>	Return the base-10 logarithm of the argument
<code>LOG2()</code>	Return the base-2 logarithm of the argument
<code>LOG()</code>	Return the natural logarithm of the first argument
<code>MOD()</code>	Return the remainder
<code>OCT()</code>	Return an octal representation of a decimal number
<code>PI()</code>	Return the value of pi
<code>POW()</code>	Return the argument raised to the specified power
<code>POWER()</code>	Return the argument raised to the specified power

Name	Description
<code>RADIANS()</code>	Return argument converted to radians
<code>RAND()</code>	Return a random floating-point value
<code>ROUND()</code>	Round the argument
<code>SIGN()</code>	Return the sign of the argument
<code>SIN()</code>	Return the sine of the argument
<code>SQRT()</code>	Return the square root of the argument
<code>TAN()</code>	Return the tangent of the argument
<code>TRUNCATE()</code>	Truncate to specified number of decimal places

All mathematical functions return `NULL` in the event of an error.

- `ABS(X)`

Returns the absolute value of `X`.

```
mysql> SELECT ABS(2);
-> 2
mysql> SELECT ABS(-32);
-> 32
```

This function is safe to use with `BIGINT` values.

- `ACOS(X)`

Returns the arc cosine of `X`, that is, the value whose cosine is `X`. Returns `NULL` if `X` is not in the range `-1` to `1`.

```
mysql> SELECT ACOS(1);
-> 0
mysql> SELECT ACOS(1.0001);
-> NULL
mysql> SELECT ACOS(0);
-> 1.5707963267949
```

- `ASIN(X)`

Returns the arc sine of `X`, that is, the value whose sine is `X`. Returns `NULL` if `X` is not in the range `-1` to `1`.

```
mysql> SELECT ASIN(0.2);
-> 0.20135792079033
mysql> SELECT ASIN('foo');

+-----+
| ASIN('foo') |
+-----+
| 0          |
+-----+
1 row in set, 1 warning (0.00 sec)
```

```
mysql> SHOW WARNINGS;

+-----+-----+-----+
| Level | Code | Message                                     |
+-----+-----+-----+
| Warning | 1292 | Truncated incorrect DOUBLE value: 'foo' |
+-----+-----+-----+
```

- `ATAN(X)`

Returns the arc tangent of `X`, that is, the value whose tangent is `X`.

```
mysql> SELECT ATAN(2);
-> 1.1071487177941
mysql> SELECT ATAN(-2);
-> -1.1071487177941
```

- `ATAN(Y, X)`, `ATAN2(Y, X)`

Returns the arc tangent of the two variables `X` and `Y`. It is similar to calculating the arc tangent of `Y / X`, except that the signs of both arguments are used to determine the quadrant of the result.

```
mysql> SELECT ATAN(-2, 2);
```

```
mysql> SELECT ATAN2(PI(),0);
-> -0.78539816339745
-> 1.5707963267949
```

- `CEIL(X)`

`CEIL()` is a synonym for `CEILING()`.

- `CEILING(X)`

Returns the smallest integer value not less than *X*.

```
mysql> SELECT CEILING(1.23);
-> 2
mysql> SELECT CEILING(-1.23);
-> -1
```

For exact-value numeric arguments, the return value has an exact-value numeric type. For string or floating-point arguments, the return value has a floating-point type.

- `CONV(N,from_base,to_base)`

Converts numbers between different number bases. Returns a string representation of the number *N*, converted from base *from\_base* to base *to\_base*. Returns `NULL` if any argument is `NULL`. The argument *N* is interpreted as an integer, but may be specified as an integer or a string. The minimum base is 2 and the maximum base is 36. If *to\_base* is a negative number, *N* is regarded as a signed number. Otherwise, *N* is treated as unsigned. `CONV()` works with 64-bit precision.

```
mysql> SELECT CONV('a',16,2);
-> '1010'
mysql> SELECT CONV('6E',18,8);
-> '172'
mysql> SELECT CONV(-17,10,-18);
-> '-H'
mysql> SELECT CONV(10+'10'+ '10'+0xa,10,10);
-> '40'
```

- `COS(X)`

Returns the cosine of *X*, where *X* is given in radians.

```
mysql> SELECT COS(PI());
-> -1
```

- `COT(X)`

Returns the cotangent of *X*.

```
mysql> SELECT COT(12);
-> -1.5726734063977
mysql> SELECT COT(0);
-> NULL
```

- `CRC32(expr)`

Computes a cyclic redundancy check value and returns a 32-bit unsigned value. The result is `NULL` if the argument is `NULL`. The argument is expected to be a string and (if possible) is treated as one if it is not.

```
mysql> SELECT CRC32('MySQL');
-> 3259397556
mysql> SELECT CRC32('mysql');
-> 2501908538
```

- `DEGREES(X)`

Returns the argument *X*, converted from radians to degrees.

```
mysql> SELECT DEGREES(PI());
-> 180
mysql> SELECT DEGREES(PI() / 2);
-> 90
```

- `EXP(X)`

Returns the value of *e* (the base of natural logarithms) raised to the power of *X*. The inverse of this function is `LOG()` (using a

single argument only) or `LN()`.

```
mysql> SELECT EXP(2);
-> 7.3890560989307
mysql> SELECT EXP(-2);
-> 0.13533528323661
mysql> SELECT EXP(0);
-> 1
```

- `FLOOR(X)`

Returns the largest integer value not greater than  $X$ .

```
mysql> SELECT FLOOR(1.23);
-> 1
mysql> SELECT FLOOR(-1.23);
-> -2
```

For exact-value numeric arguments, the return value has an exact-value numeric type. For string or floating-point arguments, the return value has a floating-point type.

- `FORMAT(X, D)`

Formats the number  $X$  to a format like ' $\#, \###, \###. \##$ ', rounded to  $D$  decimal places, and returns the result as a string. For details, see [Section 11.4, “String Functions”](#).

- `HEX(N_or_S)`

This function can be used to obtain a hexadecimal representation of a decimal number or a string; the manner in which it does so varies according to the argument's type. See this function's description in [Section 11.4, “String Functions”](#), for details.

- `LN(X)`

Returns the natural logarithm of  $X$ ; that is, the base- $e$  logarithm of  $X$ . If  $X$  is less than or equal to 0, then `NULL` is returned.

```
mysql> SELECT LN(2);
-> 0.69314718055995
mysql> SELECT LN(-2);
-> NULL
```

This function is synonymous with `LOG(X)`. The inverse of this function is the `EXP()` function.

- `LOG(X), LOG(B, X)`

If called with one parameter, this function returns the natural logarithm of  $X$ . If  $X$  is less than or equal to 0, then `NULL` is returned.

The inverse of this function (when called with a single argument) is the `EXP()` function.

```
mysql> SELECT LOG(2);
-> 0.69314718055995
mysql> SELECT LOG(-2);
-> NULL
```

If called with two parameters, this function returns the logarithm of  $X$  to the base  $B$ . If  $X$  is less than or equal to 0, or if  $B$  is less than or equal to 1, then `NULL` is returned.

```
mysql> SELECT LOG(2,65536);
-> 16
mysql> SELECT LOG(10,100);
-> 2
mysql> SELECT LOG(1,100);
-> NULL
```

`LOG(B, X)` is equivalent to `LOG(X) / LOG(B)`.

- `LOG2(X)`

Returns the base-2 logarithm of  $X$ .

```
mysql> SELECT LOG2(65536);
-> 16
mysql> SELECT LOG2(-100);
-> NULL
```

`LOG2()` is useful for finding out how many bits a number requires for storage. This function is equivalent to the expression `LOG(X) / LOG(2)`.

- `LOG10(X)`

Returns the base-10 logarithm of *X*.

```
mysql> SELECT LOG10(2);
      -> 0.30102999566398
mysql> SELECT LOG10(100);
      -> 2
mysql> SELECT LOG10(-100);
      -> NULL
```

`LOG10(X)` is equivalent to `LOG(10, X)`.

- `MOD(N,M), N % M, N MOD M`

Modulo operation. Returns the remainder of *N* divided by *M*.

```
mysql> SELECT MOD(234, 10);
      -> 4
mysql> SELECT 253 % 7;
      -> 1
mysql> SELECT MOD(29,9);
      -> 2
mysql> SELECT 29 MOD 9;
      -> 2
```

This function is safe to use with `BIGINT` values.

`MOD()` also works on values that have a fractional part and returns the exact remainder after division:

```
mysql> SELECT MOD(34.5,3);
      -> 1.5
```

`MOD(N, 0)` returns `NULL`.

- `OCT(N)`

Returns a string representation of the octal value of *N*, where *N* is a longlong (`BIGINT`) number. This is equivalent to `CONV(N, 10, 8)`. Returns `NULL` if *N* is `NULL`.

```
mysql> SELECT OCT(12);
      -> '14'
```

- `PI()`

Returns the value of  $\pi$  (pi). The default number of decimal places displayed is seven, but MySQL uses the full double-precision value internally.

```
mysql> SELECT PI();
      -> 3.141593
mysql> SELECT PI()+0.00000000000000000000;
      -> 3.141592653589793116
```

- `POW(X,Y)`

Returns the value of *X* raised to the power of *Y*.

```
mysql> SELECT POW(2,2);
      -> 4
mysql> SELECT POW(2,-2);
      -> 0.25
```

- `POWER(X,Y)`

This is a synonym for `POW()`.

- `RADIANS(X)`

Returns the argument *X*, converted from degrees to radians. (Note that  $\pi$  radians equals 180 degrees.)

```
mysql> SELECT RADIANS(90);
```

```
-> 1.5707963267949
```

- `RAND()`, `RAND(N)`

Returns a random floating-point value  $v$  in the range  $0 \leq v < 1.0$ . If a constant integer argument  $N$  is specified, it is used as the seed value, which produces a repeatable sequence of column values. In the following example, note that the sequences of values produced by `RAND(3)` is the same both places where it occurs.

```
mysql> CREATE TABLE t (i INT);
Query OK, 0 rows affected (0.42 sec)

mysql> INSERT INTO t VALUES(1),(2),(3);
Query OK, 3 rows affected (0.00 sec)
Records: 3 Duplicates: 0 Warnings: 0

mysql> SELECT i, RAND() FROM t;
+-----+-----+
| i | RAND() |
+-----+-----+
| 1 | 0.61914388706828 |
| 2 | 0.93845168309142 |
| 3 | 0.83482678498591 |
+-----+-----+
3 rows in set (0.00 sec)

mysql> SELECT i, RAND(3) FROM t;
+-----+-----+
| i | RAND(3) |
+-----+-----+
| 1 | 0.90576975597606 |
| 2 | 0.37307905813035 |
| 3 | 0.14808605345719 |
+-----+-----+
3 rows in set (0.00 sec)

mysql> SELECT i, RAND() FROM t;
+-----+-----+
| i | RAND() |
+-----+-----+
| 1 | 0.35877890638893 |
| 2 | 0.28941420772058 |
| 3 | 0.37073435016976 |
+-----+-----+
3 rows in set (0.00 sec)

mysql> SELECT i, RAND(3) FROM t;
+-----+-----+
| i | RAND(3) |
+-----+-----+
| 1 | 0.90576975597606 |
| 2 | 0.37307905813035 |
| 3 | 0.14808605345719 |
+-----+-----+
3 rows in set (0.01 sec)
```

With a constant initializer, the seed is initialized once when the statement is compiled, prior to execution. As of MySQL 5.1.16, if a non-constant initializer (such as a column name) is used as the argument, the seed is initialized with the value for each invocation of `RAND()`. (One implication of this is that for equal argument values, `RAND()` will return the same value each time.) From MySQL 5.1.3 to 5.1.15, non-constant arguments are disallowed. Before that, the effect of using a non-constant argument is undefined.

To obtain a random integer  $R$  in the range  $i \leq R < j$ , use the expression `FLOOR(i + RAND() * (j - i))`. For example, to obtain a random integer in the range the range  $7 \leq R < 12$ , you could use the following statement:

```
SELECT FLOOR(7 + (RAND() * 5));
```

`RAND()` in a `WHERE` clause is re-evaluated every time the `WHERE` is executed.

You cannot use a column with `RAND()` values in an `ORDER BY` clause, because `ORDER BY` would evaluate the column multiple times. However, you can retrieve rows in random order like this:

```
mysql> SELECT * FROM tbl_name ORDER BY RAND();
```

`ORDER BY RAND()` combined with `LIMIT` is useful for selecting a random sample from a set of rows:

```
mysql> SELECT * FROM table1, table2 WHERE a=b AND c<d -> ORDER BY RAND() LIMIT 1000;
```

`RAND()` is not meant to be a perfect random generator, but instead is a fast way to generate *ad hoc* random numbers which is portable between platforms for the same MySQL version.

- `ROUND(X)`, `ROUND(X, D)`

Rounds the argument *X* to *D* decimal places. The rounding algorithm depends on the data type of *X*. *D* defaults to 0 if not specified. *D* can be negative to cause *D* digits left of the decimal point of the value *X* to become zero.

```
mysql> SELECT ROUND(-1.23);
-> -1
mysql> SELECT ROUND(-1.58);
-> -2
mysql> SELECT ROUND(1.58);
-> 2
mysql> SELECT ROUND(1.298, 1);
-> 1.3
mysql> SELECT ROUND(1.298, 0);
-> 1
mysql> SELECT ROUND(23.298, -1);
-> 20
```

The return type is the same type as that of the first argument (assuming that it is integer, double, or decimal). This means that for an integer argument, the result is an integer (no decimal places):

```
mysql> SELECT ROUND(150.000,2), ROUND(150,2);
+-----+-----+
| ROUND(150.000,2) | ROUND(150,2) |
+-----+-----+
| 150.00 | 150 |
+-----+-----+
```

`ROUND()` uses the following rules depending on the type of the first argument:

- For exact-value numbers, `ROUND()` uses the “round half up” or “round toward nearest” rule: A value with a fractional part of .5 or greater is rounded up to the next integer if positive or down to the next integer if negative. (In other words, it is rounded away from zero.) A value with a fractional part less than .5 is rounded down to the next integer if positive or up to the next integer if negative.
- For approximate-value numbers, the result depends on the C library. On many systems, this means that `ROUND()` uses the “round to nearest even” rule: A value with any fractional part is rounded to the nearest even integer.

The following example shows how rounding differs for exact and approximate values:

```
mysql> SELECT ROUND(2.5), ROUND(25E-1);
+-----+-----+
| ROUND(2.5) | ROUND(25E-1) |
+-----+-----+
| 3 | 2 |
+-----+-----+
```

For more information, see [Section 11.14, “Precision Math”](#).

- `SIGN(X)`

Returns the sign of the argument as `-1`, `0`, or `1`, depending on whether *X* is negative, zero, or positive.

```
mysql> SELECT SIGN(-32);
-> -1
mysql> SELECT SIGN(0);
-> 0
mysql> SELECT SIGN(234);
-> 1
```

- `SIN(X)`

Returns the sine of *X*, where *X* is given in radians.

```
mysql> SELECT SIN(PI());
-> 1.2246063538224e-16
mysql> SELECT ROUND(SIN(PI()));
-> 0
```

- `SQRT(X)`

Returns the square root of a non-negative number *X*.

```
mysql> SELECT SQRT(4);
-> 2
mysql> SELECT SQRT(20);
-> 4.4721359549996
mysql> SELECT SQRT(-16);
```



```
--> NULL
```

- `TAN(X)`

Returns the tangent of  $X$ , where  $X$  is given in radians.

```
mysql> SELECT TAN(PI());
-> -1.2246063538224e-16
mysql> SELECT TAN(PI()+1);
-> 1.5574077246549
```

- `TRUNCATE(X,D)`

Returns the number  $X$ , truncated to  $D$  decimal places. If  $D$  is 0, the result has no decimal point or fractional part.  $D$  can be negative to cause  $D$  digits left of the decimal point of the value  $X$  to become zero.

```
mysql> SELECT TRUNCATE(1.223,1);
-> 1.2
mysql> SELECT TRUNCATE(1.999,1);
-> 1.9
mysql> SELECT TRUNCATE(1.999,0);
-> 1
mysql> SELECT TRUNCATE(-1.999,1);
-> -1.9
mysql> SELECT TRUNCATE(122,-2);
-> 100
mysql> SELECT TRUNCATE(10.28*100,0);
-> 1028
```

All numbers are rounded toward zero.

## 11.6. Date and Time Functions

This section describes the functions that can be used to manipulate temporal values. See [Section 10.3, “Date and Time Types”](#), for a description of the range of values each date and time type has and the valid formats in which values may be specified.

Name	Description
<code>ADDDATE()</code> (v4.1.1)	Add dates
<code>ADDTIME()</code> (v4.1.1)	Add time
<code>CONVERT_TZ()</code> (v4.1.3)	Convert from one timezone to another
<code>CURDATE()</code>	Return the current date
<code>CURRENT_DATE()</code> , <code>CURRENT_DATE</code>	Synonyms for <code>CURDATE()</code>
<code>CURRENT_TIME()</code> , <code>CURRENT_TIME</code>	Synonyms for <code>CURTIME()</code>
<code>CURRENT_TIMESTAMP()</code> , <code>CURRENT_TIMESTAMP</code>	Synonyms for <code>NOW()</code>
<code>CURTIME()</code>	Return the current time
<code>DATE_ADD()</code>	Add two dates
<code>DATE_FORMAT()</code>	Format date as specified
<code>DATE_SUB()</code>	Subtract two dates
<code>DATE()</code> (v4.1.1)	Extract the date part of a date or datetime expression
<code>DATEDIFF()</code> (v4.1.1)	Subtract two dates
<code>DAY()</code> (v4.1.1)	Synonym for <code>DAYOFMONTH()</code>
<code>DAYNAME()</code> (v4.1.21)	Return the name of the weekday
<code>DAYOFMONTH()</code>	Return the day of the month (0-31)
<code>DAYOFWEEK()</code>	Return the weekday index of the argument
<code>DAYOFYEAR()</code>	Return the day of the year (1-366)
<code>EXTRACT</code>	Extract part of a date
<code>FROM_DAYS()</code>	Convert a day number to a date
<code>FROM_UNIXTIME()</code>	Format UNIX timestamp as a date
<code>GET_FORMAT()</code> (v4.1.1)	Return a date format string
<code> HOUR()</code>	Extract the hour

Name	Description
LAST_DAY(v4.1.1)	Return the last day of the month for the argument
LOCALTIME ( ), LOCALTIME	Synonym for NOW()
LOCALTIMESTAMP, LOCALTIMESTAMP ( ) (v4.0.6)	Synonym for NOW()
MAKEDATE ( ) (v4.1.1)	Create a date from the year and day of year
MAKETIME(v4.1.1)	MAKETIME()
MICROSECOND ( ) (v4.1.1)	Return the microseconds from argument
MINUTE ( )	Return the minute from the argument
MONTH ( )	Return the month from the date passed
MONTHNAME ( ) (v4.1.21)	Return the name of the month
NOW ( )	Return the current date and time
PERIOD_ADD ( )	Add a period to a year-month
PERIOD_DIFF ( )	Return the number of months between periods
QUARTER ( )	Return the quarter from a date argument
SEC_TO_TIME ( )	Converts seconds to 'HH:MM:SS' format
SECOND ( )	Return the second (0-59)
STR_TO_DATE ( ) (v4.1.1)	Convert a string to a date
SUBDATE ( )	A synonym for DATE_SUB() when invoked with three arguments
SUBTIME ( ) (v4.1.1)	Subtract times
SYSDATE ( )	Return the time at which the function executes
TIME_FORMAT ( )	Format as time
TIME_TO_SEC ( )	Return the argument converted to seconds
TIME ( ) (v4.1.1)	Extract the time portion of the expression passed
TIMEDIFF ( ) (v4.1.1)	Subtract time
TIMESTAMP ( ) (v4.1.1)	With a single argument, this function returns the date or datetime expression; with two arguments, the sum of the arguments
TIMESTAMPADD ( ) (v5.0.0)	Add an interval to a datetime expression
TIMESTAMPDIFF ( ) (v5.0.0)	Subtract an interval from a datetime expression
TO_DAYS ( )	Return the date argument converted to days
UNIX_TIMESTAMP ( )	Return a UNIX timestamp
UTC_DATE ( ) (v4.1.1)	Return the current UTC date
UTC_TIME ( ) (v4.1.1)	Return the current UTC time
UTC_TIMESTAMP ( ) (v4.1.1)	Return the current UTC date and time
WEEK ( )	Return the week number
WEEKDAY ( )	Return the weekday index
WEEKOFYEAR ( ) (v4.1.1)	Return the calendar week of the date (0-53)
YEAR ( )	Return the year
YEARWEEK ( )	Return the year and week

Here is an example that uses date functions. The following query selects all rows with a *date\_col* value from within the last 30 days:

```
mysql> SELECT something FROM tbl_name
-> WHERE DATE_SUB(CURDATE(),INTERVAL 30 DAY) <= date_col;
```

The query also selects rows with dates that lie in the future.

Functions that expect date values usually accept datetime values and ignore the time part. Functions that expect time values usually accept datetime values and ignore the date part.

Functions that return the current date or time each are evaluated only once per query at the start of query execution. This means that

multiple references to a function such as `NOW()` within a single query always produce the same result. (For our purposes, a single query also includes a call to a stored program (stored routine, trigger, or event) and all sub-programs called by that program.) This principle also applies to `CURDATE()`, `CURTIME()`, `UTC_DATE()`, `UTC_TIME()`, `UTC_TIMESTAMP()`, and to any of their synonyms.

The `CURRENT_TIMESTAMP()`, `CURRENT_TIME()`, `CURRENT_DATE()`, and `FROM_UNIXTIME()` functions return values in the connection's current time zone, which is available as the value of the `time_zone` system variable. In addition, `UNIX_TIMESTAMP()` assumes that its argument is a datetime value in the current time zone. See [Section 9.7, “MySQL Server Time Zone Support”](#).

Some date functions can be used with “zero” dates or incomplete dates such as `'2001-11-00'`, whereas others cannot. Functions that extract parts of dates typically work with incomplete dates and thus can return 0 when you might otherwise expect a nonzero value. For example:

```
mysql> SELECT DAYOFMONTH('2001-11-00'), MONTH('2005-00-00');
-> 0, 0
```

Other functions expect complete dates and return `NULL` for incomplete dates. These include functions that perform date arithmetic or that map parts of dates to names. For example:

```
mysql> SELECT DATE_ADD('2006-05-00',INTERVAL 1 DAY);
-> NULL
mysql> SELECT DAYNAME('2006-05-00');
-> NULL
```

- `ADDDATE(date, INTERVAL expr unit), ADDDATE(expr, days)`

When invoked with the `INTERVAL` form of the second argument, `ADDDATE()` is a synonym for `DATE_ADD()`. The related function `SUBDATE()` is a synonym for `DATE_SUB()`. For information on the `INTERVAL unit` argument, see the discussion for `DATE_ADD()`.

```
mysql> SELECT DATE_ADD('2008-01-02', INTERVAL 31 DAY);
-> '2008-02-02'
mysql> SELECT ADDDATE('2008-01-02', INTERVAL 31 DAY);
-> '2008-02-02'
```

When invoked with the `days` form of the second argument, MySQL treats it as an integer number of days to be added to `expr`.

```
mysql> SELECT ADDDATE('2008-01-02', 31);
-> '2008-02-02'
```

- `ADDTIME(expr1, expr2)`

`ADDTIME()` adds `expr2` to `expr1` and returns the result. `expr1` is a time or datetime expression, and `expr2` is a time expression.

```
mysql> SELECT ADDTIME('2007-12-31 23:59:59.999999', '1 1:1:1.000002');
-> '2008-01-02 01:01:01.000001'
mysql> SELECT ADDTIME('01:00:00.999999', '02:00:00.999998');
-> '03:00:01.999997'
```

- `CONVERT_TZ(dt, from_tz, to_tz)`

`CONVERT_TZ()` converts a datetime value `dt` from the time zone given by `from_tz` to the time zone given by `to_tz` and returns the resulting value. Time zones are specified as described in [Section 9.7, “MySQL Server Time Zone Support”](#). This function returns `NULL` if the arguments are invalid.

If the value falls out of the supported range of the `TIMESTAMP` type when converted from `from_tz` to UTC, no conversion occurs. The `TIMESTAMP` range is described in [Section 10.1.2, “Overview of Date and Time Types”](#).

```
mysql> SELECT CONVERT_TZ('2004-01-01 12:00:00', 'GMT', 'MET');
-> '2004-01-01 13:00:00'
mysql> SELECT CONVERT_TZ('2004-01-01 12:00:00', '+00:00', '+10:00');
-> '2004-01-01 22:00:00'
```

## Note

To use named time zones such as `'MET'` or `'Europe/Moscow'`, the time zone tables must be properly set up. See [Section 9.7, “MySQL Server Time Zone Support”](#), for instructions.

Before MySQL 5.1.17, if you intend to use `CONVERT_TZ()` while other tables are locked with `LOCK TABLES`, you must also lock the `mysql.time_zone_name` table. See [Section 12.4.5, “LOCK TABLES and UNLOCK TABLES Syntax”](#).

- `CURDATE()`

Returns the current date as a value in 'YYYY-MM-DD' or YYYYMMDD format, depending on whether the function is used in a string or numeric context.

```
mysql> SELECT CURDATE();
-> '2008-06-13'
mysql> SELECT CURDATE() + 0;
-> 20080613
```

- `CURRENT_DATE`, `CURRENT_DATE()`

`CURRENT_DATE` and `CURRENT_DATE()` are synonyms for `CURDATE()`.

- `CURTIME()`

Returns the current time as a value in 'HH:MM:SS' or HHMMSS.uuuuuu format, depending on whether the function is used in a string or numeric context. The value is expressed in the current time zone.

```
mysql> SELECT CURTIME();
-> '23:50:26'
mysql> SELECT CURTIME() + 0;
-> 235026.000000
```

- `CURRENT_TIME`, `CURRENT_TIME()`

`CURRENT_TIME` and `CURRENT_TIME()` are synonyms for `CURTIME()`.

- `CURRENT_TIMESTAMP`, `CURRENT_TIMESTAMP()`

`CURRENT_TIMESTAMP` and `CURRENT_TIMESTAMP()` are synonyms for `NOW()`.

- `DATE(expr)`

Extracts the date part of the date or datetime expression *expr*.

```
mysql> SELECT DATE('2003-12-31 01:02:03');
-> '2003-12-31'
```

- `DATEDIFF(expr1,expr2)`

`DATEDIFF()` returns *expr1* – *expr2* expressed as a value in days from one date to the other. *expr1* and *expr2* are date or date-and-time expressions. Only the date parts of the values are used in the calculation.

```
mysql> SELECT DATEDIFF('2007-12-31 23:59:59','2007-12-30');
-> 1
mysql> SELECT DATEDIFF('2010-11-30 23:59:59','2010-12-31');
-> -31
```

- `DATE_ADD(date,INTERVAL expr unit)`, `DATE_SUB(date,INTERVAL expr unit)`

These functions perform date arithmetic. The *date* argument specifies the starting date or datetime value. *expr* is an expression specifying the interval value to be added or subtracted from the starting date. *expr* is a string; it may start with a “-” for negative intervals. *unit* is a keyword indicating the units in which the expression should be interpreted.

The `INTERVAL` keyword and the *unit* specifier are not case sensitive.

The following table shows the expected form of the *expr* argument for each *unit* value.

<i>unit</i> Value	Expected <i>expr</i> Format
MICROSECOND	MICROSECONDS
SECOND	SECONDS
MINUTE	MINUTES
HOUR	HOURS
DAY	DAYS
WEEK	WEEKS

MONTH	MONTHS
QUARTER	QUARTERS
YEAR	YEARS
SECOND_MICROSECOND	'SECONDS.MICROSECONDS'
MINUTE_MICROSECOND	'MINUTES:SECONDS.MICROSECONDS'
MINUTE_SECOND	'MINUTES:SECONDS'
HOURL_MICROSECOND	'HOURS:MINUTES:SECONDS.MICROSECONDS'
HOURL_SECOND	'HOURS:MINUTES:SECONDS'
HOURL_MINUTE	'HOURS:MINUTES'
DAY_MICROSECOND	'DAYS HOURS:MINUTES:SECONDS.MICROSECONDS'
DAY_SECOND	'DAYS HOURS:MINUTES:SECONDS'
DAY_MINUTE	'DAYS HOURS:MINUTES'
DAY_HOUR	'DAYS HOURS'
YEAR_MONTH	'YEARS-MONTHS'

The return value depends on the arguments:

- `DATETIME` if the first argument is a `DATETIME` (or `TIMESTAMP`) value, or if the first argument is a `DATE` and the `unit` value uses `HOURS`, `MINUTES`, or `SECONDS`.
- String otherwise.

To ensure that the result is `DATETIME`, you can use `CAST()` to convert the first argument to `DATETIME`.

MySQL allows any punctuation delimiter in the `expr` format. Those shown in the table are the suggested delimiters. If the `date` argument is a `DATE` value and your calculations involve only `YEAR`, `MONTH`, and `DAY` parts (that is, no time parts), the result is a `DATE` value. Otherwise, the result is a `DATETIME` value.

Date arithmetic also can be performed using `INTERVAL` together with the `+` or `-` operator:

```
date + INTERVAL expr unit
date - INTERVAL expr unit
```

`INTERVAL expr unit` is allowed on either side of the `+` operator if the expression on the other side is a date or datetime value. For the `-` operator, `INTERVAL expr unit` is allowed only on the right side, because it makes no sense to subtract a date or datetime value from an interval.

```
mysql> SELECT '2008-12-31 23:59:59' + INTERVAL 1 SECOND;
-> '2009-01-01 00:00:00'
mysql> SELECT INTERVAL 1 DAY + '2008-12-31';
-> '2009-01-01'
mysql> SELECT '2005-01-01' - INTERVAL 1 SECOND;
-> '2004-12-31 23:59:59'
mysql> SELECT DATE_ADD('2000-12-31 23:59:59',
-> INTERVAL 1 SECOND);
-> '2001-01-01 00:00:00'
mysql> SELECT DATE_ADD('2010-12-31 23:59:59',
-> INTERVAL 1 DAY);
-> '2011-01-01 23:59:59'
mysql> SELECT DATE_ADD('2100-12-31 23:59:59',
-> INTERVAL '1:1' MINUTE_SECOND);
-> '2101-01-01 00:01:00'
mysql> SELECT DATE_SUB('2005-01-01 00:00:00',
-> INTERVAL '1 1:1:1' DAY_SECOND);
-> '2004-12-30 22:58:59'
mysql> SELECT DATE_ADD('1900-01-01 00:00:00',
-> INTERVAL '-1 10' DAY_HOUR);
-> '1899-12-30 14:00:00'
mysql> SELECT DATE_SUB('1998-01-02', INTERVAL 31 DAY);
-> '1997-12-02'
mysql> SELECT DATE_ADD('1992-12-31 23:59:59.000002',
-> INTERVAL '1.999999' SECOND_MICROSECOND);
-> '1993-01-01 00:00:01.000001'
```

If you specify an interval value that is too short (does not include all the interval parts that would be expected from the `unit` keyword), MySQL assumes that you have left out the leftmost parts of the interval value. For example, if you specify a `unit` of `DAY_SECOND`, the value of `expr` is expected to have days, hours, minutes, and seconds parts. If you specify a value like `'1:10'`, MySQL assumes that the days and hours parts are missing and the value represents minutes and seconds. In other

words, '1:10' DAY\_SECOND is interpreted in such a way that it is equivalent to '1:10' MINUTE\_SECOND. This is analogous to the way that MySQL interprets TIME values as representing elapsed time rather than as a time of day.

Because *expr* is treated as a string, be careful if you specify a non-string value with INTERVAL. For example, with an interval specifier of HOUR\_MINUTE, 6/4 evaluates to 1.5000 and is treated as 1 hour, 5000 minutes:

```
mysql> SELECT 6/4;
-> 1.5000
mysql> SELECT DATE_ADD('2009-01-01', INTERVAL 6/4 HOUR_MINUTE);
-> '2009-01-04 12:20:00'
```

To ensure interpretation of the interval value as you expect, a CAST() operation may be used. To treat 6/4 as 1 hour, 5 minutes, cast it to a DECIMAL value with a single fractional digit:

```
mysql> SELECT CAST(6/4 AS DECIMAL(3,1));
-> 1.5
mysql> SELECT DATE_ADD('1970-01-01 12:00:00',
-> INTERVAL CAST(6/4 AS DECIMAL(3,1)) HOUR_MINUTE);
-> '1970-01-01 13:05:00'
```

If you add to or subtract from a date value something that contains a time part, the result is automatically converted to a date-time value:

```
mysql> SELECT DATE_ADD('2013-01-01', INTERVAL 1 DAY);
-> '2013-01-02'
mysql> SELECT DATE_ADD('2013-01-01', INTERVAL 1 HOUR);
-> '2013-01-01 01:00:00'
```

If you add MONTH, YEAR\_MONTH, or YEAR and the resulting date has a day that is larger than the maximum day for the new month, the day is adjusted to the maximum days in the new month:

```
mysql> SELECT DATE_ADD('2009-01-30', INTERVAL 1 MONTH);
-> '2009-02-28'
```

Date arithmetic operations require complete dates and do not work with incomplete dates such as '2006-07-00' or badly malformed dates:

```
mysql> SELECT DATE_ADD('2006-07-00', INTERVAL 1 DAY);
-> NULL
mysql> SELECT '2005-03-32' + INTERVAL 1 MONTH;
-> NULL
```

- DATE\_FORMAT(*date*, *format*)

Formats the *date* value according to the *format* string.

The following specifiers may be used in the *format* string. The “%” character is required before format specifier characters.

Specifier	Description
%a	Abbreviated weekday name (Sun..Sat)
%b	Abbreviated month name (Jan..Dec)
%c	Month, numeric (0..12)
%D	Day of the month with English suffix (0th, 1st, 2nd, 3rd, ...)
%d	Day of the month, numeric (00..31)
%e	Day of the month, numeric (0..31)
%f	Microseconds (000000..999999)
%H	Hour (00..23)
%h	Hour (01..12)
%I	Hour (01..12)
%i	Minutes, numeric (00..59)
%j	Day of year (001..366)
%k	Hour (0..23)
%l	Hour (1..12)
%M	Month name (January..December)
%m	Month, numeric (00..12)

<code>%p</code>	AM or PM
<code>%r</code>	Time, 12-hour ( <code>hh:mm:ss</code> followed by AM or PM)
<code>%S</code>	Seconds (00..59)
<code>%s</code>	Seconds (00..59)
<code>%T</code>	Time, 24-hour ( <code>hh:mm:ss</code> )
<code>%U</code>	Week (00..53), where Sunday is the first day of the week
<code>%u</code>	Week (00..53), where Monday is the first day of the week
<code>%V</code>	Week (01..53), where Sunday is the first day of the week; used with <code>%X</code>
<code>%v</code>	Week (01..53), where Monday is the first day of the week; used with <code>%x</code>
<code>%W</code>	Weekday name (Sunday..Saturday)
<code>%w</code>	Day of the week (0=Sunday..6=Saturday)
<code>%X</code>	Year for the week where Sunday is the first day of the week, numeric, four digits; used with <code>%V</code>
<code>%x</code>	Year for the week, where Monday is the first day of the week, numeric, four digits; used with <code>%v</code>
<code>%Y</code>	Year, numeric, four digits
<code>%y</code>	Year, numeric (two digits)
<code>%%</code>	A literal “%” character
<code>%x</code>	<code>x</code> , for any “ <code>x</code> ” not listed above

Ranges for the month and day specifiers begin with zero due to the fact that MySQL allows the storing of incomplete dates such as '2014-00-00'.

As of MySQL 5.1.12, the language used for day and month names and abbreviations is controlled by the value of the `lc_time_names` system variable (Section 9.8, “MySQL Server Locale Support”).

As of MySQL 5.1.15, `DATE_FORMAT()` returns a string with a character set and collation given by `character_set_connection` and `collation_connection` so that it can return month and weekday names containing non-ASCII characters. Before 5.1.15, the return value is a binary string.

```
mysql> SELECT DATE_FORMAT('2009-10-04 22:23:00', '%W %M %Y');
-> 'Sunday October 2009'
mysql> SELECT DATE_FORMAT('2007-10-04 22:23:00', '%H:%i:%s');
-> '22:23:00'
mysql> SELECT DATE_FORMAT('1900-10-04 22:23:00',
-> '%D %y %a %d %m %b %j');
-> '4th 00 Thu 04 10 Oct 277'
mysql> SELECT DATE_FORMAT('1997-10-04 22:23:00',
-> '%H %k %I %r %T %S %w');
-> '22 22 10 10:23:00 PM 22:23:00 00 6'
mysql> SELECT DATE_FORMAT('1999-01-01', '%X %V');
-> '1998 52'
mysql> SELECT DATE_FORMAT('2006-06-00', '%d');
-> '00'
```

- `DATE_SUB(date, INTERVAL expr unit)`

See the description for `DATE_ADD()`.

- `DAY(date)`

`DAY()` is a synonym for `DAYOFMONTH()`.

- `DAYNAME(date)`

Returns the name of the weekday for `date`. As of MySQL 5.1.12, the language used for the name is controlled by the value of the `lc_time_names` system variable (Section 9.8, “MySQL Server Locale Support”).

```
mysql> SELECT DAYNAME('2007-02-03');
-> 'Saturday'
```

- `DAYOFMONTH(date)`

Returns the day of the month for `date`, in the range 1 to 31, or 0 for dates such as '0000-00-00' or '2008-00-00' that have a zero day part.

```
mysql> SELECT DAYOFMONTH('2007-02-03');
```

```
-> 3
```

- `DAYOFWEEK(date)`

Returns the weekday index for *date* (1 = Sunday, 2 = Monday, ..., 7 = Saturday). These index values correspond to the ODBC standard.

```
mysql> SELECT DAYOFWEEK('2007-02-03');
-> 7
```

- `DAYOFYEAR(date)`

Returns the day of the year for *date*, in the range 1 to 366.

```
mysql> SELECT DAYOFYEAR('2007-02-03');
-> 34
```

- `EXTRACT(unit FROM date)`

The `EXTRACT()` function uses the same kinds of unit specifiers as `DATE_ADD()` or `DATE_SUB()`, but extracts parts from the date rather than performing date arithmetic.

```
mysql> SELECT EXTRACT(YEAR FROM '2009-07-02');
-> 2009
mysql> SELECT EXTRACT(YEAR_MONTH FROM '2009-07-02 01:02:03');
-> 200907
mysql> SELECT EXTRACT(DAY_MINUTE FROM '2009-07-02 01:02:03');
-> 20102
mysql> SELECT EXTRACT(MICROSECOND
-> FROM '2003-01-02 10:30:00.000123');
-> 123
```

- `FROM_DAYS(N)`

Given a day number *N*, returns a `DATE` value.

```
mysql> SELECT FROM_DAYS(730669);
-> '2007-07-03'
```

Use `FROM_DAYS()` with caution on old dates. It is not intended for use with values that precede the advent of the Gregorian calendar (1582). See [Section 11.7, “What Calendar Is Used By MySQL?”](#).

- `FROM_UNIXTIME(unix_timestamp)`, `FROM_UNIXTIME(unix_timestamp, format)`

Returns a representation of the *unix\_timestamp* argument as a value in 'YYYY-MM-DD HH:MM:SS' or 'YYYYMMDDH-HMMSS.uuuuuu' format, depending on whether the function is used in a string or numeric context. The value is expressed in the current time zone. *unix\_timestamp* is an internal timestamp value such as is produced by the `UNIX_TIMESTAMP()` function.

If *format* is given, the result is formatted according to the *format* string, which is used the same way as listed in the entry for the `DATE_FORMAT()` function.

```
mysql> SELECT FROM_UNIXTIME(1196440219);
-> '2007-11-30 10:30:19'
mysql> SELECT FROM_UNIXTIME(1196440219) + 0;
-> 20071130103019.000000
mysql> SELECT FROM_UNIXTIME(UNIX_TIMESTAMP(),
-> '%Y %D %M %h:%i:%s %x');
-> '2007 30th November 10:30:59 2007'
```

Note: If you use `UNIX_TIMESTAMP()` and `FROM_UNIXTIME()` to convert between `TIMESTAMP` values and Unix timestamp values, the conversion is lossy because the mapping is not one-to-one in both directions. For details, see the description of the `UNIX_TIMESTAMP()` function.

- `GET_FORMAT({DATE|TIME|DATETIME}, {'EUR'|'USA'|'JIS'|'ISO'|'INTERNAL'})`

Returns a format string. This function is useful in combination with the `DATE_FORMAT()` and the `STR_TO_DATE()` functions.

The possible values for the first and second arguments result in several possible format strings (for the specifiers used, see the table in the `DATE_FORMAT()` function description). ISO format refers to ISO 9075, not ISO 8601.

Function Call	Result
---------------	--------



GET_FORMAT(DATE, 'USA')	'%m.%d.%Y'
GET_FORMAT(DATE, 'JIS')	'%Y-%m-%d'
GET_FORMAT(DATE, 'ISO')	'%Y-%m-%d'
GET_FORMAT(DATE, 'EUR')	'%d.%m.%Y'
GET_FORMAT(DATE, 'INTERNAL')	'%Y%m%d'
GET_FORMAT(DATETIME, 'USA')	'%Y-%m-%d %H.%i.%s'
GET_FORMAT(DATETIME, 'JIS')	'%Y-%m-%d %H:%i:%s'
GET_FORMAT(DATETIME, 'ISO')	'%Y-%m-%d %H:%i:%s'
GET_FORMAT(DATETIME, 'EUR')	'%Y-%m-%d %H.%i.%s'
GET_FORMAT(DATETIME, 'INTERNAL')	'%Y%m%d%H%i%s'
GET_FORMAT(TIME, 'USA')	'%h:%i:%s %p'
GET_FORMAT(TIME, 'JIS')	'%H:%i:%s'
GET_FORMAT(TIME, 'ISO')	'%H:%i:%s'
GET_FORMAT(TIME, 'EUR')	'%H.%i.%s'
GET_FORMAT(TIME, 'INTERNAL')	'%H%i%s'

`TIMESTAMP` can also be used as the first argument to `GET_FORMAT()`, in which case the function returns the same values as for `DATETIME`.

```
mysql> SELECT DATE_FORMAT('2003-10-03',GET_FORMAT(DATE,'EUR'));
-> '03.10.2003'
mysql> SELECT STR_TO_DATE('10.31.2003',GET_FORMAT(DATE,'USA'));
-> '2003-10-31'
```

- `HOUR(time)`

Returns the hour for *time*. The range of the return value is 0 to 23 for time-of-day values. However, the range of `TIME` values actually is much larger, so `HOUR` can return values greater than 23.

```
mysql> SELECT HOUR('10:05:03');
-> 10
mysql> SELECT HOUR('272:59:59');
-> 272
```

- `LAST_DAY(date)`

Takes a date or datetime value and returns the corresponding value for the last day of the month. Returns `NULL` if the argument is invalid.

```
mysql> SELECT LAST_DAY('2003-02-05');
-> '2003-02-28'
mysql> SELECT LAST_DAY('2004-02-05');
-> '2004-02-29'
mysql> SELECT LAST_DAY('2004-01-01 01:01:01');
-> '2004-01-31'
mysql> SELECT LAST_DAY('2003-03-32');
-> NULL
```

- `LOCALTIME, LOCALTIME()`

`LOCALTIME` and `LOCALTIME()` are synonyms for `NOW()`.

- `LOCALTIMESTAMP, LOCALTIMESTAMP()`

`LOCALTIMESTAMP` and `LOCALTIMESTAMP()` are synonyms for `NOW()`.

- `MAKEDATE(year, dayofyear)`

Returns a date, given year and day-of-year values. *dayofyear* must be greater than 0 or the result is `NULL`.

```
mysql> SELECT MAKEDATE(2011,31), MAKEDATE(2011,32);
-> '2011-01-31', '2011-02-01'
mysql> SELECT MAKEDATE(2011,365), MAKEDATE(2014,365);
-> '2011-12-31', '2014-12-31'
mysql> SELECT MAKEDATE(2011,0);
-> NULL
```

- `MAKETIME(hour, minute, second)`

Returns a time value calculated from the *hour*, *minute*, and *second* arguments.

```
mysql> SELECT MAKETIME(12,15,30);
-> '12:15:30'
```

- `MICROSECOND(expr)`

Returns the microseconds from the time or datetime expression *expr* as a number in the range from 0 to 999999.

```
mysql> SELECT MICROSECOND('12:00:00.123456');
-> 123456
mysql> SELECT MICROSECOND('2009-12-31 23:59:59.000010');
-> 10
```

- `MINUTE(time)`

Returns the minute for *time*, in the range 0 to 59.

```
mysql> SELECT MINUTE('2008-02-03 10:05:03');
-> 5
```

- `MONTH(date)`

Returns the month for *date*, in the range 1 to 12 for January to December, or 0 for dates such as '0000-00-00' or '2008-00-00' that have a zero month part.

```
mysql> SELECT MONTH('2008-02-03');
-> 2
```

- `MONTHNAME(date)`

Returns the full name of the month for *date*. As of MySQL 5.1.12, the language used for the name is controlled by the value of the `lc_time_names` system variable (Section 9.8, “MySQL Server Locale Support”).

```
mysql> SELECT MONTHNAME('2008-02-03');
-> 'February'
```

- `NOW()`

Returns the current date and time as a value in 'YYYY-MM-DD HH:MM:SS' or YYYYMMDDHHMMSS.uuuuuu format, depending on whether the function is used in a string or numeric context. The value is expressed in the current time zone.

```
mysql> SELECT NOW();
-> '2007-12-15 23:50:26'
mysql> SELECT NOW() + 0;
-> 20071215235026.000000
```

`NOW()` returns a constant time that indicates the time at which the statement began to execute. (Within a stored function or trigger, `NOW()` returns the time at which the function or triggering statement began to execute.) This differs from the behavior for `SYSDATE()`, which returns the exact time at which it executes.

```
mysql> SELECT NOW(), SLEEP(2), NOW();
+-----+-----+-----+
| NOW() | SLEEP(2) | NOW() |
+-----+-----+-----+
| 2006-04-12 13:47:36 | 0 | 2006-04-12 13:47:36 |
+-----+-----+-----+

mysql> SELECT SYSDATE(), SLEEP(2), SYSDATE();
+-----+-----+-----+
| SYSDATE() | SLEEP(2) | SYSDATE() |
+-----+-----+-----+
| 2006-04-12 13:47:44 | 0 | 2006-04-12 13:47:46 |
+-----+-----+-----+
```

In addition, the `SET TIMESTAMP` statement affects the value returned by `NOW()` but not by `SYSDATE()`. This means that timestamp settings in the binary log have no effect on invocations of `SYSDATE()`.

See the description for `SYSDATE()` for additional information about the differences between the two functions.

- `PERIOD_ADD(P,N)`

Adds *N* months to period *P* (in the format `YYMM` or `YYYYMM`). Returns a value in the format `YYYYMM`. Note that the period argument *P* is *not* a date value.

```
mysql> SELECT PERIOD_ADD(200801,2);
-> 200803
```

- `PERIOD_DIFF(P1,P2)`

Returns the number of months between periods *P1* and *P2*. *P1* and *P2* should be in the format `YYMM` or `YYYYMM`. Note that the period arguments *P1* and *P2* are *not* date values.

```
mysql> SELECT PERIOD_DIFF(200802,200703);
-> 11
```

- `QUARTER(date)`

Returns the quarter of the year for *date*, in the range 1 to 4.

```
mysql> SELECT QUARTER('2008-04-01');
-> 2
```

- `SECOND(time)`

Returns the second for *time*, in the range 0 to 59.

```
mysql> SELECT SECOND('10:05:03');
-> 3
```

- `SEC_TO_TIME(seconds)`

Returns the *seconds* argument, converted to hours, minutes, and seconds, as a `TIME` value. The range of the result is constrained to that of the `TIME` data type. A warning occurs if the argument corresponds to a value outside that range.

```
mysql> SELECT SEC_TO_TIME(2378);
-> '00:39:38'
mysql> SELECT SEC_TO_TIME(2378) + 0;
-> 3938
```

- `STR_TO_DATE(str,format)`

This is the inverse of the `DATE_FORMAT()` function. It takes a string *str* and a format string *format*. `STR_TO_DATE()` returns a `DATETIME` value if the format string contains both date and time parts, or a `DATE` or `TIME` value if the string contains only date or time parts. If the date, time, or datetime value extracted from *str* is illegal, `STR_TO_DATE()` returns `NULL` and produces a warning.

The server scans *str* attempting to match *format* to it. The format string can contain literal characters and format specifiers beginning with `%`. Literal characters in *format* must match literally in *str*. Format specifiers in *format* must match a date or time part in *str*. For the specifiers that can be used in *format*, see the `DATE_FORMAT()` function description.

```
mysql> SELECT STR_TO_DATE('01,5,2013','%d,%m,%Y');
-> '2013-05-01'
mysql> SELECT STR_TO_DATE('May 1, 2013','%M %d,%Y');
-> '2013-05-01'
```

Scanning starts at the beginning of *str* and fails if *format* is found not to match. Extra characters at the end of *str* are ignored.

```
mysql> SELECT STR_TO_DATE('a09:30:17','a%h:%i:%s');
-> '09:30:17'
mysql> SELECT STR_TO_DATE('a09:30:17','%h:%i:%s');
-> NULL
mysql> SELECT STR_TO_DATE('09:30:17a','%h:%i:%s');
-> '09:30:17'
```

Unspecified date or time parts have a value of 0, so incompletely specified values in *str* produce a result with some or all parts set to 0:

```
mysql> SELECT STR_TO_DATE('abc','abc');
-> '0000-00-00'
mysql> SELECT STR_TO_DATE('9','%m');
-> '0000-09-00'
mysql> SELECT STR_TO_DATE('9','%s');
-> '0000-00-00'
```

```
-> '00:00:09'
```

Range checking on the parts of date values is as described in [Section 10.3.1, “The DATETIME, DATE, and TIMESTAMP Types”](#). This means, for example, that “zero” dates or dates with part values of 0 are allowed unless the SQL mode is set to disallow such values.

```
mysql> SELECT STR_TO_DATE('00/00/0000', '%m/%d/%Y');
-> '0000-00-00'
mysql> SELECT STR_TO_DATE('04/31/2004', '%m/%d/%Y');
-> '2004-04-31'
```

### Note

You cannot use format “%X%V” to convert a year-week string to a date because the combination of a year and week does not uniquely identify a year and month if the week crosses a month boundary. To convert a year-week to a date, then you should also specify the weekday:

```
mysql> SELECT STR_TO_DATE('200442 Monday', '%X%V %W');
-> '2004-10-18'
```

- `SUBDATE(date, INTERVAL expr unit), SUBDATE(expr, days)`

When invoked with the `INTERVAL` form of the second argument, `SUBDATE()` is a synonym for `DATE_SUB()`. For information on the `INTERVAL unit` argument, see the discussion for `DATE_ADD()`.

```
mysql> SELECT DATE_SUB('2008-01-02', INTERVAL 31 DAY);
-> '2007-12-02'
mysql> SELECT SUBDATE('2008-01-02', INTERVAL 31 DAY);
-> '2007-12-02'
```

The second form allows the use of an integer value for `days`. In such cases, it is interpreted as the number of days to be subtracted from the date or datetime expression `expr`.

```
mysql> SELECT SUBDATE('2008-01-02 12:00:00', 31);
-> '2007-12-02 12:00:00'
```

- `SUBTIME(expr1, expr2)`

`SUBTIME()` returns `expr1 - expr2` expressed as a value in the same format as `expr1`. `expr1` is a time or datetime expression, and `expr2` is a time expression.

```
mysql> SELECT SUBTIME('2007-12-31 23:59:59.999999', '1 1:1:1.000002');
-> '2007-12-30 22:58:58.999997'
mysql> SELECT SUBTIME('01:00:00.999999', '02:00:00.999998');
-> '-00:59:59.999999'
```

- `SYSDATE()`

Returns the current date and time as a value in 'YYYY-MM-DD HH:MM:SS' or YYYYMMDDHHMMSS.uuuuuu format, depending on whether the function is used in a string or numeric context.

`SYSDATE()` returns the time at which it executes. This differs from the behavior for `NOW()`, which returns a constant time that indicates the time at which the statement began to execute. (Within a stored function or trigger, `NOW()` returns the time at which the function or triggering statement began to execute.)

```
mysql> SELECT NOW(), SLEEP(2), NOW();
+-----+-----+-----+
| NOW()          | SLEEP(2) | NOW()          |
+-----+-----+-----+
| 2006-04-12 13:47:36 |          0 | 2006-04-12 13:47:36 |
+-----+-----+-----+

mysql> SELECT SYSDATE(), SLEEP(2), SYSDATE();
+-----+-----+-----+
| SYSDATE()      | SLEEP(2) | SYSDATE()      |
+-----+-----+-----+
| 2006-04-12 13:47:44 |          0 | 2006-04-12 13:47:46 |
+-----+-----+-----+
```

In addition, the `SET TIMESTAMP` statement affects the value returned by `NOW()` but not by `SYSDATE()`. This means that timestamp settings in the binary log have no effect on invocations of `SYSDATE()`.

Because `SYSDATE()` can return different values even within the same statement, and is not affected by `SET TIMESTAMP`, it is non-deterministic and therefore unsafe for replication if statement-based binary logging is used. If that is a problem, you can

use row-based logging, or start the server with the `--sysdate-is-now` option to cause `SYSDATE()` to be an alias for `NOW()`. The non-deterministic nature of `SYSDATE()` also means that indexes cannot be used for evaluating expressions that refer to it.

- `TIME(expr)`

Extracts the time part of the time or datetime expression `expr` and returns it as a string.

```
mysql> SELECT TIME('2003-12-31 01:02:03');
-> '01:02:03'
mysql> SELECT TIME('2003-12-31 01:02:03.000123');
-> '01:02:03.000123'
```

- `TIMEDIFF(expr1,expr2)`

`TIMEDIFF()` returns `expr1 - expr2` expressed as a time value. `expr1` and `expr2` are time or date-and-time expressions, but both must be of the same type.

```
mysql> SELECT TIMEDIFF('2000:01:01 00:00:00',
-> '2000:01:01 00:00:00.000001');
-> '-00:00:00.000001'
mysql> SELECT TIMEDIFF('2008-12-31 23:59:59.000001',
-> '2008-12-30 01:01:01.000002');
-> '46:58:57.999999'
```

- `TIMESTAMP(expr)`, `TIMESTAMP(expr1,expr2)`

With a single argument, this function returns the date or datetime expression `expr` as a datetime value. With two arguments, it adds the time expression `expr2` to the date or datetime expression `expr1` and returns the result as a datetime value.

```
mysql> SELECT TIMESTAMP('2003-12-31');
-> '2003-12-31 00:00:00'
mysql> SELECT TIMESTAMP('2003-12-31 12:00:00','12:00:00');
-> '2004-01-01 00:00:00'
```

- `TIMESTAMPADD(unit,interval,datetime_expr)`

Adds the integer expression `interval` to the date or datetime expression `datetime_expr`. The unit for `interval` is given by the `unit` argument, which should be one of the following values: `FRAC_SECOND` (microseconds), `SECOND`, `MINUTE`, `HOURL`, `DAY`, `WEEK`, `MONTH`, `QUARTER`, or `YEAR`.

Beginning with MySQL 5.1.24, it is possible to use `MICROSECOND` in place of `FRAC_SECOND` with this function, and `FRAC_SECOND` is deprecated.

The `unit` value may be specified using one of keywords as shown, or with a prefix of `SQL_TSI_`. For example, `DAY` and `SQL_TSI_DAY` both are legal.

```
mysql> SELECT TIMESTAMPADD(MINUTE,1,'2003-01-02');
-> '2003-01-02 00:01:00'
mysql> SELECT TIMESTAMPADD(WEEK,1,'2003-01-02');
-> '2003-01-09'
```

- `TIMESTAMPDIFF(unit,datetime_expr1,datetime_expr2)`

Returns `datetime_expr2 - datetime_expr1`, where `datetime_expr1` and `datetime_expr2` are date or datetime expressions. One expression may be a date and the other a datetime; a date value is treated as a datetime having the time part `'00:00:00'` where necessary. The unit for the result (an integer) is given by the `unit` argument. The legal values for `unit` are the same as those listed in the description of the `TIMESTAMPADD()` function.

```
mysql> SELECT TIMESTAMPDIFF(MONTH,'2003-02-01','2003-05-01');
-> 3
mysql> SELECT TIMESTAMPDIFF(YEAR,'2002-05-01','2001-01-01');
-> -1
mysql> SELECT TIMESTAMPDIFF(MINUTE,'2003-02-01','2003-05-01 12:05:55');
-> 128885
```

### Note

The order of the date or datetime arguments for this function is the opposite of that used with the `TIMESTAMP()` function when invoked with 2 arguments.

- `TIME_FORMAT(time,format)`

This is used like the `DATE_FORMAT()` function, but the `format` string may contain format specifiers only for hours, minutes,

seconds, and microseconds. Other specifiers produce a `NULL` value or `0`.

If the `time` value contains an hour part that is greater than `23`, the `%H` and `%k` hour format specifiers produce a value larger than the usual range of `0..23`. The other hour format specifiers produce the hour value modulo 12.

```
mysql> SELECT TIME_FORMAT('100:00:00', '%H %k %h %I %l');
-> '100 100 04 04 4'
```

- `TIME_TO_SEC(time)`

Returns the `time` argument, converted to seconds.

```
mysql> SELECT TIME_TO_SEC('22:23:00');
-> 80580
mysql> SELECT TIME_TO_SEC('00:39:38');
-> 2378
```

- `TO_DAYS(date)`

Given a date `date`, returns a day number (the number of days since year 0).

```
mysql> SELECT TO_DAYS(950501);
-> 728779
mysql> SELECT TO_DAYS('2007-10-07');
-> 733321
```

`TO_DAYS()` is not intended for use with values that precede the advent of the Gregorian calendar (1582), because it does not take into account the days that were lost when the calendar was changed. For dates before 1582 (and possibly a later year in other locales), results from this function are not reliable. See [Section 11.7, “What Calendar Is Used By MySQL?”](#), for details.

Remember that MySQL converts two-digit year values in dates to four-digit form using the rules in [Section 10.3, “Date and Time Types”](#). For example, `'2008-10-07'` and `'08-10-07'` are seen as identical dates:

```
mysql> SELECT TO_DAYS('2008-10-07'), TO_DAYS('08-10-07');
-> 733687, 733687
```

- `UNIX_TIMESTAMP()`, `UNIX_TIMESTAMP(date)`

If called with no argument, returns a Unix timestamp (seconds since `'1970-01-01 00:00:00'` UTC) as an unsigned integer. If `UNIX_TIMESTAMP()` is called with a `date` argument, it returns the value of the argument as seconds since `'1970-01-01 00:00:00'` UTC. `date` may be a `DATE` string, a `DATETIME` string, a `TIMESTAMP`, or a number in the format `YYMMDD` or `YYYYMMDD`. The server interprets `date` as a value in the current time zone and converts it to an internal value in UTC. Clients can set their time zone as described in [Section 9.7, “MySQL Server Time Zone Support”](#).

```
mysql> SELECT UNIX_TIMESTAMP();
-> 1196440210
mysql> SELECT UNIX_TIMESTAMP('2007-11-30 10:30:19');
-> 1196440219
```

When `UNIX_TIMESTAMP()` is used on a `TIMESTAMP` column, the function returns the internal timestamp value directly, with no implicit “string-to-Unix-timestamp” conversion. If you pass an out-of-range date to `UNIX_TIMESTAMP()`, it returns `0`.

Note: If you use `UNIX_TIMESTAMP()` and `FROM_UNIXTIME()` to convert between `TIMESTAMP` values and Unix timestamp values, the conversion is lossy because the mapping is not one-to-one in both directions. For example, due to conventions for local time zone changes, it is possible for two `UNIX_TIMESTAMP()` to map two `TIMESTAMP` values to the same Unix timestamp value. `FROM_UNIXTIME()` will map that value back to only one of the original `TIMESTAMP` values. Here is an example, using `TIMESTAMP` values in the `CET` time zone:

```
mysql> SELECT UNIX_TIMESTAMP('2005-03-27 03:00:00');
+-----+
| UNIX_TIMESTAMP('2005-03-27 03:00:00') |
+-----+
| 1111885200 |
+-----+
mysql> SELECT UNIX_TIMESTAMP('2005-03-27 02:00:00');
+-----+
| UNIX_TIMESTAMP('2005-03-27 02:00:00') |
+-----+
| 1111885200 |
+-----+
mysql> SELECT FROM_UNIXTIME(1111885200);
+-----+
| FROM_UNIXTIME(1111885200) |
+-----+
| 2005-03-27 03:00:00 |
+-----+
```

If you want to subtract `UNIX_TIMESTAMP()` columns, you might want to cast the result to signed integers. See [Section 11.9, “Cast Functions and Operators”](#).

- `UTC_DATE, UTC_DATE()`

Returns the current UTC date as a value in `'YYYY-MM-DD'` or `YYYYMMDD` format, depending on whether the function is used in a string or numeric context.

```
mysql> SELECT UTC_DATE(), UTC_DATE() + 0;
      -> '2003-08-14', 20030814
```

- `UTC_TIME, UTC_TIME()`

Returns the current UTC time as a value in `'HH:MM:SS'` or `HHMMSS.uuuuuu` format, depending on whether the function is used in a string or numeric context.

```
mysql> SELECT UTC_TIME(), UTC_TIME() + 0;
      -> '18:07:53', 180753.000000
```

- `UTC_TIMESTAMP, UTC_TIMESTAMP()`

Returns the current UTC date and time as a value in `'YYYY-MM-DD HH:MM:SS'` or `YYYYMMDDHHMMSS.uuuuuu` format, depending on whether the function is used in a string or numeric context.

```
mysql> SELECT UTC_TIMESTAMP(), UTC_TIMESTAMP() + 0;
      -> '2003-08-14 18:08:04', 20030814180804.000000
```

- `WEEK(date[, mode])`

This function returns the week number for *date*. The two-argument form of `WEEK()` allows you to specify whether the week starts on Sunday or Monday and whether the return value should be in the range from 0 to 53 or from 1 to 53. If the *mode* argument is omitted, the value of the `default_week_format` system variable is used. See [Section 5.1.3, “Server System Variables”](#).

The following table describes how the *mode* argument works.

Mode	First day of week	Range	Week 1 is the first week ...
0	Sunday	0-53	with a Sunday in this year
1	Monday	0-53	with more than 3 days this year
2	Sunday	1-53	with a Sunday in this year
3	Monday	1-53	with more than 3 days this year
4	Sunday	0-53	with more than 3 days this year
5	Monday	0-53	with a Monday in this year
6	Sunday	1-53	with more than 3 days this year
7	Monday	1-53	with a Monday in this year

```
mysql> SELECT WEEK('2008-02-20');
      -> 7
mysql> SELECT WEEK('2008-02-20',0);
      -> 7
mysql> SELECT WEEK('2008-02-20',1);
      -> 8
mysql> SELECT WEEK('2008-12-31',1);
      -> 53
```

Note that if a date falls in the last week of the previous year, MySQL returns 0 if you do not use 2, 3, 6, or 7 as the optional *mode* argument:

```
mysql> SELECT YEAR('2000-01-01'), WEEK('2000-01-01',0);
      -> 2000, 0
```

One might argue that MySQL should return 52 for the `WEEK()` function, because the given date actually occurs in the 52nd week of 1999. We decided to return 0 instead because we want the function to return “the week number in the given year.” This makes use of the `WEEK()` function reliable when combined with other functions that extract a date part from a date.

If you would prefer the result to be evaluated with respect to the year that contains the first day of the week for the given date, use 0, 2, 5, or 7 as the optional *mode* argument.

```
mysql> SELECT WEEK('2000-01-01',2);
-> 52
```

Alternatively, use the `YEARWEEK()` function:

```
mysql> SELECT YEARWEEK('2000-01-01');
-> 199952
mysql> SELECT MID(YEARWEEK('2000-01-01'),5,2);
-> '52'
```

- `WEEKDAY(date)`

Returns the weekday index for *date* (0 = Monday, 1 = Tuesday, ... 6 = Sunday).

```
mysql> SELECT WEEKDAY('2008-02-03 22:23:00');
-> 6
mysql> SELECT WEEKDAY('2007-11-06');
-> 1
```

- `WEEKOFYEAR(date)`

Returns the calendar week of the date as a number in the range from 1 to 53. `WEEKOFYEAR()` is a compatibility function that is equivalent to `WEEK(date,3)`.

```
mysql> SELECT WEEKOFYEAR('2008-02-20');
-> 8
```

- `YEAR(date)`

Returns the year for *date*, in the range 1000 to 9999, or 0 for the “zero” date.

```
mysql> SELECT YEAR('1987-01-01');
-> 1987
```

- `YEARWEEK(date)`, `YEARWEEK(date,mode)`

Returns year and week for a date. The *mode* argument works exactly like the *mode* argument to `WEEK()`. The year in the result may be different from the year in the date argument for the first and the last week of the year.

```
mysql> SELECT YEARWEEK('1987-01-01');
-> 198653
```

Note that the week number is different from what the `WEEK()` function would return (0) for optional arguments 0 or 1, as `WEEK()` then returns the week in the context of the given year.

## 11.7. What Calendar Is Used By MySQL?

MySQL uses what is known as a *proleptic Gregorian calendar*.

Every country that has switched from the Julian to the Gregorian calendar has had to discard at least ten days during the switch. To see how this works, consider the month of October 1582, when the first Julian-to-Gregorian switch occurred.

Monday	Tuesday	Wednesday	Thursday	Friday	Saturday	Sunday
1	2	3	4	15	16	17
18	19	20	21	22	23	24
25	26	27	28	29	30	31

There are no dates between October 4 and October 15. This discontinuity is called the *cutover*. Any dates before the cutover are Julian, and any dates following the cutover are Gregorian. Dates during a cutover are non-existent.

A calendar applied to dates when it wasn't actually in use is called *proleptic*. Thus, if we assume there was never a cutover and Gregorian rules always rule, we have a proleptic Gregorian calendar. This is what is used by MySQL, as is required by standard SQL. For this reason, dates prior to the cutover stored as MySQL `DATE` or `DATETIME` values must be adjusted to compensate for



the difference. It is important to realize that the cutover did not occur at the same time in all countries, and that the later it happened, the more days were lost. For example, in Great Britain, it took place in 1752, when Wednesday September 2 was followed by Thursday September 14. Russia remained on the Julian calendar until 1918, losing 13 days in the process, and what is popularly referred to as its “October Revolution” occurred in November according to the Gregorian calendar.

## 11.8. Full-Text Search Functions

```
MATCH (col1,col2,...) AGAINST (expr [search_modifier])
```

```
search_modifier:
{
  IN BOOLEAN MODE
  IN NATURAL LANGUAGE MODE
  IN NATURAL LANGUAGE MODE WITH QUERY EXPANSION
  WITH QUERY EXPANSION
}
```

MySQL has support for full-text indexing and searching:

- A full-text index in MySQL is an index of type `FULLTEXT`.
- Full-text indexes can be used only with `MyISAM` tables, and can be created only for `CHAR`, `VARCHAR`, or `TEXT` columns.
- A `FULLTEXT` index definition can be given in the `CREATE TABLE` statement when a table is created, or added later using `ALTER TABLE` or `CREATE INDEX`.
- For large data sets, it is much faster to load your data into a table that has no `FULLTEXT` index and then create the index after that, than to load data into a table that has an existing `FULLTEXT` index.

Full-text searching is performed using `MATCH() ... AGAINST` syntax. `MATCH()` takes a comma-separated list that names the columns to be searched. `AGAINST` takes a string to search for, and an optional modifier that indicates what type of search to perform. The search string must be a literal string, not a variable or a column name. There are three types of full-text searches:

- A boolean search interprets the search string using the rules of a special query language. The string contains the words to search for. It can also contain operators that specify requirements such that a word must be present or absent in matching rows, or that it should be weighted higher or lower than usual. Common words such as “some” or “then” are stopwords and do not match if present in the search string. The `IN BOOLEAN MODE` modifier specifies a boolean search. For more information, see [Section 11.8.2, “Boolean Full-Text Searches”](#).
- A natural language search interprets the search string as a phrase in natural human language (a phrase in free text). There are no special operators. The stopword list applies. In addition, words that are present in 50% or more of the rows are considered common and do not match. Full-text searches are natural language searches if the `IN NATURAL LANGUAGE MODE` modifier is given or if no modifier is given.
- A query expansion search is a modification of a natural language search. The search string is used to perform a natural language search. Then words from the most relevant rows returned by the search are added to the search string and the search is done again. The query returns the rows from the second search. The `IN NATURAL LANGUAGE MODE WITH QUERY EXPANSION` or `WITH QUERY EXPANSION` modifier specifies a query expansion search. For more information, see [Section 11.8.3, “Full-Text Searches with Query Expansion”](#).

The `IN NATURAL LANGUAGE MODE` and `IN NATURAL LANGUAGE MODE WITH QUERY EXPANSION` modifiers were added in MySQL 5.1.7.

Constraints on full-text searching are listed in [Section 11.8.5, “Full-Text Restrictions”](#).

### 11.8.1. Natural Language Full-Text Searches

By default or with the `IN NATURAL LANGUAGE MODE` modifier, the `MATCH()` function performs a natural language search for a string against a *text collection*. A collection is a set of one or more columns included in a `FULLTEXT` index. The search string is given as the argument to `AGAINST()`. For each row in the table, `MATCH()` returns a relevance value; that is, a similarity measure between the search string and the text in that row in the columns named in the `MATCH()` list.

```
mysql> CREATE TABLE articles (
->   id INT UNSIGNED AUTO_INCREMENT NOT NULL PRIMARY KEY,
->   title VARCHAR(200),
->   body TEXT,
->   FULLTEXT (title,body)
-> );
Query OK, 0 rows affected (0.00 sec)
```

```
mysql> INSERT INTO articles (title,body) VALUES
-> ('MySQL Tutorial','DBMS stands for DataBase ...'),
-> ('How To Use MySQL Well','After you went through a ...'),
-> ('Optimizing MySQL','In this tutorial we will show ...'),
-> ('1001 MySQL Tricks','1. Never run mysqld as root. 2. ...'),
-> ('MySQL vs. YourSQL','In the following database comparison ...'),
-> ('MySQL Security','When configured properly, MySQL ...');
Query OK, 6 rows affected (0.00 sec)
Records: 6 Duplicates: 0 Warnings: 0

mysql> SELECT * FROM articles
-> WHERE MATCH (title,body)
-> AGAINST ('database' IN NATURAL LANGUAGE MODE);
+-----+-----+-----+
| id | title | body |
+-----+-----+-----+
| 5 | MySQL vs. YourSQL | In the following database comparison ... |
| 1 | MySQL Tutorial | DBMS stands for DataBase ... |
+-----+-----+-----+
2 rows in set (0.00 sec)
```

By default, the search is performed in case-insensitive fashion. However, you can perform a case-sensitive full-text search by using a binary collation for the indexed columns. For example, a column that uses the `latin1` character set of can be assigned a collation of `latin1_bin` to make it case sensitive for full-text searches.

When `MATCH()` is used in a `WHERE` clause, as in the example shown earlier, the rows returned are automatically sorted with the highest relevance first. Relevance values are non-negative floating-point numbers. Zero relevance means no similarity. Relevance is computed based on the number of words in the row, the number of unique words in that row, the total number of words in the collection, and the number of documents (rows) that contain a particular word.

To simply count matches, you could use a query like this:

```
mysql> SELECT COUNT(*) FROM articles
-> WHERE MATCH (title,body)
-> AGAINST ('database' IN NATURAL LANGUAGE MODE);
+-----+
| COUNT(*) |
+-----+
| 2 |
+-----+
1 row in set (0.00 sec)
```

However, you might find it quicker to rewrite the query as follows:

```
mysql> SELECT
-> COUNT(IF(MATCH (title,body) AGAINST ('database' IN NATURAL LANGUAGE MODE), 1, NULL))
-> AS count
-> FROM articles;
+-----+
| count |
+-----+
| 2 |
+-----+
1 row in set (0.03 sec)
```

The first query sorts the results by relevance whereas the second does not. However, the second query performs a full table scan and the first does not. The first may be faster if the search matches few rows; otherwise, the second may be faster because it would read many rows anyway.

For natural-language full-text searches, it is a requirement that the columns named in the `MATCH()` function be the same columns included in some `FULLTEXT` index in your table. For the preceding query, note that the columns named in the `MATCH()` function (`title` and `body`) are the same as those named in the definition of the `article` table's `FULLTEXT` index. If you wanted to search the `title` or `body` separately, you would need to create separate `FULLTEXT` indexes for each column.

It is also possible to perform a boolean search or a search with query expansion. These search types are described in [Section 11.8.2, “Boolean Full-Text Searches”](#), and [Section 11.8.3, “Full-Text Searches with Query Expansion”](#).

A full-text search that uses an index can name columns only from a single table in the `MATCH()` clause because an index cannot span multiple tables. A boolean search can be done in the absence of an index (albeit more slowly), in which case it is possible to name columns from multiple tables.

The preceding example is a basic illustration that shows how to use the `MATCH()` function where rows are returned in order of decreasing relevance. The next example shows how to retrieve the relevance values explicitly. Returned rows are not ordered because the `SELECT` statement includes neither `WHERE` nor `ORDER BY` clauses:

```
mysql> SELECT id, MATCH (title,body)
-> AGAINST ('Tutorial' IN NATURAL LANGUAGE MODE) AS score
-> FROM articles;
+-----+-----+
| id | score |
+-----+-----+
| 1 | 0.65545833110809 |
+-----+-----+
```

```

2 | 0 |
3 | 0.66266459226608 |
4 | 0 |
5 | 0 |
6 | 0 |
+-----+
6 rows in set (0.00 sec)

```

The following example is more complex. The query returns the relevance values and it also sorts the rows in order of decreasing relevance. To achieve this result, you should specify `MATCH()` twice: once in the `SELECT` list and once in the `WHERE` clause. This causes no additional overhead, because the MySQL optimizer notices that the two `MATCH()` calls are identical and invokes the full-text search code only once.

```

mysql> SELECT id, body, MATCH (title,body) AGAINST
-> ('Security implications of running MySQL as root'
-> IN NATURAL LANGUAGE MODE) AS score
-> FROM articles WHERE MATCH (title,body) AGAINST
-> ('Security implications of running MySQL as root'
-> IN NATURAL LANGUAGE MODE);
+-----+-----+-----+
| id | body | score |
+-----+-----+-----+
| 4 | 1. Never run mysqld as root. 2. ... | 1.5219271183014 |
| 6 | When configured properly, MySQL ... | 1.3114095926285 |
+-----+-----+-----+
2 rows in set (0.00 sec)

```

The MySQL `FULLTEXT` implementation regards any sequence of true word characters (letters, digits, and underscores) as a word. That sequence may also contain apostrophes (“'”), but not more than one in a row. This means that `aaa'bbb` is regarded as one word, but `aaa' 'bbb` is regarded as two words. Apostrophes at the beginning or the end of a word are stripped by the `FULLTEXT` parser; `'aaa'bbb'` would be parsed as `aaa'bbb`.

The `FULLTEXT` parser determines where words start and end by looking for certain delimiter characters; for example, “ ” (space), “,” (comma), and “.” (period). If words are not separated by delimiters (as in, for example, Chinese), the `FULLTEXT` parser cannot determine where a word begins or ends. To be able to add words or other indexed terms in such languages to a `FULLTEXT` index, you must preprocess them so that they are separated by some arbitrary delimiter such as “#”.

In MySQL 5.1, it is possible to write a plugin that replaces the built-in full-text parser. For details, see [Section 21.2, “The MySQL Plugin Interface”](#). For example parser plugin source code, see the `plugin/fulltext` directory of a MySQL source distribution.

Some words are ignored in full-text searches:

- Any word that is too short is ignored. The default minimum length of words that are found by full-text searches is four characters.
- Words in the stopword list are ignored. A stopword is a word such as “the” or “some” that is so common that it is considered to have zero semantic value. There is a built-in stopword list, but it can be overwritten by a user-defined list.

The default stopword list is given in [Section 11.8.4, “Full-Text Stopwords”](#). The default minimum word length and stopword list can be changed as described in [Section 11.8.6, “Fine-Tuning MySQL Full-Text Search”](#).

Every correct word in the collection and in the query is weighted according to its significance in the collection or query. Consequently, a word that is present in many documents has a lower weight (and may even have a zero weight), because it has lower semantic value in this particular collection. Conversely, if the word is rare, it receives a higher weight. The weights of the words are combined to compute the relevance of the row.

Such a technique works best with large collections (in fact, it was carefully tuned this way). For very small tables, word distribution does not adequately reflect their semantic value, and this model may sometimes produce bizarre results. For example, although the word “MySQL” is present in every row of the `articles` table shown earlier, a search for the word produces no results:

```

mysql> SELECT * FROM articles
-> WHERE MATCH (title,body)
-> AGAINST ('MySQL' IN NATURAL LANGUAGE MODE);
Empty set (0.00 sec)

```

The search result is empty because the word “MySQL” is present in at least 50% of the rows. As such, it is effectively treated as a stopword. For large data sets, this is the most desirable behavior: A natural language query should not return every second row from a 1GB table. For small data sets, it may be less desirable.

A word that matches half of the rows in a table is less likely to locate relevant documents. In fact, it most likely finds plenty of irrelevant documents. We all know this happens far too often when we are trying to find something on the Internet with a search engine. It is with this reasoning that rows containing the word are assigned a low semantic value for *the particular data set in which they occur*. A given word may reach the 50% threshold in one data set but not another.

The 50% threshold has a significant implication when you first try full-text searching to see how it works: If you create a table and insert only one or two rows of text into it, every word in the text occurs in at least 50% of the rows. As a result, no search returns any results. Be sure to insert at least three rows, and preferably many more. Users who need to bypass the 50% limitation can use the boolean search mode; see [Section 11.8.2, “Boolean Full-Text Searches”](#).

## 11.8.2. Boolean Full-Text Searches

MySQL can perform boolean full-text searches using the `IN BOOLEAN MODE` modifier:

```
mysql> SELECT * FROM articles WHERE MATCH (title,body)
-> AGAINST ('+MySQL -YourSQL' IN BOOLEAN MODE);
```

id	title	body
1	MySQL Tutorial	DBMS stands for DataBase ...
2	How To Use MySQL Well	After you went through a ...
3	Optimizing MySQL	In this tutorial we will show ...
4	1001 MySQL Tricks	1. Never run mysqld as root. 2. ...
6	MySQL Security	When configured properly, MySQL ...

The `+` and `-` operators indicate that a word is required to be present or absent, respectively, for a match to occur. Thus, this query retrieves all the rows that contain the word “MySQL” but that do *not* contain the word “YourSQL”.

### Note

In implementing this feature, MySQL uses what is sometimes referred to as *implied Boolean logic*, in which

- `+` stands for `AND`
- `-` stands for `NOT`
- `[no operator]` implies `OR`

Boolean full-text searches have these characteristics:

- They do not use the 50% threshold.
- They do not automatically sort rows in order of decreasing relevance. You can see this from the preceding query result: The row with the highest relevance is the one that contains “MySQL” twice, but it is listed last, not first.
- They can work even without a `FULLTEXT` index, although a search executed in this fashion would be quite slow.
- The minimum and maximum word length full-text parameters apply.
- The stopword list applies.

The boolean full-text search capability supports the following operators:

- `+`

A leading plus sign indicates that this word *must* be present in each row that is returned.

- `-`

A leading minus sign indicates that this word must *not* be present in any of the rows that are returned.

Note: The `-` operator acts only to exclude rows that are otherwise matched by other search terms. Thus, a boolean-mode search that contains only terms preceded by `-` returns an empty result. It does not return “all rows except those containing any of the excluded terms.”

- (no operator)

By default (when neither `+` nor `-` is specified) the word is optional, but the rows that contain it are rated higher. This mimics the behavior of `MATCH() ... AGAINST()` without the `IN BOOLEAN MODE` modifier.

- `>` `<`

These two operators are used to change a word's contribution to the relevance value that is assigned to a row. The `>` operator increases the contribution and the `<` operator decreases it. See the example following this list.

- `( )`

Parentheses group words into subexpressions. Parenthesized groups can be nested.

- `~`

A leading tilde acts as a negation operator, causing the word's contribution to the row's relevance to be negative. This is useful for marking “noise” words. A row containing such a word is rated lower than others, but is not excluded altogether, as it would be with the `-` operator.

- `*`

The asterisk serves as the truncation (or wildcard) operator. Unlike the other operators, it should be *appended* to the word to be affected. Words match if they begin with the word preceding the `*` operator.

If a stopword or too-short word is specified with the truncation operator, it will not be stripped from a boolean query. For example, a search for `'+word +stopword*'` will likely return fewer rows than a search for `'+word +stopword'` because the former query remains as is and requires `stopword*` to be present in a document. The latter query is transformed to `+word`.

- `" "`

A phrase that is enclosed within double quote (“ ”) characters matches only rows that contain the phrase *literally, as it was typed*. The full-text engine splits the phrase into words, performs a search in the `FULLTEXT` index for the words. Non-word characters need not be matched exactly: Phrase searching requires only that matches contain exactly the same words as the phrase and in the same order. For example, `"test phrase"` matches `"test, phrase"`.

If the phrase contains no words that are in the index, the result is empty. For example, if all words are either stopwords or shorter than the minimum length of indexed words, the result is empty.

The following examples demonstrate some search strings that use boolean full-text operators:

- `'apple banana'`

Find rows that contain at least one of the two words.

- `'+apple +juice'`

Find rows that contain both words.

- `'+apple macintosh'`

Find rows that contain the word “apple”, but rank rows higher if they also contain “macintosh”.

- `'+apple -macintosh'`

Find rows that contain the word “apple” but not “macintosh”.

- `'+apple ~macintosh'`

Find rows that contain the word “apple”, but if the row also contains the word “macintosh”, rate it lower than if row does not. This is “softer” than a search for `'+apple -macintosh'`, for which the presence of “macintosh” causes the row not to be returned at all.

- `'+apple +(>turnover <strudel)'`

Find rows that contain the words “apple” and “turnover”, or “apple” and “strudel” (in any order), but rank “apple turnover” higher than “apple strudel”.

- `'apple*'`

Find rows that contain words such as “apple”, “apples”, “applesauce”, or “applet”.

- `'"some words"'`

Find rows that contain the exact phrase “some words” (for example, rows that contain “some words of wisdom” but not “some

noise words”). Note that the “” characters that enclose the phrase are operator characters that delimit the phrase. They are not the quotes that enclose the search string itself.

### 11.8.3. Full-Text Searches with Query Expansion

Full-text search supports query expansion (and in particular, its variant “blind query expansion”). This is generally useful when a search phrase is too short, which often means that the user is relying on implied knowledge that the full-text search engine lacks. For example, a user searching for “database” may really mean that “MySQL”, “Oracle”, “DB2”, and “RDBMS” all are phrases that should match “databases” and should be returned, too. This is implied knowledge.

Blind query expansion (also known as automatic relevance feedback) is enabled by adding `WITH QUERY EXPANSION` or `IN NATURAL LANGUAGE MODE WITH QUERY EXPANSION` following the search phrase. It works by performing the search twice, where the search phrase for the second search is the original search phrase concatenated with the few most highly relevant documents from the first search. Thus, if one of these documents contains the word “databases” and the word “MySQL”, the second search finds the documents that contain the word “MySQL” even if they do not contain the word “database”. The following example shows this difference:

```
mysql> SELECT * FROM articles
-> WHERE MATCH (title,body)
-> AGAINST ('database' IN NATURAL LANGUAGE MODE);
+-----+-----+-----+
| id | title | body |
+-----+-----+-----+
| 5 | MySQL vs. YourSQL | In the following database comparison ... |
| 1 | MySQL Tutorial | DBMS stands for DataBase ... |
+-----+-----+-----+
2 rows in set (0.00 sec)

mysql> SELECT * FROM articles
-> WHERE MATCH (title,body)
-> AGAINST ('database' WITH QUERY EXPANSION);
+-----+-----+-----+
| id | title | body |
+-----+-----+-----+
| 1 | MySQL Tutorial | DBMS stands for DataBase ... |
| 5 | MySQL vs. YourSQL | In the following database comparison ... |
| 3 | Optimizing MySQL | In this tutorial we will show ... |
+-----+-----+-----+
3 rows in set (0.00 sec)
```

Another example could be searching for books by Georges Simenon about Maigret, when a user is not sure how to spell “Maigret”. A search for “Megre and the reluctant witnesses” finds only “Maigret and the Reluctant Witnesses” without query expansion. A search with query expansion finds all books with the word “Maigret” on the second pass.

**Note**  
Because blind query expansion tends to increase noise significantly by returning non-relevant documents, it is meaningful to use only when a search phrase is rather short.

### 11.8.4. Full-Text Stopwords

The following table shows the default list of full-text stopwords.

a's	able	about	above	according
accordingly	across	actually	after	afterwards
again	against	ain't	all	allow
allows	almost	alone	along	already
also	although	always	am	among
amongst	an	and	another	any
anybody	anyhow	anyone	anything	anyway
anyways	anywhere	apart	appear	appreciate
appropriate	are	aren't	around	as
aside	ask	asking	associated	at
available	away	awfully	be	became
because	become	becomes	becoming	been
before	beforehand	behind	being	believe
below	beside	besides	best	better

Functions and Operators

between	beyond	both	brief	but
by	c'mon	c's	came	can
can't	cannot	cant	cause	causes
certain	certainly	changes	clearly	co
com	come	comes	concerning	consequently
consider	considering	contain	containing	contains
corresponding	could	couldn't	course	currently
definitely	described	despite	did	didn't
different	do	does	doesn't	doing
don't	done	down	downwards	during
each	edu	eg	eight	either
else	elsewhere	enough	entirely	especially
et	etc	even	ever	every
everybody	everyone	everything	everywhere	ex
exactly	example	except	far	few
fifth	first	five	followed	following
follows	for	former	formerly	forth
four	from	further	furthermore	get
gets	getting	given	gives	go
goes	going	gone	got	gotten
greetings	had	hadn't	happens	hardly
has	hasn't	have	haven't	having
he	he's	hello	help	hence
her	here	here's	hereafter	hereby
herein	hereupon	hers	herself	hi
him	himself	his	hither	hopefully
how	howbeit	however	i'd	i'll
i'm	i've	ie	if	ignored
immediate	in	inasmuch	inc	indeed
indicate	indicated	indicates	inner	insofar
instead	into	inward	is	isn't
it	it'd	it'll	it's	its
itself	just	keep	keeps	kept
know	knows	known	last	lately
later	latter	latterly	least	less
lest	let	let's	like	liked
likely	little	look	looking	looks
ltd	mainly	many	may	maybe
me	mean	meanwhile	merely	might
more	moreover	most	mostly	much
must	my	myself	name	namely
nd	near	nearly	necessary	need
needs	neither	never	nevertheless	new
next	nine	no	nobody	non
none	noone	nor	normally	not
nothing	novel	now	nowhere	obviously
of	off	often	oh	ok
okay	old	on	once	one

Functions and Operators

ones	only	onto	or	other
others	otherwise	ought	our	ours
ourselves	out	outside	over	overall
own	particular	particularly	per	perhaps
placed	please	plus	possible	presumably
probably	provides	que	quite	qv
rather	rd	re	really	reasonably
regarding	regardless	regards	relatively	respectively
right	said	same	saw	say
saying	says	second	secondly	see
seeing	seem	seemed	seeming	seems
seen	self	selves	sensible	sent
serious	seriously	seven	several	shall
she	should	shouldn't	since	six
so	some	somebody	somehow	someone
something	sometime	sometimes	somewhat	somewhere
soon	sorry	specified	specify	specifying
still	sub	such	sup	sure
t's	take	taken	tell	tends
th	than	thank	thanks	thanx
that	that's	thats	the	their
theirs	them	themselves	then	thence
there	there's	thereafter	thereby	therefore
therein	theres	thereupon	these	they
they'd	they'll	they're	they've	think
third	this	thorough	thoroughly	those
though	three	through	throughout	thru
thus	to	together	too	took
toward	towards	tried	tries	truly
try	trying	twice	two	un
under	unfortunately	unless	unlikely	until
unto	up	upon	us	use
used	useful	uses	using	usually
value	various	very	via	viz
vs	want	wants	was	wasn't
way	we	we'd	we'll	we're
we've	welcome	well	went	were
weren't	what	what's	whatever	when
whence	whenever	where	where's	whereafter
whereas	whereby	wherein	whereupon	wherever
whether	which	while	whither	who
who's	whoever	whole	whom	whose
why	will	willing	wish	with
within	without	won't	wonder	would
would	wouldn't	yes	yet	you
you'd	you'll	you're	you've	your
yours	yourself	yourselves	zero	



## 11.8.5. Full-Text Restrictions

- Full-text searches are supported for `MyISAM` tables only.
- Full-text searches can be used with most multi-byte character sets. The exception is that for Unicode, the `utf8` character set can be used, but not the `ucs2` character set. However, although `FULLTEXT` indexes on `ucs2` columns cannot be used, you can perform `IN BOOLEAN MODE` searches on a `ucs2` column that has no such index.
- Ideographic languages such as Chinese and Japanese do not have word delimiters. Therefore, the `FULLTEXT` parser *cannot determine where words begin and end in these and other such languages*. The implications of this and some workarounds for the problem are described in [Section 11.8, “Full-Text Search Functions”](#).
- Although the use of multiple character sets within a single table is supported, all columns in a `FULLTEXT` index must use the same character set and collation.
- The `MATCH()` column list must match exactly the column list in some `FULLTEXT` index definition for the table, unless this `MATCH()` is `IN BOOLEAN MODE`. Boolean-mode searches can be done on non-indexed columns, although they are likely to be slow.
- The argument to `AGAINST()` must be a constant string.
- Index hints are more limited for `FULLTEXT` searches than for non-`FULLTEXT` searches. See [Section 12.2.8.2, “Index Hint Syntax”](#).

## 11.8.6. Fine-Tuning MySQL Full-Text Search

MySQL's full-text search capability has few user-tunable parameters. You can exert more control over full-text searching behavior if you have a MySQL source distribution because some changes require source code modifications. See [Section 2.10, “MySQL Installation Using a Source Distribution”](#).

Note that full-text search is carefully tuned for the most effectiveness. Modifying the default behavior in most cases can actually decrease effectiveness. *Do not alter the MySQL sources unless you know what you are doing.*

Most full-text variables described in this section must be set at server startup time. A server restart is required to change them; they cannot be modified while the server is running.

Some variable changes require that you rebuild the `FULLTEXT` indexes in your tables. Instructions for doing this are given at the end of this section.

- The minimum and maximum lengths of words to be indexed are defined by the `ft_min_word_len` and `ft_max_word_len` system variables. (See [Section 5.1.3, “Server System Variables”](#).) The default minimum value is four characters; the default maximum is version dependent. If you change either value, you must rebuild your `FULLTEXT` indexes. For example, if you want three-character words to be searchable, you can set the `ft_min_word_len` variable by putting the following lines in an option file:

```
[mysqld]
ft_min_word_len=3
```

Then you must restart the server and rebuild your `FULLTEXT` indexes. Note particularly the remarks regarding `myisamchk` in the instructions following this list.

- To override the default stopword list, set the `ft_stopword_file` system variable. (See [Section 5.1.3, “Server System Variables”](#).) The variable value should be the path name of the file containing the stopword list, or the empty string to disable stopword filtering. After changing the value of this variable or the contents of the stopword file, restart the server and rebuild your `FULLTEXT` indexes.

The stopword list is free-form. That is, you may use any non-alphanumeric character such as newline, space, or comma to separate stopwords. Exceptions are the underscore character (“`_`”) and a single apostrophe (“`'`”) which are treated as part of a word. The character set of the stopword list is the server's default character set; see [Section 9.1.3.1, “Server Character Set and Collation”](#).

- The 50% threshold for natural language searches is determined by the particular weighting scheme chosen. To disable it, look for the following line in `storage/myisam/ftdefs.h`:

```
#define GWS_IN_USE GWS_PROB
```

Change that line to this:

```
#define GWS_IN_USE GWS_FREQ
```

Then recompile MySQL. There is no need to rebuild the indexes in this case.

**Note**

By making this change, you *severely* decrease MySQL's ability to provide adequate relevance values for the `MATCH()` function. If you really need to search for such common words, it would be better to search using `IN BOOLEAN MODE` instead, which does not observe the 50% threshold.

- To change the operators used for boolean full-text searches, set the `ft_boolean_syntax` system variable. This variable can be changed while the server is running, but you must have the `SUPER` privilege to do so. No rebuilding of indexes is necessary in this case. See [Section 5.1.3, “Server System Variables”](#), which describes the rules governing how to set this variable.
- If you want to change the set of characters that are considered word characters, you can do so in two ways. Suppose that you want to treat the hyphen character ('-') as a word character. Use either of these methods:
  - Modify the MySQL source: In `storage/myisam/ftdefs.h`, see the `true_word_char()` and `misc_word_char()` macros. Add '-' to one of those macros and recompile MySQL.
  - Modify a character set file: This requires no recompilation. The `true_word_char()` macro uses a “character type” table to distinguish letters and numbers from other characters. You can edit the `<ctype><map>` contents in one of the character set XML files to specify that '-' is a “letter.” Then use the given character set for your `FULLTEXT` indexes.

After making the modification, you must rebuild the indexes for each table that contains any `FULLTEXT` indexes.

If you modify full-text variables that affect indexing (`ft_min_word_len`, `ft_max_word_len`, or `ft_stopword_file`), or if you change the stopwords file itself, you must rebuild your `FULLTEXT` indexes after making the changes and restarting the server. To rebuild the indexes in this case, it is sufficient to do a `QUICK` repair operation:

```
mysql> REPAIR TABLE tbl_name QUICK;
```

Each table that contains any `FULLTEXT` index must be repaired as just shown. Otherwise, queries for the table may yield incorrect results, and modifications to the table will cause the server to see the table as corrupt and in need of repair.

Note that if you use `myisamchk` to perform an operation that modifies table indexes (such as repair or analyze), the `FULLTEXT` indexes are rebuilt using the *default* full-text parameter values for minimum word length, maximum word length, and stopwords file unless you specify otherwise. This can result in queries failing.

The problem occurs because these parameters are known only by the server. They are not stored in `MyISAM` index files. To avoid the problem if you have modified the minimum or maximum word length or stopwords file values used by the server, specify the same `ft_min_word_len`, `ft_max_word_len`, and `ft_stopword_file` values to `myisamchk` that you use for `mysqld`. For example, if you have set the minimum word length to 3, you can repair a table with `myisamchk` like this:

```
shell> myisamchk --recover --ft_min_word_len=3 tbl_name.MYI
```

To ensure that `myisamchk` and the server use the same values for full-text parameters, place each one in both the `[mysqld]` and `[myisamchk]` sections of an option file:

```
[mysqld]
ft_min_word_len=3

[myisamchk]
ft_min_word_len=3
```

An alternative to using `myisamchk` is to use the `REPAIR TABLE`, `ANALYZE TABLE`, `OPTIMIZE TABLE`, or `ALTER TABLE` statements. These statements are performed by the server, which knows the proper full-text parameter values to use.

## 11.9. Cast Functions and Operators

Name	Description
<code>BINARY</code>	Cast a string to a binary string
<code>CAST()</code>	Cast a value as a certain type
<code>Convert()</code>	Cast a value as a certain type

- **BINARY**

The **BINARY** operator casts the string following it to a binary string. This is an easy way to force a column comparison to be done byte by byte rather than character by character. This causes the comparison to be case sensitive even if the column isn't defined as **BINARY** or **BLOB**. **BINARY** also causes trailing spaces to be significant.

```
mysql> SELECT 'a' = 'A';
-> 1
mysql> SELECT BINARY 'a' = 'A';
-> 0
mysql> SELECT 'a' = 'a ';
-> 1
mysql> SELECT BINARY 'a' = 'a ';
-> 0
```

In a comparison, **BINARY** affects the entire operation; it can be given before either operand with the same result.

**BINARY str** is shorthand for **CAST(str AS BINARY)**.

Note that in some contexts, if you cast an indexed column to **BINARY**, MySQL is not able to use the index efficiently.

- **CAST(expr AS type)**

The **CAST()** function takes a value of one type and produce a value of another type, similar to **CONVERT()**. See the description of **CONVERT()** for more information.

- **CONVERT(expr, type), CONVERT(expr USING transcoding\_name)**

The **CONVERT()** and **CAST()** functions take a value of one type and produce a value of another type.

The *type* can be one of the following values:

- **BINARY[ (N) ]**
- **CHAR[ (N) ]**
- **DATE**
- **DATETIME**
- **DECIMAL[ (M[ ,D] ) ]**
- **SIGNED [ INTEGER ]**
- **TIME**
- **UNSIGNED [ INTEGER ]**

**BINARY** produces a string with the **BINARY** data type. See [Section 10.4.2, “The BINARY and VARBINARY Types”](#) for a description of how this affects comparisons. If the optional length *N* is given, **BINARY(N)** causes the cast to use no more than *N* bytes of the argument. Values shorter than *N* bytes are padded with **0x00** bytes to a length of *N*.

**CHAR(N)** causes the cast to use no more than *N* characters of the argument.

**CAST()** and **CONVERT(... USING ...)** are standard SQL syntax. The non-**USING** form of **CONVERT()** is ODBC syntax.

**CONVERT()** with **USING** is used to convert data between different character sets. In MySQL, transcoding names are the same as the corresponding character set names. For example, this statement converts the string 'abc' in the default character set to the corresponding string in the **utf8** character set:

```
SELECT CONVERT('abc' USING utf8);
```

Normally, you cannot compare a **BLOB** value or other binary string in case-insensitive fashion because binary strings have no character set, and thus no concept of lettercase. To perform a case-insensitive comparison, use the **CONVERT()** function to convert the value to a nonbinary string. If the character set of the result has a case-insensitive collation, the **LIKE** operation is not case sensitive:

```
SELECT 'A' LIKE CONVERT(blob_col USING latin1) FROM tbl_name;
```

To use a different character set, substitute its name for **latin1** in the preceding statement. To ensure that a case-insensitive colla-

tion is used, specify a `COLLATE` clause following the `CONVERT()` call.

`CONVERT()` can be used more generally for comparing strings that are represented in different character sets.

The cast functions are useful when you want to create a column with a specific type in a `CREATE ... SELECT` statement:

```
CREATE TABLE new_table SELECT CAST('2000-01-01' AS DATE);
```

The functions also can be useful for sorting `ENUM` columns in lexical order. Normally, sorting of `ENUM` columns occurs using the internal numeric values. Casting the values to `CHAR` results in a lexical sort:

```
SELECT enum_col FROM tbl_name ORDER BY CAST(enum_col AS CHAR);
```

`CAST(str AS BINARY)` is the same thing as `BINARY str`. `CAST(expr AS CHAR)` treats the expression as a string with the default character set.

`CAST()` also changes the result if you use it as part of a more complex expression such as `CONCAT('Date: ', CAST(NOW() AS DATE))`.

You should not use `CAST()` to extract data in different formats but instead use string functions like `LEFT()` or `EXTRACT()`. See Section 11.6, “Date and Time Functions”.

To cast a string to a numeric value in numeric context, you normally do not have to do anything other than to use the string value as though it were a number:

```
mysql> SELECT 1+'1';
-> 2
```

If you use a number in string context, the number automatically is converted to a `BINARY` string.

```
mysql> SELECT CONCAT('hello you ',2);
-> 'hello you 2'
```

MySQL supports arithmetic with both signed and unsigned 64-bit values. If you are using numeric operators (such as `+` or `-`) and one of the operands is an unsigned integer, the result is unsigned. You can override this by using the `SIGNED` and `UNSIGNED` cast operators to cast the operation to a signed or unsigned 64-bit integer, respectively.

```
mysql> SELECT CAST(1-2 AS UNSIGNED)
-> 18446744073709551615
mysql> SELECT CAST(CAST(1-2 AS UNSIGNED) AS SIGNED);
-> -1
```

Note that if either operand is a floating-point value, the result is a floating-point value and is not affected by the preceding rule. (In this context, `DECIMAL` column values are regarded as floating-point values.)

```
mysql> SELECT CAST(1 AS UNSIGNED) - 2.0;
-> -1.0
```

If you are using a string in an arithmetic operation, this is converted to a floating-point number.

If you convert a “zero” date string to a date, `CONVERT()` and `CAST()` return `NULL` and produce a warning when the `NO_ZERO_DATE` SQL mode is enabled.

## 11.10. XML Functions

Name	Description
<code>ExtractValue()</code> (v5.1.5)	Extracts a value from an XML string using XPath notation
<code>UpdateXML()</code> (v5.1.5)	Return replaced XML fragment

This section discusses XML and related functionality in MySQL.

### Note

It is possible to obtain XML-formatted output from MySQL in the `mysql` and `mysqldump` clients by invoking them with the `--xml` option. See Section 4.5.1, “`mysql` — The MySQL Command-Line Tool”, and Section 4.5.4, “`mysqldump` — A Database Backup Program”.

Beginning with MySQL 5.1.5, two functions providing basic XPath 1.0 (XML Path Language, version 1.0) capabilities are avail-

able. Some basic information about XPath syntax and usage is provided later in this section; however, an in-depth discussion of these topics is beyond the scope of this Manual, and you should refer to the [XML Path Language \(XPath\) 1.0 standard](#) for definitive information. A useful resource for those new to XPath or who desire a refresher in the basics is the [Zvon.org XPath Tutorial](#), which is available in several languages.

### Note

These functions remain under development. We continue to improve these and other aspects of XML and XPath functionality in MySQL 5.1 and onwards. You may discuss these, ask questions about them, and obtain help from other users with them in the [MySQL XML User Forum](#).

Beginning with MySQL 5.1.20, XPath expressions used with these functions support user variables and local stored program variables. User variables are weakly checked; variables local to stored programs are strongly checked (see also [Bug#26518](#)):

- **User variables (weak checking).** Variables using the syntax ``${variable_name}` (that is, user variables) are not checked. No warnings or errors are issued by the server if a variable has the wrong type or has previously not been assigned a value. This also means the user is fully responsible for any typographical errors, since no warnings will be given if (for example) ``${myvairable}` is used where ``${myvariable}` was intended.

### Example.

```
mysql> SET @xml = '<a><b>X</b><b>Y</b></a>';
Query OK, 0 rows affected (0.00 sec)

mysql> SET @i = 1, @j = 2;
Query OK, 0 rows affected (0.00 sec)

mysql> SELECT @i, ExtractValue(@xml, '//b[`${i}]');
+-----+-----+
| @i    | ExtractValue(@xml, '//b[`${i}]') |
+-----+-----+
| 1    | X                                |
+-----+-----+
1 row in set (0.00 sec)

mysql> SELECT @j, ExtractValue(@xml, '//b[`${j}]');
+-----+-----+
| @j    | ExtractValue(@xml, '//b[`${j}]') |
+-----+-----+
| 2    | Y                                |
+-----+-----+
1 row in set (0.00 sec)

mysql> SELECT @k, ExtractValue(@xml, '//b[`${k}]');
+-----+-----+
| @k    | ExtractValue(@xml, '//b[`${k}]') |
+-----+-----+
| NULL  |                                    |
+-----+-----+
1 row in set (0.00 sec)
```

- **Variables in stored programs (strong checking).** Variables using the syntax ``${variable_name}` can be declared and used with these functions when they are called inside stored programs. Such variables are local to the stored program in which they are defined, and are strongly checked for type and value.

### Example.

```
mysql> DELIMITER |
mysql> CREATE PROCEDURE myproc ()
-> BEGIN
-> DECLARE i INT DEFAULT 1;
-> DECLARE xml VARCHAR(25) DEFAULT '<a>X</a><a>Y</a><a>Z</a>';
->
-> WHILE i < 4 DO
-> SELECT xml, i, ExtractValue(xml, '//a[`${i}]');
-> SET i = i+1;
-> END WHILE;
-> END |
Query OK, 0 rows affected (0.01 sec)

mysql> DELIMITER ;
mysql> CALL myproc;
+-----+-----+-----+
| xml          | i | ExtractValue(xml, '//a[`${i}]') |
+-----+-----+-----+
| <a>X</a><a>Y</a><a>Z</a> | 1 | X                                |
+-----+-----+-----+
1 row in set (0.00 sec)

+-----+-----+-----+
| xml          | i | ExtractValue(xml, '//a[`${i}]') |
+-----+-----+-----+
```

```

+-----+-----+-----+
| <a>X</a><a>Y</a><a>Z</a> | 2 | Y |
+-----+-----+-----+
1 row in set (0.01 sec)
+-----+-----+-----+
| xml | i | ExtractValue(xml, '//a[$i]') |
+-----+-----+-----+
| <a>X</a><a>Y</a><a>Z</a> | 3 | Z |
+-----+-----+-----+
1 row in set (0.01 sec)

```

**Parameters.** Variables used in XPath expressions inside stored routines that are passed in as parameters are also subject to strong checking.

Expressions containing user variables or variables local to stored programs must otherwise (except for notation) conform to the rules for XPath expressions containing variables as given in the XPath 1.0 specification.

**Note**

Currently, a user variable used to store an XPath expression is treated as an empty string. Because of this, it is not possible to store an XPath expression as a user variable. We intend to fix this issue in a future MySQL release. ([Bug#32911](#))

- `ExtractValue(xml_frag, xpath_expr)`

`ExtractValue()` takes two string arguments, a fragment of XML markup *xml\_frag* and an XPath expression *xpath\_expr* (also known as a *locator*); it returns the text (CDATA) of the first text node which is a child of the element(s) matched by the XPath expression. It is the equivalent of performing a match using the *xpath\_expr* after appending `/text()`. In other words, `ExtractValue('<a><b>Sakila</b></a>', '/a/b')` and `ExtractValue('<a><b>Sakila</b></a>', '/a/b/text()')` produce the same result.

If multiple matches are found, then the content of the first child text node of each matching element is returned (in the order matched) as a single, space-delimited string.

If no matching text node is found for the expression (including the implicit `/text()`) — for whatever reason, as long as *xpath\_expr* is valid, and *xml\_frag* consists of elements which are properly nested and closed — an empty string is returned. No distinction is made between a match on an empty element and no match at all. This is by design.

If you need to determine whether no matching element was found in *xml\_frag* or such an element was found but contained no child text nodes, you should test the result of an expression that uses the XPath `count()` function. For example, both of these statements return an empty string, as shown here:

```

mysql> SELECT ExtractValue('<a><b></b></a>', '/a/b');
+-----+
| ExtractValue('<a><b></b></a>', '/a/b') |
+-----+
|                                     |
+-----+
1 row in set (0.00 sec)

mysql> SELECT ExtractValue('<a><c></c></a>', '/a/b');
+-----+
| ExtractValue('<a><c></c></a>', '/a/b') |
+-----+
|                                     |
+-----+
1 row in set (0.00 sec)

```

However, you can determine whether there was actually a matching element using the following:

```

mysql> SELECT ExtractValue('<a><b></b></a>', 'count(/a/b)');
+-----+-----+
| ExtractValue('<a><b></b></a>', 'count(/a/b)') |
+-----+-----+
| 1 |
+-----+-----+
1 row in set (0.00 sec)

mysql> SELECT ExtractValue('<a><c></c></a>', 'count(/a/b)');
+-----+-----+
| ExtractValue('<a><c></c></a>', 'count(/a/b)') |
+-----+-----+
| 0 |
+-----+-----+
1 row in set (0.01 sec)

```

**Important**

`ExtractValue()` returns only `CDATA`, and does not return any tags that might be contained within a matching tag, nor any of their content (see the result returned as `val1` in the following example).

```
mysql> SELECT
-> ExtractValue('<a>ccc<b>ddd</b></a>', '/a') AS val1,
-> ExtractValue('<a>ccc<b>ddd</b></a>', '/a/b') AS val2,
-> ExtractValue('<a>ccc<b>ddd</b></a>', '/b') AS val3,
-> ExtractValue('<a>ccc<b>ddd</b></a>', '/b') AS val4,
-> ExtractValue('<a>ccc<b>ddd</b><b>eee</b></a>', '/b') AS val5;
```

val1	val2	val3	val4	val5
ccc	ddd	ddd		ddd eee

Beginning with MySQL 5.1.8, this function uses the current SQL collation for making comparisons with `contains()`, performing the same collation aggregation as other string functions (such as `CONCAT()`), in taking into account the collation coercibility of their arguments; see [Section 9.1.6.5, “Special Cases Where Collation Determination Is Tricky”](#), for an explanation of the rules governing this behavior.

(Previously, binary — that is, case-sensitive — comparison was always used.)

Beginning with MySQL 5.1.12, `NULL` is returned if `xml_frag` contains elements which are not properly nested or closed, and a warning is generated, as shown in this example:

```
mysql> SELECT ExtractValue('<a>c</a><b', '//a');
+-----+
| ExtractValue('<a>c</a><b', '//a') |
+-----+
| NULL                               |
+-----+
1 row in set, 1 warning (0.00 sec)
```

```
mysql> SHOW WARNINGS;
+-----+-----+-----+
| Level | Code | Message                                                                 |
+-----+-----+-----+
| Warning | 1523 | Incorrect XML value: 'parse error at line 1 pos 11: END-OF-INPUT unexpected ('>' wanted)' |
+-----+-----+-----+
1 row in set (0.00 sec)
```

```
mysql> SELECT ExtractValue('<a>c</a><b/>', '//a');
+-----+
| ExtractValue('<a>c</a><b/>', '//a') |
+-----+
| c                                     |
+-----+
1 row in set (0.00 sec)
```

Prior to MySQL 5.1.12, an empty string was returned in such cases. ([Bug#18201](#))

- `UpdateXML(xml_target, xpath_expr, new_xml)`

This function replaces a single portion of a given fragment of XML markup `xml_target` with a new XML fragment `new_xml`, and then returns the changed XML. The portion of `xml_target` that is replaced matches an XPath expression `xpath_expr` supplied by the user. If no expression matching `xpath_expr` is found, or if multiple matches are found, the function returns the original `xml_target` XML fragment. All three arguments should be strings.

```
mysql> SELECT
-> UpdateXML('<a><b>ccc</b><d></d></a>', '/a', '<e>fff</e>') AS val1,
-> UpdateXML('<a><b>ccc</b><d></d></a>', '/b', '<e>fff</e>') AS val2,
-> UpdateXML('<a><b>ccc</b><d></d></a>', '/b', '<e>fff</e>') AS val3,
-> UpdateXML('<a><b>ccc</b><d></d></a>', '/a/d', '<e>fff</e>') AS val4,
-> UpdateXML('<a><d></d><b>ccc</b><d></d></a>', '/a/d', '<e>fff</e>') AS val5
-> \G
```

```
***** 1. row *****
val1: <e>fff</e>
val2: <a><b>ccc</b><d></d></a>
val3: <a><e>fff</e><d></d></a>
val4: <a><b>ccc</b><e>fff</e></a>
val5: <a><d></d><b>ccc</b><d></d></a>
```

### Note

A discussion in depth of XPath syntax and usage are beyond the scope of this Manual. Please see the [XML Path Language \(XPath\) 1.0 specification](#) for definitive information. A useful resource for those new to XPath or who are wishing a refresher in the basics is the [Zvon.org XPath Tutorial](#), which is available in several languages.

Descriptions and examples of some basic XPath expressions follow:

- `/tag`

Matches `<tag/>` if and only if `<tag/>` is the root element.

Example: `/a` has a match in `<a><b/></a>` because it matches the outermost (root) tag. It does not match the inner `a` element in `<b><a/></b>` because in this instance it is the child of another element.

- `/tag1/tag2`

Matches `<tag2/>` if and only if it is a child of `<tag1/>`, and `<tag1/>` is the root element.

Example: `/a/b` matches the `b` element in the XML fragment `<a><b/></a>` because it is a child of the root element `a`. It does not have a match in `<b><a/></b>` because in this case, `b` is the root element (and hence the child of no other element). Nor does the XPath expression have a match in `<a><c><b/></c></a>`; here, `b` is a descendant of `a`, but not actually a child of `a`.

This construct is extendable to three or more elements. For example, the XPath expression `/a/b/c` matches the `c` element in the fragment `<a><b><c/></b></a>`.

- `//tag`

Matches any instance of `<tag>`.

Example: `//a` matches the `a` element in any of the following: `<a><b><c/></b></a>`; `<c><a><b/></a></b>`; `<c><b><a/></b></c>`.

`//` can be combined with `/`. For example, `//a/b` matches the `b` element in either of the fragments `<a><b/></a>` or `<a><b><c/></b></a>`

### Note

`//tag` is the equivalent of `/descendant-or-self::*<tag>`. A common error is to confuse this with `/descendant-or-self::tag`, although the latter expression can actually lead to very different results, as can be seen here:

```
mysql> SET @xml = '<a><b><c>w</c><b>x</b><d>y</d>z</b></a>';
Query OK, 0 rows affected (0.00 sec)

mysql> SELECT @xml;
+-----+
| @xml                                     |
+-----+
| <a><b><c>w</c><b>x</b><d>y</d>z</b></a>      |
+-----+
1 row in set (0.00 sec)

mysql> SELECT ExtractValue(@xml, '//b[1]');
+-----+
| ExtractValue(@xml, '//b[1]')           |
+-----+
| x z                                     |
+-----+
1 row in set (0.00 sec)

mysql> SELECT ExtractValue(@xml, '//b[2]');
+-----+
| ExtractValue(@xml, '//b[2]')           |
+-----+
|                                         |
+-----+
1 row in set (0.01 sec)

mysql> SELECT ExtractValue(@xml, '/descendant-or-self::*b[1]');
+-----+
| ExtractValue(@xml, '/descendant-or-self::*b[1]') |
+-----+
| x z                                     |
+-----+
1 row in set (0.06 sec)

mysql> SELECT ExtractValue(@xml, '/descendant-or-self::*b[2]');
+-----+
| ExtractValue(@xml, '/descendant-or-self::*b[2]') |
+-----+
|                                         |
+-----+
1 row in set (0.00 sec)

mysql> SELECT ExtractValue(@xml, '/descendant-or-self::b[1]');
```



```

+-----+
| ExtractValue(@xml, '/descendant-or-self::b[1]') |
+-----+
| z |
+-----+
1 row in set (0.00 sec)

mysql> SELECT ExtractValue(@xml, '/descendant-or-self::b[2]');
+-----+
| ExtractValue(@xml, '/descendant-or-self::b[2]') |
+-----+
| x |
+-----+
1 row in set (0.00 sec)

```

- The `*` operator acts as a “wildcard” that matches any element. For example, the expression `*/b` matches the `b` element in either of the XML fragments `<a><b></a>` or `<c><b></c>`. However, the expression does not produce a match in the fragment `<b><a></b>` because `b` must be a child of some other element. The wildcard may be used in any position: The expression `*/b/*` will match any child of a `b` element that is itself not the root element.
- You can match any of several locators using the `|` (UNION) operator. For example, the expression `//b|//c` matches all `b` and `c` elements in the XML target.
- It is also possible to match an element based on the value of one or more of its attributes. This done using the syntax `tag[@attribute="value"]`. For example, the expression `//b[@id="idB"]` matches the second `b` element in the fragment `<a><b id="idA"/><c/><b id="idB"/></a>`. To match against *any* element having `attribute="value"`, use the XPath expression `//*[attribute="value"]`.

To filter multiple attribute values, simply use multiple attribute-comparison clauses in succession. For example, the expression `//b[@c="x"][@d="y"]` matches the element `<b c="x" d="y"/>` occurring anywhere in a given XML fragment.

To find elements for which the same attribute matches any of several values, you can use multiple locators joined by the `|` operator. For example, to match all `b` elements whose `c` attributes have either of the values 23 or 17, use the expression `//b[@c="23"]|//b[@c="17"]`. You can also use the logical `or` operator for this purpose: `//b[@c="23" or @c="17"]`.

### Note

The difference between `or` and `|` is that `or` joins conditions, while `|` joins result sets.

**XPath Limitations.** The XPath syntax supported by these functions is currently subject to the following limitations:

- Nodetest-to-nodetest comparison (such as `'/a/b[@c=@d]'`) is not supported.
- Prior to MySQL 5.1.14, equality and inequality (`=` and `!=`) were the only supported comparison operators. Beginning with MySQL 5.1.14, all of the standard XPath comparison operators are supported. ([Bug#22823](#))
- Relative locator expressions are resolved in the context of the root node. For example, consider the following query and result:

```

mysql> SELECT ExtractValue(
-> ' <a><b c="1">X</b><b c="2">Y</b></a>',
-> 'a/b'
-> ) AS result;
+-----+
| result |
+-----+
| X Y |
+-----+
1 row in set (0.03 sec)

```

In this case, the locator `a/b` resolves to `/a/b`.

Relative locators are also supported within predicates. In the following example, `d[../@c="1"]` is resolved as `/a/b[d[../@c="1"]]/d`:

```

mysql> SELECT ExtractValue(
-> ' <a>
->   <b c="1"><d>X</d></b>
->   <b c="2"><d>X</d></b>
-> </a>',
-> 'a/b/d[../@c="1"]')
-> AS result;
+-----+
| result |
+-----+
| X |
+-----+

```

```
1 row in set (0.00 sec)
```

- Locators prefixed with expressions that evaluate as scalar values — including variable references, literals, numbers, and scalar function calls — are not supported. Beginning with MySQL 5.1.32, they are disallowed, and their use results in an error. ([Bug#42495](#))
- The `::` operator is not supported in combination with node types such as the following:
  - `axis::comment()`
  - `axis::text()`
  - `axis::processing-instructions()`
  - `axis::node()`

However, name tests (such as `axis::name` and `axis::*`) are supported, as shown in these examples:

```
mysql> SELECT ExtractValue('<a><b>x</b><c>y</c></a>', '/a/child:b');
+-----+
| ExtractValue('<a><b>x</b><c>y</c></a>', '/a/child:b') |
+-----+
| x |
+-----+
1 row in set (0.02 sec)

mysql> SELECT ExtractValue('<a><b>x</b><c>y</c></a>', '/a/child::*');
+-----+
| ExtractValue('<a><b>x</b><c>y</c></a>', '/a/child::*') |
+-----+
| x y |
+-----+
1 row in set (0.01 sec)
```

- “Up-and-down” navigation is not supported in cases where the path would lead “above” the root element. That is, you cannot use expressions which match on descendants of ancestors of a given element, where one or more of the ancestors of the current element is also an ancestor of the root element (see [Bug#16321](#)).
- The following XPath functions are not supported, or have known issues as indicated:
  - Prior to MySQL 5.1.24, the `boolean()` function did not produce correct results for some string and nodeset values, including the `NULL` string (see [Bug#26051](#)).
  - `id()`
  - `lang()`
  - Prior to MySQL 5.1.8, the `last()` function was not supported (see [Bug#16318](#)).
  - `local-name()`
  - `name()`
  - `namespace-uri()`
  - `normalize-space()`
  - `starts-with()`
  - `string()`
  - `substring-after()`
  - `substring-before()`
  - `translate()`
- The following axes are not supported:
  - `following-sibling`
  - `following`
  - `preceding-sibling`

- `preceding`

Beginning with MySQL 5.1.10, XPath expressions passed as arguments to `ExtractValue()` and `UpdateXML()` may contain the colon character (":") in element selectors, which enables their use with markup employing XML namespaces notation. For example:

```
mysql> SET @xml = '<a>111<b:c>222<d>333</d><e:f>444</e:f></b:c></a>';
Query OK, 0 rows affected (0.00 sec)

mysql> SELECT ExtractValue(@xml, '//e:f');
+-----+
| ExtractValue(@xml, '//e:f') |
+-----+
| 444                          |
+-----+
1 row in set (0.00 sec)

mysql> SELECT UpdateXML(@xml, '//b:c', '<g:h>555</g:h>');
+-----+
| UpdateXML(@xml, '//b:c', '<g:h>555</g:h>') |
+-----+
| <a>111<g:h>555</g:h></a>                  |
+-----+
1 row in set (0.00 sec)
```

This is similar in some respects to what is allowed by [Apache Xalan](#) and some other parsers, and is much simpler than requiring namespace declarations or the use of the `namespace-uri()` and `local-name()` functions.

**Error handling.** For both `ExtractValue()` and `UpdateXML()`, the XPath locator used must be valid and the XML to be searched must consist of elements which are properly nested and closed. If the locator is invalid, an error is generated:

```
mysql> SELECT ExtractValue('<a>c</a><b/>', '&a');
ERROR 1105 (HY000): XPATH SYNTAX ERROR: '&a'
```

If `xml_frag` does not consist of elements which are properly nested and closed, then `NULL` is returned, and a warning is generated, as shown in this example:

```
mysql> SELECT ExtractValue('<a>c</a><b', '//a');
+-----+
| ExtractValue('<a>c</a><b', '//a') |
+-----+
| NULL                              |
+-----+
1 row in set, 1 warning (0.00 sec)

mysql> SHOW WARNINGS;
+-----+-----+-----+
| Level | Code | Message |
+-----+-----+-----+
| Warning | 1523 | Incorrect XML value: 'parse error at line 1 pos 11: END-OF-INPUT unexpected ('>' wanted)' |
+-----+-----+-----+
1 row in set (0.00 sec)

mysql> SELECT ExtractValue('<a>c</a><b/>', '//a');
+-----+
| ExtractValue('<a>c</a><b/>', '//a') |
+-----+
| c                                  |
+-----+
1 row in set (0.00 sec)
```

Prior to MySQL 5.1.12, an empty string was returned in such cases. ([Bug#18201](#))

### Important

The replacement XML used as the third argument to `UpdateXML()` is *not* checked to determine whether it consists solely of elements which are properly nested and closed.

**XPath Injection.** *code injection* occurs when malicious code is introduced into the system to gain unauthorized access to privileges and data. It is based on exploiting assumptions made by developers about the type and content of data input from users. XPath is no exception in this regard.

A common scenario in which this can happen is the case of application which handles authorization by matching the combination of a login name and password with those found in an XML file, using an XPath expression like this one:

```
//user[login/text()='neapolitan' and password/text()='1c3cr34m']/attribute::id
```

This is the XPath equivalent of an SQL statement like this one:

```
SELECT id FROM users WHERE login='neapolitan' AND password='1c3cr34m';
```

A PHP application employing XPath might handle the login process like this:

```
<?php
    $file      =    "users.xml";
    $login     =    $POST["login"];
    $password  =    $POST["password"];

    $xpath = "//user[login/text()=$login and password/text()=$password]/attribute::id";

    if( file_exists($file) )
    {
        $xml = simplexml_load_file($file);

        if($result = $xml->xpath($xpath))
            echo "You are now logged in as user $result[0].";
        else
            echo "Invalid login name or password.";
    }
    else
        exit("Failed to open $file.");
?>
```

No checks are performed on the input. This means that a malevolent user can “short-circuit” the test by entering ' or 1=1 for both the login name and password, resulting in `$xpath` being evaluated as shown here:

```
//user[login/text()=' ' or 1=1 and password/text()=' ' or 1=1]/attribute::id
```

Since the expression inside the square brackets always evaluates as `true`, it is effectively the same as this one, which matches the `id` attribute of every `user` element in the XML document:

```
//user/attribute::id
```

One way in which this particular attack can be circumvented is simply by quoting the variable names to be interpolated in the definition of `$xpath`, forcing the values passed from a Web form to be converted to strings:

```
$xpath = "//user[login/text()=' $login' and password/text()=' $password']/attribute::id";
```

This is the same strategy that is often recommended for preventing SQL injection attacks. In general, the practices you should follow for preventing XPath injection attacks are the same as for preventing SQL injection:

- Never accepted untested data from users in your application.
- Check all user-submitted data for type; reject or convert data that is of the wrong type
- Test numerical data for out of range values; truncate, round, or reject values that are out of range. Test strings for illegal characters and either strip them out or reject input containing them.
- Do not output explicit error messages that might provide an unauthorized user with clues that could be used to compromise the system; log these to a file or database table instead.

Just as SQL injection attacks can be used to obtain information about database schemas, so can XPath injection be used to traverse XML files to uncover their structure, as discussed in Amit Klein's paper [Blind XPath Injection](#) (PDF file, 46KB).

It is also important to check the output being sent back to the client. Consider what can happen when we use the MySQL `ExtractValue()` function:

```
mysql> SELECT ExtractValue(
->     LOAD_FILE('users.xml'),
->     '//user[login/text()=' " or 1=1 and password/text()=' " or 1=1]/attribute::id'
-> ) AS id;
+-----+
| id      |
+-----+
| 00327 13579 02403 42354 28570 |
+-----+
1 row in set (0.01 sec)
```

Because `ExtractValue()` returns multiple matches as a single space-delimited string, this injection attack provides every valid ID contained within `users.xml` to the user as a single row of output. As an extra safeguard, you should also test output before returning it to the user. Here is a simple example:

```
mysql> SELECT @id = ExtractValue(
->     LOAD_FILE('users.xml'),
->     '//user[login/text()="" or 1=1 and password/text()="" or 1=1]/attribute::id'
-> );
Query OK, 0 rows affected (0.00 sec)

mysql> SELECT IF(
->     INSTR(@id, ' ') = 0,
->     @id,
->     'Unable to retrieve user ID')
-> AS singleID;
+-----+
| singleID |
+-----+
| Unable to retrieve user ID |
+-----+
1 row in set (0.00 sec)
```

In general, the guidelines for returning data to users securely are the same as for accepting user input. These can be summed up as:

- Always test outgoing data for type and allowable values.
- Never allow unauthorized users to view error messages that might provide information about the application that could be used to exploit it.

## 11.11. Other Functions

Name	Description
<code>AES_DECRYPT()</code>	Decrypt using AES
<code>AES_ENCRYPT()</code>	Encrypt using AES
<code>BENCHMARK()</code>	Repeatedly execute an expression
<code>BIT_COUNT()</code>	Return the number of bits that are set
<code>&amp;</code>	Bitwise AND
<code>~</code>	Invert bits
<code> </code>	Bitwise OR
<code>^</code>	Bitwise XOR
<code>CHARSET()</code> (v4.1.0)	Return the character set of the argument
<code>COERCIBILITY()</code> (v4.1.1)	Return the collation coercibility value of the string argument
<code>COLLATION()</code> (v4.1.0)	Return the collation of the string argument
<code>COMPRESS()</code> (v4.1.1)	Return result as a binary string
<code>CONNECTION_ID()</code>	Return the connection ID (thread ID) for the connection
<code>CURRENT_USER()</code> , <code>CURRENT_USER</code>	Return the user name and host name combination
<code>DATABASE()</code>	Return the default (current) database name
<code>DECODE()</code>	Decodes a string encrypted using <code>ENCODE()</code>
<code>DEFAULT()</code>	Return the default value for a table column
<code>DES_DECRYPT()</code>	Decrypt a string
<code>DES_ENCRYPT()</code>	Encrypt a string
<code>ENCODE()</code>	Encode a string
<code>ENCRYPT()</code>	Encrypt a string
<code>FOUND_ROWS()</code>	For a <code>SELECT</code> with a <code>LIMIT</code> clause, the number of rows that would be returned were there no <code>LIMIT</code> clause
<code>GET_LOCK()</code>	Get a named lock
<code>INET_ATON()</code>	Return the numeric value of an IP address
<code>INET_NTOA()</code>	Return the IP address from a numeric value
<code>IS_FREE_LOCK()</code>	Checks whether the named lock is free
<code>IS_USED_LOCK()</code> (v4.1.0)	Checks whether the named lock is in use. Return connection identifier if true.
<code>LAST_INSERT_ID()</code>	Value of the <code>AUTOINCREMENT</code> column for the last <code>INSERT</code>
<code>&lt;&lt;</code>	Left shift

Name	Description
<code>MASTER_POS_WAIT()</code>	Block until the slave has read and applied all updates up to the specified position
<code>MD5()</code>	Calculate MD5 checksum
<code>NAME_CONST()</code> (v5.0.12)	Causes the column to have the given name
<code>OLD_PASSWORD()</code> (v4.1)	Return the value of the old (pre-4.1) implementation of PASSWORD
<code>PASSWORD()</code>	Calculate and return a password string
<code>RAND()</code>	Return a random floating-point value
<code>RELEASE_LOCK()</code>	Releases the named lock
<code>&gt;&gt;</code>	Right shift
<code>ROW_COUNT()</code> (v5.0.1)	The number of rows updated
<code>SCHEMA()</code> (v5.0.2)	A synonym for DATABASE()
<code>SESSION_USER()</code>	Synonym for USER()
<code>SHA1()</code> , <code>SHA()</code>	Calculate an SHA-1 160-bit checksum
<code>SLEEP()</code> (v5.0.12)	Sleep for a number of seconds
<code>SYSTEM_USER()</code>	Synonym for USER()
<code>UNCOMPRESS()</code> (v4.1.1)	Uncompress a string compressed
<code>UNCOMPRESSED_LENGTH()</code> (v4.1.1)	Return the length of a string before compression
<code>USER()</code>	Return the current user name and host name
<code>UUID_SHORT()</code> (v5.1.20)	Return an integer-valued universal identifier
<code>UUID()</code> (v4.1.2)	Return a Universal Unique Identifier (UUID)
<code>VALUES()</code> (v4.1.1)	Defines the values to be used during an INSERT
<code>VERSION()</code>	Returns a string that indicates the MySQL server version

### 11.11.1. Bit Functions

Name	Description
<code>BIT_COUNT()</code>	Return the number of bits that are set
<code>&amp;</code>	Bitwise AND
<code>~</code>	Invert bits
<code> </code>	Bitwise OR
<code>^</code>	Bitwise XOR
<code>&lt;&lt;</code>	Left shift
<code>&gt;&gt;</code>	Right shift

MySQL uses `BIGINT` (64-bit) arithmetic for bit operations, so these operators have a maximum range of 64 bits.

- `|`

Bitwise OR:

```
mysql> SELECT 29 | 15;
-> 31
```

The result is an unsigned 64-bit integer.

- `&`

Bitwise AND:

```
mysql> SELECT 29 & 15;
-> 13
```

The result is an unsigned 64-bit integer.

- ^

Bitwise XOR:

```
mysql> SELECT 1 ^ 1;
-> 0
mysql> SELECT 1 ^ 0;
-> 1
mysql> SELECT 11 ^ 3;
-> 8
```

The result is an unsigned 64-bit integer.

- <<

Shifts a longlong (**BIGINT**) number to the left.

```
mysql> SELECT 1 << 2;
-> 4
```

The result is an unsigned 64-bit integer. The value is truncated to 64 bits. In particular, if the shift count is greater or equal to the width of an unsigned 64-bit number, the result is zero.

- >>

Shifts a longlong (**BIGINT**) number to the right.

```
mysql> SELECT 4 >> 2;
-> 1
```

The result is an unsigned 64-bit integer. The value is truncated to 64 bits. In particular, if the shift count is greater or equal to the width of an unsigned 64-bit number, the result is zero.

- ~

Invert all bits.

```
mysql> SELECT 5 & ~1;
-> 4
```

The result is an unsigned 64-bit integer.

- **BIT\_COUNT(N)**

Returns the number of bits that are set in the argument *N*.

```
mysql> SELECT BIT_COUNT(29), BIT_COUNT(b'101010');
-> 4, 3
```

## 11.11.2. Encryption and Compression Functions

Name	Description
<b>AES_DECRYPT()</b>	Decrypt using AES
<b>AES_ENCRYPT()</b>	Encrypt using AES
<b>COMPRESS()</b> (v4.1.1)	Return result as a binary string
<b>DECODE()</b>	Decodes a string encrypted using ENCODE()
<b>DES_DECRYPT()</b>	Decrypt a string
<b>DES_ENCRYPT()</b>	Encrypt a string
<b>ENCODE()</b>	Encode a string
<b>ENCRYPT()</b>	Encrypt a string
<b>MD5()</b>	Calculate MD5 checksum
<b>OLD_PASSWORD()</b> (v4.1)	Return the value of the old (pre-4.1) implementation of PASSWORD

Name	Description
<code>PASSWORD()</code>	Calculate and return a password string
<code>SHA1()</code> , <code>SHA()</code>	Calculate an SHA-1 160-bit checksum
<code>UNCOMPRESS()</code> (v4.1.1)	Uncompress a string compressed
<code>UNCOMPRESSED_LENGTH()</code> (v4.1.1)	Return the length of a string before compression

**Note**

The encryption and compression functions return binary strings. For many of these functions, the result might contain arbitrary byte values. If you want to store these results, use a column with a `VARBINARY` or `BLOB` binary string data type. This will avoid potential problems with trailing space removal or character set conversion that would change data values, such as may occur if you use a nonbinary string data type (`CHAR`, `VARCHAR`, `TEXT`).

**Note**

Exploits for the MD5 and SHA-1 algorithms have become known. You may wish to consider using one of the other encryption functions described in this section instead.

- `AES_DECRYPT(crypt_str,key_str)`

This function allows decryption of data using the official AES (Advanced Encryption Standard) algorithm. For more information, see the description of `AES_ENCRYPT()`.

- `AES_ENCRYPT(str,key_str)`

`AES_ENCRYPT()` and `AES_DECRYPT()` allow encryption and decryption of data using the official AES (Advanced Encryption Standard) algorithm, previously known as “Rijndael.” Encoding with a 128-bit key length is used, but you can extend it up to 256 bits by modifying the source. We chose 128 bits because it is much faster and it is secure enough for most purposes.

`AES_ENCRYPT()` encrypts a string and returns a binary string. `AES_DECRYPT()` decrypts the encrypted string and returns the original string. The input arguments may be any length. If either argument is `NULL`, the result of this function is also `NULL`.

Because AES is a block-level algorithm, padding is used to encode uneven length strings and so the result string length may be calculated using this formula:

$$16 \times (\text{trunc}(\text{string\_length} / 16) + 1)$$

If `AES_DECRYPT()` detects invalid data or incorrect padding, it returns `NULL`. However, it is possible for `AES_DECRYPT()` to return a non-`NULL` value (possibly garbage) if the input data or the key is invalid.

You can use the AES functions to store data in an encrypted form by modifying your queries:

```
INSERT INTO t VALUES (1,AES_ENCRYPT('text','password'));
```

`AES_ENCRYPT()` and `AES_DECRYPT()` can be considered the most cryptographically secure encryption functions currently available in MySQL.

- `COMPRESS(string_to_compress)`

Compresses a string and returns the result as a binary string. This function requires MySQL to have been compiled with a compression library such as `zlib`. Otherwise, the return value is always `NULL`. The compressed string can be uncompressed with `UNCOMPRESS()`.

```
mysql> SELECT LENGTH(COMPRESS(REPEAT('a',1000)));
-> 21
mysql> SELECT LENGTH(COMPRESS(''));
-> 0
mysql> SELECT LENGTH(COMPRESS('a'));
-> 13
mysql> SELECT LENGTH(COMPRESS(REPEAT('a',16)));
-> 15
```

The compressed string contents are stored the following way:

- Empty strings are stored as empty strings.
- Non-empty strings are stored as a four-byte length of the uncompressed string (low byte first), followed by the compressed



string. If the string ends with space, an extra “.” character is added to avoid problems with endspace trimming should the result be stored in a `CHAR` or `VARCHAR` column. (However, use of nonbinary string data types such as `CHAR` or `VARCHAR` to store compressed strings is not recommended anyway because character set conversion may occur. Use a `VARBINARY` or `BLOB` binary string column instead.)

- `DECODE(crypt_str,pass_str)`

Decrypts the encrypted string *crypt\_str* using *pass\_str* as the password. *crypt\_str* should be a string returned from `ENCODE()`.

- `ENCODE(str,pass_str)`

Encrypt *str* using *pass\_str* as the password. To decrypt the result, use `DECODE()`.

The result is a binary string of the same length as *str*.

The strength of the encryption is based on how good the random generator is. It should suffice for short strings.

- `DES_DECRYPT(crypt_str[,key_str])`

Decrypts a string encrypted with `DES_ENCRYPT()`. If an error occurs, this function returns `NULL`.

This function works only if MySQL has been configured with SSL support. See [Section 5.5.7, “Using SSL for Secure Connections”](#).

If no *key\_str* argument is given, `DES_DECRYPT()` examines the first byte of the encrypted string to determine the DES key number that was used to encrypt the original string, and then reads the key from the DES key file to decrypt the message. For this to work, the user must have the `SUPER` privilege. The key file can be specified with the `--des-key-file` server option.

If you pass this function a *key\_str* argument, that string is used as the key for decrypting the message.

If the *crypt\_str* argument does not appear to be an encrypted string, MySQL returns the given *crypt\_str*.

- `DES_ENCRYPT(str[,{key_num|key_str}])`

Encrypts the string with the given key using the Triple-DES algorithm.

This function works only if MySQL has been configured with SSL support. See [Section 5.5.7, “Using SSL for Secure Connections”](#).

The encryption key to use is chosen based on the second argument to `DES_ENCRYPT()`, if one was given. With no argument, the first key from the DES key file is used. With a *key\_num* argument, the given key number (0-9) from the DES key file is used. With a *key\_str* argument, the given key string is used to encrypt *str*.

The key file can be specified with the `--des-key-file` server option.

The return string is a binary string where the first character is `CHAR(128 | key_num)`. If an error occurs, `DES_ENCRYPT()` returns `NULL`.

The 128 is added to make it easier to recognize an encrypted key. If you use a string key, *key\_num* is 127.

The string length for the result is given by this formula:

```
new_len = orig_len + (8 - (orig_len % 8)) + 1
```

Each line in the DES key file has the following format:

```
key_num des_key_str
```

Each *key\_num* value must be a number in the range from 0 to 9. Lines in the file may be in any order. *des\_key\_str* is the string that is used to encrypt the message. There should be at least one space between the number and the key. The first key is the default key that is used if you do not specify any key argument to `DES_ENCRYPT()`.

You can tell MySQL to read new key values from the key file with the `FLUSH DES_KEY_FILE` statement. This requires the `RELOAD` privilege.

One benefit of having a set of default keys is that it gives applications a way to check for the existence of encrypted column values, without giving the end user the right to decrypt those values.

```
mysql> SELECT customer_address FROM customer_table
```

```
> WHERE crypted_credit_card = DES_ENCRYPT('credit_card_number');
```

- `ENCRYPT(str[,salt])`

Encrypts `str` using the Unix `crypt()` system call and returns a binary string. The `salt` argument should be a string with at least two characters. If no `salt` argument is given, a random value is used.

```
mysql> SELECT ENCRYPT('hello');
-> 'VxuFAJXVARROc'
```

`ENCRYPT()` ignores all but the first eight characters of `str`, at least on some systems. This behavior is determined by the implementation of the underlying `crypt()` system call.

The use of `ENCRYPT()` with multi-byte character sets other than `utf8` is not recommended because the system call expects a string terminated by a zero byte.

If `crypt()` is not available on your system (as is the case with Windows), `ENCRYPT()` always returns `NULL`.

- `MD5(str)`

Calculates an MD5 128-bit checksum for the string. The value is returned as a binary string of 32 hex digits, or `NULL` if the argument was `NULL`. The return value can, for example, be used as a hash key.

```
mysql> SELECT MD5('testing');
-> 'ae2b1fca515949e5d54fb22b8ed95575'
```

This is the “RSA Data Security, Inc. MD5 Message-Digest Algorithm.”

If you want to convert the value to uppercase, see the description of binary string conversion given in the entry for the `BINARY` operator in [Section 11.9, “Cast Functions and Operators”](#).

See the note regarding the MD5 algorithm at the beginning this section.

- `OLD_PASSWORD(str)`

`OLD_PASSWORD()` was added to MySQL when the implementation of `PASSWORD()` was changed to improve security. `OLD_PASSWORD()` returns the value of the old (pre-4.1) implementation of `PASSWORD()` as a binary string, and is intended to permit you to reset passwords for any pre-4.1 clients that need to connect to your version 5.1 MySQL server without locking them out. See [Section 5.5.6.3, “Password Hashing in MySQL”](#).

- `PASSWORD(str)`

Calculates and returns a password string from the plaintext password `str` and returns a binary string, or `NULL` if the argument was `NULL`. This is the function that is used for encrypting MySQL passwords for storage in the `Password` column of the `user` grant table.

```
mysql> SELECT PASSWORD('badpwd');
-> '*AAB3E285149C0135D51A520E1940DD3263DC008C'
```

`PASSWORD()` encryption is one-way (not reversible).

`PASSWORD()` does not perform password encryption in the same way that Unix passwords are encrypted. See `ENCRYPT()`.

### Note

The `PASSWORD()` function is used by the authentication system in MySQL Server; you should *not* use it in your own applications. For that purpose, consider `MD5()` or `SHA1()` instead. Also see [RFC 2195, section 2 \(Challenge-Response Authentication Mechanism \(CRAM\)\)](#), for more information about handling passwords and authentication securely in your applications.

- `SHA1(str)`, `SHA(str)`

Calculates an SHA-1 160-bit checksum for the string, as described in RFC 3174 (Secure Hash Algorithm). The value is returned as a binary string of 40 hex digits, or `NULL` if the argument was `NULL`. One of the possible uses for this function is as a hash key. You can also use it as a cryptographic function for storing passwords. `SHA()` is synonymous with `SHA1()`.

```
mysql> SELECT SHA1('abc');
-> 'a9993e364706816aba3e25717850c26c9cd0d89d'
```

`SHA1()` can be considered a cryptographically more secure equivalent of `MD5()`. However, see the note regarding the MD5

and SHA-1 algorithms at the beginning this section.

- `UNCOMPRESS(string_to_uncompress)`

Uncompresses a string compressed by the `COMPRESS()` function. If the argument is not a compressed value, the result is `NULL`. This function requires MySQL to have been compiled with a compression library such as `zlib`. Otherwise, the return value is always `NULL`.

```
mysql> SELECT UNCOMPRESS(COMPRESS('any string'));
-> 'any string'
mysql> SELECT UNCOMPRESS('any string');
-> NULL
```

- `UNCOMPRESSED_LENGTH(compressed_string)`

Returns the length that the compressed string had before being compressed.

```
mysql> SELECT UNCOMPRESSED_LENGTH(COMPRESS(REPEAT('a', 30)));
-> 30
```

### 11.11.3. Information Functions

Name	Description
<code>BENCHMARK()</code>	Repeatedly execute an expression
<code>CHARSET()</code> (v4.1.0)	Return the character set of the argument
<code>COERCIBILITY()</code> (v4.1.1)	Return the collation coercibility value of the string argument
<code>COLLATION()</code> (v4.1.0)	Return the collation of the string argument
<code>CONNECTION_ID()</code>	Return the connection ID (thread ID) for the connection
<code>CURRENT_USER()</code> , <code>CURRENT_USER</code>	Return the user name and host name combination
<code>DATABASE()</code>	Return the default (current) database name
<code>FOUND_ROWS()</code>	For a <code>SELECT</code> with a <code>LIMIT</code> clause, the number of rows that would be returned were there no <code>LIMIT</code> clause
<code>LAST_INSERT_ID()</code>	Value of the <code>AUTOINCREMENT</code> column for the last <code>INSERT</code>
<code>ROW_COUNT()</code> (v5.0.1)	The number of rows updated
<code>SCHEMA()</code> (v5.0.2)	A synonym for <code>DATABASE()</code>
<code>SESSION_USER()</code>	Synonym for <code>USER()</code>
<code>SYSTEM_USER()</code>	Synonym for <code>USER()</code>
<code>USER()</code>	Return the current user name and host name
<code>VERSION()</code>	Returns a string that indicates the MySQL server version

- `BENCHMARK(count, expr)`

The `BENCHMARK()` function executes the expression `expr` repeatedly `count` times. It may be used to time how quickly MySQL processes the expression. The result value is always `0`. The intended use is from within the `mysql` client, which reports query execution times:

```
mysql> SELECT BENCHMARK(1000000, ENCODE('hello', 'goodbye'));
+-----+
| BENCHMARK(1000000, ENCODE('hello', 'goodbye')) |
+-----+
| 0 |
+-----+
1 row in set (4.74 sec)
```

The time reported is elapsed time on the client end, not CPU time on the server end. It is advisable to execute `BENCHMARK()` several times, and to interpret the result with regard to how heavily loaded the server machine is.

`BENCHMARK()` is intended for measuring the runtime performance of scalar expressions, which has some significant implications for the way that you use it and interpret the results:

- Only scalar expressions can be used. Although the expression can be a subquery, it must return a single column and at most

a single row. For example, `BENCHMARK(10, (SELECT * FROM t))` will fail if the table `t` has more than one column or more than one row.

- Executing a `SELECT expr` statement  $N$  times differs from executing `SELECT BENCHMARK(N, expr)` in terms of the amount of overhead involved. The two have very different execution profiles and you should not expect them to take the same amount of time. The former involves the parser, optimizer, table locking, and runtime evaluation  $N$  times each. The latter involves only runtime evaluation  $N$  times, and all the other components just once. Memory structures already allocated are reused, and runtime optimizations such as local caching of results already evaluated for aggregate functions can alter the results. Use of `BENCHMARK()` thus measures performance of the runtime component by giving more weight to that component and removing the “noise” introduced by the network, parser, optimizer, and so forth.
- `CHARSET(str)`

Returns the character set of the string argument.

```
mysql> SELECT CHARSET('abc');
-> 'latin1'
mysql> SELECT CHARSET(CONVERT('abc' USING utf8));
-> 'utf8'
mysql> SELECT CHARSET(USER());
-> 'utf8'
```

- `COERCIBILITY(str)`

Returns the collation coercibility value of the string argument.

```
mysql> SELECT COERCIBILITY('abc' COLLATE latin1_swedish_ci);
-> 0
mysql> SELECT COERCIBILITY(USER());
-> 3
mysql> SELECT COERCIBILITY('abc');
-> 4
```

The return values have the meanings shown in the following table. Lower values have higher precedence.

Coercibility	Meaning	Example
0	Explicit collation	Value with <code>COLLATE</code> clause
1	No collation	Concatenation of strings with different collations
2	Implicit collation	Column value, stored routine parameter or local variable
3	System constant	<code>USER()</code> return value
4	Coercible	Literal string
5	Ignorable	<code>NULL</code> or an expression derived from <code>NULL</code>

- `COLLATION(str)`

Returns the collation of the string argument.

```
mysql> SELECT COLLATION('abc');
-> 'latin1_swedish_ci'
mysql> SELECT COLLATION(utf8'abc');
-> 'utf8_general_ci'
```

- `CONNECTION_ID()`

Returns the connection ID (thread ID) for the connection. Every connection has an ID that is unique among the set of currently connected clients.

```
mysql> SELECT CONNECTION_ID();
-> 23786
```

- `CURRENT_USER, CURRENT_USER()`

Returns the user name and host name combination for the MySQL account that the server used to authenticate the current client. This account determines your access privileges. The return value is a string in the `utf8` character set.

The value of `CURRENT_USER()` can differ from the value of `USER()`.

```
mysql> SELECT USER();
-> 'davida@localhost'
```

```
mysql> SELECT * FROM mysql.user;
ERROR 1044: Access denied for user ''@'localhost' to
database 'mysql'
mysql> SELECT CURRENT_USER();
-> '@localhost'
```

The example illustrates that although the client specified a user name of `davida` (as indicated by the value of the `USER()` function), the server authenticated the client using an anonymous user account (as seen by the empty user name part of the `CURRENT_USER()` value). One way this might occur is that there is no account listed in the grant tables for `davida`.

Within a stored program or view, `CURRENT_USER()` returns the account for the user who defined the object (as given by its `DEFINER` value). For stored procedures and functions and views defined with the `SQL SECURITY INVOKER` characteristic, `CURRENT_USER()` returns the object's invoker.

- `DATABASE()`

Returns the default (current) database name as a string in the `utf8` character set. If there is no default database, `DATABASE()` returns `NULL`. Within a stored routine, the default database is the database that the routine is associated with, which is not necessarily the same as the database that is the default in the calling context.

```
mysql> SELECT DATABASE();
-> 'test'
```

If there is no default database, `DATABASE()` returns `NULL`.

- `FOUND_ROWS()`

A `SELECT` statement may include a `LIMIT` clause to restrict the number of rows the server returns to the client. In some cases, it is desirable to know how many rows the statement would have returned without the `LIMIT`, but without running the statement again. To obtain this row count, include a `SQL_CALC_FOUND_ROWS` option in the `SELECT` statement, and then invoke `FOUND_ROWS()` afterward:

```
mysql> SELECT SQL_CALC_FOUND_ROWS * FROM tbl_name
-> WHERE id > 100 LIMIT 10;
mysql> SELECT FOUND_ROWS();
```

The second `SELECT` returns a number indicating how many rows the first `SELECT` would have returned had it been written without the `LIMIT` clause.

In the absence of the `SQL_CALC_FOUND_ROWS` option in the most recent successful `SELECT` statement, `FOUND_ROWS()` returns the number of rows in the result set returned by that statement. If the statement includes a `LIMIT` clause, `FOUND_ROWS()` returns the number of rows up to the limit. For example, `FOUND_ROWS()` returns 10 or 60, respectively, if the statement includes `LIMIT 10` or `LIMIT 50, 10`.

The row count available through `FOUND_ROWS()` is transient and not intended to be available past the statement following the `SELECT SQL_CALC_FOUND_ROWS` statement. If you need to refer to the value later, save it:

```
mysql> SELECT SQL_CALC_FOUND_ROWS * FROM ... ;
mysql> SET @rows = FOUND_ROWS();
```

If you are using `SELECT SQL_CALC_FOUND_ROWS`, MySQL must calculate how many rows are in the full result set. However, this is faster than running the query again without `LIMIT`, because the result set need not be sent to the client.

`SQL_CALC_FOUND_ROWS` and `FOUND_ROWS()` can be useful in situations when you want to restrict the number of rows that a query returns, but also determine the number of rows in the full result set without running the query again. An example is a Web script that presents a paged display containing links to the pages that show other sections of a search result. Using `FOUND_ROWS()` allows you to determine how many other pages are needed for the rest of the result.

The use of `SQL_CALC_FOUND_ROWS` and `FOUND_ROWS()` is more complex for `UNION` statements than for simple `SELECT` statements, because `LIMIT` may occur at multiple places in a `UNION`. It may be applied to individual `SELECT` statements in the `UNION`, or global to the `UNION` result as a whole.

The intent of `SQL_CALC_FOUND_ROWS` for `UNION` is that it should return the row count that would be returned without a global `LIMIT`. The conditions for use of `SQL_CALC_FOUND_ROWS` with `UNION` are:

- The `SQL_CALC_FOUND_ROWS` keyword must appear in the first `SELECT` of the `UNION`.
- The value of `FOUND_ROWS()` is exact only if `UNION ALL` is used. If `UNION` without `ALL` is used, duplicate removal occurs and the value of `FOUND_ROWS()` is only approximate.
- If no `LIMIT` is present in the `UNION`, `SQL_CALC_FOUND_ROWS` is ignored and returns the number of rows in the tempor-

ary table that is created to process the `UNION`.

Beyond the cases described here, the behavior of `FOUND_ROWS()` is undefined (for example, its value following a `SELECT` statement that fails with an error).

### Important

`FOUND_ROWS()` is not replicated reliably using statement-based replication. Starting with MySQL 5.1.23, this function is automatically replicated using row-based replication.

- `LAST_INSERT_ID()`, `LAST_INSERT_ID(expr)`

For MySQL 5.1.12 and later, `LAST_INSERT_ID()` (no arguments) returns the *first* automatically generated value *successfully* inserted for an `AUTO_INCREMENT` column as a result of the most recently executed `INSERT` statement. The value of `LAST_INSERT_ID()` remains unchanged if no rows are successfully inserted.

For example, after inserting a row that generates an `AUTO_INCREMENT` value, you can get the value like this:

```
mysql> SELECT LAST_INSERT_ID();
-> 195
```

In MySQL 5.1.11 and earlier, `LAST_INSERT_ID()` (no arguments) returns the *first* automatically generated value if any rows were successfully inserted or updated. This means that the returned value could be a value that was not successfully inserted into the table. If no rows were successfully inserted, `LAST_INSERT_ID()` returns 0.

The value of `LAST_INSERT_ID()` will be consistent across all versions if all rows in the `INSERT` or `UPDATE` statement were successful.

if a table contains an `AUTO_INCREMENT` column and `INSERT ... ON DUPLICATE KEY UPDATE` updates (rather than inserts) a row, the value of `LAST_INSERT_ID()` is not meaningful prior to MySQL 5.1.12. For a workaround, see [Section 12.2.5.3, “INSERT ... ON DUPLICATE KEY UPDATE Syntax”](#).

The currently executing statement does not affect the value of `LAST_INSERT_ID()`. Suppose that you generate an `AUTO_INCREMENT` value with one statement, and then refer to `LAST_INSERT_ID()` in a multiple-row `INSERT` statement that inserts rows into a table with its own `AUTO_INCREMENT` column. The value of `LAST_INSERT_ID()` will remain stable in the second statement; its value for the second and later rows is not affected by the earlier row insertions. (However, if you mix references to `LAST_INSERT_ID()` and `LAST_INSERT_ID(expr)`, the effect is undefined.)

If the previous statement returned an error, the value of `LAST_INSERT_ID()` is undefined. For transactional tables, if the statement is rolled back due to an error, the value of `LAST_INSERT_ID()` is left undefined. For manual `ROLLBACK`, the value of `LAST_INSERT_ID()` is not restored to that before the transaction; it remains as it was at the point of the `ROLLBACK`.

Within the body of a stored routine (procedure or function) or a trigger, the value of `LAST_INSERT_ID()` changes the same way as for statements executed outside the body of these kinds of objects. The effect of a stored routine or trigger upon the value of `LAST_INSERT_ID()` that is seen by following statements depends on the kind of routine:

- If a stored procedure executes statements that change the value of `LAST_INSERT_ID()`, the changed value will be seen by statements that follow the procedure call.
- For stored functions and triggers that change the value, the value is restored when the function or trigger ends, so following statements will not see a changed value.

The ID that was generated is maintained in the server on a *per-connection basis*. This means that the value returned by the function to a given client is the first `AUTO_INCREMENT` value generated for most recent statement affecting an `AUTO_INCREMENT` column *by that client*. This value cannot be affected by other clients, even if they generate `AUTO_INCREMENT` values of their own. This behavior ensures that each client can retrieve its own ID without concern for the activity of other clients, and without the need for locks or transactions.

The value of `LAST_INSERT_ID()` is not changed if you set the `AUTO_INCREMENT` column of a row to a non-“magic” value (that is, a value that is not `NULL` and not 0).

### Important

If you insert multiple rows using a single `INSERT` statement, `LAST_INSERT_ID()` returns the value generated for the *first* inserted row *only*. The reason for this is to make it possible to reproduce easily the same `INSERT` statement against some other server.

For example:

```

mysql> USE test;
Database changed
mysql> CREATE TABLE t (
  ->   id INT AUTO_INCREMENT NOT NULL PRIMARY KEY,
  ->   name VARCHAR(10) NOT NULL
  -> );
Query OK, 0 rows affected (0.09 sec)

mysql> INSERT INTO t VALUES (NULL, 'Bob');
Query OK, 1 row affected (0.01 sec)

mysql> SELECT * FROM t;
+----+-----+
| id | name |
+----+-----+
|  1 | Bob  |
+----+-----+
1 row in set (0.01 sec)

mysql> SELECT LAST_INSERT_ID();
+-----+
| LAST_INSERT_ID() |
+-----+
|                  1 |
+-----+
1 row in set (0.00 sec)

mysql> INSERT INTO t VALUES
  -> (NULL, 'Mary'), (NULL, 'Jane'), (NULL, 'Lisa');
Query OK, 3 rows affected (0.00 sec)
Records: 3 Duplicates: 0 Warnings: 0

mysql> SELECT * FROM t;
+----+-----+
| id | name |
+----+-----+
|  1 | Bob  |
|  2 | Mary |
|  3 | Jane |
|  4 | Lisa |
+----+-----+
4 rows in set (0.01 sec)

mysql> SELECT LAST_INSERT_ID();
+-----+
| LAST_INSERT_ID() |
+-----+
|                  2 |
+-----+
1 row in set (0.00 sec)
    
```

Although the second `INSERT` statement inserted three new rows into `t`, the ID generated for the first of these rows was `2`, and it is this value that is returned by `LAST_INSERT_ID()` for the following `SELECT` statement.

If you use `INSERT IGNORE` and the row is ignored, the `AUTO_INCREMENT` counter is not incremented and `LAST_INSERT_ID()` returns `0`, which reflects that no row was inserted.

If `expr` is given as an argument to `LAST_INSERT_ID()`, the value of the argument is returned by the function and is remembered as the next value to be returned by `LAST_INSERT_ID()`. This can be used to simulate sequences:

1. Create a table to hold the sequence counter and initialize it:

```

mysql> CREATE TABLE sequence (id INT NOT NULL);
mysql> INSERT INTO sequence VALUES (0);
    
```

2. Use the table to generate sequence numbers like this:

```

mysql> UPDATE sequence SET id=LAST_INSERT_ID(id+1);
mysql> SELECT LAST_INSERT_ID();
    
```

The `UPDATE` statement increments the sequence counter and causes the next call to `LAST_INSERT_ID()` to return the updated value. The `SELECT` statement retrieves that value. The `mysql_insert_id()` C API function can also be used to get the value. See [Section 20.10.3.37](#), “`mysql_insert_id()`”.

You can generate sequences without calling `LAST_INSERT_ID()`, but the utility of using the function this way is that the ID value is maintained in the server as the last automatically generated value. It is multi-user safe because multiple clients can issue the `UPDATE` statement and get their own sequence value with the `SELECT` statement (or `mysql_insert_id()`), without affecting or being affected by other clients that generate their own sequence values.

Note that `mysql_insert_id()` is only updated after `INSERT` and `UPDATE` statements, so you cannot use the C API function to retrieve the value for `LAST_INSERT_ID(expr)` after executing other SQL statements like `SELECT` or `SET`.

- `ROW_COUNT()`

`ROW_COUNT()` returns the number of rows updated, inserted, or deleted by the preceding statement. This is the same as the row count that the `mysql` client displays and the value from the `mysql_affected_rows()` C API function.

```
mysql> INSERT INTO t VALUES(1),(2),(3);
Query OK, 3 rows affected (0.00 sec)
Records: 3 Duplicates: 0 Warnings: 0

mysql> SELECT ROW_COUNT();
+-----+
| ROW_COUNT() |
+-----+
|           3 |
+-----+
1 row in set (0.00 sec)

mysql> DELETE FROM t WHERE i IN(1,2);
Query OK, 2 rows affected (0.00 sec)

mysql> SELECT ROW_COUNT();
+-----+
| ROW_COUNT() |
+-----+
|           2 |
+-----+
1 row in set (0.00 sec)
```

### Important

`ROW_COUNT()` is not replicated reliably using statement-based replication. Beginning with MySQL 5.1.23, this function is automatically replicated using row-based replication. ([Bug#30244](#))

- `SCHEMA()`

This function is a synonym for `DATABASE()`.

- `SESSION_USER()`

`SESSION_USER()` is a synonym for `USER()`.

- `SYSTEM_USER()`

`SYSTEM_USER()` is a synonym for `USER()`.

- `USER()`

Returns the current MySQL user name and host name as a string in the `utf8` character set.

```
mysql> SELECT USER();
-> 'davida@localhost'
```

The value indicates the user name you specified when connecting to the server, and the client host from which you connected. The value can be different from that of `CURRENT_USER()`.

You can extract only the user name part like this:

```
mysql> SELECT SUBSTRING_INDEX(USER(), '@', 1);
-> 'davida'
```

- `VERSION()`

Returns a string that indicates the MySQL server version. The string uses the `utf8` character set.

```
mysql> SELECT VERSION();
-> '5.1.36-standard'
```

Note that if your version string ends with `-log` this means that logging is enabled.

## 11.11.4. Miscellaneous Functions

Name	Description
<code>DEFAULT()</code>	Return the default value for a table column



Name	Description
<code>GET_LOCK()</code>	Get a named lock
<code>INET_ATON()</code>	Return the numeric value of an IP address
<code>INET_NTOA()</code>	Return the IP address from a numeric value
<code>IS_FREE_LOCK()</code>	Checks whether the named lock is free
<code>IS_USED_LOCK()</code> (v4.1.0)	Checks whether the named lock is in use. Return connection identifier if true.
<code>MASTER_POS_WAIT()</code>	Block until the slave has read and applied all updates up to the specified position
<code>NAME_CONST()</code> (v5.0.12)	Causes the column to have the given name
<code>RAND()</code>	Return a random floating-point value
<code>RELEASE_LOCK()</code>	Releases the named lock
<code>SLEEP()</code> (v5.0.12)	Sleep for a number of seconds
<code>UUID_SHORT()</code> (v5.1.20)	Return an integer-valued universal identifier
<code>UUID()</code> (v4.1.2)	Return a Universal Unique Identifier (UUID)
<code>VALUES()</code> (v4.1.1)	Defines the values to be used during an INSERT

- `DEFAULT(col_name)`

Returns the default value for a table column. An error results if the column has no default value.

```
mysql> UPDATE t SET i = DEFAULT(i)+1 WHERE id < 100;
```

- `FORMAT(X,D)`

Formats the number *X* to a format like '#,###,###.##', rounded to *D* decimal places, and returns the result as a string. For details, see [Section 11.4, “String Functions”](#).

- `GET_LOCK(str,timeout)`

Tries to obtain a lock with a name given by the string *str*, using a timeout of *timeout* seconds. Returns `1` if the lock was obtained successfully, `0` if the attempt timed out (for example, because another client has previously locked the name), or `NULL` if an error occurred (such as running out of memory or the thread was killed with `mysqladmin kill`). If you have a lock obtained with `GET_LOCK()`, it is released when you execute `RELEASE_LOCK()`, execute a new `GET_LOCK()`, or your connection terminates (either normally or abnormally). Locks obtained with `GET_LOCK()` do not interact with transactions. That is, committing a transaction does not release any such locks obtained during the transaction.

This function can be used to implement application locks or to simulate record locks. Names are locked on a server-wide basis. If a name has been locked by one client, `GET_LOCK()` blocks any request by another client for a lock with the same name. This allows clients that agree on a given lock name to use the name to perform cooperative advisory locking. But be aware that it also allows a client that is not among the set of cooperating clients to lock a name, either inadvertently or deliberately, and thus prevent any of the cooperating clients from locking that name. One way to reduce the likelihood of this is to use lock names that are database-specific or application-specific. For example, use lock names of the form `db_name.str` or `app_name.str`.

```
mysql> SELECT GET_LOCK('lock1',10);
-> 1
mysql> SELECT IS_FREE_LOCK('lock2');
-> 1
mysql> SELECT GET_LOCK('lock2',10);
-> 1
mysql> SELECT RELEASE_LOCK('lock2');
-> 1
mysql> SELECT RELEASE_LOCK('lock1');
-> NULL
```

The second `RELEASE_LOCK()` call returns `NULL` because the lock 'lock1' was automatically released by the second `GET_LOCK()` call.

If multiple clients are waiting for a lock, the order in which they will acquire it is undefined and depends on factors such as the thread library in use. In particular, applications should not assume that clients will acquire the lock in the same order that they issued the lock requests.

### Note

If a client attempts to acquire a lock that is already held by another client, it blocks according to the *timeout* argument. If the blocked client terminates, its thread does not die until the lock request times out. This is a known bug (fixed in MySQL 6.0).

- `INET_ATON(expr)`

Given the dotted-quad representation of a network address as a string, returns an integer that represents the numeric value of the address. Addresses may be 4- or 8-byte addresses.

```
mysql> SELECT INET_ATON('209.207.224.40');
-> 3520061480
```

The generated number is always in network byte order. For the example just shown, the number is calculated as  $209 \times 256^3 + 207 \times 256^2 + 224 \times 256 + 40$ .

`INET_ATON()` also understands short-form IP addresses:

```
mysql> SELECT INET_ATON('127.0.0.1'), INET_ATON('127.1');
-> 2130706433, 2130706433
```

### Note

When storing values generated by `INET_ATON()`, it is recommended that you use an `INT UNSIGNED` column. If you use a (signed) `INT` column, values corresponding to IP addresses for which the first octet is greater than 127 cannot be stored correctly. See [Section 10.2, “Numeric Types”](#).

- `INET_NTOA(expr)`

Given a numeric network address in network byte order (4 or 8 byte), returns the dotted-quad representation of the address as a string.

```
mysql> SELECT INET_NTOA(3520061480);
-> '209.207.224.40'
```

- `IS_FREE_LOCK(str)`

Checks whether the lock named *str* is free to use (that is, not locked). Returns `1` if the lock is free (no one is using the lock), `0` if the lock is in use, and `NULL` if an error occurs (such as an incorrect argument).

- `IS_USED_LOCK(str)`

Checks whether the lock named *str* is in use (that is, locked). If so, it returns the connection identifier of the client that holds the lock. Otherwise, it returns `NULL`.

- `MASTER_POS_WAIT(log_name, log_pos[, timeout])`

This function is useful for control of master/slave synchronization. It blocks until the slave has read and applied all updates up to the specified position in the master log. The return value is the number of log events the slave had to wait for to advance to the specified position. The function returns `NULL` if the slave SQL thread is not started, the slave's master information is not initialized, the arguments are incorrect, or an error occurs. It returns `-1` if the timeout has been exceeded. If the slave SQL thread stops while `MASTER_POS_WAIT()` is waiting, the function returns `NULL`. If the slave is past the specified position, the function returns immediately.

If a *timeout* value is specified, `MASTER_POS_WAIT()` stops waiting when *timeout* seconds have elapsed. *timeout* must be greater than 0; a zero or negative *timeout* means no timeout.

- `NAME_CONST(name, value)`

Returns the given value. When used to produce a result set column, `NAME_CONST()` causes the column to have the given name. The arguments should be constants.

```
mysql> SELECT NAME_CONST('myname', 14);
+-----+
| myname |
+-----+
|      14 |
+-----+
```

This function was added in MySQL 5.0.12. It is for internal use only. The server uses it when writing statements from stored programs that contain references to local program variables, as described in [Section 18.6, “Binary Logging of Stored](#)

, You might see this function in the output from `mysqlbinlog`.

- `RELEASE_LOCK(str)`

Releases the lock named by the string `str` that was obtained with `GET_LOCK()`. Returns `1` if the lock was released, `0` if the lock was not established by this thread (in which case the lock is not released), and `NULL` if the named lock did not exist. The lock does not exist if it was never obtained by a call to `GET_LOCK()` or if it has previously been released.

The `DO` statement is convenient to use with `RELEASE_LOCK()`. See [Section 12.2.3, “DO Syntax”](#).

- `SLEEP(duration)`

Sleeps (pauses) for the number of seconds given by the `duration` argument, then returns `0`. If `SLEEP()` is interrupted, it returns `1`. The duration may have a fractional part given in microseconds.

- `UUID()`

Returns a Universal Unique Identifier (UUID) generated according to “DCE 1.1: Remote Procedure Call” (Appendix A) CAE (Common Applications Environment) Specifications published by The Open Group in October 1997 (Document Number C706, <http://www.opengroup.org/public/pubs/catalog/c706.htm>).

A UUID is designed as a number that is globally unique in space and time. Two calls to `UUID()` are expected to generate two different values, even if these calls are performed on two separate computers that are not connected to each other.

A UUID is a 128-bit number represented by a `utf8` string of five hexadecimal numbers in `aaaaaaa-bbbb-cccc-dddd-eeeeeeeeeeee` format:

- The first three numbers are generated from a timestamp.
- The fourth number preserves temporal uniqueness in case the timestamp value loses monotonicity (for example, due to day-light saving time).
- The fifth number is an IEEE 802 node number that provides spatial uniqueness. A random number is substituted if the latter is not available (for example, because the host computer has no Ethernet card, or we do not know how to find the hardware address of an interface on your operating system). In this case, spatial uniqueness cannot be guaranteed. Nevertheless, a collision should have *very* low probability.

Currently, the MAC address of an interface is taken into account only on FreeBSD and Linux. On other operating systems, MySQL uses a randomly generated 48-bit number.

```
mysql> SELECT UUID();
-> '6ccd780c-baba-1026-9564-0040f4311e29'
```

### Warning

The `UUID()` function returns a string using the character set defined by the `character_set_server` parameter. If you are using UUID values in your tables and these columns are indexed the character set of your column or table should match the character set used when the `UUID()` was called. If you do not use the same character set for the column and the UUID value, then the indexes on those columns will not be used, which may lead to a reduction in performance and locked tables during operations as the table is searched sequentially for the value.

You can convert between different character sets when using UUID-based strings using the `CONVERT()` function.

### Note

`UUID()` does not work with statement-based replication.

- `UUID_SHORT()`

Returns a “short” universal identifier as a 64-bit unsigned integer (rather than a string-form 128-bit identifier as returned by the `UUID()` function).

The value of `UUID_SHORT()` is guaranteed to be unique if the following conditions hold:

- The `server_id` of the current host is unique among your set of master and slave servers
- `server_id` is between 0 and 255
- You don't set back your system time for your server between `mysqld` restarts
- You do not invoke `UUID_SHORT()` on average more than 16 million times per second between `mysqld` restarts

The `UUID_SHORT()` return value is constructed this way:

```
(server_id & 255) << 56
+ (server_startup_time_in_seconds << 24)
+ incremented_variable++;
```

```
mysql> SELECT UUID_SHORT();
-> 92395783831158784
```

Note that `UUID_SHORT()` does not work with statement-based replication.

This function was added in MySQL 5.1.20.

- `VALUES(col_name)`

In an `INSERT ... ON DUPLICATE KEY UPDATE` statement, you can use the `VALUES(col_name)` function in the `UPDATE` clause to refer to column values from the `INSERT` portion of the statement. In other words, `VALUES(col_name)` in the `UPDATE` clause refers to the value of `col_name` that would be inserted, had no duplicate-key conflict occurred. This function is especially useful in multiple-row inserts. The `VALUES()` function is meaningful only in `INSERT ... ON DUPLICATE KEY UPDATE` statements and returns `NULL` otherwise. [Section 12.2.5.3, “INSERT ... ON DUPLICATE KEY UPDATE Syntax”](#).

```
mysql> INSERT INTO table (a,b,c) VALUES (1,2,3),(4,5,6)
-> ON DUPLICATE KEY UPDATE c=VALUES(a)+VALUES(b);
```

## 11.12. Functions and Modifiers for Use with `GROUP BY` Clauses

### 11.12.1. `GROUP BY` (Aggregate) Functions

Name	Description
<code>AVG()</code>	Return the average value of the argument
<code>BIT_AND()</code>	Return bitwise and
<code>BIT_OR()</code>	Return bitwise or
<code>BIT_XOR()</code> (v4.1.1)	Return bitwise xor
<code>COUNT(DISTINCT)</code>	Return the count of a number of different values
<code>COUNT()</code>	Return a count of the number of rows returned
<code>GROUP_CONCAT()</code> (v4.1)	Return a concatenated string
<code>MAX()</code>	Return the maximum value
<code>MIN()</code>	Return the minimum value
<code>STD()</code>	Return the population standard deviation
<code>STDDEV_POP()</code> (v5.0.3)	Return the population standard deviation
<code>STDDEV_SAMP()</code> (v5.0.3)	Return the sample standard deviation
<code>STDDEV()</code>	Return the population standard deviation
<code>SUM()</code>	Return the sum
<code>VAR_POP()</code> (v5.0.3)	Return the population standard variance
<code>VAR_SAMP()</code> (v5.0.3)	Return the sample variance
<code>VARIANCE()</code> (v4.1)	Return the population standard variance

This section describes group (aggregate) functions that operate on sets of values. Unless otherwise stated, group functions ignore `NULL` values.

If you use a group function in a statement containing no `GROUP BY` clause, it is equivalent to grouping on all rows.

For numeric arguments, the variance and standard deviation functions return a `DOUBLE` value. The `SUM()` and `AVG()` functions return a `DECIMAL` value for exact-value arguments (integer or `DECIMAL`), and a `DOUBLE` value for approximate-value arguments (`FLOAT` or `DOUBLE`).

The `SUM()` and `AVG()` aggregate functions do not work with temporal values. (They convert the values to numbers, losing

everything after the first non-numeric character.) To work around this problem, you can convert to numeric units, perform the aggregate operation, and convert back to a temporal value. Examples:

```
SELECT SEC_TO_TIME(SUM(TIME_TO_SEC(time_col))) FROM tbl_name;
SELECT FROM_DAYS(SUM(TO_DAYS(date_col))) FROM tbl_name;
```

Functions such as `SUM()` or `AVG()` that expect a numeric argument cast the argument to a number if necessary. For `SET` or `ENUM` values, the cast operation causes the underlying numeric value to be used.

- `AVG([DISTINCT] expr)`

Returns the average value of *expr*. The `DISTINCT` option can be used to return the average of the distinct values of *expr*.

`AVG()` returns `NULL` if there were no matching rows.

```
mysql> SELECT student_name, AVG(test_score)
-> FROM student
-> GROUP BY student_name;
```

- `BIT_AND(expr)`

Returns the bitwise `AND` of all bits in *expr*. The calculation is performed with 64-bit (`BIGINT`) precision.

This function returns `18446744073709551615` if there were no matching rows. (This is the value of an unsigned `BIGINT` value with all bits set to 1.)

- `BIT_OR(expr)`

Returns the bitwise `OR` of all bits in *expr*. The calculation is performed with 64-bit (`BIGINT`) precision.

This function returns `0` if there were no matching rows.

- `BIT_XOR(expr)`

Returns the bitwise `XOR` of all bits in *expr*. The calculation is performed with 64-bit (`BIGINT`) precision.

This function returns `0` if there were no matching rows.

- `COUNT(expr)`

Returns a count of the number of non-`NULL` values of *expr* in the rows retrieved by a `SELECT` statement. The result is a `BIGINT` value.

`COUNT()` returns `0` if there were no matching rows.

```
mysql> SELECT student.student_name, COUNT(*)
-> FROM student, course
-> WHERE student.student_id=course.student_id
-> GROUP BY student_name;
```

`COUNT(*)` is somewhat different in that it returns a count of the number of rows retrieved, whether or not they contain `NULL` values.

`COUNT(*)` is optimized to return very quickly if the `SELECT` retrieves from one table, no other columns are retrieved, and there is no `WHERE` clause. For example:

```
mysql> SELECT COUNT(*) FROM student;
```

This optimization applies only to `MyISAM` tables only, because an exact row count is stored for this storage engine and can be accessed very quickly. For transactional storage engines such as `InnoDB`, storing an exact row count is more problematic because multiple transactions may be occurring, each of which may affect the count.

- `COUNT(DISTINCT expr, [expr...])`

Returns a count of the number of different non-`NULL` values.

`COUNT(DISTINCT)` returns `0` if there were no matching rows.

```
mysql> SELECT COUNT(DISTINCT results) FROM student;
```

In MySQL, you can obtain the number of distinct expression combinations that do not contain `NULL` by giving a list of expres-

sions. In standard SQL, you would have to do a concatenation of all expressions inside `COUNT(DISTINCT ...)`.

- `GROUP_CONCAT(expr)`

This function returns a string result with the concatenated non-NULL values from a group. It returns NULL if there are no non-NULL values. The full syntax is as follows:

```
GROUP_CONCAT([DISTINCT] expr [,expr ...]
             [ORDER BY {unsigned_integer | col_name | expr}
              [ASC | DESC] [,col_name ...]]
             [SEPARATOR str_val])
```

```
mysql> SELECT student_name,
->        GROUP_CONCAT(test_score)
->        FROM student
->        GROUP BY student_name;
```

Or:

```
mysql> SELECT student_name,
->        GROUP_CONCAT(DISTINCT test_score
->                      ORDER BY test_score DESC SEPARATOR ' ')
->        FROM student
->        GROUP BY student_name;
```

In MySQL, you can get the concatenated values of expression combinations. You can eliminate duplicate values by using `DISTINCT`. If you want to sort values in the result, you should use `ORDER BY` clause. To sort in reverse order, add the `DESC` (descending) keyword to the name of the column you are sorting by in the `ORDER BY` clause. The default is ascending order; this may be specified explicitly using the `ASC` keyword. `SEPARATOR` is followed by the string value that should be inserted between values of result. The default is a comma (“,”). You can eliminate the separator altogether by specifying `SEPARATOR ''`.

The result is truncated to the maximum length that is given by the `group_concat_max_len` system variable, which has a default value of 1024. The value can be set higher, although the effective maximum length of the return value is constrained by the value of `max_allowed_packet`. The syntax to change the value of `group_concat_max_len` at runtime is as follows, where `val` is an unsigned integer:

```
SET [GLOBAL | SESSION] group_concat_max_len = val;
```

See also `CONCAT()` and `CONCAT_WS()`: [Section 11.4, “String Functions”](#).

- `MAX([DISTINCT] expr)`

Returns the maximum value of `expr`. `MAX()` may take a string argument; in such cases, it returns the maximum string value. See [Section 7.4.4, “How MySQL Uses Indexes”](#). The `DISTINCT` keyword can be used to find the maximum of the distinct values of `expr`, however, this produces the same result as omitting `DISTINCT`.

`MAX()` returns NULL if there were no matching rows.

```
mysql> SELECT student_name, MIN(test_score), MAX(test_score)
->        FROM student
->        GROUP BY student_name;
```

For `MAX()`, MySQL currently compares `ENUM` and `SET` columns by their string value rather than by the string's relative position in the set. This differs from how `ORDER BY` compares them. This is expected to be rectified in a future MySQL release.

- `MIN([DISTINCT] expr)`

Returns the minimum value of `expr`. `MIN()` may take a string argument; in such cases, it returns the minimum string value. See [Section 7.4.4, “How MySQL Uses Indexes”](#). The `DISTINCT` keyword can be used to find the minimum of the distinct values of `expr`, however, this produces the same result as omitting `DISTINCT`.

`MIN()` returns NULL if there were no matching rows.

```
mysql> SELECT student_name, MIN(test_score), MAX(test_score)
->        FROM student
->        GROUP BY student_name;
```

For `MIN()`, MySQL currently compares `ENUM` and `SET` columns by their string value rather than by the string's relative position in the set. This differs from how `ORDER BY` compares them. This is expected to be rectified in a future MySQL release.

- `STD(expr)`

Returns the population standard deviation of *expr*. This is an extension to standard SQL. The standard SQL function `STDDEV_POP()` can be used instead.

This function returns `NULL` if there were no matching rows.

- `STDDEV(expr)`

Returns the population standard deviation of *expr*. This function is provided for compatibility with Oracle. The standard SQL function `STDDEV_POP()` can be used instead.

This function returns `NULL` if there were no matching rows.

- `STDDEV_POP(expr)`

Returns the population standard deviation of *expr* (the square root of `VAR_POP()`). You can also use `STD()` or `STDDEV()`, which are equivalent but not standard SQL.

`STDDEV_POP()` returns `NULL` if there were no matching rows.

- `STDDEV_SAMP(expr)`

Returns the sample standard deviation of *expr* (the square root of `VAR_SAMP()`).

`STDDEV_SAMP()` returns `NULL` if there were no matching rows.

- `SUM([DISTINCT] expr)`

Returns the sum of *expr*. If the return set has no rows, `SUM()` returns `NULL`. The `DISTINCT` keyword can be used in MySQL 5.1 to sum only the distinct values of *expr*.

`SUM()` returns `NULL` if there were no matching rows.

- `VAR_POP(expr)`

Returns the population standard variance of *expr*. It considers rows as the whole population, not as a sample, so it has the number of rows as the denominator. You can also use `VARIANCE()`, which is equivalent but is not standard SQL.

`VAR_POP()` returns `NULL` if there were no matching rows.

- `VAR_SAMP(expr)`

Returns the sample variance of *expr*. That is, the denominator is the number of rows minus one.

`VAR_SAMP()` returns `NULL` if there were no matching rows.

- `VARIANCE(expr)`

Returns the population standard variance of *expr*. This is an extension to standard SQL. The standard SQL function `VAR_POP()` can be used instead.

`VARIANCE()` returns `NULL` if there were no matching rows.

## 11.12.2. GROUP BY Modifiers

The `GROUP BY` clause allows a `WITH ROLLUP` modifier that causes extra rows to be added to the summary output. These rows represent higher-level (or super-aggregate) summary operations. `ROLLUP` thus allows you to answer questions at multiple levels of analysis with a single query. It can be used, for example, to provide support for OLAP (Online Analytical Processing) operations.

Suppose that a table named `sales` has `year`, `country`, `product`, and `profit` columns for recording sales profitability:

```
CREATE TABLE sales
(
  year      INT NOT NULL,
  country   VARCHAR(20) NOT NULL,
  product   VARCHAR(32) NOT NULL,
  profit    INT
);
```

The table's contents can be summarized per year with a simple `GROUP BY` like this:

```
mysql> SELECT year, SUM(profit) FROM sales GROUP BY year;
```

year	SUM(profit)
2000	4525
2001	3010

This output shows the total profit for each year, but if you also want to determine the total profit summed over all years, you must add up the individual values yourself or run an additional query.

Or you can use `ROLLUP`, which provides both levels of analysis with a single query. Adding a `WITH ROLLUP` modifier to the `GROUP BY` clause causes the query to produce another row that shows the grand total over all year values:

```
mysql> SELECT year, SUM(profit) FROM sales GROUP BY year WITH ROLLUP;
```

year	SUM(profit)
2000	4525
2001	3010
NULL	7535

The grand total super-aggregate line is identified by the value `NULL` in the `year` column.

`ROLLUP` has a more complex effect when there are multiple `GROUP BY` columns. In this case, each time there is a “break” (change in value) in any but the last grouping column, the query produces an extra super-aggregate summary row.

For example, without `ROLLUP`, a summary on the `sales` table based on `year`, `country`, and `product` might look like this:

```
mysql> SELECT year, country, product, SUM(profit)
-> FROM sales
-> GROUP BY year, country, product;
```

year	country	product	SUM(profit)
2000	Finland	Computer	1500
2000	Finland	Phone	100
2000	India	Calculator	150
2000	India	Computer	1200
2000	USA	Calculator	75
2000	USA	Computer	1500
2001	Finland	Phone	10
2001	USA	Calculator	50
2001	USA	Computer	2700
2001	USA	TV	250

The output indicates summary values only at the year/country/product level of analysis. When `ROLLUP` is added, the query produces several extra rows:

```
mysql> SELECT year, country, product, SUM(profit)
-> FROM sales
-> GROUP BY year, country, product WITH ROLLUP;
```

year	country	product	SUM(profit)
2000	Finland	Computer	1500
2000	Finland	Phone	100
2000	Finland	NULL	1600
2000	India	Calculator	150
2000	India	Computer	1200
2000	India	NULL	1350
2000	USA	Calculator	75
2000	USA	Computer	1500
2000	USA	NULL	1575
2000	NULL	NULL	4525
2001	Finland	Phone	10
2001	Finland	NULL	10
2001	USA	Calculator	50
2001	USA	Computer	2700
2001	USA	TV	250
2001	USA	NULL	3000
2001	NULL	NULL	3010
NULL	NULL	NULL	7535

For this query, adding `ROLLUP` causes the output to include summary information at four levels of analysis, not just one. Here is how to interpret the `ROLLUP` output:

- Following each set of product rows for a given year and country, an extra summary row is produced showing the total for all products. These rows have the `product` column set to `NULL`.
- Following each set of rows for a given year, an extra summary row is produced showing the total for all countries and products.



These rows have the `country` and `products` columns set to `NULL`.

- Finally, following all other rows, an extra summary row is produced showing the grand total for all years, countries, and products. This row has the `year`, `country`, and `products` columns set to `NULL`.

### Other Considerations When using `ROLLUP`

The following items list some behaviors specific to the MySQL implementation of `ROLLUP`:

When you use `ROLLUP`, you cannot also use an `ORDER BY` clause to sort the results. In other words, `ROLLUP` and `ORDER BY` are mutually exclusive. However, you still have some control over sort order. `GROUP BY` in MySQL sorts results, and you can use explicit `ASC` and `DESC` keywords with columns named in the `GROUP BY` list to specify sort order for individual columns. (The high-level summary rows added by `ROLLUP` still appear after the rows from which they are calculated, regardless of the sort order.)

`LIMIT` can be used to restrict the number of rows returned to the client. `LIMIT` is applied after `ROLLUP`, so the limit applies against the extra rows added by `ROLLUP`. For example:

```
mysql> SELECT year, country, product, SUM(profit)
-> FROM sales
-> GROUP BY year, country, product WITH ROLLUP
-> LIMIT 5;
```

year	country	product	SUM(profit)
2000	Finland	Computer	1500
2000	Finland	Phone	100
2000	Finland	NULL	1600
2000	India	Calculator	150
2000	India	Computer	1200

Using `LIMIT` with `ROLLUP` may produce results that are more difficult to interpret, because you have less context for understanding the super-aggregate rows.

The `NULL` indicators in each super-aggregate row are produced when the row is sent to the client. The server looks at the columns named in the `GROUP BY` clause following the leftmost one that has changed value. For any column in the result set with a name that is a lexical match to any of those names, its value is set to `NULL`. (If you specify grouping columns by column number, the server identifies which columns to set to `NULL` by number.)

Because the `NULL` values in the super-aggregate rows are placed into the result set at such a late stage in query processing, you cannot test them as `NULL` values within the query itself. For example, you cannot add `HAVING product IS NULL` to the query to eliminate from the output all but the super-aggregate rows.

On the other hand, the `NULL` values do appear as `NULL` on the client side and can be tested as such using any MySQL client programming interface.

## 11.12.3. `GROUP BY` and `HAVING` with Hidden Columns

MySQL extends the use of `GROUP BY` so that you can use non-aggregated columns or calculations in the `SELECT` list that do not appear in the `GROUP BY` clause. You can use this feature to get better performance by avoiding unnecessary column sorting and grouping. For example, you do not need to group on `customer.name` in the following query:

```
SELECT order.custid, customer.name, MAX(payments)
FROM order, customer
WHERE order.custid = customer.custid
GROUP BY order.custid;
```

In standard SQL, you would have to add `customer.name` to the `GROUP BY` clause. In MySQL, the name is redundant.

Do *not* use this feature if the columns you omit from the `GROUP BY` part are not constant in the group. The server is free to return any value from the group, so the results are indeterminate unless all values are the same.

A similar MySQL extension applies to the `HAVING` clause. The SQL standard does not allow the `HAVING` clause to name any column that is not found in the `GROUP BY` clause if it is not enclosed in an aggregate function. MySQL allows the use of such columns to simplify calculations. This extension assumes that the non-grouped columns will have the same group-wise values. Otherwise, the result is indeterminate.

If the `ONLY_FULL_GROUP_BY` SQL mode is enabled, the MySQL extension to `GROUP BY` does not apply. That is, columns not named in the `GROUP BY` clause cannot be used in the `SELECT` list or `HAVING` clause if not used in an aggregate function.

The select list extension also applies to `ORDER BY`. That is, you can use non-aggregated columns or calculations in the `ORDER BY` clause that do not appear in the `GROUP BY` clause. This extension does not apply if the `ONLY_FULL_GROUP_BY` SQL mode

is enabled.

In some cases, you can use `MIN()` and `MAX()` to obtain a specific column value even if it isn't unique. The following gives the value of `column` from the row containing the smallest value in the `sort` column:

```
SUBSTR(MIN(CONCAT(RPAD(sort,6,' '),column)),7)
```

See Section 3.6.4, “The Rows Holding the Group-wise Maximum of a Certain Field”.

Note that if you are trying to follow standard SQL, you can't use expressions in `GROUP BY` clauses. You can work around this limitation by using an alias for the expression:

```
SELECT id,FLOOR(value/100) AS val
FROM tbl_name
GROUP BY id, val;
```

MySQL does allow expressions in `GROUP BY` clauses. For example:

```
SELECT id,FLOOR(value/100)
FROM tbl_name
GROUP BY id, FLOOR(value/100);
```

## 11.13. Spatial Extensions

MySQL supports spatial extensions to allow the generation, storage, and analysis of geographic features. These features are available for `MyISAM`, `InnoDB`, `NDB`, and `ARCHIVE` tables.

For spatial columns, `MyISAM` supports both `SPATIAL` and non-`SPATIAL` indexes. Other storage engines support non-`SPATIAL` indexes, as described in Section 12.1.13, “`CREATE INDEX Syntax`”.

This chapter covers the following topics:

- The basis of these spatial extensions in the OpenGIS geometry model
- Data formats for representing spatial data
- How to use spatial data in MySQL
- Use of indexing for spatial data
- MySQL differences from the OpenGIS specification

### Additional resources

- The Open Geospatial Consortium publishes the *OpenGIS® Simple Features Specifications For SQL*, a document that proposes several conceptual ways for extending an SQL RDBMS to support spatial data. This specification is available from the OGC Web site at <http://www.opengis.org/docs/99-049.pdf>.
- If you have questions or concerns about the use of the spatial extensions to MySQL, you can discuss them in the GIS forum: <http://forums.mysql.com/list.php?23>.

### 11.13.1. Introduction to MySQL Spatial Support

MySQL implements spatial extensions following the specification of the Open Geospatial Consortium (OGC). This is an international consortium of more than 250 companies, agencies, and universities participating in the development of publicly available conceptual solutions that can be useful with all kinds of applications that manage spatial data. The OGC maintains a Web site at <http://www.opengis.org/>.

In 1997, the Open Geospatial Consortium published the *OpenGIS® Simple Features Specifications For SQL*, a document that proposes several conceptual ways for extending an SQL RDBMS to support spatial data. This specification is available from the OGC Web site at <http://www.opengis.org/docs/99-049.pdf>. It contains additional information relevant to this chapter.

MySQL implements a subset of the **SQL with Geometry Types** environment proposed by OGC. This term refers to an SQL environment that has been extended with a set of geometry types. A geometry-valued SQL column is implemented as a column that has a geometry type. The specification describe a set of SQL geometry types, as well as functions on those types to create and analyze geometry values.

A **geographic feature** is anything in the world that has a location. A feature can be:

- An entity. For example, a mountain, a pond, a city.
- A space. For example, town district, the tropics.
- A definable location. For example, a crossroad, as a particular place where two streets intersect.

Some documents use the term **geospatial feature** to refer to geographic features.

**Geometry** is another word that denotes a geographic feature. Originally the word **geometry** meant measurement of the earth. Another meaning comes from cartography, referring to the geometric features that cartographers use to map the world.

This chapter uses all of these terms synonymously: **geographic feature**, **geospatial feature**, **feature**, or **geometry**. Here, the term most commonly used is **geometry**, defined as *a point or an aggregate of points representing anything in the world that has a location*.

## 11.13.2. The OpenGIS Geometry Model

The set of geometry types proposed by OGC's **SQL with Geometry Types** environment is based on the **OpenGIS Geometry Model**. In this model, each geometric object has the following general properties:

- It is associated with a Spatial Reference System, which describes the coordinate space in which the object is defined.
- It belongs to some geometry class.

### 11.13.2.1. The Geometry Class Hierarchy

The geometry classes define a hierarchy as follows:

- `Geometry` (non-instantiable)
  - `Point` (instantiable)
  - `Curve` (non-instantiable)
    - `LineString` (instantiable)
      - `Line`
      - `LinearRing`
  - `Surface` (non-instantiable)
    - `Polygon` (instantiable)
  - `GeometryCollection` (instantiable)
    - `MultiPoint` (instantiable)
    - `MultiCurve` (non-instantiable)
      - `MultiLineString` (instantiable)
    - `MultiSurface` (non-instantiable)
      - `MultiPolygon` (instantiable)

It is not possible to create objects in non-instantiable classes. It is possible to create objects in instantiable classes. All classes have properties, and instantiable classes may also have assertions (rules that define valid class instances).

`Geometry` is the base class. It is an abstract class. The instantiable subclasses of `Geometry` are restricted to zero-, one-, and two-dimensional geometric objects that exist in two-dimensional coordinate space. All instantiable geometry classes are defined so that valid instances of a geometry class are topologically closed (that is, all defined geometries include their boundary).

The base `Geometry` class has subclasses for `Point`, `Curve`, `Surface`, and `GeometryCollection`:

- `Point` represents zero-dimensional objects.
- `Curve` represents one-dimensional objects, and has subclass `LineString`, with sub-subclasses `Line` and `LinearRing`.
- `Surface` is designed for two-dimensional objects and has subclass `Polygon`.
- `GeometryCollection` has specialized zero-, one-, and two-dimensional collection classes named `MultiPoint`, `MultiLineString`, and `MultiPolygon` for modeling geometries corresponding to collections of `Points`, `LineStrings`, and `Polygons`, respectively. `MultiCurve` and `MultiSurface` are introduced as abstract superclasses that generalize the collection interfaces to handle `Curves` and `Surfaces`.

`Geometry`, `Curve`, `Surface`, `MultiCurve`, and `MultiSurface` are defined as non-instantiable classes. They define a common set of methods for their subclasses and are included for extensibility.

`Point`, `LineString`, `Polygon`, `GeometryCollection`, `MultiPoint`, `MultiLineString`, and `MultiPolygon` are instantiable classes.

### 11.13.2.2. Class `Geometry`

`Geometry` is the root class of the hierarchy. It is a non-instantiable class but has a number of properties that are common to all geometry values created from any of the `Geometry` subclasses. These properties are described in the following list. Particular subclasses have their own specific properties, described later.

#### Geometry Properties

A geometry value has the following properties:

- Its **type**. Each geometry belongs to one of the instantiable classes in the hierarchy.
- Its **SRID**, or Spatial Reference Identifier. This value identifies the geometry's associated Spatial Reference System that describes the coordinate space in which the geometry object is defined.
 

In MySQL, the SRID value is just an integer associated with the geometry value. All calculations are done assuming Euclidean (planar) geometry.
- Its **coordinates** in its Spatial Reference System, represented as double-precision (eight-byte) numbers. All non-empty geometries include at least one pair of (X,Y) coordinates. Empty geometries contain no coordinates.
 

Coordinates are related to the SRID. For example, in different coordinate systems, the distance between two objects may differ even when objects have the same coordinates, because the distance on the **planar** coordinate system and the distance on the **geocentric** system (coordinates on the Earth's surface) are different things.
- Its **interior, boundary, and exterior**.
 

Every geometry occupies some position in space. The exterior of a geometry is all space not occupied by the geometry. The interior is the space occupied by the geometry. The boundary is the interface between the geometry's interior and exterior.
- Its **MBR** (Minimum Bounding Rectangle), or Envelope. This is the bounding geometry, formed by the minimum and maximum (X,Y) coordinates:
 

```
((MINX MINY, MAXX MINY, MAXX MAXY, MINX MAXY, MINX MINY))
```
- Whether the value is **simple** or **non-simple**. Geometry values of types (`LineString`, `MultiPoint`, `MultiLineString`) are either simple or non-simple. Each type determines its own assertions for being simple or non-simple.
- Whether the value is **closed** or **not closed**. Geometry values of types (`LineString`, `MultiString`) are either closed or not closed. Each type determines its own assertions for being closed or not closed.
- Whether the value is **empty** or **non-empty**. A geometry is empty if it does not have any points. Exterior, interior, and boundary of an empty geometry are not defined (that is, they are represented by a `NULL` value). An empty geometry is defined to be always simple and has an area of 0.
- Its **dimension**. A geometry can have a dimension of -1, 0, 1, or 2:
  - -1 for an empty geometry.

- 0 for a geometry with no length and no area.
- 1 for a geometry with nonzero length and zero area.
- 2 for a geometry with nonzero area.

`Point` objects have a dimension of zero. `LineString` objects have a dimension of 1. `Polygon` objects have a dimension of 2. The dimensions of `MultiPoint`, `MultiLineString`, and `MultiPolygon` objects are the same as the dimensions of the elements they consist of.

### 11.13.2.3. Class `Point`

A `Point` is a geometry that represents a single location in coordinate space.

#### `Point` Examples

- Imagine a large-scale map of the world with many cities. A `Point` object could represent each city.
- On a city map, a `Point` object could represent a bus stop.

#### `Point` Properties

- X-coordinate value.
- Y-coordinate value.
- `Point` is defined as a zero-dimensional geometry.
- The boundary of a `Point` is the empty set.

### 11.13.2.4. Class `Curve`

A `Curve` is a one-dimensional geometry, usually represented by a sequence of points. Particular subclasses of `Curve` define the type of interpolation between points. `Curve` is a non-instantiable class.

#### `Curve` Properties

- A `Curve` has the coordinates of its points.
- A `Curve` is defined as a one-dimensional geometry.
- A `Curve` is simple if it does not pass through the same point twice.
- A `Curve` is closed if its start point is equal to its endpoint.
- The boundary of a closed `Curve` is empty.
- The boundary of a non-closed `Curve` consists of its two endpoints.
- A `Curve` that is simple and closed is a `LinearRing`.

### 11.13.2.5. Class `LineString`

A `LineString` is a `Curve` with linear interpolation between points.

#### `LineString` Examples

- On a world map, `LineString` objects could represent rivers.
- In a city map, `LineString` objects could represent streets.

### LineString Properties

- A `LineString` has coordinates of segments, defined by each consecutive pair of points.
- A `LineString` is a `Line` if it consists of exactly two points.
- A `LineString` is a `LinearRing` if it is both closed and simple.

### 11.13.2.6. Class Surface

A `Surface` is a two-dimensional geometry. It is a non-instantiable class. Its only instantiable subclass is `Polygon`.

#### Surface Properties

- A `Surface` is defined as a two-dimensional geometry.
- The OpenGIS specification defines a simple `Surface` as a geometry that consists of a single “patch” that is associated with a single exterior boundary and zero or more interior boundaries.
- The boundary of a simple `Surface` is the set of closed curves corresponding to its exterior and interior boundaries.

### 11.13.2.7. Class Polygon

A `Polygon` is a planar `Surface` representing a multisided geometry. It is defined by a single exterior boundary and zero or more interior boundaries, where each interior boundary defines a hole in the `Polygon`.

#### Polygon Examples

- On a region map, `Polygon` objects could represent forests, districts, and so on.

#### Polygon Assertions

- The boundary of a `Polygon` consists of a set of `LinearRing` objects (that is, `LineString` objects that are both simple and closed) that make up its exterior and interior boundaries.
- A `Polygon` has no rings that cross. The rings in the boundary of a `Polygon` may intersect at a `Point`, but only as a tangent.
- A `Polygon` has no lines, spikes, or punctures.
- A `Polygon` has an interior that is a connected point set.
- A `Polygon` may have holes. The exterior of a `Polygon` with holes is not connected. Each hole defines a connected component of the exterior.

The preceding assertions make a `Polygon` a simple geometry.

### 11.13.2.8. Class GeometryCollection

A `GeometryCollection` is a geometry that is a collection of one or more geometries of any class.

All the elements in a `GeometryCollection` must be in the same Spatial Reference System (that is, in the same coordinate system). There are no other constraints on the elements of a `GeometryCollection`, although the subclasses of `GeometryCollection` described in the following sections may restrict membership. Restrictions may be based on:

- Element type (for example, a `MultiPoint` may contain only `Point` elements)
- Dimension
- Constraints on the degree of spatial overlap between elements

### 11.13.2.9. Class MultiPoint

A `MultiPoint` is a geometry collection composed of `Point` elements. The points are not connected or ordered in any way.

#### `MultiPoint` Examples

- On a world map, a `MultiPoint` could represent a chain of small islands.
- On a city map, a `MultiPoint` could represent the outlets for a ticket office.

#### `MultiPoint` Properties

- A `MultiPoint` is a zero-dimensional geometry.
- A `MultiPoint` is simple if no two of its `Point` values are equal (have identical coordinate values).
- The boundary of a `MultiPoint` is the empty set.

### 11.13.2.10. Class `MultiCurve`

A `MultiCurve` is a geometry collection composed of `Curve` elements. `MultiCurve` is a non-instantiable class.

#### `MultiCurve` Properties

- A `MultiCurve` is a one-dimensional geometry.
- A `MultiCurve` is simple if and only if all of its elements are simple; the only intersections between any two elements occur at points that are on the boundaries of both elements.
- A `MultiCurve` boundary is obtained by applying the “mod 2 union rule” (also known as the “odd-even rule”): A point is in the boundary of a `MultiCurve` if it is in the boundaries of an odd number of `MultiCurve` elements.
- A `MultiCurve` is closed if all of its elements are closed.
- The boundary of a closed `MultiCurve` is always empty.

### 11.13.2.11. Class `MultiLineString`

A `MultiLineString` is a `MultiCurve` geometry collection composed of `LineString` elements.

#### `MultiLineString` Examples

- On a region map, a `MultiLineString` could represent a river system or a highway system.

### 11.13.2.12. Class `MultiSurface`

A `MultiSurface` is a geometry collection composed of surface elements. `MultiSurface` is a non-instantiable class. Its only instantiable subclass is `MultiPolygon`.

#### `MultiSurface` Assertions

- Two `MultiSurface` surfaces have no interiors that intersect.
- Two `MultiSurface` elements have boundaries that intersect at most at a finite number of points.

### 11.13.2.13. Class `MultiPolygon`

A `MultiPolygon` is a `MultiSurface` object composed of `Polygon` elements.

#### `MultiPolygon` Examples

- On a region map, a `MultiPolygon` could represent a system of lakes.

### MultiPolygon Assertions

- A `MultiPolygon` has no two `Polygon` elements with interiors that intersect.
- A `MultiPolygon` has no two `Polygon` elements that cross (crossing is also forbidden by the previous assertion), or that touch at an infinite number of points.
- A `MultiPolygon` may not have cut lines, spikes, or punctures. A `MultiPolygon` is a regular, closed point set.
- A `MultiPolygon` that has more than one `Polygon` has an interior that is not connected. The number of connected components of the interior of a `MultiPolygon` is equal to the number of `Polygon` values in the `MultiPolygon`.

### MultiPolygon Properties

- A `MultiPolygon` is a two-dimensional geometry.
- A `MultiPolygon` boundary is a set of closed curves (`LineString` values) corresponding to the boundaries of its `Polygon` elements.
- Each `Curve` in the boundary of the `MultiPolygon` is in the boundary of exactly one `Polygon` element.
- Every `Curve` in the boundary of an `Polygon` element is in the boundary of the `MultiPolygon`.

## 11.13.3. Supported Spatial Data Formats

This section describes the standard spatial data formats that are used to represent geometry objects in queries. They are:

- Well-Known Text (WKT) format
- Well-Known Binary (WKB) format

Internally, MySQL stores geometry values in a format that is not identical to either WKT or WKB format.

### 11.13.3.1. Well-Known Text (WKT) Format

The Well-Known Text (WKT) representation of Geometry is designed to exchange geometry data in ASCII form.

Examples of WKT representations of geometry objects:

- A `Point`:

```
POINT(15 20)
```

Note that point coordinates are specified with no separating comma.

- A `LineString` with four points:

```
LINESTRING(0 0, 10 10, 20 25, 50 60)
```

Note that point coordinate pairs are separated by commas.

- A `Polygon` with one exterior ring and one interior ring:

```
POLYGON((0 0,10 0,10 10,0 10,0 0),(5 5,7 5,7 7,5 7, 5 5))
```

- A `MultiPoint` with three `Point` values:

```
MULTIPOINT(0 0, 20 20, 60 60)
```

- A `MultiLineString` with two `LineString` values:

```
MULTILINESTRING((10 10, 20 20), (15 15, 30 15))
```



- A `MultiPolygon` with two `Polygon` values:

```
MULTIPOLYGON(((0 0,10 0,10 10,0 10,0 0)),((5 5,7 5,7 7,5 7, 5 5)))
```

- A `GeometryCollection` consisting of two `Point` values and one `LineString`:

```
GEOMETRYCOLLECTION(POINT(10 10), POINT(30 30), LINESTRING(15 15, 20 20))
```

A Backus-Naur grammar that specifies the formal production rules for writing WKT values can be found in the OpenGIS specification document referenced near the beginning of this chapter.

### 11.13.3.2. Well-Known Binary (WKB) Format

The Well-Known Binary (WKB) representation for geometric values is defined by the OpenGIS specification. It is also defined in the ISO *SQL/MM Part 3: Spatial* standard.

WKB is used to exchange geometry data as binary streams represented by `BLOB` values containing geometric WKB information.

WKB uses one-byte unsigned integers, four-byte unsigned integers, and eight-byte double-precision numbers (IEEE 754 format). A byte is eight bits.

For example, a WKB value that corresponds to `POINT(1 1)` consists of this sequence of 21 bytes (each represented here by two hex digits):

```
010100000000000000000000F03F000000000000F03F
```

The sequence may be broken down into these components:

```
Byte order : 01
WKB type   : 01000000
X          : 000000000000F03F
Y          : 000000000000F03F
```

Component representation is as follows:

- The byte order may be either 1 or 0 to indicate little-endian or big-endian storage. The little-endian and big-endian byte orders are also known as Network Data Representation (NDR) and External Data Representation (XDR), respectively.
- The WKB type is a code that indicates the geometry type. Values from 1 through 7 indicate `Point`, `LineString`, `Polygon`, `MultiPoint`, `MultiLineString`, `MultiPolygon`, and `GeometryCollection`.
- A `Point` value has X and Y coordinates, each represented as a double-precision value.

WKB values for more complex geometry values are represented by more complex data structures, as detailed in the OpenGIS specification.

## 11.13.4. Creating a Spatially Enabled MySQL Database

This section describes the data types you can use for representing spatial data in MySQL, and the functions available for creating and retrieving spatial values.

### 11.13.4.1. MySQL Spatial Data Types

MySQL has data types that correspond to OpenGIS classes. Some of these types hold single geometry values:

- `GEOMETRY`
- `POINT`
- `LINESTRING`
- `POLYGON`

`GEOMETRY` can store geometry values of any type. The other single-value types (`POINT`, `LINESTRING`, and `POLYGON`) restrict

their values to a particular geometry type.

The other data types hold collections of values:

- `MULTIPOINT`
- `MULTILINESTRING`
- `MULTIPOLYGON`
- `GEOMETRYCOLLECTION`

`GEOMETRYCOLLECTION` can store a collection of objects of any type. The other collection types (`MULTIPOINT`, `MULTILINESTRING`, `MULTIPOLYGON`, and `GEOMETRYCOLLECTION`) restrict collection members to those having a particular geometry type.

## 11.13.4.2. Creating Spatial Values

This section describes how to create spatial values using Well-Known Text and Well-Known Binary functions that are defined in the OpenGIS standard, and using MySQL-specific functions.

### 11.13.4.2.1. Creating Geometry Values Using WKT Functions

MySQL provides a number of functions that take as input parameters a Well-Known Text representation and, optionally, a spatial reference system identifier (SRID). They return the corresponding geometry.

`GeomFromText()` accepts a WKT of any geometry type as its first argument. An implementation also provides type-specific construction functions for construction of geometry values of each geometry type.

- `GeomCollFromText(wkt[,srid]), GeometryCollectionFromText(wkt[,srid])`  
Constructs a `GEOMETRYCOLLECTION` value using its WKT representation and SRID.
- `GeomFromText(wkt[,srid]), GeometryFromText(wkt[,srid])`  
Constructs a geometry value of any type using its WKT representation and SRID.
- `LineFromText(wkt[,srid]), LineStringFromText(wkt[,srid])`  
Constructs a `LINESTRING` value using its WKT representation and SRID.
- `MLineFromText(wkt[,srid]), MultiLineStringFromText(wkt[,srid])`  
Constructs a `MULTILINESTRING` value using its WKT representation and SRID.
- `MPointFromText(wkt[,srid]), MultiPointFromText(wkt[,srid])`  
Constructs a `MULTIPOINT` value using its WKT representation and SRID.
- `MPolyFromText(wkt[,srid]), MultiPolygonFromText(wkt[,srid])`  
Constructs a `MULTIPOLYGON` value using its WKT representation and SRID.
- `PointFromText(wkt[,srid])`  
Constructs a `POINT` value using its WKT representation and SRID.
- `PolyFromText(wkt[,srid]), PolygonFromText(wkt[,srid])`  
Constructs a `POLYGON` value using its WKT representation and SRID.

The OpenGIS specification also defines the following optional functions, which MySQL does not implement. These functions construct `Polygon` or `MultiPolygon` values based on the WKT representation of a collection of rings or closed `LineString` values. These values may intersect.

- `BdMPolyFromText(wkt,srid)`

Constructs a `MultiPolygon` value from a `MultiLineString` value in WKT format containing an arbitrary collection of closed `LineString` values.

- `BdPolyFromText(wkt, srid)`

Constructs a `Polygon` value from a `MultiLineString` value in WKT format containing an arbitrary collection of closed `LineString` values.

#### 11.13.4.2.2. Creating Geometry Values Using WKB Functions

MySQL provides a number of functions that take as arguments a `BLOB` containing a Well-Known Binary representation and, optionally, a spatial reference system identifier (SRID). They return the corresponding geometry.

As of MySQL 5.1.35, these functions also accept geometry objects for compatibility with the changes made in MySQL 5.1.35 to the return value of the functions in [Section 11.13.4.2.3, “Creating Geometry Values Using MySQL-Specific Functions”](#). Thus, those functions may continue to be used to provide the first argument to the functions in this section.

- `GeomCollFromWKB(wkb[, srid]), GeometryCollectionFromWKB(wkb[, srid])`

Constructs a `GEOMETRYCOLLECTION` value using its WKB representation and SRID.

- `GeomFromWKB(wkb[, srid]), GeometryFromWKB(wkb[, srid])`

Constructs a geometry value of any type using its WKB representation and SRID.

- `LineFromWKB(wkb[, srid]), LineStringFromWKB(wkb[, srid])`

Constructs a `LINestring` value using its WKB representation and SRID.

- `MLineFromWKB(wkb[, srid]), MultiLineStringFromWKB(wkb[, srid])`

Constructs a `MULTILINestring` value using its WKB representation and SRID.

- `MPointFromWKB(wkb[, srid]), MultiPointFromWKB(wkb[, srid])`

Constructs a `MULTIPOINT` value using its WKB representation and SRID.

- `MPolyFromWKB(wkb[, srid]), MultiPolygonFromWKB(wkb[, srid])`

Constructs a `MULTIPOLYGON` value using its WKB representation and SRID.

- `PointFromWKB(wkb[, srid])`

Constructs a `POINT` value using its WKB representation and SRID.

- `PolyFromWKB(wkb[, srid]), PolygonFromWKB(wkb[, srid])`

Constructs a `POLYGON` value using its WKB representation and SRID.

The OpenGIS specification also describes optional functions for constructing `Polygon` or `MultiPolygon` values based on the WKB representation of a collection of rings or closed `LineString` values. These values may intersect. MySQL does not implement these functions:

- `BdMPolyFromWKB(wkb, srid)`

Constructs a `MultiPolygon` value from a `MultiLineString` value in WKB format containing an arbitrary collection of closed `LineString` values.

- `BdPolyFromWKB(wkb, srid)`

Constructs a `Polygon` value from a `MultiLineString` value in WKB format containing an arbitrary collection of closed `LineString` values.

#### 11.13.4.2.3. Creating Geometry Values Using MySQL-Specific Functions

MySQL provides a set of useful non-standard functions for creating geometry values. The functions described in this section are

MySQL extensions to the OpenGIS specification.

As of MySQL 5.1.35, these functions produce geometry objects from either WKB values or geometry objects as arguments. If any argument is not a proper WKB or geometry representation of the proper object type, the return value is `NULL`.

Before MySQL 5.1.35, these functions produce `BLOB` values containing WKB representations of geometry values with no SRID from WKB arguments. The WKB value returned from these functions can be converted to geometry arguments by using them as the first argument to functions in the `GeomFromWKB()` function family.

For example, as of MySQL 5.1.35, you can insert the geometry return value from `Point()` directly into a `Point` column:

```
INSERT INTO t1 (pt_col) VALUES(Point(1,2));
```

Prior to MySQL 5.1.35, convert the WKB return value to a `Point` before inserting it:

```
INSERT INTO t1 (pt_col) VALUES(GeomFromWKB(Point(1,2)));
```

- `GeometryCollection(g1,g2,...)`  
Constructs a `GeometryCollection`.
- `LineString(pt1,pt2,...)`  
Constructs a `LineString` value from a number of `Point` or WKB `Point` arguments. If the number of arguments is less than two, the return value is `NULL`.
- `MultiLineString(ls1,ls2,...)`  
Constructs a `MultiLineString` value using `LineString` or WKB `LineString` arguments.
- `MultiPoint(pt1,pt2,...)`  
Constructs a `MultiPoint` value using `Point` or WKB `Point` arguments.
- `MultiPolygon(poly1,poly2,...)`  
Constructs a `MultiPolygon` value from a set of `Polygon` or WKB `Polygon` arguments.
- `Point(x,y)`  
Constructs a `Point` using its coordinates.
- `Polygon(ls1,ls2,...)`  
Constructs a `Polygon` value from a number of `LineString` or WKB `LineString` arguments. If any argument does not represent a `LinearRing` (that is, not a closed and simple `LineString`), the return value is `NULL`.

### 11.13.4.3. Creating Spatial Columns

MySQL provides a standard way of creating spatial columns for geometry types, for example, with `CREATE TABLE` or `ALTER TABLE`. Currently, spatial columns are supported for `MyISAM`, `InnoDB`, `NDB`, and `ARCHIVE` tables. See also the annotations about spatial indexes under [Section 11.13.6.1, “Creating Spatial Indexes”](#).

- Use the `CREATE TABLE` statement to create a table with a spatial column:

```
CREATE TABLE geom (g GEOMETRY);
```

- Use the `ALTER TABLE` statement to add or drop a spatial column to or from an existing table:

```
ALTER TABLE geom ADD pt POINT;
ALTER TABLE geom DROP pt;
```

### 11.13.4.4. Populating Spatial Columns

After you have created spatial columns, you can populate them with spatial data.

Values should be stored in internal geometry format, but you can convert them to that format from either Well-Known Text (WKT) or Well-Known Binary (WKB) format. The following examples demonstrate how to insert geometry values into a table by converting WKT values into internal geometry format:

- Perform the conversion directly in the `INSERT` statement:

```
INSERT INTO geom VALUES (GeomFromText('POINT(1 1)'));
SET @g = 'POINT(1 1)';
INSERT INTO geom VALUES (GeomFromText(@g));
```

- Perform the conversion prior to the `INSERT`:

```
SET @g = GeomFromText('POINT(1 1)');
INSERT INTO geom VALUES (@g);
```

The following examples insert more complex geometries into the table:

```
SET @g = 'LINESTRING(0 0,1 1,2 2)';
INSERT INTO geom VALUES (GeomFromText(@g));

SET @g = 'POLYGON((0 0,10 0,10 10,0 10,0 0),(5 5,7 5,7 7,5 7,5 5))';
INSERT INTO geom VALUES (GeomFromText(@g));

SET @g =
'GEOMETRYCOLLECTION(POINT(1 1),LINESTRING(0 0,1 1,2 2,3 3,4 4))';
INSERT INTO geom VALUES (GeomFromText(@g));
```

The preceding examples all use `GeomFromText()` to create geometry values. You can also use type-specific functions:

```
SET @g = 'POINT(1 1)';
INSERT INTO geom VALUES (PointFromText(@g));

SET @g = 'LINESTRING(0 0,1 1,2 2)';
INSERT INTO geom VALUES (LineStringFromText(@g));

SET @g = 'POLYGON((0 0,10 0,10 10,0 10,0 0),(5 5,7 5,7 7,5 7,5 5))';
INSERT INTO geom VALUES (PolygonFromText(@g));

SET @g =
'GEOMETRYCOLLECTION(POINT(1 1),LINESTRING(0 0,1 1,2 2,3 3,4 4))';
INSERT INTO geom VALUES (GeomCollFromText(@g));
```

Note that if a client application program wants to use WKB representations of geometry values, it is responsible for sending correctly formed WKB in queries to the server. However, there are several ways of satisfying this requirement. For example:

- Inserting a `POINT(1 1)` value with hex literal syntax:

```
mysql> INSERT INTO geom VALUES
-> (GeomFromWKB(0x01010000000000000000000000F03F000000000000F03F));
```

- An ODBC application can send a WKB representation, binding it to a placeholder using an argument of `BLOB` type:

```
INSERT INTO geom VALUES (GeomFromWKB(?))
```

Other programming interfaces may support a similar placeholder mechanism.

- In a C program, you can escape a binary value using `mysql_real_escape_string()` and include the result in a query string that is sent to the server. See [Section 20.10.3.53](#), “`mysql_real_escape_string()`”.

### 11.13.4.5. Fetching Spatial Data

Geometry values stored in a table can be fetched in internal format. You can also convert them into WKT or WKB format.

- Fetching spatial data in internal format:

Fetching geometry values using internal format can be useful in table-to-table transfers:

```
CREATE TABLE geom2 (g GEOMETRY) SELECT g FROM geom;
```

- Fetching spatial data in WKT format:

The `AsText()` function converts a geometry from internal format into a WKT string.

```
SELECT AsText(g) FROM geom;
```

- Fetching spatial data in WKB format:

The `AsBinary()` function converts a geometry from internal format into a `BLOB` containing the WKB value.

```
SELECT AsBinary(g) FROM geom;
```

## 11.13.5. Analyzing Spatial Information

After populating spatial columns with values, you are ready to query and analyze them. MySQL provides a set of functions to perform various operations on spatial data. These functions can be grouped into four major categories according to the type of operation they perform:

- Functions that convert geometries between various formats
- Functions that provide access to qualitative or quantitative properties of a geometry
- Functions that describe relations between two geometries
- Functions that create new geometries from existing ones

Spatial analysis functions can be used in many contexts, such as:

- Any interactive SQL program, such as `mysql` or MySQL Query Browser
- Application programs written in any language that supports a MySQL client API

### 11.13.5.1. Geometry Format Conversion Functions

MySQL supports the following functions for converting geometry values between internal format and either WKT or WKB format:

- `AsBinary(g), AsWKB(g)`

Converts a value in internal geometry format to its WKB representation and returns the binary result.

```
SELECT AsBinary(g) FROM geom;
```

- `AsText(g), AsWKT(g)`

Converts a value in internal geometry format to its WKT representation and returns the string result.

```
mysql> SET @g = 'LineString(1 1,2 2,3 3)';
mysql> SELECT AsText(GeomFromText(@g));
+-----+
| AsText(GeomFromText(@g)) |
+-----+
| LINESTRING(1 1,2 2,3 3) |
+-----+
```

- `GeomFromText(wkt[,srid])`

Converts a string value from its WKT representation into internal geometry format and returns the result. A number of type-specific functions are also supported, such as `PointFromText()` and `LineFromText()`. See [Section 11.13.4.2.1, “Creating Geometry Values Using WKT Functions”](#).

- `GeomFromWKB(wkb[,srid])`

Converts a binary value from its WKB representation into internal geometry format and returns the result. A number of type-specific functions are also supported, such as `PointFromWKB()` and `LineFromWKB()`. See [Section 11.13.4.2.2, “Creating Geometry Values Using WKB Functions”](#).

## 11.13.5.2. Geometry Functions

Each function that belongs to this group takes a geometry value as its argument and returns some quantitative or qualitative property of the geometry. Some functions restrict their argument type. Such functions return `NULL` if the argument is of an incorrect geometry type. For example, `Area()` returns `NULL` if the object type is neither `Polygon` nor `MultiPolygon`.

### 11.13.5.2.1. General Geometry Functions

The functions listed in this section do not restrict their argument and accept a geometry value of any type.

- `Dimension(g)`

Returns the inherent dimension of the geometry value *g*. The result can be -1, 0, 1, or 2. The meaning of these values is given in [Section 11.13.2.2, “Class Geometry”](#).

```
mysql> SELECT Dimension(GeomFromText('LineString(1 1,2 2)'));
+-----+
| Dimension(GeomFromText('LineString(1 1,2 2)')) |
+-----+
| 1 |
+-----+
```

- `Envelope(g)`

Returns the Minimum Bounding Rectangle (MBR) for the geometry value *g*. The result is returned as a `Polygon` value.

The polygon is defined by the corner points of the bounding box:

```
POLYGON((MINX MINY, MAXX MINY, MAXX MAXY, MINX MAXY, MINX MINY))
```

```
mysql> SELECT AsText(Envelope(GeomFromText('LineString(1 1,2 2)')));
+-----+
| AsText(Envelope(GeomFromText('LineString(1 1,2 2)'))) |
+-----+
| POLYGON((1 1,2 1,2 2,1 2,1 1)) |
+-----+
```

- `GeometryType(g)`

Returns as a string the name of the geometry type of which the geometry instance *g* is a member. The name corresponds to one of the instantiable `Geometry` subclasses.

```
mysql> SELECT GeometryType(GeomFromText('POINT(1 1)'));
+-----+
| GeometryType(GeomFromText('POINT(1 1)')) |
+-----+
| POINT |
+-----+
```

- `SRID(g)`

Returns an integer indicating the Spatial Reference System ID for the geometry value *g*.

In MySQL, the SRID value is just an integer associated with the geometry value. All calculations are done assuming Euclidean (planar) geometry.

```
mysql> SELECT SRID(GeomFromText('LineString(1 1,2 2)',101));
+-----+
| SRID(GeomFromText('LineString(1 1,2 2)',101)) |
+-----+
| 101 |
+-----+
```

The OpenGIS specification also defines the following functions, which MySQL does not implement:

- `Boundary(g)`

Returns a geometry that is the closure of the combinatorial boundary of the geometry value *g*.

- `IsEmpty(g)`

Returns 1 if the geometry value *g* is the empty geometry, 0 if it is not empty, and -1 if the argument is `NULL`. If the geometry is empty, it represents the empty point set.

- `IsSimple(g)`

Currently, this function is a placeholder and should not be used. If implemented, its behavior will be as described in the next paragraph.

Returns 1 if the geometry value *g* has no anomalous geometric points, such as self-intersection or self-tangency. `IsSimple()` returns 0 if the argument is not simple, and -1 if it is `NULL`.

The description of each instantiable geometric class given earlier in the chapter includes the specific conditions that cause an instance of that class to be classified as not simple. (See [Section 11.13.2.1](#), “The Geometry Class Hierarchy”.)

### 11.13.5.2.2. Point Functions

A `Point` consists of X and Y coordinates, which may be obtained using the following functions:

- `X(p)`

Returns the X-coordinate value for the point *p* as a double-precision number.

```
mysql> SET @pt = 'Point(56.7 53.34)';
mysql> SELECT X(GeomFromText(@pt));
+-----+
| X(GeomFromText(@pt)) |
+-----+
|          56.7        |
+-----+
```

- `Y(p)`

Returns the Y-coordinate value for the point *p* as a double-precision number.

```
mysql> SET @pt = 'Point(56.7 53.34)';
mysql> SELECT Y(GeomFromText(@pt));
+-----+
| Y(GeomFromText(@pt)) |
+-----+
|          53.34       |
+-----+
```

### 11.13.5.2.3. LineString Functions

A `LineString` consists of `Point` values. You can extract particular points of a `LineString`, count the number of points that it contains, or obtain its length.

- `EndPoint(ls)`

Returns the `Point` that is the endpoint of the `LineString` value *ls*.

```
mysql> SET @ls = 'LineString(1 1,2 2,3 3)';
mysql> SELECT AsText(EndPoint(GeomFromText(@ls)));
+-----+
| AsText(EndPoint(GeomFromText(@ls))) |
+-----+
| POINT(3 3)                          |
+-----+
```

- `GLength(ls)`

Returns as a double-precision number the length of the `LineString` value *ls* in its associated spatial reference.

```
mysql> SET @ls = 'LineString(1 1,2 2,3 3)';
mysql> SELECT GLength(GeomFromText(@ls));
+-----+
| GLength(GeomFromText(@ls)) |
+-----+
| 2.8284271247462           |
+-----+
```



`GLength()` is a non-standard name. It corresponds to the OpenGIS `Length()` function.

- `NumPoints(ls)`

Returns the number of `Point` objects in the `LineString` value `ls`.

```
mysql> SET @ls = 'LineString(1 1,2 2,3 3)';
mysql> SELECT NumPoints(GeomFromText(@ls));
+-----+
| NumPoints(GeomFromText(@ls)) |
+-----+
| 3 |
+-----+
```

- `PointN(ls,N)`

Returns the `N`-th `Point` in the `LineString` value `ls`. Points are numbered beginning with 1.

```
mysql> SET @ls = 'LineString(1 1,2 2,3 3)';
mysql> SELECT AsText(PointN(GeomFromText(@ls),2));
+-----+
| AsText(PointN(GeomFromText(@ls),2)) |
+-----+
| POINT(2 2) |
+-----+
```

- `StartPoint(ls)`

Returns the `Point` that is the start point of the `LineString` value `ls`.

```
mysql> SET @ls = 'LineString(1 1,2 2,3 3)';
mysql> SELECT AsText(StartPoint(GeomFromText(@ls)));
+-----+
| AsText(StartPoint(GeomFromText(@ls))) |
+-----+
| POINT(1 1) |
+-----+
```

The OpenGIS specification also defines the following function, which MySQL does not implement:

- `IsRing(ls)`

Returns 1 if the `LineString` value `ls` is closed (that is, its `StartPoint()` and `EndPoint()` values are the same) and is simple (does not pass through the same point more than once). Returns 0 if `ls` is not a ring, and -1 if it is `NULL`.

### 11.13.5.2.4. MultiLineString Functions

These functions return properties of `MultiLineString` values.

- `GLength(mls)`

Returns as a double-precision number the length of the `MultiLineString` value `mls`. The length of `mls` is equal to the sum of the lengths of its elements.

```
mysql> SET @mls = 'MultiLineString((1 1,2 2,3 3),(4 4,5 5))';
mysql> SELECT GLength(GeomFromText(@mls));
+-----+
| GLength(GeomFromText(@mls)) |
+-----+
| 4.2426406871193 |
+-----+
```

`GLength()` is a non-standard name. It corresponds to the OpenGIS `Length()` function.

- `IsClosed(mls)`

Returns 1 if the `MultiLineString` value `mls` is closed (that is, the `StartPoint()` and `EndPoint()` values are the same for each `LineString` in `mls`). Returns 0 if `mls` is not closed, and -1 if it is `NULL`.

```
mysql> SET @mls = 'MultiLineString((1 1,2 2,3 3),(4 4,5 5))';
mysql> SELECT IsClosed(GeomFromText(@mls));
+-----+
```

```
| IsClosed(GeomFromText(@mls)) |
+-----+
|                                |
+-----+
|                                |
+-----+
|                                |
+-----+
|                                |
+-----+
```

### 11.13.5.2.5. Polygon Functions

These functions return properties of `Polygon` values.

- `Area(poly)`

Returns as a double-precision number the area of the `Polygon` value `poly`, as measured in its spatial reference system.

```
mysql> SET @poly = 'Polygon((0 0,0 3,3 0,0 0),(1 1,1 2,2 1,1 1))';
mysql> SELECT Area(GeomFromText(@poly));
+-----+
| Area(GeomFromText(@poly)) |
+-----+
|                                |
+-----+
|                                |
+-----+
|                                |
+-----+
```

- `ExteriorRing(poly)`

Returns the exterior ring of the `Polygon` value `poly` as a `LineString`.

```
mysql> SET @poly =
-> 'Polygon((0 0,0 3,3 3,3 0,0 0),(1 1,1 2,2 2,2 1,1 1))';
mysql> SELECT AsText(ExteriorRing(GeomFromText(@poly)));
+-----+
| AsText(ExteriorRing(GeomFromText(@poly))) |
+-----+
| LINESTRING(0 0,0 3,3 3,3 0,0 0) |
+-----+
```

- `InteriorRingN(poly,N)`

Returns the `N`-th interior ring for the `Polygon` value `poly` as a `LineString`. Rings are numbered beginning with 1.

```
mysql> SET @poly =
-> 'Polygon((0 0,0 3,3 3,3 0,0 0),(1 1,1 2,2 2,2 1,1 1))';
mysql> SELECT AsText(InteriorRingN(GeomFromText(@poly),1));
+-----+
| AsText(InteriorRingN(GeomFromText(@poly),1)) |
+-----+
| LINESTRING(1 1,1 2,2 2,2 1,1 1) |
+-----+
```

- `NumInteriorRings(poly)`

Returns the number of interior rings in the `Polygon` value `poly`.

```
mysql> SET @poly =
-> 'Polygon((0 0,0 3,3 3,3 0,0 0),(1 1,1 2,2 2,2 1,1 1))';
mysql> SELECT NumInteriorRings(GeomFromText(@poly));
+-----+
| NumInteriorRings(GeomFromText(@poly)) |
+-----+
|                                |
+-----+
|                                |
+-----+
|                                |
+-----+
```

### 11.13.5.2.6. MultiPolygon Functions

These functions return properties of `MultiPolygon` values.

- `Area(mpoly)`

Returns as a double-precision number the area of the `MultiPolygon` value `mpoly`, as measured in its spatial reference system.

```
mysql> SET @mpoly =
-> 'MultiPolygon(((0 0,0 3,3 3,3 0,0 0),(1 1,1 2,2 2,2 1,1 1)))';
mysql> SELECT Area(GeomFromText(@mpoly));
+-----+
| Area(GeomFromText(@mpoly)) |
+-----+
```

8
---

The OpenGIS specification also defines the following functions, which MySQL does not implement:

- `Centroid(mpoly)`  
Returns the mathematical centroid for the `MultiPolygon` value *mpoly* as a `Point`. The result is not guaranteed to be on the `MultiPolygon`.
- `PointOnSurface(mpoly)`  
Returns a `Point` value that is guaranteed to be on the `MultiPolygon` value *mpoly*.

### 11.13.5.2.7. GeometryCollection Functions

These functions return properties of `GeometryCollation` values.

- `GeometryN(gc,N)`  
Returns the *N*-th geometry in the `GeometryCollection` value *gc*. Geometries are numbered beginning with 1.

```
mysql> SET @gc = 'GeometryCollection(Point(1 1),LineString(2 2, 3 3))';
mysql> SELECT AsText(GeometryN(GeomFromText(@gc),1));
```

AsText(GeometryN(GeomFromText(@gc),1))
POINT(1 1)

- `NumGeometries(gc)`  
Returns the number of geometries in the `GeometryCollection` value *gc*.

```
mysql> SET @gc = 'GeometryCollection(Point(1 1),LineString(2 2, 3 3))';
mysql> SELECT NumGeometries(GeomFromText(@gc));
```

NumGeometries(GeomFromText(@gc))
2

### 11.13.5.3. Functions That Create New Geometries from Existing Ones

The following sections describe functions that take geometry values as arguments and return new geometry values.

#### 11.13.5.3.1. Geometry Functions That Produce New Geometries

Section 11.13.5.2, “Geometry Functions”, discusses several functions that construct new geometries from existing ones. See that section for descriptions of these functions:

- `Envelope(g)`
- `StartPoint(ls)`
- `EndPoint(ls)`
- `PointN(ls,N)`
- `ExteriorRing(poly)`
- `InteriorRingN(poly,N)`
- `GeometryN(gc,N)`

### 11.13.5.3.2. Spatial Operators

OpenGIS proposes a number of other functions that can produce geometries. They are designed to implement spatial operators. These functions are not implemented in MySQL. They may appear in future releases.

- `Buffer(g,d)`  
Returns a geometry that represents all points whose distance from the geometry value *g* is less than or equal to a distance of *d*.
- `ConvexHull(g)`  
Returns a geometry that represents the convex hull of the geometry value *g*.
- `Difference(g1,g2)`  
Returns a geometry that represents the point set difference of the geometry value *g1* with *g2*.
- `Intersection(g1,g2)`  
Returns a geometry that represents the point set intersection of the geometry values *g1* with *g2*.
- `SymDifference(g1,g2)`  
Returns a geometry that represents the point set symmetric difference of the geometry value *g1* with *g2*.
- `Union(g1,g2)`  
Returns a geometry that represents the point set union of the geometry values *g1* and *g2*.

### 11.13.5.4. Functions for Testing Spatial Relations Between Geometric Objects

The functions described in these sections take two geometries as input parameters and return a qualitative or quantitative relation between them.

### 11.13.5.5. Relations on Geometry Minimal Bounding Rectangles (MBRs)

MySQL provides several functions that test relations between minimal bounding rectangles of two geometries *g1* and *g2*. The return values 1 and 0 indicate true and false, respectively.

- `MBRContains(g1,g2)`  
Returns 1 or 0 to indicate whether the Minimum Bounding Rectangle of *g1* contains the Minimum Bounding Rectangle of *g2*. This tests the opposite relationship as `MBRWithin()`.

```
mysql> SET @g1 = GeomFromText('Polygon((0 0,0 3,3 3,3 0,0 0))');
mysql> SET @g2 = GeomFromText('Point(1 1)');
mysql> SELECT MBRContains(@g1,@g2), MBRContains(@g2,@g1);
+-----+-----+
| MBRContains(@g1,@g2) | MBRContains(@g2,@g1) |
+-----+-----+
| 1 | 0 |
+-----+-----+
```

- `MBRDisjoint(g1,g2)`  
Returns 1 or 0 to indicate whether the Minimum Bounding Rectangles of the two geometries *g1* and *g2* are disjoint (do not intersect).
- `MBREqual(g1,g2)`  
Returns 1 or 0 to indicate whether the Minimum Bounding Rectangles of the two geometries *g1* and *g2* are the same.
- `MBRIntersects(g1,g2)`  
Returns 1 or 0 to indicate whether the Minimum Bounding Rectangles of the two geometries *g1* and *g2* intersect.
- `MBROverlaps(g1,g2)`

Returns 1 or 0 to indicate whether the Minimum Bounding Rectangles of the two geometries *g1* and *g2* overlap. The term *spatially overlaps* is used if two geometries intersect and their intersection results in a geometry of the same dimension but not equal to either of the given geometries.

- `MBRTouches(g1,g2)`

Returns 1 or 0 to indicate whether the Minimum Bounding Rectangles of the two geometries *g1* and *g2* touch. Two geometries *spatially touch* if the interiors of the geometries do not intersect, but the boundary of one of the geometries intersects either the boundary or the interior of the other.

- `MBRWithin(g1,g2)`

Returns 1 or 0 to indicate whether the Minimum Bounding Rectangle of *g1* is within the Minimum Bounding Rectangle of *g2*. This tests the opposite relationship as `MBRContains()`.

```
mysql> SET @g1 = GeomFromText('Polygon((0 0,0 3,3 3,3 0,0 0))');
mysql> SET @g2 = GeomFromText('Polygon((0 0,0 5,5 5,5 0,0 0))');
mysql> SELECT MBRWithin(@g1,@g2), MBRWithin(@g2,@g1);
+-----+-----+
| MBRWithin(@g1,@g2) | MBRWithin(@g2,@g1) |
+-----+-----+
| 1 | 0 |
+-----+-----+
```

### 11.13.5.6. Functions That Test Spatial Relationships Between Geometries

The OpenGIS specification defines the following functions. They test the relationship between two geometry values *g1* and *g2*.

The return values 1 and 0 indicate true and false, respectively.

**Note**

Currently, MySQL does not implement these functions according to the specification. Those that are implemented return the same result as the corresponding MBR-based functions. This includes functions in the following list other than `Distance()` and `Related()`.

These functions may be implemented in future releases with full support for spatial analysis, not just MBR-based support.

- `Contains(g1,g2)`

Returns 1 or 0 to indicate whether *g1* completely contains *g2*. This tests the opposite relationship as `Within()`.

- `Crosses(g1,g2)`

Returns 1 if *g1* spatially crosses *g2*. Returns `NULL` if *g1* is a `Polygon` or a `MultiPolygon`, or if *g2* is a `Point` or a `MultiPoint`. Otherwise, returns 0.

The term *spatially crosses* denotes a spatial relation between two given geometries that has the following properties:

- The two geometries intersect
- Their intersection results in a geometry that has a dimension that is one less than the maximum dimension of the two given geometries
- Their intersection is not equal to either of the two given geometries

- `Disjoint(g1,g2)`

Returns 1 or 0 to indicate whether *g1* is spatially disjoint from (does not intersect) *g2*.

- `Distance(g1,g2)`

Returns as a double-precision number the shortest distance between any two points in the two geometries.

- `Equals(g1,g2)`

Returns 1 or 0 to indicate whether *g1* is spatially equal to *g2*.

- `Intersects(g1,g2)`

Returns 1 or 0 to indicate whether *g1* spatially intersects *g2*.

- `Overlaps(g1,g2)`

Returns 1 or 0 to indicate whether *g1* spatially overlaps *g2*. The term *spatially overlaps* is used if two geometries intersect and their intersection results in a geometry of the same dimension but not equal to either of the given geometries.

- `Related(g1,g2,pattern_matrix)`

Returns 1 or 0 to indicate whether the spatial relationship specified by *pattern\_matrix* exists between *g1* and *g2*. Returns -1 if the arguments are `NULL`. The pattern matrix is a string. Its specification will be noted here if this function is implemented.

- `Touches(g1,g2)`

Returns 1 or 0 to indicate whether *g1* spatially touches *g2*. Two geometries *spatially touch* if the interiors of the geometries do not intersect, but the boundary of one of the geometries intersects either the boundary or the interior of the other.

- `Within(g1,g2)`

Returns 1 or 0 to indicate whether *g1* is spatially within *g2*. This tests the opposite relationship as `Contains()`.

## 11.13.6. Optimizing Spatial Analysis

Search operations in non-spatial databases can be optimized using `SPATIAL` indexes. This is true for spatial databases as well. With the help of a great variety of multi-dimensional indexing methods that have previously been designed, it is possible to optimize spatial searches. The most typical of these are:

- Point queries that search for all objects that contain a given point
- Region queries that search for all objects that overlap a given region

MySQL uses **R-Trees with quadratic splitting** for `SPATIAL` indexes on spatial columns. A `SPATIAL` index is built using the MBR of a geometry. For most geometries, the MBR is a minimum rectangle that surrounds the geometries. For a horizontal or a vertical linestring, the MBR is a rectangle degenerated into the linestring. For a point, the MBR is a rectangle degenerated into the point.

It is also possible to create normal indexes on spatial columns. In a non-`SPATIAL` index, you must declare a prefix for any spatial column except for `POINT` columns.

`MyISAM` supports both `SPATIAL` and non-`SPATIAL` indexes. Other storage engines support non-`SPATIAL` indexes, as described in [Section 12.1.13, “CREATE INDEX Syntax”](#).

### 11.13.6.1. Creating Spatial Indexes

MySQL can create spatial indexes using syntax similar to that for creating regular indexes, but extended with the `SPATIAL` keyword. Currently, columns in spatial indexes must be declared `NOT NULL`. The following examples demonstrate how to create spatial indexes:

- With `CREATE TABLE`:

```
CREATE TABLE geom (g GEOMETRY NOT NULL, SPATIAL INDEX(g));
```

- With `ALTER TABLE`:

```
ALTER TABLE geom ADD SPATIAL INDEX(g);
```

- With `CREATE INDEX`:

```
CREATE SPATIAL INDEX sp_index ON geom (g);
```

For `MyISAM` tables, `SPATIAL INDEX` creates an R-tree index. For storage engines that support non-spatial indexing of spatial columns, the engine creates a B-tree index. A B-tree index on spatial values will be useful for exact-value lookups, but not for range scans.

For more information on indexing spatial columns, see [Section 12.1.13, “CREATE INDEX Syntax”](#).

To drop spatial indexes, use `ALTER TABLE` or `DROP INDEX`:

- With `ALTER TABLE`:

```
ALTER TABLE geom DROP INDEX g;
```

- With `DROP INDEX`:

```
DROP INDEX sp_index ON geom;
```

Example: Suppose that a table `geom` contains more than 32,000 geometries, which are stored in the column `g` of type `GEOMETRY`. The table also has an `AUTO_INCREMENT` column `fid` for storing object ID values.

```
mysql> DESCRIBE geom;
+-----+-----+-----+-----+-----+-----+
| Field | Type      | Null | Key | Default | Extra          |
+-----+-----+-----+-----+-----+-----+
| fid   | int(11)   |      | PRI | NULL    | auto_increment |
| g     | geometry  |      |     |         |                |
+-----+-----+-----+-----+-----+-----+
2 rows in set (0.00 sec)

mysql> SELECT COUNT(*) FROM geom;
+-----+
| count(*) |
+-----+
|      32376 |
+-----+
1 row in set (0.00 sec)
```

To add a spatial index on the column `g`, use this statement:

```
mysql> ALTER TABLE geom ADD SPATIAL INDEX(g);
Query OK, 32376 rows affected (4.05 sec)
Records: 32376 Duplicates: 0 Warnings: 0
```

### 11.13.6.2. Using a Spatial Index

The optimizer investigates whether available spatial indexes can be involved in the search for queries that use a function such as `MBRContains()` or `MBRWithin()` in the `WHERE` clause. The following query finds all objects that are in the given rectangle:

```
mysql> SET @poly =
-> 'Polygon(30000 15000,
           31000 15000,
           31000 16000,
           30000 16000,
           30000 15000)';
mysql> SELECT fid,AsText(g) FROM geom WHERE
-> MBRContains(GeomFromText(@poly),g);
+-----+-----+
| fid | AsText(g) |
+-----+-----+
| 21  | LINESTRING(30350.4 15828.8,30350.6 15845,30333.8 15845,30 ... |
| 22  | LINESTRING(30350.6 15871.4,30350.6 15887.8,30334 15887.8, ... |
| 23  | LINESTRING(30350.6 15914.2,30350.6 15930.4,30334 15930.4, ... |
| 24  | LINESTRING(30290.2 15823,30290.2 15839.4,30273.4 15839.4, ... |
| 25  | LINESTRING(30291.4 15866.2,30291.6 15882.4,30274.8 15882. ... |
| 26  | LINESTRING(30291.6 15918.2,30291.6 15934.4,30275 15934.4, ... |
| 249 | LINESTRING(30337.8 15938.6,30337.8 15946.8,30320.4 15946. ... |
| 1   | LINESTRING(30250.4 15129.2,30248.8 15138.4,30238.2 15136. ... |
| 2   | LINESTRING(30220.2 15122.8,30217.2 15137.8,30207.6 15136. ... |
| 3   | LINESTRING(30179 15114.4,30176.6 15129.4,30167 15128,3016 ... |
| 4   | LINESTRING(30155.2 15121.4,30140.4 15118.6,30142 15109,30 ... |
| 5   | LINESTRING(30192.4 15085,30177.6 15082.2,30179.2 15072.4, ... |
| 6   | LINESTRING(30244 15087,30229 15086.2,30229.4 15076.4,3024 ... |
| 7   | LINESTRING(30200.6 15059.4,30185.6 15058.6,30186 15048.8, ... |
| 10  | LINESTRING(30179.6 15017.8,30181 15002.8,30190.8 15003.6, ... |
| 11  | LINESTRING(30154.2 15000.4,30168.6 15004.8,30166 15014.2, ... |
| 13  | LINESTRING(30105 15065.8,30108.4 15050.8,30118 15053,3011 ... |
| 154 | LINESTRING(30276.2 15143.8,30261.4 15141,30263 15131.4,30 ... |
| 155 | LINESTRING(30269.8 15084,30269.4 15093.4,30258.6 15093,30 ... |
| 157 | LINESTRING(30128.2 15011,30113.2 15010.2,30113.6 15000.4, ... |
+-----+-----+
20 rows in set (0.00 sec)
```

Use `EXPLAIN` to check the way this query is executed:

```
mysql> SET @poly =
```

```

-> 'Polygon((30000 15000,
            31000 15000,
            31000 16000,
            30000 16000,
            30000 15000))';
mysql> EXPLAIN SELECT fid,AsText(g) FROM geom WHERE
-> MBRContains(GeomFromText(@poly),g)\G
***** 1. row *****
id: 1
select_type: SIMPLE
table: geom
type: range
possible_keys: g
key: g
key_len: 32
ref: NULL
rows: 50
Extra: Using where
1 row in set (0.00 sec)

```

Check what would happen without a spatial index:

```

mysql> SET @poly =
-> 'Polygon((30000 15000,
            31000 15000,
            31000 16000,
            30000 16000,
            30000 15000))';
mysql> EXPLAIN SELECT fid,AsText(g) FROM g IGNORE INDEX (g) WHERE
-> MBRContains(GeomFromText(@poly),g)\G
***** 1. row *****
id: 1
select_type: SIMPLE
table: geom
type: ALL
possible_keys: NULL
key: NULL
key_len: NULL
ref: NULL
rows: 32376
Extra: Using where
1 row in set (0.00 sec)

```

Executing the `SELECT` statement without the spatial index yields the same result but causes the execution time to rise from 0.00 seconds to 0.46 seconds:

```

mysql> SET @poly =
-> 'Polygon((30000 15000,
            31000 15000,
            31000 16000,
            30000 16000,
            30000 15000))';
mysql> SELECT fid,AsText(g) FROM geom IGNORE INDEX (g) WHERE
-> MBRContains(GeomFromText(@poly),g);
+-----+-----+
| fid | AsText(g) |
+-----+-----+
| 1 | LINESTRING(30250.4 15129.2,30248.8 15138.4,30238.2 15136. ... |
| 2 | LINESTRING(30220.2 15122.8,30217.2 15137.8,30207.6 15136. ... |
| 3 | LINESTRING(30179 15114.4,30176.6 15129.4,30167 15128,3016 ... |
| 4 | LINESTRING(30155.2 15121.4,30140.4 15118.6,30142 15109,30 ... |
| 5 | LINESTRING(30192.4 15085,30177.6 15082.2,30179.2 15072.4, ... |
| 6 | LINESTRING(30244 15087,30229 15086.2,30229.4 15076.4,3024 ... |
| 7 | LINESTRING(30200.6 15059.4,30185.6 15058.6,30186 15048.8, ... |
| 10 | LINESTRING(30179.6 15017.8,30181 15002.8,30190.8 15003.6, ... |
| 11 | LINESTRING(30154.2 15000.4,30168.6 15004.8,30166 15014.2, ... |
| 13 | LINESTRING(30105 15065.8,30108.4 15050.8,30118 15053,3011 ... |
| 21 | LINESTRING(30350.4 15828.8,30350.6 15845,30333.8 15845,30 ... |
| 22 | LINESTRING(30350.6 15871.4,30350.6 15887.8,30334 15887.8, ... |
| 23 | LINESTRING(30350.6 15914.2,30350.6 15930.4,30334 15930.4, ... |
| 24 | LINESTRING(30290.2 15823,30290.2 15839.4,30273.4 15839.4, ... |
| 25 | LINESTRING(30291.4 15866.2,30291.6 15882.4,30274.8 15882. ... |
| 26 | LINESTRING(30291.6 15918.2,30291.6 15934.4,30275 15934.4, ... |
| 154 | LINESTRING(30276.2 15143.8,30261.4 15141,30263 15131.4,30 ... |
| 155 | LINESTRING(30269.8 15084,30269.4 15093.4,30258.6 15093,30 ... |
| 157 | LINESTRING(30128.2 15011,30113.2 15010.2,30113.6 15000.4, ... |
| 249 | LINESTRING(30337.8 15938.6,30337.8 15946.8,30320.4 15946. ... |
+-----+-----+
20 rows in set (0.46 sec)

```

In future releases, spatial indexes may also be used for optimizing other functions. See [Section 11.13.5.4, “Functions for Testing Spatial Relations Between Geometric Objects”](#).

## 11.13.7. MySQL Conformance and Compatibility

MySQL does not yet implement the following GIS features:



- Additional Metadata Views

OpenGIS specifications propose several additional metadata views. For example, a system view named `GEOMETRY_COLUMNS` contains a description of geometry columns, one row for each geometry column in the database.

- The OpenGIS function `Length()` on `LineString` and `MultiLineString` currently should be called in MySQL as `GLength()`

The problem is that there is an existing SQL function `Length()` that calculates the length of string values, and sometimes it is not possible to distinguish whether the function is called in a textual or spatial context. We need either to solve this somehow, or decide on another function name.

## 11.14. Precision Math

MySQL 5.1 provides support for precision math: numeric value handling that results in extremely accurate results and a high degree control over invalid values. Precision math is based on these two features:

- SQL modes that control how strict the server is about accepting or rejecting invalid data.
- The MySQL library for fixed-point arithmetic.

These features have several implications for numeric operations:

- **Precise calculations:** For exact-value numbers, calculations do not introduce floating-point errors. Instead, exact precision is used. For example, a number such as `.0001` is treated as an exact value rather than as an approximation, and summing it 10,000 times produces a result of exactly `1`, not a value that merely “close” to `1`.
- **Well-defined rounding behavior:** For exact-value numbers, the result of `ROUND()` depends on its argument, not on environmental factors such as how the underlying C library works.
- **Platform independence:** Operations on exact numeric values are the same across different platforms such as Windows and Unix.
- **Control over handling of invalid values:** Overflow and division by zero are detectable and can be treated as errors. For example, you can treat a value that is too large for a column as an error rather than having the value truncated to lie within the range of the column's data type. Similarly, you can treat division by zero as an error rather than as an operation that produces a result of `NULL`. The choice of which approach to take is determined by the setting of the `sql_mode` system variable.

An important result of these features is that MySQL 5.1 provides a high degree of compliance with standard SQL.

The following discussion covers several aspects of how precision math works (including possible incompatibilities with older applications). At the end, some examples are given that demonstrate how MySQL 5.1 handles numeric operations precisely. For information about using the `sql_mode` system variable to control the SQL mode, see [Section 5.1.7, “Server SQL Modes”](#).

### 11.14.1. Types of Numeric Values

The scope of precision math for exact-value operations includes the exact-value data types (`DECIMAL` and integer types) and exact-value numeric literals. Approximate-value data types and numeric literals still are handled as floating-point numbers.

Exact-value numeric literals have an integer part or fractional part, or both. They may be signed. Examples: `1`, `.2`, `3.4`, `-5`, `-6.78`, `+9.10`.

Approximate-value numeric literals are represented in scientific notation with a mantissa and exponent. Either or both parts may be signed. Examples: `1.2E3`, `1.2E-3`, `-1.2E3`, `-1.2E-3`.

Two numbers that look similar need not be both exact-value or both approximate-value. For example, `2.34` is an exact-value (fixed-point) number, whereas `2.34E0` is an approximate-value (floating-point) number.

The `DECIMAL` data type is a fixed-point type and calculations are exact. In MySQL, the `DECIMAL` type has several synonyms: `NUMERIC`, `DEC`, `FIXED`. The integer types also are exact-value types.

The `FLOAT` and `DOUBLE` data types are floating-point types and calculations are approximate. In MySQL, types that are synonymous with `FLOAT` or `DOUBLE` are `DOUBLE PRECISION` and `REAL`.

## 11.14.2. DECIMAL Data Type Changes

This section discusses the characteristics of the `DECIMAL` data type (and its synonyms) in MySQL 5.1, with particular regard to the following topics:

- Maximum number of digits
- Storage format
- Storage requirements
- The non-standard MySQL extension to the upper range of `DECIMAL` columns

Possible incompatibilities with applications that are written for older versions of MySQL are noted throughout this section.

The declaration syntax for a `DECIMAL` column is `DECIMAL(M,D)`. The ranges of values for the arguments in MySQL 5.1 are as follows:

- *M* is the maximum number of digits (the precision). It has a range of 1 to 65. (Older versions of MySQL allowed a range of 1 to 254.)
- *D* is the number of digits to the right of the decimal point (the scale). It has a range of 0 to 30 and must be no larger than *M*.

The maximum value of 65 for *M* means that calculations on `DECIMAL` values are accurate up to 65 digits. This limit of 65 digits of precision also applies to exact-value numeric literals, so the maximum range of such literals is different from before. (In older versions of MySQL, decimal values could have up to 254 digits. However, calculations were done using floating-point and thus were approximate, not exact.)

Values for `DECIMAL` columns in MySQL 5.1 are stored using a binary format that packs nine decimal digits into four bytes. The storage requirements for the integer and fractional parts of each value are determined separately. Each multiple of nine digits requires four bytes, and any digits left over require some fraction of four bytes. For example, a `DECIMAL(18,9)` column has nine digits on either side of the decimal point, so the integer part and the fractional part each require four bytes. A `DECIMAL(20,10)` column has ten digits on either side of the decimal point. Each part requires four bytes for nine of the digits, and one byte for the remaining digit.

The storage required for leftover digits is given by the following table.

Leftover Digits	Number of Bytes
0	0
1	1
2	1
3	2
4	2
5	3
6	3
7	4
8	4
9	4

Unlike some older versions of MySQL (prior to 5.0.3), `DECIMAL` columns in MySQL 5.1 do not store a leading `+` character or `-` character or leading `0` digits. If you insert `+0003.1` into a `DECIMAL(5,1)` column, it is stored as `3.1`. For negative numbers, a literal `-` character is not stored. Applications that rely on the older behavior must be modified to account for this change.

`DECIMAL` columns in MySQL 5.1 do not allow values larger than the range implied by the column definition. For example, a `DECIMAL(3,0)` column supports a range of `-999` to `999`. A `DECIMAL(M,D)` column allows at most *M* - *D* digits to the left of the decimal point. This is not compatible with applications relying on older versions of MySQL that allowed storing an extra digit in lieu of a `+` sign.

The SQL standard requires that the precision of `NUMERIC(M,D)` be *exactly* *M* digits. For `DECIMAL(M,D)`, the standard requires a precision of at least *M* digits but allows more. In MySQL, `DECIMAL(M,D)` and `NUMERIC(M,D)` are the same, and both have a precision of exactly *M* digits.

For more detailed information about porting applications that rely on the old treatment of the `DECIMAL` data type, see the *MySQL 5.0 Reference Manual*.

### 11.14.3. Expression Handling

With precision math, exact-value numbers are used as given whenever possible. For example, numbers in comparisons are used exactly as given without a change in value. In strict SQL mode, for `INSERT` into a column with an exact data type (`DECIMAL` or integer), a number is inserted with its exact value if it is within the column range. When retrieved, the value should be the same as what was inserted. (Without strict mode, truncation for `INSERT` is allowable.)

Handling of a numeric expression depends on what kind of values the expression contains:

- If any approximate values are present, the expression is approximate and is evaluated using floating-point arithmetic.
- If no approximate values are present, the expression contains only exact values. If any exact value contains a fractional part (a value following the decimal point), the expression is evaluated using `DECIMAL` exact arithmetic and has a precision of 65 digits. (The term “exact” is subject to the limits of what can be represented in binary. For example, `1.0/3.0` can be approximated in decimal notation as `.333...`, but not written as an exact number, so `(1.0/3.0)*3.0` does not evaluate to exactly `1.0`.)
- Otherwise, the expression contains only integer values. The expression is exact and is evaluated using integer arithmetic and has a precision the same as `BIGINT` (64 bits).

If a numeric expression contains any strings, they are converted to double-precision floating-point values and the expression is approximate.

Inserts into numeric columns are affected by the SQL mode, which is controlled by the `sql_mode` system variable. (See [Section 5.1.7, “Server SQL Modes”](#).) The following discussion mentions strict mode (selected by the `STRICT_ALL_TABLES` or `STRICT_TRANS_TABLES` mode values) and `ERROR_FOR_DIVISION_BY_ZERO`. To turn on all restrictions, you can simply use `TRADITIONAL` mode, which includes both strict mode values and `ERROR_FOR_DIVISION_BY_ZERO`:

```
mysql> SET sql_mode='TRADITIONAL';
```

If a number is inserted into an exact type column (`DECIMAL` or integer), it is inserted with its exact value if it is within the column range.

If the value has too many digits in the fractional part, rounding occurs and a warning is generated. Rounding is done as described in [Section 11.14.4, “Rounding Behavior”](#).

If the value has too many digits in the integer part, it is too large and is handled as follows:

- If strict mode is not enabled, the value is truncated to the nearest legal value and a warning is generated.
- If strict mode is enabled, an overflow error occurs.

Underflow is not detected, so underflow handling is undefined.

By default, division by zero produces a result of `NULL` and no warning. With the `ERROR_FOR_DIVISION_BY_ZERO` SQL mode enabled, MySQL handles division by zero differently:

- If strict mode is not enabled, a warning occurs.
- If strict mode is enabled, inserts and updates involving division by zero are prohibited, and an error occurs.

In other words, inserts and updates involving expressions that perform division by zero can be treated as errors, but this requires `ERROR_FOR_DIVISION_BY_ZERO` in addition to strict mode.

Suppose that we have this statement:

```
INSERT INTO t SET i = 1/0;
```

This is what happens for combinations of strict and `ERROR_FOR_DIVISION_BY_ZERO` modes.

<code>sql_mode</code> Value	Result
-----------------------------	--------

' ' (Default)	No warning, no error; <i>i</i> is set to <code>NULL</code> .
strict	No warning, no error; <i>i</i> is set to <code>NULL</code> .
<code>ERROR_FOR_DIVISION_BY_ZERO</code>	Warning, no error; <i>i</i> is set to <code>NULL</code> .
strict, <code>ERROR_FOR_DIVISION_BY_ZERO</code>	Error condition; no row is inserted.

For inserts of strings into numeric columns, conversion from string to number is handled as follows if the string has non-numeric contents:

- A string that does not begin with a number cannot be used as a number and produces an error in strict mode, or a warning otherwise. *This includes the empty string.*
- A string that begins with a number can be converted, but the trailing non-numeric portion is truncated. If the truncated portion contains anything other than spaces, this produces an error in strict mode, or a warning otherwise.

## 11.14.4. Rounding Behavior

This section discusses precision math rounding for the `ROUND()` function and for inserts into columns with exact-value types (`DECIMAL` and integer).

The `ROUND()` function rounds differently depending on whether its argument is exact or approximate:

- For exact-value numbers, `ROUND()` uses the “round half up” rule: A value with a fractional part of .5 or greater is rounded up to the next integer if positive or down to the next integer if negative. (In other words, it is rounded away from zero.) A value with a fractional part less than .5 is rounded down to the next integer if positive or up to the next integer if negative.
- For approximate-value numbers, the result depends on the C library. On many systems, this means that `ROUND()` uses the “round to nearest even” rule: A value with any fractional part is rounded to the nearest even integer.

The following example shows how rounding differs for exact and approximate values:

```
mysql> SELECT ROUND(2.5), ROUND(25E-1);
+-----+-----+
| ROUND(2.5) | ROUND(25E-1) |
+-----+-----+
| 3          | 2            |
+-----+-----+
```

For inserts into a `DECIMAL` or integer column, the target is an exact data type, so rounding uses “round half up,” regardless of whether the value to be inserted is exact or approximate:

```
mysql> CREATE TABLE t (d DECIMAL(10,0));
Query OK, 0 rows affected (0.00 sec)

mysql> INSERT INTO t VALUES(2.5),(2.5E0);
Query OK, 2 rows affected, 2 warnings (0.00 sec)
Records: 2 Duplicates: 0 Warnings: 2

mysql> SELECT d FROM t;
+-----+
| d     |
+-----+
| 3     |
| 3     |
+-----+
```

## 11.14.5. Precision Math Examples

This section provides some examples that show precision math query results in MySQL 5.1.

**Example 1.** Numbers are used with their exact value as given when possible:

```
mysql> SELECT .1 + .2 = .3;
+-----+
| .1 + .2 = .3 |
+-----+
| 1            |
+-----+
```

For floating-point values, results are inexact:

```
mysql> SELECT .1E0 + .2E0 = .3E0;
+-----+
| .1E0 + .2E0 = .3E0 |
+-----+
| 0 |
+-----+
```

Another way to see the difference in exact and approximate value handling is to add a small number to a sum many times. Consider the following stored procedure, which adds `.0001` to a variable 1,000 times.

```
CREATE PROCEDURE p ()
BEGIN
  DECLARE i INT DEFAULT 0;
  DECLARE d DECIMAL(10,4) DEFAULT 0;
  DECLARE f FLOAT DEFAULT 0;
  WHILE i < 10000 DO
    SET d = d + .0001;
    SET f = f + .0001E0;
    SET i = i + 1;
  END WHILE;
  SELECT d, f;
END;
```

The sum for both `d` and `f` logically should be 1, but that is true only for the decimal calculation. The floating-point calculation introduces small errors:

```
+-----+-----+
| d      | f      |
+-----+-----+
| 1.0000 | 0.99999999999991 |
+-----+-----+
```

**Example 2.** Multiplication is performed with the scale required by standard SQL. That is, for two numbers `X1` and `X2` that have scale `S1` and `S2`, the scale of the result is `S1 + S2`:

```
mysql> SELECT .01 * .01;
+-----+
| .01 * .01 |
+-----+
| 0.0001 |
+-----+
```

**Example 3.** Rounding behavior is well-defined:

Rounding behavior (for example, with the `ROUND()` function) is independent of the implementation of the underlying C library, which means that results are consistent from platform to platform.

Rounding for exact-value columns (`DECIMAL` and integer) and exact-valued numbers uses the “round half up” rule. Values with a fractional part of `.5` or greater are rounded away from zero to the nearest integer, as shown here:

```
mysql> SELECT ROUND(2.5), ROUND(-2.5);
+-----+-----+
| ROUND(2.5) | ROUND(-2.5) |
+-----+-----+
| 3 | -3 |
+-----+-----+
```

However, rounding for floating-point values uses the C library, which on many systems uses the “round to nearest even” rule. Values with any fractional part on such systems are rounded to the nearest even integer:

```
mysql> SELECT ROUND(2.5E0), ROUND(-2.5E0);
+-----+-----+
| ROUND(2.5E0) | ROUND(-2.5E0) |
+-----+-----+
| 2 | -2 |
+-----+-----+
```

**Example 4.** In strict mode, inserting a value that is too large results in overflow and causes an error, rather than truncation to a legal value.

When MySQL is not running in strict mode, truncation to a legal value occurs:

```
mysql> SET sql_mode='';
Query OK, 0 rows affected (0.00 sec)

mysql> CREATE TABLE t (i TINYINT);
Query OK, 0 rows affected (0.01 sec)
```

```
mysql> INSERT INTO t SET i = 128;
Query OK, 1 row affected, 1 warning (0.00 sec)

mysql> SELECT i FROM t;
+-----+
| i     |
+-----+
| 127  |
+-----+
1 row in set (0.00 sec)
```

However, an overflow condition occurs if strict mode is in effect:

```
mysql> SET sql_mode='STRICT_ALL_TABLES';
Query OK, 0 rows affected (0.00 sec)

mysql> CREATE TABLE t (i TINYINT);
Query OK, 0 rows affected (0.00 sec)

mysql> INSERT INTO t SET i = 128;
ERROR 1264 (22003): Out of range value adjusted for column 'i' at row 1

mysql> SELECT i FROM t;
Empty set (0.00 sec)
```

**Example 5:** In strict mode and with `ERROR_FOR_DIVISION_BY_ZERO` set, division by zero causes an error, and not a result of `NULL`.

In non-strict mode, division by zero has a result of `NULL`:

```
mysql> SET sql_mode='';
Query OK, 0 rows affected (0.01 sec)

mysql> CREATE TABLE t (i TINYINT);
Query OK, 0 rows affected (0.00 sec)

mysql> INSERT INTO t SET i = 1 / 0;
Query OK, 1 row affected (0.00 sec)

mysql> SELECT i FROM t;
+-----+
| i     |
+-----+
| NULL  |
+-----+
1 row in set (0.03 sec)
```

However, division by zero is an error if the proper SQL modes are in effect:

```
mysql> SET sql_mode='STRICT_ALL_TABLES,ERROR_FOR_DIVISION_BY_ZERO';
Query OK, 0 rows affected (0.00 sec)

mysql> CREATE TABLE t (i TINYINT);
Query OK, 0 rows affected (0.00 sec)

mysql> INSERT INTO t SET i = 1 / 0;
ERROR 1365 (22012): Division by 0

mysql> SELECT i FROM t;
Empty set (0.01 sec)
```

**Example 6.** Prior to MySQL 5.0.3 (before precision math was introduced), exact-value and approximate-value literals both are converted to double-precision floating-point values:

```
mysql> SELECT VERSION();
+-----+
| VERSION() |
+-----+
| 4.1.18-log |
+-----+
1 row in set (0.01 sec)

mysql> CREATE TABLE t SELECT 2.5 AS a, 25E-1 AS b;
Query OK, 1 row affected (0.07 sec)
Records: 1 Duplicates: 0 Warnings: 0

mysql> DESCRIBE t;
+-----+-----+-----+-----+-----+-----+
| Field | Type          | Null | Key | Default | Extra |
+-----+-----+-----+-----+-----+-----+
| a     | double(3,1)  |      |     | 0.0     |       |
| b     | double       |      |     | 0       |       |
+-----+-----+-----+-----+-----+-----+
2 rows in set (0.04 sec)
```

As of MySQL 5.0.3, the approximate-value literal still is converted to floating-point, but the exact-value literal is handled as `DECIMAL`:

```
mysql> SELECT VERSION();
+-----+
| VERSION() |
+-----+
| 5.1.6-alpha-log |
+-----+
1 row in set (0.11 sec)

mysql> CREATE TABLE t SELECT 2.5 AS a, 25E-1 AS b;
Query OK, 1 row affected (0.01 sec)
Records: 1 Duplicates: 0 Warnings: 0

mysql> DESCRIBE t;
+-----+-----+-----+-----+-----+-----+
| Field | Type                | Null | Key | Default | Extra |
+-----+-----+-----+-----+-----+-----+
| a     | decimal(2,1) unsigned | NO   |     | 0.0     |      |
| b     | double              | NO   |     | 0       |      |
+-----+-----+-----+-----+-----+-----+
2 rows in set (0.01 sec)
```

**Example 7.** If the argument to an aggregate function is an exact numeric type, the result is also an exact numeric type, with a scale at least that of the argument.

Consider these statements:

```
mysql> CREATE TABLE t (i INT, d DECIMAL, f FLOAT);
mysql> INSERT INTO t VALUES(1,1,1);
mysql> CREATE TABLE y SELECT AVG(i), AVG(d), AVG(f) FROM t;
```

Result before MySQL 5.0.3 (prior to the introduction of precision math in MySQL):

```
mysql> DESCRIBE y;
+-----+-----+-----+-----+-----+-----+
| Field | Type                | Null | Key | Default | Extra |
+-----+-----+-----+-----+-----+-----+
| AVG(i) | double(17,4)       | YES  |     | NULL    |      |
| AVG(d) | double(17,4)       | YES  |     | NULL    |      |
| AVG(f) | double             | YES  |     | NULL    |      |
+-----+-----+-----+-----+-----+-----+
```

The result is a double no matter the argument type.

Result as of MySQL 5.0.3:

```
mysql> DESCRIBE y;
+-----+-----+-----+-----+-----+-----+
| Field | Type                | Null | Key | Default | Extra |
+-----+-----+-----+-----+-----+-----+
| AVG(i) | decimal(14,4)       | YES  |     | NULL    |      |
| AVG(d) | decimal(14,4)       | YES  |     | NULL    |      |
| AVG(f) | double             | YES  |     | NULL    |      |
+-----+-----+-----+-----+-----+-----+
```

The result is a double only for the floating-point argument. For exact type arguments, the result is also an exact type.

---

# Chapter 12. SQL Statement Syntax

This chapter describes the syntax for the SQL statements supported by MySQL.

## 12.1. Data Definition Statements

### 12.1.1. ALTER DATABASE Syntax

```
ALTER {DATABASE | SCHEMA} [db_name]
    alter_specification ...
ALTER {DATABASE | SCHEMA} db_name
    UPGRADE DATA DIRECTORY NAME

alter_specification:
    [DEFAULT] CHARACTER SET [=] charset_name
    | [DEFAULT] COLLATE [=] collation_name
```

`ALTER DATABASE` enables you to change the overall characteristics of a database. These characteristics are stored in the `db.opt` file in the database directory. To use `ALTER DATABASE`, you need the `ALTER` privilege on the database. `ALTER SCHEMA` is a synonym for `ALTER DATABASE`.

The `CHARACTER SET` clause changes the default database character set. The `COLLATE` clause changes the default database collation. Section 9.1, “Character Set Support”, discusses character set and collation names.

You can see what character sets and collations are available using, respectively, the `SHOW CHARACTER SET` and `SHOW COLLATION` statements. See Section 12.5.5.4, “`SHOW CHARACTER SET Syntax`”, and Section 12.5.5.5, “`SHOW COLLATION Syntax`”, for more information.

The database name can be omitted from the first syntax, in which case the statement applies to the default database.

The syntax that includes the `UPGRADE DATA DIRECTORY NAME` clause was added in MySQL 5.1.23. It updates the name of the directory associated with the database to use the encoding implemented in MySQL 5.1 for mapping database names to database directory names (see Section 8.2.3, “Mapping of Identifiers to File Names”). This clause is for use under these conditions:

- It is intended when upgrading MySQL to 5.1 or later from older versions.
- It is intended to update a database directory name to the current encoding format if the name contains special characters that need encoding.
- The statement is used by `mysqlcheck` (as invoked by `mysql_upgrade`).

For example, if a database in MySQL 5.0 has a name of `a-b-c`, the name contains instance of the ‘-’ character. In 5.0, the database directory is also named `a-b-c`, which is not necessarily safe for all file systems. In MySQL 5.1 and up, the same database name is encoded as `a@002db@002dc` to produce a file system-neutral directory name.

When a MySQL installation is upgraded to MySQL 5.1 or later from an older version, the server displays a name such as `a-b-c` (which is in the old format) as `#mysql150#a-b-c`, and you must refer to the name using the `#mysql150#` prefix. Use `UPGRADE DATA DIRECTORY NAME` in this case to explicitly tell the server to re-encode the database directory name to the current encoding format:

```
ALTER DATABASE `#mysql150#a-b-c` UPGRADE DATA DIRECTORY NAME;
```

After executing this statement, you can refer to the database as `a-b-c` without the special `#mysql150#` prefix.

#### MySQL Enterprise

In a production environment, alteration of a database is not a common occurrence and may indicate a security breach. Advisors provided as part of the MySQL Enterprise Monitor automatically alert you when data definition statements are issued. For more information, see <http://www.mysql.com/products/enterprise/advisors.html>.

### 12.1.2. ALTER EVENT Syntax

```
ALTER
    [DEFINER = { user | CURRENT_USER }]
    EVENT event_name
    [ON SCHEDULE schedule]
    [ON COMPLETION [NOT] PRESERVE]
    [RENAME TO new_event_name]
    [ENABLE | DISABLE | DISABLE ON SLAVE]
```



```
[COMMENT 'comment']
[DO sql_statement]
```

The `ALTER EVENT` statement is used to change one or more of the characteristics of an existing event without the need to drop and recreate it. The syntax for each of the `DEFINER`, `ON SCHEDULE`, `ON COMPLETION`, `COMMENT`, `ENABLE / DISABLE`, and `DO` clauses is exactly the same as when used with `CREATE EVENT`. (See [Section 12.1.11, “CREATE EVENT Syntax”](#).)

Support for the `DEFINER` clause was added in MySQL 5.1.17.

Beginning with MySQL 5.1.12, this statement requires the `EVENT` privilege. When a user executes a successful `ALTER EVENT` statement, that user becomes the definer for the affected event.

(In MySQL 5.1.11 and earlier, an event could be altered only by its definer, or by a user having the `SUPER` privilege.)

`ALTER EVENT` works only with an existing event:

```
mysql> ALTER EVENT no_such_event
> ON SCHEDULE
> EVERY '2:3' DAY_HOUR;
ERROR 1517 (HY000): UNKNOWN EVENT 'NO_SUCH_EVENT'
```

In each of the following examples, assume that the event named `myevent` is defined as shown here:

```
CREATE EVENT myevent
ON SCHEDULE
EVERY 6 HOUR
COMMENT 'A sample comment.'
DO
UPDATE myschema.mytable SET mycol = mycol + 1;
```

The following statement changes the schedule for `myevent` from once every six hours starting immediately to once every twelve hours, starting four hours from the time the statement is run:

```
ALTER EVENT myevent
ON SCHEDULE
EVERY 12 HOUR
STARTS CURRENT_TIMESTAMP + INTERVAL 4 HOUR;
```

It is possible to change multiple characteristics of an event in a single statement. This example changes the SQL statement executed by `myevent` to one that deletes all records from `mytable`; it also changes the schedule for the event such that it executes once, one day after this `ALTER EVENT` statement is run.

```
ALTER TABLE myevent
ON SCHEDULE
AT CURRENT_TIMESTAMP + INTERVAL 1 DAY
DO
TRUNCATE TABLE myschema.mytable;
```

It is necessary to include only those options in an `ALTER EVENT` statement which correspond to characteristics that you actually wish to change; options which are omitted retain their existing values. This includes any default values for `CREATE EVENT` such as `ENABLE`.

To disable `myevent`, use this `ALTER EVENT` statement:

```
ALTER EVENT myevent
DISABLE;
```

The `ON SCHEDULE` clause may use expressions involving built-in MySQL functions and user variables to obtain any of the `timestamp` or `interval` values which it contains. You may not use stored routines or user-defined functions in such expressions, nor may you use any table references; however, you may use `SELECT FROM DUAL`. This is true for both `ALTER EVENT` and `CREATE EVENT` statements. Beginning with MySQL 5.1.13, references to stored routines, user-defined functions, and tables in such cases are specifically disallowed, and fail with an error (see [Bug#22830](#)).

An `ALTER EVENT` statement that contains another `ALTER EVENT` statement in its `DO` clause appears to succeed; however, when the server attempts to execute the resulting scheduled event, the execution fails with an error.

To rename an event, use the `ALTER EVENT` statement's `RENAME TO` clause. This statement renames the event `myevent` to `yourevent`:

```
ALTER EVENT myevent
RENAME TO yourevent;
```

You can also move an event to a different database using `ALTER EVENT ... RENAME TO ...` and

`db_name.event_name` notation, as shown here:

```
ALTER EVENT olddb.myevent
  RENAME TO newdb.myevent;
```

To execute the previous statement, the user executing it must have the `EVENT` privilege on both the `olddb` and `newdb` databases.

### Note

There is no `RENAME EVENT` statement.

Beginning with MySQL 5.1.18, a third value may also appear in place of `ENABLED` or `DISABLED`; `DISABLE ON SLAVE` is used on a replication slave to indicate an event which was created on the master and replicated to the slave, but which is not executed on the slave. Normally, `DISABLE ON SLAVE` is set automatically as required; however, there are some circumstances under which you may want or need to change it manually. See [Section 16.3.1.7, “Replication of Invoked Features”](#), for more information.

## 12.1.3. ALTER LOGFILE GROUP Syntax

```
ALTER LOGFILE GROUP logfile_group
  ADD UNDOFILE 'file_name'
  [INITIAL_SIZE [=] size]
  [WAIT]
  ENGINE [=] engine_name
```

This statement adds an `UNDO` file named `'file_name'` to an existing log file group `logfile_group`. An `ALTER LOGFILE GROUP` statement has one and only one `ADD UNDOFILE` clause. No `DROP UNDOFILE` clause is currently supported.

### Note

All MySQL Cluster Disk Data objects share the same namespace. This means that *each Disk Data object* must be uniquely named (and not merely each Disk Data object of a given type). For example, you cannot have a tablespace and an undo log file with the same name, or an undo log file and a data file with the same name.

Prior to MySQL Cluster NDB 6.2.17, 6.3.23, and 6.4.3, path and file names for undo log files could not be longer than 128 characters. ([Bug#31769](#))

The optional `INITIAL_SIZE` parameter sets the `UNDO` file's initial size in bytes; if not specified, the initial size default to `128M` (128 megabytes). You may optionally follow `size` with a one-letter abbreviation for an order of magnitude, similar to those used in `my.cnf`. Generally, this is one of the letters `M` (for megabytes) or `G` (for gigabytes).

On 32-bit systems, the maximum supported value for `INITIAL_SIZE` is `4G`. ([Bug#29186](#))

Beginning with MySQL Cluster NDB 2.1.18, 6.3.24, and 7.0.4, the minimum allowed value for `INITIAL_SIZE` is `1M`. ([Bug#29574](#))

### Note

`WAIT` is parsed but otherwise ignored, and so has no effect in MySQL 5.1 and MySQL Cluster NDB 6.x. It is intended for future expansion.

The `ENGINE` parameter (required) determines the storage engine which is used by this log file group, with `engine_name` being the name of the storage engine. In MySQL 5.1 and MySQL Cluster NDB 6.x, the only accepted values for `engine_name` are “`NDBCLUSTER`” and “`NDB`”. The two values are equivalent.

Here is an example, which assumes that the log file group `lg_3` has already been created using `CREATE LOGFILE GROUP` (see [Section 12.1.14, “CREATE LOGFILE GROUP Syntax”](#)):

```
ALTER LOGFILE GROUP lg_3
  ADD UNDOFILE 'undo_10.dat'
  INITIAL_SIZE=32M
  ENGINE=NDBCLUSTER;
```

When `ALTER LOGFILE GROUP` is used with `ENGINE = NDBCLUSTER` (alternatively, `ENGINE = NDB`), an `UNDO` log file is created on each MySQL Cluster data node. You can verify that the `UNDO` files were created and obtain information about them by querying the `INFORMATION_SCHEMA.FILES` table. For example:

```
mysql> SELECT FILE_NAME, LOGFILE_GROUP_NUMBER, EXTRA
-> FROM INFORMATION_SCHEMA.FILES
-> WHERE LOGFILE_GROUP_NAME = 'lg_3';
+-----+-----+-----+
| FILE_NAME | LOGFILE_GROUP_NUMBER | EXTRA |
+-----+-----+-----+
| newdata.dat | 0 | CLUSTER_NODE=3 |
```

```

newdata.dat | 0 | CLUSTER_NODE=4
undo_10.dat | 11 | CLUSTER_NODE=3
undo_10.dat | 11 | CLUSTER_NODE=4
+-----+-----+-----+
4 rows in set (0.01 sec)

```

(See [Section 19.21](#), “The `INFORMATION_SCHEMA FILES` Table”.)

`ALTER LOGFILE GROUP` was added in MySQL 5.1.6. In MySQL 5.1 and MySQL Cluster NDB 6.x, it is useful only with Disk Data storage for MySQL Cluster. For more information, see [MySQL Cluster Disk Data Tables](#).

## 12.1.4. ALTER FUNCTION Syntax

```

ALTER FUNCTION func_name [characteristic ...]

characteristic:
{ CONTAINS SQL | NO SQL | READS SQL DATA | MODIFIES SQL DATA }
| SQL SECURITY { DEFINER | INVOKER }
| COMMENT 'string'

```

This statement can be used to change the characteristics of a stored function. More than one change may be specified in an `ALTER FUNCTION` statement. However, you cannot change the parameters or body of a stored function using this statement; to make such changes, you must drop and re-create the function using `DROP FUNCTION` and `CREATE FUNCTION`.

You must have the `ALTER ROUTINE` privilege for the function. (That privilege is granted automatically to the function creator.) If binary logging is enabled, the `ALTER FUNCTION` statement might also require the `SUPER` privilege, as described in [Section 18.6](#), “Binary Logging of Stored Programs”.

## 12.1.5. ALTER PROCEDURE Syntax

```

ALTER PROCEDURE proc_name [characteristic ...]

characteristic:
{ CONTAINS SQL | NO SQL | READS SQL DATA | MODIFIES SQL DATA }
| SQL SECURITY { DEFINER | INVOKER }
| COMMENT 'string'

```

This statement can be used to change the characteristics of a stored procedure. More than one change may be specified in an `ALTER PROCEDURE` statement. However, you cannot change the parameters or body of a stored procedure using this statement; to make such changes, you must drop and re-create the procedure using `DROP PROCEDURE` and `CREATE PROCEDURE`.

You must have the `ALTER ROUTINE` privilege for the procedure. (That privilege is granted automatically to the procedure creator.)

## 12.1.6. ALTER SERVER Syntax

```

ALTER SERVER server_name
  OPTIONS (option [, option] ...)

```

Alters the server information for *server\_name*, adjusting the specified options as per the `CREATE SERVER` command. See [Section 12.1.16](#), “`CREATE SERVER` Syntax”. The corresponding fields in the `mysql.servers` table are updated accordingly. This statement requires the `SUPER` privilege.

For example, to update the `USER` option:

```

ALTER SERVER s OPTIONS (USER 'sally');

```

`ALTER SERVER` does not cause an automatic commit.

`ALTER SERVER` was added in MySQL 5.1.15.

## 12.1.7. ALTER TABLE Syntax

```

ALTER [ONLINE | OFFLINE] [IGNORE] TABLE tbl_name
  alter_specification [, alter_specification] ...

alter_specification:
col_name column_definition
  [FIRST | AFTER col_name ]
| ADD [COLUMN] (col_name column_definition,...)
| ADD {INDEX|KEY} [index_name]
  [index_type] (index_col_name,...) [index_option] ...
| ADD [CONSTRAINT [symbol]] PRIMARY KEY
  [index_type] (index_col_name,...) [index_option] ...

```

```

| ADD [CONSTRAINT [symbol]]
    UNIQUE [INDEX|KEY] [index_name]
      [index_type] (index_col_name,...) [index_option] ...
| ADD FULLTEXT [INDEX|KEY] [index_name]
      (index_col_name,...) [index_option] ...
| ADD SPATIAL [INDEX|KEY] [index_name]
      (index_col_name,...) [index_option] ...
| ADD [CONSTRAINT [symbol]]
    FOREIGN KEY [index_name] (index_col_name,...)
      reference_definition
| ALTER [COLUMN] col_name {SET DEFAULT literal | DROP DEFAULT}
| CHANGE [COLUMN] old_col_name new_col_name column_definition
      [FIRST|AFTER col_name]
| MODIFY [COLUMN] col_name column_definition
      [FIRST | AFTER col_name]
| DROP [COLUMN] col_name
| DROP PRIMARY KEY
| DROP {INDEX|KEY} index_name
| DROP FOREIGN KEY fk_symbol
| DISABLE KEYS
| ENABLE KEYS
| RENAME [TO] new_tbl_name
| ORDER BY col_name [, col_name] ...
| CONVERT TO CHARACTER SET charset_name [COLLATE collation_name]
| [DEFAULT] CHARACTER SET [=] charset_name [COLLATE [=] collation_name]
| DISCARD TABLESPACE
| IMPORT TABLESPACE
| partition_options
| ADD PARTITION (partition_definition)
| DROP PARTITION partition_names
| COALESCE PARTITION number
| REORGANIZE PARTITION [partition_names INTO (partition_definitions)]
| ANALYZE PARTITION partition_names
| CHECK PARTITION partition_names
| OPTIMIZE PARTITION partition_names
| REBUILD PARTITION partition_names
| REPAIR PARTITION partition_names
| REMOVE PARTITIONING

index_col_name:
  col_name [(length)] [ASC | DESC]

index_type:
  USING {BTREE | HASH | RTREE}

index_option:
  KEY_BLOCK_SIZE [=] value
  | index_type
  | WITH PARSER parser_name
  | COMMENT 'string'

table_option [[,] table_option] ...

```

**ALTER TABLE** enables you to change the structure of an existing table. For example, you can add or delete columns, create or destroy indexes, change the type of existing columns, or rename columns or the table itself. You can also change the comment for the table and type of the table.

The syntax for many of the allowable alterations is similar to clauses of the **CREATE TABLE** statement. See [Section 12.1.17, “CREATE TABLE Syntax”](#), for more information.

Some operations may result in warnings if attempted on a table for which the storage engine does not support the operation. These warnings can be displayed with **SHOW WARNINGS**. See [Section 12.5.5.42, “SHOW WARNINGS Syntax”](#).

In most cases, **ALTER TABLE** works by making a temporary copy of the original table. The alteration is performed on the copy, and then the original table is deleted and the new one is renamed. While **ALTER TABLE** is executing, the original table is readable by other sessions. Updates and writes to the table are stalled until the new table is ready, and then are automatically redirected to the new table without any failed updates. The temporary table is created in the database directory of the new table. This can be different from the database directory of the original table if **ALTER TABLE** is renaming the table to a different database.

In some cases, no temporary table is necessary:

- Alterations that modify only table metadata and not table data can be made immediately by altering the table's `.frm` file and not touching table contents. The following changes are fast alterations that can be made this way:
  - Renaming a column or index.
  - Changing the default value of a column.
  - Changing the definition of an **ENUM** or **SET** column by adding new enumeration or set members to the *end* of the list of valid member values.

In some cases, an operation such as changing a **VARCHAR(10)** column to **VARCHAR(15)** may be immediate, but this depends on the storage engine for the table. A change such as **VARCHAR(10)** to a length greater than 255 is not immediate be-

cause data values must be modified from using one byte to store the length to using two bytes.

- If you use `ALTER TABLE tbl_name RENAME TO new_tbl_name` without any other options, MySQL simply renames any files that correspond to the table *tbl\_name*. (You can also use the `RENAME TABLE` statement to rename tables. See [Section 12.1.33, “RENAME TABLE Syntax”](#).) Any privileges granted specifically for the renamed table are not migrated to the new name. They must be changed manually.
- `ALTER TABLE ... ADD PARTITION` creates no temporary table except for MySQL Cluster. `ADD` or `DROP` operations for `RANGE` or `LIST` partitions are immediate operations or nearly so. `ADD` or `COALESCE` operations for `HASH` or `KEY` partitions copy data between changed partitions; unless `LINEAR HASH` or `LINEAR KEY` was used, this is much the same as creating a new table (although the operation is done partition by partition). `REORGANIZE` operations copy only changed partitions and do not touch unchanged ones.

If other cases, MySQL creates a temporary table, even if the data wouldn't strictly need to be copied. For `MyISAM` tables, you can speed up the index re-creation operation (which is the slowest part of the alteration process) by setting the `mysiam_sort_buffer_size` system variable to a high value.

For information on troubleshooting `ALTER TABLE`, see [Section B.1.7.1, “Problems with ALTER TABLE”](#).

- To use `ALTER TABLE`, you need `ALTER`, `INSERT`, and `CREATE` privileges for the table.
- Beginning with MySQL 5.1.7, `ADD INDEX` and `DROP INDEX` operations are performed online when the indexes are on variable-width columns only.

The `ONLINE` keyword can be used to perform online `ADD COLUMN`, `ADD INDEX` (including `CREATE INDEX` statements), and `DROP INDEX` operations on `NDBCLUSTER` tables beginning with MySQL Cluster NDB 6.2.5 and MySQL Cluster NDB 6.3.3. Online renaming of `NDBCLUSTER` tables is also supported.

Currently you cannot add disk-based columns to `NDBCLUSTER` tables online. This means that, if you wish to add an in-memory column to an `NDBCLUSTER` table that uses a table-level `STORAGE DISK` option, you must declare the new column as using memory-based storage explicitly. For example — assuming that you have already created tablespace `ts1` — suppose that you create table `t1` as follows:

```
mysql> CREATE TABLE t1 (
>   c1 INT NOT NULL PRIMARY KEY,
>   c2 VARCHAR(30)
> )
> TABLESPACE ts1 STORAGE DISK
> ENGINE NDBCLUSTER;
Query OK, 0 rows affected (1.73 sec)
Records: 0 Duplicates: 0 Warnings: 0
```

You can add a new in-memory column to this table online as shown here:

```
mysql> ALTER ONLINE TABLE t1 ADD COLUMN c3 INT COLUMN_FORMAT DYNAMIC STORAGE MEMORY;
Query OK, 0 rows affected (1.25 sec)
Records: 0 Duplicates: 0 Warnings: 0
```

This statement fails if the `STORAGE MEMORY` option is omitted:

```
mysql> ALTER ONLINE TABLE t1 ADD COLUMN c3 INT COLUMN_FORMAT DYNAMIC;
ERROR 1235 (42000): THIS VERSION OF MYSQL DOESN'T YET SUPPORT
'ALTER ONLINE TABLE t1 ADD COLUMN c3 INT COLUMN_FORMAT DYNAMIC'
```

If you omit the `COLUMN_FORMAT DYNAMIC` option, the dynamic column format is employed automatically, but a warning is issued, as shown here:

```
mysql> ALTER ONLINE TABLE t1 ADD COLUMN c3 INT STORAGE MEMORY;
Query OK, 0 rows affected, 1 warning (1.17 sec)
Records: 0 Duplicates: 0 Warnings: 0

mysql> SHOW WARNINGS;
+-----+-----+-----+
| Level | Code | Message                                                                 |
+-----+-----+-----+
| Warning | 1478 | Converted FIXED field to DYNAMIC to enable on-line ADD COLUMN |
+-----+-----+-----+
1 row in set (0.00 sec)

mysql> SHOW CREATE TABLE t1\G
***** 1. row *****
Table: t1
Create Table: CREATE TABLE `t1` (
  `c1` int(11) NOT NULL,
  `c2` varchar(30) DEFAULT NULL,
  `c3` int(11) /*!50120 STORAGE MEMORY */ /*!50120 COLUMN_FORMAT DYNAMIC */ DEFAULT NULL,
```

```

`t4` int(11) /*!50120 STORAGE MEMORY */ DEFAULT NULL,
PRIMARY KEY (`c1`)
) /*!50100 TABLESPACE ts_1 STORAGE DISK */ ENGINE=ndbcluster DEFAULT CHARSET=latin1
1 row in set (0.03 sec)

```

Prior to MySQL Cluster NDB 6.2.17, 6.3.23, and 6.4.3, adding in-memory columns to tables that were created using a table-level or column-level `STORAGE DISK` option did not work correctly. ([Bug#42549](#))

It is also possible to rename `MyISAM` tables and columns online. However, you cannot use `ONLINE` with operations that add or drop columns or indexes of `MyISAM` tables.

Online operations are non-copying; that is, they do not require that indexes be re-created. They do not lock the table being altered from access by other API nodes in a MySQL Cluster (but see *Limitations* later in this section). Such operations do not require single user mode for `NDBCLUSTER` table alterations made in a cluster with multiple API nodes; transactions can continue uninterrupted during online DDL operations.

In MySQL Cluster NDB 7.0, it is also possible to use the statement `ALTER ONLINE TABLE ... REORGANIZE PARTITION` with no `partition_names INTO (partition_definitions)` option on `NDBCLUSTER` tables. This can be used to redistribute MySQL Cluster data among new data nodes that have been added to the cluster online. More information about this statement is given later in this section. For more information about adding data nodes online to a MySQL Cluster, see [Adding MySQL Cluster Data Nodes Online](#).

Prior to MySQL Cluster NDB 6.4.3, `ALTER ONLINE TABLE ... REORGANIZE PARTITION` with no `partition_names INTO (partition_definitions)` option did not work correctly with Disk Data tables or with in-memory `NDBCLUSTER` tables having one or more disk-based columns. ([Bug#42549](#))

The `ONLINE` and `OFFLINE` keywords are supported only in MySQL Cluster NDB 6.2, 6.3, 7.0 (beginning with versions 6.2.5, 6.3.3, and 6.4.0), and later MySQL Cluster release series. In other versions of MySQL (5.1.17 and later):

1. The server determines automatically whether an `ADD INDEX` or `DROP INDEX` operation can be (and is) performed online or offline; if the column is of a variable-width data type, then the operation is performed online. It is not possible to override the server behavior in this regard.
2. Attempting to use the `ONLINE` or `OFFLINE` keyword in an `ALTER TABLE` statement results in an error.

**Limitations.** Online `ALTER TABLE` operations that add columns are subject to the following limitations:

- The table being altered is not locked with respect to API nodes other than the one on which an online `ALTER TABLE`, `ADD COLUMN`, `CREATE INDEX` or `DROP INDEX` statement is run. However, the table is locked against any other operations originating on the *same* API node while the online operation is being executed.
- The table to be altered must have an explicit primary key; the hidden primary key created by the `NDBCLUSTER` storage engine is not sufficient for this purpose. Columns to be added online must meet the following criteria:
  - Such columns must be dynamic; that is, it must be possible to create them using `COLUMN_FORMAT DYNAMIC`.
  - Such columns must be nullable, and not have any explicit default value other than `NULL`. Columns added online are automatically created as `DEFAULT NULL`, as can be seen here:

```

mysql> CREATE TABLE t1 (
>   c1 INT NOT NULL AUTO_INCREMENT PRIMARY KEY
> ) ENGINE=NDBCLUSTER;
Query OK, 0 rows affected (1.44 sec)

mysql> ALTER ONLINE TABLE t1
>   ADD COLUMN c2 INT,
>   ADD COLUMN c3 INT;
Query OK, 0 rows affected, 2 warnings (0.93 sec)

mysql> SHOW CREATE TABLE t2\G
***** 1. row *****
      Table: t2
Create Table: CREATE TABLE `t2` (
  `c1` int(11) NOT NULL AUTO_INCREMENT,
  `c2` int(11) DEFAULT NULL,
  `c3` int(11) DEFAULT NULL,
  PRIMARY KEY (`c1`)
) ENGINE=ndbcluster DEFAULT CHARSET=latin1
1 row in set (0.00 sec)

```

- Columns must be added following any existing columns. If you attempt to add a column online before any existing columns, the statement fails with an error. Trying to add a column online using the `FIRST` keyword also fails.

In addition, existing table columns cannot be reordered online.

- The storage engine used by the table cannot be changed online.

The preceding limitations do not apply to operations that merely rename tables or columns.

If the storage engine supports online `ALTER TABLE`, then fixed-format columns will be converted to dynamic when columns are added online, or when indexes are created or dropped online, as shown here:

```
mysql> CREATE TABLE t1 (
>   c1 INT NOT NULL AUTO_INCREMENT PRIMARY KEY
> ) ENGINE=NDBCLUSTER;
Query OK, 0 rows affected (1.44 sec)

mysql> ALTER ONLINE TABLE t1 ADD COLUMN c2 INT, ADD COLUMN c3 INT;
Query OK, 0 rows affected, 2 warnings (0.93 sec)
Records: 0 Duplicates: 0 Warnings: 0

mysql> SHOW WARNINGS;
+-----+-----+-----+
| Level | Code | Message
+-----+-----+-----+
| Warning | 1475 | Converted FIXED field to DYNAMIC to enable on-line ADD COLUMN
| Warning | 1475 | Converted FIXED field to DYNAMIC to enable on-line ADD COLUMN
+-----+-----+-----+
2 rows in set (0.00 sec)
```

## Note

Existing columns, including the table's primary key, need not be dynamic; only the column or columns to be added online must be dynamic.

```
mysql> CREATE TABLE t2 (
>   c1 INT NOT NULL AUTO_INCREMENT PRIMARY KEY COLUMN_FORMAT FIXED
> ) ENGINE=NDBCLUSTER;
Query OK, 0 rows affected (2.10 sec)

mysql> ALTER ONLINE TABLE t2 ADD COLUMN c2 INT;
Query OK, 0 rows affected, 1 warning (0.78 sec)
Records: 0 Duplicates: 0 Warnings: 0

mysql> SHOW WARNINGS;
+-----+-----+-----+
| Level | Code | Message
+-----+-----+-----+
| Warning | 1475 | Converted FIXED field to DYNAMIC to enable on-line ADD COLUMN
+-----+-----+-----+
1 row in set (0.00 sec)
```

Columns are not converted from `FIXED` to `DYNAMIC` column format by renaming operations. For more information about `COLUMN_FORMAT`, see [Section 12.1.17, “CREATE TABLE Syntax”](#).

- Online `DROP COLUMN` operations are not supported.
- A given online `ALTER TABLE` can use only one of `ADD COLUMN`, `ADD INDEX`, or `DROP INDEX`. One or more columns can be added online in a single statement; only one index may be created or dropped online in a single statement.

The `KEY`, `CONSTRAINT`, and `IGNORE` keywords are supported in `ALTER TABLE` statements using the `ONLINE` keyword.

The `ONLINE` and `OFFLINE` keywords are also supported in `ALTER TABLE ... CHANGE ...` statements that rename columns of `MyISAM` tables.

- `IGNORE` is a MySQL extension to standard SQL. It controls how `ALTER TABLE` works if there are duplicates on unique keys in the new table or if warnings occur when strict mode is enabled. If `IGNORE` is not specified, the copy is aborted and rolled back if duplicate-key errors occur. If `IGNORE` is specified, only the first row is used of rows with duplicates on a unique key. The other conflicting rows are deleted. Incorrect values are truncated to the closest matching acceptable value.
- `table_option` signifies a table option of the kind that can be used in the `CREATE TABLE` statement, such as `ENGINE`, `AUTO_INCREMENT`, or `AVG_ROW_LENGTH`. ([Section 12.1.17, “CREATE TABLE Syntax”](#), lists all table options.) However, `ALTER TABLE` ignores the `DATA DIRECTORY` and `INDEX DIRECTORY` table options.

For example, to convert a table to be an `InnoDB` table, use this statement:

```
ALTER TABLE t1 ENGINE = InnoDB;
```

The outcome of attempting to change a table's storage engine is affected by whether the desired storage engine is available and the setting of the `NO_ENGINE_SUBSTITUTION` SQL mode, as described in [Section 5.1.7, “Server SQL Modes”](#).

As of MySQL 5.1.11, to prevent inadvertent loss of data, `ALTER TABLE` cannot be used to change the storage engine of a table to `MERGE` or `BLACKHOLE`.



To change the value of the `AUTO_INCREMENT` counter to be used for new rows, do this:

```
ALTER TABLE t2 AUTO_INCREMENT = value;
```

You cannot reset the counter to a value less than or equal to any that have already been used. For `MyISAM`, if the value is less than or equal to the maximum value currently in the `AUTO_INCREMENT` column, the value is reset to the current maximum plus one. For `InnoDB`, if the value is less than the current maximum value in the column, no error occurs and the current sequence value is not changed.

- You can issue multiple `ADD`, `ALTER`, `DROP`, and `CHANGE` clauses in a single `ALTER TABLE` statement, separated by commas. This is a MySQL extension to standard SQL, which allows only one of each clause per `ALTER TABLE` statement. For example, to drop multiple columns in a single statement, do this:

```
ALTER TABLE t2 DROP COLUMN c, DROP COLUMN d;
```

- `CHANGE col_name`, `DROP col_name`, and `DROP INDEX` are MySQL extensions to standard SQL.
- `MODIFY` is an Oracle extension to `ALTER TABLE`.
- The word `COLUMN` is optional and can be omitted.
- `column_definition` clauses use the same syntax for `ADD` and `CHANGE` as for `CREATE TABLE`. See [Section 12.1.17, “CREATE TABLE Syntax”](#).
- You can rename a column using a `CHANGE old_col_name new_col_name column_definition` clause. To do so, specify the old and new column names and the definition that the column currently has. For example, to rename an `INTEGER` column from `a` to `b`, you can do this:

```
ALTER TABLE t1 CHANGE a b INTEGER;
```

If you want to change a column's type but not the name, `CHANGE` syntax still requires an old and new column name, even if they are the same. For example:

```
ALTER TABLE t1 CHANGE b b BIGINT NOT NULL;
```

You can also use `MODIFY` to change a column's type without renaming it:

```
ALTER TABLE t1 MODIFY b BIGINT NOT NULL;
```

When you use `CHANGE` or `MODIFY`, `column_definition` must include the data type and all attributes that should apply to the new column, other than index attributes such as `PRIMARY KEY` or `UNIQUE`. Attributes present in the original definition but not specified for the new definition are not carried forward. Suppose a column `col1` is defined as `INT UNSIGNED DEFAULT 1 COMMENT 'my column'` and you modify the column as follows:

```
ALTER TABLE t1 MODIFY col1 BIGINT;
```

The resulting column will be defined as `BIGINT`, but will not include the attributes `UNSIGNED DEFAULT 1 COMMENT 'my column'`. To retain them, the statement should be:

```
ALTER TABLE t1 MODIFY col1 BIGINT UNSIGNED DEFAULT 1 COMMENT 'my column';
```

- When you change a data type using `CHANGE` or `MODIFY`, MySQL tries to convert existing column values to the new type as well as possible.

### Warning

This conversion may result in alteration of data. For example, if you shorten a string column, values may be truncated. To prevent the operation from succeeding if conversions to the new data type would result in loss of data, enable strict SQL mode before using `ALTER TABLE` (see [Section 5.1.7, “Server SQL Modes”](#)).

- To add a column at a specific position within a table row, use `FIRST` or `AFTER col_name`. The default is to add the column last. You can also use `FIRST` and `AFTER` in `CHANGE` or `MODIFY` operations to reorder columns within a table.
- `ALTER ... SET DEFAULT` or `ALTER ... DROP DEFAULT` specify a new default value for a column or remove the old default value, respectively. If the old default is removed and the column can be `NULL`, the new default is `NULL`. If the column cannot be `NULL`, MySQL assigns a default value as described in [Section 10.1.4, “Data Type Default Values”](#).



- `DROP INDEX` removes an index. This is a MySQL extension to standard SQL. See [Section 12.1.24, “DROP INDEX Syntax”](#). If you are unsure of the index name, use `SHOW INDEX FROM tbl_name`.
- If columns are dropped from a table, the columns are also removed from any index of which they are a part. If all columns that make up an index are dropped, the index is dropped as well. If you use `CHANGE` or `MODIFY` to shorten a column for which an index exists on the column, and the resulting column length is less than the index length, MySQL shortens the index automatically.
- If a table contains only one column, the column cannot be dropped. If what you intend is to remove the table, use `DROP TABLE` instead.
- `DROP PRIMARY KEY` drops the primary key. If there is no primary key, an error occurs.

If you add a `UNIQUE INDEX` or `PRIMARY KEY` to a table, it is stored before any non-unique index so that MySQL can detect duplicate keys as early as possible.

- Some storage engines allow you to specify an index type when creating an index. The syntax for the *index\_type* specifier is `USING type_name`. For details about `USING`, see [Section 12.1.13, “CREATE INDEX Syntax”](#). Before MySQL 5.1.10, `USING` can be given only before the index column list. As of 5.1.10, the preferred position is after the column list. Use of the option before the column list will no longer be recognized in a future MySQL release.

*index\_option* values specify additional options for an index. `USING` is one such option. For details about allowable *index\_option* values, see [Section 12.1.13, “CREATE INDEX Syntax”](#).

- After an `ALTER TABLE` statement, it may be necessary to run `ANALYZE TABLE` to update index cardinality information. See [Section 12.5.5.23, “SHOW INDEX Syntax”](#).
- `ORDER BY` enables you to create the new table with the rows in a specific order. Note that the table does not remain in this order after inserts and deletes. This option is useful primarily when you know that you are mostly to query the rows in a certain order most of the time. By using this option after major changes to the table, you might be able to get higher performance. In some cases, it might make sorting easier for MySQL if the table is in order by the column that you want to order it by later.

`ORDER BY` syntax allows for one or more column names to be specified for sorting, each of which optionally can be followed by `ASC` or `DESC` to indicate ascending or descending sort order, respectively. The default is ascending order. Only column names are allowed as sort criteria; arbitrary expressions are not allowed.

`ORDER BY` does not make sense for InnoDB tables that contain a user-defined clustered index (`PRIMARY KEY` or `NOT NULL UNIQUE` index). InnoDB always orders table rows according to such an index if one is present.

### Note

When used on a partitioned table, `ALTER TABLE ... ORDER BY` orders rows within each partition only.

- If you use `ALTER TABLE` on a MyISAM table, all non-unique indexes are created in a separate batch (as for `REPAIR TABLE`). This should make `ALTER TABLE` much faster when you have many indexes.

This feature can be activated explicitly for a MyISAM table. `ALTER TABLE ... DISABLE KEYS` tells MySQL to stop updating non-unique indexes. `ALTER TABLE ... ENABLE KEYS` then should be used to re-create missing indexes. MySQL does this with a special algorithm that is much faster than inserting keys one by one, so disabling keys before performing bulk insert operations should give a considerable speedup. Using `ALTER TABLE ... DISABLE KEYS` requires the `INDEX` privilege in addition to the privileges mentioned earlier.

While the non-unique indexes are disabled, they are ignored for statements such as `SELECT` and `EXPLAIN` that otherwise would use them.

`ENABLE KEYS` and `DISABLE KEYS` were not supported for partitioned tables prior to MySQL 5.1.11.

- If `ALTER TABLE` for an InnoDB table results in changes to column values (for example, because a column is truncated), InnoDB's `FOREIGN KEY` constraint checks do not notice possible violations caused by changing the values.
- The `FOREIGN KEY` and `REFERENCES` clauses are supported by the InnoDB storage engine, which implements `ADD [CONSTRAINT [symbol]] FOREIGN KEY (...) REFERENCES ... (...)`. See [Section 13.6.4.4, “FOREIGN KEY Constraints”](#). For other storage engines, the clauses are parsed but ignored. The `CHECK` clause is parsed but ignored by all storage engines. See [Section 12.1.17, “CREATE TABLE Syntax”](#). The reason for accepting but ignoring syntax clauses is for compatibility, to make it easier to port code from other SQL servers, and to run applications that create tables with references. See [Section 1.7.5, “MySQL Differences from Standard SQL”](#).

### Important

The inline `REFERENCES` specifications where the references are defined as part of the column specification are silently ignored by InnoDB. InnoDB only accepts `REFERENCES` clauses defined as part of a separate `FOREIGN KEY`

■ specification.

### Note

Partitioned tables do not support foreign keys. See [Section 17.5, “Restrictions and Limitations on Partitioning”](#), for more information.

- InnoDB supports the use of `ALTER TABLE` to drop foreign keys:

```
ALTER TABLE tbl_name DROP FOREIGN KEY fk_symbol;
```

For more information, see [Section 13.6.4.4, “FOREIGN KEY Constraints”](#).

- You cannot add a foreign key and drop a foreign key in separate clauses of a single `ALTER TABLE` statement. You must use separate statements.
- For an InnoDB table that is created with its own tablespace in an `.ibd` file, that file can be discarded and imported. To discard the `.ibd` file, use this statement:

```
ALTER TABLE tbl_name DISCARD TABLESPACE;
```

This deletes the current `.ibd` file, so be sure that you have a backup first. Attempting to access the table while the tablespace file is discarded results in an error.

To import the backup `.ibd` file back into the table, copy it into the database directory, and then issue this statement:

```
ALTER TABLE tbl_name IMPORT TABLESPACE;
```

See [Section 13.6.2.1, “Using Per-Table Tablespaces”](#).

- Pending `INSERT DELAYED` statements are lost if a table is write locked and `ALTER TABLE` is used to modify the table structure.
- If you want to change the table default character set and all character columns (`CHAR`, `VARCHAR`, `TEXT`) to a new character set, use a statement like this:

```
ALTER TABLE tbl_name CONVERT TO CHARACTER SET charset_name;
```

For a column that has a data type of `VARCHAR` or one of the `TEXT` types, `CONVERT TO CHARACTER SET` will change the data type as necessary to ensure that the new column is long enough to store as many characters as the original column. For example, a `TEXT` column has two length bytes, which store the byte-length of values in the column, up to a maximum of 65,535. For a `latin1 TEXT` column, each character requires a single byte, so the column can store up to 65,535 characters. If the column is converted to `utf8`, each character might require up to three bytes, for a maximum possible length of  $3 \times 65,535 = 196,605$  bytes. That length will not fit in a `TEXT` column's length bytes, so MySQL will convert the data type to `MEDIUMTEXT`, which is the smallest string type for which the length bytes can record a value of 196,605. Similarly, a `VARCHAR` column might be converted to `MEDIUMTEXT`.

To avoid data type changes of the type just described, do not use `CONVERT TO CHARACTER SET`. Instead, use `MODIFY` to change individual columns. For example:

```
ALTER TABLE t MODIFY latin1_text_col TEXT CHARACTER SET utf8;
ALTER TABLE t MODIFY latin1_varchar_col VARCHAR(M) CHARACTER SET utf8;
```

If you specify `CONVERT TO CHARACTER SET binary`, the `CHAR`, `VARCHAR`, and `TEXT` columns are converted to their corresponding binary string types (`BINARY`, `VARBINARY`, `BLOB`). This means that the columns no longer will have a character set and a subsequent `CONVERT TO` operation will not apply to them.

If `charset_name` is `DEFAULT`, the database character set is used.

### Warning

The `CONVERT TO` operation converts column values between the character sets. This is *not* what you want if you have a column in one character set (like `latin1`) but the stored values actually use some other, incompatible character set (like `utf8`). In this case, you have to do the following for each such column:

```
ALTER TABLE t1 CHANGE c1 c1 BLOB;
ALTER TABLE t1 CHANGE c1 c1 TEXT CHARACTER SET utf8;
```

The reason this works is that there is no conversion when you convert to or from `BLOB` columns.

To change only the *default* character set for a table, use this statement:

```
ALTER TABLE tbl_name DEFAULT CHARACTER SET charset_name;
```

The word `DEFAULT` is optional. The default character set is the character set that is used if you do not specify the character set for columns that you add to a table later (for example, with `ALTER TABLE ... ADD column`).

- A number of partitioning-related extensions to `ALTER TABLE` were added in MySQL 5.1.5. These can be used with partitioned tables for repartitioning, for adding, dropping, merging, and splitting partitions, and for performing partitioning maintenance.

Simply using a *partition\_options* clause with `ALTER TABLE` on a partitioned table repartitions the table according to the partitioning scheme defined by the *partition\_options*. This clause always begins with `PARTITION BY`, and follows the same syntax and other rules as apply to the *partition\_options* clause for `CREATE TABLE` (see [Section 12.1.17, “CREATE TABLE Syntax”](#), for more detailed information), and can also be used to partition an existing table that is not already partitioned. For example, consider a (non-partitioned) table defined as shown here:

```
CREATE TABLE t1 (
  id INT,
  year_col INT
);
```

This table can be partitioned by `HASH`, using the `id` column as the partitioning key, into 8 partitions by means of this statement:

```
ALTER TABLE t1
  PARTITION BY HASH(id)
  PARTITIONS 8;
```

The table that results from using an `ALTER TABLE ... PARTITION BY` statement must follow the same rules as one created using `CREATE TABLE ... PARTITION BY`. This includes the rules governing the relationship between any unique keys (including any primary key) that the table might have, and the column or columns used in the partitioning expression, as discussed in [Section 17.5.1, “Partitioning Keys, Primary Keys, and Unique Keys”](#). The `CREATE TABLE ... PARTITION BY` rules for specifying the number of partitions also apply to `ALTER TABLE ... PARTITION BY`.

`ALTER TABLE ... PARTITION BY` became available in MySQL 5.1.6.

The *partition\_definition* clause for `ALTER TABLE ADD PARTITION` supports the same options as the clause of the same name for the `CREATE TABLE` statement. (See [Section 12.1.17, “CREATE TABLE Syntax”](#), for the syntax and description.) Suppose that you have the partitioned table created as shown here:

```
CREATE TABLE t1 (
  id INT,
  year_col INT
)
PARTITION BY RANGE (year_col) (
  PARTITION p0 VALUES LESS THAN (1991),
  PARTITION p1 VALUES LESS THAN (1995),
  PARTITION p2 VALUES LESS THAN (1999)
);
```

You can add a new partition `p3` to this table for storing values less than 2002 as follows:

```
ALTER TABLE t1 ADD PARTITION (PARTITION p3 VALUES LESS THAN (2002));
```

`DROP PARTITION` can be used to drop one or more `RANGE` or `LIST` partitions. This statement cannot be used with `HASH` or `KEY` partitions; instead, use `COALESCE PARTITION` (see below). Any data that was stored in the dropped partitions named in the *partition\_names* list is discarded. For example, given the table `t1` defined previously, you can drop the partitions named `p0` and `p1` as shown here:

```
ALTER TABLE t1 DROP PARTITION p0, p1;
```

## Note

`DROP PARTITION` does not work with tables that use the `NDBCLUSTER` storage engine. See [Section 17.3.1, “Management of RANGE and LIST Partitions”](#), and [Known Limitations of MySQL Cluster](#).

`ADD PARTITION` and `DROP PARTITION` do not currently support `IF [NOT] EXISTS`. It is also not possible to rename a partition or a partitioned table. Instead, if you wish to rename a partition, you must drop and re-create the partition; if you wish to rename a partitioned table, you must instead drop all partitions, rename the table, and then add back the partitions that were

dropped.

`COALESCE PARTITION` can be used with a table that is partitioned by `HASH` or `KEY` to reduce the number of partitions by *number*. Suppose that you have created table `t2` using the following definition:

```
CREATE TABLE t2 (
  name VARCHAR (30),
  started DATE
)
PARTITION BY HASH( YEAR(started) )
PARTITIONS 6;
```

You can reduce the number of partitions used by `t2` from 6 to 4 using the following statement:

```
ALTER TABLE t2 COALESCE PARTITION 2;
```

The data contained in the last *number* partitions will be merged into the remaining partitions. In this case, partitions 4 and 5 will be merged into the first 4 partitions (the partitions numbered 0, 1, 2, and 3).

To change some but not all the partitions used by a partitioned table, you can use `REORGANIZE PARTITION`. This statement can be used in several ways:

- To merge a set of partitions into a single partition. This can be done by naming several partitions in the *partition\_names* list and supplying a single definition for *partition\_definition*.
- To split an existing partition into several partitions. You can accomplish this by naming a single partition for *partition\_names* and providing multiple *partition\_definitions*.
- To change the ranges for a subset of partitions defined using `VALUES LESS THAN` or the value lists for a subset of partitions defined using `VALUES IN`.
- This statement may also be used without the *partition\_names INTO (partition\_definitions)* option on tables that are automatically partitioned using `HASH` partitioning in order to force redistribution of data. (Currently, only `NDBCLUSTER` tables are automatically partitioned in this way.) This is useful in MySQL Cluster NDB 6.4.0 and later where, after you have added new MySQL Cluster data nodes online to an existing MySQL Cluster, you wish to redistribute existing MySQL Cluster table data to the new data nodes. In such cases, you should invoke the statement with the `ONLINE` option; in words words, as shown here:

```
ALTER ONLINE TABLE table REORGANIZE PARTITION;
```

You cannot perform other DDL concurrently with online table reorganization — that is, no other DDL statements can be issued while an `ALTER ONLINE TABLE ... REORGANIZE PARTITION` statement is executing. For more information about adding MySQL Cluster data nodes online, see [Adding MySQL Cluster Data Nodes Online](#).

Attempting to use `REORGANIZE PARTITION` without the *partition\_names INTO (partition\_definitions)* option on explicitly partitioned tables results in the error `REORGANIZE PARTITION WITHOUT PARAMETERS CAN ONLY BE USED ON AUTO-PARTITIONED TABLES USING HASH PARTITIONING`.

### Note

For partitions that have not been explicitly named, MySQL automatically provides the default names `p0`, `p1`, `p2`, and so on. As of MySQL 5.1.7, the same is true with regard to subpartitions.

For more detailed information about and examples of `ALTER TABLE ... REORGANIZE PARTITION` statements, see [Section 17.3, “Partition Management”](#).

### Important

Only a single `PARTITION BY`, `ADD PARTITION`, `DROP PARTITION`, `REORGANIZE PARTITION`, or `COALESCE PARTITION` clause can be used in a given `ALTER TABLE` statement.

- Several additional options were introduced in MySQL 5.1.5 for providing partition maintenance and repair functionality analogous to that implemented for non-partitioned tables by statements such as `CHECK TABLE` and `REPAIR TABLE` (which are also supported for partitioned tables, beginning with MySQL 5.1.27 — see note at the end of this item). These include `ANALYZE PARTITION`, `CHECK PARTITION`, `OPTIMIZE PARTITION`, `REBUILD PARTITION`, and `REPAIR PARTITION`. Each of these options takes a *partition\_names* clause consisting of one or more names of partitions, separated by commas. The partitions must already exist in the table to be altered. For more information and examples, see [Section 17.3.3, “Maintenance of Partitions”](#).

The `ANALYZE PARTITION`, `CHECK PARTITION`, `OPTIMIZE PARTITION`, and `REPAIR PARTITION` options were disabled in MySQL 5.1.24, and re-enabled in MySQL 5.1.27. ([Bug#20129](#)) They are not supported for tables which are not par-

tioned; beginning with MySQL 5.1.31, they are disallowed for such tables.

### Note

Beginning with MySQL 5.1.27, you can use the statements `ANALYZE TABLE`, `CHECK TABLE`, `OPTIMIZE TABLE`, and `REPAIR TABLE` on partitioned tables. See [Section 12.5.2, “Table Maintenance Statements”](#), for more information.

- `REMOVE PARTITIONING` was introduced in MySQL 5.1.8 for the purpose of removing a table's partitioning without otherwise affecting the table or its data. (Previously, this was done using the `ENGINE` option.) This option can be combined with other `ALTER TABLE` options such as those used to add, drop, or rename drop columns or indexes.
- In MySQL 5.1.7 and earlier, using the `ENGINE` option with `ALTER TABLE` caused any partitioning that a table might have had to be removed. Beginning with MySQL 5.1.8, this option merely changes the storage engine used by the table and no longer affects partitioning in any way.

With the `mysql_info()` C API function, you can find out how many rows were copied, and (when `IGNORE` is used) how many rows were deleted due to duplication of unique key values. See [Section 20.10.3.35, “mysql\\_info\(\)”](#).

Here are some examples that show uses of `ALTER TABLE`. Begin with a table `t1` that is created as shown here:

```
CREATE TABLE t1 (a INTEGER,b CHAR(10));
```

To rename the table from `t1` to `t2`:

```
ALTER TABLE t1 RENAME t2;
```

To change column `a` from `INTEGER` to `TINYINT NOT NULL` (leaving the name the same), and to change column `b` from `CHAR(10)` to `CHAR(20)` as well as renaming it from `b` to `c`:

```
ALTER TABLE t2 MODIFY a TINYINT NOT NULL, CHANGE b c CHAR(20);
```

To add a new `TIMESTAMP` column named `d`:

```
ALTER TABLE t2 ADD d TIMESTAMP;
```

To add an index on column `d` and a `UNIQUE` index on column `a`:

```
ALTER TABLE t2 ADD INDEX (d), ADD UNIQUE (a);
```

To remove column `c`:

```
ALTER TABLE t2 DROP COLUMN c;
```

To add a new `AUTO_INCREMENT` integer column named `c`:

```
ALTER TABLE t2 ADD c INT UNSIGNED NOT NULL AUTO_INCREMENT,
ADD PRIMARY KEY (c);
```

We indexed `c` (as a `PRIMARY KEY`) because `AUTO_INCREMENT` columns must be indexed, and we declare `c` as `NOT NULL` because primary key columns cannot be `NULL`.

For `NDB` tables, it is also possible to change the storage type used for a table or column. For example, consider an `NDB` table created as shown here:

```
mysql> CREATE TABLE t1 (c1 INT) TABLESPACE ts_1 ENGINE NDB;
Query OK, 0 rows affected (1.27 sec)
```

To convert this table to disk-based storage, you can use the following `ALTER TABLE` statement:

```
mysql> ALTER TABLE t1 TABLESPACE ts_1 STORAGE DISK;
Query OK, 0 rows affected (2.99 sec)
Records: 0 Duplicates: 0 Warnings: 0

mysql> SHOW CREATE TABLE t1\G
***** 1. row *****
Table: t1
Create Table: CREATE TABLE `t1` (
  `c1` int(11) DEFAULT NULL
) /*!50100 TABLESPACE ts_1 STORAGE DISK */
```

```
ENGINE=ndbcluster DEFAULT CHARSET=latin1
1 row in set (0.01 sec)
```

It is not necessary that the tablespace was referenced when the table was originally created; however, the tablespace must be referenced by the `ALTER TABLE`:

```
mysql> CREATE TABLE t2 (c1 INT) ts_1 ENGINE NDB;
Query OK, 0 rows affected (1.00 sec)

mysql> ALTER TABLE t2 STORAGE DISK;
ERROR 1005 (HY000): CAN'T CREATE TABLE 'c.#SQL-1750_3' (ERRNO: 140)
mysql> ALTER TABLE t2 TABLESPACE ts_1 STORAGE DISK;
Query OK, 0 rows affected (3.42 sec)
Records: 0 Duplicates: 0 Warnings: 0
mysql> SHOW CREATE TABLE t2\G
***** 1. row *****
      Table: t1
Create Table: CREATE TABLE `t2` (
  `c1` int(11) DEFAULT NULL
) /*!50100 TABLESPACE ts_1 STORAGE DISK */
ENGINE=ndbcluster DEFAULT CHARSET=latin1
1 row in set (0.01 sec)
```

To change the storage type of an individual column, you can use `ALTER TABLE ... MODIFY [COLUMN]`. For example, suppose you create a MySQL Cluster Disk Data table with two columns, using this `CREATE TABLE` statement:

```
mysql> CREATE TABLE t3 (c1 INT, c2 INT)
-> TABLESPACE ts_1 STORAGE DISK ENGINE NDB;
Query OK, 0 rows affected (1.34 sec)
```

To change column `c2` from disk-based to in-memory storage, include a `STORAGE MEMORY` clause in the column definition used by the `ALTER TABLE` statement, as shown here:

```
mysql> ALTER TABLE t3 MODIFY c2 INT STORAGE MEMORY;
Query OK, 0 rows affected (3.14 sec)
Records: 0 Duplicates: 0 Warnings: 0
```

You can make an in-memory column into a disk-based column by using `STORAGE DISK` in a similar fashion.

Column `c1` uses disk-based storage, since this is the default for the table (determined by the table-level `STORAGE DISK` clause in the `CREATE TABLE` statement). However, column `c2` uses in-memory storage, as can be seen here in the output of `SHOW CREATE TABLE`:

```
mysql> SHOW CREATE TABLE t3\G
***** 1. row *****
      Table: t3
Create Table: CREATE TABLE `t3` (
  `c1` int(11) DEFAULT NULL,
  `c2` int(11) /*!50120 STORAGE MEMORY */ DEFAULT NULL
) /*!50100 TABLESPACE ts_1 STORAGE DISK */ ENGINE=ndbcluster DEFAULT CHARSET=latin1
1 row in set (0.02 sec)
```

When you add an `AUTO_INCREMENT` column, column values are filled in with sequence numbers automatically. For `MyISAM` tables, you can set the first sequence number by executing `SET INSERT_ID=value` before `ALTER TABLE` or by using the `AUTO_INCREMENT=value` table option. See [Section 5.1.4, "Session System Variables"](#).

With `MyISAM` tables, if you do not change the `AUTO_INCREMENT` column, the sequence number is not affected. If you drop an `AUTO_INCREMENT` column and then add another `AUTO_INCREMENT` column, the numbers are resequenced beginning with 1.

When replication is used, adding an `AUTO_INCREMENT` column to a table might not produce the same ordering of the rows on the slave and the master. This occurs because the order in which the rows are numbered depends on the specific storage engine used for the table and the order in which the rows were inserted. If it is important to have the same order on the master and slave, the rows must be ordered before assigning an `AUTO_INCREMENT` number. Assuming that you want to add an `AUTO_INCREMENT` column to the table `t1`, the following statements produce a new table `t2` identical to `t1` but with an `AUTO_INCREMENT` column:

```
CREATE TABLE t2 (id INT AUTO_INCREMENT PRIMARY KEY)
SELECT * FROM t1 ORDER BY col1, col2;
```

This assumes that the table `t1` has columns `col1` and `col2`.

This set of statements will also produce a new table `t2` identical to `t1`, with the addition of an `AUTO_INCREMENT` column:

```
CREATE TABLE t2 LIKE t1;
ALTER TABLE T2 ADD id INT AUTO_INCREMENT PRIMARY KEY;
INSERT INTO t2 SELECT * FROM t1 ORDER BY col1, col2;
```

**Important**

To guarantee the same ordering on both master and slave, *all* columns of `t1` must be referenced in the `ORDER BY` clause.

Regardless of the method used to create and populate the copy having the `AUTO_INCREMENT` column, the final step is to drop the original table and then rename the copy:

```
DROP t1;
ALTER TABLE t2 RENAME t1;
```

**12.1.8. ALTER TABLESPACE Syntax**

```
ALTER TABLESPACE tablespace_name
{ADD|DROP} DATAFILE 'file_name'
[INITIAL_SIZE [=] size]
[WAIT]
ENGINE [=] engine_name
```

This statement can be used either to add a new data file, or to drop a data file from a tablespace.

The `ADD DATAFILE` variant allows you to specify an initial size using an `INITIAL_SIZE` clause, where *size* is measured in bytes; the default value is `128M` (128 megabytes). You may optionally follow this integer value with a one-letter abbreviation for an order of magnitude, similar to those used in `my.cnf`. Generally, this is one of the letters `M` (for megabytes) or `G` (for gigabytes).

**Note**

All MySQL Cluster Disk Data objects share the same namespace. This means that *each Disk Data object* must be uniquely named (and not merely each Disk Data object of a given type). For example, you cannot have a tablespace and a data file with the same name, or an undo log file and a with the same name.

Prior to MySQL Cluster NDB 6.2.17, 6.3.23, and 6.4.3, path and file names for data files could not be longer than 128 characters. ([Bug#31770](#))

On 32-bit systems, the maximum supported value for `INITIAL_SIZE` is `4G`. ([Bug#29186](#))

Once a data file has been created, its size cannot be changed; however, you can add more data files to the tablespace using additional `ALTER TABLESPACE ... ADD DATAFILE` statements.

Using `DROP DATAFILE` with `ALTER TABLESPACE` drops the data file '*file\_name*' from the tablespace. This file must already have been added to the tablespace using `CREATE TABLESPACE` or `ALTER TABLESPACE`; otherwise an error will result.

Both `ALTER TABLESPACE ... ADD DATAFILE` and `ALTER TABLESPACE ... DROP DATAFILE` require an `ENGINE` clause which specifies the storage engine used by the tablespace. In MySQL 5.1, the only accepted values for *engine\_name* are `NDB` and `NDBCLUSTER`.

`WAIT` is parsed but otherwise ignored, and so has no effect in MySQL 5.1. It is intended for future expansion.

When `ALTER TABLESPACE ... ADD DATAFILE` is used with `ENGINE = NDB`, a data file is created on each Cluster data node. You can verify that the data files were created and obtain information about them by querying the `INFORMATION_SCHEMA.FILES` table. For example, the following query shows all data files belonging to the tablespace named `newts`:

```
mysql> SELECT LOGFILE_GROUP_NAME, FILE_NAME, EXTRA
-> FROM INFORMATION_SCHEMA.FILES
-> WHERE TABLESPACE_NAME = 'newts' AND FILE_TYPE = 'DATAFILE';
```

LOGFILE_GROUP_NAME	FILE_NAME	EXTRA
lg_3	newdata.dat	CLUSTER_NODE=3
lg_3	newdata.dat	CLUSTER_NODE=4
lg_3	newdata2.dat	CLUSTER_NODE=3
lg_3	newdata2.dat	CLUSTER_NODE=4

```
2 rows in set (0.03 sec)
```

See [Section 19.21, “The INFORMATION\\_SCHEMA FILES Table”](#).

`ALTER TABLESPACE` was added in MySQL 5.1.6. In MySQL 5.1, it is useful only with Disk Data storage for MySQL Cluster. See [MySQL Cluster Disk Data Tables](#).

**12.1.9. ALTER VIEW Syntax**



```
ALTER
[ALGORITHM = {UNDEFINED | MERGE | TEMPTABLE}]
[DEFINER = { user | CURRENT_USER }]
[SQL SECURITY { DEFINER | INVOKER }]
VIEW view_name [(column_list)]
AS select_statement
[WITH [CASCADED | LOCAL] CHECK OPTION]
```

This statement changes the definition of a view, which must exist. The syntax is similar to that for `CREATE VIEW` and the effect is the same as for `CREATE OR REPLACE VIEW`. See [Section 12.1.20, “CREATE VIEW Syntax”](#). This statement requires the `CREATE VIEW` and `DROP` privileges for the view, and some privilege for each column referred to in the `SELECT` statement. As of MySQL 5.1.23, `ALTER VIEW` is allowed only to the definer or users with the `SUPER` privilege.

## 12.1.10. CREATE DATABASE Syntax

```
CREATE {DATABASE | SCHEMA} [IF NOT EXISTS] db_name
[create_specification] ...

create_specification:
[DEFAULT] CHARACTER SET [=] charset_name
| [DEFAULT] COLLATE [=] collation_name
```

`CREATE DATABASE` creates a database with the given name. To use this statement, you need the `CREATE` privilege for the database. `CREATE SCHEMA` is a synonym for `CREATE DATABASE`.

An error occurs if the database exists and you did not specify `IF NOT EXISTS`.

`create_specification` options specify database characteristics. Database characteristics are stored in the `db.opt` file in the database directory. The `CHARACTER SET` clause specifies the default database character set. The `COLLATE` clause specifies the default database collation. [Section 9.1, “Character Set Support”](#), discusses character set and collation names.

A database in MySQL is implemented as a directory containing files that correspond to tables in the database. Because there are no tables in a database when it is initially created, the `CREATE DATABASE` statement creates only a directory under the MySQL data directory and the `db.opt` file. Rules for allowable database names are given in [Section 8.2, “Schema Object Names”](#). If a database name contains special characters, the name for the database directory contains encoded versions of those characters as described in [Section 8.2.3, “Mapping of Identifiers to File Names”](#).

If you manually create a directory under the data directory (for example, with `mkdir`), the server considers it a database directory and it shows up in the output of `SHOW DATABASES`.

You can also use the `mysqladmin` program to create databases. See [Section 4.5.2, “mysqladmin — Client for Administering a MySQL Server”](#).

## 12.1.11. CREATE EVENT Syntax

```
CREATE
[DEFINER = { user | CURRENT_USER }]
EVENT
[IF NOT EXISTS]
event_name
ON SCHEDULE schedule
[ON COMPLETION [NOT] PRESERVE]
[ENABLE | DISABLE | DISABLE ON SLAVE]
[COMMENT 'comment']
DO sql_statement;

schedule:
AT timestamp [+ INTERVAL interval] ...
| EVERY interval
[STARTS timestamp [+ INTERVAL interval] ...]
[ENDS timestamp [+ INTERVAL interval] ...]

interval:
quantity {YEAR | QUARTER | MONTH | DAY | HOUR | MINUTE |
          WEEK | SECOND | YEAR_MONTH | DAY_HOUR | DAY_MINUTE |
          DAY_SECOND | HOUR_MINUTE | HOUR_SECOND | MINUTE_SECOND}
```

This statement creates and schedules a new event. It requires the `EVENT` privilege for the schema in which the event is to be created.

The minimum requirements for a valid `CREATE EVENT` statement are as follows:

- The keywords `CREATE EVENT` plus an event name, which uniquely identifies the event in the current schema. (Prior to MySQL 5.1.12, the event name needed to be unique only among events created by the same user on a given database.)
- An `ON SCHEDULE` clause, which determines when and how often the event executes.



- A `DO` clause, which contains the SQL statement to be executed by an event.

This is an example of a minimal `CREATE EVENT` statement:

```
CREATE EVENT myevent
ON SCHEDULE AT CURRENT_TIMESTAMP + INTERVAL 1 HOUR
DO
UPDATE myschema.mytable SET mycol = mycol + 1;
```

The previous statement creates an event named `myevent`. This event executes once — one hour following its creation — by running an SQL statement that increments the value of the `myschema.mytable` table's `mycol` column by 1.

The `event_name` must be a valid MySQL identifier with a maximum length of 64 characters. It may be delimited using back ticks, and may be qualified with the name of a database schema. An event is associated with both a MySQL user (the definer) and a schema, and its name must be unique among names of events within that schema. In general, the rules governing event names are the same as those for names of stored routines. See [Section 8.2, “Schema Object Names”](#).

If no schema is indicated as part of `event_name`, the default (current) schema is assumed.

### Note

MySQL uses case-insensitive comparisons when checking for the uniqueness of event names. This means that, for example, you cannot have two events named `myevent` and `MyEvent` in the same database schema.

The `DEFINER` clause specifies the MySQL account to be used when checking access privileges at event execution time. If a `user` value is given, it should be a MySQL account in '`user_name`'@'`host_name`' format (the same format used in the `GRANT` statement). The `user_name` and `host_name` values both are required. The definer can also be given as `CURRENT_USER` or `CURRENT_USER()`. The default `DEFINER` value is the user who executes the `CREATE EVENT` statement. (This is the same as `DEFINER = CURRENT_USER`.)

If you specify the `DEFINER` clause, these rules determine the legal `DEFINER` user values:

- If you do not have the `SUPER` privilege, the only legal `user` value is your own account, either specified literally or by using `CURRENT_USER`. You cannot set the definer to some other account.
- If you have the `SUPER` privilege, you can specify any syntactically legal account name. If the account does not actually exist, a warning is generated.
- Although it is possible to create events with a non-existent `DEFINER` value, an error occurs if the event executes with definer privileges but the definer does not exist at execution time.

The `DEFINER` clause was added in MySQL 5.1.17. (Prior to MySQL 5.1.12, it was possible for two different users to create different events having the same name on the same database schema.)

Within an event, the `CURRENT_USER()` function returns the account used to check privileges at event execution time, which is the `DEFINER` user. For information about user auditing within events, see [Section 5.5.9, “Auditing MySQL Account Activity”](#).

`IF NOT EXISTS` has the same meaning for `CREATE EVENT` as for `CREATE TABLE`: If an event named `event_name` already exists in the same schema, no action is taken, and no error results. (However, a warning is generated in such cases.)

The `ON SCHEDULE` clause determines when, how often, and for how long the `sql_statement` defined for the event repeats. This clause takes one of two forms:

- `AT timestamp` is used for a one-time event. It specifies that the event executes one time only at the date and time given by `timestamp`, which must include both the date and time, or must be an expression that resolves to a datetime value. You may use a value of either the `DATETIME` or `TIMESTAMP` type for this purpose. If the date is in the past, a warning occurs, as shown here:

```
mysql> SELECT NOW();
+-----+
| NOW() |
+-----+
| 2006-02-10 23:59:01 |
+-----+
1 row in set (0.04 sec)

mysql> CREATE EVENT e_totals
-> ON SCHEDULE AT '2006-02-10 23:59:00'
-> DO INSERT INTO test.totals VALUES (NOW());
Query OK, 0 rows affected, 1 warning (0.00 sec)
```

```
mysql> SHOW WARNINGS\G
***** 1. row *****
Level: Note
Code: 1588
Message: Event execution time is in the past and ON COMPLETION NOT
PRESERVE is set. The event was dropped immediately after
creation.
```

`CREATE EVENT` statements which are themselves invalid — for whatever reason — fail with an error.

You may use `CURRENT_TIMESTAMP` to specify the current date and time. In such a case, the event acts as soon as it is created.

To create an event which occurs at some point in the future relative to the current date and time — such as that expressed by the phrase “three weeks from now” — you can use the optional clause `+ INTERVAL interval`. The *interval* portion consists of two parts, a quantity and a unit of time, and follows the same syntax rules that govern intervals used in the `DATE_ADD()` function (see Section 11.6, “Date and Time Functions”). The units keywords are also the same, except that you cannot use any units involving microseconds when defining an event. With some interval types, complex time units may be used. For example, “two minutes and ten seconds” can be expressed as `+ INTERVAL '2:10' MINUTE_SECOND`.

You can also combine intervals. For example, `AT CURRENT_TIMESTAMP + INTERVAL 3 WEEK + INTERVAL 2 DAY` is equivalent to “three weeks and two days from now”. Each portion of such a clause must begin with `+ INTERVAL`.

- To repeat actions at a regular interval, use an `EVERY` clause. The `EVERY` keyword is followed by an *interval* as described in the previous discussion of the `AT` keyword. (`+ INTERVAL` is *not* used with `EVERY`.) For example, `EVERY 6 WEEK` means “every six weeks”.

Although `+ INTERVAL` clauses are not allowed in an `EVERY` clause, you can use the same complex time units allowed in a `+ INTERVAL`.

An `EVERY` clause may also contain an optional `STARTS` clause. `STARTS` is followed by a *timestamp* value which indicates when the action should begin repeating, and may also use `+ INTERVAL interval` in order to specify an amount of time “from now”. For example, `EVERY 3 MONTH STARTS CURRENT_TIMESTAMP + INTERVAL 1 WEEK` means “every three months, beginning one week from now”. Similarly, you can express “every two weeks, beginning six hours and fifteen minutes from now” as `EVERY 2 WEEK STARTS CURRENT_TIMESTAMP + INTERVAL '6:15' HOUR_MINUTE`. Not specifying `STARTS` is the same as using `STARTS CURRENT_TIMESTAMP` — that is, the action specified for the event begins repeating immediately upon creation of the event.

An `EVERY` clause may also contain an optional `ENDS` clause. The `ENDS` keyword is followed by a *timestamp* value which tells MySQL when the event should stop repeating. You may also use `+ INTERVAL interval` with `ENDS`; for instance, `EVERY 12 HOUR STARTS CURRENT_TIMESTAMP + INTERVAL 30 MINUTE ENDS CURRENT_TIMESTAMP + INTERVAL 4 WEEK` is equivalent to “every twelve hours, beginning thirty minutes from now, and ending four weeks from now”. Not using `ENDS` means that the event continues executing indefinitely.

`ENDS` supports the same syntax for complex time units as `STARTS` does.

You may use `STARTS`, `ENDS`, both, or neither in an `EVERY` clause.

### Note

Beginning with MySQL 5.1.17, `STARTS` or `ENDS` uses the MySQL server's local time zone, as shown in the `INFORMATION_SCHEMA.EVENTS` and `mysql.event` tables, as well as in the output of `SHOW EVENTS`. Previously, this information was stored using UTC (Bug#16420).

Due to this change, the `mysql.event` table must be updated before events created in earlier releases can be created, altered, viewed, or used in MySQL 5.1.17 or later. You can use `mysql_upgrade` for this (see Section 4.4.8, “`mysql_upgrade` — Check Tables for MySQL Upgrade”).

See Section 19.20, “The `INFORMATION_SCHEMA.EVENTS` Table”, and Section 12.5.5.19, “`SHOW EVENTS Syntax`” for information about columns added in MySQL 5.1.17 to accommodate these changes.

If a repeating event does not terminate within its scheduling interval, the result may be multiple instances of the event executing simultaneously. If this is undesirable, you should institute a mechanism to prevent simultaneous instances. For example, you could use the `GET_LOCK()` function, or row or table locking.

The `ON SCHEDULE` clause may use expressions involving built-in MySQL functions and user variables to obtain any of the *timestamp* or *interval* values which it contains. You may not use stored functions or user-defined functions in such expressions, nor may you use any table references; however, you may use `SELECT FROM DUAL`. This is true for both `CREATE EVENT` and `ALTER EVENT` statements. Beginning with MySQL 5.1.13, references to stored functions, user-defined functions, and tables in such cases are specifically disallowed, and fail with an error (see Bug#22830).

Normally, once an event has expired, it is immediately dropped. You can override this behavior by specifying `ON COMPLETION PRESERVE`. Using `ON COMPLETION NOT PRESERVE` merely makes the default non-persistent behavior explicit.

You can create an event but keep it from being active using the `DISABLE` keyword. Alternatively, you may use `ENABLE` to make explicit the default status, which is active. This is most useful in conjunction with `ALTER EVENT` (see [Section 12.1.2, “ALTER EVENT Syntax”](#)).

Beginning with MySQL 5.1.18, a third value may also appear in place of `ENABLED` or `DISABLED`; `DISABLE ON SLAVE` is set for the status of an event on a replication slave to indicate that the event was created on the master and replicated to the slave, but is not executed on the slave. See [Section 16.3.1.7, “Replication of Invoked Features”](#).

You may supply a comment for an event using a `COMMENT` clause. *comment* may be any string of up to 64 characters that you wish to use for describing the event. The comment text, being a string literal, must be surrounded by quotation marks.

The `DO` clause specifies an action carried by the event, and consists of an SQL statement. Nearly any valid MySQL statement which can be used in a stored routine can also be used as the action statement for a scheduled event. (See [Section D.1, “Restrictions on Stored Routines, Triggers, and Events”](#).) For example, the following event `e_hourly` deletes all rows from the `sessions` table once per hour, where this table is part of the `site_activity` schema:

```
CREATE EVENT e_hourly
ON SCHEDULE
EVERY 1 HOUR
COMMENT 'Clears out sessions table each hour.'
DO
DELETE FROM site_activity.sessions;
```

MySQL stores the `sql_mode` system variable setting that is in effect at the time an event is created, and always executes the event with this setting in force, *regardless of the current server SQL mode*.

A `CREATE EVENT` statement that contains an `ALTER EVENT` statement in its `DO` clause appears to succeed; however, when the server attempts to execute the resulting scheduled event, the execution fails with an error.

### Note

Statements such as `SELECT` or `SHOW` that merely return a result set have no effect when used in an event; the output from these is not sent to the MySQL Monitor, nor is it stored anywhere. However, you can use statements such as `SELECT ... INTO` and `INSERT INTO ... SELECT` that store a result. (See the next example in this section for an instance of the latter.)

The schema to which an event belongs is the default schema for table references in the `DO` clause. Any references to tables in other schemas must be qualified with the proper schema name. (In MySQL 5.1.6, all tables referenced in event `DO` clauses had to include a reference to the schema.)

As with stored routines, you can use compound-statement syntax in the `DO` clause by using the `BEGIN` and `END` keywords, as shown here:

```
delimiter |
CREATE EVENT e_daily
ON SCHEDULE
EVERY 1 DAY
COMMENT 'Saves total number of sessions then clears the table each day'
DO
BEGIN
INSERT INTO site_activity.totals (time, total)
SELECT CURRENT_TIMESTAMP, COUNT(*)
FROM site_activity.sessions;
DELETE FROM site_activity.sessions;
END |
delimiter ;
```

Note the use of the `delimiter` command to change the statement delimiter. See [Section 18.1, “Defining Stored Programs”](#).

More complex compound statements, such as those used in stored routines, are possible in an event. This example uses local variables, an error handler, and a flow control construct:

```
delimiter |
CREATE EVENT e
ON SCHEDULE
EVERY 5 SECOND
DO
BEGIN
DECLARE v INTEGER;
DECLARE CONTINUE HANDLER FOR SQLEXCEPTION BEGIN END;

SET v = 0;
```

```

WHILE v < 5 DO
  INSERT INTO t1 VALUES (0);
  UPDATE t2 SET s1 = s1 + 1;
  SET v = v + 1;
END WHILE;
END |
delimiter ;

```

There is no way to pass parameters directly to or from events; however, it is possible to invoke a stored routine with parameters:

```

CREATE EVENT e_call_myproc
ON SCHEDULE
  AT CURRENT_TIMESTAMP + INTERVAL 1 DAY
DO CALL myproc(5, 27);

```

In addition, if the event's definer has the [SUPER](#) privilege, that event may read and write global variables. As granting this privilege entails a potential for abuse, extreme care must be taken in doing so.

Generally, any statements which are valid in stored routines may be used for action statements executed by events. For more information about statements allowable within stored routines, see [Section 18.2.1, “Stored Routine Syntax”](#). You can create an event as part of a stored routine, but an event cannot be created by another event.

## 12.1.12. CREATE FUNCTION Syntax

The `CREATE FUNCTION` statement is used to create stored functions and user-defined functions (UDFs):

- For information about creating stored functions, see [Section 12.1.15, “CREATE PROCEDURE and CREATE FUNCTION Syntax”](#).
- For information about creating user-defined functions, see [Section 12.5.3.1, “CREATE FUNCTION Syntax”](#).

## 12.1.13. CREATE INDEX Syntax

```

CREATE [ONLINE|OFFLINE] [UNIQUE|FULLTEXT|SPATIAL] INDEX index_name
  [index_type]
  ON tbl_name (index_col_name,...)
  [index_option] ...

index_col_name:
  col_name [(length)] [ASC | DESC]

index_type:
  USING {BTREE | HASH | RTREE}

index_option:
  KEY_BLOCK_SIZE [=] value
  | index_type
  | WITH PARSER parser_name

```

`CREATE INDEX` is mapped to an `ALTER TABLE` statement to create indexes. See [Section 12.1.7, “ALTER TABLE Syntax”](#). `CREATE INDEX` cannot be used to create a `PRIMARY KEY`; use `ALTER TABLE` instead. For more information about indexes, see [Section 7.4.4, “How MySQL Uses Indexes”](#).

Normally, you create all indexes on a table at the time the table itself is created with `CREATE TABLE`. See [Section 12.1.17, “CREATE TABLE Syntax”](#). `CREATE INDEX` enables you to add indexes to existing tables.

A column list of the form `(col1,col2,...)` creates a multiple-column index. Index values are formed by concatenating the values of the given columns.

Indexes can be created that use only the leading part of column values, using `col_name(length)` syntax to specify an index prefix length:

- Prefixes can be specified for `CHAR`, `VARCHAR`, `BINARY`, and `VARBINARY` columns.
- `BLOB` and `TEXT` columns also can be indexed, but a prefix length *must* be given.
- Prefix lengths are given in characters for nonbinary string types and in bytes for binary string types. That is, index entries consist of the first *length* characters of each column value for `CHAR`, `VARCHAR`, and `TEXT` columns, and the first *length* bytes of each column value for `BINARY`, `VARBINARY`, and `BLOB` columns.

- For spatial columns, prefix values cannot be given, as described later in this section.

The statement shown here creates an index using the first 10 characters of the `name` column:

```
CREATE INDEX part_of_name ON customer (name(10));
```

If names in the column usually differ in the first 10 characters, this index should not be much slower than an index created from the entire `name` column. Also, using column prefixes for indexes can make the index file much smaller, which could save a lot of disk space and might also speed up `INSERT` operations.

Prefix lengths are storage engine-dependent (for example, a prefix can be up to 1000 bytes long for `MyISAM` tables, 767 bytes for `InnoDB` tables). Note that prefix limits are measured in bytes, whereas the prefix length in `CREATE INDEX` statements is interpreted as number of characters for nonbinary data types (`CHAR`, `VARCHAR`, `TEXT`). Take this into account when specifying a prefix length for a column that uses a multi-byte character set. For example, `utf8` columns require up to three index bytes per character.

Beginning with MySQL 5.1.7, indexes on variable-width columns are created online; that is, creating the indexes does not require any copying of the table. For `NDBCLUSTER` tables, the table is not locked against access from other MySQL Cluster API nodes, although it is locked against other operations on the *same* API node for the duration of the online operation. This is done automatically by the server whenever it determines that it is possible to do so; you do not have to use any special SQL syntax or server options to cause it to happen.

In standard MySQL 5.1 releases, it is not possible to override the server when it determines that an index is to be created online. In MySQL Cluster, beginning with MySQL Cluster NDB 6.2.5 and MySQL Cluster NDB 6.3.3, you can create indexes offline (which causes the table to be locked to all API nodes in the cluster) using the `OFFLINE` keyword. The rules and limitations governing online `CREATE OFFLINE INDEX` and `CREATE ONLINE INDEX` are the same as for `ALTER OFFLINE TABLE ... ADD INDEX` and `ALTER ONLINE TABLE ... ADD INDEX`. You cannot cause the online creation of an index that would normally be created offline by using the `ONLINE` keyword (if it is not possible to perform the `CREATE INDEX` operation online, then the `ONLINE` keyword is ignored). For more information, see [Section 12.1.7, “ALTER TABLE Syntax”](#).

#### Note

The `ONLINE` and `OFFLINE` keywords are available only in MySQL Cluster NDB 6.2 and MySQL Cluster NDB 6.3 releases beginning with versions 6.2.5 and 6.3.3, respectively; attempting to use them in earlier MySQL Cluster NDB 6.2 or 6.3 releases, standard MySQL 5.1 releases, or MySQL Cluster NDB 6.1 releases results in a syntax error.

A `UNIQUE` index creates a constraint such that all values in the index must be distinct. An error occurs if you try to add a new row with a key value that matches an existing row. For all engines, a `UNIQUE` index allows multiple `NULL` values for columns that can contain `NULL`. If you specify a prefix value for a column in a `UNIQUE` index, the column values must be unique within the prefix.

#### MySQL Enterprise

Lack of proper indexes can greatly reduce performance. Subscribe to the MySQL Enterprise Monitor for notification of inefficient use of indexes. For more information, see <http://www.mysql.com/products/enterprise/advisors.html>.

`FULLTEXT` indexes are supported only for `MyISAM` tables and can include only `CHAR`, `VARCHAR`, and `TEXT` columns. Indexing always happens over the entire column; column prefix indexing is not supported and any prefix length is ignored if specified. See [Section 11.8, “Full-Text Search Functions”](#), for details of operation.

The `MyISAM`, `InnoDB`, `NDB`, `BDB`, and `ARCHIVE` storage engines support spatial columns such as (`POINT` and `GEOMETRY`. ([Section 11.13, “Spatial Extensions”](#), describes the spatial data types.) However, support for spatial column indexing varies among engines. Spatial and non-spatial indexes are available according to the following rules.

Spatial indexes (created using `SPATIAL INDEX`):

- Available only for `MyISAM` tables. Specifying a `SPATIAL INDEX` for other storage engines results in an error.
- Indexed columns must be `NOT NULL`.
- In MySQL 5.1, column prefix lengths are prohibited. The full width of each column is indexed.

Non-spatial indexes (created with `INDEX`, `UNIQUE`, or `PRIMARY KEY`):

- Allowed for any storage engine that supports spatial columns except `ARCHIVE`.
- Columns can be `NULL` unless the index is a primary key.

- For each spatial column in a non-[SPATIAL](#) index except [POINT](#) columns, a column prefix length must be specified. (This is the same requirement as for indexed [BLOB](#) columns.) The prefix length is given in bytes.
- The index type for a non-[SPATIAL](#) index depends on the storage engine. Currently, B-tree is used.

In MySQL 5.1:

- You can add an index on a column that can have [NULL](#) values only if you are using the [MyISAM](#), [InnoDB](#), or [MEMORY](#) storage engine.
- You can add an index on a [BLOB](#) or [TEXT](#) column only if you are using the [MyISAM](#), or [InnoDB](#) storage engine.

An [index\\_col\\_name](#) specification can end with [ASC](#) or [DESC](#). These keywords are allowed for future extensions for specifying ascending or descending index value storage. Currently, they are parsed but ignored; index values are always stored in ascending order.

As of MySQL 5.1.10, index options can be given following the index column list. An [index\\_option](#) value can be any of the following:

- [KEY\\_BLOCK\\_SIZE \[=\] value](#)

This option provides a hint to the storage engine about the size in bytes to use for index key blocks. The engine is allowed to change the value if necessary. A value of 0 indicates that the default value should be used.

- [index\\_type](#)

Some storage engines allow you to specify an index type when creating an index. The allowable index type values supported by different storage engines are shown in the following table. Where multiple index types are listed, the first one is the default when no index type specifier is given.

Storage Engine	Allowable Index Types
<a href="#">MyISAM</a>	<a href="#">BTREE</a> , <a href="#">RTREE</a>
<a href="#">InnoDB</a>	<a href="#">BTREE</a>
<a href="#">MEMORY/HEAP</a>	<a href="#">HASH</a> , <a href="#">BTREE</a>
<a href="#">NDB</a>	<a href="#">HASH</a> , <a href="#">BTREE</a> (see note in text)

### Note

[BTREE](#) indexes are implemented by the [NDBCLUSTER](#) storage engine as T-tree indexes.

For indexes on [NDBCLUSTER](#) table columns, the [USING](#) clause can be specified only for a unique index or primary key. In such cases, the [USING HASH](#) clause prevents the creation of an implicit ordered index. Without [USING HASH](#), a statement defining a unique index or primary key automatically results in the creation of a [HASH](#) index in addition to the ordered index, both of which index the same set of columns.

The [RTREE](#) index type is allowable only for [SPATIAL](#) indexes.

If you specify an index type that is not legal for a given storage engine, but there is another index type available that the engine can use without affecting query results, the engine uses the available type.

Examples:

```
CREATE TABLE lookup (id INT) ENGINE = MEMORY;
CREATE INDEX id_index USING BTREE ON lookup (id);
```

[TYPE type\\_name](#) is recognized as a synonym for [USING type\\_name](#). However, [USING](#) is the preferred form.

Before MySQL 5.1.10, this option can be given only before the [ON tbl\\_name](#) clause. Use of the option in this position is deprecated as of 5.1.10; support for it is to be dropped in a future MySQL release. If an [index\\_type](#) option is given in both the earlier and later positions, the final option applies.

- [WITH\\_PARSER parser\\_name](#)

This option can be used only with [FULLTEXT](#) indexes. It associates a parser plugin with the index if full-text indexing and

searching operations need special handling. See [Section 21.2, “The MySQL Plugin Interface”](#), for details on creating plugins.

## 12.1.14. CREATE LOGFILE GROUP Syntax

```
CREATE LOGFILE GROUP logfile_group
  ADD UNDOFILE 'undo_file'
  [INITIAL_SIZE [=] initial_size]
  [UNDO_BUFFER_SIZE [=] undo_buffer_size]
  [REDO_BUFFER_SIZE [=] redo_buffer_size]
  [NODEGROUP [=] nodegroup_id]
  [WAIT]
  [COMMENT [=] comment_text]
  [ENGINE [=] engine_name]
```

This statement creates a new log file group named *logfile\_group* having a single UNDO file named '*undo\_file*'. A `CREATE LOGFILE GROUP` statement has one and only one `ADD UNDOFILE` clause. For rules covering the naming of log file groups, see [Section 8.2, “Schema Object Names”](#).

### Note

All MySQL Cluster Disk Data objects share the same namespace. This means that *each Disk Data object* must be uniquely named (and not merely each Disk Data object of a given type). For example, you cannot have a tablespace and a log file group with the same name, or a tablespace and a data file with the same name.

Beginning with MySQL 5.1.8, you can have only one log file group per Cluster at any given time. (See [Bug#16386](#))

Prior to MySQL Cluster NDB 6.2.17, 6.3.23, and 6.4.3, path and file names for undo log files could not be longer than 128 characters. ([Bug#31769](#))

The optional `INITIAL_SIZE` parameter sets the UNDO file's initial size; if not specified, it defaults to `128M` (128 megabytes). The optional `UNDO_BUFFER_SIZE` parameter sets the size used by the UNDO buffer for the log file group; The default value for `UNDO_BUFFER_SIZE` is `8M` (eight megabytes); this value cannot exceed the amount of system memory available. Both of these parameters are specified in bytes. You may optionally follow either or both of these with a one-letter abbreviation for an order of magnitude, similar to those used in `my.cnf`. Generally, this is one of the letters `M` (for megabytes) or `G` (for gigabytes).

Beginning with MySQL Cluster NDB 6.2.17, 6.3.23, and 6.4.3, the maximum permitted for `UNDO_BUFFER_SIZE` is `600M`; previously, it was `150M`. ([Bug#34102](#))

On 32-bit systems, the maximum supported value for `INITIAL_SIZE` is `4G`. ([Bug#29186](#))

Beginning with MySQL Cluster NDB 2.1.18, 6.3.24, and 7.0.4, the minimum allowed value for `INITIAL_SIZE` is `1M`. ([Bug#29574](#))

The `ENGINE` parameter determines the storage engine to be used by this log file group, with *engine\_name* being the name of the storage engine. In MySQL 5.1, *engine\_name* must be one of the values `NDB` or `NDBCLUSTER`.

`REDO_BUFFER_SIZE`, `NODEGROUP`, `WAIT`, and `COMMENT` are parsed but ignored, and so have no effect in MySQL 5.1. These options are intended for future expansion.

When used with `ENGINE [=] NDB`, a log file group and associated UNDO log file are created on each Cluster data node. You can verify that the UNDO files were created and obtain information about them by querying the `INFORMATION_SCHEMA.FILES` table. For example:

```
mysql> SELECT LOGFILE_GROUP_NAME, LOGFILE_GROUP_NUMBER, EXTRA
-> FROM INFORMATION_SCHEMA.FILES
-> WHERE FILE_NAME = 'undo_10.dat';
+-----+-----+-----+
| LOGFILE_GROUP_NAME | LOGFILE_GROUP_NUMBER | EXTRA          |
+-----+-----+-----+
| lg_3              | 11                   | CLUSTER_NODE=3 |
| lg_3              | 11                   | CLUSTER_NODE=4 |
+-----+-----+-----+
2 rows in set (0.06 sec)
```

`CREATE LOGFILE GROUP` was added in MySQL 5.1.6. In MySQL 5.1, it is useful only with Disk Data storage for MySQL Cluster. See [MySQL Cluster Disk Data Tables](#).

## 12.1.15. CREATE PROCEDURE and CREATE FUNCTION Syntax

```
CREATE
  [DEFINER = { user | CURRENT_USER }]
  PROCEDURE sp_name ([proc_parameter[,...]])
  [characteristic ...] routine_body
```



```

CREATE
  [DEFINER = { user | CURRENT_USER }]
  FUNCTION sp_name ([func_parameter[,...]])
  RETURNS type
  [characteristic ...] routine_body

proc_parameter:
  [ IN | OUT | INOUT ] param_name type

func_parameter:
  param_name type

type:
  Any valid MySQL data type

characteristic:
  LANGUAGE SQL
  [NOT] DETERMINISTIC
  { CONTAINS SQL | NO SQL | READS SQL DATA | MODIFIES SQL DATA }
  SQL SECURITY { DEFINER | INVOKER }
  COMMENT 'string'

routine_body:
  Valid SQL procedure statement

```

These statements create stored routines. By default, a routine is associated with the default database. To associate the routine explicitly with a given database, specify the name as *db\_name.sp\_name* when you create it.

The `CREATE FUNCTION` statement is also used in MySQL to support UDFs (user-defined functions). See [Section 21.3, “Adding New Functions to MySQL”](#). A UDF can be regarded as an external stored function. However, do note that stored functions share their namespace with UDFs. See [Section 8.2.4, “Function Name Parsing and Resolution”](#), for the rules describing how the server interprets references to different kinds of functions.

To invoke a stored procedure, use the `CALL` statement (see [Section 12.2.1, “CALL Syntax”](#)). To invoke a stored function, refer to it in an expression. The function returns a value during expression evaluation.

To execute the `CREATE PROCEDURE` or `CREATE FUNCTION` statement, it is necessary to have the `CREATE ROUTINE` privilege. By default, MySQL automatically grants the `ALTER ROUTINE` and `EXECUTE` privileges to the routine creator. This behavior can be changed by disabling the `automatic_sp_privileges` system variable. See [Section 18.2.2, “Stored Routines and MySQL Privileges”](#). If binary logging is enabled, the `CREATE FUNCTION` statement might also require the `SUPER` privilege, as described in [Section 18.6, “Binary Logging of Stored Programs”](#).

The `DEFINER` and `SQL SECURITY` clauses specify the security context to be used when checking access privileges at routine execution time, as described later.

If the routine name is the same as the name of a built-in SQL function, a syntax error occurs unless you use a space between the name and the following parenthesis when defining the routine or invoking it later. For this reason, avoid using the names of existing SQL functions for your own stored routines.

The `IGNORE_SPACE` SQL mode applies to built-in functions, not to stored routines. It is always allowable to have spaces after a stored routine name, regardless of whether `IGNORE_SPACE` is enabled.

The parameter list enclosed within parentheses must always be present. If there are no parameters, an empty parameter list of `()` should be used. Parameter names are not case sensitive.

Each parameter is an `IN` parameter by default. To specify otherwise for a parameter, use the keyword `OUT` or `INOUT` before the parameter name.

### Note

Specifying a parameter as `IN`, `OUT`, or `INOUT` is valid only for a `PROCEDURE`. (`FUNCTION` parameters are always regarded as `IN` parameters.)

An `IN` parameter passes a value into a procedure. The procedure might modify the value, but the modification is not visible to the caller when the procedure returns. An `OUT` parameter passes a value from the procedure back to the caller. Its initial value is `NULL` within the procedure, and its value is visible to the caller when the procedure returns. An `INOUT` parameter is initialized by the caller, can be modified by the procedure, and any change made by the procedure is visible to the caller when the procedure returns.

For each `OUT` or `INOUT` parameter, pass a user-defined variable in the `CALL` statement that invokes the procedure so that you can obtain its value when the procedure returns. If you are calling the procedure from within another stored procedure or function, you can also pass a routine parameter or local routine variable as an `IN` or `INOUT` parameter.

The following example shows a simple stored procedure that uses an `OUT` parameter:

```

mysql> delimiter //
mysql> CREATE PROCEDURE simpleproc (OUT param1 INT)
-> BEGIN
->   SELECT COUNT(*) INTO param1 FROM t;

```



```

-> END//
Query OK, 0 rows affected (0.00 sec)

mysql> delimiter ;

mysql> CALL simpleproc(@a);
Query OK, 0 rows affected (0.00 sec)

mysql> SELECT @a;
+-----+
| @a    |
+-----+
| 3     |
+-----+
1 row in set (0.00 sec)

```

The example uses the `mysql` client `delimiter` command to change the statement delimiter from `;` to `//` while the procedure is being defined. This allows the `;` delimiter used in the procedure body to be passed through to the server rather than being interpreted by `mysql` itself. See [Section 18.1, “Defining Stored Programs”](#).

The `RETURNS` clause may be specified only for a `FUNCTION`, for which it is mandatory. It indicates the return type of the function, and the function body must contain a `RETURN value` statement. If the `RETURN` statement returns a value of a different type, the value is coerced to the proper type. For example, if a function specifies an `ENUM` or `SET` value in the `RETURNS` clause, but the `RETURN` statement returns an integer, the value returned from the function is the string for the corresponding `ENUM` member of set of `SET` members.

The following example function takes a parameter, performs an operation using an SQL function, and returns the result. In this case, it is unnecessary to use `delimiter` because the function definition contains no internal `;` statement delimiters:

```

mysql> CREATE FUNCTION hello (s CHAR(20))
mysql> RETURNS CHAR(50) DETERMINISTIC
-> RETURN CONCAT('Hello, ',s,'!');
Query OK, 0 rows affected (0.00 sec)

mysql> SELECT hello('world');
+-----+
| hello('world') |
+-----+
| Hello, world!  |
+-----+
1 row in set (0.00 sec)

```

Parameter types and function return types can be declared to use any valid data type, except that the `COLLATE` attribute cannot be used.

The `routine_body` consists of a valid SQL procedure statement. This can be a simple statement such as `SELECT` or `INSERT`, or it can be a compound statement written using `BEGIN` and `END`. Compound statements can contain declarations, loops, and other control structure statements. The syntax for these statements is described in [Section 12.8, “MySQL Compound-Statement Syntax”](#).

MySQL allows routines to contain DDL statements, such as `CREATE` and `DROP`. MySQL also allows stored procedures (but not stored functions) to contain SQL transaction statements such as `COMMIT`. Stored functions may not contain statements that perform explicit or implicit commit or rollback. Support for these statements is not required by the SQL standard, which states that each DBMS vendor may decide whether to allow them.

Statements that return a result set can be used within a stored procedure but not within a stored function. This prohibition includes `SELECT` statements that do not have an `INTO var_list` clause and other statements such as `SHOW`, `EXPLAIN`, and `CHECK TABLE`. For statements that can be determined at function definition time to return a result set, a `Not allowed to return a result set from a function` error occurs (`ER_SP_NO_RETSET`). For statements that can be determined only at runtime to return a result set, a `PROCEDURE %s can't return a result set in the given context` error occurs (`ER_SP_BADSELECT`).

`USE` statements within stored routines are disallowed. When a routine is invoked, an implicit `USE db_name` is performed (and undone when the routine terminates). This causes the routine to have the given default database while it executes. References to objects in databases other than the routine default database should be qualified with the appropriate database name.

For additional information about statements that are not allowed in stored routines, see [Section D.1, “Restrictions on Stored Routines, Triggers, and Events”](#).

For information about invoking stored procedures from within programs written in a language that has a MySQL interface, see [Section 12.2.1, “CALL Syntax”](#).

MySQL stores the `sql_mode` system variable setting that is in effect at the time a routine is created, and always executes the routine with this setting in force, *regardless of the server SQL mode in effect when the routine is invoked*.

The switch from the SQL mode of the invoker to that of the routine occurs after evaluation of arguments and assignment of the resulting values to routine parameters. If you define a routine in strict SQL mode but invoke it in non-strict mode, assignment of arguments to routine parameters does not take place in strict mode. If you require that expressions passed to a routine be assigned in

strict SQL mode, you should invoke the routine with strict mode in effect.

A procedure or function is considered “deterministic” if it always produces the same result for the same input parameters, and “not deterministic” otherwise. If neither `DETERMINISTIC` nor `NOT DETERMINISTIC` is given in the routine definition, the default is `NOT DETERMINISTIC`.

A routine that contains the `NOW()` function (or its synonyms) or `RAND()` is non-deterministic, but it might still be replication-safe. For `NOW()`, the binary log includes the timestamp and replicates correctly. `RAND()` also replicates correctly as long as it is called only a single time during the execution of a routine. (You can consider the routine execution timestamp and random number seed as implicit inputs that are identical on the master and slave.)

Prior to MySQL 5.1.21, the `DETERMINISTIC` characteristic is accepted, but not used by the optimizer. However, if binary logging is enabled, this characteristic always affects which routine definitions MySQL accepts. See [Section 18.6, “Binary Logging of Stored Programs”](#).

Several characteristics provide information about the nature of data use by the routine. In MySQL, these characteristics are advisory only. The server does not use them to constrain what kinds of statements a routine will be allowed to execute.

- `CONTAINS SQL` indicates that the routine does not contain statements that read or write data. This is the default if none of these characteristics is given explicitly. Examples of such statements are `SET @x = 1` or `DO RELEASE_LOCK('abc')`, which execute but neither read nor write data.
- `NO SQL` indicates that the routine contains no SQL statements.
- `READS SQL DATA` indicates that the routine contains statements that read data (for example, `SELECT`), but not statements that write data.
- `MODIFIES SQL DATA` indicates that the routine contains statements that may write data (for example, `INSERT` or `DELETE`).

The `SQL SECURITY` characteristic can be used to specify whether the routine should be executed using the permissions of the user who creates the routine or the user who invokes it. The default value is `DEFINER`. This feature is new in SQL:2003. The creator or invoker must have permission to access the database with which the routine is associated. It is necessary to have the `EXECUTE` privilege to be able to execute the routine. The user that must have this privilege is either the definer or invoker, depending on how the `SQL SECURITY` characteristic is set.

The `COMMENT` characteristic is a MySQL extension, and may be used to describe the stored routine. This information is displayed by the `SHOW CREATE PROCEDURE` and `SHOW CREATE FUNCTION` statements.

The optional `DEFINER` clause specifies the MySQL account to be used when checking access privileges at routine execution time for routines that have the `SQL SECURITY DEFINER` characteristic. The `DEFINER` clause was added in MySQL 5.1.8.

If a `user` value is given for the `DEFINER` clause, it should be a MySQL account in '`user_name`'@'`host_name`' format (the same format used in the `GRANT` statement). The `user_name` and `host_name` values both are required. The definer can also be given as `CURRENT_USER` or `CURRENT_USER()`. The default `DEFINER` value is the user who executes the `CREATE PROCEDURE` or `CREATE FUNCTION` or statement. (This is the same as `DEFINER = CURRENT_USER`.)

If you specify the `DEFINER` clause, these rules determine the legal `DEFINER` user values:

- If you do not have the `SUPER` privilege, the only legal `user` value is your own account, either specified literally or by using `CURRENT_USER`. You cannot set the definer to some other account.
- If you have the `SUPER` privilege, you can specify any syntactically legal account name. If the account does not actually exist, a warning is generated.
- Although it is possible to create routines with a non-existent `DEFINER` value, an error occurs if the routine executes with definer privileges but the definer does not exist at execution time.

Within a stored routine that is defined with the `SQL SECURITY DEFINER` characteristic, `CURRENT_USER` returns the routine's `DEFINER` value. For information about user auditing within stored routines, see [Section 5.5.9, “Auditing MySQL Account Activity”](#).

Consider the following procedure, which displays a count of the number of MySQL accounts listed in the `mysql.user` table:

```
CREATE DEFINER = 'admin'@'localhost' PROCEDURE account_count()
BEGIN
  SELECT 'Number of accounts:', COUNT(*) FROM mysql.user;
END;
```

The procedure is assigned a [DEFINER](#) account of 'admin'@'localhost' no matter which user defines it. It executes with the privileges of that account no matter which user invokes it (because the default security characteristic is [DEFINER](#)). The procedure succeeds or fails depending on whether 'admin'@'localhost' has the [EXECUTE](#) privilege for it and the [SELECT](#) privilege for the `mysql.user` table.

Now suppose that the procedure is defined with the [SQL SECURITY INVOKER](#) characteristic:

```
CREATE DEFINER = 'admin'@'localhost' PROCEDURE account_count()
SQL SECURITY INVOKER
BEGIN
  SELECT 'Number of accounts:', COUNT(*) FROM mysql.user;
END;
```

The procedure still has a [DEFINER](#) of 'admin'@'localhost', but in this case, it executes with the privileges of the invoking user. Thus, the procedure succeeds or fails depending on whether the invoker has the required privileges.

The server handles the data type of a routine parameter, local routine variable created with [DECLARE](#), or function return value as follows:

- Assignments are checked for data type mismatches and overflow. Conversion and overflow problems result in warnings, or errors in strict SQL mode.
- Only scalar values can be assigned. For example, a statement such as `SET x = (SELECT 1, 2)` is invalid.
- For character data types, if there is a [CHARACTER SET](#) attribute in the declaration, the specified character set and its default collation are used. If there is no such attribute, the database character set in effect at routine creation time and its default collation are used. (The database character set is given by the value of the `character_set_database` system variable.) The [COLLATE](#) attribute is not supported. (This includes use of [BINARY](#), because in this context [BINARY](#) specifies the binary collation of the character set.)

## 12.1.16. CREATE SERVER Syntax

```
CREATE SERVER server_name
  FOREIGN DATA WRAPPER wrapper_name
  OPTIONS (option [, option] ...)

option:
{
  HOST character-literal
  DATABASE character-literal
  USER character-literal
  PASSWORD character-literal
  SOCKET character-literal
  OWNER character-literal
  PORT numeric-literal }
```

This statement creates the definition of a server for use with the [FEDERATED](#) storage engine. The [CREATE SERVER](#) statement creates a new row within the `servers` table within the `mysql` database. This statement requires the [SUPER](#) privilege.

The *server\_name* should be a unique reference to the server. Server definitions are global within the scope of the server, it is not possible to qualify the server definition to a specific database. *server\_name* has a maximum length of 64 characters (names longer than 64 characters are silently truncated), and is case insensitive. You may specify the name as a quoted string.

The *wrapper\_name* should be `mysql`, and may be quoted with single quotes. Other values for *wrapper\_name* are not currently supported.

For each *option* you must specify either a character literal or numeric literal. Character literals are UTF-8, support a maximum length of 64 characters and default to a blank (empty) string. String literals are silently truncated to 64 characters. Numeric literals must be a number between 0 and 9999, default value is 0.

### Note

Note that the [OWNER](#) option is currently not applied, and has no effect on the ownership or operation of the server connection that is created.

The [CREATE SERVER](#) statement creates an entry in the `mysql.server` table that can later be used with the [CREATE TABLE](#) statement when creating a [FEDERATED](#) table. The options that you specify will be used to populate the columns in the `mysql.server` table. The table columns are `Server_name`, `Host`, `Db`, `Username`, `Password`, `Port` and `Socket`.

For example:

```
CREATE SERVER s
FOREIGN DATA WRAPPER mysql
```

```
OPTIONS (USER 'Remote', HOST '192.168.1.106', DATABASE 'test');
```

The data stored in the table can be used when creating a connection to a [FEDERATED](#) table:

```
CREATE TABLE t (s1 INT) ENGINE=FEDERATED CONNECTION='s';
```

For more information, see [Section 13.10, “The FEDERATED Storage Engine”](#).

`CREATE SERVER` does not cause an automatic commit.

`CREATE SERVER` was added in MySQL 5.1.15.

## 12.1.17. CREATE TABLE Syntax

```
CREATE [TEMPORARY] TABLE [IF NOT EXISTS] tbl_name
(create_definition,...)
[table_options]
[partition_options]
```

Or:

```
CREATE [TEMPORARY] TABLE [IF NOT EXISTS] tbl_name
[ (create_definition,...) ]
[table_options]
[partition_options]
select_statement
```

Or:

```
CREATE [TEMPORARY] TABLE [IF NOT EXISTS] tbl_name
{ LIKE old_tbl_name | (LIKE old_tbl_name) }
```

```
create_definition:
  col_name column_definition
  | [CONSTRAINT [symbol]] PRIMARY KEY [index_type] (index_col_name,...)
    [index_option] ...
  | {INDEX|KEY} [index_name] [index_type] (index_col_name,...)
    [index_option] ...
  | [CONSTRAINT [symbol]] UNIQUE [INDEX|KEY]
    [index_name] [index_type] (index_col_name,...)
    [index_option] ...
  | {FULLTEXT|SPATIAL} [INDEX|KEY] [index_name] (index_col_name,...)
    [index_option] ...
  | [CONSTRAINT [symbol]] FOREIGN KEY
    [index_name] (index_col_name,...) reference_definition
  | CHECK (expr)

column_definition:
  data_type [NOT NULL | NULL] [DEFAULT default_value]
  [AUTO_INCREMENT] [UNIQUE [KEY] | [PRIMARY] KEY]
  [COMMENT 'string']
  [COLUMN_FORMAT {FIXED|DYNAMIC|DEFAULT}]
  [STORAGE {DISK|MEMORY|DEFAULT}]
  [reference_definition]

data_type:
  BIT[(length)]
  TINYINT[(length)] [UNSIGNED] [ZEROFILL]
  SMALLINT[(length)] [UNSIGNED] [ZEROFILL]
  MEDIUMINT[(length)] [UNSIGNED] [ZEROFILL]
  INT[(length)] [UNSIGNED] [ZEROFILL]
  INTEGER[(length)] [UNSIGNED] [ZEROFILL]
  BIGINT[(length)] [UNSIGNED] [ZEROFILL]
  REAL[(length,decimals)] [UNSIGNED] [ZEROFILL]
  DOUBLE[(length,decimals)] [UNSIGNED] [ZEROFILL]
  FLOAT[(length,decimals)] [UNSIGNED] [ZEROFILL]
  DECIMAL[(length[,decimals])] [UNSIGNED] [ZEROFILL]
  NUMERIC[(length[,decimals])] [UNSIGNED] [ZEROFILL]
  DATE
  TIME
  TIMESTAMP
  DATETIME
  YEAR
  CHAR[(length)]
    [CHARACTER SET charset_name] [COLLATE collation_name]
  VARCHAR(length)
    [CHARACTER SET charset_name] [COLLATE collation_name]
  BINARY[(length)]
  VARBINARY(length)
  TINYBLOB
  BLOB
  MEDIUMBLOB
  LONGBLOB
  TINYTEXT [BINARY]
    [CHARACTER SET charset_name] [COLLATE collation_name]
```

```

| TEXT [BINARY]
|   [CHARACTER SET charset_name] [COLLATE collation_name]
| MEDIUMTEXT [BINARY]
|   [CHARACTER SET charset_name] [COLLATE collation_name]
| LONGTEXT [BINARY]
|   [CHARACTER SET charset_name] [COLLATE collation_name]
| ENUM(value1,value2,value3,...)
|   [CHARACTER SET charset_name] [COLLATE collation_name]
| SET(value1,value2,value3,...)
|   [CHARACTER SET charset_name] [COLLATE collation_name]
| spatial_type

index_col_name:
  col_name [(length)] [ASC | DESC]

index_type:
  USING {BTREE | HASH | RTREE}

index_option:
  KEY_BLOCK_SIZE [=] value
  | index_type
  | WITH PARSER parser_name

reference_definition:
  REFERENCES tbl_name (index_col_name,...)
  | [MATCH FULL | MATCH PARTIAL | MATCH SIMPLE]
  | [ON DELETE reference_option]
  | [ON UPDATE reference_option]

reference_option:
  RESTRICT | CASCADE | SET NULL | NO ACTION

table_options:
  table_option [, table_option] ...

table_option:
  ENGINE [=] engine_name
  | AUTO_INCREMENT [=] value
  | AVG_ROW_LENGTH [=] value
  | [DEFAULT] CHARACTER SET [=] charset_name
  | CHECKSUM [=] {0 | 1}
  | [DEFAULT] COLLATE [=] collation_name
  | COMMENT [=] 'string'
  | CONNECTION [=] 'connect_string'
  | DATA DIRECTORY [=] 'absolute path to directory'
  | DELAY_KEY_WRITE [=] {0 | 1}
  | INDEX DIRECTORY [=] 'absolute path to directory'
  | INSERT_METHOD [=] { NO | FIRST | LAST }
  | KEY_BLOCK_SIZE [=] value
  | MAX_ROWS [=] value
  | MIN_ROWS [=] value
  | PACK_KEYS [=] {0 | 1 | DEFAULT}
  | PASSWORD [=] 'string'
  | ROW_FORMAT [=] {DEFAULT|DYNAMIC|FIXED|COMPRESSED|REDUNDANT|COMPACT}
  | TABLESPACE tablespace_name [STORAGE {DISK|MEMORY|DEFAULT}]
  | UNION [=] (tbl_name [, tbl_name]...)

partition_options:
  PARTITION BY
  | { [LINEAR] HASH(expr)
  |   [LINEAR] KEY(column_list)
  |   RANGE(expr)
  |   LIST(expr) }
  | [PARTITIONS num]
  | [SUBPARTITION BY
  |   { [LINEAR] HASH(expr)
  |     [LINEAR] KEY(column_list) }
  |   [SUBPARTITIONS num]
  | ]
  | [(partition_definition [, partition_definition] ...)]

partition_definition:
  PARTITION partition_name
  | [VALUES {LESS THAN {(expr) | MAXVALUE} | IN (value_list)}]
  | [[STORAGE] ENGINE [=] engine_name]
  | [COMMENT [=] 'comment_text' ]
  | [DATA DIRECTORY [=] 'data_dir' ]
  | [INDEX DIRECTORY [=] 'index_dir' ]
  | [MAX_ROWS [=] max_number_of_rows]
  | [MIN_ROWS [=] min_number_of_rows]
  | [TABLESPACE [=] tablespace_name]
  | [NODEGROUP [=] node_group_id]
  | [(subpartition_definition [, subpartition_definition] ...)]

subpartition_definition:
  SUBPARTITION logical_name
  | [[STORAGE] ENGINE [=] engine_name]
  | [COMMENT [=] 'comment_text' ]
  | [DATA DIRECTORY [=] 'data_dir' ]
  | [INDEX DIRECTORY [=] 'index_dir' ]
  | [MAX_ROWS [=] max_number_of_rows]
  | [MIN_ROWS [=] min_number_of_rows]
  | [TABLESPACE [=] tablespace_name]
  | [NODEGROUP [=] node_group_id]

select_statement:
  [IGNORE | REPLACE] [AS] SELECT ... (Some legal select statement)

```

`CREATE TABLE` creates a table with the given name. You must have the `CREATE` privilege for the table.

Rules for allowable table names are given in [Section 8.2, “Schema Object Names”](#). By default, the table is created in the default database. An error occurs if the table exists, if there is no default database, or if the database does not exist.

The table name can be specified as `db_name.tbl_name` to create the table in a specific database. This works regardless of whether there is a default database, assuming that the database exists. If you use quoted identifiers, quote the database and table names separately. For example, write ``mydb`.`mytbl``, not ``mydb.mytbl``.

You can use the `TEMPORARY` keyword when creating a table. A `TEMPORARY` table is visible only to the current connection, and is dropped automatically when the connection is closed. This means that two different connections can use the same temporary table name without conflicting with each other or with an existing non-`TEMPORARY` table of the same name. (The existing table is hidden until the temporary table is dropped.) To create temporary tables, you must have the `CREATE TEMPORARY TABLES` privilege.

### Note

`CREATE TABLE` does not automatically commit the current active transaction if you use the `TEMPORARY` keyword.

The keywords `IF NOT EXISTS` prevent an error from occurring if the table exists. However, there is no verification that the existing table has a structure identical to that indicated by the `CREATE TABLE` statement.

MySQL represents each table by an `.frm` table format (definition) file in the database directory. The storage engine for the table might create other files as well. In the case of `MyISAM` tables, the storage engine creates data and index files. Thus, for each `MyISAM` table `tbl_name`, there are three disk files.

File	Purpose
<code>tbl_name.frm</code>	Table format (definition) file
<code>tbl_name.MYD</code>	Data file
<code>tbl_name.MYI</code>	Index file

[Chapter 13, \*Storage Engines\*](#), describes what files each storage engine creates to represent tables. If a table name contains special characters, the names for the table files contain encoded versions of those characters as described in [Section 8.2.3, “Mapping of Identifiers to File Names”](#).

`data_type` represents the data type in a column definition. `spatial_type` represents a spatial data type. The data type syntax shown is representative only. For a full description of the syntax available for specifying column data types, as well as information about the properties of each type, see [Chapter 10, \*Data Types\*](#), and [Section 11.13, “Spatial Extensions”](#).

Some attributes do not apply to all data types. `AUTO_INCREMENT` applies only to integer and floating-point types. `DEFAULT` does not apply to the `BLOB` or `TEXT` types.

- If neither `NULL` nor `NOT NULL` is specified, the column is treated as though `NULL` had been specified.
- An integer or floating-point column can have the additional attribute `AUTO_INCREMENT`. When you insert a value of `NULL` (recommended) or `0` into an indexed `AUTO_INCREMENT` column, the column is set to the next sequence value. Typically this is `value+1`, where `value` is the largest value for the column currently in the table. `AUTO_INCREMENT` sequences begin with `1`.

To retrieve an `AUTO_INCREMENT` value after inserting a row, use the `LAST_INSERT_ID()` SQL function or the `mysql_insert_id()` C API function. See [Section 11.11.3, “Information Functions”](#), and [Section 20.10.3.37, “mysql\\_insert\\_id\(\)”](#).

If the `NO_AUTO_VALUE_ON_ZERO` SQL mode is enabled, you can store `0` in `AUTO_INCREMENT` columns as `0` without generating a new sequence value. See [Section 5.1.7, “Server SQL Modes”](#).

### Note

There can be only one `AUTO_INCREMENT` column per table, it must be indexed, and it cannot have a `DEFAULT` value. An `AUTO_INCREMENT` column works properly only if it contains only positive values. Inserting a negative number is regarded as inserting a very large positive number. This is done to avoid precision problems when numbers “wrap” over from positive to negative and also to ensure that you do not accidentally get an `AUTO_INCREMENT` column that contains `0`.

For `MyISAM` tables, you can specify an `AUTO_INCREMENT` secondary column in a multiple-column key. See [Section 3.6.9, “Using AUTO\\_INCREMENT”](#).

To make MySQL compatible with some ODBC applications, you can find the `AUTO_INCREMENT` value for the last inserted row with the following query:

```
SELECT * FROM tbl_name WHERE auto_col IS NULL
```

For information about `InnoDB` and `AUTO_INCREMENT`, see [Section 13.6.4.3, “AUTO\\_INCREMENT Handling in InnoDB”](#).

- Character data types (`CHAR`, `VARCHAR`, `TEXT`) can include `CHARACTER SET` and `COLLATE` attributes to specify the character set and collation for the column. For details, see [Section 9.1, “Character Set Support”](#). `CHARSET` is a synonym for `CHARACTER SET`. Example:

```
CREATE TABLE t (c CHAR(20) CHARACTER SET utf8 COLLATE utf8_bin);
```

MySQL 5.1 interprets length specifications in character column definitions in characters. (Versions before MySQL 4.1 interpreted them in bytes.) Lengths for `BINARY` and `VARBINARY` are in bytes.

- The `DEFAULT` clause specifies a default value for a column. With one exception, the default value must be a constant; it cannot be a function or an expression. This means, for example, that you cannot set the default for a date column to be the value of a function such as `NOW()` or `CURRENT_DATE`. The exception is that you can specify `CURRENT_TIMESTAMP` as the default for a `TIMESTAMP` column. See [Section 10.3.1.1, “TIMESTAMP Properties”](#).

If a column definition includes no explicit `DEFAULT` value, MySQL determines the default value as described in [Section 10.1.4, “Data Type Default Values”](#).

`BLOB` and `TEXT` columns cannot be assigned a default value.

`CREATE TABLE` fails if a date-valued default is not correct according to the `NO_ZERO_IN_DATE` SQL mode, even if strict SQL mode is not enabled. For example, `c1 DATE DEFAULT '2010-00-00'` causes `CREATE TABLE` to fail with `In-valid default value for 'c1'`.

- A comment for a column can be specified with the `COMMENT` option, up to 255 characters long. The comment is displayed by the `SHOW CREATE TABLE` and `SHOW FULL COLUMNS` statements.
- Beginning with MySQL Cluster NDB 6.2.5 and MySQL Cluster NDB 6.3.2, it is also possible to specify a data storage format for individual columns of `NDB` tables using `COLUMN_FORMAT`. Allowable column formats are `FIXED`, `DYNAMIC`, and `DEFAULT`. `FIXED` is used to specify fixed-width storage, `DYNAMIC` allows the column to be variable-width, and `DEFAULT` causes the column to use fixed-width or variable-width storage as determined by the column's data type (possibly overridden by a `ROW_FORMAT` specifier).

For `NDB` tables, the default value for `COLUMN_FORMAT` is `DEFAULT`.

`COLUMN_FORMAT` currently has no effect on columns of tables using storage engines other than `NDB`.

- For `NDB` tables, beginning with MySQL Cluster NDB 6.2.5 and MySQL Cluster NDB 6.3.2, it is also possible to specify whether the column is stored on disk or in memory by using a `STORAGE` clause. `STORAGE DISK` causes the column to be stored on disk, and `STORAGE MEMORY` causes in-memory storage to be used. The `CREATE TABLE` statement used must still include a `TABLESPACE` clause:

```
mysql> CREATE TABLE t1 (
->   c1 INT STORAGE DISK,
->   c2 INT STORAGE MEMORY
-> ) ENGINE NDB;
ERROR 1005 (HY000): CAN'T CREATE TABLE 'c.t1' (ERRNO: 140)

mysql> CREATE TABLE t1 (
->   c1 INT STORAGE DISK,
->   c2 INT STORAGE MEMORY
-> ) TABLESPACE ts_1 ENGINE NDB;
Query OK, 0 rows affected (1.06 sec)
```

For `NDB` tables, `STORAGE DEFAULT` is equivalent to `STORAGE MEMORY`.

The `STORAGE` clause has no effect on tables using storage engines other than `NDB`.

- `KEY` is normally a synonym for `INDEX`. The key attribute `PRIMARY KEY` can also be specified as just `KEY` when given in a column definition. This was implemented for compatibility with other database systems.
- A `UNIQUE` index creates a constraint such that all values in the index must be distinct. An error occurs if you try to add a new row with a key value that matches an existing row. For all engines, a `UNIQUE` index allows multiple `NULL` values for columns that can contain `NULL`.



- A **PRIMARY KEY** is a unique index where all key columns must be defined as **NOT NULL**. If they are not explicitly declared as **NOT NULL**, MySQL declares them so implicitly (and silently). A table can have only one **PRIMARY KEY**. If you do not have a **PRIMARY KEY** and an application asks for the **PRIMARY KEY** in your tables, MySQL returns the first **UNIQUE** index that has no **NULL** columns as the **PRIMARY KEY**.

In **InnoDB** tables, having a long **PRIMARY KEY** wastes a lot of space. (See [Section 13.6.10](#), “**InnoDB Table and Index Structures**”.)

- In the created table, a **PRIMARY KEY** is placed first, followed by all **UNIQUE** indexes, and then the non-unique indexes. This helps the MySQL optimizer to prioritize which index to use and also more quickly to detect duplicated **UNIQUE** keys.
- A **PRIMARY KEY** can be a multiple-column index. However, you cannot create a multiple-column index using the **PRIMARY KEY** key attribute in a column specification. Doing so only marks that single column as primary. You must use a separate **PRIMARY KEY(index\_col\_name, ...)** clause.
- If a **PRIMARY KEY** or **UNIQUE** index consists of only one column that has an integer type, you can also refer to the column as **\_rowid** in **SELECT** statements.
- In MySQL, the name of a **PRIMARY KEY** is **PRIMARY**. For other indexes, if you do not assign a name, the index is assigned the same name as the first indexed column, with an optional suffix (**\_2**, **\_3**, ...) to make it unique. You can see index names for a table using **SHOW INDEX FROM tbl\_name**. See [Section 12.5.5.23](#), “**SHOW INDEX Syntax**”.
- Some storage engines allow you to specify an index type when creating an index. The syntax for the *index\_type* specifier is **USING type\_name**.

Example:

```
CREATE TABLE lookup
(id INT, INDEX USING BTREE (id))
ENGINE = MEMORY;
```

Before MySQL 5.1.10, **USING** can be given only before the index column list. As of 5.1.10, the preferred position is after the column list. Use of the option before the column list will no longer be recognized in a future MySQL release.

*index\_option* values specify additional options for an index. **USING** is one such option. For details about allowable *index\_option* values, see [Section 12.1.13](#), “**CREATE INDEX Syntax**”.

For more information about indexes, see [Section 7.4.4](#), “**How MySQL Uses Indexes**”.

- In MySQL 5.1, only the **MyISAM**, **InnoDB**, and **MEMORY** storage engines support indexes on columns that can have **NULL** values. In other cases, you must declare indexed columns as **NOT NULL** or an error results.
- For **CHAR**, **VARCHAR**, **BINARY**, and **VARBINARY** columns, indexes can be created that use only the leading part of column values, using *col\_name(length)* syntax to specify an index prefix length. **BLOB** and **TEXT** columns also can be indexed, but a prefix length *must* be given. Prefix lengths are given in characters for nonbinary string types and in bytes for binary string types. That is, index entries consist of the first *length* characters of each column value for **CHAR**, **VARCHAR**, and **TEXT** columns, and the first *length* bytes of each column value for **BINARY**, **VARBINARY**, and **BLOB** columns. Indexing only a prefix of column values like this can make the index file much smaller. See [Section 7.4.2](#), “**Column Indexes**”.

Only the **MyISAM** and **InnoDB** storage engines support indexing on **BLOB** and **TEXT** columns. For example:

```
CREATE TABLE test (blob_col BLOB, INDEX(blob_col(10)));
```

Prefixes can be up to 1000 bytes long (767 bytes for **InnoDB** tables). Note that prefix limits are measured in bytes, whereas the prefix length in **CREATE TABLE** statements is interpreted as number of characters for nonbinary data types (**CHAR**, **VARCHAR**, **TEXT**). Take this into account when specifying a prefix length for a column that uses a multi-byte character set.

- An *index\_col\_name* specification can end with **ASC** or **DESC**. These keywords are allowed for future extensions for specifying ascending or descending index value storage. Currently, they are parsed but ignored; index values are always stored in ascending order.
- When you use **ORDER BY** or **GROUP BY** on a **TEXT** or **BLOB** column in a **SELECT**, the server sorts values using only the initial number of bytes indicated by the *max\_sort\_length* system variable. See [Section 10.4.3](#), “**The BLOB and TEXT Types**”.
- You can create special **FULLTEXT** indexes, which are used for full-text searches. Only the **MyISAM** storage engine supports **FULLTEXT** indexes. They can be created only from **CHAR**, **VARCHAR**, and **TEXT** columns. Indexing always happens over the entire column; column prefix indexing is not supported and any prefix length is ignored if specified. See [Section 11.8](#), “**Full-Text Search Functions**”, for details of operation. A **WITH PARSER** clause can be specified as an *index\_option* value to associate a parser plugin with the index if full-text indexing and searching operations need special handling. This clause is legal only for **FULLTEXT** indexes. See [Section 21.2](#), “**The MySQL Plugin Interface**”, for details on creating plugins.



- You can create `SPATIAL` indexes on spatial data types. Spatial types are supported only for `MyISAM` tables and indexed columns must be declared as `NOT NULL`. See [Section 11.13, “Spatial Extensions”](#).
- `InnoDB` tables support checking of foreign key constraints. See [Section 13.6, “The InnoDB Storage Engine”](#). Note that the `FOREIGN KEY` syntax in `InnoDB` is more restrictive than the syntax presented for the `CREATE TABLE` statement at the beginning of this section: The columns of the referenced table must always be explicitly named. `InnoDB` supports both `ON DELETE` and `ON UPDATE` actions on foreign keys. For the precise syntax, see [Section 13.6.4.4, “FOREIGN KEY Constraints”](#).

For other storage engines, MySQL Server parses and ignores the `FOREIGN KEY` and `REFERENCES` syntax in `CREATE TABLE` statements. The `CHECK` clause is parsed but ignored by all storage engines. See [Section 1.7.5.4, “Foreign Keys”](#).

### Important

For users familiar with the ANSI/ISO SQL Standard, please note that no storage engine, including `InnoDB`, recognizes or enforces the `MATCH` clause used in referential integrity constraint definitions. Use of an explicit `MATCH` clause will not have the specified effect, and also causes `ON DELETE` and `ON UPDATE` clauses to be ignored. For these reasons, specifying `MATCH` should be avoided.

The `MATCH` clause in the SQL standard controls how `NULL` values in a composite (multiple-column) foreign key are handled when comparing to a primary key. `InnoDB` essentially implements the semantics defined by `MATCH SIMPLE`, which allow a foreign key to be all or partially `NULL`. In that case, the (child table) row containing such a foreign key is allowed to be inserted, and does not match any row in the referenced (parent) table. It is possible to implement other semantics using triggers.

Additionally, MySQL and `InnoDB` require that the referenced columns be indexed for performance. However, the system does not enforce a requirement that the referenced columns be `UNIQUE` or be declared `NOT NULL`. The handling of foreign key references to non-unique keys or keys that contain `NULL` values is not well defined for operations such as `UPDATE` or `DELETE CASCADE`. You are advised to use foreign keys that reference only `UNIQUE` and `NOT NULL` keys.

Furthermore, `InnoDB` does not recognize or support “inline `REFERENCES` specifications” (as defined in the SQL standard) where the references are defined as part of the column specification. `InnoDB` accepts `REFERENCES` clauses only when specified as part of a separate `FOREIGN KEY` specification. For other storage engines, MySQL Server parses and ignores foreign key specifications.

### Note

Partitioned tables do not support foreign keys. See [Section 17.5, “Restrictions and Limitations on Partitioning”](#), for more information.

- There is a hard limit of 4096 columns per table, but the effective maximum may be less for a given table and depends on the factors discussed in [Section D.7.2, “The Maximum Number of Columns Per Table”](#).

The `TABLESPACE` and `STORAGE` table options were both introduced in MySQL 5.1.6. In MySQL 5.1, they are employed only with `NDBCLUSTER` tables. The tablespace named `tablespace_name` must already have been created using `CREATE TABLESPACE`. `STORAGE` determines the type of storage used (disk or memory), and can be one of `DISK`, `MEMORY`, or `DEFAULT`.

`TABLESPACE ... STORAGE DISK` assigns a table to a MySQL Cluster Disk Data tablespace. See [MySQL Cluster Disk Data Tables](#), for more information.

### Important

A `STORAGE` clause cannot be used in a `CREATE TABLE` statement without a `TABLESPACE` clause.

The `ENGINE` table option specifies the storage engine for the table.

The `ENGINE` table option takes the storage engine names shown in the following table.

Storage Engine	Description
<code>ARCHIVE</code>	The archiving storage engine. See <a href="#">Section 13.11, “The ARCHIVE Storage Engine”</a> .
<code>CSV</code>	Tables that store rows in comma-separated values format. See <a href="#">Section 13.12, “The CSV Storage Engine”</a> .
<code>EXAMPLE</code>	An example engine. See <a href="#">Section 13.9, “The EXAMPLE Storage Engine”</a> .
<code>FEDERATED</code>	Storage engine that accesses remote tables. See <a href="#">Section 13.10, “The FEDERATED Storage Engine”</a> .
<code>HEAP</code>	This is a synonym for <code>MEMORY</code> .
<code>ISAM (OBSOLETE)</code>	Not available in MySQL 5.1. If you are upgrading to MySQL 5.1 from a previous version, you

	should convert any existing <code>ISAM</code> tables to <code>MyISAM</code> before performing the upgrade.
<code>InnoDB</code>	Transaction-safe tables with row locking and foreign keys. See <a href="#">Section 13.6, “The InnoDB Storage Engine”</a> .
<code>MEMORY</code>	The data for this storage engine is stored only in memory. See <a href="#">Section 13.8, “The MEMORY (HEAP) Storage Engine”</a> .
<code>MERGE</code>	A collection of <code>MyISAM</code> tables used as one table. Also known as <code>MRG_MyISAM</code> . See <a href="#">Section 13.7, “The MERGE Storage Engine”</a> .
<code>MyISAM</code>	The binary portable storage engine that is the default storage engine used by MySQL. See <a href="#">Section 13.4, “The MyISAM Storage Engine”</a> .
<code>NDBCLUSTER</code>	Clustered, fault-tolerant, memory-based tables. Also known as <code>NDB</code> . See <a href="#">MySQL Cluster NDB 6.X/7.X</a> .

If a storage engine is specified that is not available, MySQL uses the default engine instead. Normally, this is `MyISAM`. For example, if a table definition includes the `ENGINE=INNODB` option but the MySQL server does not support `INNODB` tables, the table is created as a `MyISAM` table. This makes it possible to have a replication setup where you have transactional tables on the master but tables created on the slave are non-transactional (to get more speed). In MySQL 5.1, a warning occurs if the storage engine specification is not honored.

Engine substitution can be controlled by the setting of the `NO_ENGINE_SUBSTITUTION` SQL mode, as described in [Section 5.1.7, “Server SQL Modes”](#).

### Note

The older `TYPE` option was synonymous with `ENGINE`. `TYPE` has been deprecated since MySQL 4.0 but is still supported for backward compatibility in MySQL 5.1 (excepting MySQL 5.1.7). Since MySQL 5.1.8, it produces a warning. It is removed as of MySQL 6.0. *You should not use `TYPE` in any new applications, and you should immediately begin conversion of existing applications to use `ENGINE` instead.* (See [Section C.2.30, “Changes in MySQL 5.1.8 \(Not released\)”](#).)

The other table options are used to optimize the behavior of the table. In most cases, you do not have to specify any of them. These options apply to all storage engines unless otherwise indicated. Options that do not apply to a given storage engine may be accepted and remembered as part of the table definition. Such options then apply if you later use `ALTER TABLE` to convert the table to use a different storage engine.

- `AUTO_INCREMENT`

The initial `AUTO_INCREMENT` value for the table. In MySQL 5.1, this works for `MyISAM`, `MEMORY`, and `InnoDB` tables. It also works for `ARCHIVE` tables as of MySQL 5.1.6. To set the first auto-increment value for engines that do not support the `AUTO_INCREMENT` table option, insert a “dummy” row with a value one less than the desired value after creating the table, and then delete the dummy row.

For engines that support the `AUTO_INCREMENT` table option in `CREATE TABLE` statements, you can also use `ALTER TABLE tbl_name AUTO_INCREMENT = N` to reset the `AUTO_INCREMENT` value. The value cannot be set lower than the maximum value currently in the column.

- `AVG_ROW_LENGTH`

An approximation of the average row length for your table. You need to set this only for large tables with variable-size rows.

When you create a `MyISAM` table, MySQL uses the product of the `MAX_ROWS` and `AVG_ROW_LENGTH` options to decide how big the resulting table is. If you don't specify either option, the maximum size for `MyISAM` data and index files is 256TB by default. (If your operating system does not support files that large, table sizes are constrained by the file size limit.) If you want to keep down the pointer sizes to make the index smaller and faster and you don't really need big files, you can decrease the default pointer size by setting the `myisam_data_pointer_size` system variable. (See [Section 5.1.3, “Server System Variables”](#).) If you want all your tables to be able to grow above the default limit and are willing to have your tables slightly slower and larger than necessary, you can increase the default pointer size by setting this variable. Setting the value to 7 allows table sizes up to 65,536TB.

- `[DEFAULT] CHARACTER SET`

Specify a default character set for the table. `CHARSET` is a synonym for `CHARACTER SET`. If the character set name is `DEFAULT`, the database character set is used.

- `CHECKSUM`

Set this to 1 if you want MySQL to maintain a live checksum for all rows (that is, a checksum that MySQL updates automatic-

ally as the table changes). This makes the table a little slower to update, but also makes it easier to find corrupted tables. The `CHECKSUM TABLE` statement reports the checksum. (MyISAM only.)

- `[DEFAULT] COLLATE`

Specify a default collation for the table.

- `COMMENT`

A comment for the table, up to 60 characters long.

- `CONNECTION`

The connection string for a `FEDERATED` table.

### Note

Older versions of MySQL used a `COMMENT` option for the connection string.

- `DATA DIRECTORY, INDEX DIRECTORY`

By using `DATA DIRECTORY='directory'` or `INDEX DIRECTORY='directory'` you can specify where the MyISAM storage engine should put a table's data file and index file. The directory must be the full path name to the directory, not a relative path.

### Important

Beginning with MySQL 5.1.23, table-level `DATA DIRECTORY` and `INDEX DIRECTORY` options are ignored for partitioned tables. (Bug#32091)

These options work only when you are not using the `--skip-symbolic-links` option. Your operating system must also have a working, thread-safe `realpath()` call. See Section 7.6.1.2, “Using Symbolic Links for Tables on Unix”, for more complete information.

If a MyISAM table is created with no `DATA DIRECTORY` option, the `.MYD` file is created in the database directory. By default, if MyISAM finds an existing `.MYD` file in this case, it overwrites it. The same applies to `.MYI` files for tables created with no `INDEX DIRECTORY` option. As of MySQL 5.1.23, to suppress this behavior, start the server with the `--keep-files-on-create` option, in which case MyISAM will not overwrite existing files and returns an error instead.

If a MyISAM table is created with a `DATA DIRECTORY` or `INDEX DIRECTORY` option and an existing `.MYD` or `.MYI` file is found, MyISAM always returns an error. It will not overwrite a file in the specified directory.

### Important

Beginning with MySQL 5.1.24, you cannot use path names that contain the MySQL data directory with `DATA DIRECTORY` or `INDEX DIRECTORY`. This includes partitioned tables and individual table partitions. (See Bug#32167.)

- `DELAY_KEY_WRITE`

Set this to 1 if you want to delay key updates for the table until the table is closed. See the description of the `delay_key_write` system variable in Section 5.1.3, “Server System Variables”. (MyISAM only.)

- `INSERT_METHOD`

If you want to insert data into a `MERGE` table, you must specify with `INSERT_METHOD` the table into which the row should be inserted. `INSERT_METHOD` is an option useful for `MERGE` tables only. Use a value of `FIRST` or `LAST` to have inserts go to the first or last table, or a value of `NO` to prevent inserts. See Section 13.7, “The MERGE Storage Engine”.

- `KEY_BLOCK_SIZE`

This option provides a hint to the storage engine about the size in bytes to use for index key blocks. The engine is allowed to change the value if necessary. A value of 0 indicates that the default value should be used. Individual index definitions can specify a `KEY_BLOCK_SIZE` value of their own to override the table value. `KEY_BLOCK_SIZE` was added in MySQL 5.1.10.

- `MAX_ROWS`

The maximum number of rows you plan to store in the table. This is not a hard limit, but rather a hint to the storage engine that the table must be able to store at least this many rows.

- `MIN_ROWS`

The minimum number of rows you plan to store in the table. The `MEMORY` storage engine uses this option as a hint about memory use.

- `PACK_KEYS`

`PACK_KEYS` takes effect only with `MyISAM` tables. Set this option to 1 if you want to have smaller indexes. This usually makes updates slower and reads faster. Setting the option to 0 disables all packing of keys. Setting it to `DEFAULT` tells the storage engine to pack only long `CHAR`, `VARCHAR`, `BINARY`, or `VARBINARY` columns.

If you do not use `PACK_KEYS`, the default is to pack strings, but not numbers. If you use `PACK_KEYS=1`, numbers are packed as well.

When packing binary number keys, MySQL uses prefix compression:

- Every key needs one extra byte to indicate how many bytes of the previous key are the same for the next key.
- The pointer to the row is stored in high-byte-first order directly after the key, to improve compression.

This means that if you have many equal keys on two consecutive rows, all following “same” keys usually only take two bytes (including the pointer to the row). Compare this to the ordinary case where the following keys takes `storage_size_for_key + pointer_size` (where the pointer size is usually 4). Conversely, you get a significant benefit from prefix compression only if you have many numbers that are the same. If all keys are totally different, you use one byte more per key, if the key is not a key that can have `NULL` values. (In this case, the packed key length is stored in the same byte that is used to mark if a key is `NULL`.)

- `PASSWORD`

This option is unused. If you have a need to scramble your `.frm` files and make them unusable to any other MySQL server, please contact our sales department.

- `RAID_TYPE`

`RAID` support has been removed as of MySQL 5.0. For information on `RAID`, see [CREATE TABLE Syntax](#).

- `ROW_FORMAT`

Defines how the rows should be stored. For `MyISAM` tables, the option value can be `FIXED` or `DYNAMIC` for static or variable-length row format. `myisampack` sets the type to `COMPRESSED`. See [Section 13.4.3, “MyISAM Table Storage Formats”](#).

For `InnoDB` tables, rows are stored in compact format (`ROW_FORMAT=COMPACT`) by default. The non-compact format used in older versions of MySQL can still be requested by specifying `ROW_FORMAT=REDUNDANT`.

### Note

When executing a `CREATE TABLE` statement, if you specify a row format which is not supported by the storage engine that is used for the table, the table is created using that storage engine’s default row format. The information reported in this column in response to `SHOW TABLE STATUS` is the actual row format used. This may differ from the value in the `Create_options` column because the original `CREATE TABLE` definition is retained during creation.

- `UNION`

`UNION` is used when you want to access a collection of identical `MyISAM` tables as one. This works only with `MERGE` tables. See [Section 13.7, “The MERGE Storage Engine”](#).

You must have `SELECT`, `UPDATE`, and `DELETE` privileges for the tables you map to a `MERGE` table.

### Note

Formerly, all tables used had to be in the same database as the `MERGE` table itself. This restriction no longer applies.

`partition_options` can be used to control partitioning of the table created with `CREATE TABLE`.

### Important

Not all options shown in the syntax for `partition_options` at the beginning of this section are available for all partitioning types. Please see the listings for the following individual types for information specific to each type, and see [Chapter 17, Partitioning](#), for more complete information about the workings of and uses for partitioning in MySQL, as well as additional examples of table creation and other statements relating to MySQL partitioning.

If used, a *partition\_options* clause begins with **PARTITION BY**. This clause contains the function that is used to determine the partition; the function returns an integer value ranging from 1 to *num*, where *num* is the number of partitions. (The maximum number of user-defined partitions which a table may contain is 1024; the number of subpartitions — discussed later in this section — is included in this maximum.) The choices that are available for this function in MySQL 5.1 are shown in the following list:

- **HASH(*expr*)**: Hashes one or more columns to create a key for placing and locating rows. *expr* is an expression using one or more table columns. This can be any legal MySQL expression (including MySQL functions) that yields a single integer value. For example, these are all valid **CREATE TABLE** statements using **PARTITION BY HASH**:

```
CREATE TABLE t1 (col1 INT, col2 CHAR(5))
PARTITION BY HASH(col1);

CREATE TABLE t1 (col1 INT, col2 CHAR(5))
PARTITION BY HASH( ORD(col2) );

CREATE TABLE t1 (col1 INT, col2 CHAR(5), col3 DATETIME)
PARTITION BY HASH ( YEAR(col3) );
```

You may not use either **VALUES LESS THAN** or **VALUES IN** clauses with **PARTITION BY HASH**.

**PARTITION BY HASH** uses the remainder of *expr* divided by the number of partitions (that is, the modulus). For examples and additional information, see [Section 17.2.3, “HASH Partitioning”](#).

The **LINEAR** keyword entails a somewhat different algorithm. In this case, the number of the partition in which a row is stored is calculated as the result of one or more logical **AND** operations. For discussion and examples of linear hashing, see [Section 17.2.3.1, “LINEAR HASH Partitioning”](#).

- **KEY(*column\_list*)**: This is similar to **HASH**, except that MySQL supplies the hashing function so as to guarantee an even data distribution. The *column\_list* argument is simply a list of table columns. This example shows a simple table partitioned by key, with 4 partitions:

```
CREATE TABLE tk (col1 INT, col2 CHAR(5), col3 DATE)
PARTITION BY KEY(col3)
PARTITIONS 4;
```

For tables that are partitioned by key, you can employ linear partitioning by using the **LINEAR** keyword. This has the same effect as with tables that are partitioned by **HASH**. That is, the partition number is found using the **&** operator rather than the modulus (see [Section 17.2.3.1, “LINEAR HASH Partitioning”](#), and [Section 17.2.4, “KEY Partitioning”](#), for details). This example uses linear partitioning by key to distribute data between 5 partitions:

```
CREATE TABLE tk (col1 INT, col2 CHAR(5), col3 DATE)
PARTITION BY LINEAR KEY(col3)
PARTITIONS 5;
```

You may not use either **VALUES LESS THAN** or **VALUES IN** clauses with **PARTITION BY KEY**.

- **RANGE**: In this case, *expr* shows a range of values using a set of **VALUES LESS THAN** operators. When using range partitioning, you must define at least one partition using **VALUES LESS THAN**. You cannot use **VALUES IN** with range partitioning.

**VALUES LESS THAN** can be used with either a literal value or an expression that evaluates to a single value.

Suppose that you have a table that you wish to partition on a column containing year values, according to the following scheme.

Partition Number:	Years Range:
0	1990 and earlier
1	1991 – 1994
2	1995 – 1998
3	1999 – 2002
4	2003 – 2005
5	2006 and later

A table implementing such a partitioning scheme can be realized by the **CREATE TABLE** statement shown here:

```
CREATE TABLE t1 (
  year_col INT,
  some_data INT
)
PARTITION BY RANGE (year_col) (
```

```

PARTITION p0 VALUES LESS THAN (1991),
PARTITION p1 VALUES LESS THAN (1995),
PARTITION p2 VALUES LESS THAN (1999),
PARTITION p3 VALUES LESS THAN (2002),
PARTITION p4 VALUES LESS THAN (2006),
PARTITION p5 VALUES LESS THAN MAXVALUE
);

```

`PARTITION ... VALUES LESS THAN ...` statements work in a consecutive fashion. `VALUES LESS THAN MAXVALUE` works to specify “leftover” values that are greater than the maximum value otherwise specified.

Note that `VALUES LESS THAN` clauses work sequentially in a manner similar to that of the `case` portions of a `switch ... case` block (as found in many programming languages such as C, Java, and PHP). That is, the clauses must be arranged in such a way that the upper limit specified in each successive `VALUES LESS THAN` is greater than that of the previous one, with the one referencing `MAXVALUE` coming last of all in the list.

- `LIST(expr)`: This is useful when assigning partitions based on a table column with a restricted set of possible values, such as a state or country code. In such a case, all rows pertaining to a certain state or country can be assigned to a single partition, or a partition can be reserved for a certain set of states or countries. It is similar to `RANGE`, except that only `VALUES IN` may be used to specify allowable values for each partition.

`VALUES IN` is used with a list of values to be matched. For instance, you could create a partitioning scheme such as the following:

```

CREATE TABLE client_firms (
  id INT,
  name VARCHAR(35)
)
PARTITION BY LIST (id) (
  PARTITION r0 VALUES IN (1, 5, 9, 13, 17, 21),
  PARTITION r1 VALUES IN (2, 6, 10, 14, 18, 22),
  PARTITION r2 VALUES IN (3, 7, 11, 15, 19, 23),
  PARTITION r3 VALUES IN (4, 8, 12, 16, 20, 24)
);

```

When using list partitioning, you must define at least one partition using `VALUES IN`. You cannot use `VALUES LESS THAN` with `PARTITION BY LIST`.

### Note

Currently, the value list used with `VALUES IN` must consist of integer values only.

- The number of partitions may optionally be specified with a `PARTITIONS num` clause, where `num` is the number of partitions. If both this clause *and* any `PARTITION` clauses are used, `num` must be equal to the total number of any partitions that are declared using `PARTITION` clauses.

### Note

Whether or not you use a `PARTITIONS` clause in creating a table that is partitioned by `RANGE` or `LIST`, you must still include at least one `PARTITION VALUES` clause in the table definition (see below).

- A partition may optionally be divided into a number of subpartitions. This can be indicated by using the optional `SUBPARTITION BY` clause. Subpartitioning may be done by `HASH` or `KEY`. Either of these may be `LINEAR`. These work in the same way as previously described for the equivalent partitioning types. (It is not possible to subpartition by `LIST` or `RANGE`.)

The number of subpartitions can be indicated using the `SUBPARTITIONS` keyword followed by an integer value.

- MySQL 5.1.12 introduces rigorous checking of the value used in a `PARTITIONS` or `SUBPARTITIONS` clause. Beginning with this version, this value must adhere to the following rules:
  - The value must be a positive, nonzero integer.
  - No leading zeroes are permitted.
  - The value must be an integer literal, and cannot not be an expression. For example, `PARTITIONS 0.2E+01` is not allowed, even though `0.2E+01` evaluates to 2. ([Bug#15890](#))

### Note

The expression (`expr`) used in a `PARTITION BY` clause cannot refer to any columns not in the table being created; beginning with MySQL 5.1.23, such references are specifically disallowed and cause the statement to fail with an error. ([Bug#29444](#))



Each partition may be individually defined using a *partition\_definition* clause. The individual parts making up this clause are as follows:

- **PARTITION** *partition\_name*: This specifies a logical name for the partition.
- A **VALUES** clause: For range partitioning, each partition must include a **VALUES LESS THAN** clause; for list partitioning, you must specify a **VALUES IN** clause for each partition. This is used to determine which rows are to be stored in this partition. See the discussions of partitioning types in [Chapter 17, Partitioning](#), for syntax examples.

- An optional **COMMENT** clause may be used to specify a string that describes the partition. Example:

```
COMMENT = 'Data for the years previous to 1999'
```

- **DATA DIRECTORY** and **INDEX DIRECTORY** may be used to indicate the directory where, respectively, the data and indexes for this partition are to be stored. Both the *data\_dir* and the *index\_dir* must be absolute system path names. Example:

```
CREATE TABLE th (id INT, name VARCHAR(30), adate DATE)
PARTITION BY LIST(YEAR(adata))
(
  PARTITION p1999 VALUES IN (1995, 1999, 2003)
  DATA DIRECTORY = '/var/appdata/95/data'
  INDEX DIRECTORY = '/var/appdata/95/idx',
  PARTITION p2000 VALUES IN (1996, 2000, 2004)
  DATA DIRECTORY = '/var/appdata/96/data'
  INDEX DIRECTORY = '/var/appdata/96/idx',
  PARTITION p2001 VALUES IN (1997, 2001, 2005)
  DATA DIRECTORY = '/var/appdata/97/data'
  INDEX DIRECTORY = '/var/appdata/97/idx',
  PARTITION p2000 VALUES IN (1998, 2002, 2006)
  DATA DIRECTORY = '/var/appdata/98/data'
  INDEX DIRECTORY = '/var/appdata/98/idx'
);
```

**DATA DIRECTORY** and **INDEX DIRECTORY** behave in the same way as in the **CREATE TABLE** statement's *table\_option* clause as used for **MyISAM** tables.

One data directory and one index directory may be specified per partition. If left unspecified, the data and indexes are stored by default in the table's database directory.

On Windows, the **DATA DIRECTORY** and **INDEX DIRECTORY** options are not supported for individual partitions or subpartitions. Beginning with MySQL 5.1.24, these options are ignored on Windows, except that a warning is generated. ([Bug#30459](#))

### Note

Prior to MySQL 5.1.18, **DATA DIRECTORY** and **INDEX DIRECTORY** were allowed even if the **NO\_DIR\_IN\_CREATE** server SQL mode was in effect at the time that a partitioned table was created. Beginning with MySQL 5.1.18, these options are ignored for creating partitioned tables if **NO\_DIR\_IN\_CREATE** is in effect. ([Bug#24633](#))

- **MAX\_ROWS** and **MIN\_ROWS** may be used to specify, respectively, the maximum and minimum number of rows to be stored in the partition. The values for *max\_number\_of\_rows* and *min\_number\_of\_rows* must be positive integers. As with the table-level options with the same names, these act only as “suggestions” to the server and are not hard limits.
- The optional **TABLESPACE** clause may be used to designate a tablespace for the partition. Used for MySQL Cluster only.
- The partitioning handler accepts a [**STORAGE**] **ENGINE** option for both **PARTITION** and **SUBPARTITION**. Currently, the only way in which this can be used is to set all partitions or all subpartitions to the same storage engine, and an attempt to set different storage engines for partitions or subpartitions in the same table will give rise to the error **ERROR 1469 (HY000): THE MIX OF HANDLERS IN THE PARTITIONS IS NOT ALLOWED IN THIS VERSION OF MYSQL**. We expect to lift this restriction on partitioning in a future MySQL release.
- The **NODEGROUP** option can be used to make this partition act as part of the node group identified by *node\_group\_id*. This option is applicable only to MySQL Cluster.
- The partition definition may optionally contain one or more *subpartition\_definition* clauses. Each of these consists at a minimum of the **SUBPARTITION** *name*, where *name* is an identifier for the subpartition. Except for the replacement of the **PARTITION** keyword with **SUBPARTITION**, the syntax for a subpartition definition is identical to that for a partition definition.

Subpartitioning must be done by **HASH** or **KEY**, and can be done only on **RANGE** or **LIST** partitions. See [Section 17.2.5, “Subpartitioning”](#).

Partitions can be modified, merged, added to tables, and dropped from tables. For basic information about the MySQL statements to accomplish these tasks, see [Section 12.1.7, “ALTER TABLE Syntax”](#). For more detailed descriptions and examples, see [Section 17.3, “Partition Management”](#).

### Important

The original `CREATE TABLE` statement, including all specifications and table options are stored by MySQL when the table is created. The information is retained so that if you change storage engines, collations or other settings using an `ALTER TABLE` statement, the original table options specified are retained. This allows you to change between `InnoDB` and `MyISAM` table types even though the row formats supported by the two engines are different.

Because the text of the original statement is retained, but due to the way that certain values and options may be silently reconfigured (such as the `ROW_FORMAT`), the active table definition (accessible through `DESCRIBE` or with `SHOW TABLE STATUS`) and the table creation string (accessible through `SHOW CREATE TABLE`) will report different values.

You can create one table from another by adding a `SELECT` statement at the end of the `CREATE TABLE` statement:

```
CREATE TABLE new_tbl SELECT * FROM orig_tbl;
```

MySQL creates new columns for all elements in the `SELECT`. For example:

```
mysql> CREATE TABLE test (a INT NOT NULL AUTO_INCREMENT,
->     PRIMARY KEY (a), KEY(b))
->     ENGINE=MyISAM SELECT b,c FROM test2;
```

This creates a `MyISAM` table with three columns, `a`, `b`, and `c`. Notice that the columns from the `SELECT` statement are appended to the right side of the table, not overlapped onto it. Take the following example:

```
mysql> SELECT * FROM foo;
+----+
| n  |
+----+
| 1  |
+----+

mysql> CREATE TABLE bar (m INT) SELECT n FROM foo;
Query OK, 1 row affected (0.02 sec)
Records: 1 Duplicates: 0 Warnings: 0

mysql> SELECT * FROM bar;
+-----+-----+
| m    | n    |
+-----+-----+
| NULL | 1    |
+-----+-----+
1 row in set (0.00 sec)
```

For each row in table `foo`, a row is inserted in `bar` with the values from `foo` and default values for the new columns.

In a table resulting from `CREATE TABLE ... SELECT`, columns named only in the `CREATE TABLE` part come first. Columns named in both parts or only in the `SELECT` part come after that. The data type of `SELECT` columns can be overridden by also specifying the column in the `CREATE TABLE` part.

If any errors occur while copying the data to the table, it is automatically dropped and not created.

`CREATE TABLE ... SELECT` does not automatically create any indexes for you. This is done intentionally to make the statement as flexible as possible. If you want to have indexes in the created table, you should specify these before the `SELECT` statement:

```
mysql> CREATE TABLE bar (UNIQUE (n)) SELECT n FROM foo;
```

Some conversion of data types might occur. For example, the `AUTO_INCREMENT` attribute is not preserved, and `VARCHAR` columns can become `CHAR` columns. Retained attributes are `NULL` (or `NOT NULL`) and, for those columns that have them, `CHARACTER SET`, `COLLATION`, `COMMENT`, and the `DEFAULT` clause.

When creating a table with `CREATE ... SELECT`, make sure to alias any function calls or expressions in the query. If you do not, the `CREATE` statement might fail or result in undesirable column names.

```
CREATE TABLE artists_and_works
SELECT artist.name, COUNT(work.artist_id) AS number_of_works
FROM artist LEFT JOIN work ON artist.id = work.artist_id
GROUP BY artist.id;
```



You can also explicitly specify the data type for a generated column:

```
CREATE TABLE foo (a TINYINT NOT NULL) SELECT b+1 AS a FROM bar;
```

For `CREATE TABLE ... SELECT`, if `IF NOT EXISTS` is given and the table already exists, MySQL handles the statement as follows:

- The table definition given in the `CREATE TABLE` part is ignored. No error occurs, even if the definition does not match that of the existing table.
- If there is a mismatch between the number of columns in the table and the number of columns produced by the `SELECT` part, the selected values are assigned to the rightmost columns. For example, if the table contains  $n$  columns and the `SELECT` produces  $m$  columns, where  $m < n$ , the selected values are assigned to the  $m$  rightmost columns in the table. Each of the initial  $n - m$  columns is assigned its default value, either that specified explicitly in the column definition or the implicit column data type default if the definition contains no default.
- If strict SQL mode is enabled and any of these initial columns do not have an explicit default value, the statement fails with an error.

The following example illustrates `IF NOT EXISTS` handling:

```
mysql> CREATE TABLE t1 (i1 INT DEFAULT 0, i2 INT, i3 INT, i4 INT);
Query OK, 0 rows affected (0.05 sec)

mysql> CREATE TABLE IF NOT EXISTS t1 (c1 CHAR(10)) SELECT 1, 2;
Query OK, 1 row affected, 1 warning (0.01 sec)
Records: 1 Duplicates: 0 Warnings: 0

mysql> SELECT * FROM t1;
+-----+-----+-----+-----+
| i1   | i2   | i3   | i4   |
+-----+-----+-----+-----+
| 0    | NULL | 1    | 2    |
+-----+-----+-----+-----+
1 row in set (0.00 sec)
```

Use `LIKE` to create an empty table based on the definition of another table, including any column attributes and indexes defined in the original table:

```
CREATE TABLE new_tbl LIKE orig_tbl;
```

The copy is created using the same version of the table storage format as the original table. The `SELECT` privilege is required on the original table.

`LIKE` works only for base tables, not for views.

`CREATE TABLE ... LIKE` does not preserve any `DATA DIRECTORY` or `INDEX DIRECTORY` table options that were specified for the original table, or any foreign key definitions.

You can precede the `SELECT` by `IGNORE` or `REPLACE` to indicate how to handle rows that duplicate unique key values. With `IGNORE`, new rows that duplicate an existing row on a unique key value are discarded. With `REPLACE`, new rows replace rows that have the same unique key value. If neither `IGNORE` nor `REPLACE` is specified, duplicate unique key values result in an error.

To ensure that the binary log can be used to re-create the original tables, MySQL does not allow concurrent inserts during `CREATE TABLE ... SELECT`.

### 12.1.17.1. Silent Column Specification Changes

In some cases, MySQL silently changes column specifications from those given in a `CREATE TABLE` or `ALTER TABLE` statement. These might be changes to a data type, to attributes associated with a data type, or to an index specification.

- `TIMESTAMP` display sizes are discarded.

Also note that `TIMESTAMP` columns are `NOT NULL` by default.

- Columns that are part of a `PRIMARY KEY` are made `NOT NULL` even if not declared that way.
- Trailing spaces are automatically deleted from `ENUM` and `SET` member values when the table is created.
- MySQL maps certain data types used by other SQL database vendors to MySQL types. See [Section 10.7, “Using Data Types](#)

from Other Database Engines”.

- If you include a `USING` clause to specify an index type that is not legal for a given storage engine, but there is another index type available that the engine can use without affecting query results, the engine uses the available type.
- If strict SQL mode is not enabled, a `VARCHAR` column with a length specification greater than 65535 is converted to `TEXT`, and a `VARBINARY` column with a length specification greater than 65535 is converted to `BLOB`. Otherwise, an error occurs in either of these cases.
- Specifying the `CHARACTER SET binary` attribute for a character data type causes the column to be created as the corresponding binary data type: `CHAR` becomes `BINARY`, `VARCHAR` becomes `VARBINARY`, and `TEXT` becomes `BLOB`. For the `ENUM` and `SET` data types, this does not occur; they are created as declared. Suppose that you specify a table using this definition:

```
CREATE TABLE t
(
  c1 VARCHAR(10) CHARACTER SET binary,
  c2 TEXT CHARACTER SET binary,
  c3 ENUM('a','b','c') CHARACTER SET binary
);
```

The resulting table has this definition:

```
CREATE TABLE t
(
  c1 VARBINARY(10),
  c2 BLOB,
  c3 ENUM('a','b','c') CHARACTER SET binary
);
```

To see whether MySQL used a data type other than the one you specified, issue a `DESCRIBE` or `SHOW CREATE TABLE` statement after creating or altering the table.

Certain other data type changes can occur if you compress a table using `myisampack`. See [Section 13.4.3.3, “Compressed Table Characteristics”](#).

## 12.1.18. CREATE TABLESPACE Syntax

```
CREATE TABLESPACE tablespace_name
ADD DATAFILE 'file_name'
USE LOGFILE GROUP logfile_group
[EXTENT_SIZE [=] extent_size]
[INITIAL_SIZE [=] initial_size]
[AUTOEXTEND_SIZE [=] autoextend_size]
[MAX_SIZE [=] max_size]
[NODEGROUP [=] nodegroup_id]
[WAIT]
[COMMENT [=] comment_text]
ENGINE [=] engine_name
```

This statement is used to create a tablespace, which can contain one or more data files, providing storage space for tables. One data file is created and added to the tablespace using this statement. Additional data files may be added to the tablespace by using the `ALTER TABLESPACE` statement (see [Section 12.1.8, “ALTER TABLESPACE Syntax”](#)). For rules covering the naming of tablespaces, see [Section 8.2, “Schema Object Names”](#).

### Note

All MySQL Cluster Disk Data objects share the same namespace. This means that *each Disk Data object* must be uniquely named (and not merely each Disk Data object of a given type). For example, you cannot have a tablespace and a log file group with the same name, or a tablespace and a data file with the same name.

Prior to MySQL Cluster NDB 6.2.17, 6.3.23, and 6.4.3, path and file names for data files could not be longer than 128 characters. ([Bug#31770](#))

A log file group of one or more `UNDO` log files must be assigned to the tablespace to be created with the `USE LOGFILE GROUP` clause. `logfile_group` must be an existing log file group created with `CREATE LOGFILE GROUP` (see [Section 12.1.14, “CREATE LOGFILE GROUP Syntax”](#)). Multiple tablespaces may use the same log file group for `UNDO` logging.

The `EXTENT_SIZE` sets the size, in bytes, of the extents used by any files belonging to the tablespace. The default value is 1M. The minimum size is 32K, and theoretical maximum is 2G, although the practical maximum size depends on a number of factors. In most cases, changing the extent size does not have any measurable effect on performance, and the default value is recommended for all but the most unusual situations.

An *extent* is a unit of disk space allocation. One extent is filled with as much data as that extent can contain before another extent is used. In theory, up to 65,535 (64K) extents may be used per data file; however, the recommended maximum is 32,768 (32K). The recommended maximum size for a single data file is 32G — that is, 32K extents × 1 MB per extent. In addition, once an extent is allocated to a given partition, it cannot be used to store data from a different partition; an extent cannot store data from more than one partition. This means, for example that a tablespace having a single datafile whose `INITIAL_SIZE` is 256 MB and whose `EXTENT_SIZE` is 128M has just two extents, and so can be used to store data from at most two different disk data table partitions.

You can see how many extents remain free in a given data file by querying the `INFORMATION_SCHEMA.FILES` table, and so derive an estimate for how much space remains free in the file. For further discussion and examples, see [Section 19.21, “The INFORMATION\\_SCHEMA FILES Table”](#).

The `INITIAL_SIZE` parameter sets the data file's total size in bytes. Once the file has been created, its size cannot be changed; however, you can add more data files to the tablespace using `ALTER TABLESPACE . . . ADD DATAFILE`. See [Section 12.1.8, “ALTER TABLESPACE Syntax”](#).

`INITIAL_SIZE` is optional; its default value is 128M.

On 32-bit systems, the maximum supported value for `INITIAL_SIZE` is 4G. ([Bug#29186](#))

When setting `EXTENT_SIZE` or `INITIAL_SIZE` (either or both), you may optionally follow the number with a one-letter abbreviation for an order of magnitude, similar to those used in `my.cnf`. Generally, this is one of the letters M (for megabytes) or G (for gigabytes).

`AUTOEXTEND_SIZE`, `MAX_SIZE`, `NODEGROUP`, `WAIT`, and `COMMENT` are parsed but ignored, and so have no effect in MySQL 5.1. These options are intended for future expansion.

The `ENGINE` parameter determines the storage engine which uses this tablespace, with `engine_name` being the name of the storage engine. In MySQL 5.1, `engine_name` must be one of the values `NDB` or `NDBCLUSTER`.

When `CREATE TABLESPACE` is used with `ENGINE = NDB`, a tablespace and associated data file are created on each Cluster data node. You can verify that the data files were created and obtain information about them by querying the `INFORMATION_SCHEMA.FILES` table. For example:

```
mysql> SELECT LOGFILE_GROUP_NAME, FILE_NAME, EXTRA
-> FROM INFORMATION_SCHEMA.FILES
-> WHERE TABLESPACE_NAME = 'newts' AND FILE_TYPE = 'DATAFILE';
+-----+-----+-----+
| LOGFILE_GROUP_NAME | FILE_NAME | EXTRA |
+-----+-----+-----+
| lg_3               | newdata.dat | CLUSTER_NODE=3 |
| lg_3               | newdata.dat | CLUSTER_NODE=4 |
+-----+-----+-----+
2 rows in set (0.01 sec)
```

(See [Section 19.21, “The INFORMATION\\_SCHEMA FILES Table”](#).)

`CREATE TABLESPACE` was added in MySQL 5.1.6. In MySQL 5.1, it is useful only with Disk Data storage for MySQL Cluster. See [MySQL Cluster Disk Data Tables](#).

## 12.1.19. CREATE TRIGGER Syntax

```
CREATE
[DEFINER = { user | CURRENT_USER }]
TRIGGER trigger_name trigger_time trigger_event
ON tbl_name FOR EACH ROW trigger_stmt
```

This statement creates a new trigger. A trigger is a named database object that is associated with a table, and that activates when a particular event occurs for the table. The trigger becomes associated with the table named `tbl_name`, which must refer to a permanent table. You cannot associate a trigger with a `TEMPORARY` table or a view.

### MySQL Enterprise

For expert advice on creating triggers subscribe to the MySQL Enterprise Monitor. For more information, see <http://www.mysql.com/products/enterprise/advisors.html>.

`CREATE TRIGGER` requires the `TRIGGER` privilege for the table associated with the trigger. (Before MySQL 5.1.6, this statement requires the `SUPER` privilege.)

The `DEFINER` clause determines the security context to be used when checking access privileges at trigger activation time.

`trigger_time` is the trigger action time. It can be `BEFORE` or `AFTER` to indicate that the trigger activates before or after each row to be modified.

`trigger_event` indicates the kind of statement that activates the trigger. The `trigger_event` can be one of the following:

- **INSERT:** The trigger is activated whenever a new row is inserted into the table; for example, through **INSERT**, **LOAD DATA**, and **REPLACE** statements.
- **UPDATE:** The trigger is activated whenever a row is modified; for example, through **UPDATE** statements.
- **DELETE:** The trigger is activated whenever a row is deleted from the table; for example, through **DELETE** and **REPLACE** statements. However, **DROP TABLE** and **TRUNCATE** statements on the table do *not* activate this trigger, because they do not use **DELETE**. Dropping a partition does not activate **DELETE** triggers, either. See [Section 12.2.10, “TRUNCATE Syntax”](#).

It is important to understand that the `trigger_event` does not represent a literal type of SQL statement that activates the trigger so much as it represents a type of table operation. For example, an **INSERT** trigger is activated by not only **INSERT** statements but also **LOAD DATA** statements because both statements insert rows into a table.

A potentially confusing example of this is the **INSERT INTO ... ON DUPLICATE KEY UPDATE ...** syntax: a **BEFORE INSERT** trigger will activate for every row, followed by either an **AFTER INSERT** trigger or both the **BEFORE UPDATE** and **AFTER UPDATE** triggers, depending on whether there was a duplicate key for the row.

There cannot be two triggers for a given table that have the same trigger action time and event. For example, you cannot have two **BEFORE UPDATE** triggers for a table. But you can have a **BEFORE UPDATE** and a **BEFORE INSERT** trigger, or a **BEFORE UPDATE** and an **AFTER UPDATE** trigger.

`trigger_stmt` is the statement to execute when the trigger activates. If you want to execute multiple statements, use the **BEGIN ... END** compound statement construct. This also enables you to use the same statements that are allowable within stored routines. See [Section 12.8.1, “BEGIN ... END Compound Statement Syntax”](#). Some statements are not allowed in triggers; see [Section D.1, “Restrictions on Stored Routines, Triggers, and Events”](#).

MySQL stores the `sql_mode` system variable setting that is in effect at the time a trigger is created, and always executes the trigger with this setting in force, *regardless of the current server SQL mode*.

### Note

Currently, triggers are not activated by cascaded foreign key actions. This limitation will be lifted as soon as possible.

In MySQL 5.1, you can write triggers containing direct references to tables by name, such as the trigger named `testref` shown in this example:

```
CREATE TABLE test1(a1 INT);
CREATE TABLE test2(a2 INT);
CREATE TABLE test3(a3 INT NOT NULL AUTO_INCREMENT PRIMARY KEY);
CREATE TABLE test4(
  a4 INT NOT NULL AUTO_INCREMENT PRIMARY KEY,
  b4 INT DEFAULT 0
);

delimiter |

CREATE TRIGGER testref BEFORE INSERT ON test1
FOR EACH ROW BEGIN
  INSERT INTO test2 SET a2 = NEW.a1;
  DELETE FROM test3 WHERE a3 = NEW.a1;
  UPDATE test4 SET b4 = b4 + 1 WHERE a4 = NEW.a1;
END;
|

delimiter ;

INSERT INTO test3 (a3) VALUES
  (NULL), (NULL), (NULL), (NULL), (NULL),
  (NULL), (NULL), (NULL), (NULL), (NULL);

INSERT INTO test4 (a4) VALUES
  (0), (0), (0), (0), (0), (0), (0), (0), (0);
```

Suppose that you insert the following values into table `test1` as shown here:

```
mysql> INSERT INTO test1 VALUES
-> (1), (3), (1), (7), (1), (8), (4), (4);
Query OK, 8 rows affected (0.01 sec)
Records: 8 Duplicates: 0 Warnings: 0
```

As a result, the data in the four tables will be as follows:

```
mysql> SELECT * FROM test1;
+-----+
```

```

+----+
| a1 |
+----+
| 1  |
| 3  |
| 1  |
| 7  |
| 1  |
| 8  |
| 4  |
| 4  |
+----+
8 rows in set (0.00 sec)

mysql> SELECT * FROM test2;
+----+
| a2 |
+----+
| 1  |
| 3  |
| 1  |
| 7  |
| 1  |
| 8  |
| 4  |
| 4  |
+----+
8 rows in set (0.00 sec)

mysql> SELECT * FROM test3;
+----+
| a3 |
+----+
| 2  |
| 5  |
| 6  |
| 9  |
| 10 |
+----+
5 rows in set (0.00 sec)

mysql> SELECT * FROM test4;
+----+
| a4 | b4 |
+----+
| 1  | 3  |
| 2  | 0  |
| 3  | 1  |
| 4  | 2  |
| 5  | 0  |
| 6  | 0  |
| 7  | 1  |
| 8  | 1  |
| 9  | 0  |
| 10 | 0  |
+----+
10 rows in set (0.00 sec)

```

You can refer to columns in the subject table (the table associated with the trigger) by using the aliases `OLD` and `NEW`. `OLD.col_name` refers to a column of an existing row before it is updated or deleted. `NEW.col_name` refers to the column of a new row to be inserted or an existing row after it is updated.

The `DEFINER` clause specifies the MySQL account to be used when checking access privileges at trigger activation time. If a `user` value is given, it should be a MySQL account in '`user_name`'@'`host_name`' format (the same format used in the `GRANT` statement). The `user_name` and `host_name` values both are required. The definer can also be given as `CURRENT_USER` or `CURRENT_USER()`. The default `DEFINER` value is the user who executes the `CREATE TRIGGER` statement. (This is the same as `DEFINER = CURRENT_USER`.)

If you specify the `DEFINER` clause, these rules determine the legal `DEFINER` user values:

- If you do not have the `SUPER` privilege, the only legal `user` value is your own account, either specified literally or by using `CURRENT_USER`. You cannot set the definer to some other account.
- If you have the `SUPER` privilege, you can specify any syntactically legal account name. If the account does not actually exist, a warning is generated.
- Although it is possible to create triggers with a non-existent `DEFINER` value, it is not a good idea for such triggers to be activated until the definer actually does exist. Otherwise, the behavior with respect to privilege checking is undefined.

Note: Prior to MySQL 5.1.6, MySQL requires the `SUPER` privilege for the use of `CREATE TRIGGER`, so only the second of the preceding rules applies. As of 5.1.6, `CREATE TRIGGER` requires the `TRIGGER` privilege and `SUPER` is required only to be able to set `DEFINER` to a value other than your own account.

MySQL takes the `DEFINER` user into account when checking trigger privileges, as follows:

- At `CREATE TRIGGER` time, the user who issues the statement must have the `TRIGGER` privilege. (*SUPER* prior to MySQL 5.1.6.)
- At trigger activation time, privileges are checked against the `DEFINER` user. This user must have these privileges:
  - The `TRIGGER` privilege. (*SUPER* prior to MySQL 5.1.6.)
  - The `SELECT` privilege for the subject table if references to table columns occur via `OLD.col_name` or `NEW.col_name` in the trigger definition.
  - The `UPDATE` privilege for the subject table if table columns are targets of `SET NEW.col_name = value` assignments in the trigger definition.
  - Whatever other privileges normally are required for the statements executed by the trigger.

Within a trigger, the `CURRENT_USER()` function returns the account used to check privileges at trigger activation time. This is the `DEFINER` user, not the user whose actions caused the trigger to be activated. For information about user auditing within triggers, see [Section 5.5.9, “Auditing MySQL Account Activity”](#).

If you use `LOCK TABLES` to lock a table that has triggers, the tables used within the trigger are also locked, as described in [Section 12.4.5.2, “LOCK TABLES and Triggers”](#).

## 12.1.20. CREATE VIEW Syntax

```
CREATE
[OR REPLACE]
[ALGORITHM = {UNDEFINED | MERGE | TEMPTABLE}]
[DEFINER = { user | CURRENT_USER }]
[SQL SECURITY { DEFINER | INVOKER }]
VIEW view_name [(column_list)]
AS select_statement
[WITH [CASCADED | LOCAL] CHECK OPTION]
```

The `CREATE VIEW` statement creates a new view, or replaces an existing one if the `OR REPLACE` clause is given. If the view does not exist, `CREATE OR REPLACE VIEW` is the same as `CREATE VIEW`. If the view does exist, `CREATE OR REPLACE VIEW` is the same as `ALTER VIEW`.

The `select_statement` is a `SELECT` statement that provides the definition of the view. (When you select from the view, you select in effect using the `SELECT` statement.) `select_statement` can select from base tables or other views.

The view definition is “frozen” at creation time, so changes to the underlying tables afterward do not affect the view definition. For example, if a view is defined as `SELECT *` on a table, new columns added to the table later do not become part of the view.

The `ALGORITHM` clause affects how MySQL processes the view. The `DEFINER` and `SQL SECURITY` clauses specify the security context to be used when checking access privileges at view invocation time. The `WITH CHECK OPTION` clause can be given to constrain inserts or updates to rows in tables referenced by the view. These clauses are described later in this section.

The `CREATE VIEW` statement requires the `CREATE VIEW` privilege for the view, and some privilege for each column selected by the `SELECT` statement. For columns used elsewhere in the `SELECT` statement you must have the `SELECT` privilege. If the `OR REPLACE` clause is present, you must also have the `DROP` privilege for the view.

A view belongs to a database. By default, a new view is created in the default database. To create the view explicitly in a given database, specify the name as `db_name.view_name` when you create it.

```
mysql> CREATE VIEW test.v AS SELECT * FROM t;
```

Base tables and views share the same namespace within a database, so a database cannot contain a base table and a view that have the same name.

Views must have unique column names with no duplicates, just like base tables. By default, the names of the columns retrieved by the `SELECT` statement are used for the view column names. To define explicit names for the view columns, the optional `column_list` clause can be given as a list of comma-separated identifiers. The number of names in `column_list` must be the same as the number of columns retrieved by the `SELECT` statement.

### Note

Prior to MySQL 5.1.29, when you modify an existing view, the current view definition is backed up and saved. It is stored in that table's database directory, in a subdirectory named `arc`. The backup file for a view `v` is named `v.frm-00001`. If you alter the view again, the next backup is named `v.frm-00002`. The three latest view backup definitions are stored.

Backed up view definitions are not preserved by `mysqldump`, or any other such programs, but you can retain them using a file copy operation. However, they are not needed for anything but to provide you with a backup of your previous view definition.

It is safe to remove these backup definitions, but only while `mysqld` is not running. If you delete the `arc` subdirectory or its files while `mysqld` is running, you will receive an error the next time you try to alter the view:

```
mysql> ALTER VIEW v AS SELECT * FROM t;
ERROR 6 (HY000): Error on delete of './test\arc\v.frm-0004' (Errcode:
2)
```

Columns retrieved by the `SELECT` statement can be simple references to table columns. They can also be expressions that use functions, constant values, operators, and so forth.

Unqualified table or view names in the `SELECT` statement are interpreted with respect to the default database. A view can refer to tables or views in other databases by qualifying the table or view name with the proper database name.

A view can be created from many kinds of `SELECT` statements. It can refer to base tables or other views. It can use joins, `UNION`, and subqueries. The `SELECT` need not even refer to any tables. The following example defines a view that selects two columns from another table, as well as an expression calculated from those columns:

```
mysql> CREATE TABLE t (qty INT, price INT);
mysql> INSERT INTO t VALUES(3, 50);
mysql> CREATE VIEW v AS SELECT qty, price, qty*price AS value FROM t;
mysql> SELECT * FROM v;
```

qty	price	value
3	50	150

A view definition is subject to the following restrictions:

- The `SELECT` statement cannot contain a subquery in the `FROM` clause.
- The `SELECT` statement cannot refer to system or user variables.
- Within a stored program, the definition cannot refer to program parameters or local variables.
- The `SELECT` statement cannot refer to prepared statement parameters.
- Any table or view referred to in the definition must exist. However, after a view has been created, it is possible to drop a table or view that the definition refers to. In this case, use of the view results in an error. To check a view definition for problems of this kind, use the `CHECK TABLE` statement.
- The definition cannot refer to a `TEMPORARY` table, and you cannot create a `TEMPORARY` view.
- Any tables named in the view definition must exist at definition time.
- You cannot associate a trigger with a view.
- As of MySQL 5.1.23, aliases for column names in the `SELECT` statement are checked against the maximum column length of 64 characters (not the maximum alias length of 256 characters).

`ORDER BY` is allowed in a view definition, but it is ignored if you select from a view using a statement that has its own `ORDER BY`.

For other options or clauses in the definition, they are added to the options or clauses of the statement that references the view, but the effect is undefined. For example, if a view definition includes a `LIMIT` clause, and you select from the view using a statement that has its own `LIMIT` clause, it is undefined which limit applies. This same principle applies to options such as `ALL`, `DISTINCT`, or `SQL_SMALL_RESULT` that follow the `SELECT` keyword, and to clauses such as `INTO`, `FOR UPDATE`, `LOCK IN SHARE MODE`, and `PROCEDURE`.

If you create a view and then change the query processing environment by changing system variables, that may affect the results that you get from the view:

```
mysql> CREATE VIEW v (mycol) AS SELECT 'abc';
Query OK, 0 rows affected (0.01 sec)

mysql> SET sql_mode = '';
Query OK, 0 rows affected (0.00 sec)

mysql> SELECT "mycol" FROM v;
```



```

+-----+
| mycol |
+-----+
| mycol |
+-----+
1 row in set (0.01 sec)

mysql> SET sql_mode = 'ANSI_QUOTES';
Query OK, 0 rows affected (0.00 sec)

mysql> SELECT "mycol" FROM v;
+-----+
| mycol |
+-----+
| abc   |
+-----+
1 row in set (0.00 sec)

```

The `DEFINER` and `SQL SECURITY` clauses determine which MySQL account to use when checking access privileges for the view when a statement is executed that references the view. They were added in MySQL 5.1.2. The legal `SQL SECURITY` characteristic values are `DEFINER` and `INVOKER`. These indicate that the required privileges must be held by the user who defined or invoked the view, respectively. The default `SQL SECURITY` value is `DEFINER`.

If a `user` value is given for the `DEFINER` clause, it should be a MySQL account in '`user_name`'@'`host_name`' format (the same format used in the `GRANT` statement). The `user_name` and `host_name` values both are required. The definer can also be given as `CURRENT_USER` or `CURRENT_USER()`. The default `DEFINER` value is the user who executes the `CREATE VIEW` statement. This is the same as specifying `DEFINER = CURRENT_USER` explicitly.

If you specify the `DEFINER` clause, these rules determine the legal `DEFINER` user values:

- If you do not have the `SUPER` privilege, the only legal `user` value is your own account, either specified literally or by using `CURRENT_USER`. You cannot set the definer to some other account.
- If you have the `SUPER` privilege, you can specify any syntactically legal account name. If the account does not actually exist, a warning is generated.
- If the `SQL SECURITY` value is `DEFINER` but the definer account does not exist when the view is referenced, an error occurs.

Within a view definition, `CURRENT_USER` returns the view's `DEFINER` value by default as of MySQL 5.1.12. For older versions, and for views defined with the `SQL SECURITY INVOKER` characteristic, `CURRENT_USER` returns the account for the view's invoker. For information about user auditing within views, see [Section 5.5.9, "Auditing MySQL Account Activity"](#).

Within a stored routine that is defined with the `SQL SECURITY DEFINER` characteristic, `CURRENT_USER` returns the routine's `DEFINER` value. This also affects a view defined within such a program, if the view definition contains a `DEFINER` value of `CURRENT_USER`.

As of MySQL 5.1.2 (when the `DEFINER` and `SQL SECURITY` clauses were implemented), view privileges are checked like this:

- At view definition time, the view creator must have the privileges needed to use the top-level objects accessed by the view. For example, if the view definition refers to table columns, the creator must have privileges for the columns, as described previously. If the definition refers to a stored function, only the privileges needed to invoke the function can be checked. The privileges required when the function runs can be checked only as it executes: For different invocations of the function, different execution paths within the function might be taken.
- When a view is referenced, privileges for objects accessed by the view are checked against the privileges held by the view creator or invoker, depending on whether the `SQL SECURITY` characteristic is `DEFINER` or `INVOKER`, respectively.
- If reference to a view causes execution of a stored function, privilege checking for statements executed within the function depend on whether the function is defined with a `SQL SECURITY` characteristic of `DEFINER` or `INVOKER`. If the security characteristic is `DEFINER`, the function runs with the privileges of its creator. If the characteristic is `INVOKER`, the function runs with the privileges determined by the view's `SQL SECURITY` characteristic.

Prior to MySQL 5.1.2 (before the `DEFINER` and `SQL SECURITY` clauses were implemented), privileges required for objects used in a view are checked at view creation time.

Example: A view might depend on a stored function, and that function might invoke other stored routines. For example, the following view invokes a stored function `f()`:

```
CREATE VIEW v AS SELECT * FROM t WHERE t.id = f(t.name);
```

Suppose that `f()` contains a statement such as this:



```
IF name IS NULL then
  CALL p1();
ELSE
  CALL p2();
END IF;
```

The privileges required for executing statements within `f()` need to be checked when `f()` executes. This might mean that privileges are needed for `p1()` or `p2()`, depending on the execution path within `f()`. Those privileges must be checked at runtime, and the user who must possess the privileges is determined by the `SQL SECURITY` values of the view `v` and the function `f()`.

The `DEFINER` and `SQL SECURITY` clauses for views are extensions to standard SQL. In standard SQL, views are handled using the rules for `SQL SECURITY INVOKER`.

If you invoke a view that was created before MySQL 5.1.2, it is treated as though it was created with a `SQL SECURITY DEFINER` clause and with a `DEFINER` value that is the same as your account. However, because the actual definer is unknown, MySQL issues a warning. To make the warning go away, it is sufficient to re-create the view so that the view definition includes a `DEFINER` clause.

The optional `ALGORITHM` clause is a MySQL extension to standard SQL. It affects how MySQL processes the view. `ALGORITHM` takes three values: `MERGE`, `TEMPTABLE`, or `UNDEFINED`. The default algorithm is `UNDEFINED` if no `ALGORITHM` clause is present. For more information, see [Section 18.5.2, “View Processing Algorithms”](#).

Some views are updatable. That is, you can use them in statements such as `UPDATE`, `DELETE`, or `INSERT` to update the contents of the underlying table. For a view to be updatable, there must be a one-to-one relationship between the rows in the view and the rows in the underlying table. There are also certain other constructs that make a view non-updatable.

The `WITH CHECK OPTION` clause can be given for an updatable view to prevent inserts or updates to rows except those for which the `WHERE` clause in the `select_statement` is true.

In a `WITH CHECK OPTION` clause for an updatable view, the `LOCAL` and `CASCADE` keywords determine the scope of check testing when the view is defined in terms of another view. The `LOCAL` keyword restricts the `CHECK OPTION` only to the view being defined. `CASCADE` causes the checks for underlying views to be evaluated as well. When neither keyword is given, the default is `CASCADE`.

For more information about updatable views and the `WITH CHECK OPTION` clause, see [Section 18.5.3, “Updatable and Insertable Views”](#).

## 12.1.21. DROP DATABASE Syntax

```
DROP {DATABASE | SCHEMA} [IF EXISTS] db_name
```

`DROP DATABASE` drops all tables in the database and deletes the database. Be *very* careful with this statement! To use `DROP DATABASE`, you need the `DROP` privilege on the database. `DROP SCHEMA` is a synonym for `DROP DATABASE`.

### Important

When a database is dropped, user privileges on the database are *not* automatically dropped. See [Section 12.5.1.3, “GRANT Syntax”](#).

`IF EXISTS` is used to prevent an error from occurring if the database does not exist.

If you use `DROP DATABASE` on a symbolically linked database, both the link and the original database are deleted.

`DROP DATABASE` returns the number of tables that were removed. This corresponds to the number of `.frm` files removed.

The `DROP DATABASE` statement removes from the given database directory those files and directories that MySQL itself may create during normal operation:

- All files with the following extensions.

<code>.BAK</code>	<code>.DAT</code>	<code>.HSH</code>	<code>.MRG</code>
<code>.MYD</code>	<code>.MYI</code>	<code>.TRG</code>	<code>.TRN</code>
<code>.db</code>	<code>.frm</code>	<code>.ibd</code>	<code>.ndb</code>
<code>.par</code>			

- The `db.opt` file, if it exists.

If other files or directories remain in the database directory after MySQL removes those just listed, the database directory cannot be removed. In this case, you must remove any remaining files or directories manually and issue the `DROP DATABASE` statement again.

You can also drop databases with `mysqladmin`. See [Section 4.5.2, “mysqladmin — Client for Administering a MySQL Server”](#).

## 12.1.22. DROP EVENT Syntax

```
DROP EVENT [IF EXISTS] event_name
```

This statement drops the event named *event\_name*. The event immediately ceases being active, and is deleted completely from the server.

If the event does not exist, the error `ERROR 1517 (HY000): UNKNOWN EVENT 'EVENT_NAME'` results. You can override this and cause the statement to generate a warning for non-existent events instead using `IF EXISTS`.

Beginning with MySQL 5.1.12, this statement requires the `EVENT` privilege for the schema to which the event to be dropped belongs. (In MySQL 5.1.11 and earlier, an event could be dropped only by its definer, or by a user having the `SUPER` privilege.)

## 12.1.23. DROP FUNCTION Syntax

The `DROP FUNCTION` statement is used to drop stored functions and user-defined functions (UDFs):

- For information about dropping stored functions, see [Section 12.1.26, “DROP PROCEDURE and DROP FUNCTION Syntax”](#).
- For information about dropping user-defined functions, see [Section 12.5.3.2, “DROP FUNCTION Syntax”](#).

## 12.1.24. DROP INDEX Syntax

```
DROP [ONLINE|OFFLINE] INDEX index_name ON tbl_name
```

`DROP INDEX` drops the index named *index\_name* from the table *tbl\_name*. This statement is mapped to an `ALTER TABLE` statement to drop the index. See [Section 12.1.7, “ALTER TABLE Syntax”](#).

Beginning with MySQL 5.1.7, indexes on variable-width columns are dropped online; that is, dropping the indexes does not require any copying of the table. For `NDBCLUSTER` tables, the table is not locked against access from other MySQL Cluster API nodes, although it is locked against other operations on the *same* API node for the duration of the online operation. This is done automatically by the server whenever it determines that it is possible to do so; you do not have to use any special SQL syntax or server options to cause it to happen.

In standard MySQL 5.1 releases, it is not possible to override the server when it determines that an index is to be dropped online. In MySQL Cluster, beginning with MySQL Cluster NDB 6.2.5 and MySQL Cluster NDB 6.3.3, you can drop indexes offline (which causes the table to be locked for all API nodes in the cluster) using the `OFFLINE` keyword. The rules and limitations governing online `DROP OFFLINE INDEX` and `DROP ONLINE INDEX` are the same as for `ALTER OFFLINE TABLE ... DROP INDEX` and `ALTER ONLINE TABLE ... DROP INDEX`. You cannot cause the online dropping of an index that would normally be dropped offline by using the `ONLINE` keyword (if it is not possible to perform the `DROP` operation online, then the `ONLINE` keyword is ignored). For more information, see [Section 12.1.7, “ALTER TABLE Syntax”](#).

### Note

The `ONLINE` and `OFFLINE` keywords are available only in MySQL Cluster NDB 6.2 and MySQL Cluster NDB 6.3 releases beginning with versions 6.2.5 and 6.3.3, respectively; attempting to use them in earlier MySQL Cluster NDB 6.2 or 6.3 releases, standard MySQL 5.1 releases, or MySQL Cluster NDB 6.1 releases results in a syntax error.

## 12.1.25. DROP LOGFILE GROUP Syntax

```
DROP LOGFILE GROUP logfile_group
ENGINE [=] engine_name
```

This statement drops the log file group named *logfile\_group*. The log file group must already exist or an error results. (For information on creating log file groups, see [Section 12.1.14, “CREATE LOGFILE GROUP Syntax”](#).)

### Important

Before dropping a log file group, you must drop all tablespaces that use that log file group for [UNDO](#) logging.

The required [ENGINE](#) clause provides the name of the storage engine used by the log file group to be dropped. In MySQL 5.1, the only permitted values for *engine\_name* are [NDB](#) and [NDBCLUSTER](#).

[DROP LOGFILE GROUP](#) was added in MySQL 5.1.6. In MySQL 5.1, it is useful only with Disk Data storage for MySQL Cluster. See [MySQL Cluster Disk Data Tables](#).

## 12.1.26. DROP PROCEDURE and DROP FUNCTION Syntax

```
DROP {PROCEDURE | FUNCTION} [IF EXISTS] sp_name
```

This statement is used to drop a stored procedure or function. That is, the specified routine is removed from the server. You must have the [ALTER ROUTINE](#) privilege for the routine. (That privilege is granted automatically to the routine creator.)

The [IF EXISTS](#) clause is a MySQL extension. It prevents an error from occurring if the procedure or function does not exist. A warning is produced that can be viewed with [SHOW WARNINGS](#).

[DROP FUNCTION](#) is also used to drop user-defined functions (see [Section 12.5.3.2](#), “[DROP FUNCTION Syntax](#)”).

## 12.1.27. DROP SERVER Syntax

```
DROP SERVER [ IF EXISTS ] server_name
```

Drops the server definition for the server named *server\_name*. The corresponding row within the `mysql.servers` table will be deleted. This statement requires the [SUPER](#) privilege.

Dropping a server for a table does not affect any [FEDERATED](#) tables that used this connection information when they were created. See [Section 12.1.16](#), “[CREATE SERVER Syntax](#)”.

[DROP SERVER](#) does not cause an automatic commit.

[DROP SERVER](#) was added in MySQL 5.1.15.

## 12.1.28. DROP TABLE Syntax

```
DROP [TEMPORARY] TABLE [IF EXISTS]
tbl_name [, tbl_name] ...
[RESTRICT | CASCADE]
```

[DROP TABLE](#) removes one or more tables. You must have the [DROP](#) privilege for each table. All table data and the table definition are *removed*, so be careful with this statement! If any of the tables named in the argument list do not exist, MySQL returns an error indicating by name which non-existing tables it was unable to drop, but it also drops all of the tables in the list that do exist.

### Important

When a table is dropped, user privileges on the table are *not* automatically dropped. See [Section 12.5.1.3](#), “[GRANT Syntax](#)”.

Note that for a partitioned table, [DROP TABLE](#) permanently removes the table definition, all of its partitions, and all of the data which was stored in those partitions. It also removes the partitioning definition (`.par`) file associated with the dropped table.

Use [IF EXISTS](#) to prevent an error from occurring for tables that do not exist. A [NOTE](#) is generated for each non-existent table when using [IF EXISTS](#). See [Section 12.5.5.42](#), “[SHOW WARNINGS Syntax](#)”.

[RESTRICT](#) and [CASCADE](#) are allowed to make porting easier. In MySQL 5.1, they do nothing.

### Note

[DROP TABLE](#) automatically commits the current active transaction, unless you use the [TEMPORARY](#) keyword.

The [TEMPORARY](#) keyword has the following effects:

- The statement drops only [TEMPORARY](#) tables.
- The statement does not end an ongoing transaction.
- No access rights are checked. (A [TEMPORARY](#) table is visible only to the session that created it, so no check is necessary.)

Using `TEMPORARY` is a good way to ensure that you do not accidentally drop a non-`TEMPORARY` table.

## 12.1.29. DROP TABLESPACE Syntax

```
DROP TABLESPACE tablespace_name
ENGINE [=] engine_name
```

This statement drops a tablespace that was previously created using `CREATE TABLESPACE` (see [Section 12.1.18](#), “`CREATE TABLESPACE Syntax`”).

### Important

The tablespace to be dropped must not contain any data files; in other words, before you can drop a tablespace, you must first drop each of its data files using `ALTER TABLESPACE ... DROP DATAFILE` (see [Section 12.1.8](#), “`ALTER TABLESPACE Syntax`”).

The `ENGINE` clause (required) specifies the storage engine used by the tablespace. In MySQL 5.1, the only accepted values for `engine_name` are `NDB` and `NDBCLUSTER`.

`DROP TABLESPACE` was added in MySQL 5.1.6. In MySQL 5.1, it is useful only with Disk Data storage for MySQL Cluster. See [MySQL Cluster Disk Data Tables](#).

## 12.1.30. DROP TRIGGER Syntax

```
DROP TRIGGER [IF EXISTS] [schema_name.]trigger_name
```

This statement drops a trigger. The schema (database) name is optional. If the schema is omitted, the trigger is dropped from the default schema. `DROP TRIGGER` was added in MySQL 5.0.2. Its use requires the `TRIGGER` privilege for the table associated with the trigger. (This statement requires the `SUPER` privilege prior to MySQL 5.1.6.)

Use `IF EXISTS` to prevent an error from occurring for a trigger that does not exist. A `NOTE` is generated for a non-existent trigger when using `IF EXISTS`. See [Section 12.5.5.42](#), “`SHOW WARNINGS Syntax`”. The `IF EXISTS` clause was added in MySQL 5.1.14.

Triggers for a table are also dropped if you drop the table.

### Note

When upgrading from a version of MySQL older than MySQL 5.0.10 to 5.0.10 or newer — including all MySQL 5.1 releases — you must drop all triggers *before upgrading* and re-create them afterward, or else `DROP TRIGGER` does not work after the upgrade. See [Section 2.12.1.1](#), “`Upgrading from MySQL 5.0 to 5.1`”, for a suggested upgrade procedure.

## 12.1.31. DROP VIEW Syntax

```
DROP VIEW [IF EXISTS]
view_name [, view_name] ...
[RESTRICT | CASCADE]
```

`DROP VIEW` removes one or more views. You must have the `DROP` privilege for each view. If any of the views named in the argument list do not exist, MySQL returns an error indicating by name which non-existing views it was unable to drop, but it also drops all of the views in the list that do exist.

The `IF EXISTS` clause prevents an error from occurring for views that don't exist. When this clause is given, a `NOTE` is generated for each non-existent view. See [Section 12.5.5.42](#), “`SHOW WARNINGS Syntax`”.

`RESTRICT` and `CASCADE`, if given, are parsed and ignored.

## 12.1.32. RENAME DATABASE Syntax

```
RENAME {DATABASE | SCHEMA} db_name TO new_db_name;
```

This statement was added in MySQL 5.1.7 but was found to be dangerous and was removed in MySQL 5.1.23. It was intended to enable upgrading pre-5.1 databases to use the encoding implemented in 5.1 for mapping database names to database directory names (see [Section 8.2.3](#), “`Mapping of Identifiers to File Names`”). However, use of this statement could result in loss of database contents, which is why it was removed. Do not use `RENAME DATABASE` in earlier versions in which it is present.

To perform the task of upgrading database names with the new encoding, use `ALTER DATABASE db_name UPGRADE DATA DIRECTORY NAME` instead (see [Section 12.1.1, “ALTER DATABASE Syntax”](#)).

## 12.1.33. RENAME TABLE Syntax

```
RENAME TABLE tbl_name TO new_tbl_name
[, tbl_name2 TO new_tbl_name2] ...
```

This statement renames one or more tables.

The rename operation is done atomically, which means that no other session can access any of the tables while the rename is running. For example, if you have an existing table `old_table`, you can create another table `new_table` that has the same structure but is empty, and then replace the existing table with the empty one as follows (assuming that `backup_table` does not already exist):

```
CREATE TABLE new_table (...);
RENAME TABLE old_table TO backup_table, new_table TO old_table;
```

If the statement renames more than one table, renaming operations are done from left to right. If you want to swap two table names, you can do so like this (assuming that `tmp_table` does not already exist):

```
RENAME TABLE old_table TO tmp_table,
             new_table TO old_table,
             tmp_table TO new_table;
```

As long as two databases are on the same file system, you can use `RENAME TABLE` to move a table from one database to another:

```
RENAME TABLE current_db.tbl_name TO other_db.tbl_name;
```

If there are any triggers associated with a table which is moved to a different database using `RENAME TABLE`, then the statement fails with the error `TRIGGER IN WRONG SCHEMA`.

`RENAME TABLE` also works for views, as long as you do not try to rename a view into a different database.

Any privileges granted specifically for the renamed table or view are not migrated to the new name. They must be changed manually.

When you execute `RENAME`, you cannot have any locked tables or active transactions. You must also have the `ALTER` and `DROP` privileges on the original table, and the `CREATE` and `INSERT` privileges on the new table.

If MySQL encounters any errors in a multiple-table rename, it does a reverse rename for all renamed tables to return everything to its original state.

You cannot use `RENAME` to rename a `TEMPORARY` table. However, you can use `ALTER TABLE` instead:

```
mysql> ALTER TABLE orig_name RENAME new_name;
```

## 12.2. Data Manipulation Statements

### 12.2.1. CALL Syntax

```
CALL sp_name( [parameter[,...]] )
CALL sp_name( )
```

The `CALL` statement invokes a stored procedure that was defined previously with `CREATE PROCEDURE`.

As of MySQL 5.1.13, stored procedures that take no arguments can be invoked without parentheses. That is, `CALL p()` and `CALL p` are equivalent.

`CALL` can pass back values to its caller using parameters that are declared as `OUT` or `INOUT` parameters. When the procedure returns, a client program can also obtain the number of rows affected for the final statement executed within the routine: At the SQL level, call the `ROW_COUNT()` function; from the C API, call the `mysql_affected_rows()` function.

To get back a value from a procedure using an `OUT` or `INOUT` parameter, pass the parameter by means of a user variable, and then check the value of the variable after the procedure returns. (If you are calling the procedure from within another stored procedure or function, you can also pass a routine parameter or local routine variable as an `IN` or `INOUT` parameter.) For an `INOUT` parameter, initialize its value before passing it to the procedure. The following procedure has an `OUT` parameter that the procedure sets to the current server version, and an `INOUT` value that the procedure increments by one from its current value:

```
CREATE PROCEDURE p (OUT ver_param VARCHAR(25), INOUT incr_param INT)
BEGIN
  # Set value of OUT parameter
  SELECT VERSION() INTO ver_param;
  # Increment value of INOUT parameter
  SET incr_param = incr_param + 1;
END;
```

Before calling the procedure, initialize the variable to be passed as the `INOUT` parameter. After calling the procedure, the values of the two variables will have been set or modified:

```
mysql> SET @increment = 10;
mysql> CALL p(@version, @increment);
mysql> SELECT @version, @increment;
+-----+-----+
| @version | @increment |
+-----+-----+
| 5.1.32-log | 11 |
+-----+-----+
```

In prepared `CALL` statements used with `PREPARE` and `EXECUTE`, placeholder support is available in MySQL 5.1 for `IN` parameters, but not for `OUT` or `INOUT` parameters. To work around this limitation for `OUT` and `INOUT` parameters, forego the use of placeholders; instead, refer to user variables in the `CALL` statement itself and do not specify them in the `EXECUTE` statement:

```
mysql> SET @increment = 10;
mysql> PREPARE s FROM 'CALL p(@version, @increment)';
mysql> EXECUTE s;
mysql> SELECT @version, @increment;
+-----+-----+
| @version | @increment |
+-----+-----+
| 5.1.32-log | 11 |
+-----+-----+
```

To write C programs that use the `CALL` SQL statement to execute stored procedures that produce result sets, the `CLIENT_MULTI_RESULTS` flag must be enabled. This is because each `CALL` returns a result to indicate the call status, in addition to any result sets that might be returned by statements executed within the procedure. `CLIENT_MULTI_RESULTS` must also be enabled if `CALL` is used to execute any stored procedure that contains prepared statements. It cannot be determined when such a procedure is loaded whether those statements will produce result sets, so it is necessary to assume that they will.

`CLIENT_MULTI_RESULTS` can be enabled when you call `mysql_real_connect()`, either explicitly by passing the `CLIENT_MULTI_RESULTS` flag itself, or implicitly by passing `CLIENT_MULTI_STATEMENTS` (which also enables `CLIENT_MULTI_RESULTS`).

To process the result of a `CALL` statement executed via `mysql_query()` or `mysql_real_query()`, use a loop that calls `mysql_next_result()` to determine whether there are more results. For an example, see [Section 20.10.12, “C API Support for Multiple Statement Execution”](#).

For programs written in a language that provides a MySQL interface, there is no native method for directly retrieving the results of `OUT` or `INOUT` parameters from `CALL` statements. To get the parameter values, pass user-defined variables to the procedure in the `CALL` statement and then execute a `SELECT` statement to produce a result set containing the variable values. To handle an `INOUT` parameter, execute a statement prior to the `CALL` that sets the corresponding user variable to the value to be passed to the procedure.

The following example illustrates the technique (without error checking) for the stored procedure `p` described earlier that has an `OUT` parameter and an `INOUT` parameter:

```
mysql_query(mysql, "SET @increment = 10");
mysql_query(mysql, "CALL p(@version, @increment)");
mysql_query(mysql, "SELECT @version, @increment");
result = mysql_store_result(mysql);
row = mysql_fetch_row(result);
mysql_free_result(result);
```

After the preceding code executes, `row[0]` and `row[1]` contain the values of `@version` and `@increment`, respectively.

## 12.2.2. DELETE Syntax

Single-table syntax:

```
DELETE [LOW_PRIORITY] [QUICK] [IGNORE] FROM tbl_name
[WHERE where_condition]
[ORDER BY ...]
[LIMIT row_count]
```

Multiple-table syntax:

```
DELETE [LOW_PRIORITY] [QUICK] [IGNORE]
tbl_name[.*] [, tbl_name[.*]] ...
FROM table_references
[WHERE where_condition]
```

Or:

```
DELETE [LOW_PRIORITY] [QUICK] [IGNORE]
FROM tbl_name[.*] [, tbl_name[.*]] ...
USING table_references
[WHERE where_condition]
```

For the single-table syntax, the `DELETE` statement deletes rows from `tbl_name` and returns a count of the number of deleted rows. This count can be obtained by calling the `ROW_COUNT()` function (see [Section 11.11.3, “Information Functions”](#)). The `WHERE` clause, if given, specifies the conditions that identify which rows to delete. With no `WHERE` clause, all rows are deleted. If the `ORDER BY` clause is specified, the rows are deleted in the order that is specified. The `LIMIT` clause places a limit on the number of rows that can be deleted.

For the multiple-table syntax, `DELETE` deletes from each `tbl_name` the rows that satisfy the conditions. In this case, `ORDER BY` and `LIMIT` cannot be used.

`where_condition` is an expression that evaluates to true for each row to be deleted. It is specified as described in [Section 12.2.8, “SELECT Syntax”](#).

Currently, you cannot delete from a table and select from the same table in a subquery.

As stated, a `DELETE` statement with no `WHERE` clause deletes all rows. A faster way to do this, when you do not need to know the number of deleted rows, is to use `TRUNCATE TABLE`. However, within a transaction or if you have a lock on the table, `TRUNCATE TABLE` cannot be used whereas `DELETE` can. See [Section 12.2.10, “TRUNCATE Syntax”](#), and [Section 12.4.5, “LOCK TABLES and UNLOCK TABLES Syntax”](#).

If you delete the row containing the maximum value for an `AUTO_INCREMENT` column, the value is not reused for a `MyISAM` or `InnoDB` table. If you delete all rows in the table with `DELETE FROM tbl_name` (without a `WHERE` clause) in `autocommit` mode, the sequence starts over for all storage engines except `InnoDB` and `MyISAM`. There are some exceptions to this behavior for `InnoDB` tables, as discussed in [Section 13.6.4.3, “AUTO\\_INCREMENT Handling in InnoDB”](#).

For `MyISAM` tables, you can specify an `AUTO_INCREMENT` secondary column in a multiple-column key. In this case, reuse of values deleted from the top of the sequence occurs even for `MyISAM` tables. See [Section 3.6.9, “Using AUTO\\_INCREMENT”](#).

The `DELETE` statement supports the following modifiers:

- If you specify `LOW_PRIORITY`, the server delays execution of the `DELETE` until no other clients are reading from the table. This affects only storage engines that use only table-level locking (`MyISAM`, `MEMORY`, `MERGE`).
- For `MyISAM` tables, if you use the `QUICK` keyword, the storage engine does not merge index leaves during delete, which may speed up some kinds of delete operations.
- The `IGNORE` keyword causes MySQL to ignore all errors during the process of deleting rows. (Errors encountered during the parsing stage are processed in the usual manner.) Errors that are ignored due to the use of `IGNORE` are returned as warnings.

The speed of delete operations may also be affected by factors discussed in [Section 7.2.23, “Speed of DELETE Statements”](#).

In `MyISAM` tables, deleted rows are maintained in a linked list and subsequent `INSERT` operations reuse old row positions. To reclaim unused space and reduce file sizes, use the `OPTIMIZE TABLE` statement or the `myisamchk` utility to reorganize tables. `OPTIMIZE TABLE` is easier to use, but `myisamchk` is faster. See [Section 12.5.2.5, “OPTIMIZE TABLE Syntax”](#), and [Section 4.6.3, “myisamchk — MyISAM Table-Maintenance Utility”](#).

The `QUICK` modifier affects whether index leaves are merged for delete operations. `DELETE QUICK` is most useful for applications where index values for deleted rows are replaced by similar index values from rows inserted later. In this case, the holes left by deleted values are reused.

`DELETE QUICK` is not useful when deleted values lead to underfilled index blocks spanning a range of index values for which new inserts occur again. In this case, use of `QUICK` can lead to wasted space in the index that remains unreclaimed. Here is an example of such a scenario:

1. Create a table that contains an indexed `AUTO_INCREMENT` column.
2. Insert many rows into the table. Each insert results in an index value that is added to the high end of the index.



3. Delete a block of rows at the low end of the column range using `DELETE QUICK`.

In this scenario, the index blocks associated with the deleted index values become underfilled but are not merged with other index blocks due to the use of `QUICK`. They remain underfilled when new inserts occur, because new rows do not have index values in the deleted range. Furthermore, they remain underfilled even if you later use `DELETE` without `QUICK`, unless some of the deleted index values happen to lie in index blocks within or adjacent to the underfilled blocks. To reclaim unused index space under these circumstances, use `OPTIMIZE TABLE`.

If you are going to delete many rows from a table, it might be faster to use `DELETE QUICK` followed by `OPTIMIZE TABLE`. This rebuilds the index rather than performing many index block merge operations.

The MySQL-specific `LIMIT row_count` option to `DELETE` tells the server the maximum number of rows to be deleted before control is returned to the client. This can be used to ensure that a given `DELETE` statement does not take too much time. You can simply repeat the `DELETE` statement until the number of affected rows is less than the `LIMIT` value.

If the `DELETE` statement includes an `ORDER BY` clause, rows are deleted in the order specified by the clause. This is useful primarily in conjunction with `LIMIT`. For example, the following statement finds rows matching the `WHERE` clause, sorts them by `timestamp_column`, and deletes the first (oldest) one:

```
DELETE FROM somelog WHERE user = 'jcole'
ORDER BY timestamp_column LIMIT 1;
```

`ORDER BY` may also be useful in some cases to delete rows in an order required to avoid referential integrity violations.

If you are deleting many rows from a large table, you may exceed the lock table size for an `InnoDB` table. To avoid this problem, or simply to minimize the time that the table remains locked, the following strategy (which does not use `DELETE` at all) might be helpful:

1. Select the rows *not* to be deleted into an empty table that has the same structure as the original table:

```
INSERT INTO t_copy SELECT * FROM t WHERE ... ;
```

2. Use `RENAME TABLE` to atomically move the original table out of the way and rename the copy to the original name:

```
RENAME TABLE t TO t_old, t_copy TO t;
```

3. Drop the original table:

```
DROP TABLE t_old;
```

No other sessions can access the tables involved while `RENAME TABLE` executes, so the rename operation is not subject to concurrency problems. See [Section 12.1.33, “RENAME TABLE Syntax”](#).

You can specify multiple tables in a `DELETE` statement to delete rows from one or more tables depending on the particular condition in the `WHERE` clause. However, you cannot use `ORDER BY` or `LIMIT` in a multiple-table `DELETE`. The *table\_references* clause lists the tables involved in the join. Its syntax is described in [Section 12.2.8.1, “JOIN Syntax”](#).

For the first multiple-table syntax, only matching rows from the tables listed before the `FROM` clause are deleted. For the second multiple-table syntax, only matching rows from the tables listed in the `FROM` clause (before the `USING` clause) are deleted. The effect is that you can delete rows from many tables at the same time and have additional tables that are used only for searching:

```
DELETE t1, t2 FROM t1 INNER JOIN t2 INNER JOIN t3
WHERE t1.id=t2.id AND t2.id=t3.id;
```

Or:

```
DELETE FROM t1, t2 USING t1 INNER JOIN t2 INNER JOIN t3
WHERE t1.id=t2.id AND t2.id=t3.id;
```

These statements use all three tables when searching for rows to delete, but delete matching rows only from tables `t1` and `t2`.

The preceding examples use `INNER JOIN`, but multiple-table `DELETE` statements can use other types of join allowed in `SELECT` statements, such as `LEFT JOIN`. For example, to delete rows that exist in `t1` that have no match in `t2`, use a `LEFT JOIN`:

```
DELETE t1 FROM t1 LEFT JOIN t2 ON t1.id=t2.id WHERE t2.id IS NULL;
```



The syntax allows `.*` after each `tbl_name` for compatibility with `Access`.

If you use a multiple-table `DELETE` statement involving `InnoDB` tables for which there are foreign key constraints, the MySQL optimizer might process tables in an order that differs from that of their parent/child relationship. In this case, the statement fails and rolls back. Instead, you should delete from a single table and rely on the `ON DELETE` capabilities that `InnoDB` provides to cause the other tables to be modified accordingly.

### Note

If you declare an alias for a table, you must use the alias when referring to the table:

```
DELETE t1 FROM test AS t1, test2 WHERE ...
```

Table aliases in a multiple-table `DELETE` statement should be declared only in the `table_references` part. Elsewhere in the statement, alias references are allowed but not alias declarations.

Correct:

```
DELETE a1, a2 FROM t1 AS a1 INNER JOIN t2 AS a2
WHERE a1.id=a2.id;

DELETE FROM a1, a2 USING t1 AS a1 INNER JOIN t2 AS a2
WHERE a1.id=a2.id;
```

Incorrect:

```
DELETE t1 AS a1, t2 AS a2 FROM t1 INNER JOIN t2
WHERE a1.id=a2.id;

DELETE FROM t1 AS a1, t2 AS a2 USING t1 INNER JOIN t2
WHERE a1.id=a2.id;
```

Declaration of aliases other than in the `table_references` part can lead to ambiguous statements that have unexpected results such as deleting rows from the wrong table. This is such a statement:

```
DELETE FROM t1 AS a2 USING t1 AS a1 INNER JOIN t2 AS a2;
```

Before MySQL 5.1.23, alias declarations are allowed in other than the `table_references` part, but should be avoided for the reason just mentioned.

Cross-database deletes are supported for multiple-table deletes, but you should be aware that in the list of tables from which to delete rows, aliases will have a default database unless one is specified explicitly. For example, if the current database is `test`, the following statement does not work because the unqualified alias `a1` has a default database of `test`:

```
DELETE a1, a2 FROM db1.t1 AS a1 INNER JOIN db2.t2 AS a2
WHERE a1.id=a2.id;
```

To correctly match the alias, you must explicitly qualify it with the database of the table being aliased:

```
DELETE db1.a1, db2.a2 FROM db1.t1 AS a1 INNER JOIN db2.t2 AS a2
WHERE a1.id=a2.id;
```

## 12.2.3. DO Syntax

```
DO expr [, expr] ...
```

`DO` executes the expressions but does not return any results. In most respects, `DO` is shorthand for `SELECT expr, ...`, but has the advantage that it is slightly faster when you do not care about the result.

`DO` is useful primarily with functions that have side effects, such as `RELEASE_LOCK()`.

## 12.2.4. HANDLER Syntax

```
HANDLER tbl_name OPEN [ [AS] alias ]
HANDLER tbl_name READ index_name { = | >= | <= | < } (value1,value2,...)
  [ WHERE where_condition ] [LIMIT ... ]
HANDLER tbl_name READ index_name { FIRST | NEXT | PREV | LAST }
  [ WHERE where_condition ] [LIMIT ... ]
HANDLER tbl_name READ { FIRST | NEXT }
  [ WHERE where_condition ] [LIMIT ... ]
HANDLER tbl_name CLOSE
```

The `HANDLER` statement provides direct access to table storage engine interfaces. It is available for `MyISAM` and `InnoDB` tables.

The `HANDLER ... OPEN` statement opens a table, making it accessible via subsequent `HANDLER ... READ` statements. This table object is not shared by other sessions and is not closed until the session calls `HANDLER ... CLOSE` or the session terminates. If you open the table using an alias, further references to the open table with other `HANDLER` statements must use the alias rather than the table name.

The first `HANDLER ... READ` syntax fetches a row where the index specified satisfies the given values and the `WHERE` condition is met. If you have a multiple-column index, specify the index column values as a comma-separated list. Either specify values for all the columns in the index, or specify values for a leftmost prefix of the index columns. Suppose that an index `my_idx` includes three columns named `col_a`, `col_b`, and `col_c`, in that order. The `HANDLER` statement can specify values for all three columns in the index, or for the columns in a leftmost prefix. For example:

```
HANDLER ... READ my_idx = (col_a_val,col_b_val,col_c_val) ...
HANDLER ... READ my_idx = (col_a_val,col_b_val) ...
HANDLER ... READ my_idx = (col_a_val) ...
```

To employ the `HANDLER` interface to refer to a table's `PRIMARY KEY`, use the quoted identifier ``PRIMARY``:

```
HANDLER tbl_name READ `PRIMARY` ...
```

The second `HANDLER ... READ` syntax fetches a row from the table in index order that matches the `WHERE` condition.

The third `HANDLER ... READ` syntax fetches a row from the table in natural row order that matches the `WHERE` condition. It is faster than `HANDLER tbl_name READ index_name` when a full table scan is desired. Natural row order is the order in which rows are stored in a `MyISAM` table data file. This statement works for `InnoDB` tables as well, but there is no such concept because there is no separate data file.

Without a `LIMIT` clause, all forms of `HANDLER ... READ` fetch a single row if one is available. To return a specific number of rows, include a `LIMIT` clause. It has the same syntax as for the `SELECT` statement. See [Section 12.2.8, “SELECT Syntax”](#).

`HANDLER ... CLOSE` closes a table that was opened with `HANDLER ... OPEN`.

There are several reasons to use the `HANDLER` interface instead of normal `SELECT` statements:

- `HANDLER` is faster than `SELECT`:
  - A designated storage engine handler object is allocated for the `HANDLER ... OPEN`. The object is reused for subsequent `HANDLER` statements for that table; it need not be reinitialized for each one.
  - There is less parsing involved.
  - There is no optimizer or query-checking overhead.
  - The table does not have to be locked between two handler requests.
  - The handler interface does not have to provide a consistent look of the data (for example, dirty reads are allowed), so the storage engine can use optimizations that `SELECT` does not normally allow.
- For applications that use a low-level `ISAM`-like interface, `HANDLER` makes it much easier to port them to MySQL.
- `HANDLER` enables you to traverse a database in a manner that is difficult (or even impossible) to accomplish with `SELECT`. The `HANDLER` interface is a more natural way to look at data when working with applications that provide an interactive user interface to the database.

`HANDLER` is a somewhat low-level statement. For example, it does not provide consistency. That is, `HANDLER ... OPEN` does *not* take a snapshot of the table, and does *not* lock the table. This means that after a `HANDLER ... OPEN` statement is issued, table data can be modified (by the current session or other sessions) and these modifications might be only partially visible to `HANDLER ... NEXT` or `HANDLER ... PREV` scans.

An open handler can be closed and marked for reopen, in which case the handler loses its position in the table. This occurs when both of the following circumstances are true:

- Any session executes `FLUSH TABLES` or DDL statements on the handler's table.
- The session in which the handler is open executes non-`HANDLER` statements that use tables.

## 12.2.5. INSERT Syntax

```
INSERT [LOW_PRIORITY | DELAYED | HIGH_PRIORITY] [IGNORE]
[INTO] tbl_name [(col_name,...)]
{VALUES | VALUE} ({expr | DEFAULT},...),(...),...
[ ON DUPLICATE KEY UPDATE
  col_name=expr
  [, col_name=expr] ... ]
```

Or:

```
INSERT [LOW_PRIORITY | DELAYED | HIGH_PRIORITY] [IGNORE]
[INTO] tbl_name
SET col_name={expr | DEFAULT}, ...
[ ON DUPLICATE KEY UPDATE
  col_name=expr
  [, col_name=expr] ... ]
```

Or:

```
INSERT [LOW_PRIORITY | HIGH_PRIORITY] [IGNORE]
[INTO] tbl_name [(col_name,...)]
SELECT ...
[ ON DUPLICATE KEY UPDATE
  col_name=expr
  [, col_name=expr] ... ]
```

`INSERT` inserts new rows into an existing table. The `INSERT ... VALUES` and `INSERT ... SET` forms of the statement insert rows based on explicitly specified values. The `INSERT ... SELECT` form inserts rows selected from another table or tables. `INSERT ... SELECT` is discussed further in [Section 12.2.5.1, “INSERT ... SELECT Syntax”](#).

You can use `REPLACE` instead of `INSERT` to overwrite old rows. `REPLACE` is the counterpart to `INSERT IGNORE` in the treatment of new rows that contain unique key values that duplicate old rows: The new rows are used to replace the old rows rather than being discarded. See [Section 12.2.7, “REPLACE Syntax”](#).

`tbl_name` is the table into which rows should be inserted. The columns for which the statement provides values can be specified as follows:

- You can provide a comma-separated list of column names following the table name. In this case, a value for each named column must be provided by the `VALUES` list or the `SELECT` statement.
- If you do not specify a list of column names for `INSERT ... VALUES` or `INSERT ... SELECT`, values for every column in the table must be provided by the `VALUES` list or the `SELECT` statement. If you do not know the order of the columns in the table, use `DESCRIBE tbl_name` to find out.
- The `SET` clause indicates the column names explicitly.

Column values can be given in several ways:

- If you are not running in strict SQL mode, any column not explicitly given a value is set to its default (explicit or implicit) value. For example, if you specify a column list that does not name all the columns in the table, unnamed columns are set to their default values. Default value assignment is described in [Section 10.1.4, “Data Type Default Values”](#). See also [Section 1.7.6.2, “Constraints on Invalid Data”](#).

If you want an `INSERT` statement to generate an error unless you explicitly specify values for all columns that do not have a default value, you should use strict mode. See [Section 5.1.7, “Server SQL Modes”](#).

- Use the keyword `DEFAULT` to set a column explicitly to its default value. This makes it easier to write `INSERT` statements that assign values to all but a few columns, because it enables you to avoid writing an incomplete `VALUES` list that does not include a value for each column in the table. Otherwise, you would have to write out the list of column names corresponding to each value in the `VALUES` list.

You can also use `DEFAULT(col_name)` as a more general form that can be used in expressions to produce a given column's default value.

- If both the column list and the `VALUES` list are empty, `INSERT` creates a row with each column set to its default value:

```
INSERT INTO tbl_name () VALUES();
```

In strict mode, an error occurs if any column doesn't have a default value. Otherwise, MySQL uses the implicit default value for any column that does not have an explicitly defined default.

- You can specify an expression *expr* to provide a column value. This might involve type conversion if the type of the expression does not match the type of the column, and conversion of a given value can result in different inserted values depending on the data type. For example, inserting the string '1999.0e-2' into an `INT`, `FLOAT`, `DECIMAL(10,6)`, or `YEAR` column results in the values 1999, 19.9921, 19.992100, and 1999 being inserted, respectively. The reason the value stored in the `INT` and `YEAR` columns is 1999 is that the string-to-integer conversion looks only at as much of the initial part of the string as may be considered a valid integer or year. For the floating-point and fixed-point columns, the string-to-floating-point conversion considers the entire string a valid floating-point value.

An expression *expr* can refer to any column that was set earlier in a value list. For example, you can do this because the value for `col2` refers to `col1`, which has previously been assigned:

```
INSERT INTO tbl_name (col1,col2) VALUES(15,col1*2);
```

But the following is not legal, because the value for `col1` refers to `col2`, which is assigned after `col1`:

```
INSERT INTO tbl_name (col1,col2) VALUES(col2*2,15);
```

One exception involves columns that contain `AUTO_INCREMENT` values. Because the `AUTO_INCREMENT` value is generated after other value assignments, any reference to an `AUTO_INCREMENT` column in the assignment returns a 0.

`INSERT` statements that use `VALUES` syntax can insert multiple rows. To do this, include multiple lists of column values, each enclosed within parentheses and separated by commas. Example:

```
INSERT INTO tbl_name (a,b,c) VALUES(1,2,3),(4,5,6),(7,8,9);
```

The values list for each row must be enclosed within parentheses. The following statement is illegal because the number of values in the list does not match the number of column names:

```
INSERT INTO tbl_name (a,b,c) VALUES(1,2,3,4,5,6,7,8,9);
```

`VALUE` is a synonym for `VALUES` in this context. Neither implies anything about the number of values lists, and either may be used whether there is a single values list or multiple lists.

The affected-rows value for an `INSERT` can be obtained using the `ROW_COUNT()` function (see Section 11.11.3, "Information Functions"), or the `mysql_affected_rows()` C API function (see Section 20.10.3.1, "mysql\_affected\_rows()").

If you use an `INSERT ... VALUES` statement with multiple value lists or `INSERT ... SELECT`, the statement returns an information string in this format:

```
Records: 100 Duplicates: 0 Warnings: 0
```

`Records` indicates the number of rows processed by the statement. (This is not necessarily the number of rows actually inserted because `Duplicates` can be nonzero.) `Duplicates` indicates the number of rows that could not be inserted because they would duplicate some existing unique index value. `Warnings` indicates the number of attempts to insert column values that were problematic in some way. Warnings can occur under any of the following conditions:

- Inserting `NULL` into a column that has been declared `NOT NULL`. For multiple-row `INSERT` statements or `INSERT INTO ... SELECT` statements, the column is set to the implicit default value for the column data type. This is 0 for numeric types, the empty string ( ' ' ) for string types, and the "zero" value for date and time types. `INSERT INTO ... SELECT` statements are handled the same way as multiple-row inserts because the server does not examine the result set from the `SELECT` to see whether it returns a single row. (For a single-row `INSERT`, no warning occurs when `NULL` is inserted into a `NOT NULL` column. Instead, the statement fails with an error.)
- Setting a numeric column to a value that lies outside the column's range. The value is clipped to the closest endpoint of the range.
- Assigning a value such as '10.34 a' to a numeric column. The trailing non-numeric text is stripped off and the remaining numeric part is inserted. If the string value has no leading numeric part, the column is set to 0.
- Inserting a string into a string column (`CHAR`, `VARCHAR`, `TEXT`, or `BLOB`) that exceeds the column's maximum length. The value is truncated to the column's maximum length.
- Inserting a value into a date or time column that is illegal for the data type. The column is set to the appropriate zero value for the type.

If you are using the C API, the information string can be obtained by invoking the `mysql_info()` function. See [Sec-](#)

tion 20.10.3.35, “`mysql_info()`”.

If `INSERT` inserts a row into a table that has an `AUTO_INCREMENT` column, you can find the value used for that column by using the SQL `LAST_INSERT_ID()` function. From within the C API, use the `mysql_insert_id()` function. However, you should note that the two functions do not always behave identically. The behavior of `INSERT` statements with respect to `AUTO_INCREMENT` columns is discussed further in Section 11.11.3, “Information Functions”, and Section 20.10.3.37, “`mysql_insert_id()`”.

The `INSERT` statement supports the following modifiers:

- If you use the `DELAYED` keyword, the server puts the row or rows to be inserted into a buffer, and the client issuing the `INSERT DELAYED` statement can then continue immediately. If the table is in use, the server holds the rows. When the table is free, the server begins inserting rows, checking periodically to see whether there are any new read requests for the table. If there are, the delayed row queue is suspended until the table becomes free again. See Section 12.2.5.2, “`INSERT DELAYED Syntax`”.

`DELAYED` is ignored with `INSERT ... SELECT` or `INSERT ... ON DUPLICATE KEY UPDATE`.

Beginning with MySQL 5.1.19, `DELAYED` is also disregarded for an `INSERT` that uses functions accessing tables or triggers, or that is called from a function or a trigger.

- If you use the `LOW_PRIORITY` keyword, execution of the `INSERT` is delayed until no other clients are reading from the table. This includes other clients that began reading while existing clients are reading, and while the `INSERT LOW_PRIORITY` statement is waiting. It is possible, therefore, for a client that issues an `INSERT LOW_PRIORITY` statement to wait for a very long time (or even forever) in a read-heavy environment. (This is in contrast to `INSERT DELAYED`, which lets the client continue at once. Note that `LOW_PRIORITY` should normally not be used with `MyISAM` tables because doing so disables concurrent inserts. See Section 7.3.3, “Concurrent Inserts”.

If you specify `HIGH_PRIORITY`, it overrides the effect of the `--low-priority-updates` option if the server was started with that option. It also causes concurrent inserts not to be used. See Section 7.3.3, “Concurrent Inserts”.

`LOW_PRIORITY` and `HIGH_PRIORITY` affect only storage engines that use only table-level locking (`MyISAM`, `MEMORY`, `MERGE`).

- If you use the `IGNORE` keyword, errors that occur while executing the `INSERT` statement are treated as warnings instead. For example, without `IGNORE`, a row that duplicates an existing `UNIQUE` index or `PRIMARY KEY` value in the table causes a duplicate-key error and the statement is aborted. With `IGNORE`, the row still is not inserted, but no error is issued.

`IGNORE` has a similar effect on inserts into partitioned tables where no partition matching a given value is found. Without `IGNORE`, such `INSERT` statements are aborted with an error; however, when `INSERT IGNORE` is used, the insert operation fails silently for the row containing the unmatched value, but any rows that are matched are inserted. For an example, see Section 17.2.2, “LIST Partitioning”.

Data conversions that would trigger errors abort the statement if `IGNORE` is not specified. With `IGNORE`, invalid values are adjusted to the closest values and inserted; warnings are produced but the statement does not abort. You can determine with the `mysql_info()` C API function how many rows were actually inserted into the table.

- If you specify `ON DUPLICATE KEY UPDATE`, and a row is inserted that would cause a duplicate value in a `UNIQUE` index or `PRIMARY KEY`, an `UPDATE` of the old row is performed. The affected-rows value per row is 1 if the row is inserted as a new row and 2 if an existing row is updated. See Section 12.2.5.3, “`INSERT ... ON DUPLICATE KEY UPDATE Syntax`”.

Inserting into a table requires the `INSERT` privilege for the table. If the `ON DUPLICATE KEY UPDATE` clause is used and a duplicate key causes an `UPDATE` to be performed instead, the statement requires the `UPDATE` privilege for the columns to be updated. For columns that are read but not modified you need only the `SELECT` privilege (such as for a column referenced only on the right hand side of an `col_name=expr` assignment in an `ON DUPLICATE KEY UPDATE` clause).

### 12.2.5.1. `INSERT ... SELECT Syntax`

```
INSERT [LOW_PRIORITY | HIGH_PRIORITY] [IGNORE]
[INTO] tbl_name [(col_name,...)]
SELECT ...
[ ON DUPLICATE KEY UPDATE col_name=expr, ... ]
```

With `INSERT ... SELECT`, you can quickly insert many rows into a table from one or many tables. For example:

```
INSERT INTO tbl_temp2 (fld_id)
SELECT tbl_temp1.fld_order_id
FROM tbl_temp1 WHERE tbl_temp1.fld_order_id > 100;
```

The following conditions hold for a `INSERT ... SELECT` statements:

- Specify `IGNORE` to ignore rows that would cause duplicate-key violations.
- `DELAYED` is ignored with `INSERT ... SELECT`.
- The target table of the `INSERT` statement may appear in the `FROM` clause of the `SELECT` part of the query. (This was not possible in some older versions of MySQL.) In this case, MySQL creates a temporary table to hold the rows from the `SELECT` and then inserts those rows into the target table. However, it remains true that you cannot use `INSERT INTO t ... SELECT ... FROM t` when `t` is a `TEMPORARY` table, because `TEMPORARY` tables cannot be referred to twice in the same statement (see Section B.1.7.3, “TEMPORARY Table Problems”).
- `AUTO_INCREMENT` columns work as usual.
- To ensure that the binary log can be used to re-create the original tables, MySQL does not allow concurrent inserts for `INSERT ... SELECT` statements.
- Currently, you cannot insert into a table and select from the same table in a subquery.
- To avoid ambiguous column reference problems when the `SELECT` and the `INSERT` refer to the same table, provide a unique alias for each table used in the `SELECT` part, and qualify column names in that part with the appropriate alias.

In the values part of `ON DUPLICATE KEY UPDATE`, you can refer to columns in other tables, as long as you do not use `GROUP BY` in the `SELECT` part. One side effect is that you must qualify non-unique column names in the values part.

### 12.2.5.2. INSERT DELAYED Syntax

```
INSERT DELAYED ...
```

The `DELAYED` option for the `INSERT` statement is a MySQL extension to standard SQL that is very useful if you have clients that cannot or need not wait for the `INSERT` to complete. This is a common situation when you use MySQL for logging and you also periodically run `SELECT` and `UPDATE` statements that take a long time to complete.

When a client uses `INSERT DELAYED`, it gets an okay from the server at once, and the row is queued to be inserted when the table is not in use by any other thread.

Another major benefit of using `INSERT DELAYED` is that inserts from many clients are bundled together and written in one block. This is much faster than performing many separate inserts.

Note that `INSERT DELAYED` is slower than a normal `INSERT` if the table is not otherwise in use. There is also the additional overhead for the server to handle a separate thread for each table for which there are delayed rows. This means that you should use `INSERT DELAYED` only when you are really sure that you need it.

The queued rows are held only in memory until they are inserted into the table. This means that if you terminate `mysqld` forcibly (for example, with `kill -9`) or if `mysqld` dies unexpectedly, *any queued rows that have not been written to disk are lost*.

There are some constraints on the use of `DELAYED`:

- `INSERT DELAYED` works only with `MyISAM`, `MEMORY`, `ARCHIVE`, and (as of MySQL 5.1.19) `BLACKHOLE` tables. For engines that do not support `DELAYED`, an error occurs.
- An error occurs for `INSERT DELAYED` if used with a table that has been locked with `LOCK TABLES` because the insert must be handled by a separate thread, not by the session that holds the lock.
- For `MyISAM` tables, if there are no free blocks in the middle of the data file, concurrent `SELECT` and `INSERT` statements are supported. Under these circumstances, you very seldom need to use `INSERT DELAYED` with `MyISAM`.
- `INSERT DELAYED` should be used only for `INSERT` statements that specify value lists. The server ignores `DELAYED` for `INSERT ... SELECT` or `INSERT ... ON DUPLICATE KEY UPDATE` statements.
- Because the `INSERT DELAYED` statement returns immediately, before the rows are inserted, you cannot use `LAST_INSERT_ID()` to get the `AUTO_INCREMENT` value that the statement might generate.
- `DELAYED` rows are not visible to `SELECT` statements until they actually have been inserted.
- `INSERT DELAYED` is treated as a normal `INSERT` if the statement inserts multiple rows and binary logging is enabled and the global logging format is to use statement-based logging (`binlog_format` is set to `STATEMENT`). This restriction does not apply to row-based binary logging.
- `DELAYED` is ignored on slave replication servers, so that `INSERT DELAYED` is treated as a normal `INSERT` on slaves. This is



because `DELAYED` could cause the slave to have different data than the master.

- Pending `INSERT DELAYED` statements are lost if a table is write locked and `ALTER TABLE` is used to modify the table structure.
- `INSERT DELAYED` is not supported for views.
- `INSERT DELAYED` is not supported for partitioned tables.

The following describes in detail what happens when you use the `DELAYED` option to `INSERT` or `REPLACE`. In this description, the “thread” is the thread that received an `INSERT DELAYED` statement and “handler” is the thread that handles all `INSERT DELAYED` statements for a particular table.

- When a thread executes a `DELAYED` statement for a table, a handler thread is created to process all `DELAYED` statements for the table, if no such handler already exists.
- The thread checks whether the handler has previously acquired a `DELAYED` lock; if not, it tells the handler thread to do so. The `DELAYED` lock can be obtained even if other threads have a `READ` or `WRITE` lock on the table. However, the handler waits for all `ALTER TABLE` locks or `FLUSH TABLES` statements to finish, to ensure that the table structure is up to date.
- The thread executes the `INSERT` statement, but instead of writing the row to the table, it puts a copy of the final row into a queue that is managed by the handler thread. Any syntax errors are noticed by the thread and reported to the client program.
- The client cannot obtain from the server the number of duplicate rows or the `AUTO_INCREMENT` value for the resulting row, because the `INSERT` returns before the insert operation has been completed. (If you use the C API, the `mysql_info()` function does not return anything meaningful, for the same reason.)
- The binary log is updated by the handler thread when the row is inserted into the table. In case of multiple-row inserts, the binary log is updated when the first row is inserted.
- Each time that `delayed_insert_limit` rows are written, the handler checks whether any `SELECT` statements are still pending. If so, it allows these to execute before continuing.
- When the handler has no more rows in its queue, the table is unlocked. If no new `INSERT DELAYED` statements are received within `delayed_insert_timeout` seconds, the handler terminates.
- If more than `delayed_queue_size` rows are pending in a specific handler queue, the thread requesting `INSERT DELAYED` waits until there is room in the queue. This is done to ensure that `mysqld` does not use all memory for the delayed memory queue.
- The handler thread shows up in the MySQL process list with `delayed_insert` in the `Command` column. It is killed if you execute a `FLUSH TABLES` statement or kill it with `KILL thread_id`. However, before exiting, it first stores all queued rows into the table. During this time it does not accept any new `INSERT` statements from other threads. If you execute an `INSERT DELAYED` statement after this, a new handler thread is created.

Note that this means that `INSERT DELAYED` statements have higher priority than normal `INSERT` statements if there is an `INSERT DELAYED` handler running. Other update statements have to wait until the `INSERT DELAYED` queue is empty, someone terminates the handler thread (with `KILL thread_id`), or someone executes a `FLUSH TABLES`.

- The following status variables provide information about `INSERT DELAYED` statements.

Status Variable	Meaning
<code>Delayed_insert_threads</code>	Number of handler threads
<code>Delayed_writes</code>	Number of rows written with <code>INSERT DELAYED</code>
<code>Not_flushed_delayed_rows</code>	Number of rows waiting to be written

You can view these variables by issuing a `SHOW STATUS` statement or by executing a `mysqladmin extended-status` command.

### 12.2.5.3. `INSERT ... ON DUPLICATE KEY UPDATE` Syntax

If you specify `ON DUPLICATE KEY UPDATE`, and a row is inserted that would cause a duplicate value in a `UNIQUE` index or `PRIMARY KEY`, an `UPDATE` of the old row is performed. For example, if column `a` is declared as `UNIQUE` and contains the value `1`, the following two statements have identical effect:

```
INSERT INTO table (a,b,c) VALUES (1,2,3)
ON DUPLICATE KEY UPDATE c=c+1;

UPDATE table SET c=c+1 WHERE a=1;
```

With `ON DUPLICATE KEY UPDATE`, the affected-rows value per row is 1 if the row is inserted as a new row and 2 if an existing row is updated.

If column `b` is also unique, the `INSERT` is equivalent to this `UPDATE` statement instead:

```
UPDATE table SET c=c+1 WHERE a=1 OR b=2 LIMIT 1;
```

If `a=1 OR b=2` matches several rows, only *one* row is updated. In general, you should try to avoid using an `ON DUPLICATE KEY UPDATE` clause on tables with multiple unique indexes.

The `ON DUPLICATE KEY UPDATE` clause can contain multiple column assignments, separated by commas.

You can use the `VALUES(col_name)` function in the `UPDATE` clause to refer to column values from the `INSERT` portion of the `INSERT ... ON DUPLICATE KEY UPDATE` statement. In other words, `VALUES(col_name)` in the `ON DUPLICATE KEY UPDATE` clause refers to the value of `col_name` that would be inserted, had no duplicate-key conflict occurred. This function is especially useful in multiple-row inserts. The `VALUES()` function is meaningful only in `INSERT ... UPDATE` statements and returns `NULL` otherwise. Example:

```
INSERT INTO table (a,b,c) VALUES (1,2,3),(4,5,6)
ON DUPLICATE KEY UPDATE c=VALUES(a)+VALUES(b);
```

That statement is identical to the following two statements:

```
INSERT INTO table (a,b,c) VALUES (1,2,3)
ON DUPLICATE KEY UPDATE c=3;
INSERT INTO table (a,b,c) VALUES (4,5,6)
ON DUPLICATE KEY UPDATE c=9;
```

If a table contains an `AUTO_INCREMENT` column and `INSERT ... ON DUPLICATE KEY UPDATE` inserts a row, the `LAST_INSERT_ID()` function returns the `AUTO_INCREMENT` value. If the statement updates a row instead, `LAST_INSERT_ID()` is not meaningful prior to MySQL 5.1.12. However, you can work around this by using `LAST_INSERT_ID(expr)`. Suppose that `id` is the `AUTO_INCREMENT` column. To make `LAST_INSERT_ID()` meaningful for updates, insert rows as follows:

```
INSERT INTO table (a,b,c) VALUES (1,2,3)
ON DUPLICATE KEY UPDATE id=LAST_INSERT_ID(id), c=3;
```

The `DELAYED` option is ignored when you use `ON DUPLICATE KEY UPDATE`.

## 12.2.6. LOAD DATA INFILE Syntax

```
LOAD DATA [LOW_PRIORITY | CONCURRENT] [LOCAL] INFILE 'file_name'
[REPLACE | IGNORE]
INTO TABLE tbl_name
[CHARACTER SET charset_name]
[ {FIELDS | COLUMNS}
  [TERMINATED BY 'string']
  [[OPTIONALLY] ENCLOSED BY 'char']
  [ESCAPED BY 'char']
]
[LINES
  [STARTING BY 'string']
  [TERMINATED BY 'string']
]
[IGNORE number LINES]
[ (col_name_or_user_var, ...) ]
[SET col_name = expr, ...]
```

The `LOAD DATA INFILE` statement reads rows from a text file into a table at a very high speed. The file name must be given as a literal string.

`LOAD DATA INFILE` is the complement of `SELECT ... INTO OUTFILE`. (See [Section 12.2.8, “SELECT Syntax”](#).) To write data from a table to a file, use `SELECT ... INTO OUTFILE`. To read the file back into a table, use `LOAD DATA INFILE`. The syntax of the `FIELDS` and `LINES` clauses is the same for both statements. Both clauses are optional, but `FIELDS` must precede `LINES` if both are specified.

For more information about the efficiency of `INSERT` versus `LOAD DATA INFILE` and speeding up `LOAD DATA INFILE`, see [Section 7.2.21, “Speed of INSERT Statements”](#).



The character set indicated by the `character_set_database` system variable is used to interpret the information in the file. `SET NAMES` and the setting of `character_set_client` do not affect interpretation of input. If the contents of the input file use a character set that differs from the default, it is usually preferable to specify the character set of the file by using the `CHARACTER SET` clause, which is available as of MySQL 5.1.17.

`LOAD DATA INFILE` interprets all fields in the file as having the same character set, regardless of the data types of the columns into which field values are loaded. For proper interpretation of file contents, you must ensure that it was written with the correct character set. For example, if you write a data file with `mysqldump -T` or by issuing a `SELECT ... INTO OUTFILE` statement in `mysql`, be sure to use a `--default-character-set` option with `mysqldump` or `mysql` so that output is written in the character set to be used when the file is loaded with `LOAD DATA INFILE`.

Note that it is currently not possible to load data files that use the `ucs2`, `utf16`, or `utf32` character set.

As of MySQL 5.1.6, the `character_set_filesystem` system variable controls the interpretation of the file name.

You can also load data files by using the `mysqlimport` utility; it operates by sending a `LOAD DATA INFILE` statement to the server. The `--local` option causes `mysqlimport` to read data files from the client host. You can specify the `--compress` option to get better performance over slow networks if the client and server support the compressed protocol. See [Section 4.5.5](#), “`mysqlimport` — A Data Import Program”.

If you use `LOW_PRIORITY`, execution of the `LOAD DATA` statement is delayed until no other clients are reading from the table. This affects only storage engines that use only table-level locking (`MyISAM`, `MEMORY`, `MERGE`).

If you specify `CONCURRENT` with a `MyISAM` table that satisfies the condition for concurrent inserts (that is, it contains no free blocks in the middle), other threads can retrieve data from the table while `LOAD DATA` is executing. Using this option affects the performance of `LOAD DATA` a bit, even if no other thread is using the table at the same time.

`CONCURRENT` is not replicated when using statement-based replication; however, it is replicated when using row-based replication. See [Section 16.3.1.12](#), “`Replication and LOAD DATA`”, for more information.

### Note

Prior to MySQL 5.1.23, `LOAD DATA` performed very poorly when importing into partitioned tables. The statement now uses buffering to improve performance; however, the buffer uses 130 KB memory per partition to achieve this. ([Bug#26527](#))

The `LOCAL` keyword, if specified, is interpreted with respect to the client end of the connection:

- If `LOCAL` is specified, the file is read by the client program on the client host and sent to the server. The file can be given as a full path name to specify its exact location. If given as a relative path name, the name is interpreted relative to the directory in which the client program was started.
- If `LOCAL` is not specified, the file must be located on the server host and is read directly by the server. The server uses the following rules to locate the file:
  - If the file name is an absolute path name, the server uses it as given.
  - If the file name is a relative path name with one or more leading components, the server searches for the file relative to the server's data directory.
  - If a file name with no leading components is given, the server looks for the file in the database directory of the default database.

Note that, in the non-`LOCAL` case, these rules mean that a file named as `./myfile.txt` is read from the server's data directory, whereas the file named as `myfile.txt` is read from the database directory of the default database. For example, if `db1` is the default database, the following `LOAD DATA` statement reads the file `data.txt` from the database directory for `db1`, even though the statement explicitly loads the file into a table in the `db2` database:

```
LOAD DATA INFILE 'data.txt' INTO TABLE db2.my_table;
```

Windows path names are specified using forward slashes rather than backslashes. If you do use backslashes, you must double them.

For security reasons, when reading text files located on the server, the files must either reside in the database directory or be readable by all. Also, to use `LOAD DATA INFILE` on server files, you must have the `FILE` privilege. See [Section 5.4.1](#), “`Privileges Provided by MySQL`”. For non-`LOCAL` load operations, if the `secure_file_priv` system variable is set to a non-empty directory name, the file to be loaded must be located in that directory.

Using `LOCAL` is a bit slower than letting the server access the files directly, because the contents of the file must be sent over the

connection by the client to the server. On the other hand, you do not need the `FILE` privilege to load local files.

With `LOCAL`, the default behavior is the same as if `IGNORE` is specified; this is because the server has no way to stop transmission of the file in the middle of the operation. `IGNORE` is explained further later in this section.

`LOCAL` works only if your server and your client both have been enabled to allow it. For example, if `mysqld` was started with `--local-infile=0`, `LOCAL` does not work. See [Section 5.3.4, “Security Issues with `LOAD DATA LOCAL`”](#).

On Unix, if you need `LOAD DATA` to read from a pipe, you can use the following technique (here we load the listing of the `/` directory into a table):

```
mkfifo /mysql/db/x/x
chmod 666 /mysql/db/x/x
find / -ls > /mysql/db/x/x &
mysql -e "LOAD DATA INFILE 'x' INTO TABLE x" x
```

Note that you must run the command that generates the data to be loaded and the `mysql` commands either on separate terminals, or run the data generation process in the background (as shown in the preceding example). If you do not do this, the pipe will block until data is read by the `mysql` process.

The `REPLACE` and `IGNORE` keywords control handling of input rows that duplicate existing rows on unique key values:

- If you specify `REPLACE`, input rows replace existing rows. In other words, rows that have the same value for a primary key or unique index as an existing row. See [Section 12.2.7, “`REPLACE` Syntax”](#).
- If you specify `IGNORE`, input rows that duplicate an existing row on a unique key value are skipped. If you do not specify either option, the behavior depends on whether the `LOCAL` keyword is specified. Without `LOCAL`, an error occurs when a duplicate key value is found, and the rest of the text file is ignored. With `LOCAL`, the default behavior is the same as if `IGNORE` is specified; this is because the server has no way to stop transmission of the file in the middle of the operation.

If you want to ignore foreign key constraints during the load operation, you can issue a `SET foreign_key_checks = 0` statement before executing `LOAD DATA`.

If you use `LOAD DATA INFILE` on an empty `MyISAM` table, all non-unique indexes are created in a separate batch (as for `REPAIR TABLE`). Normally, this makes `LOAD DATA INFILE` much faster when you have many indexes. In some extreme cases, you can create the indexes even faster by turning them off with `ALTER TABLE ... DISABLE KEYS` before loading the file into the table and using `ALTER TABLE ... ENABLE KEYS` to re-create the indexes after loading the file. See [Section 7.2.21, “Speed of `INSERT` Statements”](#).

For both the `LOAD DATA INFILE` and `SELECT ... INTO OUTFILE` statements, the syntax of the `FIELDS` and `LINES` clauses is the same. Both clauses are optional, but `FIELDS` must precede `LINES` if both are specified.

If you specify a `FIELDS` clause, each of its subclauses (`TERMINATED BY`, `[OPTIONALLY] ENCLOSED BY`, and `ESCAPED BY`) is also optional, except that you must specify at least one of them.

If you specify no `FIELDS` clause, the defaults are the same as if you had written this:

```
FIELDS TERMINATED BY '\t' ENCLOSED BY '' ESCAPED BY '\\'
```

If you specify no `LINES` clause, the defaults are the same as if you had written this:

```
LINES TERMINATED BY '\n' STARTING BY ''
```

In other words, the defaults cause `LOAD DATA INFILE` to act as follows when reading input:

- Look for line boundaries at newlines.
- Do not skip over any line prefix.
- Break lines into fields at tabs.
- Do not expect fields to be enclosed within any quoting characters.
- Interpret occurrences of tab, newline, or “\” preceded by “\” as literal characters that are part of field values.

Conversely, the defaults cause `SELECT ... INTO OUTFILE` to act as follows when writing output:

- Write tabs between fields.
- Do not enclose fields within any quoting characters.
- Use “\” to escape instances of tab, newline, or “\” that occur within field values.
- Write newlines at the ends of lines.

Backslash is the MySQL escape character within strings, so to write `FIELDS ESCAPED BY '\\'`, you must specify two backslashes for the value to be interpreted as a single backslash.

### Note

If you have generated the text file on a Windows system, you might have to use `LINES TERMINATED BY '\r\n'` to read the file properly, because Windows programs typically use two characters as a line terminator. Some programs, such as `WordPad`, might use `\r` as a line terminator when writing files. To read such files, use `LINES TERMINATED BY '\r'`.

If all the lines you want to read in have a common prefix that you want to ignore, you can use `LINES STARTING BY 'prefix_string'` to skip over the prefix, *and anything before it*. If a line does not include the prefix, the entire line is skipped. Suppose that you issue the following statement:

```
LOAD DATA INFILE '/tmp/test.txt' INTO TABLE test
  FIELDS TERMINATED BY ',' LINES STARTING BY 'xxx';
```

If the data file looks like this:

```
xxx"abc",1
something xxx"def",2
"ghi",3
```

The resulting rows will be (`"abc",1`) and (`"def",2`). The third row in the file is skipped because it does not contain the prefix.

The `IGNORE number LINES` option can be used to ignore lines at the start of the file. For example, you can use `IGNORE 1 LINES` to skip over an initial header line containing column names:

```
LOAD DATA INFILE '/tmp/test.txt' INTO TABLE test IGNORE 1 LINES;
```

When you use `SELECT ... INTO OUTFILE` in tandem with `LOAD DATA INFILE` to write data from a database into a file and then read the file back into the database later, the field- and line-handling options for both statements must match. Otherwise, `LOAD DATA INFILE` will not interpret the contents of the file properly. Suppose that you use `SELECT ... INTO OUTFILE` to write a file with fields delimited by commas:

```
SELECT * INTO OUTFILE 'data.txt'
  FIELDS TERMINATED BY ','
  FROM table2;
```

To read the comma-delimited file back in, the correct statement would be:

```
LOAD DATA INFILE 'data.txt' INTO TABLE table2
  FIELDS TERMINATED BY ',';
```

If instead you tried to read in the file with the statement shown following, it wouldn't work because it instructs `LOAD DATA INFILE` to look for tabs between fields:

```
LOAD DATA INFILE 'data.txt' INTO TABLE table2
  FIELDS TERMINATED BY '\t';
```

The likely result is that each input line would be interpreted as a single field.

`LOAD DATA INFILE` can be used to read files obtained from external sources. For example, many programs can export data in comma-separated values (CSV) format, such that lines have fields separated by commas and enclosed within double quotes. If lines in such a file are terminated by newlines, the statement shown here illustrates the field- and line-handling options you would use to load the file:

```
LOAD DATA INFILE 'data.txt' INTO TABLE tbl_name
  FIELDS TERMINATED BY ',' ENCLOSED BY '"'
  LINES TERMINATED BY '\n';
```

If the input values are not necessarily enclosed within quotes, use `OPTIONALLY` before the `ENCLOSED BY` keywords.

Any of the field- or line-handling options can specify an empty string ( `' '` ). If not empty, the `FIELDS [OPTIONALLY] ENCLOSED BY` and `FIELDS ESCAPED BY` values must be a single character. The `FIELDS TERMINATED BY`, `LINES STARTING BY`, and `LINES TERMINATED BY` values can be more than one character. For example, to write lines that are terminated by carriage return/linefeed pairs, or to read a file containing such lines, specify a `LINES TERMINATED BY '\r\n'` clause.

To read a file containing jokes that are separated by lines consisting of `%%`, you can do this

```
CREATE TABLE jokes
  (a INT NOT NULL AUTO_INCREMENT PRIMARY KEY,
  joke TEXT NOT NULL);
LOAD DATA INFILE '/tmp/jokes.txt' INTO TABLE jokes
  FIELDS TERMINATED BY ''
  LINES TERMINATED BY '\n%%\n' (joke);
```

`FIELDS [OPTIONALLY] ENCLOSED BY` controls quoting of fields. For output (`SELECT ... INTO OUTFILE`), if you omit the word `OPTIONALLY`, all fields are enclosed by the `ENCLOSED BY` character. An example of such output (using a comma as the field delimiter) is shown here:

```
"1","a string",100.20"
"2","a string containing a , comma",102.20"
"3","a string containing a \" quote",102.20"
"4","a string containing a \", quote and comma",102.20"
```

If you specify `OPTIONALLY`, the `ENCLOSED BY` character is used only to enclose values from columns that have a string data type (such as `CHAR`, `BINARY`, `TEXT`, or `ENUM`):

```
1,"a string",100.20
2,"a string containing a , comma",102.20
3,"a string containing a \" quote",102.20
4,"a string containing a \", quote and comma",102.20
```

Note that occurrences of the `ENCLOSED BY` character within a field value are escaped by prefixing them with the `ESCAPED BY` character. Also note that if you specify an empty `ESCAPED BY` value, it is possible to inadvertently generate output that cannot be read properly by `LOAD DATA INFILE`. For example, the preceding output just shown would appear as follows if the escape character is empty. Observe that the second field in the fourth line contains a comma following the quote, which (erroneously) appears to terminate the field:

```
1,"a string",100.20
2,"a string containing a , comma",102.20
3,"a string containing a " quote",102.20
4,"a string containing a ", quote and comma",102.20
```

For input, the `ENCLOSED BY` character, if present, is stripped from the ends of field values. (This is true regardless of whether `OPTIONALLY` is specified; `OPTIONALLY` has no effect on input interpretation.) Occurrences of the `ENCLOSED BY` character preceded by the `ESCAPED BY` character are interpreted as part of the current field value.

If the field begins with the `ENCLOSED BY` character, instances of that character are recognized as terminating a field value only if followed by the field or line `TERMINATED BY` sequence. To avoid ambiguity, occurrences of the `ENCLOSED BY` character within a field value can be doubled and are interpreted as a single instance of the character. For example, if `ENCLOSED BY ''` is specified, quotes are handled as shown here:

```
"The ""BIG"" boss" -> The "BIG" boss
The "BIG" boss    -> The "BIG" boss
The ""BIG"" boss  -> The "BIG" boss
```

`FIELDS ESCAPED BY` controls how to write or read special characters. If the `FIELDS ESCAPED BY` character is not empty, it is used to prefix the following characters on output:

- The `FIELDS ESCAPED BY` character
- The `FIELDS [OPTIONALLY] ENCLOSED BY` character
- The first character of the `FIELDS TERMINATED BY` and `LINES TERMINATED BY` values
- ASCII 0 (what is actually written following the escape character is ASCII “0”, not a zero-valued byte)

If the `FIELDS ESCAPED BY` character is empty, no characters are escaped and `NULL` is output as `NULL`, not `\N`. It is probably not a good idea to specify an empty escape character, particularly if field values in your data contain any of the characters in the list

just given.

For input, if the `FIELDS ESCAPED BY` character is not empty, occurrences of that character are stripped and the following character is taken literally as part of a field value. Some two-character sequences that are exceptions, where the first character is the escape character. These sequences are shown in the following table (using “\” for the escape character). The rules for `NULL` handling are described later in this section.

<code>\0</code>	An ASCII NUL (0x00) character
<code>\b</code>	A backspace character
<code>\n</code>	A newline (linefeed) character
<code>\r</code>	A carriage return character
<code>\t</code>	A tab character.
<code>\z</code>	ASCII 26 (Control-Z)
<code>\N</code>	NULL

For more information about “\”-escape syntax, see [Section 8.1, “Literal Values”](#).

In certain cases, field- and line-handling options interact:

- If `LINES TERMINATED BY` is an empty string and `FIELDS TERMINATED BY` is non-empty, lines are also terminated with `FIELDS TERMINATED BY`.
- If the `FIELDS TERMINATED BY` and `FIELDS ENCLOSED BY` values are both empty (‘ ’), a fixed-row (non-delimited) format is used. With fixed-row format, no delimiters are used between fields (but you can still have a line terminator). Instead, column values are read and written using a field width wide enough to hold all values in the field. For `TINYINT`, `SMALLINT`, `MEDIUMINT`, `INT`, and `BIGINT`, the field widths are 4, 6, 8, 11, and 20, respectively, no matter what the declared display width is.

`LINES TERMINATED BY` is still used to separate lines. If a line does not contain all fields, the rest of the columns are set to their default values. If you do not have a line terminator, you should set this to ‘ ’. In this case, the text file must contain all fields for each row.

Fixed-row format also affects handling of `NULL` values, as described later. Note that fixed-size format does not work if you are using a multi-byte character set.

Handling of `NULL` values varies according to the `FIELDS` and `LINES` options in use:

- For the default `FIELDS` and `LINES` values, `NULL` is written as a field value of `\N` for output, and a field value of `\N` is read as `NULL` for input (assuming that the `ESCAPED BY` character is “\”).
- If `FIELDS ENCLOSED BY` is not empty, a field containing the literal word `NULL` as its value is read as a `NULL` value. This differs from the word `NULL` enclosed within `FIELDS ENCLOSED BY` characters, which is read as the string ‘NULL’.
- If `FIELDS ESCAPED BY` is empty, `NULL` is written as the word `NULL`.
- With fixed-row format (which is used when `FIELDS TERMINATED BY` and `FIELDS ENCLOSED BY` are both empty), `NULL` is written as an empty string. Note that this causes both `NULL` values and empty strings in the table to be indistinguishable when written to the file because both are written as empty strings. If you need to be able to tell the two apart when reading the file back in, you should not use fixed-row format.

An attempt to load `NULL` into a `NOT NULL` column causes assignment of the implicit default value for the column’s data type and a warning, or an error in strict SQL mode. Implicit default values are discussed in [Section 10.1.4, “Data Type Default Values”](#).

Some cases are not supported by `LOAD DATA INFILE`:

- Fixed-size rows (`FIELDS TERMINATED BY` and `FIELDS ENCLOSED BY` both empty) and `BLOB` or `TEXT` columns.
- If you specify one separator that is the same as or a prefix of another, `LOAD DATA INFILE` cannot interpret the input properly. For example, the following `FIELDS` clause would cause problems:

```
FIELDS TERMINATED BY ' ' ENCLOSED BY ' '
```

- If `FIELDS ESCAPED BY` is empty, a field value that contains an occurrence of `FIELDS ENCLOSED BY` or `LINES TER-`

`MINATED BY` followed by the `FIELDS TERMINATED BY` value causes `LOAD DATA INFILE` to stop reading a field or line too early. This happens because `LOAD DATA INFILE` cannot properly determine where the field or line value ends.

The following example loads all columns of the `persondata` table:

```
LOAD DATA INFILE 'persondata.txt' INTO TABLE persondata;
```

By default, when no column list is provided at the end of the `LOAD DATA INFILE` statement, input lines are expected to contain a field for each table column. If you want to load only some of a table's columns, specify a column list:

```
LOAD DATA INFILE 'persondata.txt' INTO TABLE persondata (col1,col2,...);
```

You must also specify a column list if the order of the fields in the input file differs from the order of the columns in the table. Otherwise, MySQL cannot tell how to match input fields with table columns.

The column list can contain either column names or user variables. With user variables, the `SET` clause enables you to perform transformations on their values before assigning the result to columns.

User variables in the `SET` clause can be used in several ways. The following example uses the first input column directly for the value of `t1.column1`, and assigns the second input column to a user variable that is subjected to a division operation before being used for the value of `t1.column2`:

```
LOAD DATA INFILE 'file.txt'
  INTO TABLE t1
  (column1, @var1)
  SET column2 = @var1/100;
```

The `SET` clause can be used to supply values not derived from the input file. The following statement sets `column3` to the current date and time:

```
LOAD DATA INFILE 'file.txt'
  INTO TABLE t1
  (column1, column2)
  SET column3 = CURRENT_TIMESTAMP;
```

You can also discard an input value by assigning it to a user variable and not assigning the variable to a table column:

```
LOAD DATA INFILE 'file.txt'
  INTO TABLE t1
  (column1, @dummy, column2, @dummy, column3);
```

Use of the column/variable list and `SET` clause is subject to the following restrictions:

- Assignments in the `SET` clause should have only column names on the left hand side of assignment operators.
- You can use subqueries in the right hand side of `SET` assignments. A subquery that returns a value to be assigned to a column may be a scalar subquery only. Also, you cannot use a subquery to select from the table that is being loaded.
- Lines ignored by an `IGNORE` clause are not processed for the column/variable list or `SET` clause.
- User variables cannot be used when loading data with fixed-row format because user variables do not have a display width.

When processing an input line, `LOAD DATA` splits it into fields and uses the values according to the column/variable list and the `SET` clause, if they are present. Then the resulting row is inserted into the table. If there are `BEFORE INSERT` or `AFTER INSERT` triggers for the table, they are activated before or after inserting the row, respectively.

If an input line has too many fields, the extra fields are ignored and the number of warnings is incremented.

If an input line has too few fields, the table columns for which input fields are missing are set to their default values. Default value assignment is described in [Section 10.1.4, “Data Type Default Values”](#).

An empty field value is interpreted differently than if the field value is missing:

- For string types, the column is set to the empty string.
- For numeric types, the column is set to 0.

- For date and time types, the column is set to the appropriate “zero” value for the type. See [Section 10.3, “Date and Time Types”](#).

These are the same values that result if you assign an empty string explicitly to a string, numeric, or date or time type explicitly in an `INSERT` or `UPDATE` statement.

`TIMESTAMP` columns are set to the current date and time only if there is a `NULL` value for the column (that is, `\N`) and the column is not declared to allow `NULL` values, or if the `TIMESTAMP` column's default value is the current timestamp and it is omitted from the field list when a field list is specified.

`LOAD DATA INFILE` regards all input as strings, so you cannot use numeric values for `ENUM` or `SET` columns the way you can with `INSERT` statements. All `ENUM` and `SET` values must be specified as strings.

`BIT` values cannot be loaded using binary notation (for example, `b'011010'`). To work around this, specify the values as regular integers and use the `SET` clause to convert them so that MySQL performs a numeric type conversion and loads them into the `BIT` column properly:

```
shell> cat /tmp/bit_test.txt
2
127
shell> mysql test
mysql> LOAD DATA INFILE '/tmp/bit_test.txt'
-> INTO TABLE bit_test (@var1) SET b= CAST(@var1 AS UNSIGNED);
Query OK, 2 rows affected (0.00 sec)
Records: 2 Deleted: 0 Skipped: 0 Warnings: 0

mysql> SELECT BIN(b+0) FROM bit_test;
+-----+
| bin(b+0) |
+-----+
| 10      |
| 1111111 |
+-----+
2 rows in set (0.00 sec)
```

When the `LOAD DATA INFILE` statement finishes, it returns an information string in the following format:

```
Records: 1 Deleted: 0 Skipped: 0 Warnings: 0
```

If you are using the C API, you can get information about the statement by calling the `mysql_info()` function. See [Section 20.10.3.35, “mysql\\_info\(\)”](#).

Warnings occur under the same circumstances as when values are inserted via the `INSERT` statement (see [Section 12.2.5, “INSERT Syntax”](#)), except that `LOAD DATA INFILE` also generates warnings when there are too few or too many fields in the input row. The warnings are not stored anywhere; the number of warnings can be used only as an indication of whether everything went well.

You can use `SHOW WARNINGS` to get a list of the first `max_error_count` warnings as information about what went wrong. See [Section 12.5.5.42, “SHOW WARNINGS Syntax”](#).

## 12.2.7. REPLACE Syntax

```
REPLACE [LOW_PRIORITY | DELAYED]
[INTO] tbl_name [(col_name,...)]
{VALUES | VALUE} ({expr | DEFAULT},...),(...),...
```

Or:

```
REPLACE [LOW_PRIORITY | DELAYED]
[INTO] tbl_name
SET col_name={expr | DEFAULT}, ...
```

Or:

```
REPLACE [LOW_PRIORITY | DELAYED]
[INTO] tbl_name [(col_name,...)]
SELECT ...
```

`REPLACE` works exactly like `INSERT`, except that if an old row in the table has the same value as a new row for a `PRIMARY KEY` or a `UNIQUE` index, the old row is deleted before the new row is inserted. See [Section 12.2.5, “INSERT Syntax”](#).

`REPLACE` is a MySQL extension to the SQL standard. It either inserts, or *deletes* and inserts. For another MySQL extension to standard SQL — that either inserts or *updates* — see [Section 12.2.5.3, “INSERT ... ON DUPLICATE KEY UPDATE”](#)



Note that unless the table has a [PRIMARY KEY](#) or [UNIQUE](#) index, using a [REPLACE](#) statement makes no sense. It becomes equivalent to [INSERT](#), because there is no index to be used to determine whether a new row duplicates another.

Values for all columns are taken from the values specified in the [REPLACE](#) statement. Any missing columns are set to their default values, just as happens for [INSERT](#). You cannot refer to values from the current row and use them in the new row. If you use an assignment such as `SET col_name = col_name + 1`, the reference to the column name on the right hand side is treated as `DEFAULT(col_name)`, so the assignment is equivalent to `SET col_name = DEFAULT(col_name) + 1`.

To use [REPLACE](#), you must have both the [INSERT](#) and [DELETE](#) privileges for the table.

The [REPLACE](#) statement returns a count to indicate the number of rows affected. This is the sum of the rows deleted and inserted. If the count is 1 for a single-row [REPLACE](#), a row was inserted and no rows were deleted. If the count is greater than 1, one or more old rows were deleted before the new row was inserted. It is possible for a single row to replace more than one old row if the table contains multiple unique indexes and the new row duplicates values for different old rows in different unique indexes.

The affected-rows count makes it easy to determine whether [REPLACE](#) only added a row or whether it also replaced any rows: Check whether the count is 1 (added) or greater (replaced).

If you are using the C API, the affected-rows count can be obtained using the `mysql_affected_rows()` function.

Currently, you cannot replace into a table and select from the same table in a subquery.

MySQL uses the following algorithm for [REPLACE](#) (and `LOAD DATA ... REPLACE`):

1. Try to insert the new row into the table
2. While the insertion fails because a duplicate-key error occurs for a primary key or unique index:
  - a. Delete from the table the conflicting row that has the duplicate key value
  - b. Try again to insert the new row into the table

## 12.2.8. SELECT Syntax

```
SELECT
  [ALL | DISTINCT | DISTINCTROW ]
  [HIGH_PRIORITY]
  [STRAIGHT_JOIN]
  [SQL_SMALL_RESULT] [SQL_BIG_RESULT] [SQL_BUFFER_RESULT]
  [SQL_CACHE | SQL_NO_CACHE] [SQL_CALC_FOUND_ROWS]
  select_expr [, select_expr ...]
  [FROM table_references]
  [WHERE where_condition]
  [GROUP BY {col_name | expr | position}
  [ASC | DESC], ... [WITH ROLLUP]]
  [HAVING where_condition]
  [ORDER BY {col_name | expr | position}
  [ASC | DESC], ...]
  [LIMIT {[offset,] row_count | row_count OFFSET offset}]
  [PROCEDURE procedure_name(argument_list)]
  [INTO OUTFILE 'file_name' export_options
  | INTO DUMPFILE 'file_name'
  | INTO var_name [, var_name]]
  [FOR UPDATE | LOCK IN SHARE MODE]
```

[SELECT](#) is used to retrieve rows selected from one or more tables, and can include [UNION](#) statements and subqueries. See [Section 12.2.8.3, “UNION Syntax”](#), and [Section 12.2.9, “Subquery Syntax”](#).

The most commonly used clauses of [SELECT](#) statements are these:

- Each `select_expr` indicates a column that you want to retrieve. There must be at least one `select_expr`.
- `table_references` indicates the table or tables from which to retrieve rows. Its syntax is described in [Section 12.2.8.1, “JOIN Syntax”](#).
- The [WHERE](#) clause, if given, indicates the condition or conditions that rows must satisfy to be selected. `where_condition` is an expression that evaluates to true for each row to be selected. The statement selects all rows if there is no [WHERE](#) clause.

In the [WHERE](#) clause, you can use any of the functions and operators that MySQL supports, except for aggregate (summary) functions. See [Chapter 11, Functions and Operators](#).



`SELECT` can also be used to retrieve rows computed without reference to any table.

For example:

```
mysql> SELECT 1 + 1;
-> 2
```

You are allowed to specify `DUAL` as a dummy table name in situations where no tables are referenced:

```
mysql> SELECT 1 + 1 FROM DUAL;
-> 2
```

`DUAL` is purely for the convenience of people who require that all `SELECT` statements should have `FROM` and possibly other clauses. MySQL may ignore the clauses. MySQL does not require `FROM DUAL` if no tables are referenced.

In general, clauses used must be given in exactly the order shown in the syntax description. For example, a `HAVING` clause must come after any `GROUP BY` clause and before any `ORDER BY` clause. The exception is that the `INTO` clause can appear either as shown in the syntax description or immediately following the `select_expr` list.

The list of `select_expr` terms comprises the select list that indicates which columns to retrieve. Terms specify a column or expression or can use `*`-shorthand:

- A select list consisting only of a single unqualified `*` can be used as shorthand to select all columns from all tables:

```
SELECT * FROM t1 INNER JOIN t2 ...
```

- `tbl_name.*` can be used as a qualified shorthand to select all columns from the named table:

```
SELECT t1.*, t2.* FROM t1 INNER JOIN t2 ...
```

- Use of an unqualified `*` with other items in the select list may produce a parse error. To avoid this problem, use a qualified `tbl_name.*` reference

```
SELECT AVG(score), t1.* FROM t1 ...
```

The following list provides additional information about other `SELECT` clauses:

- A `select_expr` can be given an alias using `AS alias_name`. The alias is used as the expression's column name and can be used in `GROUP BY`, `ORDER BY`, or `HAVING` clauses. For example:

```
SELECT CONCAT(last_name,', ',first_name) AS full_name
FROM mytable ORDER BY full_name;
```

The `AS` keyword is optional when aliasing a `select_expr`. The preceding example could have been written like this:

```
SELECT CONCAT(last_name,', ',first_name) full_name
FROM mytable ORDER BY full_name;
```

However, because the `AS` is optional, a subtle problem can occur if you forget the comma between two `select_expr` expressions: MySQL interprets the second as an alias name. For example, in the following statement, `columnb` is treated as an alias name:

```
SELECT columna columnb FROM mytable;
```

For this reason, it is good practice to be in the habit of using `AS` explicitly when specifying column aliases.

It is not allowable to refer to a column alias in a `WHERE` clause, because the column value might not yet be determined when the `WHERE` clause is executed. See [Section B.1.5.4, “Problems with Column Aliases”](#).

- The `FROM table_references` clause indicates the table or tables from which to retrieve rows. If you name more than one table, you are performing a join. For information on join syntax, see [Section 12.2.8.1, “JOIN Syntax”](#). For each table specified, you can optionally specify an alias.

```
tbl_name [[AS] alias] [index_hint]
```

The use of index hints provides the optimizer with information about how to choose indexes during query processing. For a description of the syntax for specifying these hints, see [Section 12.2.8.2, “Index Hint Syntax”](#).

You can use `SET max_seeks_for_key=value` as an alternative way to force MySQL to prefer key scans instead of table scans. See [Section 5.1.3, “Server System Variables”](#).

- You can refer to a table within the default database as `tbl_name`, or as `db_name.tbl_name` to specify a database explicitly. You can refer to a column as `col_name`, `tbl_name.col_name`, or `db_name.tbl_name.col_name`. You need not specify a `tbl_name` or `db_name.tbl_name` prefix for a column reference unless the reference would be ambiguous. See [Section 8.2.1, “Identifier Qualifiers”](#), for examples of ambiguity that require the more explicit column reference forms.
- A table reference can be aliased using `tbl_name AS alias_name` or `tbl_name alias_name`:

```
SELECT t1.name, t2.salary FROM employee AS t1, info AS t2
WHERE t1.name = t2.name;

SELECT t1.name, t2.salary FROM employee t1, info t2
WHERE t1.name = t2.name;
```

- Columns selected for output can be referred to in `ORDER BY` and `GROUP BY` clauses using column names, column aliases, or column positions. Column positions are integers and begin with 1:

```
SELECT college, region, seed FROM tournament
ORDER BY region, seed;

SELECT college, region AS r, seed AS s FROM tournament
ORDER BY r, s;

SELECT college, region, seed FROM tournament
ORDER BY 2, 3;
```

To sort in reverse order, add the `DESC` (descending) keyword to the name of the column in the `ORDER BY` clause that you are sorting by. The default is ascending order; this can be specified explicitly using the `ASC` keyword.

If `ORDER BY` occurs within a subquery and also is applied in the outer query, the outermost `ORDER BY` takes precedence. For example, results for the following statement are sorted in descending order, not ascending order:

```
(SELECT ... ORDER BY a) ORDER BY a DESC;
```

Use of column positions is deprecated because the syntax has been removed from the SQL standard.

- If you use `GROUP BY`, output rows are sorted according to the `GROUP BY` columns as if you had an `ORDER BY` for the same columns. To avoid the overhead of sorting that `GROUP BY` produces, add `ORDER BY NULL`:

```
SELECT a, COUNT(b) FROM test_table GROUP BY a ORDER BY NULL;
```

- MySQL extends the `GROUP BY` clause so that you can also specify `ASC` and `DESC` after columns named in the clause:

```
SELECT a, COUNT(b) FROM test_table GROUP BY a DESC;
```

- MySQL extends the use of `GROUP BY` to allow selecting fields that are not mentioned in the `GROUP BY` clause. If you are not getting the results that you expect from your query, please read the description of `GROUP BY` found in [Section 11.12, “Functions and Modifiers for Use with GROUP BY Clauses”](#).
- `GROUP BY` allows a `WITH ROLLUP` modifier. See [Section 11.12.2, “GROUP BY Modifiers”](#).
- The `HAVING` clause is applied nearly last, just before items are sent to the client, with no optimization. (`LIMIT` is applied after `HAVING`.)

The SQL standard requires that `HAVING` must reference only columns in the `GROUP BY` clause or columns used in aggregate functions. However, MySQL supports an extension to this behavior, and allows `HAVING` to refer to columns in the `SELECT` list and columns in outer subqueries as well.

If the `HAVING` clause refers to a column that is ambiguous, a warning occurs. In the following statement, `col2` is ambiguous because it is used as both an alias and a column name:

```
SELECT COUNT(col1) AS col2 FROM t GROUP BY col2 HAVING col2 = 2;
```

Preference is given to standard SQL behavior, so if a `HAVING` column name is used both in `GROUP BY` and as an aliased column in the output column list, preference is given to the column in the `GROUP BY` column.

- Do not use `HAVING` for items that should be in the `WHERE` clause. For example, do not write the following:

```
SELECT col_name FROM tbl_name HAVING col_name > 0;
```

Write this instead:

```
SELECT col_name FROM tbl_name WHERE col_name > 0;
```

- The `HAVING` clause can refer to aggregate functions, which the `WHERE` clause cannot:

```
SELECT user, MAX(salary) FROM users
GROUP BY user HAVING MAX(salary) > 10;
```

(This did not work in some older versions of MySQL.)

- MySQL allows duplicate column names. That is, there can be more than one `select_expr` with the same name. This is an extension to standard SQL. Because MySQL also allows `GROUP BY` and `HAVING` to refer to `select_expr` values, this can result in an ambiguity:

```
SELECT 12 AS a, a FROM t GROUP BY a;
```

In that statement, both columns have the name `a`. To ensure that the correct column is used for grouping, use different names for each `select_expr`.

- MySQL resolves unqualified column or alias references in `ORDER BY` clauses by searching in the `select_expr` values, then in the columns of the tables in the `FROM` clause. For `GROUP BY` or `HAVING` clauses, it searches the `FROM` clause before searching in the `select_expr` values. (For `GROUP BY` and `HAVING`, this differs from the pre-MySQL 5.0 behavior that used the same rules as for `ORDER BY`.)
- The `LIMIT` clause can be used to constrain the number of rows returned by the `SELECT` statement. `LIMIT` takes one or two numeric arguments, which must both be non-negative integer constants (except when using prepared statements).

With two arguments, the first argument specifies the offset of the first row to return, and the second specifies the maximum number of rows to return. The offset of the initial row is 0 (not 1):

```
SELECT * FROM tbl LIMIT 5,10; # Retrieve rows 6-15
```

To retrieve all rows from a certain offset up to the end of the result set, you can use some large number for the second parameter. This statement retrieves all rows from the 96th row to the last:

```
SELECT * FROM tbl LIMIT 95,18446744073709551615;
```

With one argument, the value specifies the number of rows to return from the beginning of the result set:

```
SELECT * FROM tbl LIMIT 5; # Retrieve first 5 rows
```

In other words, `LIMIT row_count` is equivalent to `LIMIT 0, row_count`.

For prepared statements, you can use placeholders. The following statements will return one row from the `tbl` table:

```
SET @a=1;
PREPARE STMT FROM 'SELECT * FROM tbl LIMIT ?';
EXECUTE STMT USING @a;
```

The following statements will return the second to sixth row from the `tbl` table:

```
SET @skip=1; SET @numrows=5;
PREPARE STMT FROM 'SELECT * FROM tbl LIMIT ?, ?';
EXECUTE STMT USING @skip, @numrows;
```

For compatibility with PostgreSQL, MySQL also supports the `LIMIT row_count OFFSET offset` syntax.

If `LIMIT` occurs within a subquery and also is applied in the outer query, the outermost `LIMIT` takes precedence. For example, the following statement produces two rows, not one:

```
(SELECT ... LIMIT 1) LIMIT 2;
```

- A `PROCEDURE` clause names a procedure that should process the data in the result set. For an example, see [Section 21.4.1](#),

PROCEDURE ANALYSE”.

- The `SELECT ... INTO OUTFILE 'file_name'` form of `SELECT` writes the selected rows to a file. The file is created on the server host, so you must have the `FILE` privilege to use this syntax. `file_name` cannot be an existing file, which among other things prevents files such as `/etc/passwd` and database tables from being destroyed. As of MySQL 5.1.6, the `character_set_filesystem` system variable controls the interpretation of the file name.

The `SELECT ... INTO OUTFILE` statement is intended primarily to let you very quickly dump a table to a text file on the server machine. If you want to create the resulting file on some client host other than the server host, you cannot use `SELECT ... INTO OUTFILE`. In that case, you should instead use a command such as `mysql -e "SELECT ..." > file_name` to generate the file on the client host.

`SELECT ... INTO OUTFILE` is the complement of `LOAD DATA INFILE`; the syntax for the `export_options` part of the statement consists of the same `FIELDS` and `LINES` clauses that are used with the `LOAD DATA INFILE` statement. See [Section 12.2.6, “LOAD DATA INFILE Syntax”](#).

Column values are dumped using the `binary` character set. In effect, there is no character set conversion. If a table contains columns in several character sets, the output data file will as well and you may not be able to reload the file correctly.

`FIELDS ESCAPED BY` controls how to write special characters. If the `FIELDS ESCAPED BY` character is not empty, it is used as a prefix that precedes following characters on output:

- The `FIELDS ESCAPED BY` character
- The `FIELDS [OPTIONALLY] ENCLOSED BY` character
- The first character of the `FIELDS TERMINATED BY` and `LINES TERMINATED BY` values
- ASCII `NUL` (the zero-valued byte; what is actually written following the escape character is ASCII “0”, not a zero-valued byte)

The `FIELDS TERMINATED BY`, `ENCLOSED BY`, `ESCAPED BY`, or `LINES TERMINATED BY` characters *must* be escaped so that you can read the file back in reliably. ASCII `NUL` is escaped to make it easier to view with some paggers.

The resulting file does not have to conform to SQL syntax, so nothing else need be escaped.

If the `FIELDS ESCAPED BY` character is empty, no characters are escaped and `NULL` is output as `NULL`, not `\N`. It is probably not a good idea to specify an empty escape character, particularly if field values in your data contain any of the characters in the list just given.

Here is an example that produces a file in the comma-separated values (CSV) format used by many programs:

```
SELECT a,b,a+b INTO OUTFILE '/tmp/result.txt'
  FIELDS TERMINATED BY ',' OPTIONALLY ENCLOSED BY '"'
  LINES TERMINATED BY '\n'
FROM test_table;
```

- If you use `INTO DUMPFILE` instead of `INTO OUTFILE`, MySQL writes only one row into the file, without any column or line termination and without performing any escape processing. This is useful if you want to store a `BLOB` value in a file.

### Note

Any file created by `INTO OUTFILE` or `INTO DUMPFILE` is writable by all users on the server host. The reason for this is that the MySQL server cannot create a file that is owned by anyone other than the user under whose account it is running. (You should *never* run `mysqld` as `root` for this and other reasons.) The file thus must be world-writable so that you can manipulate its contents.

If the `secure_file_priv` system variable is set to a non-empty directory name, the file to be written must be located in that directory.

- The `INTO` clause can name a list of one or more variables, which can be user-defined variables, or parameters or local variables within a stored function or procedure body (see [Section 12.8.3.3, “SELECT ... INTO Statement”](#)). The selected values are assigned to the variables. The number of variables must match the number of columns. The query should return a single row. If the query returns no rows, a warning with error code 1329 occurs (`No data`), and the variable values remain unchanged. If the query returns multiple rows, error 1172 occurs (`Result consisted of more than one row`). If it is possible that the statement may retrieve multiple rows, you can use `LIMIT 1` to limit the result set to a single row.

In the context of such statements that occur as part of events executed by the Event Scheduler, diagnostics messages (not only errors, but also warnings) are written to the error log, and, on Windows, to the application event log. For additional information, see [Section 18.4.5, “Event Scheduler Status”](#).

- The `SELECT` syntax description at the beginning this section shows the `INTO` clause near the end of the statement. It is also possible to use `INTO` immediately following the `select_expr` list.
- An `INTO` clause should not be used in a nested `SELECT` because such a `SELECT` must return its result to the outer context.
- If you use `FOR UPDATE` with a storage engine that uses page or row locks, rows examined by the query are write-locked until the end of the current transaction. Using `LOCK IN SHARE MODE` sets a shared lock that allows other transactions to read the examined rows but not to update or delete them. See [Section 13.6.8.3, “SELECT ... FOR UPDATE and SELECT ... LOCK IN SHARE MODE Locking Reads”](#).

Following the `SELECT` keyword, you can use a number of options that affect the operation of the statement.

The `ALL`, `DISTINCT`, and `DISTINCTROW` options specify whether duplicate rows should be returned. If none of these options are given, the default is `ALL` (all matching rows are returned). `DISTINCT` and `DISTINCTROW` are synonyms and specify removal of duplicate rows from the result set.

`HIGH_PRIORITY`, `STRAIGHT_JOIN`, and options beginning with `SQL_` are MySQL extensions to standard SQL.

- `HIGH_PRIORITY` gives the `SELECT` higher priority than a statement that updates a table. You should use this only for queries that are very fast and must be done at once. A `SELECT HIGH_PRIORITY` query that is issued while the table is locked for reading runs even if there is an update statement waiting for the table to be free. This affects only storage engines that use only table-level locking (`MyISAM`, `MEMORY`, `MERGE`).

`HIGH_PRIORITY` cannot be used with `SELECT` statements that are part of a `UNION`.

- `STRAIGHT_JOIN` forces the optimizer to join the tables in the order in which they are listed in the `FROM` clause. You can use this to speed up a query if the optimizer joins the tables in non-optimal order. `STRAIGHT_JOIN` also can be used in the `table_references` list. See [Section 12.2.8.1, “JOIN Syntax”](#).

`STRAIGHT_JOIN` does not apply to any table that the optimizer treats as a `const` or `system` table. Such a table produces a single row, is read during the optimization phase of query execution, and references to its columns are replaced with the appropriate column values before query execution proceeds. These tables will appear first in the query plan displayed by `EXPLAIN`. See [Section 7.2.1, “Optimizing Queries with EXPLAIN”](#). This exception may not apply to `const` or `system` tables that are used on the `NULL`-complemented side of an outer join (that is, the right-side table of a `LEFT JOIN` or the left-side table of a `RIGHT JOIN`).

- `SQL_BIG_RESULT` can be used with `GROUP BY` or `DISTINCT` to tell the optimizer that the result set has many rows. In this case, MySQL directly uses disk-based temporary tables if needed, and prefers sorting to using a temporary table with a key on the `GROUP BY` elements.
- `SQL_BUFFER_RESULT` forces the result to be put into a temporary table. This helps MySQL free the table locks early and helps in cases where it takes a long time to send the result set to the client. This option can be used only for top-level `SELECT` statements, not for subqueries or following `UNION`.
- `SQL_SMALL_RESULT` can be used with `GROUP BY` or `DISTINCT` to tell the optimizer that the result set is small. In this case, MySQL uses fast temporary tables to store the resulting table instead of using sorting. This should not normally be needed.
- `SQL_CALC_FOUND_ROWS` tells MySQL to calculate how many rows there would be in the result set, disregarding any `LIMIT` clause. The number of rows can then be retrieved with `SELECT FOUND_ROWS()`. See [Section 11.11.3, “Information Functions”](#).
- The `SQL_CACHE` and `SQL_NO_CACHE` options affect caching of query results in the query cache (see [Section 7.5.5, “The MySQL Query Cache”](#)). `SQL_CACHE` tells MySQL to store the result in the query cache if it is cacheable and the value of the `query_cache_type` system variable is `2` or `DEMAND`. `SQL_NO_CACHE` tells MySQL not to store the result in the query cache. For a query that uses `UNION`, subqueries, or views, the following rules apply:
  - `SQL_NO_CACHE` applies if it appears in any `SELECT` in the query.
  - For a cacheable query, `SQL_CACHE` applies if it appears in the first `SELECT` of the query, or in the first `SELECT` of a view referred to by the query.

### 12.2.8.1. JOIN Syntax

MySQL supports the following `JOIN` syntaxes for the `table_references` part of `SELECT` statements and multiple-table `DELETE` and `UPDATE` statements:

```
table_references:
```

```

 [, table_reference] ...

table_reference:
  table_factor
  | join_table

table_factor:
  tbl_name [[AS] alias] [index_hint_list]
  | table_subquery [AS] alias
  | ( table_references )
  | { OJ table_reference LEFT OUTER JOIN table_reference
      ON conditional_expr }

join_table:
  table_reference [INNER | CROSS] JOIN table_factor [join_condition]
  | table_reference STRAIGHT_JOIN table_factor
  | table_reference STRAIGHT_JOIN table_factor ON conditional_expr
  | table_reference {LEFT|RIGHT} [OUTER] JOIN table_reference join_condition
  | table_reference NATURAL [{LEFT|RIGHT} [OUTER]] JOIN table_factor

join_condition:
  ON conditional_expr
  | USING (column_list)

index_hint_list:
  index_hint [, index_hint] ...

index_hint:
  USE {INDEX|KEY}
  | [{FOR {JOIN ORDER BY|GROUP BY}] (index_list)]
  | IGNORE {INDEX KEY}
  | [{FOR {JOIN ORDER BY|GROUP BY}] (index_list)]
  | FORCE {INDEX|KEY}
  | [{FOR {JOIN ORDER BY|GROUP BY}] (index_list)]

index_list:
  index_name [, index_name] ...

```

A table reference is also known as a join expression.

The syntax of *table\_factor* is extended in comparison with the SQL Standard. The latter accepts only *table\_reference*, not a list of them inside a pair of parentheses.

This is a conservative extension if we consider each comma in a list of *table\_reference* items as equivalent to an inner join. For example:

```

SELECT * FROM t1 LEFT JOIN (t2, t3, t4)
      ON (t2.a=t1.a AND t3.b=t1.b AND t4.c=t1.c)

```

is equivalent to:

```

SELECT * FROM t1 LEFT JOIN (t2 CROSS JOIN t3 CROSS JOIN t4)
      ON (t2.a=t1.a AND t3.b=t1.b AND t4.c=t1.c)

```

In MySQL, **CROSS JOIN** is a syntactic equivalent to **INNER JOIN** (they can replace each other). In standard SQL, they are not equivalent. **INNER JOIN** is used with an **ON** clause, **CROSS JOIN** is used otherwise.

In general, parentheses can be ignored in join expressions containing only inner join operations. MySQL also supports nested joins (see [Section 7.2.11, “Nested Join Optimization”](#)).

Index hints can be specified to affect how the MySQL optimizer makes use of indexes. For more information, see [Section 12.2.8.2, “Index Hint Syntax”](#).

The following list describes general factors to take into account when writing joins.

- A table reference can be aliased using *tbl\_name AS alias\_name* or *tbl\_name alias\_name*:

```

SELECT t1.name, t2.salary
  FROM employee AS t1 INNER JOIN info AS t2 ON t1.name = t2.name;

SELECT t1.name, t2.salary
  FROM employee t1 INNER JOIN info t2 ON t1.name = t2.name;

```

- A *table\_subquery* is also known as a subquery in the **FROM** clause. Such subqueries *must* include an alias to give the subquery result a table name. A trivial example follows; see also [Section 12.2.9.8, “Subqueries in the FROM clause”](#).

```

SELECT * FROM (SELECT 1, 2, 3) AS t1;

```

- **INNER JOIN** and **,** (comma) are semantically equivalent in the absence of a join condition: both produce a Cartesian product between the specified tables (that is, each and every row in the first table is joined to each and every row in the second table).

However, the precedence of the comma operator is less than of `INNER JOIN`, `CROSS JOIN`, `LEFT JOIN`, and so on. If you mix comma joins with the other join types when there is a join condition, an error of the form `Unknown column 'col_name' in 'on clause'` may occur. Information about dealing with this problem is given later in this section.

- The `conditional_expr` used with `ON` is any conditional expression of the form that can be used in a `WHERE` clause. Generally, you should use the `ON` clause for conditions that specify how to join tables, and the `WHERE` clause to restrict which rows you want in the result set.
- If there is no matching row for the right table in the `ON` or `USING` part in a `LEFT JOIN`, a row with all columns set to `NULL` is used for the right table. You can use this fact to find rows in a table that have no counterpart in another table:

```
SELECT left_tbl.*
FROM left_tbl LEFT JOIN right_tbl ON left_tbl.id = right_tbl.id
WHERE right_tbl.id IS NULL;
```

This example finds all rows in `left_tbl` with an `id` value that is not present in `right_tbl` (that is, all rows in `left_tbl` with no corresponding row in `right_tbl`). This assumes that `right_tbl.id` is declared `NOT NULL`. See [Section 7.2.9, “LEFT JOIN and RIGHT JOIN Optimization”](#).

- The `USING(column_list)` clause names a list of columns that must exist in both tables. If tables `a` and `b` both contain columns `c1`, `c2`, and `c3`, the following join compares corresponding columns from the two tables:

```
a LEFT JOIN b USING (c1,c2,c3)
```

- The `NATURAL [LEFT] JOIN` of two tables is defined to be semantically equivalent to an `INNER JOIN` or a `LEFT JOIN` with a `USING` clause that names all columns that exist in both tables.
- `RIGHT JOIN` works analogously to `LEFT JOIN`. To keep code portable across databases, it is recommended that you use `LEFT JOIN` instead of `RIGHT JOIN`.
- The `{ OJ ... LEFT OUTER JOIN ... }` syntax shown in the join syntax description exists only for compatibility with ODBC. The curly braces in the syntax should be written literally; they are not metasyntax as used elsewhere in syntax descriptions.

```
SELECT left_tbl.*
FROM { OJ left_tbl LEFT OUTER JOIN right_tbl ON left_tbl.id = right_tbl.id }
WHERE right_tbl.id IS NULL;
```

As of MySQL 5.1.24, you can use other types of joins within `{ OJ ... }`, such as `INNER JOIN` or `RIGHT OUTER JOIN`. This helps with compatibility with some third-party applications, but is not official ODBC syntax.

- `STRAIGHT_JOIN` is similar to `JOIN`, except that the left table is always read before the right table. This can be used for those (few) cases for which the join optimizer puts the tables in the wrong order.

Some join examples:

```
SELECT * FROM table1, table2;
SELECT * FROM table1 INNER JOIN table2 ON table1.id=table2.id;
SELECT * FROM table1 LEFT JOIN table2 ON table1.id=table2.id;
SELECT * FROM table1 LEFT JOIN table2 USING (id);
SELECT * FROM table1 LEFT JOIN table2 ON table1.id=table2.id
LEFT JOIN table3 ON table2.id=table3.id;
```

## Join Processing Changes in MySQL 5.0.12

### Note

Natural joins and joins with `USING`, including outer join variants, are processed according to the SQL:2003 standard. The goal was to align the syntax and semantics of MySQL with respect to `NATURAL JOIN` and `JOIN ... USING` according to SQL:2003. However, these changes in join processing can result in different output columns for some joins. Also, some queries that appeared to work correctly in older versions (prior to 5.0.12) must be rewritten to comply with the standard.

These changes have five main aspects:

- The way that MySQL determines the result columns of `NATURAL` or `USING` join operations (and thus the result of the entire



FROM clause).

- Expansion of `SELECT *` and `SELECT tbl_name.*` into a list of selected columns.
- Resolution of column names in `NATURAL` or `USING` joins.
- Transformation of `NATURAL` or `USING` joins into `JOIN ... ON`.
- Resolution of column names in the `ON` condition of a `JOIN ... ON`.

The following list provides more detail about several effects of current join processing versus join processing in older versions. The term “previously” means “prior to MySQL 5.0.12.”

- The columns of a `NATURAL` join or a `USING` join may be different from previously. Specifically, redundant output columns no longer appear, and the order of columns for `SELECT *` expansion may be different from before.

Consider this set of statements:

```
CREATE TABLE t1 (i INT, j INT);
CREATE TABLE t2 (k INT, j INT);
INSERT INTO t1 VALUES(1,1);
INSERT INTO t2 VALUES(1,1);
SELECT * FROM t1 NATURAL JOIN t2;
SELECT * FROM t1 JOIN t2 USING (j);
```

Previously, the statements produced this output:

```
+-----+-----+-----+-----+
| i   | j   | k   | j   |
+-----+-----+-----+-----+
|  1  |  1  |  1  |  1  |
+-----+-----+-----+-----+
| i   | j   | k   | j   |
+-----+-----+-----+-----+
|  1  |  1  |  1  |  1  |
+-----+-----+-----+-----+
```

In the first `SELECT` statement, column `j` appears in both tables and thus becomes a join column, so, according to standard SQL, it should appear only once in the output, not twice. Similarly, in the second `SELECT` statement, column `j` is named in the `USING` clause and should appear only once in the output, not twice. But in both cases, the redundant column is not eliminated. Also, the order of the columns is not correct according to standard SQL.

Now the statements produce this output:

```
+-----+-----+-----+
| j   | i   | k   |
+-----+-----+-----+
|  1  |  1  |  1  |
+-----+-----+-----+
| j   | i   | k   |
+-----+-----+-----+
|  1  |  1  |  1  |
+-----+-----+-----+
```

The redundant column is eliminated and the column order is correct according to standard SQL:

- First, coalesced common columns of the two joined tables, in the order in which they occur in the first table
- Second, columns unique to the first table, in order in which they occur in that table
- Third, columns unique to the second table, in order in which they occur in that table

The single result column that replaces two common columns is defined via the coalesce operation. That is, for two `t1.a` and `t2.a` the resulting single join column `a` is defined as `a = COALESCE(t1.a, t2.a)`, where:

```
COALESCE(x, y) = (CASE WHEN v1 IS NOT NULL THEN v1 ELSE v2 END)
```

If the join operation is any other join, the result columns of the join consists of the concatenation of all columns of the joined tables. This is the same as previously.

A consequence of the definition of coalesced columns is that, for outer joins, the coalesced column contains the value of the non-`NULL` column if one of the two columns is always `NULL`. If neither or both columns are `NULL`, both common columns



have the same value, so it doesn't matter which one is chosen as the value of the coalesced column. A simple way to interpret this is to consider that a coalesced column of an outer join is represented by the common column of the inner table of a `JOIN`. Suppose that the tables `t1(a,b)` and `t2(a,c)` have the following contents:

```
t1    t2
----  ----
1 x   2 z
2 y   3 w
```

Then:

```
mysql> SELECT * FROM t1 NATURAL LEFT JOIN t2;
+-----+-----+-----+
| a     | b     | c     |
+-----+-----+-----+
| 1     | x     | NULL  |
| 2     | y     | z     |
+-----+-----+-----+
```

Here column `a` contains the values of `t1.a`.

```
mysql> SELECT * FROM t1 NATURAL RIGHT JOIN t2;
+-----+-----+-----+
| a     | c     | b     |
+-----+-----+-----+
| 2     | z     | y     |
| 3     | w     | NULL  |
+-----+-----+-----+
```

Here column `a` contains the values of `t2.a`.

Compare these results to the otherwise equivalent queries with `JOIN ... ON`:

```
mysql> SELECT * FROM t1 LEFT JOIN t2 ON (t1.a = t2.a);
+-----+-----+-----+-----+
| a     | b     | a     | c     |
+-----+-----+-----+-----+
| 1     | x     | NULL  | NULL  |
| 2     | y     | 2     | z     |
+-----+-----+-----+-----+
```

```
mysql> SELECT * FROM t1 RIGHT JOIN t2 ON (t1.a = t2.a);
+-----+-----+-----+-----+
| a     | b     | a     | c     |
+-----+-----+-----+-----+
| 2     | y     | 2     | z     |
| NULL | NULL | 3     | w     |
+-----+-----+-----+-----+
```

- Previously, a `USING` clause could be rewritten as an `ON` clause that compares corresponding columns. For example, the following two clauses were semantically identical:

```
a LEFT JOIN b USING (c1,c2,c3)
a LEFT JOIN b ON a.c1=b.c1 AND a.c2=b.c2 AND a.c3=b.c3
```

Now the two clauses no longer are quite the same:

- With respect to determining which rows satisfy the join condition, both joins remain semantically identical.
- With respect to determining which columns to display for `SELECT *` expansion, the two joins are not semantically identical. The `USING` join selects the coalesced value of corresponding columns, whereas the `ON` join selects all columns from all tables. For the preceding `USING` join, `SELECT *` selects these values:

```
COALESCE(a.c1,b.c1), COALESCE(a.c2,b.c2), COALESCE(a.c3,b.c3)
```

For the `ON` join, `SELECT *` selects these values:

```
a.c1, a.c2, a.c3, b.c1, b.c2, b.c3
```

With an inner join, `COALESCE(a.c1,b.c1)` is the same as either `a.c1` or `b.c1` because both columns will have the same value. With an outer join (such as `LEFT JOIN`), one of the two columns can be `NULL`. That column will be omitted from the result.

- The evaluation of multi-way natural joins differs in a very important way that affects the result of `NATURAL` or `USING` joins and that can require query rewriting. Suppose that you have three tables `t1(a,b)`, `t2(c,b)`, and `t3(a,c)` that each have

one row: `t1(1,2)`, `t2(10,2)`, and `t3(7,10)`. Suppose also that you have this `NATURAL JOIN` on the three tables:

```
SELECT ... FROM t1 NATURAL JOIN t2 NATURAL JOIN t3;
```

Previously, the left operand of the second join was considered to be `t2`, whereas it should be the nested join `(t1 NATURAL JOIN t2)`. As a result, the columns of `t3` are checked for common columns only in `t2`, and, if `t3` has common columns with `t1`, these columns are not used as equi-join columns. Thus, previously, the preceding query was transformed to the following equi-join:

```
SELECT ... FROM t1, t2, t3
WHERE t1.b = t2.b AND t2.c = t3.c;
```

That join is missing one more equi-join predicate `(t1.a = t3.a)`. As a result, it produces one row, not the empty result that it should. The correct equivalent query is this:

```
SELECT ... FROM t1, t2, t3
WHERE t1.b = t2.b AND t2.c = t3.c AND t1.a = t3.a;
```

If you require the same query result in current versions of MySQL as in older versions, rewrite the natural join as the first equi-join.

- Previously, the comma operator `(,)` and `JOIN` both had the same precedence, so the join expression `t1, t2 JOIN t3` was interpreted as `((t1, t2) JOIN t3)`. Now `JOIN` has higher precedence, so the expression is interpreted as `(t1, (t2 JOIN t3))`. This change affects statements that use an `ON` clause, because that clause can refer only to columns in the operands of the join, and the change in precedence changes interpretation of what those operands are.

Example:

```
CREATE TABLE t1 (i1 INT, j1 INT);
CREATE TABLE t2 (i2 INT, j2 INT);
CREATE TABLE t3 (i3 INT, j3 INT);
INSERT INTO t1 VALUES(1,1);
INSERT INTO t2 VALUES(1,1);
INSERT INTO t3 VALUES(1,1);
SELECT * FROM t1, t2 JOIN t3 ON (t1.i1 = t3.i3);
```

Previously, the `SELECT` was legal due to the implicit grouping of `t1, t2` as `(t1, t2)`. Now the `JOIN` takes precedence, so the operands for the `ON` clause are `t2` and `t3`. Because `t1.i1` is not a column in either of the operands, the result is an `Unknown column 't1.i1' in 'on clause'` error. To allow the join to be processed, group the first two tables explicitly with parentheses so that the operands for the `ON` clause are `(t1, t2)` and `t3`:

```
SELECT * FROM (t1, t2) JOIN t3 ON (t1.i1 = t3.i3);
```

Alternatively, avoid the use of the comma operator and use `JOIN` instead:

```
SELECT * FROM t1 JOIN t2 JOIN t3 ON (t1.i1 = t3.i3);
```

This change also applies to statements that mix the comma operator with `INNER JOIN`, `CROSS JOIN`, `LEFT JOIN`, and `RIGHT JOIN`, all of which now have higher precedence than the comma operator.

- Previously, the `ON` clause could refer to columns in tables named to its right. Now an `ON` clause can refer only to its operands.

Example:

```
CREATE TABLE t1 (i1 INT);
CREATE TABLE t2 (i2 INT);
CREATE TABLE t3 (i3 INT);
SELECT * FROM t1 JOIN t2 ON (i1 = i3) JOIN t3;
```

Previously, the `SELECT` statement was legal. Now the statement fails with an `Unknown column 'i3' in 'on clause'` error because `i3` is a column in `t3`, which is not an operand of the `ON` clause. The statement should be rewritten as follows:

```
SELECT * FROM t1 JOIN t2 JOIN t3 ON (i1 = i3);
```

- Resolution of column names in `NATURAL` or `USING` joins is different than previously. For column names that are outside the `FROM` clause, MySQL now handles a superset of the queries compared to previously. That is, in cases when MySQL formerly issued an error that some column is ambiguous, the query now is handled correctly. This is due to the fact that MySQL now treats the common columns of `NATURAL` or `USING` joins as a single column, so when a query refers to such columns, the query compiler does not consider them as ambiguous.

Example:

```
SELECT * FROM t1 NATURAL JOIN t2 WHERE b > 1;
```

Previously, this query would produce an error `ERROR 1052 (23000): Column 'b' in where clause is ambiguous`. Now the query produces the correct result:

b	c	y
4	2	3

One extension of MySQL compared to the SQL:2003 standard is that MySQL allows you to qualify the common (coalesced) columns of `NATURAL` or `USING` joins (just as previously), while the standard disallows that.

## 12.2.8.2. Index Hint Syntax

You can provide hints to give the optimizer information about how to choose indexes during query processing. [Section 12.2.8.1, “JOIN Syntax”](#), describes the general syntax for specifying tables in a `SELECT` statement. The syntax for an individual table, including that for index hints, looks like this:

```
tbl_name [[AS] alias] [index_hint_list]
index_hint_list:
    index_hint [, index_hint] ...
index_hint:
    USE {INDEX|KEY}
        [{FOR {JOIN|ORDER BY|GROUP BY}] (index_list)]
    | IGNORE {INDEX|KEY}
        [{FOR {JOIN|ORDER BY|GROUP BY}] (index_list)]
    | FORCE {INDEX|KEY}
        [{FOR {JOIN|ORDER BY|GROUP BY}] (index_list)]
index_list:
    index_name [, index_name] ...
```

By specifying `USE INDEX (index_list)`, you can tell MySQL to use only one of the named indexes to find rows in the table. The alternative syntax `IGNORE INDEX (index_list)` can be used to tell MySQL to not use some particular index or indexes. These hints are useful if `EXPLAIN` shows that MySQL is using the wrong index from the list of possible indexes.

You can also use `FORCE INDEX`, which acts like `USE INDEX (index_list)` but with the addition that a table scan is assumed to be *very* expensive. In other words, a table scan is used only if there is no way to use one of the given indexes to find rows in the table.

Each hint requires the names of *indexes*, not the names of columns. The name of a `PRIMARY KEY` is `PRIMARY`. To see the index names for a table, use `SHOW INDEX`.

An *index\_name* value need not be a full index name. It can be an unambiguous prefix of an index name. If a prefix is ambiguous, an error occurs.

Prior to MySQL 5.1.17, `USE INDEX`, `IGNORE INDEX`, and `FORCE INDEX` affect only which indexes are used when MySQL decides how to find rows in the table and how to process joins. They do not affect whether an index is used when resolving an `ORDER BY` or `GROUP BY` clause.

Examples:

```
SELECT * FROM table1 USE INDEX (col1_index,col2_index)
WHERE col1=1 AND col2=2 AND col3=3;

SELECT * FROM table1 IGNORE INDEX (col3_index)
WHERE col1=1 AND col2=2 AND col3=3;
```

As of MySQL 5.1.17, the syntax for index hints is extended in the following ways:

- It is syntactically valid to specify an empty *index\_list* for `USE INDEX`, which means “use no indexes.” Specifying an empty *index\_list* for `FORCE INDEX` or `IGNORE INDEX` is a syntax error.
- You can specify the scope of a index hint by adding a `FOR` clause to the hint. This provides more fine-grained control over the optimizer’s selection of an execution plan for various phases of query processing. To affect only the indexes used when MySQL decides how to find rows in the table and how to process joins, use `FOR JOIN`. To influence index usage for sorting or group-

ing rows, use `FOR ORDER BY` or `FOR GROUP BY`. (However, if there is a covering index for the table and it is used to access the table, the optimizer will ignore `IGNORE INDEX FOR {ORDER BY|GROUP BY}` hints that disable that index.)

- You can specify multiple index hints:

```
SELECT * FROM t1 USE INDEX (i1) IGNORE INDEX FOR ORDER BY (i2) ORDER BY a;
```

It is not an error to name the same index in several hints (even within the same hint):

```
SELECT * FROM t1 USE INDEX (i1) USE INDEX (i1,i1);
```

However, it is an error to mix `USE INDEX` and `FORCE INDEX` for the same table:

```
SELECT * FROM t1 USE INDEX FOR JOIN (i1) FORCE INDEX FOR JOIN (i2);
```

The default scope of index hints also is changed as of MySQL 5.1.17. Formerly, index hints applied only to how indexes are used for retrieval of records and not during resolution of `ORDER BY` or `GROUP BY` clauses. As of 5.1.17, if you specify no `FOR` clause for an index hint, the hint by default applies to all parts of the statement. For example, this hint:

```
IGNORE INDEX (i1)
```

is equivalent to this combination of hints:

```
IGNORE INDEX FOR JOIN (i1)
IGNORE INDEX FOR ORDER BY (i1)
IGNORE INDEX FOR GROUP BY (i1)
```

To cause the server to use the older behavior for hint scope when no `FOR` clause is present (so that hints apply only to row retrieval), enable the `old` system variable at server startup. Take care about enabling this variable in a replication setup. With statement-based binary logging, having different modes for the master and slaves might lead to replication errors.

When index hints are processed, they are collected in a single list by type (`USE`, `FORCE`, `IGNORE`) and by scope (`FOR JOIN`, `FOR ORDER BY`, `FOR GROUP BY`). For example:

```
SELECT * FROM t1
  USE INDEX () IGNORE INDEX (i2) USE INDEX (i1) USE INDEX (i2);
```

is equivalent to:

```
SELECT * FROM t1
  USE INDEX (i1,i2) IGNORE INDEX (i2);
```

The index hints then are applied for each scope in the following order:

- `{USE|FORCE} INDEX` is applied if present. (If not, the optimizer-determined set of indexes is used.)
- `IGNORE INDEX` is applied over the result of the previous step. For example, the following two queries are equivalent:

```
SELECT * FROM t1 USE INDEX (i1) IGNORE INDEX (i2) USE INDEX (i2);
SELECT * FROM t1 USE INDEX (i1);
```

For `FULLTEXT` searches, index hints do not work before MySQL 5.1.31. As of 5.1.31, index hints work as follows:

- For natural language mode searches, index hints are silently ignored. For example, `IGNORE INDEX(i)` is ignored with no warning and the index is still used.

For boolean mode searches, index hints with `FOR ORDER BY` or `FOR GROUP BY` are silently ignored. Index hints with `FOR JOIN` or no `FOR` modifier are honored. In contrast to how hints apply for non-`FULLTEXT` searches, the hint is used for all phases of query execution (finding rows and retrieval, grouping, and ordering). This is true even if the hint is given for a non-`FULLTEXT` index.

For example, the following two queries are equivalent:

```
SELECT * FROM t
```

```

USE INDEX (index1)
IGNORE INDEX (index1) FOR ORDER BY
IGNORE INDEX (index1) FOR GROUP BY
WHERE ... IN BOOLEAN MODE ... ;

SELECT * FROM t
USE INDEX (index1)
WHERE ... IN BOOLEAN MODE ... ;

```

Index hints are accepted but ignored for `UPDATE` statements.

### 12.2.8.3. UNION Syntax

```

SELECT ...
UNION [ALL | DISTINCT] SELECT ...
[UNION [ALL | DISTINCT] SELECT ...]

```

`UNION` is used to combine the result from multiple `SELECT` statements into a single result set.

The column names from the first `SELECT` statement are used as the column names for the results returned. Selected columns listed in corresponding positions of each `SELECT` statement should have the same data type. (For example, the first column selected by the first statement should have the same type as the first column selected by the other statements.)

If the data types of corresponding `SELECT` columns do not match, the types and lengths of the columns in the `UNION` result take into account the values retrieved by all of the `SELECT` statements. For example, consider the following:

```

mysql> SELECT REPEAT('a',1) UNION SELECT REPEAT('b',10);
+-----+
| REPEAT('a',1) |
+-----+
| a              |
| bbbbbbbbbbb   |
+-----+

```

(In some earlier versions of MySQL, only the type and length from the first `SELECT` would have been used and the second row would have been truncated to a length of 1.)

The `SELECT` statements are normal select statements, but with the following restrictions:

- Only the last `SELECT` statement can use `INTO OUTFILE`. (However, the entire `UNION` result is written to the file.)
- `HIGH_PRIORITY` cannot be used with `SELECT` statements that are part of a `UNION`. If you specify it for the first `SELECT`, it has no effect. If you specify it for any subsequent `SELECT` statements, a syntax error results.

The default behavior for `UNION` is that duplicate rows are removed from the result. The optional `DISTINCT` keyword has no effect other than the default because it also specifies duplicate-row removal. With the optional `ALL` keyword, duplicate-row removal does not occur and the result includes all matching rows from all the `SELECT` statements.

You can mix `UNION ALL` and `UNION DISTINCT` in the same query. Mixed `UNION` types are treated such that a `DISTINCT` union overrides any `ALL` union to its left. A `DISTINCT` union can be produced explicitly by using `UNION DISTINCT` or implicitly by using `UNION` with no following `DISTINCT` or `ALL` keyword.

To use an `ORDER BY` or `LIMIT` clause to sort or limit the entire `UNION` result, parenthesize the individual `SELECT` statements and place the `ORDER BY` or `LIMIT` after the last one. The following example uses both clauses:

```

(SELECT a FROM t1 WHERE a=10 AND B=1)
UNION
(SELECT a FROM t2 WHERE a=11 AND B=2)
ORDER BY a LIMIT 10;

```

This kind of `ORDER BY` cannot use column references that include a table name (that is, names in `tbl_name.col_name` format). Instead, provide a column alias in the first `SELECT` statement and refer to the alias in the `ORDER BY`. (Alternatively, refer to the column in the `ORDER BY` using its column position. However, use of column positions is deprecated.)

Also, if a column to be sorted is aliased, the `ORDER BY` clause *must* refer to the alias, not the column name. The first of the following statements will work, but the second will fail with an `Unknown column 'a' in 'order clause'` error:

```

(SELECT a AS b FROM t) UNION (SELECT ... ) ORDER BY b;
(SELECT a AS b FROM t) UNION (SELECT ... ) ORDER BY a;

```

To apply `ORDER BY` or `LIMIT` to an individual `SELECT`, place the clause inside the parentheses that enclose the `SELECT`:

```
(SELECT a FROM t1 WHERE a=10 AND B=1 ORDER BY a LIMIT 10)
UNION
(SELECT a FROM t2 WHERE a=11 AND B=2 ORDER BY a LIMIT 10);
```

However, use of `ORDER BY` for individual `SELECT` statements implies nothing about the order in which the rows appear in the final result because `UNION` by default produces an unordered set of rows. Therefore, the use of `ORDER BY` in this context is typically in conjunction with `LIMIT`, so that it is used to determine the subset of the selected rows to retrieve for the `SELECT`, even though it does not necessarily affect the order of those rows in the final `UNION` result. If `ORDER BY` appears without `LIMIT` in a `SELECT`, it is optimized away because it will have no effect anyway.

To cause rows in a `UNION` result to consist of the sets of rows retrieved by each `SELECT` one after the other, select an additional column in each `SELECT` to use as a sort column and add an `ORDER BY` following the last `SELECT`:

```
(SELECT 1 AS sort_col, colla, collb, ... FROM t1)
UNION
(SELECT 2, col2a, col2b, ... FROM t2) ORDER BY sort_col;
```

To additionally maintain sort order within individual `SELECT` results, add a secondary column to the `ORDER BY` clause:

```
(SELECT 1 AS sort_col, colla, collb, ... FROM t1)
UNION
(SELECT 2, col2a, col2b, ... FROM t2) ORDER BY sort_col, colla;
```

Use of an additional column also enables you to determine which `SELECT` each row comes from. Extra columns can provide other identifying information as well, such as a string that indicates a table name.

## 12.2.9. Subquery Syntax

A subquery is a `SELECT` statement within another statement.

Starting with MySQL 4.1, all subquery forms and operations that the SQL standard requires are supported, as well as a few features that are MySQL-specific.

Here is an example of a subquery:

```
SELECT * FROM t1 WHERE column1 = (SELECT column1 FROM t2);
```

In this example, `SELECT * FROM t1 ...` is the *outer query* (or *outer statement*), and `(SELECT column1 FROM t2)` is the *subquery*. We say that the subquery is *nested* within the outer query, and in fact it is possible to nest subqueries within other subqueries, to a considerable depth. A subquery must always appear within parentheses.

The main advantages of subqueries are:

- They allow queries that are *structured* so that it is possible to isolate each part of a statement.
- They provide alternative ways to perform operations that would otherwise require complex joins and unions.
- They are, in many people's opinion, more readable than complex joins or unions. Indeed, it was the innovation of subqueries that gave people the original idea of calling the early SQL "Structured Query Language."

Here is an example statement that shows the major points about subquery syntax as specified by the SQL standard and supported in MySQL:

```
DELETE FROM t1
WHERE s11 > ANY
  (SELECT COUNT(*) /* no hint */ FROM t2
   WHERE NOT EXISTS
    (SELECT * FROM t3
     WHERE ROW(5*t2.s1,77)=
      (SELECT 50,11*s1 FROM t4 UNION SELECT 50,77 FROM
       (SELECT * FROM t5) AS t5)));
```

A subquery can return a scalar (a single value), a single row, a single column, or a table (one or more rows of one or more columns). These are called scalar, column, row, and table subqueries. Subqueries that return a particular kind of result often can be used only in certain contexts, as described in the following sections.

There are few restrictions on the type of statements in which subqueries can be used. A subquery can contain any of the keywords or clauses that an ordinary `SELECT` can contain: `DISTINCT`, `GROUP BY`, `ORDER BY`, `LIMIT`, joins, index hints, `UNION` constructs, comments, functions, and so on.

One restriction is that a subquery's outer statement must be one of: `SELECT`, `INSERT`, `UPDATE`, `DELETE`, `SET`, or `DO`. Another restriction is that currently you cannot modify a table and select from the same table in a subquery. This applies to statements such as `DELETE`, `INSERT`, `REPLACE`, `UPDATE`, and (because subqueries can be used in the `SET` clause) `LOAD DATA INFILE`.

A more comprehensive discussion of restrictions on subquery use, including performance issues for certain forms of subquery syntax, is given in [Section D.3, "Restrictions on Subqueries"](#).

### 12.2.9.1. The Subquery as Scalar Operand

In its simplest form, a subquery is a scalar subquery that returns a single value. A scalar subquery is a simple operand, and you can use it almost anywhere a single column value or literal is legal, and you can expect it to have those characteristics that all operands have: a data type, a length, an indication whether it can be `NULL`, and so on. For example:

```
CREATE TABLE t1 (s1 INT, s2 CHAR(5) NOT NULL);
INSERT INTO t1 VALUES(100, 'abcde');
SELECT (SELECT s2 FROM t1);
```

The subquery in this `SELECT` returns a single value ('abcde') that has a data type of `CHAR`, a length of 5, a character set and collation equal to the defaults in effect at `CREATE TABLE` time, and an indication that the value in the column can be `NULL`. In fact, almost all subqueries can be `NULL`. If the table used in the example were empty, the value of the subquery would be `NULL`.

There are a few contexts in which a scalar subquery cannot be used. If a statement allows only a literal value, you cannot use a subquery. For example, `LIMIT` requires literal integer arguments, and `LOAD DATA INFILE` requires a literal string file name. You cannot use subqueries to supply these values.

When you see examples in the following sections that contain the rather spartan construct (`SELECT column1 FROM t1`), imagine that your own code contains much more diverse and complex constructions.

Suppose that we make two tables:

```
CREATE TABLE t1 (s1 INT);
INSERT INTO t1 VALUES (1);
CREATE TABLE t2 (s1 INT);
INSERT INTO t2 VALUES (2);
```

Then perform a `SELECT`:

```
SELECT (SELECT s1 FROM t2) FROM t1;
```

The result is 2 because there is a row in `t2` containing a column `s1` that has a value of 2.

A scalar subquery can be part of an expression, but remember the parentheses, even if the subquery is an operand that provides an argument for a function. For example:

```
SELECT UPPER((SELECT s1 FROM t1)) FROM t2;
```

### 12.2.9.2. Comparisons Using Subqueries

The most common use of a subquery is in the form:

```
non_subquery_operand comparison_operator (subquery)
```

Where *comparison\_operator* is one of these operators:

```
= > < >= <= <> != <=>
```

For example:

```
... 'a' = (SELECT column1 FROM t1)
```

At one time the only legal place for a subquery was on the right side of a comparison, and you might still find some old DBMSs that insist on this.

Here is an example of a common-form subquery comparison that you cannot do with a join. It finds all the rows in table `t1` for which the `column1` value is equal to a maximum value in table `t2`:

```
SELECT * FROM t1
WHERE column1 = (SELECT MAX(column2) FROM t2);
```

Here is another example, which again is impossible with a join because it involves aggregating for one of the tables. It finds all rows in table `t1` containing a value that occurs twice in a given column:

```
SELECT * FROM t1 AS t
WHERE 2 = (SELECT COUNT(*) FROM t1 WHERE t1.id = t.id);
```

For a comparison of the subquery to a scalar, the subquery must return a scalar. For a comparison of the subquery to a row constructor, the subquery must be a row subquery that returns a row with the same number of values as the row constructor. See [Section 12.2.9.5, “Row Subqueries”](#).

### 12.2.9.3. Subqueries with **ANY**, **IN**, and **SOME**

Syntax:

```
operand comparison_operator ANY (subquery)
operand IN (subquery)
operand comparison_operator SOME (subquery)
```

The **ANY** keyword, which must follow a comparison operator, means “return **TRUE** if the comparison is **TRUE** for **ANY** of the values in the column that the subquery returns.” For example:

```
SELECT s1 FROM t1 WHERE s1 > ANY (SELECT s1 FROM t2);
```

Suppose that there is a row in table `t1` containing `(10)`. The expression is **TRUE** if table `t2` contains `(21, 14, 7)` because there is a value `7` in `t2` that is less than `10`. The expression is **FALSE** if table `t2` contains `(20, 10)`, or if table `t2` is empty. The expression is *unknown* if table `t2` contains `(NULL, NULL, NULL)`.

When used with a subquery, the word **IN** is an alias for `= ANY`. Thus, these two statements are the same:

```
SELECT s1 FROM t1 WHERE s1 = ANY (SELECT s1 FROM t2);
SELECT s1 FROM t1 WHERE s1 IN (SELECT s1 FROM t2);
```

**IN** and `= ANY` are not synonyms when used with an expression list. **IN** can take an expression list, but `= ANY` cannot. See [Section 11.2.3, “Comparison Functions and Operators”](#).

**NOT IN** is not an alias for `<> ANY`, but for `<> ALL`. See [Section 12.2.9.4, “Subqueries with ALL”](#).

The word **SOME** is an alias for **ANY**. Thus, these two statements are the same:

```
SELECT s1 FROM t1 WHERE s1 <> ANY (SELECT s1 FROM t2);
SELECT s1 FROM t1 WHERE s1 <> SOME (SELECT s1 FROM t2);
```

Use of the word **SOME** is rare, but this example shows why it might be useful. To most people's ears, the English phrase “a is not equal to any b” means “there is no b which is equal to a,” but that is not what is meant by the SQL syntax. The syntax means “there is some b to which a is not equal.” Using `<> SOME` instead helps ensure that everyone understands the true meaning of the query.

### 12.2.9.4. Subqueries with **ALL**

Syntax:

```
operand comparison_operator ALL (subquery)
```

The word **ALL**, which must follow a comparison operator, means “return **TRUE** if the comparison is **TRUE** for **ALL** of the values in the column that the subquery returns.” For example:

```
SELECT s1 FROM t1 WHERE s1 > ALL (SELECT s1 FROM t2);
```

Suppose that there is a row in table `t1` containing `(10)`. The expression is **TRUE** if table `t2` contains `(-5, 0, +5)` because `10` is greater than all three values in `t2`. The expression is **FALSE** if table `t2` contains `(12, 6, NULL, -100)` because there is a single value `12` in table `t2` that is greater than `10`. The expression is *unknown* (that is, **NULL**) if table `t2` contains `(0, NULL, 1)`.

Finally, if table `t2` is empty, the result is **TRUE**. So, the following statement is **TRUE** when table `t2` is empty:

```
SELECT * FROM t1 WHERE 1 > ALL (SELECT s1 FROM t2);
```

But this statement is **NULL** when table `t2` is empty:

```
SELECT * FROM t1 WHERE 1 > (SELECT s1 FROM t2);
```



In addition, the following statement is `NULL` when table `t2` is empty:

```
SELECT * FROM t1 WHERE 1 > ALL (SELECT MAX(s1) FROM t2);
```

In general, *tables containing `NULL` values* and *empty tables* are “edge cases.” When writing subquery code, always consider whether you have taken those two possibilities into account.

`NOT IN` is an alias for `<> ALL`. Thus, these two statements are the same:

```
SELECT s1 FROM t1 WHERE s1 <> ALL (SELECT s1 FROM t2);
SELECT s1 FROM t1 WHERE s1 NOT IN (SELECT s1 FROM t2);
```

### 12.2.9.5. Row Subqueries

The discussion to this point has been of scalar or column subqueries; that is, subqueries that return a single value or a column of values. A *row subquery* is a subquery variant that returns a single row and can thus return more than one column value. Legal operators for row subquery comparisons are:

```
= > < >= <= <> != <=>
```

Here are two examples:

```
SELECT * FROM t1 WHERE (1,2) = (SELECT column1, column2 FROM t2);
SELECT * FROM t1 WHERE ROW(1,2) = (SELECT column1, column2 FROM t2);
```

The queries here are both `TRUE` if table `t2` has a row where `column1 = 1` and `column2 = 2`.

The expressions `(1, 2)` and `ROW(1, 2)` are sometimes called *row constructors*. The two are equivalent. The row constructor and the row returned by the subquery must contain the same number of values.

Row constructors are legal in other contexts as well. For example, the following two statements are semantically equivalent (although the first one cannot be optimized until MySQL 5.1.12):

```
SELECT * FROM t1 WHERE (column1,column2) = (1,1);
SELECT * FROM t1 WHERE column1 = 1 AND column2 = 1;
```

The normal use of row constructors is for comparisons with subqueries that return two or more columns. For example, the following query answers the request, “find all rows in table `t1` that also exist in table `t2`”:

```
SELECT column1,column2,column3
FROM t1
WHERE (column1,column2,column3) IN
      (SELECT column1,column2,column3 FROM t2);
```

### 12.2.9.6. EXISTS and NOT EXISTS

If a subquery returns any rows at all, `EXISTS subquery` is `TRUE`, and `NOT EXISTS subquery` is `FALSE`. For example:

```
SELECT column1 FROM t1 WHERE EXISTS (SELECT * FROM t2);
```

Traditionally, an `EXISTS` subquery starts with `SELECT *`, but it could begin with `SELECT 5` or `SELECT column1` or anything at all. MySQL ignores the `SELECT` list in such a subquery, so it makes no difference.

For the preceding example, if `t2` contains any rows, even rows with nothing but `NULL` values, the `EXISTS` condition is `TRUE`. This is actually an unlikely example because a `[NOT] EXISTS` subquery almost always contains correlations. Here are some more realistic examples:

- What kind of store is present in one or more cities?

```
SELECT DISTINCT store_type FROM stores
WHERE EXISTS (SELECT * FROM cities_stores
              WHERE cities_stores.store_type = stores.store_type);
```

- What kind of store is present in no cities?

```
SELECT DISTINCT store_type FROM stores
WHERE NOT EXISTS (SELECT * FROM cities_stores
                  WHERE cities_stores.store_type = stores.store_type);
```

- What kind of store is present in all cities?

```
SELECT DISTINCT store_type FROM stores s1
WHERE NOT EXISTS (
  SELECT * FROM cities WHERE NOT EXISTS (
    SELECT * FROM cities_stores
    WHERE cities_stores.city = cities.city
    AND cities_stores.store_type = stores.store_type));
```

The last example is a double-nested `NOT EXISTS` query. That is, it has a `NOT EXISTS` clause within a `NOT EXISTS` clause. Formally, it answers the question “does a city exist with a store that is not in `Stores`”? But it is easier to say that a nested `NOT EXISTS` answers the question “is  $x$  `TRUE` for all  $y$ ?”

### 12.2.9.7. Correlated Subqueries

A *correlated subquery* is a subquery that contains a reference to a table that also appears in the outer query. For example:

```
SELECT * FROM t1 WHERE column1 = ANY
(SELECT column1 FROM t2 WHERE t2.column2 = t1.column2);
```

Notice that the subquery contains a reference to a column of `t1`, even though the subquery's `FROM` clause does not mention a table `t1`. So, MySQL looks outside the subquery, and finds `t1` in the outer query.

Suppose that table `t1` contains a row where `column1 = 5` and `column2 = 6`; meanwhile, table `t2` contains a row where `column1 = 5` and `column2 = 7`. The simple expression `... WHERE column1 = ANY (SELECT column1 FROM t2)` would be `TRUE`, but in this example, the `WHERE` clause within the subquery is `FALSE` (because `(5, 6)` is not equal to `(5, 7)`), so the subquery as a whole is `FALSE`.

**Scoping rule:** MySQL evaluates from inside to outside. For example:

```
SELECT column1 FROM t1 AS x
WHERE x.column1 = (SELECT column1 FROM t2 AS x
WHERE x.column1 = (SELECT column1 FROM t3
WHERE x.column2 = t3.column1));
```

In this statement, `x.column2` must be a column in table `t2` because `SELECT column1 FROM t2 AS x ...` renames `t2`. It is not a column in table `t1` because `SELECT column1 FROM t1 ...` is an outer query that is *farther out*.

For subqueries in `HAVING` or `ORDER BY` clauses, MySQL also looks for column names in the outer select list.

For certain cases, a correlated subquery is optimized. For example:

```
val IN (SELECT key_val FROM tbl_name WHERE correlated_condition)
```

Otherwise, they are inefficient and likely to be slow. Rewriting the query as a join might improve performance.

Aggregate functions in correlated subqueries may contain outer references, provided the function contains nothing but outer references, and provided the function is not contained in another function or expression.

### 12.2.9.8. Subqueries in the `FROM` clause

Subqueries are legal in a `SELECT` statement's `FROM` clause. The actual syntax is:

```
SELECT ... FROM (subquery) [AS] name ...
```

The `[AS] name` clause is mandatory, because every table in a `FROM` clause must have a name. Any columns in the *subquery* select list must have unique names.

For the sake of illustration, assume that you have this table:

```
CREATE TABLE t1 (s1 INT, s2 CHAR(5), s3 FLOAT);
```

Here is how to use a subquery in the `FROM` clause, using the example table:

```
INSERT INTO t1 VALUES (1, '1', 1.0);
INSERT INTO t1 VALUES (2, '2', 2.0);
SELECT sb1, sb2, sb3
FROM (SELECT s1 AS sb1, s2 AS sb2, s3*2 AS sb3 FROM t1) AS sb
WHERE sb1 > 1;
```

Result: 2, '2', 4.0.

Here is another example: Suppose that you want to know the average of a set of sums for a grouped table. This does not work:

```
SELECT AVG(SUM(column1)) FROM t1 GROUP BY column1;
```

However, this query provides the desired information:

```
SELECT AVG(sum_column1)
FROM (SELECT SUM(column1) AS sum_column1
      FROM t1 GROUP BY column1) AS t1;
```

Notice that the column name used within the subquery (`sum_column1`) is recognized in the outer query.

Subqueries in the `FROM` clause can return a scalar, column, row, or table. Subqueries in the `FROM` clause cannot be correlated subqueries, unless used within the `ON` clause of a `JOIN` operation.

Subqueries in the `FROM` clause are executed even for the `EXPLAIN` statement (that is, derived temporary tables are built). This occurs because upper-level queries need information about all tables during the optimization phase, and the table represented by a subquery in the `FROM` clause is unavailable unless the subquery is executed.

It is possible under certain circumstances to modify table data using `EXPLAIN SELECT`. This can occur if the outer query accesses any tables and an inner query invokes a stored function that changes one or more rows of a table. For example, suppose there are two tables `t1` and `t2` in database `d1`, created as shown here:

```
mysql> CREATE DATABASE d1;
Query OK, 1 row affected (0.00 sec)

mysql> USE d1;
Database changed

mysql> CREATE TABLE t1 (c1 INT);
Query OK, 0 rows affected (0.15 sec)

mysql> CREATE TABLE t2 (c1 INT);
Query OK, 0 rows affected (0.08 sec)
```

Now we create a stored function `f1` which modifies `t2`:

```
mysql> DELIMITER //
mysql> CREATE FUNCTION f1(p1 INT) RETURNS INT
mysql> BEGIN
mysql>     INSERT INTO t2 VALUES (p1);
mysql>     RETURN p1;
mysql> END //
Query OK, 0 rows affected (0.01 sec)

mysql> DELIMITER ;
```

Referencing the function directly in an `EXPLAIN SELECT` does not have any effect on `t2`, as shown here:

```
mysql> SELECT * FROM t2;
Empty set (0.00 sec)

mysql> EXPLAIN SELECT f1(5);
+----+-----+-----+-----+-----+-----+-----+-----+-----+-----+
| id | select_type | table | type | possible_keys | key | key_len | ref | rows | Extra |
+----+-----+-----+-----+-----+-----+-----+-----+-----+-----+
| 1 | SIMPLE | NULL | NULL | NULL | NULL | NULL | NULL | NULL | No tables used |
+----+-----+-----+-----+-----+-----+-----+-----+-----+-----+
1 row in set (0.00 sec)

mysql> SELECT * FROM t2;
Empty set (0.00 sec)
```

This is because the `SELECT` statement did not reference any tables, as can be seen in the `table` and `Extra` columns of the output. This is also true of the following nested `SELECT`:

```
mysql> EXPLAIN SELECT NOW() AS a1, (SELECT f1(5)) AS a2;
+----+-----+-----+-----+-----+-----+-----+-----+-----+-----+
| id | select_type | table | type | possible_keys | key | key_len | ref | rows | Extra |
+----+-----+-----+-----+-----+-----+-----+-----+-----+-----+
| 1 | PRIMARY | NULL | NULL | NULL | NULL | NULL | NULL | NULL | No tables used |
+----+-----+-----+-----+-----+-----+-----+-----+-----+-----+
1 row in set, 1 warning (0.00 sec)

mysql> SHOW WARNINGS;
+-----+-----+-----+
| Level | Code | Message |
+-----+-----+-----+
| Note | 1249 | Select 2 was reduced during optimization |
+-----+-----+-----+
1 row in set (0.00 sec)

mysql> SELECT * FROM t2;
```

```
Empty set (0.00 sec)
```

However, if the outer `SELECT` references any tables, then the optimizer executes the statement in the subquery as well:

```
mysql> EXPLAIN SELECT * FROM t1 AS a1, (SELECT f1(5)) AS a2;
+----+-----+-----+-----+-----+-----+-----+-----+-----+-----+
| id | select_type | table | type | possible_keys | key | key_len | ref | rows | Extra |
+----+-----+-----+-----+-----+-----+-----+-----+-----+-----+
| 1  | PRIMARY    | a1    | system | NULL          | NULL | NULL    | NULL | 0    | const row not found |
| 1  | PRIMARY    | <derived2> | system | NULL          | NULL | NULL    | NULL | 1    | |
| 2  | DERIVED    | NULL  | NULL  | NULL          | NULL | NULL    | NULL | NULL | No tables used |
+----+-----+-----+-----+-----+-----+-----+-----+-----+-----+
3 rows in set (0.00 sec)

mysql> SELECT * FROM t2;
+----+
| c1 |
+----+
| 5  |
+----+
1 row in set (0.00 sec)
```

This also means that an `EXPLAIN SELECT` statement such as the one shown here may take a long time to execute:

```
EXPLAIN SELECT * FROM t1 AS a1, (SELECT BENCHMARK(1000000, MD5(NOW())));
```

This is because the `BENCHMARK()` function is executed once for each row in `t1`.

### 12.2.9.9. Subquery Errors

There are some errors that apply only to subqueries. This section describes them.

- Unsupported subquery syntax:

```
ERROR 1235 (ER_NOT_SUPPORTED_YET)
SQLSTATE = 42000
Message = "This version of MySQL does not yet support
'LIMIT & IN/ALL/ANY/SOME subquery'"
```

This means that statements of the following form do not work yet:

```
SELECT * FROM t1 WHERE s1 IN (SELECT s2 FROM t2 ORDER BY s1 LIMIT 1)
```

- Incorrect number of columns from subquery:

```
ERROR 1241 (ER_OPERAND_COL)
SQLSTATE = 21000
Message = "Operand should contain 1 column(s)"
```

This error occurs in cases like this:

```
SELECT (SELECT column1, column2 FROM t2) FROM t1;
```

You may use a subquery that returns multiple columns, if the purpose is comparison. In other contexts, the subquery must be a scalar operand. See [Section 12.2.9.5, "Row Subqueries"](#).

- Incorrect number of rows from subquery:

```
ERROR 1242 (ER_SUBSELECT_NO_1_ROW)
SQLSTATE = 21000
Message = "Subquery returns more than 1 row"
```

This error occurs for statements where the subquery returns more than one row. Consider the following example:

```
SELECT * FROM t1 WHERE column1 = (SELECT column1 FROM t2);
```

If `SELECT column1 FROM t2` returns just one row, the previous query will work. If the subquery returns more than one row, error 1242 will occur. In that case, the query should be rewritten as:

```
SELECT * FROM t1 WHERE column1 = ANY (SELECT column1 FROM t2);
```

- Incorrectly used table in subquery:

```
Error 1093 (ER_UPDATE_TABLE_USED)
SQLSTATE = HY000
```

```
Message = "You can't specify target table 'x'
for update in FROM clause"
```

This error occurs in cases such as the following:

```
UPDATE t1 SET column2 = (SELECT MAX(column1) FROM t1);
```

You can use a subquery for assignment within an `UPDATE` statement because subqueries are legal in `UPDATE` and `DELETE` statements as well as in `SELECT` statements. However, you cannot use the same table (in this case, table `t1`) for both the subquery's `FROM` clause and the update target.

For transactional storage engines, the failure of a subquery causes the entire statement to fail. For non-transactional storage engines, data modifications made before the error was encountered are preserved.

### 12.2.9.10. Optimizing Subqueries

Development is ongoing, so no optimization tip is reliable for the long term. The following list provides some interesting tricks that you might want to play with:

- Use subquery clauses that affect the number or order of the rows in the subquery. For example:

```
SELECT * FROM t1 WHERE t1.column1 IN
  (SELECT column1 FROM t2 ORDER BY column1);
SELECT * FROM t1 WHERE t1.column1 IN
  (SELECT DISTINCT column1 FROM t2);
SELECT * FROM t1 WHERE EXISTS
  (SELECT * FROM t2 LIMIT 1);
```

- Replace a join with a subquery. For example, try this:

```
SELECT DISTINCT column1 FROM t1 WHERE t1.column1 IN (
  SELECT column1 FROM t2);
```

Instead of this:

```
SELECT DISTINCT t1.column1 FROM t1, t2
  WHERE t1.column1 = t2.column1;
```

- Some subqueries can be transformed to joins for compatibility with older versions of MySQL that do not support subqueries. However, in some cases, converting a subquery to a join may improve performance. See [Section 12.2.9.11, “Rewriting Subqueries as Joins”](#).
- Move clauses from outside to inside the subquery. For example, use this query:

```
SELECT * FROM t1
  WHERE s1 IN (SELECT s1 FROM t1 UNION ALL SELECT s1 FROM t2);
```

Instead of this query:

```
SELECT * FROM t1
  WHERE s1 IN (SELECT s1 FROM t1) OR s1 IN (SELECT s1 FROM t2);
```

For another example, use this query:

```
SELECT (SELECT column1 + 5 FROM t1) FROM t2;
```

Instead of this query:

```
SELECT (SELECT column1 FROM t1) + 5 FROM t2;
```

- Use a row subquery instead of a correlated subquery. For example, use this query:

```
SELECT * FROM t1
  WHERE (column1,column2) IN (SELECT column1,column2 FROM t2);
```

Instead of this query:

```
SELECT * FROM t1
WHERE EXISTS (SELECT * FROM t2 WHERE t2.column1=t1.column1
AND t2.column2=t1.column2);
```

- Use `NOT (a = ANY (...))` rather than `a <> ALL (...)`.
- Use `x = ANY (table containing (1,2))` rather than `x=1 OR x=2`.
- Use `= ANY` rather than `EXISTS`.
- For uncorrelated subqueries that always return one row, `IN` is always slower than `=`. For example, use this query:

```
SELECT * FROM t1 WHERE t1.col_name
= (SELECT a FROM t2 WHERE b = some_const);
```

Instead of this query:

```
SELECT * FROM t1 WHERE t1.col_name
IN (SELECT a FROM t2 WHERE b = some_const);
```

These tricks might cause programs to go faster or slower. Using MySQL facilities like the `BENCHMARK()` function, you can get an idea about what helps in your own situation. See [Section 11.11.3, “Information Functions”](#).

Some optimizations that MySQL itself makes are:

- MySQL executes uncorrelated subqueries only once. Use `EXPLAIN` to make sure that a given subquery really is uncorrelated.
- MySQL rewrites `IN`, `ALL`, `ANY`, and `SOME` subqueries in an attempt to take advantage of the possibility that the select-list columns in the subquery are indexed.
- MySQL replaces subqueries of the following form with an index-lookup function, which `EXPLAIN` describes as a special join type (`unique_subquery` or `index_subquery`):

```
... IN (SELECT indexed_column FROM single_table ...)
```

- MySQL enhances expressions of the following form with an expression involving `MIN()` or `MAX()`, unless `NULL` values or empty sets are involved:

```
value {ALL|ANY|SOME} {> | < | >= | <=} (uncorrelated subquery)
```

For example, this `WHERE` clause:

```
WHERE 5 > ALL (SELECT x FROM t)
```

might be treated by the optimizer like this:

```
WHERE 5 > (SELECT MAX(x) FROM t)
```

See also the MySQL Internals Manual chapter [How MySQL Transforms Subqueries](#).

### 12.2.9.11. Rewriting Subqueries as Joins

Although MySQL 5.1 supports subqueries (see [Section 12.2.9, “Subquery Syntax”](#)), it is still true that there are sometimes other ways to test membership in a set of values. It is also true that on some occasions, it is not only possible to rewrite a query without a subquery, but it can be more efficient to make use of some of these techniques rather than to use subqueries. One of these is the `IN()` construct:

For example, this query:

```
SELECT * FROM t1 WHERE id IN (SELECT id FROM t2);
```

Can be rewritten as:

```
SELECT DISTINCT t1.* FROM t1, t2 WHERE t1.id=t2.id;
```

The queries:

```
SELECT * FROM t1 WHERE id NOT IN (SELECT id FROM t2);
SELECT * FROM t1 WHERE NOT EXISTS (SELECT id FROM t2 WHERE t1.id=t2.id);
```

Can be rewritten as:

```
SELECT table1.*
FROM table1 LEFT JOIN table2 ON table1.id=table2.id
WHERE table2.id IS NULL;
```

A **LEFT [OUTER] JOIN** can be faster than an equivalent subquery because the server might be able to optimize it better — a fact that is not specific to MySQL Server alone. Prior to SQL-92, outer joins did not exist, so subqueries were the only way to do certain things. Today, MySQL Server and many other modern database systems offer a wide range of outer join types.

MySQL Server supports multiple-table **DELETE** statements that can be used to efficiently delete rows based on information from one table or even from many tables at the same time. Multiple-table **UPDATE** statements are also supported. See [Section 12.2.2](#), “**DELETE Syntax**”, and [Section 12.2.11](#), “**UPDATE Syntax**”.

## 12.2.10. TRUNCATE Syntax

```
TRUNCATE [TABLE] tbl_name
```

**TRUNCATE TABLE** empties a table completely. Logically, this is equivalent to a **DELETE** statement that deletes all rows, but there are practical differences under some circumstances.

For an **InnoDB** table, **InnoDB** processes **TRUNCATE TABLE** by deleting rows one by one if there are any **FOREIGN KEY** constraints that reference the table. If there are no **FOREIGN KEY** constraints, **InnoDB** performs fast truncation by dropping the original table and creating an empty one with the same definition, which is much faster than deleting rows one by one. The **AUTO\_INCREMENT** counter is reset by **TRUNCATE TABLE**, regardless of whether there is a **FOREIGN KEY** constraint.

In the case that **FOREIGN KEY** constraints reference the table, **InnoDB** deletes rows one by one and processes the constraints on each one. If the **FOREIGN KEY** constraint specifies **DELETE CASCADE**, rows from the child (referenced) table are deleted, and the truncated table becomes empty. If the **FOREIGN KEY** constraint does *not* specify **CASCADE**, the **TRUNCATE** statement deletes rows one by one and stops if it encounters a parent row that is referenced by the child, returning this error:

```
ERROR 1451 (23000): Cannot delete or update a parent row: a foreign
key constraint fails (`test`.`child`, CONSTRAINT `child_ibfk_1`
FOREIGN KEY (`parent_id`) REFERENCES `parent` (`id`))
```

This is the same as a **DELETE** statement with no **WHERE** clause.

Beginning with MySQL 5.1.32, **TRUNCATE** is treated for purposes of binary logging and replication as **DROP TABLE** followed by **CREATE TABLE** — that is, as DDL rather than DML. This is due to the fact that, when using **InnoDB** and other transactional storage engines where the transaction isolation level does not allow for statement-based logging (**READ COMMITTED** or **READ UNCOMMITTED**), the statement was not logged and replicated when using **STATEMENT** or **MIXED** logging mode. ([Bug#36763](#)) However, it is still applied on replication slaves using **InnoDB** in the manner described previously.

The count of rows affected by **TRUNCATE TABLE** is accurate only when it is mapped to a **DELETE** statement.

For other storage engines, **TRUNCATE TABLE** differs from **DELETE** in the following ways in MySQL 5.1:

- Truncate operations drop and re-create the table, which is much faster than deleting rows one by one, particularly for large tables.
- Truncate operations are not transaction-safe; an error occurs when attempting one in the course of an active transaction or active table lock.
- Truncation operations do not return the number of deleted rows.
- As long as the table format file *tbl\_name.frm* is valid, the table can be re-created as an empty table with **TRUNCATE TABLE**, even if the data or index files have become corrupted.
- The table handler does not remember the last used **AUTO\_INCREMENT** value, but starts counting from the beginning. This is true even for **MyISAM** and **InnoDB**, which normally do not reuse sequence values.
- When used with partitioned tables, **TRUNCATE TABLE** preserves the partitioning; that is, the data and index files are dropped and re-created, while the partition definitions (*.par*) file is unaffected.

- Since truncation of a table does not make any use of `DELETE`, the `TRUNCATE` statement does not invoke `ON DELETE` triggers.

`TRUNCATE TABLE` requires the `DROP` privilege as of MySQL 5.1.16. (Before 5.1.16, it requires the `DELETE` privilege.)

## 12.2.11. UPDATE Syntax

Single-table syntax:

```
UPDATE [LOW_PRIORITY] [IGNORE] table_reference
SET col_name1={expr1|DEFAULT} [, col_name2={expr2|DEFAULT}] ...
[WHERE where_condition]
[ORDER BY ...]
[LIMIT row_count]
```

Multiple-table syntax:

```
UPDATE [LOW_PRIORITY] [IGNORE] table_references
SET col_name1={expr1|DEFAULT} [, col_name2={expr2|DEFAULT}] ...
[WHERE where_condition]
```

For the single-table syntax, the `UPDATE` statement updates columns of existing rows in the named table with new values. The `SET` clause indicates which columns to modify and the values they should be given. Each value can be given as an expression, or the keyword `DEFAULT` to set a column explicitly to its default value. The `WHERE` clause, if given, specifies the conditions that identify which rows to update. With no `WHERE` clause, all rows are updated. If the `ORDER BY` clause is specified, the rows are updated in the order that is specified. The `LIMIT` clause places a limit on the number of rows that can be updated.

For the multiple-table syntax, `UPDATE` updates rows in each table named in `table_references` that satisfy the conditions. In this case, `ORDER BY` and `LIMIT` cannot be used.

`where_condition` is an expression that evaluates to true for each row to be updated.

`table_references` and `where_condition` are specified as described in [Section 12.2.8, “SELECT Syntax”](#).

The `UPDATE` statement supports the following modifiers:

- If you use the `LOW_PRIORITY` keyword, execution of the `UPDATE` is delayed until no other clients are reading from the table. This affects only storage engines that use only table-level locking ([MyISAM](#), [MEMORY](#), [MERGE](#)).
- If you use the `IGNORE` keyword, the update statement does not abort even if errors occur during the update. Rows for which duplicate-key conflicts occur are not updated. Rows for which columns are updated to values that would cause data conversion errors are updated to the closest valid values instead.

If you access a column from the table to be updated in an expression, `UPDATE` uses the current value of the column. For example, the following statement sets the `age` column to one more than its current value:

```
UPDATE persondata SET age=age+1;
```

Single-table `UPDATE` assignments are generally evaluated from left to right. For multiple-table updates, there is no guarantee that assignments are carried out in any particular order.

If you set a column to the value it currently has, MySQL notices this and does not update it.

If you update a column that has been declared `NOT NULL` by setting to `NULL`, an error occurs if strict SQL mode is enabled; otherwise, the column is set to the implicit default value for the column data type and the warning count is incremented. The implicit default value is `0` for numeric types, the empty string (`' '`) for string types, and the “zero” value for date and time types. See [Section 10.1.4, “Data Type Default Values”](#).

`UPDATE` returns the number of rows that were actually changed. The `mysql_info()` C API function returns the number of rows that were matched and updated and the number of warnings that occurred during the `UPDATE`.

You can use `LIMIT row_count` to restrict the scope of the `UPDATE`. A `LIMIT` clause is a rows-matched restriction. The statement stops as soon as it has found `row_count` rows that satisfy the `WHERE` clause, whether or not they actually were changed.

If an `UPDATE` statement includes an `ORDER BY` clause, the rows are updated in the order specified by the clause. This can be useful in certain situations that might otherwise result in an error. Suppose that a table `t` contains a column `id` that has a unique index. The following statement could fail with a duplicate-key error, depending on the order in which rows are updated:



```
UPDATE t SET id = id + 1;
```

For example, if the table contains 1 and 2 in the `id` column and 1 is updated to 2 before 2 is updated to 3, an error occurs. To avoid this problem, add an `ORDER BY` clause to cause the rows with larger `id` values to be updated before those with smaller values:

```
UPDATE t SET id = id + 1 ORDER BY id DESC;
```

You can also perform `UPDATE` operations covering multiple tables. However, you cannot use `ORDER BY` or `LIMIT` with a multiple-table `UPDATE`. The `table_references` clause lists the tables involved in the join. Its syntax is described in [Section 12.2.8.1, “JOIN Syntax”](#). Here is an example:

```
UPDATE items,month SET items.price=month.price
WHERE items.id=month.id;
```

The preceding example shows an inner join that uses the comma operator, but multiple-table `UPDATE` statements can use any type of join allowed in `SELECT` statements, such as `LEFT JOIN`.

You need the `UPDATE` privilege only for columns referenced in a multiple-table `UPDATE` that are actually updated. You need only the `SELECT` privilege for any columns that are read but not modified.

If you use a multiple-table `UPDATE` statement involving `InnoDB` tables for which there are foreign key constraints, the MySQL optimizer might process tables in an order that differs from that of their parent/child relationship. In this case, the statement fails and rolls back. Instead, update a single table and rely on the `ON UPDATE` capabilities that `InnoDB` provides to cause the other tables to be modified accordingly. See [Section 13.6.4.4, “FOREIGN KEY Constraints”](#).

Currently, you cannot update a table and select from the same table in a subquery.

Index hints (see [Section 12.2.8.2, “Index Hint Syntax”](#)) are accepted but ignored for `UPDATE` statements.

## 12.3. MySQL Utility Statements

### 12.3.1. DESCRIBE Syntax

```
{DESCRIBE | DESC} tbl_name [col_name | wild]
```

`DESCRIBE` provides information about the columns in a table. It is a shortcut for `SHOW COLUMNS FROM`. These statements also display information for views. (See [Section 12.5.5.6, “SHOW COLUMNS Syntax”](#).)

`col_name` can be a column name, or a string containing the SQL “%” and “\_” wildcard characters to obtain output only for the columns with names matching the string. There is no need to enclose the string within quotes unless it contains spaces or other special characters.

```
mysql> DESCRIBE City;
```

Field	Type	Null	Key	Default	Extra
Id	int(11)	NO	PRI	NULL	auto_increment
Name	char(35)	NO			
Country	char(3)	NO	UNI		
District	char(20)	YES	MUL		
Population	int(11)	NO		0	

5 rows in set (0.00 sec)

The description for `SHOW COLUMNS` provides more information about the output columns (see [Section 12.5.5.6, “SHOW COLUMNS Syntax”](#)).

If the data types differ from what you expect them to be based on a `CREATE TABLE` statement, note that MySQL sometimes changes data types when you create or alter a table. The conditions under which this occurs are described in [Section 12.1.17.1, “Silent Column Specification Changes”](#).

The `DESCRIBE` statement is provided for compatibility with Oracle.

The `SHOW CREATE TABLE`, `SHOW TABLE STATUS`, and `SHOW INDEX` statements also provide information about tables. See [Section 12.5.5, “SHOW Syntax”](#).

### 12.3.2. EXPLAIN Syntax

```
EXPLAIN tbl_name
```

Or:

```
EXPLAIN [EXTENDED | PARTITIONS] SELECT select_options
```

The `EXPLAIN` statement can be used either as a synonym for `DESCRIBE` or as a way to obtain information about how MySQL executes a `SELECT` statement:

- `EXPLAIN tbl_name` is synonymous with `DESCRIBE tbl_name` or `SHOW COLUMNS FROM tbl_name`.

For a description of the `DESCRIBE` and `SHOW COLUMNS` statements, see [Section 12.3.1, “DESCRIBE Syntax”](#), and [Section 12.5.5.6, “SHOW COLUMNS Syntax”](#).

- When you precede a `SELECT` statement with the keyword `EXPLAIN`, MySQL displays information from the optimizer about the query execution plan. That is, MySQL explains how it would process the `SELECT`, including information about how tables are joined and in which order. `EXPLAIN EXTENDED` can be used to provide additional information.

For information regarding the use of `EXPLAIN` and `EXPLAIN EXTENDED` for obtaining query execution plan information, see [Section 7.2.1, “Optimizing Queries with EXPLAIN”](#).

- `EXPLAIN PARTITIONS` is available beginning with MySQL 5.1.5. It is useful only when examining queries involving partitioned tables.

For details, see [Section 17.3.4, “Obtaining Information About Partitions”](#).

### 12.3.3. HELP Syntax

```
HELP 'search_string'
```

The `HELP` statement returns online information from the MySQL Reference manual. Its proper operation requires that the help tables in the `mysql` database be initialized with help topic information (see [Section 5.1.8, “Server-Side Help”](#)).

The `HELP` statement searches the help tables for the given search string and displays the result of the search. The search string is not case sensitive.

The `HELP` statement understands several types of search strings:

- At the most general level, use `contents` to retrieve a list of the top-level help categories:

```
HELP 'contents'
```

- For a list of topics in a given help category, such as `Data Types`, use the category name:

```
HELP 'data types'
```

- For help on a specific help topic, such as the `ASCII()` function or the `CREATE TABLE` statement, use the associated keyword or keywords:

```
HELP 'ascii'  
HELP 'create table'
```

In other words, the search string matches a category, many topics, or a single topic. You cannot necessarily tell in advance whether a given search string will return a list of items or the help information for a single help topic. However, you can tell what kind of response `HELP` returned by examining the number of rows and columns in the result set.

The following descriptions indicate the forms that the result set can take. Output for the example statements is shown using the familiar “tabular” or “vertical” format that you see when using the `mysql` client, but note that `mysql` itself reformats `HELP` result sets in a different way.

- Empty result set  
No match could be found for the search string.
- Result set containing a single row with three columns

This means that the search string yielded a hit for the help topic. The result has three columns:

- **name**: The topic name.
- **description**: Descriptive help text for the topic.
- **example**: Usage example or examples. This column might be blank.

Example: `HELP 'replace'`

Yields:

```
name: REPLACE
description: Syntax:
REPLACE(str,from_str,to_str)

Returns the string str with all occurrences of the string from_str
replaced by the string to_str. REPLACE() performs a case-sensitive
match when searching for from_str.
example: mysql> SELECT REPLACE('www.mysql.com', 'w', 'Ww');
-> 'WwWwWw.mysql.com'
```

- Result set containing multiple rows with two columns

This means that the search string matched many help topics. The result set indicates the help topic names:

- **name**: The help topic name.
- **is\_it\_category**: **Y** if the name represents a help category, **N** if it does not. If it does not, the **name** value when specified as the argument to the `HELP` statement should yield a single-row result set containing a description for the named item.

Example: `HELP 'status'`

Yields:

name	is_it_category
SHOW	N
SHOW ENGINE	N
SHOW INNODB STATUS	N
SHOW MASTER STATUS	N
SHOW PROCEDURE STATUS	N
SHOW SLAVE STATUS	N
SHOW STATUS	N
SHOW TABLE STATUS	N

- Result set containing multiple rows with three columns

This means the search string matches a category. The result set contains category entries:

- **source\_category\_name**: The help category name.
- **name**: The category or topic name
- **is\_it\_category**: **Y** if the name represents a help category, **N** if it does not. If it does not, the **name** value when specified as the argument to the `HELP` statement should yield a single-row result set containing a description for the named item.

Example: `HELP 'functions'`

Yields:

source_category_name	name	is_it_category
Functions	CREATE FUNCTION	N
Functions	DROP FUNCTION	N
Functions	Bit Functions	Y
Functions	Comparison operators	Y
Functions	Control flow functions	Y
Functions	Date and Time Functions	Y
Functions	Encryption Functions	Y
Functions	Information Functions	Y
Functions	Logical operators	Y
Functions	Miscellaneous Functions	Y
Functions	Numeric Functions	Y

Functions	String Functions	Y

Before MySQL 5.1.17, if you intend to use the `HELP` statement while other tables are locked with `LOCK TABLES`, you must also lock the required `mysql.help_XXX` tables. See [Section 12.4.5, “LOCK TABLES and UNLOCK TABLES Syntax”](#).

## 12.3.4. USE Syntax

```
USE db_name
```

The `USE db_name` statement tells MySQL to use the `db_name` database as the default (current) database for subsequent statements. The database remains the default until the end of the session or another `USE` statement is issued:

```
USE db1;
SELECT COUNT(*) FROM mytable; # selects from db1.mytable
USE db2;
SELECT COUNT(*) FROM mytable; # selects from db2.mytable
```

Making a particular database the default by means of the `USE` statement does not preclude you from accessing tables in other databases. The following example accesses the `author` table from the `db1` database and the `editor` table from the `db2` database:

```
USE db1;
SELECT author_name, editor_name FROM author, db2.editor
WHERE author.editor_id = db2.editor.editor_id;
```

The `USE` statement is provided for compatibility with Sybase.

## 12.4. MySQL Transactional and Locking Statements

MySQL supports local transactions (within a given client session) through statements such as `SET autocommit`, `START TRANSACTION`, `COMMIT`, and `ROLLBACK`. See [Section 12.4.1, “START TRANSACTION, COMMIT, and ROLLBACK Syntax”](#). XA transaction support enables MySQL to participate in distributed transactions as well. See [Section 12.4.7, “XA Transactions”](#).

### 12.4.1. START TRANSACTION, COMMIT, and ROLLBACK Syntax

```
START TRANSACTION [WITH CONSISTENT SNAPSHOT] | BEGIN [WORK]
COMMIT [WORK] [AND [NO] CHAIN] [[NO] RELEASE]
ROLLBACK [WORK] [AND [NO] CHAIN] [[NO] RELEASE]
SET autocommit = {0 | 1}
```

The `START TRANSACTION` or `BEGIN` statement begins a new transaction. `COMMIT` commits the current transaction, making its changes permanent. `ROLLBACK` rolls back the current transaction, canceling its changes. The `SET autocommit` statement disables or enables the default autocommit mode for the current session.

The optional `WORK` keyword is supported for `COMMIT` and `ROLLBACK`, as are the `CHAIN` and `RELEASE` clauses. `CHAIN` and `RELEASE` can be used for additional control over transaction completion. The value of the `completion_type` system variable determines the default completion behavior. See [Section 5.1.3, “Server System Variables”](#).

#### Note

Within all stored programs (stored procedures and functions, triggers, and events), the parser treats `BEGIN [WORK]` as the beginning of a `BEGIN . . . END` block. Begin a transaction in this context with `START TRANSACTION` instead.

The `AND CHAIN` clause causes a new transaction to begin as soon as the current one ends, and the new transaction has the same isolation level as the just-terminated transaction. The `RELEASE` clause causes the server to disconnect the current client session after terminating the current transaction. Including the `NO` keyword suppresses `CHAIN` or `RELEASE` completion, which can be useful if the `completion_type` system variable is set to cause chaining or release completion by default.

By default, MySQL runs with autocommit mode enabled. This means that as soon as you execute a statement that updates (modifies) a table, MySQL stores the update on disk to make it permanent. To disable autocommit mode, use the following statement:

```
SET autocommit=0;
```

After disabling autocommit mode by setting the `autocommit` variable to zero, changes to transaction-safe tables (such as those for `InnoDB` or `NDBCLUSTER`) are not made permanent immediately. You must use `COMMIT` to store your changes to disk or

`ROLLBACK` to ignore the changes.

To disable autocommit mode for a single series of statements, use the `START TRANSACTION` statement:

```
START TRANSACTION;
SELECT @A:=SUM(salary) FROM table1 WHERE type=1;
UPDATE table2 SET summary=@A WHERE type=1;
COMMIT;
```

With `START TRANSACTION`, autocommit remains disabled until you end the transaction with `COMMIT` or `ROLLBACK`. The autocommit mode then reverts to its previous state.

`BEGIN` and `BEGIN WORK` are supported as aliases of `START TRANSACTION` for initiating a transaction. `START TRANSACTION` is standard SQL syntax and is the recommended way to start an ad-hoc transaction.

### Important

Many APIs used for writing MySQL client applications (such as JDBC) provide their own methods for starting transactions that can (and sometimes should) be used instead of sending a `START TRANSACTION` statement from the client. See [Chapter 20, Connectors and APIs](#), or the documentation for your API, for more information.

The `BEGIN` statement differs from the use of the `BEGIN` keyword that starts a `BEGIN . . . END` compound statement. The latter does not begin a transaction. See [Section 12.8.1, “BEGIN . . . END Compound Statement Syntax”](#).

You can also begin a transaction like this:

```
START TRANSACTION WITH CONSISTENT SNAPSHOT;
```

The `WITH CONSISTENT SNAPSHOT` clause starts a consistent read for storage engines that are capable of it. This applies only to `InnoDB`. The effect is the same as issuing a `START TRANSACTION` followed by a `SELECT` from any `InnoDB` table. See [Section 13.6.8.2, “Consistent Non-Locking Reads”](#). The `WITH CONSISTENT SNAPSHOT` clause does not change the current transaction isolation level, so it provides a consistent snapshot only if the current isolation level is one that allows consistent read (`REPEATABLE READ` or `SERIALIZABLE`).

Beginning a transaction causes any pending transaction to be committed. See [Section 12.4.3, “Statements That Cause an Implicit Commit”](#), for more information.

Beginning a transaction also causes table locks acquired with `LOCK TABLES` to be released, as though you had executed `UNLOCK TABLES`. Beginning a transaction does not release a global read lock acquired with `FLUSH TABLES WITH READ LOCK`.

For best results, transactions should be performed using only tables managed by a single transaction-safe storage engine. Otherwise, the following problems can occur:

- If you use tables from more than one transaction-safe storage engine (such as `InnoDB` and `Falcon`), and the transaction isolation level is not `SERIALIZABLE`, it is possible that when one transaction commits, another ongoing transaction that uses the same tables will see only some of the changes made by the first transaction. That is, the atomicity of transactions is not guaranteed with mixed engines and inconsistencies can result. (If mixed-engine transactions are infrequent, you can use `SET TRANSACTION ISOLATION LEVEL` to set the isolation level to `SERIALIZABLE` on a per-transaction basis as necessary.)
- If you use tables that are not transaction-safe within a transaction, changes to those tables are stored at once, regardless of the status of autocommit mode.
- If you issue a `ROLLBACK` statement after updating a non-transactional table within a transaction, an `ER_WARNING_NOT_COMPLETE_ROLLBACK` warning occurs. Changes to transaction-safe tables are rolled back, but not changes to non-transaction-safe tables.

Each transaction is stored in the binary log in one chunk, upon `COMMIT`. Transactions that are rolled back are not logged. (**Exception:** Modifications to non-transactional tables cannot be rolled back. If a transaction that is rolled back includes modifications to non-transactional tables, the entire transaction is logged with a `ROLLBACK` statement at the end to ensure that modifications to the non-transactional tables are replicated.) See [Section 5.2.4, “The Binary Log”](#).

You can change the isolation level for transactions with `SET TRANSACTION ISOLATION LEVEL`. See [Section 12.4.6, “SET TRANSACTION Syntax”](#).

Rolling back can be a slow operation that may occur implicitly without the user having explicitly asked for it (for example, when an error occurs). Because of this, `SHOW PROCESSLIST` displays `Rolling back` in the `State` column for the session, not only for explicit rollbacks performed with the `ROLLBACK` statement but also for implicit rollbacks.

## 12.4.2. Statements That Cannot Be Rolled Back

Some statements cannot be rolled back. In general, these include data definition language (DDL) statements, such as those that create or drop databases, those that create, drop, or alter tables or stored routines.

You should design your transactions not to include such statements. If you issue a statement early in a transaction that cannot be rolled back, and then another statement later fails, the full effect of the transaction cannot be rolled back in such cases by issuing a `ROLLBACK` statement.

### 12.4.3. Statements That Cause an Implicit Commit

The statements listed in this section (and any synonyms for them) implicitly end a transaction, as if you had done a `COMMIT` before executing the statement.

- **Data definition language (DDL) statements that define or modify database objects.** `ALTER DATABASE . . . UPGRADE DATA DIRECTORY NAME`, `ALTER EVENT`, `ALTER PROCEDURE`, `ALTER TABLE`, `CREATE DATABASE`, `CREATE EVENT`, `CREATE INDEX`, `CREATE PROCEDURE`, `CREATE TABLE`, `DROP DATABASE`, `DROP EVENT`, `DROP INDEX`, `DROP PROCEDURE`, `DROP TABLE`, `RENAME TABLE`, `TRUNCATE TABLE`.

`ALTER FUNCTION`, `CREATE FUNCTION` and `DROP FUNCTION` also cause an implicit commit when used with stored functions, but not with UDFs. (`ALTER FUNCTION` can only be used with stored functions.)

`ALTER TABLE`, `CREATE TABLE`, and `DROP TABLE` do not commit a transaction if the `TEMPORARY` keyword is used. (This does not apply to other operations on temporary tables such as `CREATE INDEX`, which do cause a commit.) However, although no implicit commit occurs, neither can the statement be rolled back. Therefore, use of such statements will violate transaction atomicity: For example, if you use `CREATE TEMPORARY TABLE` and then roll back the transaction, the table remains in existence.

The `CREATE TABLE` statement in InnoDB is processed as a single transaction. This means that a `ROLLBACK` from the user does not undo `CREATE TABLE` statements the user made during that transaction.

Beginning with MySQL 5.1.3, `ALTER VIEW`, `CREATE TRIGGER`, `CREATE VIEW`, `DROP TRIGGER`, and `DROP VIEW` cause an implicit commit.

Beginning with MySQL 5.1.15, `CREATE TABLE . . . SELECT` causes an implicit commit before and after the statement is executed when you are creating non-temporary tables. (No commit occurs for `CREATE TEMPORARY TABLE . . . SELECT`.) This is to prevent an issue during replication where the table could be created on the master after a rollback, but fail to be recorded in the binary log, and therefore not replicated to the slave. For more information, see [Bug#22865](#).

- **Statements that implicitly use or modify tables in the `mysql` database.** Beginning with MySQL 5.1.3, `CREATE USER`, `DROP USER`, and `RENAME USER` cause an implicit commit. Beginning with MySQL 5.1.23, `GRANT`, `REVOKE`, and `SET PASSWORD` statements cause an implicit commit.
- **Transaction-control and locking statements.** `BEGIN`, `LOCK TABLES`, `SET autocommit = 1` (if the value is not already 1), `START TRANSACTION`, `UNLOCK TABLES`.

`UNLOCK TABLES` commits a transaction only if any tables currently have been locked with `LOCK TABLES`. This does not occur for `UNLOCK TABLES` following `FLUSH TABLES WITH READ LOCK` because the latter statement does not acquire table-level locks.

Transactions cannot be nested. This is a consequence of the implicit commit performed for any current transaction when you issue a `START TRANSACTION` statement or one of its synonyms.

Statements that cause an implicit commit cannot be used in an XA transaction while the transaction is in an `ACTIVE` state.

The `BEGIN` statement differs from the use of the `BEGIN` keyword that starts a `BEGIN . . . END` compound statement. The latter does not cause an implicit commit. See [Section 12.8.1, “BEGIN . . . END Compound Statement Syntax”](#).

- **Data loading statements.** `LOAD DATA INFILE`. Before MySQL 5.1.12, `LOAD DATA INFILE` caused an implicit commit for all storage engines. As of MySQL 5.1.12, it causes an implicit commit only for tables using the `NDB` storage engine. For more information, see [Bug#11151](#).
- **Administrative statements.** `CACHE INDEX`, `LOAD INDEX INTO CACHE`. Beginning with MySQL 5.1.10, `ANALYZE TABLE`, `CHECK TABLE`, `OPTIMIZE TABLE`, and `REPAIR TABLE` cause an implicit commit.

### 12.4.4. SAVEPOINT and ROLLBACK TO SAVEPOINT Syntax

```
SAVEPOINT identifier
ROLLBACK [WORK] TO [SAVEPOINT] identifier
RELEASE SAVEPOINT identifier
```

InnoDB supports the SQL statements `SAVEPOINT`, `ROLLBACK TO SAVEPOINT`, `RELEASE SAVEPOINT` and the optional `WORK` keyword for `ROLLBACK`.

The `SAVEPOINT` statement sets a named transaction savepoint with a name of *identifier*. If the current transaction has a savepoint with the same name, the old savepoint is deleted and a new one is set.

The `ROLLBACK TO SAVEPOINT` statement rolls back a transaction to the named savepoint without terminating the transaction. Modifications that the current transaction made to rows after the savepoint was set are undone in the rollback, but InnoDB does *not* release the row locks that were stored in memory after the savepoint. (For a new inserted row, the lock information is carried by the transaction ID stored in the row; the lock is not separately stored in memory. In this case, the row lock is released in the undo.) Savepoints that were set at a later time than the named savepoint are deleted.

If the `ROLLBACK TO SAVEPOINT` statement returns the following error, it means that no savepoint with the specified name exists:

```
ERROR 1181: Got error 153 during ROLLBACK
```

The `RELEASE SAVEPOINT` statement removes the named savepoint from the set of savepoints of the current transaction. No commit or rollback occurs. It is an error if the savepoint does not exist.

All savepoints of the current transaction are deleted if you execute a `COMMIT`, or a `ROLLBACK` that does not name a savepoint.

A new savepoint level is created when a stored function is invoked or a trigger is activated. The savepoints on previous levels become unavailable and thus do not conflict with savepoints on the new level. When the function or trigger terminates, any savepoints it created are released and the previous savepoint level is restored.

## 12.4.5. LOCK TABLES and UNLOCK TABLES Syntax

```
LOCK TABLES
  tbl_name [[AS] alias] lock_type
  [, tbl_name [[AS] alias] lock_type] ...

lock_type:
  READ [LOCAL]
  | [LOW_PRIORITY] WRITE

UNLOCK TABLES
```

MySQL enables client sessions to acquire table locks explicitly for the purpose of cooperating with other sessions for access to tables, or to prevent other sessions from modifying tables during periods when a session requires exclusive access to them. A session can acquire or release locks only for itself. One session cannot acquire locks for another session or release locks held by another session.

Locks may be used to emulate transactions or to get more speed when updating tables. This is explained in more detail later in this section.

`LOCK TABLES` explicitly acquires table locks for the current client session. Table locks can be acquired for base tables or views. You must have the `LOCK TABLES` privilege, and the `SELECT` privilege for each object to be locked.

For view locking, `LOCK TABLES` adds all base tables used in the view to the set of tables to be locked and locks them automatically. If you lock a table explicitly with `LOCK TABLES`, any tables used in triggers are also locked implicitly, as described in [Section 12.4.5.2, “LOCK TABLES and Triggers”](#).

`UNLOCK TABLES` explicitly releases any table locks held by the current session.

Another use for `UNLOCK TABLES` is to release the global read lock acquired with the `FLUSH TABLES WITH READ LOCK` statement, which enables you to lock all tables in all databases. See [Section 12.5.6.3, “FLUSH Syntax”](#). (This is a very convenient way to get backups if you have a file system such as Veritas that can take snapshots in time.)

The following discussion applies only to non-`TEMPORARY` tables. `LOCK TABLES` is allowed (but ignored) for a `TEMPORARY` table. The table can be accessed freely by the session within which it was created, regardless of what other locking may be in effect. No lock is necessary because no other session can see the table.

The following general rules apply to acquisition and release of locks by a given session:

- Table locks are acquired with `LOCK TABLES`.
- If the `LOCK TABLES` statement must wait due to locks held by other sessions on any of the tables, it blocks until all locks can be acquired.
- Table locks are released explicitly with `UNLOCK TABLES`.



- Table locks are released implicitly under these conditions:
  - `LOCK TABLES` releases any table locks currently held by the session before acquiring new locks.
  - Beginning a transaction (for example, with `START TRANSACTION`) implicitly performs an `UNLOCK TABLES`. (Additional information about the interaction between table locking and transactions is given in [Section 12.4.5.1](#), “Interaction of Table Locking and Transactions”.)
  - If a client connection drops, the server releases table locks held by the client. If the client reconnects, the locks will no longer be in effect. In addition, if the client had an active transaction, the server rolls back the transaction upon disconnect, and if reconnect occurs, the new session begins with autocommit enabled. For this reason, clients may wish to disable auto-reconnect. With auto-reconnect in effect, the client is not notified if reconnect occurs but any table locks or current transaction will have been lost. With auto-reconnect disabled, if the connection drops, an error occurs for the next statement issued. The client can detect the error and take appropriate action such as reacquiring the locks or redoing the transaction. See [Section 20.10.11](#), “Controlling Automatic Reconnection Behavior”.

### Note

If you use `ALTER TABLE` on a locked table, it may become unlocked. See [Section B.1.7.1](#), “Problems with `ALTER TABLE`”.

A table lock protects only against inappropriate reads or writes by other clients. The client holding the lock, even a read lock, can perform table-level operations such as `DROP TABLE`. Truncate operations are not transaction-safe, so an error occurs if the client attempts one during an active transaction or while holding a table lock.

A session that requires locks must acquire all the locks that it needs in a single `LOCK TABLES` statement. While the locks thus obtained are held, the session can access only the locked tables. For example, in the following sequence of statements, an error occurs for the attempt to access `t2` because it was not locked in the `LOCK TABLES` statement:

```
mysql> LOCK TABLES t1 READ;
mysql> SELECT COUNT(*) FROM t1;
+-----+
| COUNT(*) |
+-----+
|          3 |
+-----+
mysql> SELECT COUNT(*) FROM t2;
ERROR 1100 (HY000): Table 't2' was not locked with LOCK TABLES
```

Tables in the `INFORMATION_SCHEMA` database are an exception. They can be accessed without being locked explicitly even while a session holds table locks obtained with `LOCK TABLES`.

You cannot refer to a locked table multiple times in a single query using the same name. Use aliases instead, and obtain a separate lock for the table and each alias:

```
mysql> LOCK TABLE t WRITE, t AS t1 READ;
mysql> INSERT INTO t SELECT * FROM t;
ERROR 1100: Table 't' was not locked with LOCK TABLES
mysql> INSERT INTO t SELECT * FROM t AS t1;
```

The error occurs for the first `INSERT` because there are two references to the same name for a locked table. The second `INSERT` succeeds because the references to the table use different names.

If your statements refer to a table by means of an alias, you must lock the table using that same alias. It does not work to lock the table without specifying the alias:

```
mysql> LOCK TABLE t READ;
mysql> SELECT * FROM t AS myalias;
ERROR 1100: Table 'myalias' was not locked with LOCK TABLES
```

Conversely, if you lock a table using an alias, you must refer to it in your statements using that alias:

```
mysql> LOCK TABLE t AS myalias READ;
mysql> SELECT * FROM t;
ERROR 1100: Table 't' was not locked with LOCK TABLES
mysql> SELECT * FROM t AS myalias;
```

If a session obtains a `READ` lock on a table, that session (and all other sessions) can only read from the table. If a session obtains a `WRITE` lock on a table, only the session holding the lock can write to the table (that session can also read from the table); other sessions are blocked from reading or writing the locked table until the lock has been released.

The difference between `READ` and `READ LOCAL` is that `READ LOCAL` allows non-conflicting `INSERT` statements (concurrent in-



serts) to execute while the lock is held. However, `READ LOCAL` cannot be used if you are going to manipulate the database using processes external to the server while you hold the lock. For `InnoDB` tables, `READ LOCAL` is the same as `READ`.

`WRITE` locks normally have higher priority than `READ` locks to ensure that updates are processed as soon as possible. This means that if one session obtains a `READ` lock and then another session requests a `WRITE` lock, subsequent `READ` lock requests wait until the session that requested the `WRITE` lock has obtained the lock and released it. A request for a `LOW_PRIORITY WRITE` lock, by contrast, allows subsequent `READ` lock requests by other sessions to be satisfied first if they occur while the `LOW_PRIORITY WRITE` request is waiting. You should use `LOW_PRIORITY WRITE` locks only if you are sure that eventually there will be a time when no sessions have a `READ` lock. For `InnoDB` tables in transactional mode (`autocommit = 0`), a waiting `LOW_PRIORITY WRITE` lock acts like a regular `WRITE` lock and causes subsequent `READ` lock requests to wait.

`LOCK TABLES` acquires locks as follows:

1. Sort all tables to be locked in an internally defined order. From the user standpoint, this order is undefined.
2. If a table is to be locked with a read and a write lock, put the write lock request before the read lock request.
3. Lock one table at a time until the session gets all locks.

This policy ensures that table locking is deadlock free. There are, however, other things you need to be aware of about this policy: If you are using a `LOW_PRIORITY WRITE` lock for a table, it means only that MySQL waits for this particular lock until there are no other sessions that want a `READ` lock. When the session has gotten the `WRITE` lock and is waiting to get the lock for the next table in the lock table list, all other sessions wait for the `WRITE` lock to be released. If this becomes a serious problem with your application, you should consider converting some of your tables to transaction-safe tables.

### 12.4.5.1. Interaction of Table Locking and Transactions

`LOCK TABLES` and `UNLOCK TABLES` interact with the use of transactions as follows:

- `LOCK TABLES` is not transaction-safe and implicitly commits any active transaction before attempting to lock the tables.
- `UNLOCK TABLES` implicitly commits any active transaction, but only if `LOCK TABLES` has been used to acquire table locks. For example, in the following set of statements, `UNLOCK TABLES` releases the global read lock but does not commit the transaction because no table locks are in effect:

```
FLUSH TABLES WITH READ LOCK;
START TRANSACTION;
SELECT ... ;
UNLOCK TABLES;
```

- Beginning a transaction (for example, with `START TRANSACTION`) implicitly commits any current transaction and releases existing locks.
- Other statements that implicitly cause transactions to be committed do not release existing locks. For a list of such statements, see [Section 12.4.3, “Statements That Cause an Implicit Commit”](#).
- The correct way to use `LOCK TABLES` and `UNLOCK TABLES` with transactional tables, such as `InnoDB` tables, is to begin a transaction with `SET autocommit = 0` (not `START TRANSACTION`) followed by `LOCK TABLES`, and to not call `UNLOCK TABLES` until you commit the transaction explicitly. For example, if you need to write to table `t1` and read from table `t2`, you can do this:

```
SET autocommit=0;
LOCK TABLES t1 WRITE, t2 READ, ...;
... do something with tables t1 and t2 here ...
COMMIT;
UNLOCK TABLES;
```

When you call `LOCK TABLES`, `InnoDB` internally takes its own table lock, and MySQL takes its own table lock. `InnoDB` releases its internal table lock at the next commit, but for MySQL to release its table lock, you have to call `UNLOCK TABLES`. You should not have `autocommit = 1`, because then `InnoDB` releases its internal table lock immediately after the call of `LOCK TABLES`, and deadlocks can very easily happen. `InnoDB` does not acquire the internal table lock at all if `autocommit = 1`, to help old applications avoid unnecessary deadlocks.

- `ROLLBACK` does not release table locks.
- `FLUSH TABLES WITH READ LOCK` acquires a global read lock and not table locks, so it is not subject to the same behavior as `LOCK TABLES` and `UNLOCK TABLES` with respect to table locking and implicit commits. See [Section 12.5.6.3, “FLUSH Syntax”](#).

### 12.4.5.2. LOCK TABLES and Triggers

If you lock a table explicitly with `LOCK TABLES`, any tables used in triggers are also locked implicitly:

- The locks are taken at the same time as those acquired explicitly with the `LOCK TABLES` statement.
- The lock on a table used in a trigger depends on whether the table is used only for reading. If so, a read lock suffices. Otherwise, a write lock is used.
- If a table is locked explicitly for reading with `LOCK TABLES`, but needs to be locked for writing because it might be modified within a trigger, a write lock is taken rather than a read lock. (That is, an implicit write lock needed due to the table's appearance within a trigger causes an explicit read lock request for the table to be converted to a write lock request.)

Suppose that you lock two tables, `t1` and `t2`, using this statement:

```
LOCK TABLES t1 WRITE, t2 READ;
```

If `t1` or `t2` have any triggers, tables used within the triggers will also be locked. Suppose that `t1` has a trigger defined like this:

```
CREATE TRIGGER t1_a_ins AFTER INSERT ON t1 FOR EACH ROW
BEGIN
  UPDATE t4 SET count = count+1
  WHERE id = NEW.id AND EXISTS (SELECT a FROM t3);
  INSERT INTO t2 VALUES(1, 2);
END;
```

The result of the `LOCK TABLES` statement is that `t1` and `t2` are locked because they appear in the statement, and `t3` and `t4` are locked because they are used within the trigger:

- `t1` is locked for writing per the `WRITE` lock request.
- `t2` is locked for writing, even though the request is for a `READ` lock. This occurs because `t2` is inserted into within the trigger, so the `READ` request is converted to a `WRITE` request.
- `t3` is locked for reading because it is only read from within the trigger.
- `t4` is locked for writing because it might be updated within the trigger.

### 12.4.5.3. Other Table-Locking Notes

You can safely use `KILL` to terminate a session that is waiting for a table lock. See [Section 12.5.6.4, “KILL Syntax”](#).

You should *not* lock any tables that you are using with `INSERT DELAYED`. An `INSERT DELAYED` in this case results in an error because the insert must be handled by a separate thread, not by the session which holds the lock.

For some operations, system tables in the `mysql` database must be accessed. For example, the `HELP` statement requires the contents of the server-side help tables, and `CONVERT_TZ()` might need to read the time zone tables. Before MySQL 5.1.17, to perform such operations while a `LOCK TABLES` statement is in effect, you must also lock the requisite system tables explicitly or a lock error occurs. As of 5.1.17, the server implicitly locks the system tables for reading as necessary so that you need not lock them explicitly. These tables are treated as just described:

```
mysql.help_category
mysql.help_keyword
mysql.help_relation
mysql.help_topic
mysql.proc
mysql.time_zone
mysql.time_zone_leap_second
mysql.time_zone_name
mysql.time_zone_transition
mysql.time_zone_transition_type
```

If you want to explicitly place a `WRITE` lock on any of those tables with a `LOCK TABLES` statement, the table must be the only one locked; no other table can be locked with the same statement.

Normally, you do not need to lock tables, because all single `UPDATE` statements are atomic; no other session can interfere with any other currently executing SQL statement. However, there are a few cases when locking tables may provide an advantage:

- If you are going to run many operations on a set of `MyISAM` tables, it is much faster to lock the tables you are going to use. Locking `MyISAM` tables speeds up inserting, updating, or deleting on them because MySQL does not flush the key cache for the locked tables until `UNLOCK TABLES` is called. Normally, the key cache is flushed after each SQL statement.

The downside to locking the tables is that no session can update a `READ`-locked table (including the one holding the lock) and no session can access a `WRITE`-locked table other than the one holding the lock.

- If you are using tables for a non-transactional storage engine, you must use `LOCK TABLES` if you want to ensure that no other session modifies the tables between a `SELECT` and an `UPDATE`. The example shown here requires `LOCK TABLES` to execute safely:

```
LOCK TABLES trans READ, customer WRITE;
SELECT SUM(value) FROM trans WHERE customer_id=some_id;
UPDATE customer
  SET total_value=sum_from_previous_statement
  WHERE customer_id=some_id;
UNLOCK TABLES;
```

Without `LOCK TABLES`, it is possible that another session might insert a new row in the `trans` table between execution of the `SELECT` and `UPDATE` statements.

You can avoid using `LOCK TABLES` in many cases by using relative updates (`UPDATE customer SET value=value+new_value`) or the `LAST_INSERT_ID()` function. See [Section 1.7.5.2, “Transactions and Atomic Operations”](#).

You can also avoid locking tables in some cases by using the user-level advisory lock functions `GET_LOCK()` and `RELEASE_LOCK()`. These locks are saved in a hash table in the server and implemented with `pthread_mutex_lock()` and `pthread_mutex_unlock()` for high speed. See [Section 11.11.4, “Miscellaneous Functions”](#).

See [Section 7.3.1, “Internal Locking Methods”](#), for more information on locking policy.

## 12.4.6. SET TRANSACTION Syntax

```
SET [GLOBAL | SESSION] TRANSACTION ISOLATION LEVEL
{
  READ UNCOMMITTED
  READ COMMITTED
  REPEATABLE READ
  SERIALIZABLE
}
```

This statement sets the transaction isolation level globally, for the current session, or for the next transaction:

- With the `GLOBAL` keyword, the statement sets the default transaction level globally for all subsequent sessions. Existing sessions are unaffected.
- With the `SESSION` keyword, the statement sets the default transaction level for all subsequent transactions performed within the current session.
- Without any `SESSION` or `GLOBAL` keyword, the statement sets the isolation level for the next (not started) transaction performed within the current session.

A change to the global default isolation level requires the `SUPER` privilege. Any session is free to change its session isolation level (even in the middle of a transaction), or the isolation level for its next transaction.

To set the global default isolation level at server startup, use the `--transaction-isolation=level` option to `mysqld` on the command line or in an option file. Values of `level` for this option use dashes rather than spaces, so the allowable values are `READ-UNCOMMITTED`, `READ-COMMITTED`, `REPEATABLE-READ`, or `SERIALIZABLE`. For example, to set the default isolation level to `REPEATABLE READ`, use these lines in the `[mysqld]` section of an option file:

```
[mysqld]
transaction-isolation = REPEATABLE-READ
```

To determine the global and session transaction isolation levels at runtime, check the value of the `tx_isolation` system variable:

```
SELECT @@GLOBAL.tx_isolation, @@tx_isolation;
```

`InnoDB` supports each of the transaction isolation levels described here using different locking strategies. The default level is `RE-`

**REPEATABLE READ.** For additional information about **InnoDB** record-level locks and how it uses them to execute various types of statements, see [Section 13.6.8.4, “InnoDB Record, Gap, and Next-Key Locks”](#), and [Section 13.6.8.6, “Locks Set by Different SQL Statements in InnoDB”](#).

The following list describes how MySQL supports the different transaction levels:

- **READ UNCOMMITTED**

**SELECT** statements are performed in a non-locking fashion, but a possible earlier version of a row might be used. Thus, using this isolation level, such reads are not consistent. This is also called a “dirty read.” Otherwise, this isolation level works like **READ COMMITTED**.

- **READ COMMITTED**

A somewhat Oracle-like isolation level with respect to consistent (non-locking) reads: Each consistent read, even within the same transaction, sets and reads its own fresh snapshot. See [Section 13.6.8.2, “Consistent Non-Locking Reads”](#).

For locking reads (**SELECT** with **FOR UPDATE** or **LOCK IN SHARE MODE**), **InnoDB** locks only index records, not the gaps before them, and thus allows the free insertion of new records next to locked records. For **UPDATE** and **DELETE** statements, locking depends on whether the statement uses a unique index with a unique search condition (such as **WHERE id = 100**), or a range-type search condition (such as **WHERE id > 100**). For a unique index with a unique search condition, **InnoDB** locks only the index record found, not the gap before it. For range-type searches, **InnoDB** locks the index range scanned, using gap locks or next-key (gap plus index-record) locks to block insertions by other sessions into the gaps covered by the range. This is necessary because “phantom rows” must be blocked for MySQL replication and recovery to work.

### Note

In MySQL 5.1, if the **READ COMMITTED** isolation level is used or the `innodb_locks_unsafe_for_binlog` system variable is enabled, there is no **InnoDB** gap locking except for foreign-key constraint checking and duplicate-key checking. Also, record locks for non-matching rows are released after MySQL has evaluated the **WHERE** condition.

As of MySQL 5.1, if you use **READ COMMITTED** or enable `innodb_locks_unsafe_for_binlog`, you *must* use row-based binary logging.

- **REPEATABLE READ**

This is the default isolation level for **InnoDB**. For consistent reads, there is an important difference from the **READ COMMITTED** isolation level: All consistent reads within the same transaction read the snapshot established by the first read. This convention means that if you issue several plain (non-locking) **SELECT** statements within the same transaction, these **SELECT** statements are consistent also with respect to each other. See [Section 13.6.8.2, “Consistent Non-Locking Reads”](#).

For locking reads (**SELECT** with **FOR UPDATE** or **LOCK IN SHARE MODE**), **UPDATE**, and **DELETE** statements, locking depends on whether the statement uses a unique index with a unique search condition, or a range-type search condition. For a unique index with a unique search condition, **InnoDB** locks only the index record found, not the gap before it. For other search conditions, **InnoDB** locks the index range scanned, using gap locks or next-key (gap plus index-record) locks to block insertions by other sessions into the gaps covered by the range.

- **SERIALIZABLE**

This level is like **REPEATABLE READ**, but **InnoDB** implicitly converts all plain **SELECT** statements to **SELECT . . . LOCK IN SHARE MODE** if autocommit is disabled. If autocommit is enabled, the **SELECT** is its own transaction. It therefore is known to be read only and can be serialized if performed as a consistent (non-locking) read and need not block for other transactions. (This means that to force a plain **SELECT** to block if other transactions have modified the selected rows, you should disable autocommit.)

## 12.4.7. XA Transactions

Support for XA transactions is available for the **InnoDB** storage engine. The MySQL XA implementation is based on the X/Open CAE document *Distributed Transaction Processing: The XA Specification*. This document is published by The Open Group and available at <http://www.opengroup.org/public/pubs/catalog/c193.htm>. Limitations of the current XA implementation are described in [Section D.5, “Restrictions on XA Transactions”](#).

On the client side, there are no special requirements. The XA interface to a MySQL server consists of SQL statements that begin with the **XA** keyword. MySQL client programs must be able to send SQL statements and to understand the semantics of the XA statement interface. They do not need to be linked against a recent client library. Older client libraries also will work.

Currently, among the MySQL Connectors, MySQL Connector/J 5.0.0 supports XA directly (by means of a class interface that handles the Xan SQL statement interface for you).

XA supports distributed transactions; that is, the ability to allow multiple separate transactional resources to participate in a global transaction. Transactional resources often are RDBMSs but may be other kinds of resources.

A global transaction involves several actions that are transactional in themselves, but that all must either complete successfully as a group, or all be rolled back as a group. In essence, this extends ACID properties “up a level” so that multiple ACID transactions can be executed in concert as components of a global operation that also has ACID properties. (However, for a distributed transaction, you must use the `SERIALIZABLE` isolation level to achieve ACID properties. It is enough to use `REPEATABLE READ` for a non-distributed transaction, but not for a distributed transaction.)

Some examples of distributed transactions:

- An application may act as an integration tool that combines a messaging service with an RDBMS. The application makes sure that transactions dealing with message sending, retrieval, and processing that also involve a transactional database all happen in a global transaction. You can think of this as “transactional email.”
- An application performs actions that involve different database servers, such as a MySQL server and an Oracle server (or multiple MySQL servers), where actions that involve multiple servers must happen as part of a global transaction, rather than as separate transactions local to each server.
- A bank keeps account information in an RDBMS and distributes and receives money via automated teller machines (ATMs). It is necessary to ensure that ATM actions are correctly reflected in the accounts, but this cannot be done with the RDBMS alone. A global transaction manager integrates the ATM and database resources to ensure overall consistency of financial transactions.

Applications that use global transactions involve one or more Resource Managers and a Transaction Manager:

- A Resource Manager (RM) provides access to transactional resources. A database server is one kind of resource manager. It must be possible to either commit or roll back transactions managed by the RM.
- A Transaction Manager (TM) coordinates the transactions that are part of a global transaction. It communicates with the RMs that handle each of these transactions. The individual transactions within a global transaction are “branches” of the global transaction. Global transactions and their branches are identified by a naming scheme described later.

The MySQL implementation of XA MySQL enables a MySQL server to act as a Resource Manager that handles XA transactions within a global transaction. A client program that connects to the MySQL server acts as the Transaction Manager.

To carry out a global transaction, it is necessary to know which components are involved, and bring each component to a point when it can be committed or rolled back. Depending on what each component reports about its ability to succeed, they must all commit or roll back as an atomic group. That is, either all components must commit, or all components must roll back. To manage a global transaction, it is necessary to take into account that any component or the connecting network might fail.

The process for executing a global transaction uses two-phase commit (2PC). This takes place after the actions performed by the branches of the global transaction have been executed.

1. In the first phase, all branches are prepared. That is, they are told by the TM to get ready to commit. Typically, this means each RM that manages a branch records the actions for the branch in stable storage. The branches indicate whether they are able to do this, and these results are used for the second phase.
2. In the second phase, the TM tells the RMs whether to commit or roll back. If all branches indicated when they were prepared that they will be able to commit, all branches are told to commit. If any branch indicated when it was prepared that it will not be able to commit, all branches are told to roll back.

In some cases, a global transaction might use one-phase commit (1PC). For example, when a Transaction Manager finds that a global transaction consists of only one transactional resource (that is, a single branch), that resource can be told to prepare and commit at the same time.

### 12.4.7.1. XA Transaction SQL Syntax

To perform XA transactions in MySQL, use the following statements:

```
XA {START|BEGIN} xid [JOIN|RESUME]
XA END xid [SUSPEND [FOR MIGRATE]]
XA PREPARE xid
XA COMMIT xid [ONE PHASE]
```

```
XA ROLLBACK xid
XA RECOVER
```

For **XA START**, the **JOIN** and **RESUME** clauses are not supported.

For **XA END** the **SUSPEND [FOR MIGRATE]** clause is not supported.

Each XA statement begins with the **XA** keyword, and most of them require an *xid* value. An *xid* is an XA transaction identifier. It indicates which transaction the statement applies to. *xid* values are supplied by the client, or generated by the MySQL server. An *xid* value has from one to three parts:

```
xid: gtrid [, bqual [, formatID ]]
```

*gtrid* is a global transaction identifier, *bqual* is a branch qualifier, and *formatID* is a number that identifies the format used by the *gtrid* and *bqual* values. As indicated by the syntax, *bqual* and *formatID* are optional. The default *bqual* value is '' if not given. The default *formatID* value is 1 if not given.

*gtrid* and *bqual* must be string literals, each up to 64 bytes (not characters) long. *gtrid* and *bqual* can be specified in several ways. You can use a quoted string ('ab'), hex string (0x6162, X'ab'), or bit value (b'nnnn').

*formatID* is an unsigned integer.

The *gtrid* and *bqual* values are interpreted in bytes by the MySQL server's underlying XA support routines. However, while an SQL statement containing an XA statement is being parsed, the server works with some specific character set. To be safe, write *gtrid* and *bqual* as hex strings.

*xid* values typically are generated by the Transaction Manager. Values generated by one TM must be different from values generated by other TMs. A given TM must be able to recognize its own *xid* values in a list of values returned by the **XA RECOVER** statement.

#### MySQL Enterprise

For expert advice on XA Distributed Transaction Support subscribe to the MySQL Enterprise Monitor. For more information, see <http://www.mysql.com/products/enterprise/advisors.html>.

**XA START** *xid* starts an XA transaction with the given *xid* value. Each XA transaction must have a unique *xid* value, so the value must not currently be used by another XA transaction. Uniqueness is assessed using the *gtrid* and *bqual* values. All following XA statements for the XA transaction must be specified using the same *xid* value as that given in the **XA START** statement. If you use any of those statements but specify an *xid* value that does not correspond to some existing XA transaction, an error occurs.

One or more XA transactions can be part of the same global transaction. All XA transactions within a given global transaction must use the same *gtrid* value in the *xid* value. For this reason, *gtrid* values must be globally unique so that there is no ambiguity about which global transaction a given XA transaction is part of. The *bqual* part of the *xid* value must be different for each XA transaction within a global transaction. (The requirement that *bqual* values be different is a limitation of the current MySQL XA implementation. It is not part of the XA specification.)

The **XA RECOVER** statement returns information for those XA transactions on the MySQL server that are in the **PREPARED** state. (See [Section 12.4.7.2, “XA Transaction States”](#).) The output includes a row for each such XA transaction on the server, regardless of which client started it.

**XA RECOVER** output rows look like this (for an example *xid* value consisting of the parts 'abc', 'def', and 7):

```
mysql> XA RECOVER;
+-----+-----+-----+-----+
| formatID | gtrid_length | bqual_length | data |
+-----+-----+-----+-----+
|          7 |              3 |              3 | abcdef |
+-----+-----+-----+-----+
```

The output columns have the following meanings:

- *formatID* is the *formatID* part of the transaction *xid*
- *gtrid\_length* is the length in bytes of the *gtrid* part of the *xid*
- *bqual\_length* is the length in bytes of the *bqual* part of the *xid*
- *data* is the concatenation of the *gtrid* and *bqual* parts of the *xid*



## 12.4.7.2. XA Transaction States

An XA transaction progresses through the following states:

1. Use `XA START` to start an XA transaction and put it in the `ACTIVE` state.
2. For an `ACTIVE` XA transaction, issue the SQL statements that make up the transaction, and then issue an `XA END` statement. `XA END` puts the transaction in the `IDLE` state.
3. For an `IDLE` XA transaction, you can issue either an `XA PREPARE` statement or an `XA COMMIT ... ONE PHASE` statement:
  - `XA PREPARE` puts the transaction in the `PREPARED` state. An `XA RECOVER` statement at this point will include the transaction's `xid` value in its output, because `XA RECOVER` lists all XA transactions that are in the `PREPARED` state.
  - `XA COMMIT ... ONE PHASE` prepares and commits the transaction. The `xid` value will not be listed by `XA RECOVER` because the transaction terminates.
4. For a `PREPARED` XA transaction, you can issue an `XA COMMIT` statement to commit and terminate the transaction, or `XA ROLLBACK` to roll back and terminate the transaction.

Here is a simple XA transaction that inserts a row into a table as part of a global transaction:

```
mysql> XA START 'xatest';
Query OK, 0 rows affected (0.00 sec)

mysql> INSERT INTO mytable (i) VALUES(10);
Query OK, 1 row affected (0.04 sec)

mysql> XA END 'xatest';
Query OK, 0 rows affected (0.00 sec)

mysql> XA PREPARE 'xatest';
Query OK, 0 rows affected (0.00 sec)

mysql> XA COMMIT 'xatest';
Query OK, 0 rows affected (0.00 sec)
```

Within the context of a given client connection, XA transactions and local (non-XA) transactions are mutually exclusive. For example, if `XA START` has been issued to begin an XA transaction, a local transaction cannot be started until the XA transaction has been committed or rolled back. Conversely, if a local transaction has been started with `START TRANSACTION`, no XA statements can be used until the transaction has been committed or rolled back.

Note that if an XA transaction is in the `ACTIVE` state, you cannot issue any statements that cause an implicit commit. That would violate the XA contract because you could not roll back the XA transaction. You will receive the following error if you try to execute such a statement:

```
ERROR 1399 (XAE07): XAER_RMFAIL: The command cannot be executed
when global transaction is in the ACTIVE state
```

Statements to which the preceding remark applies are listed at [Section 12.4.3, “Statements That Cause an Implicit Commit”](#).

## 12.5. Database Administration Statements

### 12.5.1. Account Management Statements

MySQL account information is stored in the tables of the `mysql` database. This database and the access control system are discussed extensively in [Chapter 5, \*MySQL Server Administration\*](#), which you should consult for additional details.

#### Important

Some releases of MySQL introduce changes to the structure of the grant tables to add new privileges or features. Whenever you update to a new version of MySQL, you should update your grant tables to make sure that they have the current structure so that you can take advantage of any new capabilities. See [Section 4.4.8, “mysql\\_upgrade — Check Tables for MySQL Upgrade”](#).

#### MySQL Enterprise

In a production environment it is always prudent to examine any changes to users' accounts. The MySQL Enterprise Monitor provides notification whenever users' privileges are altered. For more information, see <http://www.mysql.com/products/enterprise/advisors.html>.

### 12.5.1.1. CREATE USER Syntax

```
CREATE USER user [IDENTIFIED BY [PASSWORD] 'password']
[, user [IDENTIFIED BY [PASSWORD] 'password']] ...
```

The `CREATE USER` statement creates new MySQL accounts. To use it, you must have the global `CREATE USER` privilege or the `INSERT` privilege for the `mysql` database. For each account, `CREATE USER` creates a new row in the `mysql.user` table that has no privileges. An error occurs if the account already exists. Each account is named using the same format as for the `GRANT` statement; for example, `'jeffrey'@'localhost'`. If you specify only the user name part of the account name, a host name part of `'%'` is used. For additional information about specifying account names, see [Section 12.5.1.3, “GRANT Syntax”](#).

The account can be given a password with the optional `IDENTIFIED BY` clause. The `user` value and the password are given the same way as for the `GRANT` statement. In particular, to specify the password in plain text, omit the `PASSWORD` keyword. To specify the password as the hashed value as returned by the `PASSWORD()` function, include the `PASSWORD` keyword. See [Section 12.5.1.3, “GRANT Syntax”](#).

#### Important

This statement may be recorded in a history file such as `~/.mysql_history`, which means that plaintext passwords may be read by anyone having read access to such files.

### 12.5.1.2. DROP USER Syntax

```
DROP USER user [, user] ...
```

The `DROP USER` statement removes one or more MySQL accounts. It removes privilege rows for the account from all grant tables. To use this statement, you must have the global `CREATE USER` privilege or the `DELETE` privilege for the `mysql` database. Each account is named using the same format as for the `GRANT` statement; for example, `'jeffrey'@'localhost'`. If you specify only the user name part of the account name, a host name part of `'%'` is used. For additional information about specifying account names, see [Section 12.5.1.3, “GRANT Syntax”](#).

With `DROP USER`, you can remove an account and its privileges as follows:

```
DROP USER user;
```

#### Important

`DROP USER` does not automatically close any open user sessions. Rather, in the event that a user with an open session is dropped, the statement does not take effect until that user's session is closed. Once the session is closed, the user is dropped, and that user's next attempt to log in will fail. *This is by design.*

`DROP USER` does not automatically delete or invalidate any database objects that the user created. This applies to tables, views, stored routines, triggers, and events.

### 12.5.1.3. GRANT Syntax

```
GRANT
  priv_type [(column_list)]
  [, priv_type [(column_list)] ...]
ON [object_type] priv_level
TO user [IDENTIFIED BY [PASSWORD] 'password']
  [, user [IDENTIFIED BY [PASSWORD] 'password']] ...
[REQUIRE {NONE | ssl_option [[AND] ssl_option] ...}]
[WITH with_option [with_option] ...]
```

*object\_type*:

```
TABLE
|
FUNCTION
|
PROCEDURE
```

*priv\_level*:

```
*
|
* *
|
db_name.*
|
db_name.tbl_name
|
tbl_name
|
db_name.routine_name
```

*with\_option*:

```
GRANT OPTION
|
MAX_QUERIES_PER_HOUR count
|
MAX_UPDATES_PER_HOUR count
|
MAX_CONNECTIONS_PER_HOUR count
|
MAX_USER_CONNECTIONS count
```

*ssl\_option*:

```
SSL
```



```
X509
CIPHER 'cipher'
ISSUER 'issuer'
SUBJECT 'subject'
```

The `GRANT` statement enables system administrators to create MySQL user accounts and to grant rights to accounts. To use `GRANT`, you must have the `GRANT OPTION` privilege, and you must have the privileges that you are granting. The `REVOKE` statement is related and enables administrators to remove account privileges. To determine what privileges an account has, use `SHOW GRANTS`. See [Section 12.5.1.5, “REVOKE Syntax”](#), and [Section 12.5.5.22, “SHOW GRANTS Syntax”](#).

### MySQL Enterprise

For automated notification of users with inappropriate privileges, subscribe to the MySQL Enterprise Monitor. For more information, see <http://www.mysql.com/products/enterprise/advisors.html>.

The following table summarizes the allowable `priv_type` privilege types that can be specified for the `GRANT` and `REVOKE` statements. For additional information about these privileges, see [Section 5.4.1, “Privileges Provided by MySQL”](#).

Privilege	Meaning
<code>ALL [PRIVILEGES]</code>	Grant all privileges at specified access level except <code>GRANT OPTION</code>
<code>ALTER</code>	Enable use of <code>ALTER TABLE</code>
<code>ALTER ROUTINE</code>	Enable stored routines to be altered or dropped
<code>CREATE</code>	Enable database and table creation
<code>CREATE ROUTINE</code>	Enable stored routine creation
<code>CREATE TEMPORARY TABLES</code>	Enable use of <code>CREATE TEMPORARY TABLE</code>
<code>CREATE USER</code>	Enable use of <code>CREATE USER</code> , <code>DROP USER</code> , <code>RENAME USER</code> , and <code>REVOKE ALL PRIVILEGES</code>
<code>CREATE VIEW</code>	Enable views to be created or altered
<code>DELETE</code>	Enable use of <code>DELETE</code>
<code>DROP</code>	Enable databases, tables, and views to be dropped
<code>EVENT</code>	Enable use of events for the Event Scheduler
<code>EXECUTE</code>	Enable the user to execute stored routines
<code>FILE</code>	Enable the user to cause the server to read or write files
<code>GRANT OPTION</code>	Enable privileges to be granted to or removed from other accounts
<code>INDEX</code>	Enable indexes to be created or dropped
<code>INSERT</code>	Enable use of <code>INSERT</code>
<code>LOCK TABLES</code>	Enable use of <code>LOCK TABLES</code> on tables for which you have the <code>SELECT</code> privilege
<code>PROCESS</code>	Enable the user to see all processes with <code>SHOW PROCESSLIST</code>
<code>REFERENCES</code>	Not implemented
<code>RELOAD</code>	Enable use of <code>FLUSH</code> operations
<code>REPLICATION CLIENT</code>	Enable the user to ask where master or slave servers are
<code>REPLICATION SLAVE</code>	Enable replication slaves to read binary log events from the master
<code>SELECT</code>	Enable use of <code>SELECT</code>
<code>SHOW DATABASES</code>	Enable <code>SHOW DATABASES</code> to show all databases
<code>SHOW VIEW</code>	Enable use of <code>SHOW CREATE VIEW</code>
<code>SHUTDOWN</code>	Enable use of <code>mysqladmin shutdown</code>
<code>SUPER</code>	Enable use of <code>CHANGE MASTER TO</code> , <code>KILL</code> , <code>PURGE BINARY LOGS</code> , and <code>SET GLOBAL</code> statements, the <code>mysqladmin debug</code> command; allows you to connect (once) even if <code>max_connections</code> is reached
<code>TRIGGER</code>	Enable triggers to be created or dropped
<code>UPDATE</code>	Enable use of <code>UPDATE</code>
<code>USAGE</code>	Synonym for “no privileges”

The `EVENT` and `TRIGGER` privileges were added in MySQL 5.1.6. A trigger is associated with a table, so to create or drop a trigger, you must have the `TRIGGER` privilege for the table, not the trigger. (Before MySQL 5.1.6, the `SUPER` privilege was required to create or drop triggers.)

**USAGE** can be specified when you want to create a user that has no privileges, or to modify the **REQUIRE** or **WITH** clauses for an account without changing its existing privileges.

MySQL account information is stored in the tables of the `mysql` database. This database and the access control system are discussed extensively in [Chapter 5, MySQL Server Administration](#), which you should consult for additional details.

### Important

Some releases of MySQL introduce changes to the structure of the grant tables to add new privileges or features. Whenever you update to a new version of MySQL, you should update your grant tables to make sure that they have the current structure so that you can take advantage of any new capabilities. See [Section 4.4.8, “mysql\\_upgrade — Check Tables for MySQL Upgrade”](#).

If the grant tables hold privilege rows that contain mixed-case database or table names and the `lower_case_table_names` system variable is set to a nonzero value, **REVOKE** cannot be used to revoke these privileges. It will be necessary to manipulate the grant tables directly. (**GRANT** will not create such rows when `lower_case_table_names` is set, but such rows might have been created prior to setting the variable.)

Privileges can be granted at several levels, depending on the syntax used for the **ON** clause. For **REVOKE**, the same **ON** syntax specifies which privileges to take away. The examples shown here include no **IDENTIFIED BY 'password'** clause for brevity, but you should include one if the account does not already exist to avoid creating an account with no password.

### Global privileges

Global privileges are administrative or apply to all databases on a given server. To assign global privileges, use **ON \*.\*** syntax:

```
GRANT ALL ON *.* TO 'someuser'@'somehost';
GRANT SELECT, INSERT ON *.* TO 'someuser'@'somehost';
```

Privileges also are assigned at the global level if you use **ON \*** syntax and you have *not* selected a default database.

The **CREATE USER**, **FILE**, **PROCESS**, **RELOAD**, **REPLICATION CLIENT**, **REPLICATION SLAVE**, **SHOW DATABASES**, **SHUTDOWN**, and **SUPER** privileges are administrative and can only be granted globally.

Other privileges can be granted globally or at more specific levels.

Global privileges are stored in the `mysql.user` table.

### Database privileges

Database privileges apply to all objects in a given database. To assign database-level privileges, use **ON db\_name.\*** syntax:

```
GRANT ALL ON mydb.* TO 'someuser'@'somehost';
GRANT SELECT, INSERT ON mydb.* TO 'someuser'@'somehost';
```

Privileges also are assigned at the database level if you use **ON \*** syntax and you have selected a default database.

The **CREATE**, **DROP**, **EVENT**, and **GRANT OPTION** privileges can be specified at the database level. Table or routine privileges also can be specified at the database level, in which case they apply to all tables or routines in the database.

Database privileges are stored in the `mysql.db` and `mysql.host` tables. **GRANT** and **REVOKE** affect the `db` table, but not the `host` table, which is rarely used.

### Table privileges

Table privileges apply to all columns in a given table. To assign table-level privileges, use **ON db\_name.tbl\_name** syntax:

```
GRANT ALL ON mydb.mytbl TO 'someuser'@'somehost';
GRANT SELECT, INSERT ON mydb.mytbl TO 'someuser'@'somehost';
```

If you specify `tbl_name` rather than `db_name.tbl_name`, the statement applies to `tbl_name` in the default database. An error occurs if there is no default database.

The allowable *priv\_type* values for a table are **ALTER**, **CREATE VIEW**, **CREATE**, **DELETE**, **DROP**, **GRANT OPTION**, **INDEX**, **INSERT**, **SELECT**, **SHOW VIEW**, **TRIGGER**, and **UPDATE**.

Table privileges are stored in the `mysql.tables_priv` table.

### Column privileges

Column privileges apply to single columns in a given table. Each privilege to be granted at the column level must be followed by

the column or columns, enclosed within parentheses.

```
GRANT SELECT (col1), INSERT (col1,col2) ON mydb.mytbl TO 'someuser'@'somehost';
```

The allowable *priv\_type* values for a column (that is, when you use a *column\_list* clause) are `INSERT`, `SELECT`, and `UPDATE`.

Column privileges are stored in the `mysql.columns_priv` table.

### Routine privileges

The `ALTER ROUTINE`, `CREATE ROUTINE`, `EXECUTE`, and `GRANT OPTION` privileges apply to stored routines (procedures and functions). They can be granted at the global and database levels. Except for `CREATE ROUTINE`, these privileges can be granted at the routine level for individual routines.

```
GRANT CREATE ROUTINE ON mydb.* TO 'someuser'@'somehost';
GRANT EXECUTE ON PROCEDURE mydb.myproc TO 'someuser'@'somehost';
```

The allowable *priv\_type* values at the routine level are `ALTER ROUTINE`, `EXECUTE`, and `GRANT OPTION`. `CREATE ROUTINE` is not a routine-level privilege because you must have this privilege to create a routine in the first place.

Routine-level privileges are stored in the `mysql.procs_priv` table.

For the global, database, table, and routine levels, `GRANT ALL` assigns only the privileges that exist at the level you are granting. For example, `GRANT ALL ON db_name.*` is a database-level statement, so it does not grant any global-only privileges such as `FILE`.

The *object\_type* clause, if present, should be specified as `TABLE`, `FUNCTION`, or `PROCEDURE` when the following object is a table, a stored function, or a stored procedure.

The privileges for a database, table, column, or routine are formed additively as the logical `OR` of the privileges at each of the privilege levels. For example, if a user has a global `SELECT` privilege, the privilege cannot be denied by an absence of the privilege at the database, table, or column level. Details of the privilege-checking procedure are presented in [Section 5.4.5, “Access Control, Stage 2: Request Verification”](#).

MySQL enables you to grant privileges even on database objects that do not exist. In such cases, the privileges to be granted must include the `CREATE` privilege. *This behavior is by design*, and is intended to enable the database administrator to prepare user accounts and privileges for database objects that are to be created at a later time.

### Important

*MySQL does not automatically revoke any privileges when you drop a database or table.* However, if you drop a routine, any routine-level privileges granted for that routine are revoked.

The *user* value indicates which MySQL account to grant the privileges to. To accommodate granting rights to users from arbitrary hosts, MySQL supports specifying the *user* value in the form `user_name@host_name`. If a *user\_name* or *host\_name* value is legal as an unquoted identifier, you need not quote it. However, quotes are necessary to specify a *user\_name* string containing special characters (such as “-”), or a *host\_name* string containing special characters or wildcard characters (such as “%”); for example, `'test-user'@'%.com'`. Quote the user name and host name separately.

You can specify wildcards in the host name. For example, `user_name@'%.example.com'` applies to *user\_name* for any host in the `example.com` domain, and `user_name@'192.168.1.%'` applies to *user\_name* for any host in the `192.168.1` class C subnet.

The simple form *user\_name* is a synonym for `user_name@' % '`.

*MySQL does not support wildcards in user names.* To refer to an anonymous user, specify an account with an empty user name with the `GRANT` statement:

```
GRANT ALL ON test.* TO ''@'localhost' ...
```

In this case, any user who connects from the local host with the correct password for the anonymous user will be allowed access, with the privileges associated with the anonymous-user account.

For additional information about user and host values in account names, see [Section 5.4.3, “Specifying Account Names”](#).

To specify quoted values, quote database, table, column, and routine names as identifiers, using backticks (“`”). Quote user names and host names as identifiers or as strings, using either backticks (“`”), single quotes (“'”), or double quotes (“”). Quote passwords as strings, using single quotes.

The “\_” and “%” wildcards are allowed when specifying database names in `GRANT` statements that grant privileges at the global or database levels. This means, for example, that if you want to use a “\_” character as part of a database name, you should specify it as “\\_” in the `GRANT` statement, to prevent the user from being able to access additional databases matching the wildcard pattern; for example, `GRANT ... ON `foo\_bar`.* TO ...`

### Warning

If you allow anonymous users to connect to the MySQL server, you should also grant privileges to all local users as `user_name@localhost`. Otherwise, the anonymous user account for `localhost` in the `mysql.user` table (created during MySQL installation) is used when named users try to log in to the MySQL server from the local machine. For details, see [Section 5.4.4, “Access Control, Stage 1: Connection Verification”](#).

You can determine whether the preceding warning applies to you by executing the following query, which lists any anonymous users:

```
SELECT Host, User FROM mysql.user WHERE User='';
```

To avoid the problem just described, delete the local anonymous user account using this statement:

```
DROP USER ''@'localhost';
```

`GRANT` supports host names up to 60 characters long. Database, table, column, and routine names can be up to 64 characters. User names can be up to 16 characters.

### Warning

*The allowable length for user names cannot be changed by altering the `mysql.user` table. Attempting to do so results in unpredictable behavior which may even make it impossible for users to log in to the MySQL server. You should never alter any of the tables in the `mysql` database in any manner whatsoever except by means of the procedure prescribed by MySQL AB that is described in [Section 4.4.8, “mysql\\_upgrade — Check Tables for MySQL Upgrade”](#).*

If the `NO_AUTO_CREATE_USER` SQL mode is not enabled and the account named in a `GRANT` statement does not exist in the `mysql.user` table, `GRANT` creates it. If you specify no `IDENTIFIED BY` clause or provide an empty password, the user has no password. *This is very insecure.*

If `NO_AUTO_CREATE_USER` is enabled and the account does not exist, `GRANT` fails and does not create the account unless the `IDENTIFIED BY` clause is given to provide a non-empty password.

When the `IDENTIFIED BY` clause is present and you have global grant privileges, the password becomes the new password for the account, even if the account exists and already has a password.

### MySQL Enterprise

The MySQL Enterprise Monitor specifically guards against user accounts with no passwords. To find out more, see <http://www.mysql.com/products/enterprise/advisors.html>.

`REVOKE` does not remove `mysql.user` table entries; you must do that using `DROP USER` or `DELETE`.

Passwords can also be set with the `SET PASSWORD` statement. See [Section 12.5.1.6, “SET PASSWORD Syntax”](#).

In the `IDENTIFIED BY` clause, the password should be given as the literal password value. It is unnecessary to use the `PASSWORD()` function as it is for the `SET PASSWORD` statement. For example:

```
GRANT ... IDENTIFIED BY 'mypass';
```

If you do not want to send the password in clear text and you know the hashed value that `PASSWORD()` would return for the password, you can specify the hashed value preceded by the keyword `PASSWORD`:

```
GRANT ...
IDENTIFIED BY PASSWORD '*6C8989366EAF75BB670AD8EA7A7FC1176A95CEF4';
```

The `WITH` clause is used for several purposes:

- To enable a user to grant privileges to other users
- To specify resource-use limitations on a user
- To specify whether and how a user must use secure connections to the server

The `WITH GRANT OPTION` clause gives the user the ability to give to other users any privileges the user has at the specified privilege level. You should be careful to whom you give the `GRANT OPTION` privilege, because two users with different privileges may be able to combine privileges!

You cannot grant another user a privilege which you yourself do not have; the `GRANT OPTION` privilege enables you to assign only those privileges which you yourself possess.

Be aware that when you grant a user the `GRANT OPTION` privilege at a particular privilege level, any privileges the user possesses (or may be given in the future) at that level can also be granted by that user to other users. Suppose that you grant a user the `INSERT` privilege on a database. If you then grant the `SELECT` privilege on the database and specify `WITH GRANT OPTION`, that user can give to other users not only the `SELECT` privilege, but also `INSERT`. If you then grant the `UPDATE` privilege to the user on the database, the user can grant `INSERT`, `SELECT`, and `UPDATE`.

For a non-administrative user, you should not grant the `ALTER` privilege globally or for the `mysql` database. If you do that, the user can try to subvert the privilege system by renaming tables!

For additional information about security risks associated with particular privileges, see [Section 5.4.1, “Privileges Provided by MySQL”](#).

The `MAX_QUERIES_PER_HOUR count`, `MAX_UPDATES_PER_HOUR count`, and `MAX_CONNECTIONS_PER_HOUR count` options limit the number of queries, updates, and logins a user can perform during any given one-hour period. (Queries for which results are served from the query cache do not count against the `MAX_QUERIES_PER_HOUR` limit.) If `count` is 0 (the default), this means that there is no limitation for that user.

The `MAX_USER_CONNECTIONS count` option limits the maximum number of simultaneous connections that the account can make. If `count` is 0 (the default), the `max_user_connections` system variable determines the number of simultaneous connections for the account.

To specify any of these resource-limit options for an existing user without affecting existing privileges, use `GRANT USAGE ON *.* ... WITH MAX_...`

For more information on restricting resources, see [Section 5.5.4, “Limiting Account Resources”](#).

MySQL can check X509 certificate attributes in addition to the usual authentication that is based on the user name and password. To specify SSL-related options for a MySQL account, use the `REQUIRE` clause of the `GRANT` statement. (For background information on the use of SSL with MySQL, see [Section 5.5.7, “Using SSL for Secure Connections”](#).)

There are a number of different possibilities for limiting connection types for a given account:

- `REQUIRE NONE` indicates that the account has no SSL or X509 requirements. This is the default if no SSL-related `REQUIRE` options are specified. Unencrypted connections are allowed if the user name and password are valid. However, encrypted connections can also be used, at the client's option, if the client has the proper certificate and key files. That is, the client need not specify any SSL command options, in which case the connection will be unencrypted. To use an encrypted connection, the client must specify either the `--ssl-ca` option, or all three of the `--ssl-ca`, `--ssl-key`, and `--ssl-cert` options.
- The `REQUIRE SSL` option tells the server to allow only SSL-encrypted connections for the account.

```
GRANT ALL PRIVILEGES ON test.* TO 'root'@'localhost'
  IDENTIFIED BY 'goodsecret' REQUIRE SSL;
```

To connect, the client must specify the `--ssl-ca` option, and may additionally specify the `--ssl-key` and `--ssl-cert` options.

- `REQUIRE X509` means that the client must have a valid certificate but that the exact certificate, issuer, and subject do not matter. The only requirement is that it should be possible to verify its signature with one of the CA certificates.

```
GRANT ALL PRIVILEGES ON test.* TO 'root'@'localhost'
  IDENTIFIED BY 'goodsecret' REQUIRE X509;
```

To connect, the client must specify the `--ssl-ca`, `--ssl-key`, and `--ssl-cert` options. This is also true for `ISSUER` and `SUBJECT` because those `REQUIRE` options imply `X509`.

- `REQUIRE ISSUER 'issuer'` places the restriction on connection attempts that the client must present a valid X509 certificate issued by CA `'issuer'`. If the client presents a certificate that is valid but has a different issuer, the server rejects the connection. Use of X509 certificates always implies encryption, so the `SSL` option is unnecessary in this case.

```
GRANT ALL PRIVILEGES ON test.* TO 'root'@'localhost'
  IDENTIFIED BY 'goodsecret'
  REQUIRE ISSUER '/C=FI/ST=Some-State/L=Helsinki/
  O=MySQL Finland AB/CN=Tonu Samuel/Email=tonu@example.com';
```

Note that the `'issuer'` value should be entered as a single string.

- `REQUIRE SUBJECT 'subject'` places the restriction on connection attempts that the client must present a valid X509 certificate containing the subject `subject`. If the client presents a certificate that is valid but has a different subject, the server rejects the connection.

```
GRANT ALL PRIVILEGES ON test.* TO 'root'@'localhost'
  IDENTIFIED BY 'goodsecret'
  REQUIRE SUBJECT '/C=EE/ST=Some-State/L=Tallinn/
    O=MySQL demo client certificate/
    CN=Tonu Samuel/Email=tonu@example.com';
```

Note that the `'subject'` value should be entered as a single string.

- `REQUIRE CIPHER 'cipher'` is needed to ensure that ciphers and key lengths of sufficient strength are used. SSL itself can be weak if old algorithms using short encryption keys are used. Using this option, you can ask that a specific cipher method is used to allow a connection.

```
GRANT ALL PRIVILEGES ON test.* TO 'root'@'localhost'
  IDENTIFIED BY 'goodsecret'
  REQUIRE CIPHER 'EDH-RSA-DES-CBC3-SHA';
```

The `SUBJECT`, `ISSUER`, and `CIPHER` options can be combined in the `REQUIRE` clause like this:

```
GRANT ALL PRIVILEGES ON test.* TO 'root'@'localhost'
  IDENTIFIED BY 'goodsecret'
  REQUIRE SUBJECT '/C=EE/ST=Some-State/L=Tallinn/
    O=MySQL demo client certificate/
    CN=Tonu Samuel/Email=tonu@example.com'
  AND ISSUER '/C=FI/ST=Some-State/L=Helsinki/
    O=MySQL Finland AB/CN=Tonu Samuel/Email=tonu@example.com'
  AND CIPHER 'EDH-RSA-DES-CBC3-SHA';
```

The order of the options does not matter, but no option can be specified twice. The `AND` keyword is optional between `REQUIRE` options.

If you are using table, column, or routine privileges for even one user, the server examines table, column, and routine privileges for all users and this slows down MySQL a bit. Similarly, if you limit the number of queries, updates, or connections for any users, the server must monitor these values.

The biggest differences between the standard SQL and MySQL versions of `GRANT` are:

- In MySQL, privileges are associated with the combination of a host name and user name and not with only a user name.
- Standard SQL does not have global or database-level privileges, nor does it support all the privilege types that MySQL supports.
- MySQL does not support the standard SQL `UNDER` privilege.
- Standard SQL privileges are structured in a hierarchical manner. If you remove a user, all privileges the user has been granted are revoked. This is also true in MySQL if you use `DROP USER`. See [Section 12.5.1.2, “DROP USER Syntax”](#).
- In standard SQL, when you drop a table, all privileges for the table are revoked. In standard SQL, when you revoke a privilege, all privileges that were granted based on that privilege are also revoked. In MySQL, privileges can be dropped only with explicit `REVOKE` statements or by manipulating values stored in the MySQL grant tables.
- In MySQL, it is possible to have the `INSERT` privilege for only some of the columns in a table. In this case, you can still execute `INSERT` statements on the table, provided that you omit those columns for which you do not have the `INSERT` privilege. The omitted columns are set to their implicit default values if strict SQL mode is not enabled. In strict mode, the statement is rejected if any of the omitted columns have no default value. (Standard SQL requires you to have the `INSERT` privilege on all columns.) [Section 5.1.7, “Server SQL Modes”](#), discusses strict mode. [Section 10.1.4, “Data Type Default Values”](#), discusses implicit default values.

#### 12.5.1.4. RENAME USER Syntax

```
RENAME USER old_user TO new_user
  [, old_user TO new_user] ...
```

The `RENAME USER` statement renames existing MySQL accounts. To use it, you must have the global `CREATE USER` privilege



or the `UPDATE` privilege for the `mysql` database. An error occurs if any old account does not exist or any new account exists. Each account is named using the same format as for the `GRANT` statement; for example, `'jeffrey'@'localhost'`. If you specify only the user name part of the account name, a host name part of `'%'` is used. For additional information about specifying account names, see [Section 12.5.1.3, “GRANT Syntax”](#).

`RENAME USER` does not automatically migrate any database objects that the user created, nor does it migrate any privileges that the user had prior to the renaming. This applies to tables, views, stored routines, triggers, and events.

### 12.5.1.5. REVOKE Syntax

```
REVOKE
  priv_type [(column_list)]
  [, priv_type [(column_list)]] ...
ON [object_type] priv_level
FROM user [, user] ...

REVOKE ALL PRIVILEGES, GRANT OPTION
FROM user [, user] ...
```

The `REVOKE` statement enables system administrators to revoke privileges from MySQL accounts. Each account is named using the same format as for the `GRANT` statement; for example, `'jeffrey'@'localhost'`. If you specify only the user name part of the account name, a host name part of `'%'` is used. For details on the levels at which privileges exist, the allowable `priv_type` and `priv_level` values, and the syntax for specifying users and passwords, see [Section 12.5.1.3, “GRANT Syntax”](#)

To use the first `REVOKE` syntax, you must have the `GRANT OPTION` privilege, and you must have the privileges that you are revoking.

To revoke all privileges, use the second syntax, which drops all global, database, table, column, and routine privileges for the named user or users:

```
REVOKE ALL PRIVILEGES, GRANT OPTION FROM user [, user] ...
```

To use this `REVOKE` syntax, you must have the global `CREATE USER` privilege or the `UPDATE` privilege for the `mysql` database.

`REVOKE` removes privileges, but does not drop `mysql.user` table entries. To remove a user account entirely, use `DROP USER` (see [Section 12.5.1.2, “DROP USER Syntax”](#)) or `DELETE`.

If the grant tables hold privilege rows that contain mixed-case database or table names and the `lower_case_table_names` system variable is set to a nonzero value, `REVOKE` cannot be used to revoke these privileges. It will be necessary to manipulate the grant tables directly. (`GRANT` will not create such rows when `lower_case_table_names` is set, but such rows might have been created prior to setting the variable.)

To verify an account's privileges after a `REVOKE` operation, use `SHOW GRANTS`. See [Section 12.5.5.22, “SHOW GRANTS Syntax”](#).

### 12.5.1.6. SET PASSWORD Syntax

```
SET PASSWORD [FOR user] =
{
  PASSWORD('some password')
  | OLD_PASSWORD('some password')
  | 'encrypted password'
}
```

The `SET PASSWORD` statement assigns a password to an existing MySQL user account.

If the password is specified using the `PASSWORD()` or `OLD_PASSWORD()` function, the literal text of the password should be given. If the password is specified without using either function, the password should be the already-encrypted password value as returned by `PASSWORD()`.

With no `FOR` clause, this statement sets the password for the current user. Any client that has connected to the server using a non-anonymous account can change the password for that account.

With a `FOR` clause, this statement sets the password for a specific account on the current server host. Only clients that have the `UPDATE` privilege for the `mysql` database can do this. The `user` value should be given in `user_name@host_name` format, where `user_name` and `host_name` are exactly as they are listed in the `User` and `Host` columns of the `mysql.user` table entry. For example, if you had an entry with `User` and `Host` column values of `'bob'` and `'%.loc.gov'`, you would write the statement like this:

```
SET PASSWORD FOR 'bob'@'%.loc.gov' = PASSWORD('newpass');
```

That is equivalent to the following statements:

```
UPDATE mysql.user SET Password=PASSWORD('newpass')
  WHERE User='bob' AND Host='% .loc.gov';
FLUSH PRIVILEGES;
```

### Note

If you are connecting to a MySQL 4.1 or later server using a pre-4.1 client program, do not use the preceding `SET PASSWORD` or `UPDATE` statement without reading [Section 5.5.6.3, “Password Hashing in MySQL”](#), first. The password format changed in MySQL 4.1, and under certain circumstances it is possible that if you change your password, you might not be able to connect to the server afterward.

You can see which account the server authenticated you as by executing `SELECT CURRENT_USER()`.

### MySQL Enterprise

For automated notification of users without passwords, subscribe to the MySQL Enterprise Monitor. For more information, see <http://www.mysql.com/products/enterprise/advisors.html>.

## 12.5.2. Table Maintenance Statements

### 12.5.2.1. ANALYZE TABLE Syntax

```
ANALYZE [NO_WRITE_TO_BINLOG | LOCAL] TABLE
  tbl_name [, tbl_name] ...
```

`ANALYZE TABLE` analyzes and stores the key distribution for a table. During the analysis, the table is locked with a read lock for `MyISAM`. For `InnoDB` the table is locked with a write lock. This statement works with `MyISAM`, and `InnoDB` tables. For `MyISAM` tables, this statement is equivalent to using `myisamchk --analyze`.

For more information on how the analysis works within `InnoDB`, see [Section 13.6.14, “Restrictions on InnoDB Tables”](#).

### MySQL Enterprise

For expert advice on optimizing tables subscribe to the MySQL Enterprise Monitor. For more information, see <http://www.mysql.com/products/enterprise/advisors.html>.

MySQL uses the stored key distribution to decide the order in which tables should be joined when you perform a join on something other than a constant. In addition, key distributions can be used when deciding which indexes to use for a specific table within a query.

This statement requires `SELECT` and `INSERT` privileges for the table.

Beginning with MySQL 5.1.27, `ANALYZE TABLE` is also supported for partitioned tables. Also beginning with MySQL 5.1.27, you can use `ALTER TABLE ... ANALYZE PARTITION` to analyze one or more partitions; for more information, see [Section 12.1.7, “ALTER TABLE Syntax”](#), and [Section 17.3.3, “Maintenance of Partitions”](#).

`ANALYZE TABLE` returns a result set with the following columns.

Column	Value
Table	The table name
Op	Always <code>analyze</code>
Msg_type	<code>status</code> , <code>error</code> , <code>info</code> , or <code>warning</code>
Msg_text	An informational message

You can check the stored key distribution with the `SHOW INDEX` statement. See [Section 12.5.5.23, “SHOW INDEX Syntax”](#).

If the table has not changed since the last `ANALYZE TABLE` statement, the table is not analyzed again.

By default, `ANALYZE TABLE` statements are written to the binary log so that they will be replicated to replication slaves. Logging can be suppressed with the optional `NO_WRITE_TO_BINLOG` keyword or its alias `LOCAL`.

### 12.5.2.2. BACKUP TABLE Syntax

```
BACKUP TABLE tbl_name [, tbl_name] ... TO '/path/to/backup/directory'
```

### Note



This statement is deprecated. We are working on a better replacement for it that will provide online backup capabilities. In the meantime, the `mysqlhotcopy` script can be used instead.

`BACKUP TABLE` copies to the backup directory the minimum number of table files needed to restore the table, after flushing any buffered changes to disk. The statement works only for `MyISAM` tables. It copies the `.frm` definition and `.MYD` data files. The `.MYI` index file can be rebuilt from those two files. The directory should be specified as a full path name. To restore the table, use `RESTORE TABLE`.

During the backup, a read lock is held for each table, one at a time, as they are being backed up. If you want to back up several tables as a snapshot (preventing any of them from being changed during the backup operation), issue a `LOCK TABLES` statement first, to obtain a read lock for all tables in the group.

`BACKUP TABLE` returns a result set with the following columns.

Column	Value
Table	The table name
Op	Always <code>backup</code>
Msg_type	<code>status</code> , <code>error</code> , <code>info</code> , or <code>warning</code>
Msg_text	An informational message

### 12.5.2.3. CHECK TABLE Syntax

```
CHECK TABLE tbl_name [, tbl_name] ... [option] ...
option = {FOR UPGRADE | QUICK | FAST | MEDIUM | EXTENDED | CHANGED}
```

`CHECK TABLE` checks a table or tables for errors. `CHECK TABLE` works for `MyISAM`, `InnoDB`, and `ARCHIVE` tables. Starting with MySQL 5.1.9, `CHECK TABLE` is also valid for `CSV` tables, see [Section 13.12, “The CSV Storage Engine”](#). For `MyISAM` tables, the key statistics are updated as well.

`CHECK TABLE` can also check views for problems, such as tables that are referenced in the view definition that no longer exist.

Beginning with MySQL 5.1.27, `CHECK TABLE` is also supported for partitioned tables. Also beginning with MySQL 5.1.27, you can use `ALTER TABLE ... CHECK PARTITION` to check one or more partitions; for more information, see [Section 12.1.7, “ALTER TABLE Syntax”](#), and [Section 17.3.3, “Maintenance of Partitions”](#).

`CHECK TABLE` returns a result set with the following columns.

Column	Value
Table	The table name
Op	Always <code>check</code>
Msg_type	One of <code>status</code> , <code>error</code> , <code>info</code> , or <code>warning</code>
Msg_text	The message

Note that the statement might produce many rows of information for each checked table. The last row has a `Msg_type` value of `status` and the `Msg_text` normally should be `OK`. If you don't get `OK`, or `Table is already up to date` you should normally run a repair of the table. See [Section 6.4, “Table Maintenance and Crash Recovery”](#). `Table is already up to date` means that the storage engine for the table indicated that there was no need to check the table.

The `FOR UPGRADE` option checks whether the named tables are compatible with the current version of MySQL. This option was added in MySQL 5.1.7. With `FOR UPGRADE`, the server checks each table to determine whether there have been any incompatible changes in any of the table's data types or indexes since the table was created. If not, the check succeeds. Otherwise, if there is a possible incompatibility, the server runs a full check on the table (which might take some time). If the full check succeeds, the server marks the table's `.frm` file with the current MySQL version number. Marking the `.frm` file ensures that further checks for the table with the same version of the server will be fast.

Incompatibilities might occur because the storage format for a data type has changed or because its sort order has changed. Our aim is to avoid these changes, but occasionally they are necessary to correct problems that would be worse than an incompatibility between releases.

Currently, `FOR UPGRADE` discovers these incompatibilities:

- The indexing order for end-space in `TEXT` columns for `InnoDB` and `MyISAM` tables changed between MySQL 4.1 and 5.0.

- The storage method of the new `DECIMAL` data type changed between MySQL 5.0.3 and 5.0.5.
- As of MySQL 5.1.25, if your table was created by a different version of the MySQL server than the one you are currently running, `FOR UPGRADE` indicates that the table has an `.frm` file with an incompatible version. In this case, the result set returned by `CHECK TABLE` contains a line with a `Msg_type` value of `error` and a `Msg_text` value of `Table upgrade required. Please do "REPAIR TABLE `tbl_name`" to fix it!`
- Changes are sometimes made to character sets or collations that require table indexes to be rebuilt. For details about these changes and when `FOR UPGRADE` detects them, see [Section 2.12.3, “Checking Whether Table Indexes Must Be Rebuilt”](#).

The other check options that can be given are shown in the following table. These options are passed to the storage engine, which may use them or not. `MyISAM` uses them; they are ignored for `InnoDB` tables and views.

Type	Meaning
<code>QUICK</code>	Do not scan the rows to check for incorrect links.
<code>FAST</code>	Check only tables that have not been closed properly.
<code>CHANGED</code>	Check only tables that have been changed since the last check or that have not been closed properly.
<code>MEDIUM</code>	Scan rows to verify that deleted links are valid. This also calculates a key checksum for the rows and verifies this with a calculated checksum for the keys.
<code>EXTENDED</code>	Do a full key lookup for all keys for each row. This ensures that the table is 100% consistent, but takes a long time.

If none of the options `QUICK`, `MEDIUM`, or `EXTENDED` are specified, the default check type for dynamic-format `MyISAM` tables is `MEDIUM`. This has the same result as running `myisamchk --medium-check tbl_name` on the table. The default check type also is `MEDIUM` for static-format `MyISAM` tables, unless `CHANGED` or `FAST` is specified. In that case, the default is `QUICK`. The row scan is skipped for `CHANGED` and `FAST` because the rows are very seldom corrupted.

You can combine check options, as in the following example that does a quick check on the table to determine whether it was closed properly:

```
CHECK TABLE test_table FAST QUICK;
```

### Note

In some cases, `CHECK TABLE` changes the table. This happens if the table is marked as “corrupted” or “not closed properly” but `CHECK TABLE` does not find any problems in the table. In this case, `CHECK TABLE` marks the table as okay.

If a table is corrupted, it is most likely that the problem is in the indexes and not in the data part. All of the preceding check types check the indexes thoroughly and should thus find most errors.

If you just want to check a table that you assume is okay, you should use no check options or the `QUICK` option. The latter should be used when you are in a hurry and can take the very small risk that `QUICK` does not find an error in the data file. (In most cases, under normal usage, MySQL should find any error in the data file. If this happens, the table is marked as “corrupted” and cannot be used until it is repaired.)

`FAST` and `CHANGED` are mostly intended to be used from a script (for example, to be executed from `cron`) if you want to check tables from time to time. In most cases, `FAST` is to be preferred over `CHANGED`. (The only case when it is not preferred is when you suspect that you have found a bug in the `MyISAM` code.)

`EXTENDED` is to be used only after you have run a normal check but still get strange errors from a table when MySQL tries to update a row or find a row by key. This is very unlikely if a normal check has succeeded.

Use of `CHECK TABLE . . . EXTENDED` might influence the execution plan generated by the query optimizer.

Some problems reported by `CHECK TABLE` cannot be corrected automatically:

- `Found row where the auto_increment column has the value 0.`

This means that you have a row in the table where the `AUTO_INCREMENT` index column contains the value 0. (It is possible to create a row where the `AUTO_INCREMENT` column is 0 by explicitly setting the column to 0 with an `UPDATE` statement.)

This is not an error in itself, but could cause trouble if you decide to dump the table and restore it or do an `ALTER TABLE` on the table. In this case, the `AUTO_INCREMENT` column changes value according to the rules of `AUTO_INCREMENT` columns, which could cause problems such as a duplicate-key error.

To get rid of the warning, simply execute an `UPDATE` statement to set the column to some value other than 0.

- If `CHECK TABLE` finds a problem for an `InnoDB` table, the server shuts down to prevent error propagation. Details of the error will be written to the error log.

### 12.5.2.4. CHECKSUM TABLE Syntax

```
CHECKSUM TABLE tbl_name [, tbl_name] ... [ QUICK | EXTENDED ]
```

`CHECKSUM TABLE` reports a table checksum.

With `QUICK`, the live table checksum is reported if it is available, or `NULL` otherwise. This is very fast. A live checksum is enabled by specifying the `CHECKSUM=1` table option when you create the table; currently, this is supported only for `MyISAM` tables. See [Section 12.1.17, “CREATE TABLE Syntax”](#).

With `EXTENDED`, the entire table is read row by row and the checksum is calculated. This can be very slow for large tables.

If neither `QUICK` nor `EXTENDED` is specified, MySQL returns a live checksum if the table storage engine supports it and scans the table otherwise.

For a non-existent table, `CHECKSUM TABLE` returns `NULL` and generates a warning.

The checksum value depends on the table row format. If the row format changes, the checksum also changes. For example, the storage format for `VARCHAR` changed between MySQL 4.1 and 5.0, so if a 4.1 table is upgraded to MySQL 5.0, the checksum value may change.

#### Important

If the checksums for two tables are different, then the tables are different in some way. However, the fact that two tables produce the same checksum does *not* mean that the tables are identical.

### 12.5.2.5. OPTIMIZE TABLE Syntax

```
OPTIMIZE [NO_WRITE_TO_BINLOG | LOCAL] TABLE  
tbl_name [, tbl_name] ...
```

`OPTIMIZE TABLE` should be used if you have deleted a large part of a table or if you have made many changes to a table with variable-length rows (tables that have `VARCHAR`, `VARBINARY`, `BLOB`, or `TEXT` columns). Deleted rows are maintained in a linked list and subsequent `INSERT` operations reuse old row positions. You can use `OPTIMIZE TABLE` to reclaim the unused space and to defragment the data file.

This statement requires `SELECT` and `INSERT` privileges for the table.

Beginning with MySQL 5.1.27, `OPTIMIZE TABLE` is also supported for partitioned tables. Also beginning with MySQL 5.1.27, you can use `ALTER TABLE ... OPTIMIZE PARTITION` to optimize one or more partitions; for more information, see [Section 12.1.7, “ALTER TABLE Syntax”](#), and [Section 17.3.3, “Maintenance of Partitions”](#).

In most setups, you need not run `OPTIMIZE TABLE` at all. Even if you do a lot of updates to variable-length rows, it is not likely that you need to do this more than once a week or month and only on certain tables.

`OPTIMIZE TABLE` works *only* for `MyISAM`, `InnoDB`, and `ARCHIVE` tables. It does *not* work for tables created using any other storage engine, including `NDBCLUSTER` Disk Data tables.

Beginning with MySQL Cluster NDB 6.3.7, `OPTIMIZE TABLE` is supported for dynamic columns of in-memory `NDBCLUSTER` tables. The performance of `OPTIMIZE` on Cluster tables can be tuned by adjusting the value of the `ndb_optimization_delay` system variable, which controls the number of milliseconds to wait between processing batches of rows by `OPTIMIZE TABLE`. See [Previous MySQL Cluster Issues Resolved in MySQL 5.1 and MySQL Cluster NDB 6.x](#), for more information.

Beginning with MySQL Cluster NDB 6.3.8, `OPTIMIZE TABLE` can be interrupted by (for example) killing the SQL thread performing the `OPTIMIZE` operation.

For `MyISAM` tables, `OPTIMIZE TABLE` works as follows:

1. If the table has deleted or split rows, repair the table.
2. If the index pages are not sorted, sort them.

- If the table's statistics are not up to date (and the repair could not be accomplished by sorting the index), update them.

For `InnoDB` tables, `OPTIMIZE TABLE` is mapped to `ALTER TABLE`, which rebuilds the table to update index statistics and free unused space in the clustered index. Beginning with MySQL 5.1.27, this is displayed in the output of `OPTIMIZE TABLE` when you run it on an `InnoDB` table, as shown here:

```
mysql> OPTIMIZE TABLE foo;
+-----+-----+-----+-----+
| Table      | Op       | Msg_type | Msg_text                                     |
+-----+-----+-----+-----+
| test.foo   | optimize | note     | Table does not support optimize, doing recreate + analyze instead |
| test.foo   | optimize | status   | OK                                          |
+-----+-----+-----+-----+
```

You can make `OPTIMIZE TABLE` work on other storage engines by starting `mysqld` with the `--skip-new` or `--safe-mode` option. In this case, `OPTIMIZE TABLE` is just mapped to `ALTER TABLE`.

`OPTIMIZE TABLE` returns a result set with the following columns.

Column	Value
Table	The table name
Op	Always <code>optimize</code>
Msg_type	<code>status</code> , <code>error</code> , <code>info</code> , or <code>warning</code>
Msg_text	An informational message

Note that MySQL locks the table during the time `OPTIMIZE TABLE` is running.

By default, `OPTIMIZE TABLE` statements are written to the binary log so that they will be replicated to replication slaves. Logging can be suppressed with the optional `NO_WRITE_TO_BINLOG` keyword or its alias `LOCAL`.

`OPTIMIZE TABLE` does not sort R-tree indexes, such as spatial indexes on `POINT` columns. ([Bug#23578](#))

### 12.5.2.6. REPAIR TABLE Syntax

```
REPAIR [NO_WRITE_TO_BINLOG | LOCAL] TABLE
tbl_name [, tbl_name] ...
[QUICK] [EXTENDED] [USE_FRM]
```

`REPAIR TABLE` repairs a possibly corrupted table. By default, it has the same effect as `myisamchk --recover tbl_name`. `REPAIR TABLE` works for `MyISAM` and for `ARCHIVE` tables. Starting with MySQL 5.1.9, `REPAIR` is also valid for `CSV` tables. See [Section 13.4, “The MyISAM Storage Engine”](#), and [Section 13.11, “The ARCHIVE Storage Engine”](#), and [Section 13.12, “The CSV Storage Engine”](#)

This statement requires `SELECT` and `INSERT` privileges for the table.

Beginning with MySQL 5.1.27, `REPAIR TABLE` is also supported for partitioned tables. However, the `USE_FRM` option cannot be used with this statement on a partitioned table.

Also beginning with MySQL 5.1.27, you can use `ALTER TABLE ... REPAIR PARTITION` to repair one or more partitions; for more information, see [Section 12.1.7, “ALTER TABLE Syntax”](#), and [Section 17.3.3, “Maintenance of Partitions”](#).

Normally, you should never have to run `REPAIR TABLE`. However, if disaster strikes, this statement is very likely to get back all your data from a `MyISAM` table. If your tables become corrupted often, you should try to find the reason for it, to eliminate the need to use `REPAIR TABLE`. See [Section B.1.4.2, “What to Do If MySQL Keeps Crashing”](#), and [Section 13.4.4, “MyISAM Table Problems”](#).

#### Caution

It is best to make a backup of a table before performing a table repair operation; under some circumstances the operation might cause data loss. Possible causes include but are not limited to file system errors.

#### Warning

If the server dies during a `REPAIR TABLE` operation, it is essential after restarting it that you immediately execute another `REPAIR TABLE` statement for the table before performing any other operations on it. In the worst case, you might have a new clean index file without information about the data file, and then the next operation you perform could overwrite the data file. This is an unlikely but possible scenario that underscores the value of making a backup

■ first.

`REPAIR TABLE` returns a result set with the following columns.

Column	Value
Table	The table name
Op	Always <code>repair</code>
Msg_type	<code>status</code> , <code>error</code> , <code>info</code> , or <code>warning</code>
Msg_text	An informational message

The `REPAIR TABLE` statement might produce many rows of information for each repaired table. The last row has a `Msg_type` value of `status` and `Msg_text` normally should be `OK`. If you do not get `OK` for a `MyISAM` table, you should try repairing it with `myisamchk --safe-recover`. (`REPAIR TABLE` does not implement all the options of `myisamchk`.) With `myisamchk --safe-recover`, you can also use options that `REPAIR TABLE` does not support, such as `--max-record-length`.

If you use the `QUICK` option, `REPAIR TABLE` tries to repair only the index tree. This type of repair is like that done by `myisamchk --recover --quick`.

If you use the `EXTENDED` option, MySQL creates the index row by row instead of creating one index at a time with sorting. This type of repair is like that done by `myisamchk --safe-recover`.

The `USE_FRM` option is available for use if the `.MYI` index file is missing or if its header is corrupted. This option tells MySQL not to trust the information in the `.MYI` file header and to re-create it using information from the `.frm` file. This kind of repair cannot be done with `myisamchk`.

### Note

Use the `USE_FRM` option *only* if you cannot use regular `REPAIR` modes! Telling the server to ignore the `.MYI` file makes important table metadata stored in the `.MYI` unavailable to the repair process, which can have deleterious consequences:

- The current `AUTO_INCREMENT` value is lost.
- The link to deleted records in the table is lost, which means that free space for deleted records will remain unoccupied thereafter.
- The `.MYI` header indicates whether the table is compressed. If the server ignores this information, it cannot tell that a table is compressed and repair can cause change or loss of table contents. This means that `USE_FRM` should not be used with compressed tables. That should not be necessary, anyway: Compressed tables are read only, so they should not become corrupt.

### Caution

As of MySQL 5.1.25, if you use `USE_FRM` for a table that was created by a different version of the MySQL server than the one you are currently running, `REPAIR TABLE` will not attempt to repair the table. In this case, the result set returned by `REPAIR TABLE` contains a line with a `Msg_type` value of `error` and a `Msg_text` value of `Failed repairing incompatible .FRM file`.

Prior to MySQL 5.1.25, *do not use* `USE_FRM` if your table was created by a different version of the MySQL server. Doing so risks the loss of all rows in the table. It is particularly dangerous to use `USE_FRM` after the server returns this message:

```
Table upgrade required. Please do
"REPAIR TABLE `tbl_name`" to fix it!
```

If `USE_FRM` is *not* used, `REPAIR TABLE` checks the table to see whether an upgrade is required. If so, it performs the upgrade, following the same rules as `CHECK TABLE ... FOR UPGRADE`. See [Section 12.5.2.3, “CHECK TABLE Syntax”](#), for more information. As of MySQL 5.1.25, `REPAIR TABLE` without `USE_FRM` upgrades the `.frm` file to the current version.

By default, `REPAIR TABLE` statements are written to the binary log so that they will be replicated to replication slaves. Logging can be suppressed with the optional `NO_WRITE_TO_BINLOG` keyword or its alias `LOCAL`.

## 12.5.2.7. RESTORE TABLE Syntax

```
RESTORE TABLE tbl_name [, tbl_name] ... FROM '/path/to/backup/directory'
```

`RESTORE TABLE` restores the table or tables from a backup that was made with `BACKUP TABLE`. The directory should be specified as a full path name.

Existing tables are not overwritten; if you try to restore over an existing table, an error occurs. Just as for `BACKUP TABLE`, `RESTORE TABLE` currently works only for `MyISAM` tables. Restored tables are not replicated from master to slave.

The backup for each table consists of its `.frm` format file and `.MYD` data file. The restore operation restores those files, and then uses them to rebuild the `.MYI` index file. Restoring takes longer than backing up due to the need to rebuild the indexes. The more indexes the table has, the longer it takes.

`RESTORE TABLE` returns a result set with the following columns.

Column	Value
Table	The table name
Op	Always <code>restore</code>
Msg_type	One of <code>status</code> , <code>error</code> , <code>info</code> , or <code>warning</code>
Msg_text	The message

## 12.5.3. Plugin and User-Defined Function Statements

### 12.5.3.1. CREATE FUNCTION Syntax

```
CREATE [AGGREGATE] FUNCTION function_name RETURNS {STRING|INTEGER|REAL|DECIMAL}
SONAME shared_library_name
```

A user-defined function (UDF) is a way to extend MySQL with a new function that works like a native (built-in) MySQL function such as `ABS()` or `CONCAT()`.

*function\_name* is the name that should be used in SQL statements to invoke the function. The `RETURNS` clause indicates the type of the function's return value. `DECIMAL` is a legal value after `RETURNS`, but currently `DECIMAL` functions return string values and should be written like `STRING` functions.

*shared\_library\_name* is the basename of the shared object file that contains the code that implements the function. The file must be located in the plugin directory. This directory is given by the value of the `plugin_dir` system variable.

#### Note

This is a change in MySQL 5.1. For earlier versions of MySQL, the shared object can be located in any directory that is searched by your system's dynamic linker.

To create a function, you must have the `INSERT` privilege for the `mysql` database. This is necessary because `CREATE FUNCTION` adds a row to the `mysql.func` system table that records the function's name, type, and shared library name. If you do not have this table, you should run the `mysql_upgrade` command to create it. See [Section 4.4.8, “mysql\\_upgrade — Check Tables for MySQL Upgrade”](#).

An active function is one that has been loaded with `CREATE FUNCTION` and not removed with `DROP FUNCTION`. All active functions are reloaded each time the server starts, unless you start `mysqld` with the `--skip-grant-tables` option. In this case, UDF initialization is skipped and UDFs are unavailable.

For instructions on writing user-defined functions, see [Section 21.3.2, “Adding a New User-Defined Function”](#). For the UDF mechanism to work, functions must be written in C or C++ (or another language that can use C calling conventions), your operating system must support dynamic loading and you must have compiled `mysqld` dynamically (not statically).

An `AGGREGATE` function works exactly like a native MySQL aggregate (summary) function such as `SUM` or `COUNT()`. For `AGGREGATE` to work, your `mysql.func` table must contain a `type` column. If your `mysql.func` table does not have this column, you should run the `mysql_upgrade` program to create it (see [Section 4.4.8, “mysql\\_upgrade — Check Tables for MySQL Upgrade”](#)).

#### Note

To upgrade the shared library associated with a UDF, issue a `DROP FUNCTION` statement, upgrade the shared library, and then issue a `CREATE FUNCTION` statement. If you upgrade the shared library first and then use `DROP FUNCTION`, the server may crash.

### 12.5.3.2. DROP FUNCTION Syntax



```
DROP FUNCTION function_name
```

This statement drops the user-defined function (UDF) named *function\_name*.

To drop a function, you must have the `DELETE` privilege for the `mysql` database. This is because `DROP FUNCTION` removes a row from the `mysql.func` system table that records the function's name, type, and shared library name.

### Note

To upgrade the shared library associated with a UDF, issue a `DROP FUNCTION` statement, upgrade the shared library, and then issue a `CREATE FUNCTION` statement. If you upgrade the shared library first and then use `DROP FUNCTION`, the server may crash.

`DROP FUNCTION` is also used to drop stored functions (see [Section 12.1.26](#), “`DROP PROCEDURE` and `DROP FUNCTION Syntax`”).

## 12.5.3.3. INSTALL PLUGIN Syntax

```
INSTALL PLUGIN plugin_name SONAME 'plugin_library'
```

This statement installs a plugin.

*plugin\_name* is the name of the plugin as defined in the plugin declaration structure contained in the library file. Plugin names are not case sensitive. For maximal compatibility, plugin names should be limited to ASCII letters, digits, and underscore, because they are used in C source files, shell command lines, M4 and Bourne shell scripts, and SQL environments.

*plugin\_library* is the name of the shared library that contains the plugin code. The name includes the file name extension (for example, `libmyplugin.so` or `libmyplugin.dylib`).

The shared library must be located in the plugin directory (that is, the directory named by the `plugin_dir` system variable). The library must be in the plugin directory itself, not in a subdirectory. By default, `plugin_dir` is `plugin` directory under the directory named by the `pkglibdir` configuration variable, but it can be changed by setting the value of `plugin_dir` at server startup. For example, set its value in a `my.cnf` file:

```
[mysqld]
plugin_dir=/path/to/plugin/directory
```

If the value of `plugin_dir` is a relative path name, it is taken to be relative to the MySQL base directory (the value of the `basedir` system variable).

`INSTALL PLUGIN` adds a line to the `mysql.plugin` table that describes the `plugin`. This table contains the plugin name and library file name.

As of MySQL 5.1.33, `INSTALL PLUGIN` causes the server to read option (`my.cnf`) files just as during server startup. This enables the plugin to pick up any relevant options from those files. It is possible to add plugin options to an option file even before loading a plugin (if the `loose` prefix is used). It is also possible to uninstall a plugin, edit `my.cnf`, and install the plugin again. Restarting the plugin this way enables it to the new option values without a server restart.

Before MySQL 5.1.33, a plugin is started with each option set to its default value.

`INSTALL PLUGIN` also loads and initializes the plugin code to make the plugin available for use. A plugin is initialized by executing its initialization function, which handles any setup that the plugin must perform before it can be used.

To use `INSTALL PLUGIN`, you must have the `INSERT` privilege for the `mysql.plugin` table.

At server startup, the server loads and initializes any plugin that is listed in the `mysql.plugin` table. This means that a plugin is installed with `INSTALL PLUGIN` only once, not every time the server starts. Plugin loading at startup does not occur if the server is started with the `--skip-grant-tables` option.

When the server shuts down, it executes the deinitialization function for each plugin that is loaded so that the plugin has a change to perform any final cleanup.

If you need to load plugins for a single server startup when the `--skip-grant-tables` option is given (which tells the server not to read system tables), use the `--plugin-load` option. See [Section 5.1.2](#), “`Server Command Options`”.

To remove a plugin entirely, use the `UNINSTALL PLUGIN` statement:

To see what plugins are installed, use the `SHOW PLUGIN` statement.

If you recompile a plugin library and need to reinstall it, you can use either of the following procedures:

- Use `UNINSTALL PLUGIN` to uninstall all plugins in the library, install the new plugin library file in the plugin directory, and then use `INSTALL PLUGIN` to install all plugins in the library. This procedure has the advantage that it can be used without stopping the server. However, if the plugin library contains many plugins, you must issue many `INSTALL PLUGIN` and `UNINSTALL PLUGIN` statements.
- Alternatively, stop the server, install the new plugin library file in the plugin directory, and then restart the server.

### 12.5.3.4. UNINSTALL PLUGIN Syntax

```
UNINSTALL PLUGIN plugin_name
```

This statement removes an installed plugin. You cannot uninstall a plugin if any table that uses it is open.

*plugin\_name* must be the name of some plugin that is listed in the `mysql.plugin` table. The server executes the plugin's deinitialization function and removes the row for the plugin from the `mysql.plugin` table, so that subsequent server restarts will not load and initialize the plugin. `UNINSTALL PLUGIN` does not remove the plugin's shared library file.

To use `UNINSTALL PLUGIN`, you must have the `DELETE` privilege for the `mysql.plugin` table.

Plugin removal has implications for the use of associated tables. For example, if a full-text parser plugin is associated with a `FULLTEXT` index on the table, uninstalling the plugin makes the table unusable. Any attempt to access the table results in an error. The table cannot even be opened, so you cannot drop an index for which the plugin is used. This means that uninstalling a plugin is something to do with care unless you do not care about the table contents. If you are uninstalling a plugin with no intention of reinstalling it later and you care about the table contents, you should dump the table with `mysqldump` and remove the `WITH PARSER` clause from the dumped `CREATE TABLE` statement so that you can reload the table later. If you do not care about the table, `DROP TABLE` can be used even if any plugins associated with the table are missing.

## 12.5.4. SET Syntax

```
SET variable_assignment [, variable_assignment] ...

variable_assignment:
  user_var_name = expr
  | [GLOBAL | SESSION] system_var_name = expr
  | [@@global. | @@session. | @@] system_var_name = expr
```

The `SET` statement assigns values to different types of variables that affect the operation of the server or your client. Older versions of MySQL employed `SET OPTION`, but this syntax is deprecated in favor of `SET` without `OPTION`.

This section describes use of `SET` for assigning values to system variables or user variables. For general information about these types of variables, see [Section 5.1.3, “Server System Variables”](#), [Section 5.1.4, “Session System Variables”](#), and [Section 8.4, “User-Defined Variables”](#). System variables also can be set at server startup, as described in [Section 5.1.5, “Using System Variables”](#).

Some variants of `SET` syntax are used in other contexts:

- `SET CHARACTER SET` and `SET NAMES` assign values to character set and collation variables associated with the connection to the server. `SET ONESHOT` is used for replication. These variants are described later in this section.
- `SET PASSWORD` assigns account passwords. See [Section 12.5.1.6, “SET PASSWORD Syntax”](#).
- `SET TRANSACTION ISOLATION LEVEL` sets the isolation level for transaction processing. See [Section 12.4.6, “SET TRANSACTION Syntax”](#).
- `SET` is used within stored routines to assign values to local routine variables. See [Section 12.8.3.2, “Variable SET Statement”](#).

The following discussion shows the different `SET` syntaxes that you can use to set variables. The examples use the `=` assignment operator, but the `:=` operator also is allowable.

A user variable is written as `@var_name` and can be set as follows:

```
SET @var_name = expr;
```

Many system variables are dynamic and can be changed while the server runs by using the `SET` statement. For a list, see [Section 5.1.5.2, “Dynamic System Variables”](#). To change a system variable with `SET`, refer to it as `var_name`, optionally preceded by a modifier:



- To indicate explicitly that a variable is a global variable, precede its name by `GLOBAL` or `@@global.`. The `SUPER` privilege is required to set global variables.
- To indicate explicitly that a variable is a session variable, precede its name by `SESSION`, `@@session.`, or `@@`. Setting a session variable requires no special privilege, but a client can change only its own session variables, not those of any other client.
- `LOCAL` and `@@local.` are synonyms for `SESSION` and `@@session.`
- If no modifier is present, `SET` changes the session variable.

### MySQL Enterprise

The MySQL Enterprise Monitor makes extensive use of system variables to determine the state of your server. For more information, see <http://www.mysql.com/products/enterprise/advisors.html>.

A `SET` statement can contain multiple variable assignments, separated by commas. If you set several system variables, the most recent `GLOBAL` or `SESSION` modifier in the statement is used for following variables that have no modifier specified.

Examples:

```
SET sort_buffer_size=10000;
SET @@local.sort_buffer_size=10000;
SET GLOBAL sort_buffer_size=1000000, SESSION sort_buffer_size=1000000;
SET @@sort_buffer_size=1000000;
SET @@global.sort_buffer_size=1000000, @@local.sort_buffer_size=1000000;
```

The `@@var_name` syntax for system variables is supported for compatibility with some other database systems.

If you change a session system variable, the value remains in effect until your session ends or until you change the variable to a different value. The change is not visible to other clients.

If you change a global system variable, the value is remembered and used for new connections until the server restarts. (To make a global system variable setting permanent, you should set it in an option file.) The change is visible to any client that accesses that global variable. However, the change affects the corresponding session variable only for clients that connect after the change. The global variable change does not affect the session variable for any client that is currently connected (not even that of the client that issues the `SET GLOBAL` statement).

To prevent incorrect usage, MySQL produces an error if you use `SET GLOBAL` with a variable that can only be used with `SET SESSION` or if you do not specify `GLOBAL` (or `@@global.`) when setting a global variable.

To set a `SESSION` variable to the `GLOBAL` value or a `GLOBAL` value to the compiled-in MySQL default value, use the `DEFAULT` keyword. For example, the following two statements are identical in setting the session value of `max_join_size` to the global value:

```
SET max_join_size=DEFAULT;
SET @@session.max_join_size=@@global.max_join_size;
```

Not all system variables can be set to `DEFAULT`. In such cases, use of `DEFAULT` results in an error.

You can refer to the values of specific global or session system variables in expressions by using one of the `@@`-modifiers. For example, you can retrieve values in a `SELECT` statement like this:

```
SELECT @@global.sql_mode, @@session.sql_mode, @@sql_mode;
```

When you refer to a system variable in an expression as `@@var_name` (that is, when you do not specify `@@global.` or `@@session.`), MySQL returns the session value if it exists and the global value otherwise. (This differs from `SET @@var_name = value`, which always refers to the session value.)

### Note

Some variables displayed by `SHOW VARIABLES` may not be available using `SELECT @@var_name` syntax; an `Unknown system variable` occurs. As a workaround in such cases, you can use `SHOW VARIABLES LIKE 'var_name'`.

Suffixes for specifying a value multiplier can be used when setting a variable at server startup, but not to set the value with `SET` at runtime. On the other hand, with `SET` you can assign a variable's value using an expression, which is not true when you set a variable at server startup. For example, the first of the following lines is legal at server startup, but the second is not:

```
shell> mysql --max_allowed_packet=16M
shell> mysql --max_allowed_packet=16*1024*1024
```

Conversely, the second of the following lines is legal at runtime, but the first is not:

```
mysql> SET GLOBAL max_allowed_packet=16M;
mysql> SET GLOBAL max_allowed_packet=16*1024*1024;
```

To display system variables names and values, use the `SHOW VARIABLES` statement. (See [Section 12.5.5.41](#), “`SHOW VARIABLES Syntax`”.)

The following list describes `SET` options that have non-standard syntax (that is, options that are not set with `name = value` syntax).

- `CHARACTER SET {charset_name | DEFAULT}`

This maps all strings from and to the client with the given mapping. You can add new mappings by editing `sql/convert.cc` in the MySQL source distribution. `SET CHARACTER SET` sets three session system variables: `character_set_client` and `character_set_results` are set to the given character set, and `character_set_connection` to the value of `character_set_database`. See [Section 9.1.4](#), “[Connection Character Sets and Collations](#)”.

The default mapping can be restored by using the value `DEFAULT`. The default depends on the server configuration.

`ucs2` cannot be used as a client character set, which means that it does not work for `SET CHARACTER SET`.

- `NAMES {'charset_name' [COLLATE 'collation_name'] | DEFAULT}`

`SET NAMES` sets the three session system variables `character_set_client`, `character_set_connection`, and `character_set_results` to the given character set. Setting `character_set_connection` to `charset_name` also sets `collation_connection` to the default collation for `charset_name`. The optional `COLLATE` clause may be used to specify a collation explicitly. See [Section 9.1.4](#), “[Connection Character Sets and Collations](#)”.

The default mapping can be restored by using a value of `DEFAULT`. The default depends on the server configuration.

`ucs2` cannot be used as a client character set, which means that it does not work for `SET NAMES`.

- `ONE_SHOT`

This option is a modifier, not a variable. It can be used to influence the effect of variables that set the character set, the collation, and the time zone. `ONE_SHOT` is primarily used for replication purposes: `mysqlbinlog` uses `SET ONE_SHOT` to modify temporarily the values of character set, collation, and time zone variables to reflect at rollforward what they were originally. `ONE_SHOT` is for internal use only and is deprecated for MySQL 5.0 and up.

You cannot use `ONE_SHOT` with other than the allowed set of variables; if you try, you get an error like this:

```
mysql> SET ONE_SHOT max_allowed_packet = 1;
ERROR 1382 (HY000): The 'SET ONE_SHOT' syntax is reserved for purposes
internal to the MySQL server
```

If `ONE_SHOT` is used with the allowed variables, it changes the variables as requested, but only for the next non-`SET` statement. After that, the server resets all character set, collation, and time zone-related system variables to their previous values. Example:

```
mysql> SET ONE_SHOT character_set_connection = latin5;
mysql> SET ONE_SHOT collation_connection = latin5_turkish_ci;
mysql> SHOW VARIABLES LIKE '%_connection';
+-----+-----+
| Variable_name | Value |
+-----+-----+
| character_set_connection | latin5 |
| collation_connection | latin5_turkish_ci |
+-----+-----+
mysql> SHOW VARIABLES LIKE '%_connection';
+-----+-----+
| Variable_name | Value |
+-----+-----+
| character_set_connection | latin1 |
| collation_connection | latin1_swedish_ci |
+-----+-----+
```

## 12.5.5. `SHOW Syntax`

`SHOW` has many forms that provide information about databases, tables, columns, or status information about the server. This section describes those following:

```
SHOW AUTHORS
SHOW CHARACTER SET [like_or_where]
SHOW COLLATION [like_or_where]
SHOW [FULL] COLUMNS FROM tbl_name [FROM db_name] [like_or_where]
SHOW CONTRIBUTORS
SHOW CREATE DATABASE db_name
SHOW CREATE EVENT event_name
SHOW CREATE FUNCTION func_name
SHOW CREATE PROCEDURE proc_name
SHOW CREATE TABLE tbl_name
SHOW CREATE TRIGGER trigger_name
SHOW CREATE VIEW view_name
SHOW DATABASES [like_or_where]
SHOW ENGINE engine_name {STATUS | MUTEX}
SHOW [STORAGE] ENGINES
SHOW ERRORS [LIMIT [offset,] row_count]
SHOW [FULL] EVENTS
SHOW FUNCTION CODE func_name
SHOW FUNCTION STATUS [like_or_where]
SHOW GRANTS FOR user
SHOW INDEX FROM tbl_name [FROM db_name]
SHOW INNODB STATUS
SHOW OPEN TABLES [FROM db_name] [like_or_where]
SHOW PLUGINS
SHOW PROCEDURE CODE proc_name
SHOW PROCEDURE STATUS [like_or_where]
SHOW PRIVILEGES
SHOW [FULL] PROCESSLIST
SHOW PROFILE [types] [FOR QUERY n] [OFFSET n] [LIMIT n]
SHOW PROFILES
SHOW SCHEDULER STATUS
SHOW [GLOBAL | SESSION] STATUS [like_or_where]
SHOW TABLE STATUS [FROM db_name] [like_or_where]
SHOW TABLES [FROM db_name] [like_or_where]
SHOW TRIGGERS [FROM db_name] [like_or_where]
SHOW [GLOBAL | SESSION] VARIABLES [like_or_where]
SHOW WARNINGS [LIMIT [offset,] row_count]

like_or_where:
  LIKE 'pattern'
  | WHERE expr
```

If the syntax for a given `SHOW` statement includes a `LIKE 'pattern'` part, '*pattern*' is a string that can contain the SQL “%” and “\_” wildcard characters. The pattern is useful for restricting statement output to matching values.

Several `SHOW` statements also accept a `WHERE` clause that provides more flexibility in specifying which rows to display. See [Section 19.28, “Extensions to SHOW Statements”](#).

Many MySQL APIs (such as PHP) allow you to treat the result returned from a `SHOW` statement as you would a result set from a `SELECT`; see [Chapter 20, Connectors and APIs](#), or your API documentation for more information. In addition, you can work in SQL with results from queries on tables in the `INFORMATION_SCHEMA` database, which you cannot easily do with results from `SHOW` statements. See [Chapter 19, INFORMATION\\_SCHEMA Tables](#).

### 12.5.5.1. SHOW AUTHORS Syntax

```
SHOW AUTHORS
```

The `SHOW AUTHORS` statement displays information about the people who work on MySQL. For each author, it displays `Name`, `Location`, and `Comment` values.

This statement was added in MySQL 5.1.3.

### 12.5.5.2. SHOW BINARY LOGS Syntax

```
SHOW BINARY LOGS
SHOW MASTER LOGS
```

Lists the binary log files on the server. This statement is used as part of the procedure described in [Section 12.6.1.1, “PURGE BINARY LOGS Syntax”](#), that shows how to determine which logs can be purged.

```
mysql> SHOW BINARY LOGS;
+-----+-----+
| Log_name | File_size |
+-----+-----+
| binlog.000015 | 724935 |
| binlog.000016 | 733481 |
+-----+-----+
```

`SHOW MASTER LOGS` is equivalent to `SHOW BINARY LOGS`.

### 12.5.5.3. SHOW BINLOG EVENTS Syntax

```
SHOW BINLOG EVENTS
  [IN 'log_name'] [FROM pos] [LIMIT [offset,] row_count]
```

Shows the events in the binary log. If you do not specify `'log_name'`, the first binary log is displayed.

The `LIMIT` clause has the same syntax as for the `SELECT` statement. See [Section 12.2.8, “SELECT Syntax”](#).

#### Note

Issuing a `SHOW BINLOG EVENTS` with no `LIMIT` clause could start a very time- and resource-consuming process because the server returns to the client the complete contents of the binary log (which includes all statements executed by the server that modify data). As an alternative to `SHOW BINLOG EVENTS`, use the `mysqlbinlog` utility to save the binary log to a text file for later examination and analysis. See [Section 4.6.7, “mysqlbinlog — Utility for Processing Binary Log Files”](#).

#### Note

Events relating to the setting of variables are not included in the output from `SHOW BINLOG EVENTS`. To get complete coverage of events within a binary log, use `mysqlbinlog`.

### 12.5.5.4. SHOW CHARACTER SET Syntax

```
SHOW CHARACTER SET
  [LIKE 'pattern' | WHERE expr]
```

The `SHOW CHARACTER SET` statement shows all available character sets. The `LIKE` clause, if present, indicates which character set names to match. The `WHERE` clause can be given to select rows using more general conditions, as discussed in [Section 19.28, “Extensions to SHOW Statements”](#). For example:

```
mysql> SHOW CHARACTER SET LIKE 'latin%';
+-----+-----+-----+-----+
| Charset | Description | Default collation | Maxlen |
+-----+-----+-----+-----+
| latin1  | cp1252 West European | latin1_swedish_ci | 1 |
| latin2  | ISO 8859-2 Central European | latin2_general_ci | 1 |
| latin5  | ISO 8859-9 Turkish | latin5_turkish_ci | 1 |
| latin7  | ISO 8859-13 Baltic | latin7_general_ci | 1 |
+-----+-----+-----+-----+
```

The `Maxlen` column shows the maximum number of bytes required to store one character.

### 12.5.5.5. SHOW COLLATION Syntax

```
SHOW COLLATION
  [LIKE 'pattern' | WHERE expr]
```

The output from `SHOW COLLATION` includes all available character sets. The `LIKE` clause, if present, indicates which collation names to match. The `WHERE` clause can be given to select rows using more general conditions, as discussed in [Section 19.28, “Extensions to SHOW Statements”](#). For example:

```
mysql> SHOW COLLATION LIKE 'latin1%';
+-----+-----+-----+-----+-----+-----+
| Collation | Charset | Id | Default | Compiled | Sortlen |
+-----+-----+-----+-----+-----+-----+
| latin1_german1_ci | latin1 | 5 | | | 0 |
| latin1_swedish_ci | latin1 | 8 | Yes | Yes | 0 |
| latin1_danish_ci | latin1 | 15 | | | 0 |
| latin1_german2_ci | latin1 | 31 | | Yes | 2 |
| latin1_bin | latin1 | 47 | | Yes | 0 |
| latin1_general_ci | latin1 | 48 | | | 0 |
| latin1_general_cs | latin1 | 49 | | | 0 |
| latin1_spanish_ci | latin1 | 94 | | | 0 |
+-----+-----+-----+-----+-----+-----+
```

The `Default` column indicates whether a collation is the default for its character set. `Compiled` indicates whether the character set is compiled into the server. `Sortlen` is related to the amount of memory required to sort strings expressed in the character set.

To see the default collation for each character set, use the following statement. `Default` is a reserved word, so to use it as an identifier, it must be quoted as such:

```
mysql> SHOW COLLATION WHERE `Default` = 'Yes';
```

Collation	Charset	Id	Default	Compiled	Sortlen
big5_chinese_ci	big5	1	Yes	Yes	1
dec8_swedish_ci	dec8	3	Yes	Yes	1
cp850_general_ci	cp850	4	Yes	Yes	1
hp8_english_ci	hp8	6	Yes	Yes	1
koi8r_general_ci	koi8r	7	Yes	Yes	1
latin1_swedish_ci	latin1	8	Yes	Yes	1

...

## 12.5.5.6. SHOW COLUMNS Syntax

```
SHOW [FULL] COLUMNS {FROM | IN} tbl_name [{FROM | IN} db_name]
[LIKE 'pattern' | WHERE expr]
```

`SHOW COLUMNS` displays information about the columns in a given table. It also works for views. The `LIKE` clause, if present, indicates which column names to match. The `WHERE` clause can be given to select rows using more general conditions, as discussed in [Section 19.28, “Extensions to SHOW Statements”](#).

```
mysql> SHOW COLUMNS FROM City;
```

Field	Type	Null	Key	Default	Extra
Id	int(11)	NO	PRI	NULL	auto_increment
Name	char(35)	NO			
Country	char(3)	NO	UNI		
District	char(20)	YES	MUL		
Population	int(11)	NO		0	

5 rows in set (0.00 sec)

If the data types differ from what you expect them to be based on a `CREATE TABLE` statement, note that MySQL sometimes changes data types when you create or alter a table. The conditions under which this occurs are described in [Section 12.1.17.1, “Silent Column Specification Changes”](#).

The `FULL` keyword causes the output to include the column collation and comments, as well as the privileges you have for each column.

You can use `db_name.tbl_name` as an alternative to the `tbl_name FROM db_name` syntax. In other words, these two statements are equivalent:

```
mysql> SHOW COLUMNS FROM mytable FROM mydb;
mysql> SHOW COLUMNS FROM mydb.mytable;
```

`SHOW COLUMNS` displays the following values for each table column:

**Field** indicates the column name.

**Type** indicates the column data type.

**Collation** indicates the collation for nonbinary string columns, or `NULL` for other columns. This value is displayed only if you use the `FULL` keyword.

The **Null** field contains `YES` if `NULL` values can be stored in the column, `NO` if not.

The **Key** field indicates whether the column is indexed:

- If **Key** is empty, the column either is not indexed or is indexed only as a secondary column in a multiple-column, non-unique index.
- If **Key** is `PRI`, the column is a **PRIMARY KEY** or is one of the columns in a multiple-column **PRIMARY KEY**.
- If **Key** is `UNI`, the column is the first column of a unique-valued index that cannot contain `NULL` values.
- If **Key** is `MUL`, multiple occurrences of a given value are allowed within the column. The column is the first column of a non-unique index or a unique-valued index that can contain `NULL` values.

If more than one of the **Key** values applies to a given column of a table, **Key** displays the one with the highest priority, in the order `PRI`, `UNI`, `MUL`.

A **UNIQUE** index may be displayed as `PRI` if it cannot contain `NULL` values and there is no **PRIMARY KEY** in the table. A

**UNIQUE** index may display as **MUL** if several columns form a composite **UNIQUE** index; although the combination of the columns is unique, each column can still hold multiple occurrences of a given value.

The **Default** field indicates the default value that is assigned to the column.

The **Extra** field contains any additional information that is available about a given column. The value is **auto\_increment** if the column was created with the **AUTO\_INCREMENT** keyword and empty otherwise.

**Privileges** indicates the privileges you have for the column. This value is displayed only if you use the **FULL** keyword.

**Comment** indicates any comment the column has. This value is displayed only if you use the **FULL** keyword.

**SHOW FIELDS** is a synonym for **SHOW COLUMNS**. You can also list a table's columns with the `mysqlshow db_name tbl_name` command.

The **DESCRIBE** statement provides information similar to **SHOW COLUMNS**. See [Section 12.3.1, “DESCRIBE Syntax”](#).

The **SHOW CREATE TABLE**, **SHOW TABLE STATUS**, and **SHOW INDEX** statements also provide information about tables. See [Section 12.5.5, “SHOW Syntax”](#).

### 12.5.5.7. SHOW CONTRIBUTORS Syntax

```
SHOW CONTRIBUTORS
```

The **SHOW CONTRIBUTORS** statement displays information about the people who contribute to MySQL source or to causes that MySQL AB supports. For each contributor, it displays **Name**, **Location**, and **Comment** values.

This statement was added in MySQL 5.1.12.

### 12.5.5.8. SHOW CREATE DATABASE Syntax

```
SHOW CREATE {DATABASE | SCHEMA} db_name
```

Shows the **CREATE DATABASE** statement that creates the given database. **SHOW CREATE SCHEMA** is a synonym for **SHOW CREATE DATABASE**.

```
mysql> SHOW CREATE DATABASE test\G
***** 1. row *****
      Database: test
Create Database: CREATE DATABASE `test`
                  /*!40100 DEFAULT CHARACTER SET latin1 */

mysql> SHOW CREATE SCHEMA test\G
***** 1. row *****
      Database: test
Create Database: CREATE DATABASE `test`
                  /*!40100 DEFAULT CHARACTER SET latin1 */
```

**SHOW CREATE DATABASE** quotes table and column names according to the value of the `sql_quote_show_create` option. See [Section 5.1.4, “Session System Variables”](#).

### 12.5.5.9. SHOW CREATE EVENT Syntax

```
SHOW CREATE EVENT event_name
```

This statement displays the **CREATE EVENT** statement needed to re-create a given event. For example (using the same event **e\_daily** defined and then altered in [Section 12.5.5.19, “SHOW EVENTS Syntax”](#)):

```
mysql> SHOW CREATE EVENT test.e_daily\G
***** 1. row *****
      Event: e_daily
      sql_mode:
      time_zone: SYSTEM
Create Event: CREATE EVENT `e_daily`
              ON SCHEDULE EVERY 1 DAY
              STARTS CURRENT_TIMESTAMP + INTERVAL 6 HOUR
              ON COMPLETION NOT PRESERVE
              ENABLE
              COMMENT 'Saves total number of sessions then
                       clears the table each day'
              DO BEGIN
                INSERT INTO site_activity.totals (time, total)
                SELECT CURRENT_TIMESTAMP, COUNT(*)
                FROM site_activity.sessions;
                DELETE FROM site_activity.sessions;
              END
character_set_client: latin1
```

```
collation_connection: latin1_swedish_ci
Database Collation: latin1_swedish_ci
```

`character_set_client` is the session value of the `character_set_client` system variable when the event was created. `collation_connection` is the session value of the `collation_connection` system variable when the event was created. `Database Collation` is the collation of the database with which the event is associated. These columns were added in MySQL 5.1.21.

Note that the output reflects the current status of the event (`ENABLE`) rather than the status with which it was created.

This statement was implemented in MySQL 5.1.6.

### 12.5.5.10. SHOW CREATE FUNCTION Syntax

```
SHOW CREATE FUNCTION func_name
```

This statement is similar to `SHOW CREATE PROCEDURE` but for stored functions. See [Section 12.5.5.11, “SHOW CREATE PROCEDURE Syntax”](#).

### 12.5.5.11. SHOW CREATE PROCEDURE Syntax

```
SHOW CREATE PROCEDURE proc_name
```

This statement is a MySQL extension. It returns the exact string that can be used to re-create the named stored procedure. A similar statement, `SHOW CREATE FUNCTION`, displays information about stored functions (see [Section 12.5.5.10, “SHOW CREATE FUNCTION Syntax”](#)).

Both statements require that you be the owner of the routine or have `SELECT` access to the `mysql.proc` table. If you do not have privileges for the routine itself, the value displayed for the `Create Procedure` or `Create Function` field will be `NULL`.

```
mysql> SHOW CREATE PROCEDURE test.simpleproc\G
***** 1. row *****
      Procedure: simpleproc
      sql_mode:
      Create Procedure: CREATE PROCEDURE `simpleproc` (OUT param1 INT)
                        BEGIN
                        SELECT COUNT(*) INTO param1 FROM t;
                        END
character_set_client: latin1
collation_connection: latin1_swedish_ci
Database Collation: latin1_swedish_ci

mysql> SHOW CREATE FUNCTION test.hello\G
***** 1. row *****
      Function: hello
      sql_mode:
      Create Function: CREATE FUNCTION `hello` (s CHAR(20))
                       RETURNS CHAR(50)
                       RETURN CONCAT('Hello, ',s, '!')
character_set_client: latin1
collation_connection: latin1_swedish_ci
Database Collation: latin1_swedish_ci
```

`character_set_client` is the session value of the `character_set_client` system variable when the routine was created. `collation_connection` is the session value of the `collation_connection` system variable when the routine was created. `Database Collation` is the collation of the database with which the routine is associated. These columns were added in MySQL 5.1.21.

### 12.5.5.12. SHOW CREATE TABLE Syntax

```
SHOW CREATE TABLE tbl_name
```

Shows the `CREATE TABLE` statement that creates the given table. The statement requires the `SELECT` privilege for the table. This statement also works with views.

```
mysql> SHOW CREATE TABLE t\G
***** 1. row *****
      Table: t
      Create Table: CREATE TABLE t (
        id INT(11) default NULL auto_increment,
        s char(60) default NULL,
        PRIMARY KEY (id)
      ) ENGINE=MyISAM
```



`SHOW CREATE TABLE` quotes table and column names according to the value of the `sql_quote_show_create` option. See Section 5.1.4, “Session System Variables”.

### 12.5.5.13. SHOW CREATE TRIGGER Syntax

```
SHOW CREATE TRIGGER trigger_name
```

This statement shows a `CREATE TRIGGER` statement that creates the given trigger.

```
mysql> SHOW CREATE TRIGGER ins_sum\G
***** 1. row *****
      Trigger: ins_sum
      sql_mode:
SQL Original Statement: CREATE DEFINER=`bob`@`localhost` TRIGGER ins_sum
                        BEFORE INSERT ON account
                        FOR EACH ROW SET @sum = @sum + NEW.amount
      character_set_client: latin1
      collation_connection: latin1_swedish_ci
      Database Collation: latin1_swedish_ci
```

This statement was added in MySQL 5.1.21.

You can also obtain information about trigger objects from `INFORMATION_SCHEMA`, which contains a `TRIGGERS` table. See Section 19.16, “The `INFORMATION_SCHEMA TRIGGERS` Table”.

### 12.5.5.14. SHOW CREATE VIEW Syntax

```
SHOW CREATE VIEW view_name
```

This statement shows a `CREATE VIEW` statement that creates the given view.

```
mysql> SHOW CREATE VIEW v\G
***** 1. row *****
      View: v
      Create View: CREATE ALGORITHM=UNDEFINED
                  DEFINER=`bob`@`localhost`
                  SQL SECURITY DEFINER VIEW
                  `v` AS select 1 AS `a`,2 AS `b`
      character_set_client: latin1
      collation_connection: latin1_swedish_ci
```

`character_set_client` is the session value of the `character_set_client` system variable when the routine was created. `collation_connection` is the session value of the `collation_connection` system variable when the routine was created. These columns were added in MySQL 5.1.21.

Use of `SHOW CREATE VIEW` requires the `SHOW VIEW` privilege and the `SELECT` privilege for the view in question.

You can also obtain information about view objects from `INFORMATION_SCHEMA`, which contains a `VIEWS` table. See Section 19.15, “The `INFORMATION_SCHEMA VIEWS` Table”.

MySQL lets you use different `sql_mode` settings to tell the server the type of SQL syntax to support. For example, you might use the `ANSI` SQL mode to ensure MySQL correctly interprets the standard SQL concatenation operator, the double bar (`||`), in your queries. If you then create a view that concatenates items, you might worry that changing the `sql_mode` setting to a value different from `ANSI` could cause the view to become invalid. But this is not the case. No matter how you write out a view definition, MySQL always stores it the same way, in a canonical form. Here is an example that shows how the server changes a double bar concatenation operator to a `CONCAT()` function:

```
mysql> SET sql_mode = 'ANSI';
Query OK, 0 rows affected (0.00 sec)

mysql> CREATE VIEW test.v AS SELECT 'a' || 'b' as coll;
Query OK, 0 rows affected (0.01 sec)

mysql> SHOW CREATE VIEW test.v\G
***** 1. row *****
      View: v
      Create View: CREATE VIEW "v" AS select concat('a','b') AS "coll"
      ...
1 row in set (0.00 sec)
```

The advantage of storing a view definition in canonical form is that changes made later to the value of `sql_mode` will not affect the results from the view. However an additional consequence is that comments prior to `SELECT` are stripped from the definition by the server.

### 12.5.5.15. SHOW DATABASES Syntax



```
SHOW {DATABASES | SCHEMAS}
     [LIKE 'pattern' | WHERE expr]
```

`SHOW DATABASES` lists the databases on the MySQL server host. `SHOW SCHEMAS` is a synonym for `SHOW DATABASES`. The `LIKE` clause, if present, indicates which database names to match. The `WHERE` clause can be given to select rows using more general conditions, as discussed in [Section 19.28, “Extensions to SHOW Statements”](#).

You see only those databases for which you have some kind of privilege, unless you have the global `SHOW DATABASES` privilege. You can also get this list using the `mysqlshow` command.

If the server was started with the `--skip-show-database` option, you cannot use this statement at all unless you have the `SHOW DATABASES` privilege.

`SHOW SCHEMAS` can also be used.

## 12.5.5.16. SHOW ENGINE Syntax

```
SHOW ENGINE engine_name {STATUS | MUTEX}
```

`SHOW ENGINE` displays operational information about a storage engine. The following statements currently are supported:

```
SHOW ENGINE INNODB STATUS
SHOW ENGINE INNODB MUTEX
SHOW ENGINE {NDB | NDBCLUSTER} STATUS
```

Older (and now deprecated) synonyms are `SHOW INNODB STATUS` for `SHOW ENGINE INNODB STATUS` and `SHOW MUTEX STATUS` for `SHOW ENGINE INNODB MUTEX`.

In MySQL 5.0, `SHOW ENGINE INNODB MUTEX` is invoked as `SHOW MUTEX STATUS`. The latter statement displays similar information but in a somewhat different output format.

`SHOW ENGINE BDB LOGS` formerly displayed status information about `BDB` log files. As of MySQL 5.1.12, the `BDB` storage engine is not supported, and this statement produces a warning.

`SHOW ENGINE INNODB STATUS` displays extensive information from the standard `InnoDB` Monitor about the state of the `InnoDB` storage engine. For information about the standard monitor and other `InnoDB` Monitors that provide information about `InnoDB` processing, see [Section 13.6.13.2, “SHOW ENGINE INNODB STATUS and the InnoDB Monitors”](#).

`SHOW ENGINE INNODB MUTEX` displays `InnoDB` mutex statistics. From MySQL 5.1.2 to 5.1.14, the statement displays the following output fields:

- **Type**

Always `InnoDB`.

- **Name**

The mutex name and the source file where it is implemented. Example: `&pool->mutex:mem0pool.c`

The mutex name indicates its purpose. For example, the `log_sys` mutex is used by the `InnoDB` logging subsystem and indicates how intensive logging activity is. The `buf_pool` mutex protects the `InnoDB` buffer pool.

- **Status**

The mutex status. The fields contains several values:

- `count` indicates how many times the mutex was requested.
- `spin_waits` indicates how many times the spinlock had to run.
- `spin_rounds` indicates the number of spinlock rounds. (`spin_rounds` divided by `spin_waits` provides the average round count.)
- `os_waits` indicates the number of operating system waits. This occurs when the spinlock did not work (the mutex was not locked during the spinlock and it was necessary to yield to the operating system and wait).
- `os_yields` indicates the number of times a the thread trying to lock a mutex gave up its timeslice and yielded to the operating system (on the presumption that allowing other threads to run will free the mutex so that it can be locked).
- `os_wait_times` indicates the amount of time (in ms) spent in operating system waits, if the `timed_mutexes` system

variable is 1 (ON). If `timed_mutexes` is 0 (OFF), timing is disabled, so `os_wait_times` is 0. `timed_mutexes` is off by default.

From MySQL 5.1.15 on, the statement displays the following output fields:

- **Type**

Always `InnoDB`.

- **Name**

The source file where the mutex is implemented, and the line number in the file where the mutex is created. The line number may change depending on your version of MySQL.

- **Status**

This field displays the same values as previously described (`count`, `spin_waits`, `spin_rounds`, `os_waits`, `os_yields`, `os_wait_times`), but only if `UNIV_DEBUG` was defined at MySQL compilation time (for example, in `include/univ.h` in the `InnoDB` part of the MySQL source tree). If `UNIV_DEBUG` was not defined, the statement displays only the `os_waits` value. In the latter case (without `UNIV_DEBUG`), the information on which the output is based is insufficient to distinguish regular mutexes and mutexes that protect rw-locks (which allow multiple readers or a single writer). Consequently, the output may appear to contain multiple rows for the same mutex.

Information from this statement can be used to diagnose system problems. For example, large values of `spin_waits` and `spin_rounds` may indicate scalability problems.

If the server has the `NDBCLUSTER` storage engine enabled, `SHOW ENGINE NDB STATUS` displays cluster status information such as the number of connected data nodes, the cluster connectstring, and cluster binlog epochs, as well as counts of various Cluster API objects created by the MySQL Server when connected to the cluster. Sample output from this statement is shown here:

```
mysql> SHOW ENGINE NDB STATUS;
+-----+-----+-----+
| Type      | Name                                     | Status                                     |
+-----+-----+-----+
| ndbcluster | connection                             | cluster_node_id=7,                       |
|            | connected_host=192.168.0.103,          | connected_port=1186, number_of_data_nodes=4, |
|            | number_of_ready_data_nodes=3,         | connect_count=0                           |
|            | NdbTransaction                         | created=6, free=0, sizeof=212             |
|            | NdbOperation                           | created=8, free=8, sizeof=660             |
|            | NdbIndexScanOperation                  | created=1, free=1, sizeof=744             |
|            | NdbIndexOperation                      | created=0, free=0, sizeof=664             |
|            | NdbRecAttr                             | created=1285, free=1285, sizeof=60        |
|            | NdbApiSignal                           | created=16, free=16, sizeof=136           |
|            | NdbLabel                                | created=0, free=0, sizeof=196             |
|            | NdbBranch                              | created=0, free=0, sizeof=24              |
|            | NdbSubroutine                          | created=0, free=0, sizeof=68              |
|            | NdbCall                                 | created=0, free=0, sizeof=16              |
|            | NdbBlob                                 | created=1, free=1, sizeof=264             |
|            | NdbReceiver                            | created=4, free=0, sizeof=68              |
|            | binlog                                 | latest_epoch=155467, latest_trans_epoch=148126, |
|            | latest_received_binlog_epoch=0,       | latest_handled_binlog_epoch=0,           |
|            | latest_applied_binlog_epoch=0         |
+-----+-----+-----+
```

The rows with `connection` and `binlog` in the `Name` column were added to the output of this statement in MySQL 5.1. The `Status` column in each of these rows provides information about the MySQL server's connection to the cluster and about the cluster binary log's status, respectively. The `Status` information is in the form of comma-delimited set of name/value pairs.

The `connection` row's `Status` column contains the name/value pairs described in the following table.

Name	Value
<code>cluster_node_id</code>	The node ID of the MySQL server in the cluster
<code>connected_host</code>	The host name or IP address of the cluster management server to which the MySQL server is connected
<code>connected_port</code>	The port used by the MySQL server to connect to the management server ( <code>connected_host</code> )
<code>number_of_data_nodes</code>	The number of data nodes configured for the cluster (that is, the number of <code>[ndbd]</code> sections in the cluster <code>config.ini</code> file)
<code>number_of_ready_data_nodes</code>	The number of data nodes in the cluster that are actually running
<code>connect_count</code>	The number of times this <code>mysqld</code> has connected or reconnected to cluster

	data nodes
--	------------

The `binlog` row's `Status` column contains information relating to MySQL Cluster Replication. The name/value pairs it contains are described in the following table.

Name	Value
<code>latest_epoch</code>	The most recent epoch most recently run on this MySQL server (that is, the sequence number of the most recent transaction run on the server)
<code>latest_trans_epoch</code>	The most recent epoch processed by the cluster's data nodes
<code>latest_received_binlog_epoch</code>	The most recent epoch received by the binlog thread
<code>latest_handled_binlog_epoch</code>	The most recent epoch processed by the binlog thread (for writing to the binlog)
<code>latest_applied_binlog_epoch</code>	The most recent epoch actually written to the binlog

See [MySQL Cluster Replication](#), for more information.

The remaining rows from the output of `SHOW ENGINE NDB STATUS` which are most likely to prove useful in monitoring the cluster are listed here by `Name`:

- `NdbTransaction`: The number and size of `NdbTransaction` objects that have been created. An `NdbTransaction` is created each time a table schema operation (such as `CREATE TABLE` or `ALTER TABLE`) is performed on an `NDB` table.
- `NdbOperation`: The number and size of `NdbOperation` objects that have been created.
- `NdbIndexScanOperation`: The number and size of `NdbIndexScanOperation` objects that have been created.
- `NdbIndexOperation`: The number and size of `NdbIndexOperation` objects that have been created.
- `NdbRecAttr`: The number and size of `NdbRecAttr` objects that have been created. In general, one of these is created each time a data manipulation statement is performed by an SQL node.
- `NdbBlob`: The number and size of `NdbBlob` objects that have been created. An `NdbBlob` is created for each new operation involving a `BLOB` column in an `NDB` table.
- `NdbReceiver`: The number and size of any `NdbReceiver` object that have been created. The number in the `created` column is the same as the number of data nodes in the cluster to which the MySQL server has connected.

#### Note

`SHOW ENGINE NDB STATUS` returns an empty result if no operations involving `NDB` tables have been performed during the current session by the MySQL client accessing the SQL node on which this statement is run.

#### MySQL Enterprise

The `SHOW ENGINE engine_name STATUS` statement provides valuable information about the state of your server. For expert interpretation of this information, subscribe to the MySQL Enterprise Monitor. For more information, see <http://www.mysql.com/products/enterprise/advisors.html>.

## 12.5.5.17. SHOW ENGINES Syntax

```
SHOW [STORAGE] ENGINES
```

`SHOW ENGINES` displays status information about the server's storage engines. This is particularly useful for checking whether a storage engine is supported, or to see what the default engine is. `SHOW TABLE TYPES` is a deprecated synonym.

```
mysql> SHOW ENGINES\G
***** 1. row *****
Engine: MEMORY
Support: YES
Comment: Hash based, stored in memory, useful for temporary tables
Transactions: NO
XA: NO
Savepoints: NO
***** 2. row *****
Engine: MyISAM
Support: DEFAULT
Comment: Default engine as of MySQL 3.23 with great performance
Transactions: NO
```

```

      XA: NO
      Savepoints: NO
***** 3. row *****
      Engine: InnoDB
      Support: YES
      Comment: Supports transactions, row-level locking, and foreign keys
      Transactions: YES
      XA: YES
      Savepoints: YES
***** 4. row *****
      Engine: EXAMPLE
      Support: YES
      Comment: Example storage engine
      Transactions: NO
      XA: NO
      Savepoints: NO
***** 5. row *****
      Engine: ARCHIVE
      Support: YES
      Comment: Archive storage engine
      Transactions: NO
      XA: NO
      Savepoints: NO
***** 6. row *****
      Engine: CSV
      Support: YES
      Comment: CSV storage engine
      Transactions: NO
      XA: NO
      Savepoints: NO
***** 7. row *****
      Engine: BLACKHOLE
      Support: YES
      Comment: /dev/null storage engine (anything you write »
              to it disappears)
      Transactions: NO
      XA: NO
      Savepoints: NO
***** 8. row *****
      Engine: FEDERATED
      Support: YES
      Comment: Federated MySQL storage engine
      Transactions: NO
      XA: NO
      Savepoints: NO
***** 9. row *****
      Engine: MRG_MYISAM
      Support: YES
      Comment: Collection of identical MyISAM tables
      Transactions: NO
      XA: NO
      Savepoints: NO

```

The output from `SHOW ENGINES` may vary according to the MySQL version used and other factors. The values shown in the `Support` column indicate the server's level of support for the storage engine, as shown in the following table.

Value	Meaning
YES	The engine is supported and is active
DEFAULT	Like YES, plus this is the default engine
NO	The engine is not supported
DISABLED	The engine is supported but has been disabled

A value of `NO` means that the server was compiled without support for the engine, so it cannot be activated at runtime.

A value of `DISABLED` occurs either because the server was started with an option that disables the engine, or because not all options required to enable it were given. In the latter case, the error log file should contain a reason indicating why the option is disabled. See [Section 5.2.2, “The Error Log”](#).

You might also see `DISABLED` for a storage engine if the server was compiled to support it, but was started with a `--skip-engine_name` option. For the `NDBCLUSTER` storage engine, `DISABLED` means the server was compiled with support for MySQL Cluster, but was not started with the `--ndbcluster` option.

All MySQL servers support `MyISAM` tables, because `MyISAM` is the default storage engine. It is not possible to disable `MyISAM`.

The `Transactions`, `XA`, and `Savepoints` columns were added in MySQL 5.1.2. They indicate whether the storage engine supports transactions, XA transactions, and savepoints, respectively.

## 12.5.5.18. SHOW ERRORS Syntax

```

SHOW ERRORS [LIMIT [offset,] row_count]
SHOW COUNT(*) ERRORS

```

This statement is similar to `SHOW WARNINGS`, except that instead of displaying errors, warnings, and notes, it displays only errors.

The `LIMIT` clause has the same syntax as for the `SELECT` statement. See [Section 12.2.8, “SELECT Syntax”](#).

The `SHOW COUNT(*) ERRORS` statement displays the number of errors. You can also retrieve this number from the `error_count` variable:

```
SHOW COUNT(*) ERRORS;
SELECT @@error_count;
```

For more information, see [Section 12.5.5.42, “SHOW WARNINGS Syntax”](#).

## 12.5.5.19. SHOW EVENTS Syntax

```
SHOW EVENTS [{FROM | IN} schema_name]
[LIKE 'pattern' | WHERE expr]
```

In its simplest form, `SHOW EVENTS` lists all of the events in the current schema:

```
mysql> SELECT CURRENT_USER(), SCHEMA();
+-----+-----+
| CURRENT_USER() | SCHEMA() |
+-----+-----+
| jon@ghidora   | myschema |
+-----+-----+
1 row in set (0.00 sec)

mysql> SHOW EVENTS\G
***** 1. row *****
      Db: myschema
      Name: e_daily
      Definer: jon@ghidora
      Time zone: SYSTEM
      Type: RECURRING
      Execute at: NULL
      Interval value: 10
      Interval field: SECOND
      Starts: 2006-02-09 10:41:23
      Ends: 0000-00-00 00:00:00
      Status: ENABLED
      Originator: 0
character_set_client: latin1
collation_connection: latin1_swedish_ci
Database Collation: latin1_swedish_ci
```

The `LIKE` clause, if present, indicates which event names to match. The `WHERE` clause can be given to select rows using more general conditions, as discussed in [Section 19.28, “Extensions to SHOW Statements”](#).

The columns in the output of `SHOW EVENTS` — which are similar to, but not identical to the columns in the `INFORMATION_SCHEMA.EVENTS` table — are shown here:

- **Db:** The schema (database) on which the event is defined.
- **Name:** The name of the event.
- **Time zone:** The time zone in effect when schedule for the event was last modified. If the event's schedule has not been modified since the event was created, then this is the time zone that was in effect at the event's creation. The default value is `SYSTEM`.

This column was added in MySQL 5.1.17. See [Section C.2.21, “Changes in MySQL 5.1.17 \(04 April 2007\)”](#), for important information if you are using the Event Scheduler and are upgrading from MySQL 5.1.16 (or earlier) to MySQL 5.1.17 (or later).

- **Definer:** The user account (`user_name@host_name`) which created the event.
- **Type:** One of the two values `ONE TIME` (transient) or `RECURRING`.
- **Execute At:** The date and time when a transient event is set to execute. Shown as a `DATETIME` value.

For a recurring event, the value of this column is always `NULL`.

- **Interval Value:** For a recurring event, the number of intervals to wait between event executions.

For a transient event, the value of this column is always `NULL`.

- **Interval Field:** The time units used for the interval which a recurring event waits before repeating.

For a transient event, the value of this column is always `NULL`.

- **Starts:** The start date and time for a recurring event. This is displayed as a `DATETIME` value, and is empty if no start date and time are defined for the event. (Prior to MySQL 5.1.8, it defaulted to `'0000-00-00 00:00:00'` in such cases.)

For a transient event, the value of this column is always `NULL`.

- **Ends:** The end date and time for a recurring event. This is displayed as a `DATETIME` value, and defaults to `'0000-00-00 00:00:00'` if no end date and time is defined for the event.

For a transient event, the value of this column is always `NULL`.

- **Status:** The event status. One of `ENABLED`, `DISABLED`, or `SLAVESIDE_DISABLED`.

`SLAVESIDE_DISABLED` was added in MySQL 5.1.18. This value indicates that the creation of the event occurred on another MySQL server acting as a replication master and replicated to the current MySQL server which is acting as a slave, but the event is not presently being executed on the slave.

- **Originator:** The server ID of the MySQL server on which the event was created. Defaults to 0. This column was added in MySQL 5.1.18.
- `character_set_client` is the session value of the `character_set_client` system variable when the routine was created. `collation_connection` is the session value of the `collation_connection` system variable when the routine was created. `Database Collation` is the collation of the database with which the routine is associated. These columns were added in MySQL 5.1.21.

For more information about `SLAVE_DISABLED` and the `Originator` column, see [Section 16.3.1.7, “Replication of Invoked Features”](#).

Note that the action statement is not shown in the output of `SHOW EVENTS`.

Prior to MySQL 5.1.17, the values displayed for `Starts` and `Ends` (other than `'0000-00-00 00:00:00'`) were shown using Universal Time ([Bug#16420](#)). Beginning with MySQL 5.1.17, these times are all given in terms of local time as determined by the MySQL server's `time_zone` setting. See also [Section 19.20, “The INFORMATION\\_SCHEMA EVENTS Table”](#).

To see events for a different schema, you can use the `FROM` clause. For example, if the `test` schema had been selected in the preceding example, you could view events defined on `myschema` using the following statement:

```
SHOW EVENTS FROM myschema;
```

You can filter the list returned by this statement on the event name using `LIKE` plus a pattern.

This statement was added in MySQL 5.1.6.

See also [Section 19.20, “The INFORMATION\\_SCHEMA EVENTS Table”](#).

### Note

In MySQL 5.1.11 and earlier, `SHOW EVENTS` displayed only those events for which the current user was the definer, and the `SHOW FULL EVENTS` statement was used for viewing events defined by all users on a given schema. `SHOW FULL EVENTS` was removed in MySQL 5.1.12.

## 12.5.5.20. SHOW FUNCTION CODE Syntax

```
SHOW FUNCTION CODE func_name
```

This statement is similar to `SHOW PROCEDURE CODE` but for stored functions. See [Section 12.5.5.29, “SHOW PROCEDURE CODE Syntax”](#).

## 12.5.5.21. SHOW FUNCTION STATUS Syntax

```
SHOW FUNCTION STATUS
[LIKE 'pattern' | WHERE expr]
```

This statement is similar to `SHOW PROCEDURE STATUS` but for stored functions. See [Section 12.5.5.30, “SHOW PROCEDURE STATUS Syntax”](#).

## 12.5.5.22. SHOW GRANTS Syntax

```
SHOW GRANTS [FOR user]
```

This statement lists the `GRANT` statement or statements that must be issued to duplicate the privileges that are granted to a MySQL user account. The account is named using the same format as for the `GRANT` statement; for example, `'jef-frey'@'localhost'`. If you specify only the user name part of the account name, a host name part of `'%'` is used. For additional information about specifying account names, see [Section 12.5.1.3, “GRANT Syntax”](#).

```
mysql> SHOW GRANTS FOR 'root'@'localhost';
+-----+
| Grants for root@localhost                                     |
+-----+
| GRANT ALL PRIVILEGES ON *.* TO 'root'@'localhost' WITH GRANT OPTION |
+-----+
```

To list the privileges granted to the account that you are using to connect to the server, you can use any of the following statements:

```
SHOW GRANTS;
SHOW GRANTS FOR CURRENT_USER;
SHOW GRANTS FOR CURRENT_USER();
```

As of MySQL 5.1.12, if `SHOW GRANTS FOR CURRENT_USER` (or any of the equivalent syntaxes) is used in `DEFINER` context, such as within a stored procedure that is defined with `SQL SECURITY DEFINER`, the grants displayed are those of the definer and not the invoker.

`SHOW GRANTS` displays only the privileges granted explicitly to the named account. Other privileges might be available to the account, but they are not displayed. For example, if an anonymous account exists, the named account might be able to use its privileges, but `SHOW GRANTS` will not display them.

`SHOW GRANTS` requires the `SELECT` privilege for the `mysql` database.

## 12.5.5.23. SHOW INDEX Syntax

```
SHOW {INDEX | INDEXES | KEYS}
  {FROM | IN} tbl_name
  [{FROM | IN} db_name]
```

`SHOW INDEX` returns table index information. The format resembles that of the `SQLStatistics` call in ODBC.

`SHOW INDEX` returns the following fields:

- `Table`  
The name of the table.
- `Non_unique`  
0 if the index cannot contain duplicates, 1 if it can.
- `Key_name`  
The name of the index.
- `Seq_in_index`  
The column sequence number in the index, starting with 1.
- `Column_name`  
The column name.
- `Collation`  
How the column is sorted in the index. In MySQL, this can have values “A” (Ascending) or `NULL` (Not sorted).
- `Cardinality`  
An estimate of the number of unique values in the index. This is updated by running `ANALYZE TABLE` or `myisamchk -a`. `Cardinality` is counted based on statistics stored as integers, so the value is not necessarily exact even for small tables. The

higher the cardinality, the greater the chance that MySQL uses the index when doing joins.

- `Sub_part`

The number of indexed characters if the column is only partly indexed, `NULL` if the entire column is indexed.

- `Packed`

Indicates how the key is packed. `NULL` if it is not.

- `Null`

Contains `YES` if the column may contain `NULL`. If not, the column contains `NO`.

Contains `YES` if the column may contain `NULL` values and `' '` if not.

- `Index_type`

The index method used (`BTREE`, `FULLTEXT`, `HASH`, `RTREE`).

- `Comment`

Various remarks.

You can use `db_name.tbl_name` as an alternative to the `tbl_name FROM db_name` syntax. These two statements are equivalent:

```
SHOW INDEX FROM mytable FROM mydb;
SHOW INDEX FROM mydb.mytable;
```

You can also list a table's indexes with the `mysqlshow -k db_name tbl_name` command.

#### 12.5.5.24. SHOW INNODB STATUS Syntax

```
SHOW INNODB STATUS
```

In MySQL 5.1, this is a deprecated synonym for `SHOW ENGINE INNODB STATUS`. See [Section 12.5.5.16, “SHOW ENGINE Syntax”](#).

#### 12.5.5.25. SHOW MASTER STATUS Syntax

```
SHOW MASTER STATUS
```

Provides status information about the binary log files of the master. Example:

```
mysql> SHOW MASTER STATUS;
+-----+-----+-----+-----+
| File           | Position | Binlog_Do_DB | Binlog_Ignore_DB |
+-----+-----+-----+-----+
| mysql-bin.003 | 73       | test         | manual,mysql      |
+-----+-----+-----+-----+
```

#### 12.5.5.26. SHOW OPEN TABLES Syntax

```
SHOW OPEN TABLES [{FROM | IN} db_name]
[LIKE 'pattern' | WHERE expr]
```

`SHOW OPEN TABLES` lists the non-`TEMPORARY` tables that are currently open in the table cache. See [Section 7.4.7, “How MySQL Opens and Closes Tables”](#). The `WHERE` clause can be given to select rows using more general conditions, as discussed in [Section 19.28, “Extensions to SHOW Statements”](#).

The `FROM` and `LIKE` clauses may be used beginning with MySQL 5.1.24. The `LIKE` clause, if present, indicates which table names to match. The `FROM` clause, if present, restricts the tables shown to those present in the `db_name` database.

`SHOW OPEN TABLES` returns the following columns:

- `Database`



The database containing the table.

- `Table`

The table name.

- `In_use`

The number of table locks or lock requests there are for the table. For example, if one client acquires a lock for a table using `LOCK TABLE t1 WRITE`, `In_use` will be 1. If another client issues `LOCK TABLE t1 WRITE` while the table remains locked, the client will block waiting for the lock, but the lock request causes `In_use` to be 2. If the count is zero, the table is open but not currently being used. `In_use` is also increased by the `HANDLER ... OPEN` statement and decreased by `HANDLER ... CLOSE`.

- `Name_locked`

Whether the table name is locked. Name locking is used for operations such as dropping or renaming tables.

### 12.5.5.27. SHOW PLUGINS Syntax

SHOW PLUGINS

`SHOW PLUGINS` displays information about known plugins.

```
mysql> SHOW PLUGINS;
+-----+-----+-----+-----+
| Name           | Status | Type           | Library |
+-----+-----+-----+-----+
| MEMORY         | ACTIVE | STORAGE ENGINE | NULL    |
| MyISAM         | ACTIVE | STORAGE ENGINE | NULL    |
| InnoDB        | ACTIVE | STORAGE ENGINE | NULL    |
| ARCHIVE        | ACTIVE | STORAGE ENGINE | NULL    |
| CSV            | ACTIVE | STORAGE ENGINE | NULL    |
| BLACKHOLE      | ACTIVE | STORAGE ENGINE | NULL    |
| FEDERATED      | ACTIVE | STORAGE ENGINE | NULL    |
| MRG_MYISAM     | ACTIVE | STORAGE ENGINE | NULL    |
+-----+-----+-----+-----+
```

`SHOW PLUGIN` was added in MySQL 5.1.5 and renamed to `SHOW PLUGINS` in 5.1.9. (As of 5.1.9, `SHOW PLUGIN` is deprecated and generates a warning.)

### 12.5.5.28. SHOW PRIVILEGES Syntax

SHOW PRIVILEGES

`SHOW PRIVILEGES` shows the list of system privileges that the MySQL server supports. The exact list of privileges depends on the version of your server.

```
mysql> SHOW PRIVILEGES\G
***** 1. row *****
Privilege: Alter
Context: Tables
Comment: To alter the table
***** 2. row *****
Privilege: Alter routine
Context: Functions,Procedures
Comment: To alter or drop stored functions/procedures
***** 3. row *****
Privilege: Create
Context: Databases,Tables,Indexes
Comment: To create new databases and tables
***** 4. row *****
Privilege: Create routine
Context: Functions,Procedures
Comment: To use CREATE FUNCTION/PROCEDURE
***** 5. row *****
Privilege: Create temporary tables
Context: Databases
Comment: To use CREATE TEMPORARY TABLE
...

```

Privileges belonging to a specific user are displayed by the `SHOW GRANTS` statement. See [Section 12.5.5.22, “SHOW GRANTS Syntax”](#), for more information.

### 12.5.5.29. SHOW PROCEDURE CODE Syntax

```
SHOW PROCEDURE CODE proc_name
```

This statement is a MySQL extension that is available only for servers that have been built with debugging support. It displays a representation of the internal implementation of the named stored procedure. A similar statement, `SHOW FUNCTION CODE`, displays information about stored functions (see [Section 12.5.5.20](#), “`SHOW FUNCTION CODE Syntax`”).

Both statements require that you be the owner of the routine or have `SELECT` access to the `mysql.proc` table.

If the named routine is available, each statement produces a result set. Each row in the result set corresponds to one “instruction” in the routine. The first column is `Pos`, which is an ordinal number beginning with 0. The second column is `Instruction`, which contains an SQL statement (usually changed from the original source), or a directive which has meaning only to the stored-routine handler.

```
mysql> DELIMITER //
mysql> CREATE PROCEDURE p1 ()
-> BEGIN
->   DECLARE fanta INT DEFAULT 55;
->   DROP TABLE t2;
->   LOOP
->     INSERT INTO t3 VALUES (fanta);
->   END LOOP;
-> END//
Query OK, 0 rows affected (0.00 sec)

mysql> SHOW PROCEDURE CODE p1//
+-----+-----+
| Pos | Instruction |
+-----+-----+
| 0   | set fanta@0 55 |
| 1   | stmt 9 "DROP TABLE t2" |
| 2   | stmt 5 "INSERT INTO t3 VALUES (fanta)" |
| 3   | jump 2 |
+-----+-----+
4 rows in set (0.00 sec)
```

In this example, the non-executable `BEGIN` and `END` statements have disappeared, and for the `DECLARE variable_name` statement, only the executable part appears (the part where the default is assigned). For each statement that is taken from source, there is a code word `stmt` followed by a type (9 means `DROP`, 5 means `INSERT`, and so on). The final row contains an instruction `jump 2`, meaning `GOTO instruction #2`.

These statements were added in MySQL 5.1.3.

### 12.5.5.30. SHOW PROCEDURE STATUS Syntax

```
SHOW PROCEDURE STATUS
[LIKE 'pattern' | WHERE expr]
```

This statement is a MySQL extension. It returns characteristics of a stored procedure, such as the database, name, type, creator, creation and modification dates, and character set information. A similar statement, `SHOW FUNCTION STATUS`, displays information about stored functions (see [Section 12.5.5.21](#), “`SHOW FUNCTION STATUS Syntax`”).

The `LIKE` clause, if present, indicates which procedure or function names to match. The `WHERE` clause can be given to select rows using more general conditions, as discussed in [Section 19.28](#), “`Extensions to SHOW Statements`”.

```
mysql> SHOW PROCEDURE STATUS LIKE 'spl' \G
***** 1. row *****
      Db: test
      Name: spl
      Type: PROCEDURE
      Definer: testuser@localhost
      Modified: 2004-08-03 15:29:37
      Created: 2004-08-03 15:29:37
      Security_type: DEFINER
      Comment:
character_set_client: latin1
collation_connection: latin1_swedish_ci
  Database Collation: latin1_swedish_ci
```

`character_set_client` is the session value of the `character_set_client` system variable when the routine was created. `collation_connection` is the session value of the `collation_connection` system variable when the routine was created. `Database Collation` is the collation of the database with which the routine is associated. These columns were added in MySQL 5.1.21.

You can also get information about stored routines from the `ROUTINES` table in `INFORMATION_SCHEMA`. See [Section 19.14](#), “`The INFORMATION_SCHEMA ROUTINES Table`”.

### 12.5.5.31. SHOW PROCESSLIST Syntax

```
SHOW [FULL] PROCESSLIST
```

`SHOW PROCESSLIST` shows you which threads are running. You can also get this information from the `INFORMATION_SCHEMA.PROCESSLIST` table or the `mysqladmin processlist` command. If you have the `PROCESS` privilege, you can see all threads. Otherwise, you can see only your own threads (that is, threads associated with the MySQL account that you are using). If you do not use the `FULL` keyword, only the first 100 characters of each statement are shown in the `Info` field.

### MySQL Enterprise

Subscribers to MySQL Enterprise Monitor receive instant notification and expert advice on resolution when there are too many concurrent processes. For more information, see <http://www.mysql.com/products/enterprise/advisors.html>.

This statement is very useful if you get the “too many connections” error message and want to find out what is going on. MySQL reserves one extra connection to be used by accounts that have the `SUPER` privilege, to ensure that administrators should always be able to connect and check the system (assuming that you are not giving this privilege to all your users).

Threads can be killed with the `KILL` statement. See [Section 12.5.6.4, “KILL Syntax”](#).

Here is an example of what `SHOW PROCESSLIST` output looks like:

```
mysql> SHOW FULL PROCESSLIST\G
***** 1. row *****
Id: 1
User: system user
Host:
db: NULL
Command: Connect
Time: 1030455
State: Waiting for master to send event
Info: NULL
***** 2. row *****
Id: 2
User: system user
Host:
db: NULL
Command: Connect
Time: 1004
State: Has read all relay log; waiting for the slave
      I/O thread to update it
Info: NULL
***** 3. row *****
Id: 3112
User: replikator
Host: artemis:2204
db: NULL
Command: Binlog Dump
Time: 2144
State: Has sent all binlog to slave; waiting for binlog to be updated
Info: NULL
***** 4. row *****
Id: 3113
User: replikator
Host: iconnect2:45781
db: NULL
Command: Binlog Dump
Time: 2086
State: Has sent all binlog to slave; waiting for binlog to be updated
Info: NULL
***** 5. row *****
Id: 3123
User: stefan
Host: localhost
db: apollon
Command: Query
Time: 0
State: NULL
Info: SHOW FULL PROCESSLIST
5 rows in set (0.00 sec)
```

The columns have the following meaning:

- `Id`  
The connection identifier.
- `User`

The MySQL user who issued the statement. If this is `system user`, it refers to a non-client thread spawned by the server to handle tasks internally. This could be the I/O or SQL thread used on replication slaves or a delayed-row handler. `unauthenticated user` refers to a thread that has become associated with a client connection but for which authentication of the client user has not yet been done. `event_scheduler` refers to the thread that monitors scheduled events. For `system`

`user` or `event_scheduler`, there is no host specified in the `Host` column.

- `Host`

The host name of the client issuing the statement (except for `system user` where there is no host). `SHOW PROCESSLIST` reports the host name for TCP/IP connections in `host_name:client_port` format to make it easier to determine which client is doing what.

- `db`

The default database, if one is selected, otherwise `NULL`.

- `Command`

The type of command the thread is executing. Descriptions for thread commands can be found at [Section 7.5.6, “Examining Thread Information”](#). The value of this column corresponds to the `COM_xxx` commands of the client/server protocol. See [Section 5.1.6, “Server Status Variables”](#)

- `Time`

The time in seconds that the thread has been in its current state.

- `State`

An action, event, or state that indicates what the thread is doing. Descriptions for `State` values can be found at [Section 7.5.6, “Examining Thread Information”](#).

Most states correspond to very quick operations. If a thread stays in a given state for many seconds, there might be a problem that needs to be investigated.

For the `SHOW PROCESSLIST` statement, the value of `State` is `NULL`.

- `Info`

The statement that the thread is executing, or `NULL` if it is not executing any statement. The statement might be the one sent to the server, or an innermost statement if the statement executes other statements. For example, if a `CALL p1()` statement executes a stored procedure `p1()`, and the procedure is executing a `SELECT` statement, the `Info` value shows the `SELECT` statement.

### 12.5.5.32. SHOW PROFILE Syntax

```
SHOW PROFILES
```

The `SHOW PROFILE` statement display profiling information that indicates resource usage for statements executed during the course of the current session. It is used together with `SHOW PROFILES`; see [Section 12.5.5.33, “SHOW PROFILES Syntax”](#).

### 12.5.5.33. SHOW PROFILES Syntax

```
SHOW PROFILE [type [, type] ... ]
             [FOR QUERY n]
             [LIMIT row_count [OFFSET offset]]
```

```
type:
  ALL
  BLOCK IO
  CONTEXT SWITCHES
  CPU
  IPC
  MEMORY
  PAGE FAULTS
  SOURCE
  SWAPS
```

The `SHOW PROFILES` and `SHOW PROFILE` statements display profiling information that indicates resource usage for statements executed during the course of the current session.

Profiling is controlled by the `profiling` session variable, which has a default value of 0 (`OFF`). Profiling is enabled by setting `profiling` to 1 or `ON`:

```
mysql> SET profiling = 1;
```

`SHOW PROFILES` displays a list of the most recent statements sent to the master. The size of the list is controlled by the `pro-`

`filing_history_size` session variable, which has a default value of 15. The maximum value is 100. Setting the value to 0 has the practical effect of disabling profiling.

All statements are profiled except `SHOW PROFILES` and `SHOW PROFILE`, so you will find neither of those statements in the profile list. Malformed statements are profiled. For example, `SHOW PROFILING` is an illegal statement, and a syntax error occurs if you try to execute it, but it will show up in the profiling list.

`SHOW PROFILE` displays detailed information about a single statement. Without the `FOR QUERY n` clause, the output pertains to the most recently executed statement. If `FOR QUERY n` is included, `SHOW PROFILE` displays information for statement `n`. The values of `n` correspond to the `Query_ID` values displayed by `SHOW PROFILES`.

The `LIMIT row_count` clause may be given to limit the output to `row_count` rows. If `LIMIT` is given, `OFFSET offset` may be added to begin the output `offset` rows into the full set of rows.

By default, `SHOW PROFILE` displays `Status` and `Duration` columns. The `Status` values are like the `State` values displayed by `SHOW PROCESSLIST`, although there might be some minor differences in interpretation for the two statements for some status values (see [Section 7.5.6, “Examining Thread Information”](#)).

Optional `type` values may be specified to display specific additional types of information:

- `ALL` displays all information
- `BLOCK IO` displays counts for block input and output operations
- `CONTEXT SWITCHES` displays counts for voluntary and involuntary context switches
- `CPU` displays user and system CPU usage times
- `IPC` displays counts for messages sent and received
- `MEMORY` is not currently implemented
- `PAGE FAULTS` displays counts for major and minor page faults
- `SOURCE` displays the names of functions from the source code, together with the name and line number of the file in which the function occurs
- `SWAPS` displays swap counts

Profiling is enabled per session. When a session ends, its profiling information is lost.

```
mysql> SELECT @@profiling;
+-----+
| @@profiling |
+-----+
|           0 |
+-----+
1 row in set (0.00 sec)

mysql> SET profiling = 1;
Query OK, 0 rows affected (0.00 sec)

mysql> DROP TABLE IF EXISTS t1;
Query OK, 0 rows affected, 1 warning (0.00 sec)

mysql> CREATE TABLE T1 (id INT);
Query OK, 0 rows affected (0.01 sec)

mysql> SHOW PROFILES;
+-----+-----+-----+
| Query_ID | Duration | Query
+-----+-----+-----+
|         0 | 0.000088 | SET PROFILING = 1
|         1 | 0.000136 | DROP TABLE IF EXISTS t1
|         2 | 0.011947 | CREATE TABLE t1 (id INT)
+-----+-----+-----+
3 rows in set (0.00 sec)

mysql> SHOW PROFILE;
+-----+-----+
| Status | Duration |
+-----+-----+
| checking permissions | 0.000040 |
| creating table | 0.000056 |
| After create | 0.011363 |
| query end | 0.000375 |
| freeing items | 0.000089 |
| logging slow query | 0.000019 |
| cleaning up | 0.000005 |
+-----+-----+
7 rows in set (0.00 sec)
```

```
mysql> SHOW PROFILE FOR QUERY 1;
+-----+-----+
| Status          | Duration |
+-----+-----+
| query end       | 0.000107 |
| freeing items   | 0.000008 |
| logging slow query | 0.000015 |
| cleaning up     | 0.000006 |
+-----+-----+
4 rows in set (0.00 sec)

mysql> SHOW PROFILE CPU FOR QUERY 2;
+-----+-----+-----+-----+
| Status          | Duration | CPU_user | CPU_system |
+-----+-----+-----+-----+
| checking permissions | 0.000040 | 0.000038 | 0.000002 |
| creating table     | 0.000056 | 0.000028 | 0.000028 |
| After create      | 0.011363 | 0.000217 | 0.001571 |
| query end         | 0.000375 | 0.000013 | 0.000028 |
| freeing items     | 0.000089 | 0.000010 | 0.000014 |
| logging slow query | 0.000019 | 0.000009 | 0.000010 |
| cleaning up       | 0.000005 | 0.000003 | 0.000002 |
+-----+-----+-----+-----+
7 rows in set (0.00 sec)
```

**Note**

Profiling is only partially functional on some architectures. For values that depend on the `getrusage()` system call, `NULL` is returned on systems such as Windows that do not support the call. In addition, profiling is per process and not per thread. This means that activity on threads within the server other than your own may affect the timing information that you see.

`SHOW PROFILES` and `SHOW PROFILE` were added in MySQL 5.1.24 (but were not added to binary distributions by default until 5.1.28).

You can also get profiling information from the `PROFILING` table in `INFORMATION_SCHEMA`. See [Section 19.26, “The INFORMATION\\_SCHEMA PROFILING Table”](#). For example, the following queries produce the same result:

```
SHOW PROFILE FOR QUERY 2;

SELECT STATE, FORMAT(DURATION, 6) AS DURATION
FROM INFORMATION_SCHEMA.PROFILING
WHERE QUERY_ID = 2 ORDER BY SEQ;
```

**12.5.5.34. SHOW SCHEDULER STATUS Syntax**

```
SHOW SCHEDULER STATUS
```

This statement provides debugging information regarding the Event Scheduler's state. It is supported only in `-debug` builds of MySQL 5.1.11, and was removed in 5.1.12 and subsequent releases.

Sample output is shown here:

```
+-----+-----+
| Name          | Value |
+-----+-----+
| scheduler state | INITIALIZED |
| thread_id     | NULL |
| scheduler last locked at | init_scheduler::313 |
| scheduler last unlocked at | init_scheduler::318 |
| scheduler waiting on condition | 0 |
| scheduler workers count | 0 |
| scheduler executed events | 0 |
| scheduler data locked | 0 |
| queue element count | 1 |
| queue data locked | 0 |
| queue data attempting lock | 0 |
| queue last locked at | create_event::218 |
| queue last unlocked at | create_event::222 |
| queue last attempted lock at | ::0 |
| queue waiting on condition | 0 |
| next activation at | 0-00-00 00:00:00 |
+-----+-----+
```

In MySQL 5.1.12 and later, this information can be obtained using `mysqladmin debug`. (See [Section 4.5.2, “mysqladmin — Client for Administering a MySQL Server”](#).) For more information about obtaining Event Scheduler status information, see [Section 18.4.5, “Event Scheduler Status”](#).

**12.5.5.35. SHOW SLAVE HOSTS Syntax**

```
SHOW SLAVE HOSTS
```

Displays a list of replication slaves currently registered with the master. Only slaves started with the `--report-host=host_name` option are visible in this list.

The list is displayed on any server (not just the master server). The output looks like this:

```
mysql> SHOW SLAVE HOSTS;
+-----+-----+-----+-----+
| Server_id | Host       | Port | Master_id |
+-----+-----+-----+-----+
| 192168010 | iconnect2 | 3306 | 192168011 |
| 192168011 | athena    | 3306 | 192168011 |
+-----+-----+-----+-----+
```

- **Server\_id**: The unique server ID of the slave server, as configured in the server's option file, or on the command line with `--server-id=value`.
- **Host**: The host name of the slave server, as configured in the server's option file, or on the command line with `--report-host=host_name`. Note that this can differ from the machine name as configured in the operating system.
- **Port**: The port the slave server is listening on.
- **Master\_id**: The unique server ID of the master server that the slave server is replicating from.

Some MySQL versions report another variable, `Rpl_recovery_rank`. This variable was never used, and was eventually removed.

### 12.5.5.36. SHOW SLAVE STATUS Syntax

```
SHOW SLAVE STATUS
```

This statement provides status information on essential parameters of the slave threads. If you issue this statement using the `mysql` client, you can use a `\G` statement terminator rather than a semicolon to obtain a more readable vertical layout:

```
mysql> SHOW SLAVE STATUS\G
***** 1. row *****
      Slave_IO_State: Waiting for master to send event
      Master_Host: localhost
      Master_User: root
      Master_Port: 3306
      Connect_Retry: 3
      Master_Log_File: gbichot-bin.005
      Read_Master_Log_Pos: 79
      Relay_Log_File: gbichot-relay-bin.005
      Relay_Log_Pos: 548
      Relay_Master_Log_File: gbichot-bin.005
      Slave_IO_Running: Yes
      Slave_SQL_Running: Yes
      Replicate_Do_DB:
      Replicate_Ignore_DB:
      Last_Errno: 0
      Last_Error:
      Skip_Counter: 0
      Exec_Master_Log_Pos: 79
      Relay_Log_Space: 552
      Until_Condition: None
      Until_Log_File:
      Until_Log_Pos: 0
      Master_SSL_Allowed: No
      Master_SSL_CA_File:
      Master_SSL_CA_Path:
      Master_SSL_Cert:
      Master_SSL_Cipher:
      Master_SSL_Key:
      Seconds_Behind_Master: 8
      Master_SSL_Verify_Server_Cert: No
      Last_IO_Errno: 0
      Last_IO_Error:
      Last_SQL_Errno: 0
      Last_SQL_Error:
```

`SHOW SLAVE STATUS` returns the following fields:

- **Slave\_IO\_State**

A copy of the `State` field of the output of `SHOW PROCESSLIST` for the slave I/O thread. This tells you what the thread is doing: trying to connect to the master, waiting for events from the master, reconnecting to the master, and so on. Possible states

are listed in [Section 16.4.1, “Replication Implementation Details”](#). It is necessary to check this field for older versions of MySQL which allowed the thread to continue running while unsuccessfully trying to connect to the master. If it is running, there is no problem; if it is not, you can find the error in the `Last_Error` field (described below).

- `Master_Host`  
The current master host.
- `Master_User`  
The current user used to connect to the master.
- `Master_Port`  
The current master port.
- `Connect_Retry`  
The number of seconds between connect retries (default 60). This may be set with the `CHANGE MASTER TO` statement or `--master-connect-retry` option.
- `Master_Log_File`  
The name of the master binary log file from which the I/O thread is currently reading.
- `Read_Master_Log_Pos`  
The position up to which the I/O thread has read in the current master binary log.
- `Relay_Log_File`  
The name of the relay log file from which the SQL thread is currently reading and executing.
- `Relay_Log_Pos`  
The position up to which the SQL thread has read and executed in the current relay log.
- `Relay_Master_Log_File`  
The name of the master binary log file containing the most recent event executed by the SQL thread.
- `Slave_IO_Running`  
Whether the I/O thread is started and has connected successfully to the master. Internally, the state of this thread is represented by one of 3 values; these are shown with their meanings in the following list:
  - **`MYSQL_SLAVE_NOT_RUN`**. The slave I/O thread is not running.
  - **`MYSQL_SLAVE_RUN_NOT_CONNECT`**. The slave I/O thread is running, but is not connected to a replication master.
  - **`MYSQL_SLAVE_RUN_CONNECT`**. The slave I/O thread is running, and is connected to a replication master.

Different values are displayed for `Slave_IO_running` depending on the slave I/O thread's actual state and the version of MySQL used on the replication slave, as shown in the following table.

MySQL Version	<code>MYSQL_SLAVE_NOT_RUN</code>	<code>MYSQL_SLAVE_RUN_NOT_CONNECT</code>
4.1 (4.1.13 and earlier); 5.0 (5.0.11 and earlier)	No	Yes
4.1 (4.1.14 and later); 5.0 (5.0.12 and later)	No	No
5.1, 5.4 (all)	No	No
6.0 (6.0.10 and earlier)	No	No
6.0 (6.0.11 and later)	No	Connecting



- `Slave_SQL_Running`

Whether the SQL thread is started.

- `Replicate_Do_DB`, `Replicate_Ignore_DB`

The lists of databases that were specified with the `--replicate-do-db` and `--replicate-ignore-db` options, if any.

- `Replicate_Do_Table`, `Replicate_Ignore_Table`, `Replicate_Wild_Do_Table`, `Replicate_Wild_Ignore_Table`

The lists of tables that were specified with the `--replicate-do-table`, `--replicate-ignore-table`, `--replicate-wild-do-table`, and `--replicate-wild-ignore-table` options, if any.

- `Last_Errno`, `Last_Error`

As of MySQL 5.1.20, these columns are aliases for `Last_SQL_Errno` and `Last_SQL_Error`. Before 5.1.20, they indicate the error number and error message returned by the most recently executed statement. An error number of 0 and message of the empty string mean “no error.” If the `Last_Error` value is not empty, it also appears as a message in the slave's error log.

**MySQL Cluster.** Beginning with MySQL Cluster NDB 6.2.17, 6.3.23, and 6.4.3: Issuing `RESET MASTER` or `RESET SLAVE` resets the values shown in these columns. This applies to MySQL Cluster only. ([Bug#34654](#))

### Note

When the slave SQL thread receives an error, it reports the error first, then stops the SQL thread. This means that there is a small window of time during which `SHOW SLAVE STATUS` shows a nonzero value for `Last_Errno` even though `Slave_SQL_Running` still displays `Yes`.

- `Skip_Counter`

The most recently used value for `SQL_SLAVE_SKIP_COUNTER`.

- `Exec_Master_Log_Pos`

The position of the last event executed by the SQL thread from the master's binary log (`Relay_Master_Log_File`). (`Relay_Master_Log_File`, `Exec_Master_Log_Pos`) in the master's binary log corresponds to (`Relay_Log_File`, `Relay_Log_Pos`) in the relay log.

- `Relay_Log_Space`

The total combined size of all existing relay logs.

- `Until_Condition`, `Until_Log_File`, `Until_Log_Pos`

The values specified in the `UNTIL` clause of the `START SLAVE` statement.

`Until_Condition` has these values:

- `None` if no `UNTIL` clause was specified
- `Master` if the slave is reading until a given position in the master's binary logs
- `Relay` if the slave is reading until a given position in its relay logs

`Until_Log_File` and `Until_Log_Pos` indicate the log file name and position values that define the point at which the SQL thread stops executing.

- `Master_SSL_Allowed`, `Master_SSL_CA_File`, `Master_SSL_CA_Path`, `Master_SSL_Cert`, `Master_SSL_Cipher`, `Master_SSL_Key`

These fields show the SSL parameters used by the slave to connect to the master, if any.

`Master_SSL_Allowed` has these values:

- `Yes` if an SSL connection to the master is permitted
- `No` if an SSL connection to the master is not permitted
- `Ignored` if an SSL connection is permitted but the slave server does not have SSL support enabled

The values of the other SSL-related fields correspond to the values of the `MASTER_SSL_CA`, `MASTER_SSL_CAPATH`, `MAS-`

`TER_SSL_CERT`, `MASTER_SSL_CIPHER`, `MASTER_SSL_KEY`, and `MASTER_SSL_VERIFY_SERVER_CERT` options to the `CHANGE MASTER TO` statement. See [Section 12.6.2.1, “CHANGE MASTER TO Syntax”](#). `MAS-TER_SSL_VERIFY_SERVER_CERT` was added in MySQL 5.1.18.

- `Seconds_Behind_Master`

This field is an indication of how “late” the slave is:

- When the slave SQL thread is actively running (processing updates), this field is the number of seconds that have elapsed since the timestamp of the most recent event on the master executed by that thread.
- When the SQL thread has caught up to the slave I/O thread and goes idle waiting for more events from the I/O thread, this field is zero.

In essence, this field measures the time difference in seconds between the slave SQL thread and the slave I/O thread.

If the network connection between master and slave is fast, the slave I/O thread is very close to the master, so this field is a good approximation of how late the slave SQL thread is compared to the master. If the network is slow, this is *not* a good approximation; the slave SQL thread may quite often be caught up with the slow-reading slave I/O thread, so `Seconds_Behind_Master` often shows a value of 0, even if the I/O thread is late compared to the master. In other words, *this column is useful only for fast networks*.

This time difference computation works even though the master and slave do not have identical clocks (the clock difference is computed when the slave I/O thread starts, and assumed to remain constant from then on). `Seconds_Behind_Master` is `NULL` (which means “unknown”) if the slave SQL thread is not running, or if the slave I/O thread is not running or not connected to master. For example if the slave I/O thread is sleeping for the number of seconds given by the `CHANGE MASTER TO` statement or `--master-connect-retry` option (default 60) before reconnecting, `NULL` is shown, as the slave cannot know what the master is doing, and so cannot say reliably how late it is.

This field has one limitation. The timestamp is preserved through replication, which means that, if a master M1 is itself a slave of M0, any event from M1's binlog which originates in replicating an event from M0's binlog has the timestamp of that event. This enables MySQL to replicate `TIMESTAMP` successfully. However, the problem for `Seconds_Behind_Master` is that if M1 also receives direct updates from clients, the value randomly deviates, because sometimes the last M1's event is from M0 and sometimes it is the most recent timestamp from a direct update.

- `Last_IO_Errno`, `Last_IO_Error`

The error number and error message of the last error that caused the I/O thread to stop. An error number of 0 and message of the empty string mean “no error.” If the `Last_IO_Error` value is not empty, it also appears as a message in the slave's error log. These columns were added in MySQL 5.1.20.

**MySQL Cluster.** Beginning with MySQL Cluster NDB 6.2.17, 6.3.23, and 6.4.3: Issuing `RESET MASTER` or `RESET SLAVE` resets the values shown in these columns. This applies to MySQL Cluster only. ([Bug#34654](#))

- `Last_SQL_Errno`, `Last_SQL_Error`

The error number and error message of the last error that caused the SQL thread to stop. An error number of 0 and message of the empty string mean “no error.” If the `Last_IO_Error` value is not empty, it also appears as a message in the slave's error log. These columns were added in MySQL 5.1.20.

Example:

```
Last_SQL_Errno: 1051
Last_SQL_Error: error 'Unknown table 'z'' on query 'drop table z'
```

The message indicates that the table `z` existed on the master and was dropped there, but it did not exist on the slave, so `DROP TABLE` failed on the slave. (This might occur, for example, if you forget to copy the table to the slave when setting up replication.)

**MySQL Cluster.** Beginning with MySQL Cluster NDB 6.2.17, 6.3.23, and 6.4.3: Issuing `RESET MASTER` or `RESET SLAVE` resets the values shown in these columns. This applies to MySQL Cluster only. ([Bug#34654](#))

## 12.5.5.37. SHOW STATUS Syntax

```
SHOW [GLOBAL | SESSION] STATUS
     [LIKE 'pattern' | WHERE expr]
```

`SHOW STATUS` provides server status information. This information also can be obtained using the `mysqladmin extended-status` command. The `LIKE` clause, if present, indicates which variable names to match. The `WHERE` clause can be given to se-

lect rows using more general conditions, as discussed in [Section 19.28, “Extensions to SHOW Statements”](#).

Partial output is shown here. The list of names and values may be different for your server. The meaning of each variable is given in [Section 5.1.6, “Server Status Variables”](#).

```
mysql> SHOW STATUS;
+-----+-----+
| Variable_name | Value |
+-----+-----+
| Aborted_clients | 0 |
| Aborted_connects | 0 |
| Bytes_received | 155372598 |
| Bytes_sent | 1176560426 |
| Connections | 30023 |
| Created_tmp_disk_tables | 0 |
| Created_tmp_tables | 8340 |
| Created_tmp_files | 60 |
| .. | .. |
| Open_tables | 1 |
| Open_files | 2 |
| Open_streams | 0 |
| Opened_tables | 44600 |
| Questions | 2026873 |
| .. | .. |
| Table_locks_immediate | 1920382 |
| Table_locks_waited | 0 |
| Threads_cached | 0 |
| Threads_created | 30022 |
| Threads_connected | 1 |
| Threads_running | 1 |
| Uptime | 80380 |
+-----+-----+
```

With a [LIKE](#) clause, the statement displays only rows for those variables with names that match the pattern:

```
mysql> SHOW STATUS LIKE 'Key%';
+-----+-----+
| Variable_name | Value |
+-----+-----+
| Key_blocks_used | 14955 |
| Key_read_requests | 96854827 |
| Key_reads | 162040 |
| Key_write_requests | 7589728 |
| Key_writes | 3813196 |
+-----+-----+
```

With the [GLOBAL](#) modifier, [SHOW STATUS](#) displays the status values for all connections to MySQL. With [SESSION](#), it displays the status values for the current connection. If no modifier is present, the default is [SESSION](#). [LOCAL](#) is a synonym for [SESSION](#).

Some status variables have only a global value. For these, you get the same value for both [GLOBAL](#) and [SESSION](#). The scope for each status variable is listed at [Section 5.1.6, “Server Status Variables”](#).

#### MySQL Enterprise

Status variables provide valuable clues to the state of your servers. For expert interpretation of the information provided by status variables, subscribe to the MySQL Enterprise Monitor. For more information, see <http://www.mysql.com/products/enterprise/advisors.html>.

### 12.5.5.38. SHOW TABLE STATUS Syntax

```
SHOW TABLE STATUS [{FROM | IN} db_name]
[LIKE 'pattern' | WHERE expr]
```

[SHOW TABLE STATUS](#) works like [SHOW TABLES](#), but provides a lot of information about each non-[TEMPORARY](#) table. You can also get this list using the `mysqlshow --status db_name` command. The [LIKE](#) clause, if present, indicates which table names to match. The [WHERE](#) clause can be given to select rows using more general conditions, as discussed in [Section 19.28, “Extensions to SHOW Statements”](#).

This statement also displays information about views.

[SHOW TABLE STATUS](#) returns the following fields:

- **Name**  
The name of the table.
- **Engine**  
The storage engine for the table. See [Chapter 13, Storage Engines](#).

- `Version`

The version number of the table's `.frm` file.

- `Row_format`

The row storage format (`Fixed`, `Dynamic`, `Compressed`, `Redundant`, `Compact`). The format of `InnoDB` tables is reported as `Redundant` or `Compact`.

- `Rows`

The number of rows. Some storage engines, such as `MyISAM`, store the exact count. For other storage engines, such as `InnoDB`, this value is an approximation, and may vary from the actual value by as much as 40 to 50%. In such cases, use `SELECT COUNT(*)` to obtain an accurate count.

The `Rows` value is `NULL` for tables in the `INFORMATION_SCHEMA` database.

- `Avg_row_length`

The average row length.

- `Data_length`

The length of the data file.

- `Max_data_length`

The maximum length of the data file. This is the total number of bytes of data that can be stored in the table, given the data pointer size used.

- `Index_length`

The length of the index file.

- `Data_free`

The number of allocated but unused bytes.

Beginning with MySQL 5.1.24, this information is also shown for `InnoDB` tables (previously, it was in the `Comment` value). `InnoDB` tables report the free space of the tablespace to which the table belongs. For a table located in the shared tablespace, this is the free space of the shared tablespace. If you are using multiple tablespaces and the table has its own tablespace, the free space is for only that table. Free space means the number of completely free 1MB extents minus a safety margin. Even if free space displays as 0, it may be possible to insert rows as long as new extents need not be allocated.

For partitioned tables, this value is only an estimate and may not be absolutely correct. A more accurate method of obtaining this information in such cases is to query the `INFORMATION_SCHEMA.PARTITIONS` table, as shown in this example:

```
SELECT SUM(DATA_FREE)
FROM INFORMATION_SCHEMA.PARTITIONS
WHERE TABLE_SCHEMA = 'mydb'
AND TABLE_NAME = 'mytable';
```

For more information, see [Section 19.19, “The INFORMATION\\_SCHEMA PARTITIONS Table”](#).

- `Auto_increment`

The next `AUTO_INCREMENT` value.

- `Create_time`

When the table was created.

- `Update_time`

When the data file was last updated. For some storage engines, this value is `NULL`. For example, `InnoDB` stores multiple tables in its tablespace and the data file timestamp does not apply. For `MyISAM`, the data file timestamp is used; however, on Windows the timestamp is not updated by updates so the value is inaccurate.

- `Check_time`

When the table was last checked. Not all storage engines update this time, in which case the value is always `NULL`.

- [Collation](#)

The table's character set and collation.

- [Checksum](#)

The live checksum value (if any).

- [Create\\_options](#)

Extra options used with `CREATE TABLE`. The original options supplied when `CREATE TABLE` is called are retained and the options reported here may differ from the active table settings and options.

- [Comment](#)

The comment used when creating the table (or information as to why MySQL could not access the table information).

Before MySQL 5.1.24, free space for `InnoDB` tables is reported in the comment. As of 5.1.24, it is reported in the `Data_free` column.

For `MEMORY` tables, the `Data_length`, `Max_data_length`, and `Index_length` values approximate the actual amount of allocated memory. The allocation algorithm reserves memory in large amounts to reduce the number of allocation operations.

For `NDBCLUSTER` tables, the output of this statement shows appropriate values for the `Avg_row_length` and `Data_length` columns, with the exception that `BLOB` columns are not taken into account. Prior to MySQL 5.1.21, the number of MySQL Cluster replicas was shown in the `Comment` column as `number_of_replicas` ([Bug#11379](#)).

For views, all the fields displayed by `SHOW TABLE STATUS` are `NULL` except that `Name` indicates the view name and `Comment` says `view`.

### 12.5.5.39. SHOW TABLES Syntax

```
SHOW [FULL] TABLES [{FROM | IN} db_name]
[LIKE 'pattern' | WHERE expr]
```

`SHOW TABLES` lists the non-`TEMPORARY` tables in a given database. You can also get this list using the `mysqlshow db_name` command. The `LIKE` clause, if present, indicates which table names to match. The `WHERE` clause can be given to select rows using more general conditions, as discussed in [Section 19.28, “Extensions to SHOW Statements”](#).

This statement also lists any views in the database. The `FULL` modifier is supported such that `SHOW FULL TABLES` displays a second output column. Values for the second column are `BASE TABLE` for a table and `VIEW` for a view.

If you have no privileges for a base table or view, it does not show up in the output from `SHOW TABLES` or `mysqlshow db_name`.

### 12.5.5.40. SHOW TRIGGERS Syntax

```
SHOW TRIGGERS [{FROM | IN} db_name]
[LIKE 'pattern' | WHERE expr]
```

`SHOW TRIGGERS` lists the triggers currently defined for tables in a database (the default database unless a `FROM` clause is given). This statement requires the `TRIGGER` privilege (prior to MySQL 5.1.22, it requires the `SUPER` privilege). The `LIKE` clause, if present, indicates which table names to match and causes the statement to display triggers for those tables. The `WHERE` clause can be given to select rows using more general conditions, as discussed in [Section 19.28, “Extensions to SHOW Statements”](#).

For the trigger `ins_sum` as defined in [Section 18.3, “Using Triggers”](#), the output of this statement is as shown here:

```
mysql> SHOW TRIGGERS LIKE 'acc%\G
***** 1. row *****
      Trigger: ins_sum
      Event: INSERT
      Table: account
      Statement: SET @sum = @sum + NEW.amount
      Timing: BEFORE
      Created: NULL
      sql_mode:
      Definer: myname@localhost
character_set_client: latin1
collation_connection: latin1_swedish_ci
      Database Collation: latin1_swedish_ci
```

`character_set_client` is the session value of the `character_set_client` system variable when the trigger was cre-

ated. `collation_connection` is the session value of the `collation_connection` system variable when the trigger was created. `Database Collation` is the collation of the database with which the trigger is associated. These columns were added in MySQL 5.1.21.

### Note

When using a `LIKE` clause with `SHOW TRIGGERS`, the expression to be matched (*expr*) is compared with the name of the table on which the trigger is declared, and not with the name of the trigger:

```
mysql> SHOW TRIGGERS LIKE 'ins%';
Empty set (0.01 sec)
```

A brief explanation of the columns in the output of this statement is shown here:

- `Trigger`  
The name of the trigger.
- `Event`  
The event that causes trigger activation: one of 'INSERT', 'UPDATE', or 'DELETE'.
- `Table`  
The table for which the trigger is defined.
- `Statement`  
The statement to be executed when the trigger is activated. This is the same as the text shown in the `ACTION_STATEMENT` column of `INFORMATION_SCHEMA.TRIGGERS`.
- `Timing`  
One of the two values 'BEFORE' or 'AFTER'.
- `Created`  
Currently, the value of this column is always `NULL`.
- `sql_mode`  
The SQL mode in effect when the trigger executes.
- `Definer`  
The account that created the trigger.

See also [Section 19.16, “The INFORMATION\\_SCHEMA TRIGGERS Table”](#).

## 12.5.5.41. SHOW VARIABLES Syntax

```
SHOW [GLOBAL | SESSION] VARIABLES
[LIKE 'pattern' | WHERE expr]
```

`SHOW VARIABLES` shows the values of MySQL system variables. This information also can be obtained using the `mysqladmin variables` command. The `LIKE` clause, if present, indicates which variable names to match. The `WHERE` clause can be given to select rows using more general conditions, as discussed in [Section 19.28, “Extensions to SHOW Statements”](#).

With the `GLOBAL` modifier, `SHOW VARIABLES` displays the values that are used for new connections to MySQL. With `SESSION`, it displays the values that are in effect for the current connection. If no modifier is present, the default is `SESSION`. `LOCAL` is a synonym for `SESSION`.

If the default system variable values are unsuitable, you can set them using command options when `mysqld` starts, and most can be changed at runtime with the `SET` statement. See [Section 5.1.5, “Using System Variables”](#), and [Section 12.5.4, “SET Syntax”](#).

Partial output is shown here. The list of names and values may be different for your server. [Section 5.1.3, “Server System Variables”](#), describes the meaning of each variable, and [Section 7.5.3, “Tuning Server Parameters”](#), provides information about tuning them.

```
mysql> SHOW VARIABLES;
```

Variable_name	Value
auto_increment_increment	1
auto_increment_offset	1
automatic_sp_privileges	ON
back_log	50
basedir	/home/jon/bin/mysql-5.1/
binlog_cache_size	32768
bulk_insert_buffer_size	8388608
character_set_client	latin1
character_set_connection	latin1
..	
max_user_connections	0
max_write_lock_count	4294967295
multi_range_count	256
mysam_data_pointer_size	6
mysam_max_sort_file_size	2147483647
mysam_recover_options	OFF
mysam_repair_threads	1
mysam_sort_buffer_size	8388608
ndb_autoincrement_prefetch_sz	32
ndb_cache_check_time	0
ndb_force_send	ON
..	
time_zone	SYSTEM
timed_mutexes	OFF
tmp_table_size	33554432
tmpdir	
transaction_alloc_block_size	8192
transaction_prealloc_size	4096
tx_isolation	REPEATABLE-READ
updatable_views_with_limit	YES
version	5.1.6-alpha-log
version_comment	Source distribution
version_compile_machine	i686
version_compile_os	suse-linux
wait_timeout	28800

With a [LIKE](#) clause, the statement displays only rows for those variables with names that match the pattern. To obtain the row for a specific variable, use a [LIKE](#) clause as shown:

```
SHOW VARIABLES LIKE 'max_join_size';
SHOW SESSION VARIABLES LIKE 'max_join_size';
```

To get a list of variables whose name match a pattern, use the “%” wildcard character in a [LIKE](#) clause:

```
SHOW VARIABLES LIKE '%size%';
SHOW GLOBAL VARIABLES LIKE '%size%';
```

Wildcard characters can be used in any position within the pattern to be matched. Strictly speaking, because “\_” is a wildcard that matches any single character, you should escape it as “\\_” to match it literally. In practice, this is rarely necessary.

### 12.5.5.42. SHOW WARNINGS Syntax

```
SHOW WARNINGS [LIMIT [offset,] row_count]
SHOW COUNT(*) WARNINGS
```

`SHOW WARNINGS` shows the error, warning, and note messages that resulted from the last statement that generated messages in the current session. It shows nothing if the last statement used a table and generated no messages. (That is, a statement that uses a table but generates no messages clears the message list.) Statements that do not use tables and do not generate messages have no effect on the message list.

Warnings are generated for DML statements such as [INSERT](#), [UPDATE](#), and [LOAD DATA INFILE](#) as well as DDL statements such as [CREATE TABLE](#) and [ALTER TABLE](#).

A related statement, `SHOW ERRORS`, shows only the errors. See [Section 12.5.5.18](#), “`SHOW ERRORS Syntax`”.

The `SHOW COUNT(*) WARNINGS` statement displays the total number of errors, warnings, and notes. You can also retrieve this number from the `warning_count` variable:

```
SHOW COUNT(*) WARNINGS;
SELECT @@warning_count;
```

The value of `warning_count` might be greater than the number of messages displayed by `SHOW WARNINGS` if the `max_error_count` system variable is set so low that not all messages are stored. An example shown later in this section demonstrates how this can happen.

The `LIMIT` clause has the same syntax as for the [SELECT](#) statement. See [Section 12.2.8](#), “`SELECT Syntax`”.

The MySQL server sends back the total number of errors, warnings, and notes resulting from the last statement. If you are using the C API, this value can be obtained by calling `mysql_warning_count()`. See [Section 20.10.3.72](#), “`mysql_warning_count()`”.

The following `DROP TABLE` statement results in a note:

```
mysql> DROP TABLE IF EXISTS no_such_table;
mysql> SHOW WARNINGS;
+-----+-----+-----+
| Level | Code | Message                                     |
+-----+-----+-----+
| Note  | 1051 | Unknown table 'no_such_table'           |
+-----+-----+-----+
```

Here is a simple example that shows a syntax warning for `CREATE TABLE` and conversion warnings for `INSERT`:

```
mysql> CREATE TABLE t1 (a TINYINT NOT NULL, b CHAR(4)) TYPE=MyISAM;
Query OK, 0 rows affected, 1 warning (0.00 sec)
mysql> SHOW WARNINGS\G
***** 1. row *****
Level: Warning
Code: 1287
Message: 'TYPE=storage_engine' is deprecated, use
'ENGINE=storage_engine' instead
1 row in set (0.00 sec)

mysql> INSERT INTO t1 VALUES(10,'mysql'),(NULL,'test'),
-> (300,'Open Source');
Query OK, 3 rows affected, 4 warnings (0.01 sec)
Records: 3 Duplicates: 0 Warnings: 4

mysql> SHOW WARNINGS\G
***** 1. row *****
Level: Warning
Code: 1265
Message: Data truncated for column 'b' at row 1
***** 2. row *****
Level: Warning
Code: 1263
Message: Data truncated, NULL supplied to NOT NULL column 'a' at row 2
***** 3. row *****
Level: Warning
Code: 1264
Message: Data truncated, out of range for column 'a' at row 3
***** 4. row *****
Level: Warning
Code: 1265
Message: Data truncated for column 'b' at row 3
4 rows in set (0.00 sec)
```

The maximum number of error, warning, and note messages to store is controlled by the `max_error_count` system variable. By default, its value is 64. To change the number of messages you want stored, change the value of `max_error_count`. In the following example, the `ALTER TABLE` statement produces three warning messages, but only one is stored because `max_error_count` has been set to 1:

```
mysql> SHOW VARIABLES LIKE 'max_error_count';
+-----+-----+
| Variable_name | Value |
+-----+-----+
| max_error_count | 64   |
+-----+-----+
1 row in set (0.00 sec)

mysql> SET max_error_count=1;
Query OK, 0 rows affected (0.00 sec)

mysql> ALTER TABLE t1 MODIFY b CHAR;
Query OK, 3 rows affected, 3 warnings (0.00 sec)
Records: 3 Duplicates: 0 Warnings: 3

mysql> SELECT @@warning_count;
+-----+
| @@warning_count |
+-----+
| 3               |
+-----+
1 row in set (0.01 sec)

mysql> SHOW WARNINGS;
+-----+-----+-----+
| Level | Code | Message                                     |
+-----+-----+-----+
| Warning | 1263 | Data truncated for column 'b' at row 1 |
+-----+-----+-----+
1 row in set (0.00 sec)
```

To disable warnings, set `max_error_count` to 0. In this case, `warning_count` still indicates how many warnings have oc-



curred, but none of the messages are stored.

You can set the `sql_notes` session variable to 0 to cause `Note`-level warnings not to be recorded.

## 12.5.6. Other Administrative Statements

### 12.5.6.1. BINLOG Syntax

```
BINLOG 'str'
```

`BINLOG` is an internal-use statement. It is generated by the `mysqlbinlog` program as the printable representation of certain events in binary log files. (See [Section 4.6.7, “mysqlbinlog — Utility for Processing Binary Log Files”](#).) The `'str'` value is a base 64-encoded string that the server decodes to determine the data change indicated by the corresponding event. This statement requires the `SUPER` privilege. It was added in MySQL 5.1.5.

### 12.5.6.2. CACHE INDEX Syntax

```
CACHE INDEX
tbl_index_list [, tbl_index_list] ...
IN key_cache_name

tbl_index_list:
tbl_name [(INDEX|KEY) (index_name[, index_name] ...)]
```

The `CACHE INDEX` statement assigns table indexes to a specific key cache. It is used only for `MyISAM` tables.

The following statement assigns indexes from the tables `t1`, `t2`, and `t3` to the key cache named `hot_cache`:

```
mysql> CACHE INDEX t1, t2, t3 IN hot_cache;
```

Table	Op	Msg_type	Msg_text
test.t1	assign_to_keycache	status	OK
test.t2	assign_to_keycache	status	OK
test.t3	assign_to_keycache	status	OK

The syntax of `CACHE INDEX` enables you to specify that only particular indexes from a table should be assigned to the cache. The current implementation assigns all the table's indexes to the cache, so there is no reason to specify anything other than the table name.

The key cache referred to in a `CACHE INDEX` statement can be created by setting its size with a parameter setting statement or in the server parameter settings. For example:

```
mysql> SET GLOBAL keycache1.key_buffer_size=128*1024;
```

Key cache parameters can be accessed as members of a structured system variable. See [Section 5.1.5.1, “Structured System Variables”](#).

A key cache must exist before you can assign indexes to it:

```
mysql> CACHE INDEX t1 IN non_existent_cache;
ERROR 1284 (HY000): Unknown key cache 'non_existent_cache'
```

By default, table indexes are assigned to the main (default) key cache created at the server startup. When a key cache is destroyed, all indexes assigned to it become assigned to the default key cache again.

Index assignment affects the server globally: If one client assigns an index to a given cache, this cache is used for all queries involving the index, no matter which client issues the queries.

### 12.5.6.3. FLUSH Syntax

```
FLUSH [NO_WRITE_TO_BINLOG | LOCAL]
flush_option [, flush_option] ...
```

The `FLUSH` statement clears or reloads various internal caches used by MySQL. To execute `FLUSH`, you must have the `RELOAD` privilege.

The `RESET` statement is similar to `FLUSH`. See [Section 12.5.6.6, “RESET Syntax”](#).

`flush_option` can be any of the following:

- `DES_KEY_FILE`

Reloads the DES keys from the file that was specified with the `--des-key-file` option at server startup time.

- `HOSTS`

Empties the host cache tables. You should flush the host tables if some of your hosts change IP number or if you get the error message `Host 'host_name' is blocked`. When more than `max_connect_errors` errors occur successively for a given host while connecting to the MySQL server, MySQL assumes that something is wrong and blocks the host from further connection requests. Flushing the host tables enables further connection attempts from the host. See [Section B.1.2.6, “Host 'host\\_name' is blocked”](#). You can start `mysqld` with `--max_connect_errors=999999999` to avoid this error message.

- `LOGS`

Closes and reopens all log files. If binary logging is enabled, the sequence number of the binary log file is incremented by one relative to the previous file. On Unix, this is the same thing as sending a `SIGHUP` signal to the `mysqld` server (except on some Mac OS X 10.3 versions where `mysqld` ignores `SIGHUP` and `SIGQUIT`).

If the server is writing error output to a named file (for example, if it was started with the `--log-error` option), `FLUSH LOGS` causes it to rename the current error log file with a suffix of `-old` and create a new empty log file. No renaming occurs if the server is not writing to a named file (for example, if it is writing errors to the console).

- `MASTER (DEPRECATED)`. Deletes all binary logs, resets the binary log index file and creates a new binary log. `FLUSH MASTER` is deprecated in favor of `RESET MASTER`, and is supported for backward compatibility only. See [Section 12.6.1.2, “RESET MASTER Syntax”](#).

- `PRIVILEGES`

Reloads the privileges from the grant tables in the `mysql` database. On Unix, this also occurs if the server receives a `SIGHUP` signal.

The server caches information in memory as a result of `GRANT`, `CREATE USER`, `CREATE SERVER`, and `INSTALL PLUGIN` statements. This memory is not released by the corresponding `REVOKE`, `DROP USER`, `DROP SERVER`, and `UNINSTALL PLUGIN` statements, so for a server that executes many instances of the statements that cause caching, there will be an increase in memory use. This cached memory can be freed with `FLUSH PRIVILEGES`.

- `QUERY CACHE`

Defragment the query cache to better utilize its memory. `FLUSH QUERY CACHE` does not remove any queries from the cache, unlike `FLUSH TABLES` or `RESET QUERY CACHE`.

- `SLAVE (DEPRECATED)`. Resets all replication slave parameters, including relay log files and replication position in the master's binary logs. `FLUSH SLAVE` is deprecated in favor of `RESET SLAVE`, and is supported for backward compatibility only. See [Section 12.6.2.5, “RESET SLAVE Syntax”](#).

- `STATUS`

This option adds the current thread's session status variable values to the global values and resets the session values to zero. It also resets the counters for key caches (default and named) to zero and sets `Max_used_connections` to the current number of open connections. This is something you should use only when debugging a query. See [Section 1.6, “How to Report Bugs or Problems”](#).

- `{TABLE | TABLES} [tbl_name [, tbl_name] ...]`

When no tables are named, closes all open tables, forces all tables in use to be closed, and flushes the query cache. With one or more table names, flushes only the given tables. `FLUSH TABLES` also removes all query results from the query cache, like the `RESET QUERY CACHE` statement. No error occurs if a named table does not exist.

- `TABLES WITH READ LOCK`

Closes all open tables and locks all tables for all databases with a read lock until you explicitly release the lock by executing `UNLOCK TABLES`. This is very convenient way to get backups if you have a file system such as Veritas that can take snapshots in time.

`FLUSH TABLES WITH READ LOCK` acquires a global read lock and not table locks, so it is not subject to the same behavior as `LOCK TABLES` and `UNLOCK TABLES` with respect to table locking and implicit commits:

- `UNLOCK TABLES` implicitly commits any active transaction only if any tables currently have been locked with `LOCK TABLES`. The commit does not occur for `UNLOCK TABLES` following `FLUSH TABLES WITH READ LOCK` because the latter statement does not acquire table locks.

- Beginning a transaction causes table locks acquired with `LOCK TABLES` to be released, as though you had executed `UNLOCK TABLES`. Beginning a transaction does not release a global read lock acquired with `FLUSH TABLES WITH READ LOCK`.

`FLUSH TABLES WITH READ LOCK` does not prevent the server from inserting rows into the log tables (see [Section 5.2.1](#), “Selecting General Query and Slow Query Log Output Destinations”).

- `USER_RESOURCES`

Resets all per-hour user resources to zero. This enables clients that have reached their hourly connection, query, or update limits to resume activity immediately. `FLUSH USER_RESOURCES` does not apply to the limit on maximum simultaneous connections. See [Section 12.5.1.3](#), “GRANT Syntax”.

By default, `FLUSH` statements are written to the binary log so that they will be replicated to replication slaves. Logging can be suppressed with the optional `NO_WRITE_TO_BINLOG` keyword or its alias `LOCAL`.

See also [Section 12.5.6.6](#), “RESET Syntax”, for information about how the `RESET` statement is used with replication.

#### Note

`FLUSH LOGS`, `FLUSH MASTER`, `FLUSH SLAVE`, and `FLUSH TABLES WITH READ LOCK` are not written to the binary log in any case because they would cause problems if replicated to a slave.

The `mysqladmin` utility provides a command-line interface to some flush operations, via the `flush-hosts`, `flush-logs`, `flush-privileges`, `flush-status`, and `flush-tables` commands.

#### Note

It is not possible in MySQL 5.1 to issue `FLUSH` statements within stored functions or triggers. However, you may use `FLUSH` in stored procedures, so long as these are not called from stored functions or triggers. See [Section D.1](#), “Restrictions on Stored Routines, Triggers, and Events”.

### 12.5.6.4. KILL Syntax

```
KILL [CONNECTION | QUERY] thread_id
```

Each connection to `mysqld` runs in a separate thread. You can see which threads are running with the `SHOW PROCESSLIST` statement and kill a thread with the `KILL thread_id` statement.

`KILL` allows the optional `CONNECTION` or `QUERY` modifier:

- `KILL CONNECTION` is the same as `KILL` with no modifier: It terminates the connection associated with the given *thread\_id*.
- `KILL QUERY` terminates the statement that the connection is currently executing, but leaves the connection itself intact.

If you have the `PROCESS` privilege, you can see all threads. If you have the `SUPER` privilege, you can kill all threads and statements. Otherwise, you can see and kill only your own threads and statements.

You can also use the `mysqladmin processlist` and `mysqladmin kill` commands to examine and kill threads.

#### Note

You cannot use `KILL` with the Embedded MySQL Server library, because the embedded server merely runs inside the threads of the host application. It does not create any connection threads of its own.

When you use `KILL`, a thread-specific kill flag is set for the thread. In most cases, it might take some time for the thread to die, because the kill flag is checked only at specific intervals:

- In `SELECT`, `ORDER BY` and `GROUP BY` loops, the flag is checked after reading a block of rows. If the kill flag is set, the statement is aborted.
- During `ALTER TABLE`, the kill flag is checked before each block of rows are read from the original table. If the kill flag was set, the statement is aborted and the temporary table is deleted.

- During `UPDATE` or `DELETE` operations, the kill flag is checked after each block read and after each updated or deleted row. If the kill flag is set, the statement is aborted. Note that if you are not using transactions, the changes are not rolled back.
- `GET_LOCK()` aborts and returns `NULL`.
- An `INSERT DELAYED` thread quickly flushes (inserts) all rows it has in memory and then terminates.
- If the thread is in the table lock handler (state: `Locked`), the table lock is quickly aborted.
- If the thread is waiting for free disk space in a write call, the write is aborted with a “disk full” error message.

### Warning

Killing a `REPAIR TABLE` or `OPTIMIZE TABLE` operation on a `MyISAM` table results in a table that is corrupted and unusable. Any reads or writes to such a table fail until you optimize or repair it again (without interruption).

## 12.5.6.5. LOAD INDEX INTO CACHE Syntax

```
LOAD INDEX INTO CACHE
  tbl_index_list [, tbl_index_list] ...

tbl_index_list:
  tbl_name
  [[INDEX|KEY] (index_name[, index_name] ...)]
  [IGNORE LEAVES]
```

The `LOAD INDEX INTO CACHE` statement preloads a table index into the key cache to which it has been assigned by an explicit `CACHE INDEX` statement, or into the default key cache otherwise. `LOAD INDEX INTO CACHE` is used only for `MyISAM` tables. It is not supported for tables having user-defined partitioning (see [Section 17.5, “Restrictions and Limitations on Partitioning”](#).)

The `IGNORE LEAVES` modifier causes only blocks for the non-leaf nodes of the index to be preloaded.

The following statement preloads nodes (index blocks) of indexes for the tables `t1` and `t2`:

```
mysql> LOAD INDEX INTO CACHE t1, t2 IGNORE LEAVES;
+-----+-----+-----+-----+
| Table | Op          | Msg_type | Msg_text |
+-----+-----+-----+-----+
| test.t1 | preload_keys | status   | OK       |
| test.t2 | preload_keys | status   | OK       |
+-----+-----+-----+-----+
```

This statement preloads all index blocks from `t1`. It preloads only blocks for the non-leaf nodes from `t2`.

The syntax of `LOAD INDEX INTO CACHE` enables you to specify that only particular indexes from a table should be preloaded. The current implementation preloads all the table’s indexes into the cache, so there is no reason to specify anything other than the table name.

`LOAD INDEX INTO CACHE ... IGNORE LEAVES` fails unless all indexes in a table have the same block size. (Prior to MySQL 5.1.19, it fails even without `IGNORE LEAVES`.) You can determine index block sizes for a table by using `myisamchk -dv` and checking the `Blocksize` column.

## 12.5.6.6. RESET Syntax

```
RESET reset_option [, reset_option] ...
```

The `RESET` statement is used to clear the state of various server operations. You must have the `RELOAD` privilege to execute `RESET`.

`RESET` acts as a stronger version of the `FLUSH` statement. See [Section 12.5.6.3, “FLUSH Syntax”](#).

`reset_option` can be any of the following:

- `MASTER`  
Deletes all binary logs listed in the index file, resets the binary log index file to be empty, and creates a new binary log file.
- `QUERY CACHE`

Removes all query results from the query cache.

- `SLAVE`

Makes the slave forget its replication position in the master binary logs. Also resets the relay log by deleting any existing relay log files and beginning a new one.

## 12.6. Replication Statements

This section describes SQL statements related to replication. One group of statements is used for controlling master servers. The other is used for controlling slave servers.

### 12.6.1. SQL Statements for Controlling Master Servers

Replication can be controlled through the SQL interface. This section discusses statements for managing master replication servers. [Section 12.6.2, “SQL Statements for Controlling Slave Servers”](#), discusses statements for managing slave servers.

The following `SHOW` statements are used with master servers in replication:

- `SHOW BINARY LOGS`
- `SHOW BINLOG EVENTS`
- `SHOW MASTER STATUS`
- `SHOW SLAVE HOSTS`

For information about these statements, see [Section 12.5.5, “SHOW Syntax”](#).

#### 12.6.1.1. PURGE BINARY LOGS Syntax

```
PURGE { BINARY | MASTER } LOGS
      { TO 'log_name' | BEFORE datetime_expr }
```

The binary log is a set of files that contain information about data modifications made by the MySQL server. The log consists of a set of binary log files, plus an index file.

The `PURGE BINARY LOGS` statement deletes all the binary log files listed in the log index file prior to the specified log file name or date. The log files also are removed from the list recorded in the index file, so that the given log file becomes the first.

This statement has no effect if the `--log-bin` option has not been enabled.

Examples:

```
PURGE BINARY LOGS TO 'mysql-bin.010';
PURGE BINARY LOGS BEFORE '2008-04-02 22:46:26';
```

The `BEFORE` variant's *datetime\_expr* argument should evaluate to a `DATETIME` value (a value in `'YYYY-MM-DD hh:mm:ss'` format). `BINARY` and `MASTER` are synonyms.

This statement is safe to run while slaves are replicating. You do not need to stop them. If you have an active slave that currently is reading one of the logs you are trying to delete, this statement does nothing and fails with an error. However, if a slave is dormant and you happen to purge one of the logs it has yet to read, the slave will be unable to replicate after it comes up.

To safely purge logs, follow this procedure:

1. On each slave server, use `SHOW SLAVE STATUS` to check which log it is reading.
2. Obtain a listing of the binary logs on the master server with `SHOW BINARY LOGS`.
3. Determine the earliest log among all the slaves. This is the target log. If all the slaves are up to date, this is the last log on the list.
4. Make a backup of all the logs you are about to delete. (This step is optional, but always advisable.)
5. Purge all logs up to but not including the target log.

You can also set the `expire_logs_days` system variable to expire binary log files automatically after a given number of days (see [Section 5.1.3, “Server System Variables”](#)). If you are using replication, you should set the variable no lower than the maximum number of days your slaves might lag behind the master.

Prior to MySQL 5.1.24, `PURGE BINARY LOGS TO` and `PURGE BINARY LOGS BEFORE` did not behave in the same way (and neither one behaved correctly) when binary log files listed in the `.index` file had been removed from the system by some other means (such as using `rm` on Linux). Beginning with MySQL 5.1.24, both variants of the statement fail with an error in such cases. ([Bug#18199](#), [Bug#18453](#)) You can handle such errors by editing the `.index` file (which is a simple text file) manually and insuring that it lists only the binary log files that are actually present, then running again the `PURGE BINARY LOGS` statement that failed.

### 12.6.1.2. RESET MASTER Syntax

```
RESET MASTER
```

Deletes all binary logs listed in the index file, resets the binary log index file to be empty, and creates a new binary log file. It is intended to be used only when the master is started for the first time.

#### Important

This effects of this statement differ from those of `PURGE BINARY LOGS` in 2 key ways:

1. `RESET MASTER` removes *all* binary logs that are listed in the index file, leaving only a single, empty binary log file named `master-bin.000001`, whereas the numbering is not reset by `PURGE BINARY LOGS`.
2. `RESET MASTER` is *not* intended to be used while any replication slaves are running. The behavior of `RESET MASTER` when used while slaves are running is undefined (and thus unsupported), whereas `PURGE BINARY LOGS` may be safely used while replication slaves are running.

See also [Section 12.6.1.1, “PURGE BINARY LOGS Syntax”](#).

`RESET MASTER` can prove useful when you first set up the master and the slave, so that you can verify the setup as follows:

1. Start the master and slave, and start replication (see [Section 16.1.1, “How to Set Up Replication”](#))
2. Execute a few test queries on the master
3. Check that the queries were replicated to the slave
4. When replication is running correctly, issue `STOP SLAVE` on the slave, followed by `RESET SLAVE`; verify that any unwanted data no longer exists on the slave
5. Issue `RESET MASTER` on the master to clean up the test queries

After verifying the setup and getting rid of any unwanted and logs generated by testing, you can start the slave and begin replicating.

### 12.6.1.3. SET sql\_log\_bin Syntax

```
SET sql_log_bin = {0|1}
```

Disables or enables binary logging for the current connection (`sql_log_bin` is a session variable) if the client has the `SUPER` privilege. The statement is refused with an error if the client does not have that privilege.

## 12.6.2. SQL Statements for Controlling Slave Servers

Replication can be controlled through the SQL interface. This section discusses statements for managing slave replication servers. [Section 12.6.1, “SQL Statements for Controlling Master Servers”](#), discusses statements for managing master servers.

`SHOW SLAVE STATUS` is also used with replication slaves. For information about this statement, see [Section 12.5.5.36, “SHOW SLAVE STATUS Syntax”](#).

### 12.6.2.1. CHANGE MASTER TO Syntax

```
CHANGE MASTER TO master_def [, master_def] ...
```

```

master_def:
MASTER_BIND = 'interface_name'
MASTER_HOST = 'host_name'
MASTER_USER = 'user_name'
MASTER_PASSWORD = 'password'
MASTER_PORT = port_num
MASTER_CONNECT_RETRY = interval
MASTER_HEARTBEAT_PERIOD = interval
MASTER_LOG_FILE = 'master_log_name'
MASTER_LOG_POS = master_log_pos
RELAY_LOG_FILE = 'relay_log_name'
RELAY_LOG_POS = relay_log_pos
MASTER_SSL = {0|1}
MASTER_SSL_CA = 'ca_file_name'
MASTER_SSL_CAPATH = 'ca_directory_name'
MASTER_SSL_CERT = 'cert_file_name'
MASTER_SSL_KEY = 'key_file_name'
MASTER_SSL_CIPHER = 'cipher_list'
MASTER_SSL_VERIFY_SERVER_CERT = {0|1}

```

**CHANGE MASTER TO** changes the parameters that the slave server uses for connecting to and communicating with the master server. It also updates the contents of the `master.info` and `relay-log.info` files.

`MASTER_USER`, `MASTER_PASSWORD`, `MASTER_SSL`, `MASTER_SSL_CA`, `MASTER_SSL_CAPATH`, `MASTER_SSL_CERT`, `MASTER_SSL_KEY`, `MASTER_SSL_CIPHER`, and `MASTER_SSL_VERIFY_SERVER_CERT` provide information to the slave about how to connect to its master. `MASTER_SSL_VERIFY_SERVER_CERT` was added in MySQL 5.1.18. It is used as described for the `--ssl-verify-server-cert` option in [Section 5.5.7.3, “SSL Command Options”](#).

`MASTER_CONNECT_RETRY` specifies how many seconds to wait between connect retries. The default is 60. The *number* of reconnection attempts is limited by the `--master-retry-count` server option; for more information, see [Section 16.1.3, “Replication and Binary Logging Options and Variables”](#).

The SSL options (`MASTER_SSL`, `MASTER_SSL_CA`, `MASTER_SSL_CAPATH`, `MASTER_SSL_CERT`, `MASTER_SSL_KEY`, `MASTER_SSL_CIPHER`), and `MASTER_SSL_VERIFY_SERVER_CERT` can be changed even on slaves that are compiled without SSL support. They are saved to the `master.info` file, but are ignored unless you use a server that has SSL support enabled.

If you don't specify a given parameter, it keeps its old value, except as indicated in the following discussion. For example, if the password to connect to your MySQL master has changed, you just need to issue these statements to tell the slave about the new password:

```

STOP SLAVE; -- if replication was running
CHANGE MASTER TO MASTER_PASSWORD='new3cret';
START SLAVE; -- if you want to restart replication

```

There is no need to specify the parameters that do not change (host, port, user, and so forth).

`MASTER_HOST` and `MASTER_PORT` are the host name (or IP address) of the master host and its TCP/IP port.

The next two options are available only in MySQL Cluster NDB 6.3 and 6.4; they are not supported in mainline MySQL 5.1:

- `MASTER_BIND` is for use on replication slaves having multiple network interfaces, and determines which of the slave's network interfaces is chosen for connecting to the master. It is also possible to determine which network interface is to be used in such cases by starting the slave `mysqld` process with the `--master-bind` option.

The ability to bind a replication slave to specific network interface was added in MySQL Cluster NDB 6.3.4.

- `MASTER_HEARTBEAT_PERIOD` is used to set the interval in seconds between replication heartbeats. Whenever the master's binlog is updated with an event, the waiting period for the next heartbeat is reset. *interval* is a decimal value having the range 0 to 4294967 seconds and a resolution to hundredths of a second; the smallest nonzero value is 0.001. Heartbeats are sent by the master only if there are no unsent events in the binlog file for a period longer than *interval*.

Setting *interval* to 0 disables heartbeats altogether. The default value for *interval* is equal to the value of `slave_net_timeout` divided by 2.

#### Note

Setting `@@global.slave_net_timeout` to a value less than that of the current heartbeat interval results in a warning being issued.

Issuing `RESET SLAVE` resets the heartbeat interval to the default.

`MASTER_HEARTBEAT_PERIOD` was added in MySQL Cluster NDB 6.3.4.



**Note**

Replication cannot use Unix socket files. You must be able to connect to the master MySQL server using TCP/IP.

If you specify `MASTER_HOST` or `MASTER_PORT`, the slave assumes that the master server is different from before (even if you specify a host or port value that is the same as the current value.) In this case, the old values for the master binary log name and position are considered no longer applicable, so if you do not specify `MASTER_LOG_FILE` and `MASTER_LOG_POS` in the statement, `MASTER_LOG_FILE=' '` and `MASTER_LOG_POS=4` are silently appended to it.

Setting `MASTER_HOST=' '` — that is, setting its value explicitly to an empty string — is *not* the same as not setting it at all. Setting this option to an empty string causes `START SLAVE` subsequently to fail. This issue is addressed in MySQL 6.0. ([Bug#28796](#))

`MASTER_LOG_FILE` and `MASTER_LOG_POS` are the coordinates at which the slave I/O thread should begin reading from the master the next time the thread starts. If you specify either of them, you cannot specify `RELAY_LOG_FILE` or `RELAY_LOG_POS`. If neither of `MASTER_LOG_FILE` or `MASTER_LOG_POS` are specified, the slave uses the last coordinates of the *slave SQL thread* before `CHANGE MASTER TO` was issued. This ensures that there is no discontinuity in replication, even if the slave SQL thread was late compared to the slave I/O thread, when you merely want to change, say, the password to use.

`CHANGE MASTER TO` deletes all relay log files and starts a new one, unless you specify `RELAY_LOG_FILE` or `RELAY_LOG_POS`. In that case, relay logs are kept; the `relay_log_purge` global variable is set silently to 0.

`CHANGE MASTER TO` is useful for setting up a slave when you have the snapshot of the master and have recorded the log and the offset corresponding to it. After loading the snapshot into the slave, you can run `CHANGE MASTER TO MASTER_LOG_FILE='log_name_on_master', MASTER_LOG_POS=log_offset_on_master` on the slave.

The following example changes the master and master's binary log coordinates. This is used when you want to set up the slave to replicate the master:

```
CHANGE MASTER TO
  MASTER_HOST='master2.mycompany.com',
  MASTER_USER='replication',
  MASTER_PASSWORD='big3cret',
  MASTER_PORT=3306,
  MASTER_LOG_FILE='master2-bin.001',
  MASTER_LOG_POS=4,
  MASTER_CONNECT_RETRY=10;
```

The next example shows an operation that is less frequently employed. It is used when the slave has relay logs that you want it to execute again for some reason. To do this, the master need not be reachable. You need only use `CHANGE MASTER TO` and start the SQL thread (`START SLAVE SQL_THREAD`):

```
CHANGE MASTER TO
  RELAY_LOG_FILE='slave-relay-bin.006',
  RELAY_LOG_POS=4025;
```

You can even use the second operation in a non-replication setup with a standalone, non-slave server for recovery following a crash. Suppose that your server has crashed and you have restored a backup. You want to replay the server's own binary logs (not relay logs, but regular binary logs), named (for example) `myhost-bin.*`. First, make a backup copy of these binary logs in some safe place, in case you don't exactly follow the procedure below and accidentally have the server purge the binary logs. Use `SET GLOBAL relay_log_purge=0` for additional safety. Then start the server without the `--log-bin` option. Instead, use the `--replicate-same-server-id`, `--relay-log=myhost-bin` (to make the server believe that these regular binary logs are relay logs) and `--skip-slave-start` options. After the server starts, issue these statements:

```
CHANGE MASTER TO
  RELAY_LOG_FILE='myhost-bin.153',
  RELAY_LOG_POS=410,
  MASTER_HOST='some_dummy_string';
START SLAVE SQL_THREAD;
```

The server reads and executes its own binary logs, thus achieving crash recovery. Once the recovery is finished, run `STOP SLAVE`, shut down the server, delete the `master.info` and `relay-log.info` files, and restart the server with its original options.

Specifying the `MASTER_HOST` option (even with a dummy value) is required to make the server think it is a slave.

## 12.6.2.2. LOAD DATA FROM MASTER Syntax

```
LOAD DATA FROM MASTER
```

**This feature is deprecated. We recommend not using it anymore. It is subject to removal in a future version of MySQL.**



Since the current implementation of `LOAD DATA FROM MASTER` and `LOAD TABLE FROM MASTER` is very limited, these statements are deprecated in versions 4.1 of MySQL and above. We will introduce a more advanced technique (called “online backup”) in a future version. That technique will have the additional advantage of working with more storage engines.

For MySQL 5.1 and earlier, the recommended alternative solution to using `LOAD DATA FROM MASTER` or `LOAD TABLE FROM MASTER` is using `mysqldump` or `mysqlhotcopy`. The latter requires Perl and two Perl modules (`DBI` and `DBD:mysql`) and works for `MyISAM` and `ARCHIVE` tables only. With `mysqldump`, you can create SQL dumps on the master and pipe (or copy) these to a `mysql` client on the slave. This has the advantage of working for all storage engines, but can be quite slow, since it works using `SELECT`.

This statement takes a snapshot of the master and copies it to the slave. It updates the values of `MASTER_LOG_FILE` and `MASTER_LOG_POS` so that the slave starts replicating from the correct position. Any table and database exclusion rules specified with the `--replicate-*-do-*` and `--replicate-*-ignore-*` options are honored. `--replicate-rewrite-db` is *not* taken into account because a user could use this option to set up a non-unique mapping such as `--replicate-rewrite-db="db1->db3"` and `--replicate-rewrite-db="db2->db3"`, which would confuse the slave when loading tables from the master.

Use of this statement is subject to the following conditions:

- It works only for `MyISAM` tables. Attempting to load a non-`MyISAM` table results in the following error:

```
ERROR 1189 (08S01): Net error reading from master
```

- It acquires a global read lock on the master while taking the snapshot, which prevents updates on the master during the load operation.

If you are loading large tables, you might have to increase the values of `net_read_timeout` and `net_write_timeout` on both the master and slave servers. See [Section 5.1.3, “Server System Variables”](#).

Note that `LOAD DATA FROM MASTER` does *not* copy any tables from the `mysql` database. This makes it easy to have different users and privileges on the master and the slave.

To use `LOAD DATA FROM MASTER`, the replication account that is used to connect to the master must have the `RELOAD` and `SUPER` privileges on the master and the `SELECT` privilege for all master tables you want to load. All master tables for which the user does not have the `SELECT` privilege are ignored by `LOAD DATA FROM MASTER`. This is because the master hides them from the user: `LOAD DATA FROM MASTER` calls `SHOW DATABASES` to know the master databases to load, but `SHOW DATABASES` returns only databases for which the user has some privilege. See [Section 12.5.5.15, “SHOW DATABASES Syntax”](#). On the slave side, the user that issues `LOAD DATA FROM MASTER` must have privileges for dropping and creating the databases and tables that are copied.

### 12.6.2.3. `LOAD TABLE tbl_name FROM MASTER` Syntax

```
LOAD TABLE tbl_name FROM MASTER
```

**This feature is deprecated. We recommend not using it anymore. It is subject to removal in a future version of MySQL.**

Since the current implementation of `LOAD DATA FROM MASTER` and `LOAD TABLE FROM MASTER` is very limited, these statements are deprecated in versions 4.1 of MySQL and above. We will introduce a more advanced technique (called “online backup”) in a future version. That technique will have the additional advantage of working with more storage engines.

For MySQL 5.1 and earlier, the recommended alternative solution to using `LOAD DATA FROM MASTER` or `LOAD TABLE FROM MASTER` is using `mysqldump` or `mysqlhotcopy`. The latter requires Perl and two Perl modules (`DBI` and `DBD:mysql`) and works for `MyISAM` and `ARCHIVE` tables only. With `mysqldump`, you can create SQL dumps on the master and pipe (or copy) these to a `mysql` client on the slave. This has the advantage of working for all storage engines, but can be quite slow, since it works using `SELECT`.

Transfers a copy of the table from the master to the slave. This statement is implemented mainly debugging `LOAD DATA FROM MASTER` operations. To use `LOAD TABLE`, the account used for connecting to the master server must have the `RELOAD` and `SUPER` privileges on the master and the `SELECT` privilege for the master table to load. On the slave side, the user that issues `LOAD TABLE FROM MASTER` must have privileges for dropping and creating the table.

The conditions for `LOAD DATA FROM MASTER` apply here as well. For example, `LOAD TABLE FROM MASTER` works only for `MyISAM` tables. The timeout notes for `LOAD DATA FROM MASTER` apply as well.

### 12.6.2.4. `MASTER_POS_WAIT( )` Syntax

```
SELECT MASTER_POS_WAIT('master_log_file', master_log_pos [, timeout])
```

This is actually a function, not a statement. It is used to ensure that the slave has read and executed events up to a given position in the master's binary log. See [Section 11.11.4, “Miscellaneous Functions”](#), for a full description.

### 12.6.2.5. RESET SLAVE Syntax

```
RESET SLAVE
```

`RESET SLAVE` makes the slave forget its replication position in the master's binary logs. This statement is meant to be used for a clean start: It deletes the `master.info` and `relay-log.info` files, all the relay logs, and starts a new relay log.

#### Note

All relay logs are deleted, even if they have not been completely executed by the slave SQL thread. (This is a condition likely to exist on a replication slave if you have issued a `STOP SLAVE` statement or if the slave is highly loaded.)

Connection information stored in the `master.info` file is immediately reset using any values specified in the corresponding startup options. This information includes values such as master host, master port, master user, and master password. If the slave SQL thread was in the middle of replicating temporary tables when it was stopped, and `RESET SLAVE` is issued, these replicated temporary tables are deleted on the slave.

### 12.6.2.6. SET GLOBAL SQL\_SLAVE\_SKIP\_COUNTER Syntax

```
SET GLOBAL SQL_SLAVE_SKIP_COUNTER = N
```

This statement skips the next *N* events from the master. This is useful for recovering from replication stops caused by a statement.

This statement is valid only when the slave thread is not running. Otherwise, it produces an error.

When using this statement, it is important to understand that the binary log is actually organized as a sequence of groups known as *event groups*. Each event group consists of a sequence of events.

- For transactional tables, an event group corresponds to a transaction.
- For non-transactional tables, an event group corresponds to a single SQL statement.

#### Note

A single transaction can contain changes to both transactional and non-transactional tables.

When you use `SET GLOBAL SQL_SLAVE_SKIP_COUNTER` to skip events and the result is in the middle of a group, the slave continues to skip events until it reaches the end of the group. Execution then starts with the next event group.

### 12.6.2.7. START SLAVE Syntax

```
START SLAVE [thread_type [, thread_type] ... ]
START SLAVE [SQL_THREAD] UNTIL
  MASTER_LOG_FILE = 'log_name', MASTER_LOG_POS = log_pos
START SLAVE [SQL_THREAD] UNTIL
  RELAY_LOG_FILE = 'log_name', RELAY_LOG_POS = log_pos
thread_type: IO_THREAD | SQL_THREAD
```

`START SLAVE` with no *thread\_type* options starts both of the slave threads. The I/O thread reads queries from the master server and stores them in the relay log. The SQL thread reads the relay log and executes the queries. `START SLAVE` requires the `SUPER` privilege.

If `START SLAVE` succeeds in starting the slave threads, it returns without any error. However, even in that case, it might be that the slave threads start and then later stop (for example, because they do not manage to connect to the master or read its binary logs, or some other problem). `START SLAVE` does not warn you about this. You must check the slave's error log for error messages generated by the slave threads, or check that they are running satisfactorily with `SHOW SLAVE STATUS`.

`START SLAVE` sends an acknowledgement to the user after both the IO thread and the SQL thread have started. However, the IO thread may not yet have connected. For this reason, a successful `START SLAVE` causes `SHOW SLAVE STATUS` to show `Slave_SQL_Running=Yes`, but this does not guarantee that `Slave_IO_Running=Yes` (because `Slave_IO_Running=Yes` only if the IO thread is running *and connected*). For more information, see [Section 12.5.5.36, “SHOW SLAVE STATUS Syntax”](#), and [Section 16.1.4.1, “Checking Replication Status”](#).

You can add `IO_THREAD` and `SQL_THREAD` options to the statement to name which of the threads to start.

An `UNTIL` clause may be added to specify that the slave should start and run until the SQL thread reaches a given point in the master binary logs or in the slave relay logs. When the SQL thread reaches that point, it stops. If the `SQL_THREAD` option is specified in the statement, it starts only the SQL thread. Otherwise, it starts both slave threads. If the SQL thread is running, the `UNTIL` clause is ignored and a warning is issued.

For an `UNTIL` clause, you must specify both a log file name and position. Do not mix master and relay log options.

Any `UNTIL` condition is reset by a subsequent `STOP SLAVE` statement, a `START SLAVE` statement that includes no `UNTIL` clause, or a server restart.

The `UNTIL` clause can be useful for debugging replication, or to cause replication to proceed until just before the point where you want to avoid having the slave replicate a statement. For example, if an unwise `DROP TABLE` statement was executed on the master, you can use `UNTIL` to tell the slave to execute up to that point but no farther. To find what the event is, use `mysqlbinlog` with the master logs or slave relay logs, or by using a `SHOW BINLOG EVENTS` statement.

If you are using `UNTIL` to have the slave process replicated queries in sections, it is recommended that you start the slave with the `--skip-slave-start` option to prevent the SQL thread from running when the slave server starts. It is probably best to use this option in an option file rather than on the command line, so that an unexpected server restart does not cause it to be forgotten.

The `SHOW SLAVE STATUS` statement includes output fields that display the current values of the `UNTIL` condition.

In old versions of MySQL (before 4.0.5), this statement was called `SLAVE START`. This usage is still accepted in MySQL 5.1 for backward compatibility, but is deprecated.

### 12.6.2.8. STOP SLAVE Syntax

```
STOP SLAVE [thread_type [, thread_type] ... ]
thread_type: IO_THREAD | SQL_THREAD
```

Stops the slave threads. `STOP SLAVE` requires the `SUPER` privilege.

Like `START SLAVE`, this statement may be used with the `IO_THREAD` and `SQL_THREAD` options to name the thread or threads to be stopped.

#### Note

The transactional behavior of `STOP SLAVE` changed in MySQL 5.1.35. Previously, it took effect immediately; beginning with MySQL 5.1.35, it waits until the current replication event group (if any) has finished executing, or until the user issues a `KILL QUERY` or `KILL CONNECTION` statement. ([Bug#319](#), [Bug#38205](#))

In old versions of MySQL (before 4.0.5), this statement was called `SLAVE STOP`. This usage is still accepted in MySQL 5.1 for backward compatibility, but is deprecated.

## 12.7. SQL Syntax for Prepared Statements

MySQL 5.1 provides support for server-side prepared statements. This support takes advantage of the efficient client/server binary protocol implemented in MySQL 4.1, provided that you use an appropriate client programming interface. Candidate interfaces include the MySQL C API client library (for C programs), MySQL Connector/J (for Java programs), and MySQL Connector/NET. For example, the C API provides a set of function calls that make up its prepared statement API. See [Section 20.10.4, “C API Prepared Statements”](#). Other language interfaces can provide support for prepared statements that use the binary protocol by linking in the C client library, one example being the `mysql_i extension`, available in PHP 5.0 and later.

An alternative SQL interface to prepared statements is available. This interface is not as efficient as using the binary protocol through a prepared statement API, but requires no programming because it is available directly at the SQL level:

- You can use it when no programming interface is available to you.
- You can use it from any program that allows you to send SQL statements to the server to be executed, such as the `mysql` client program.
- You can use it even if the client is using an old version of the client library. The only requirement is that you be able to connect to a server that is recent enough to support SQL syntax for prepared statements.

SQL syntax for prepared statements is intended to be used for situations such as these:

- You want to test how prepared statements work in your application before coding it.
- An application has problems executing prepared statements and you want to determine interactively what the problem is.
- You want to create a test case that describes a problem you are having with prepared statements, so that you can file a bug report.
- You need to use prepared statements but do not have access to a programming API that supports them.

SQL syntax for prepared statements is based on three SQL statements:

- `PREPARE` prepares a statement for execution (see [Section 12.7.1, “PREPARE Syntax”](#)).
- `EXECUTE` executes a prepared statement (see [Section 12.7.2, “EXECUTE Syntax”](#)).
- `DEALLOCATE PREPARE` releases a prepared statement (see [Section 12.7.3, “DEALLOCATE PREPARE Syntax”](#)).

The following examples show two equivalent ways of preparing a statement that computes the hypotenuse of a triangle given the lengths of the two sides.

The first example shows how to create a prepared statement by using a string literal to supply the text of the statement:

```
mysql> PREPARE stmt1 FROM 'SELECT SQRT(POW(?,2) + POW(?,2)) AS hypotenuse';
mysql> SET @a = 3;
mysql> SET @b = 4;
mysql> EXECUTE stmt1 USING @a, @b;
+-----+
| hypotenuse |
+-----+
|          5 |
+-----+
mysql> DEALLOCATE PREPARE stmt1;
```

The second example is similar, but supplies the text of the statement as a user variable:

```
mysql> SET @s = 'SELECT SQRT(POW(?,2) + POW(?,2)) AS hypotenuse';
mysql> PREPARE stmt2 FROM @s;
mysql> SET @a = 6;
mysql> SET @b = 8;
mysql> EXECUTE stmt2 USING @a, @b;
+-----+
| hypotenuse |
+-----+
|          10 |
+-----+
mysql> DEALLOCATE PREPARE stmt2;
```

Here is an additional example which demonstrates how to choose the table on which to perform a query at run time, by storing the name of the table as a user variable:

```
mysql> USE test;
mysql> CREATE TABLE t1 (a INT NOT NULL);
mysql> INSERT INTO t1 VALUES (4), (8), (11), (32), (80);

mysql> SET @table = 't1';
mysql> SET @s = CONCAT('SELECT * FROM ', @table);

mysql> PREPARE stmt3 FROM @s;
mysql> EXECUTE stmt3;
+----+
| a  |
+----+
|  4 |
|  8 |
| 11 |
| 32 |
| 80 |
+----+

mysql> DEALLOCATE PREPARE stmt3;
```

A prepared statement is specific to the session in which it was created. If you terminate a session without deallocating a previously prepared statement, the server deallocates it automatically.

A prepared statement is also global to the session. If you create a prepared statement within a stored routine, it is not deallocated when the stored routine ends.

To guard against too many prepared statements being created simultaneously, set the `max_prepared_stmt_count` system variable. To prevent the use of prepared statements, set the value to 0.

The following SQL statements can be used in prepared statements: `ALTER TABLE`, `CALL`, `COMMIT`, `CREATE INDEX`, `CREATE TABLE`, `DELETE`, `DO`, `DROP INDEX`, `DROP TABLE`, `INSERT`, `RENAME TABLE`, `REPLACE`, `SELECT`, `SET`, `UPDATE`, and most `SHOW` statements.

As of MySQL 5.1.10, the following additional statements are supported:

```
ANALYZE TABLE
OPTIMIZE TABLE
REPAIR TABLE
```

As of MySQL 5.1.12, the following additional statements are supported:

```
CACHE INDEX
CHANGE MASTER
CHECKSUM {TABLE | TABLES}
{CREATE | DROP} DATABASE
{CREATE | RENAME | DROP} USER
FLUSH {TABLE | TABLES | TABLES WITH READ LOCK | HOSTS | PRIVILEGES
      | LOGS | STATUS | MASTER | SLAVE | DES_KEY_FILE | USER_RESOURCES}
GRANT
REVOKE
KILL
LOAD INDEX INTO CACHE
RESET {MASTER | SLAVE | QUERY CACHE}
SHOW BINLOG EVENTS
SHOW CREATE {PROCEDURE | FUNCTION | EVENT | TABLE | VIEW}
SHOW {AUTHORS | CONTRIBUTORS | WARNINGS | ERRORS}
SHOW {MASTER | BINARY} LOGS
SHOW {MASTER | SLAVE} STATUS
SLAVE {START | STOP}
INSTALL PLUGIN
UNINSTALL PLUGIN
```

Other statements are not yet supported.

Statements not allowed in SQL prepared statements are generally also not permitted in stored routines. Any exceptions to this rule are noted in [Section 18.2, “Using Stored Routines \(Procedures and Functions\)”](#).

Placeholders can be used for the arguments of the `LIMIT` clause when using prepared statements. See [Section 12.2.8, “SELECT Syntax”](#).

In prepared `CALL` statements used with `PREPARE` and `EXECUTE`, placeholder support for `OUT` and `INOUT` parameters is not available in MySQL 5.1. See [Section 12.2.1, “CALL Syntax”](#), for an example and a workaround. Placeholders can be used for `IN` parameters regardless of version.

SQL syntax for prepared statements cannot be used in nested fashion. That is, a statement passed to `PREPARE` cannot itself be a `PREPARE`, `EXECUTE`, or `DEALLOCATE PREPARE` statement.

SQL syntax for prepared statements is distinct from using prepared statement API calls. For example, you cannot use the `mysql_stmt_prepare()` C API function to prepare a `PREPARE`, `EXECUTE`, or `DEALLOCATE PREPARE` statement.

SQL syntax for prepared statements can be used within stored procedures, but not in stored functions or triggers. However, a cursor cannot be used for a dynamic statement that is prepared and executed with `PREPARE` and `EXECUTE`. The statement for a cursor is checked at cursor creation time, so the statement cannot be dynamic.

SQL syntax for prepared statements does not support multi-statements (that is, multiple statements within a single string separated by “`;`” characters).

Before MySQL 5.1.17, prepared statements do not use the query cache. As of 5.1.17, prepared statements use the query cache under the conditions described in [Section 7.5.5.1, “How the Query Cache Operates”](#).

To write C programs that use the `CALL` SQL statement to execute stored procedures that contain prepared statements, the `CLIENT_MULTI_RESULTS` flag must be enabled. This is because each `CALL` returns a result to indicate the call status, in addition to any result sets that might be returned by statements executed within the procedure.

`CLIENT_MULTI_RESULTS` can be enabled when you call `mysql_real_connect()`, either explicitly by passing the `CLIENT_MULTI_RESULTS` flag itself, or implicitly by passing `CLIENT_MULTI_STATEMENTS` (which also enables `CLIENT_MULTI_RESULTS`). For additional information, see [Section 12.2.1, “CALL Syntax”](#).

## 12.7.1. PREPARE Syntax

```
PREPARE stmt_name FROM preparable_stmt
```

The `PREPARE` statement prepares a statement and assigns it a name, `stmt_name`, by which to refer to the statement later. Statement names are not case sensitive. `preparable_stmt` is either a string literal or a user variable that contains the text of the statement. The text must represent a single SQL statement, not multiple statements. Within the statement, “?” characters can be used as parameter markers to indicate where data values are to be bound to the query later when you execute it. The “?” characters should not be enclosed within quotes, even if you intend to bind them to string values. Parameter markers can be used only where data values should appear, not for SQL keywords, identifiers, and so forth.

If a prepared statement with the given name already exists, it is deallocated implicitly before the new statement is prepared. This means that if the new statement contains an error and cannot be prepared, an error is returned and no statement with the given name exists.

A prepared statement is executed with `EXECUTE` and released with `DEALLOCATE PREPARE`.

The scope of a prepared statement is the session within which it is created. Other sessions cannot see it.

For examples, see [Section 12.7, “SQL Syntax for Prepared Statements”](#).

## 12.7.2. EXECUTE Syntax

```
EXECUTE stmt_name
[USING @var_name [, @var_name] ...]
```

After preparing a statement with `PREPARE`, you execute it with an `EXECUTE` statement that refers to the prepared statement name. If the prepared statement contains any parameter markers, you must supply a `USING` clause that lists user variables containing the values to be bound to the parameters. Parameter values can be supplied only by user variables, and the `USING` clause must name exactly as many variables as the number of parameter markers in the statement.

You can execute a given prepared statement multiple times, passing different variables to it or setting the variables to different values before each execution.

For examples, see [Section 12.7, “SQL Syntax for Prepared Statements”](#).

## 12.7.3. DEALLOCATE PREPARE Syntax

```
{DEALLOCATE | DROP} PREPARE stmt_name
```

To deallocate a prepared statement produced with `PREPARE`, use a `DEALLOCATE PREPARE` statement that refers to the prepared statement name. Attempting to execute a prepared statement after deallocating it results in an error.

For examples, see [Section 12.7, “SQL Syntax for Prepared Statements”](#).

## 12.7.4. Automatic Prepared Statement Repreparation

As of MySQL 5.1.25, metadata changes to tables or views referred to by prepared statements are detected and cause automatic repreparation of the statement when it is next executed. This applies to prepared statements processed at the SQL level (using the `PREPARE` statement) and those processed using the binary client-server protocol (using the `mysql_stmt_prepare()` C API function).

Metadata changes occur for DDL statements such as those that create, drop, alter, rename, or truncate tables, or that analyze, optimize, or repair tables. Repreparation also occurs after referenced tables or views are flushed from the table definition cache, either implicitly to make room for new entries in the cache, or explicitly due to `FLUSH TABLES`.

Repreparation is automatic, but to the extent that it occurs, performance of prepared statements is diminished.

When a statement is reprepared, the default database and SQL mode that were in effect for the original preparation are used.

Table content changes (for example, with `INSERT` or `UPDATE`) do not cause repreparation, nor do `SELECT` statements.

An incompatibility with previous versions of MySQL is that a prepared statement may return a different set of columns or different column types from one execution to the next. For example, if the prepared statement is `SELECT * FROM t1`, altering `t1` to contain a different number of columns causes the next execution to return a number of columns different from the previous execution.

Older versions of the client library cannot handle this change in behavior. For applications that use prepared statements with a server that performs automatic repreparation, an upgrade to the new client library is strongly recommended.

The `Com_stmt_reprepare` status variable tracks the number of repreparations.

## 12.8. MySQL Compound-Statement Syntax

This section describes the syntax for the `BEGIN ... END` compound statement and other statements that can be used in the body of stored programs: Stored procedures and functions, triggers, and events. These objects are defined in terms of SQL code that is stored on the server for later invocation (see [Chapter 18, \*Stored Programs and Views\*](#)).

## 12.8.1. `BEGIN ... END` Compound Statement Syntax

```
[begin_label:] BEGIN
  [statement_list]
END [end_label]
```

`BEGIN ... END` syntax is used for writing compound statements, which can appear within stored programs. A compound statement can contain multiple statements, enclosed by the `BEGIN` and `END` keywords. `statement_list` represents a list of one or more statements, each terminated by a semicolon (`;`) statement delimiter. `statement_list` is optional, which means that the empty compound statement (`BEGIN END`) is legal.

Use of multiple statements requires that a client is able to send statement strings containing the `;` statement delimiter. This is handled in the `mysql` command-line client with the `delimiter` command. Changing the `;` end-of-statement delimiter (for example, to `//`) allows `;` to be used in a program body. For an example, see [Section 18.1, “Defining Stored Programs”](#).

A compound statement can be labeled. `end_label` cannot be given unless `begin_label` also is present. If both are present, they must be the same.

The optional `[NOT] ATOMIC` clause is not supported. This means that no transactional savepoint is set at the start of the instruction block and the `BEGIN` clause used in this context has no effect on the current transaction.

## 12.8.2. `DECLARE` Syntax

The `DECLARE` statement is used to define various items local to a program:

- Local variables. See [Section 12.8.3, “Variables in Stored Programs”](#).
- Conditions and handlers. See [Section 12.8.4, “Conditions and Handlers”](#).
- Cursors. See [Section 12.8.5, “Cursors”](#).

The `SIGNAL` and `RESIGNAL` statements are not supported until MySQL 6.0.

`DECLARE` is allowed only inside a `BEGIN ... END` compound statement and must be at its start, before any other statements.

Declarations must follow a certain order. Cursors must be declared before declaring handlers, and variables and conditions must be declared before declaring either cursors or handlers.

## 12.8.3. Variables in Stored Programs

You may declare and use variables within stored programs.

### 12.8.3.1. `DECLARE` for Local Variables

```
DECLARE var_name [, var_name] ... type [DEFAULT value]
```

This statement is used to declare local variables within stored programs. To provide a default value for the variable, include a `DEFAULT` clause. The value can be specified as an expression; it need not be a constant. If the `DEFAULT` clause is missing, the initial value is `NULL`.

Local variables are treated like stored routine parameters with respect to data type and overflow checking. See [Section 12.1.15, “CREATE PROCEDURE and CREATE FUNCTION Syntax”](#).

Local variable names are not case sensitive.

The scope of a local variable is within the `BEGIN ... END` block where it is declared. The variable can be referred to in blocks nested within the declaring block, except those blocks that declare a variable with the same name.

### 12.8.3.2. Variable `SET` Statement

```
SET var_name = expr [, var_name = expr] ...
```



The `SET` statement in stored programs is an extended version of the general `SET` statement (see [Section 12.5.4, “SET Syntax”](#)). Referenced variables may be ones declared inside a stored program, global system variables, or user-defined variables.

The `SET` statement in stored programs is implemented as part of the pre-existing `SET` syntax. This allows an extended syntax of `SET a=x, b=y, ...` where different variable types (locally declared variables, global and session server variables, user-defined variables) can be mixed. This also allows combinations of local variables and some options that make sense only for system variables; in that case, the options are recognized but ignored.

### 12.8.3.3. `SELECT ... INTO` Statement

```
SELECT col_name [, col_name] ...
      INTO var_name [, var_name] ...
      table_expr
```

`SELECT ... INTO` syntax enables selected columns to be stored directly into variables. The query should return a single row. If the query returns no rows, a warning with error code 1329 occurs (`No data`), and the variable values remain unchanged. If the query returns multiple rows, error 1172 occurs (`Result consisted of more than one row`). If it is possible that the statement may retrieve multiple rows, you can use `LIMIT 1` to limit the result set to a single row.

In the context of such statements that occur as part of events executed by the Event Scheduler, diagnostics messages (not only errors, but also warnings) are written to the error log, and, on Windows, to the application event log. For additional information, see [Section 18.4.5, “Event Scheduler Status”](#).

```
SELECT id,data INTO x,y FROM test.t1 LIMIT 1;
```

User variable names are not case sensitive. See [Section 8.4, “User-Defined Variables”](#).

### 12.8.3.4. Scope and Resolution of Local Variables

The scope of a local variable is within the `BEGIN ... END` block where it is declared. The variable can be referred to in blocks nested within the declaring block, except those blocks that declare a variable with the same name.

Local variable names should not be the same as column names. If an SQL statement, such as a `SELECT ... INTO` statement, contains a reference to a column and a declared local variable with the same name, MySQL currently interprets the reference as the name of a variable. For example, in the following statement, `xname` is interpreted as a reference to the `xname` variable rather than the `xname` column:

```
CREATE PROCEDURE sp1 (x VARCHAR(5))
  BEGIN
    DECLARE xname VARCHAR(5) DEFAULT 'bob';
    DECLARE newname VARCHAR(5);
    DECLARE xid INT;

    SELECT xname,id INTO newname,xid
      FROM table1 WHERE xname = xname;
    SELECT newname;
  END;
```

When this procedure is called, the `newname` variable returns the value `'bob'` regardless of the value of the `table1.xname` column.

See also [Section D.1, “Restrictions on Stored Routines, Triggers, and Events”](#).

## 12.8.4. Conditions and Handlers

Certain conditions may require specific handling. These conditions can relate to errors or warnings, as well as to general flow control inside a stored program.

### 12.8.4.1. `DECLARE` for Conditions

```
DECLARE condition_name CONDITION FOR condition_value
condition_value:
  SQLSTATE [VALUE] sqlstate_value
  | mysql_error_code
```

The `DECLARE ... CONDITION` statement defines a named error condition. It specifies a condition that needs specific handling and associates a name with that condition. The name can be referred to in a subsequence `DECLARE ... HANDLER` statement. See [Section 12.8.4.2, “DECLARE for Handlers”](#).

A `condition_value` for `DECLARE ... CONDITION` can be an SQLSTATE value (a 5-character string literal) or a MySQL



error code (a number). You should not use SQLSTATE value '00000' or MySQL error code 0, because those indicate success rather than an error condition. For a list of SQLSTATE values and MySQL error codes, see [Section B.3, “Server Error Codes and Messages”](#).

## 12.8.4.2. DECLARE for Handlers

```
DECLARE handler_type HANDLER
  FOR condition_value [, condition_value] ...
  statement

handler_type:
  CONTINUE
  EXIT
  UNDO

condition_value:
  SQLSTATE [VALUE] sqlstate_value
  condition_name
  SQLWARNING
  NOT FOUND
  SQLEXCEPTION
  mysql_error_code
```

The `DECLARE ... HANDLER` statement specifies handlers that each may deal with one or more conditions. If one of these conditions occurs, the specified *statement* is executed. *statement* can be a simple statement (for example, `SET var_name = value`), or it can be a compound statement written using `BEGIN` and `END` (see [Section 12.8.1, “BEGIN ... END Compound Statement Syntax”](#)).

For a `CONTINUE` handler, execution of the current program continues after execution of the handler statement. For an `EXIT` handler, execution terminates for the `BEGIN ... END` compound statement in which the handler is declared. (This is true even if the condition occurs in an inner block.) The `UNDO` handler type statement is not supported.

If a condition occurs for which no handler has been declared, the default action is `EXIT`.

A *condition\_value* for `DECLARE ... HANDLER` can be any of the following values:

- An SQLSTATE value (a 5-character string literal) or a MySQL error code (a number). You should not use SQLSTATE value '00000' or MySQL error code 0, because those indicate success rather than an error condition. For a list of SQLSTATE values and MySQL error codes, see [Section B.3, “Server Error Codes and Messages”](#).
- A condition name previously specified with `DECLARE ... CONDITION`. See [Section 12.8.4.1, “DECLARE for Conditions”](#).
- `SQLWARNING` is shorthand for the class of SQLSTATE values that begin with '01'.
- `NOT FOUND` is shorthand for the class of SQLSTATE values that begin with '02'. This is relevant only in the context of cursors and is used to control what happens when a cursor reaches the end of a data set. If no more rows are available, a No Data condition occurs with SQLSTATE value 02000. To detect this condition, you can set up a handler for it (or for a `NOT FOUND` condition). An example is shown in [Section 12.8.5, “Cursors”](#). This condition also occurs for `SELECT ... INTO var_list` statements that retrieve no rows.
- `SQLEXCEPTION` is shorthand for the class of SQLSTATE values that do not begin with '00', '01', or '02'.

Example:

```
mysql> CREATE TABLE test.t (s1 INT, PRIMARY KEY (s1));
Query OK, 0 rows affected (0.00 sec)

mysql> delimiter //

mysql> CREATE PROCEDURE handlerdemo ()
-> BEGIN
->   DECLARE CONTINUE HANDLER FOR SQLSTATE '23000' SET @x2 = 1;
->   SET @x = 1;
->   INSERT INTO test.t VALUES (1);
->   SET @x = 2;
->   INSERT INTO test.t VALUES (1);
->   SET @x = 3;
-> END;
-> //
Query OK, 0 rows affected (0.00 sec)

mysql> CALL handlerdemo()//
Query OK, 0 rows affected (0.00 sec)

mysql> SELECT @x//
+-----+
| @x    |
+-----+
| 3     |
```

```
+-----+
1 row in set (0.00 sec)
```

The example associates a handler with SQLSTATE value '23000', which occurs for a duplicate-key error. Notice that `@x` is 3 after the procedure executes, which shows that execution continued to the end of the procedure. If the `DECLARE ... HANDLER` statement had not been present, MySQL would have taken the default path (`EXIT`) after the second `INSERT` failed due to the `PRIMARY KEY` constraint, and `SELECT @x` would have returned 2.

If you want to ignore a condition, you can declare a `CONTINUE` handler for it and associate it with an empty block. For example:

```
DECLARE CONTINUE HANDLER FOR SQLWARNING BEGIN END;
```

The statement associated with a handler cannot use `ITERATE` or `LEAVE` to refer to labels for blocks that enclose the handler declaration. That is, the scope of a block label does not include the code for handlers declared within the block. Consider the following example, where the `REPEAT` block has a label of `retry`:

```
CREATE PROCEDURE p ()
BEGIN
  DECLARE i INT DEFAULT 3;
  retry:
  REPEAT
  BEGIN
    DECLARE CONTINUE HANDLER FOR SQLWARNING
    BEGIN
      ITERATE retry; # illegal
    END;
  END;
  IF i < 0 THEN
    LEAVE retry; # legal
  END IF;
  SET i = i - 1;
  UNTIL FALSE END REPEAT;
END;
```

The label is in scope for the `IF` statement within the block. It is not in scope for the `CONTINUE` handler, so the reference there is invalid and results in an error:

```
ERROR 1308 (42000): LEAVE with no matching label: retry
```

To avoid using references to outer labels in handlers, you can use these strategies:

- To leave the block, use an `EXIT` handler:

```
DECLARE EXIT HANDLER FOR SQLWARNING BEGIN END;
```

- To iterate, set a status variable in the handler that can be checked in the enclosing block to determine whether the handler was invoked. The following example uses the variable `done` for this purpose:

```
CREATE PROCEDURE p ()
BEGIN
  DECLARE i INT DEFAULT 3;
  DECLARE done INT DEFAULT FALSE;
  retry:
  REPEAT
  BEGIN
    DECLARE CONTINUE HANDLER FOR SQLWARNING
    BEGIN
      SET done = TRUE;
    END;
  END;
  IF NOT done AND i < 0 THEN
    LEAVE retry;
  END IF;
  SET i = i - 1;
  UNTIL FALSE END REPEAT;
END;
```

## 12.8.5. Cursors

Cursors are supported inside stored routines, triggers, and events. The syntax is as in embedded SQL. Cursors in MySQL have these properties:

- Asensitive: The server may or may not make a copy of its result table
- Read only: Not updatable

- Non-scrollable: Can be traversed only in one direction and cannot skip rows

Cursors must be declared before declaring handlers. Variables and conditions must be declared before declaring either cursors or handlers.

Example:

```
CREATE PROCEDURE curdemo()
BEGIN
  DECLARE done INT DEFAULT 0;
  DECLARE a CHAR(16);
  DECLARE b,c INT;
  DECLARE cur1 CURSOR FOR SELECT id,data FROM test.t1;
  DECLARE cur2 CURSOR FOR SELECT i FROM test.t2;
  DECLARE CONTINUE HANDLER FOR NOT FOUND SET done = 1;

  OPEN cur1;
  OPEN cur2;

  REPEAT
    FETCH cur1 INTO a, b;
    FETCH cur2 INTO c;
    IF NOT done THEN
      IF b < c THEN
        INSERT INTO test.t3 VALUES (a,b);
      ELSE
        INSERT INTO test.t3 VALUES (a,c);
      END IF;
    END IF;
  UNTIL done END REPEAT;

  CLOSE cur1;
  CLOSE cur2;
END
```

### 12.8.5.1. DECLARE for Cursors

```
DECLARE cursor_name CURSOR FOR select_statement
```

This statement declares a cursor. Multiple cursors may be declared in a stored program, but each cursor in a given block must have a unique name.

The `SELECT` statement cannot have an `INTO` clause.

### 12.8.5.2. Cursor OPEN Statement

```
OPEN cursor_name
```

This statement opens a previously declared cursor.

### 12.8.5.3. Cursor FETCH Statement

```
FETCH cursor_name INTO var_name [, var_name] ...
```

This statement fetches the next row (if a row exists) using the specified open cursor, and advances the cursor pointer.

If no more rows are available, a No Data condition occurs with SQLSTATE value 02000. To detect this condition, you can set up a handler for it (or for a `NOT FOUND` condition). An example is shown in [Section 12.8.5, “Cursors”](#).

### 12.8.5.4. Cursor CLOSE Statement

```
CLOSE cursor_name
```

This statement closes a previously opened cursor.

If not closed explicitly, a cursor is closed at the end of the compound statement in which it was declared.

## 12.8.6. Flow Control Constructs

MySQL supports the `IF`, `CASE`, `ITERATE`, `LEAVE LOOP`, `WHILE`, and `REPEAT` constructs for flow control within stored programs.

Many of these constructs contain other statements, as indicated by the grammar specifications in the following sections. Such con-

structs may be nested. For example, an **IF** statement might contain a **WHILE** loop, which itself contains a **CASE** statement.

**FOR** loops are not supported.

### 12.8.6.1. **IF** Statement

```
IF search_condition THEN statement_list
  [ELSEIF search_condition THEN statement_list] ...
  [ELSE statement_list]
END IF
```

**IF** implements a basic conditional construct. If the *search\_condition* evaluates to true, the corresponding SQL statement list is executed. If no *search\_condition* matches, the statement list in the **ELSE** clause is executed. Each *statement\_list* consists of one or more statements.

#### Note

There is also an **IF()** function, which differs from the **IF** statement described here. See [Section 11.3, “Control Flow Functions”](#).

An **IF ... END IF** block, like all other flow-control blocks used within stored programs, must be terminated with a semicolon, as shown in this example:

```
DELIMITER //
CREATE FUNCTION SimpleCompare(n INT, m INT)
  RETURNS VARCHAR(20)
  BEGIN
    DECLARE s VARCHAR(20);
    IF n > m THEN SET s = '>';
    ELSEIF n = m THEN SET s = '=';
    ELSE SET s = '<';
    END IF;
    SET s = CONCAT(n, ' ', s, ' ', m);
    RETURN s;
  END //
DELIMITER ;
```

As with other flow-control constructs, **IF ... END IF** blocks may be nested within other flow-control constructs, including other **IF** statements. Each **IF** must be terminated by its own **END IF** followed by a semicolon. You can use indentation to make nested flow-control blocks more easily readable by humans (although this is not required by MySQL), as shown here:

```
DELIMITER //
CREATE FUNCTION VerboseCompare (n INT, m INT)
  RETURNS VARCHAR(50)
  BEGIN
    DECLARE s VARCHAR(50);
    IF n = m THEN SET s = 'equals';
    ELSE
      IF n > m THEN SET s = 'greater';
      ELSE SET s = 'less';
      END IF;
    SET s = CONCAT('is ', s, ' than');
    END IF;
    SET s = CONCAT(n, ' ', s, ' ', m, '.');
    RETURN s;
  END //
DELIMITER ;
```

In this example, the inner **IF** is evaluated only if **n** is not equal to **m**.

### 12.8.6.2. **CASE** Statement

```
CASE case_value
  WHEN when_value THEN statement_list
  [WHEN when_value THEN statement_list] ...
  [ELSE statement_list]
END CASE
```

Or:

```

CASE
  WHEN search_condition THEN statement_list
  [WHEN search_condition THEN statement_list] ...
  [ELSE statement_list]
END CASE

```

The **CASE** statement for stored programs implements a complex conditional construct. If a *search\_condition* evaluates to true, the corresponding SQL statement list is executed. If no search condition matches, the statement list in the **ELSE** clause is executed. Each *statement\_list* consists of one or more statements.

If no *when\_value* or *search\_condition* matches the value tested and the **CASE** statement contains no **ELSE** clause, a **CASE NOT FOUND FOR CASE STATEMENT** error results.

Each *statement\_list* consists of one or more statements; an empty *statement\_list* is not allowed. To handle situations where no value is matched by any **WHEN** clause, use an **ELSE** containing an empty **BEGIN ... END** block, as shown in this example:

```

DELIMITER |
CREATE PROCEDURE p()
  BEGIN
    DECLARE v INT DEFAULT 1;

    CASE v
      WHEN 2 THEN SELECT v;
      WHEN 3 THEN SELECT 0;
      ELSE
        BEGIN
          END;
        END CASE;
    END;
  |

```

(The indentation used here in the **ELSE** clause is for purposes of clarity only, and is not otherwise significant.)

### Note

The syntax of the **CASE statement** used inside stored programs differs slightly from that of the SQL **CASE expression** described in Section 11.3, “Control Flow Functions”. The **CASE** statement cannot have an **ELSE NULL** clause, and it is terminated with **END CASE** instead of **END**.

### 12.8.6.3. LOOP Statement

```

[begin_label:] LOOP
  statement_list
END LOOP [end_label]

```

**LOOP** implements a simple loop construct, enabling repeated execution of the statement list, which consists of one or more statements, each terminated by a semicolon (;) statement delimiter. The statements within the loop are repeated until the loop is exited; usually this is accomplished with a **LEAVE** statement.

A **LOOP** statement can be labeled. *end\_label* cannot be given unless *begin\_label* also is present. If both are present, they must be the same.

### 12.8.6.4. LEAVE Statement

```

LEAVE label

```

This statement is used to exit the flow control construct that has the given label. It can be used within **BEGIN ... END** or loop constructs (**LOOP**, **REPEAT**, **WHILE**).

### 12.8.6.5. ITERATE Statement

```

ITERATE label

```

**ITERATE** can appear only within **LOOP**, **REPEAT**, and **WHILE** statements. **ITERATE** means “do the loop again.”

Example:

```

CREATE PROCEDURE doiterate(p1 INT)
  BEGIN
    label1: LOOP
      SET p1 = p1 + 1;
      IF p1 < 10 THEN ITERATE label1; END IF;
      LEAVE label1;
    END LOOP label1;

```

```
SET @x = p1;
END
```

### 12.8.6.6. REPEAT Statement

```
[begin_label:] REPEAT
  statement_list
UNTIL search_condition
END REPEAT [end_label]
```

The statement list within a **REPEAT** statement is repeated until the *search\_condition* is true. Thus, a **REPEAT** always enters the loop at least once. *statement\_list* consists of one or more statements, each terminated by a semicolon (;) statement delimiter.

A **REPEAT** statement can be labeled. *end\_label* cannot be given unless *begin\_label* also is present. If both are present, they must be the same.

Example:

```
mysql> delimiter //

mysql> CREATE PROCEDURE dorepeat(p1 INT)
-> BEGIN
->   SET @x = 0;
->   REPEAT SET @x = @x + 1; UNTIL @x > p1 END REPEAT;
-> END
-> //
Query OK, 0 rows affected (0.00 sec)

mysql> CALL dorepeat(1000)//
Query OK, 0 rows affected (0.00 sec)

mysql> SELECT @x//
+-----+
| @x    |
+-----+
| 1001  |
+-----+
1 row in set (0.00 sec)
```

### 12.8.6.7. WHILE Statement

```
[begin_label:] WHILE search_condition DO
  statement_list
END WHILE [end_label]
```

The statement list within a **WHILE** statement is repeated as long as the *search\_condition* is true. *statement\_list* consists of one or more statements.

A **WHILE** statement can be labeled. *end\_label* cannot be given unless *begin\_label* also is present. If both are present, they must be the same.

Example:

```
CREATE PROCEDURE dowhile()
BEGIN
  DECLARE v1 INT DEFAULT 5;

  WHILE v1 > 0 DO
    ...
    SET v1 = v1 - 1;
  END WHILE;
END
```

### 12.8.7. RETURN Syntax

```
RETURN expr
```

The **RETURN** statement terminates execution of a stored function and returns the value *expr* to the function caller. There must be at least one **RETURN** statement in a stored function. There may be more than one if the function has multiple exit points.

This statement is not used in stored procedures, triggers, or events.

---

# Chapter 13. Storage Engines

MySQL supports several storage engines that act as handlers for different table types. MySQL storage engines include both those that handle transaction-safe tables and those that handle non-transaction-safe tables.

With MySQL 5.1, MySQL AB has introduced a new pluggable storage engine architecture that allows storage engines to be loaded into and unloaded from a running MySQL server.

To determine which storage engines your server supports by using the `SHOW ENGINES` statement. The value in the `Support` column indicates whether an engine can be used. A value of `YES`, `NO`, or `DEFAULT` indicates that an engine is available, not available, or available and current set as the default storage engine.

```
mysql> SHOW ENGINES\G
***** 1. row *****
  Engine: FEDERATED
  Support: NO
  Comment: Federated MySQL storage engine
  Transactions: NULL
    XA: NULL
  Savepoints: NULL
***** 2. row *****
  Engine: MRG_MYISAM
  Support: YES
  Comment: Collection of identical MyISAM tables
  Transactions: NO
    XA: NO
  Savepoints: NO
***** 3. row *****
  Engine: MyISAM
  Support: DEFAULT
  Comment: Default engine as of MySQL 3.23 with great performance
  Transactions: NO
    XA: NO
  Savepoints: NO
...

```

This chapter describes each of the MySQL storage engines except for `NDBCLUSTER`, which is covered in [MySQL Cluster NDB 6.X/7.X](#). It also contains a description of the pluggable storage engine architecture (see [Section 13.1, “Overview of MySQL Storage Engine Architecture”](#)).

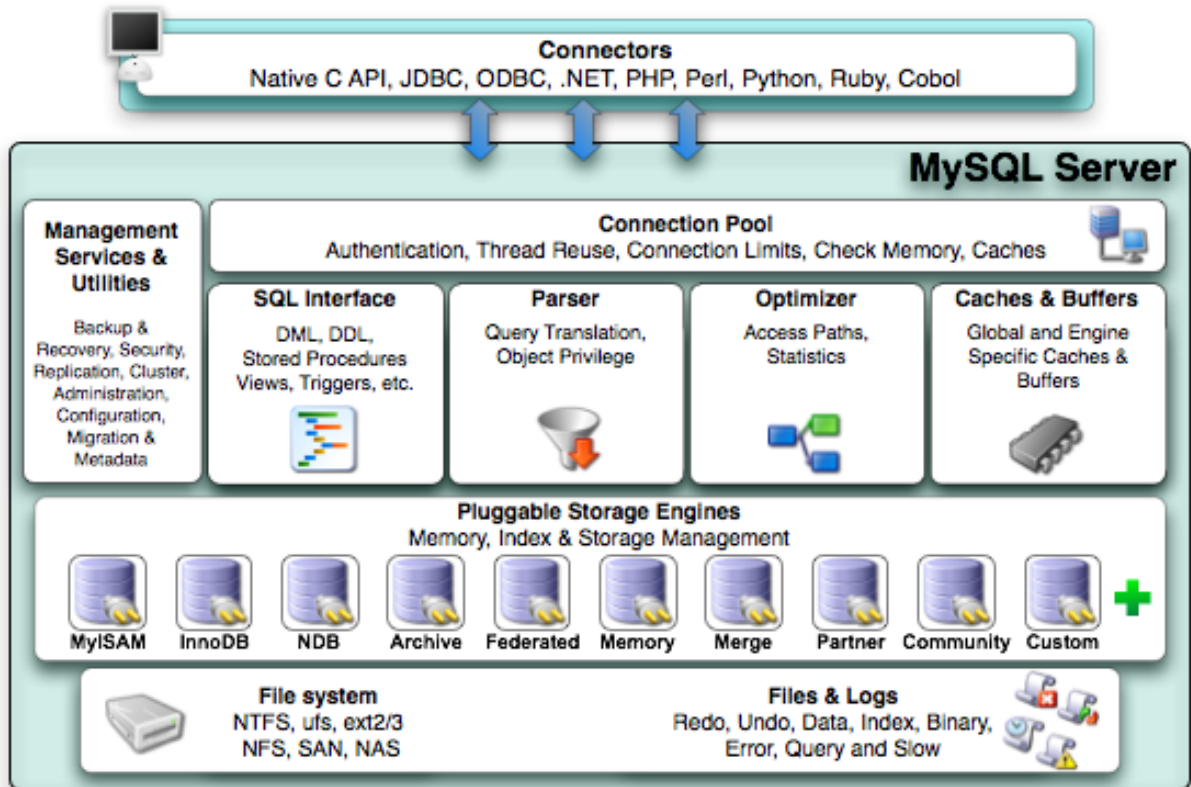
For answers to some commonly asked questions about MySQL storage engines, see [Section A.2, “MySQL 5.1 FAQ — Storage Engines”](#).

## 13.1. Overview of MySQL Storage Engine Architecture

The MySQL pluggable storage engine architecture allows a database professional to select a specialized storage engine for a particular application need while being completely shielded from the need to manage any specific application coding requirements. The MySQL server architecture isolates the application programmer and DBA from all of the low-level implementation details at the storage level, providing a consistent and easy application model and API. Thus, although there are different capabilities across different storage engines, the application is shielded from these differences.

The MySQL pluggable storage engine architecture is shown in [Figure 13.1, “The MySQL architecture using pluggable storage engines”](#).

**Figure 13.1. The MySQL architecture using pluggable storage engines**



The pluggable storage engine architecture provides a standard set of management and support services that are common among all underlying storage engines. The storage engines themselves are the components of the database server that actually perform actions on the underlying data that is maintained at the physical server level.

This efficient and modular architecture provides huge benefits for those wishing to specifically target a particular application need — such as data warehousing, transaction processing, or high availability situations — while enjoying the advantage of utilizing a set of interfaces and services that are independent of any one storage engine.

The application programmer and DBA interact with the MySQL database through Connector APIs and service layers that are above the storage engines. If application changes bring about requirements that demand the underlying storage engine change, or that one or more additional storage engines be added to support new needs, no significant coding or process changes are required to make things work. The MySQL server architecture shields the application from the underlying complexity of the storage engine by presenting a consistent and easy-to-use API that applies across storage engines.

### 13.1.1. The Common Database Server Layer

A MySQL pluggable storage engine is the component in the MySQL database server that is responsible for performing the actual data I/O operations for a database as well as enabling and enforcing certain feature sets that target a specific application need. A major benefit of using specific storage engines is that you are only delivered the features needed for a particular application, and therefore you have less system overhead in the database, with the end result being more efficient and higher database performance. This is one of the reasons that MySQL has always been known to have such high performance, matching or beating proprietary monolithic databases in industry standard benchmarks.

From a technical perspective, what are some of the unique supporting infrastructure components that are in a storage engine? Some of the key feature differentiations include:

- *Concurrency* — some applications have more granular lock requirements (such as row-level locks) than others. Choosing the right locking strategy can reduce overhead and therefore improve overall performance. This area also includes support for capabilities such as multi-version concurrency control or “snapshot” read.
- *Transaction Support* — Not every application needs transactions, but for those that do, there are very well defined requirements such as ACID compliance and more.
- *Referential Integrity* — The need to have the server enforce relational database referential integrity through DDL defined for-



eign keys.

- *Physical Storage* — This involves everything from the overall page size for tables and indexes as well as the format used for storing data to physical disk.
- *Index Support* — Different application scenarios tend to benefit from different index strategies. Each storage engine generally has its own indexing methods, although some (such as B-tree indexes) are common to nearly all engines.
- *Memory Caches* — Different applications respond better to some memory caching strategies than others, so although some memory caches are common to all storage engines (such as those used for user connections or MySQL's high-speed Query Cache), others are uniquely defined only when a particular storage engine is put in play.
- *Performance Aids* — This includes multiple I/O threads for parallel operations, thread concurrency, database checkpointing, bulk insert handling, and more.
- *Miscellaneous Target Features* — This may include support for geospatial operations, security restrictions for certain data manipulation operations, and other similar features.

Each set of the pluggable storage engine infrastructure components are designed to offer a selective set of benefits for a particular application. Conversely, avoiding a set of component features helps reduce unnecessary overhead. It stands to reason that understanding a particular application's set of requirements and selecting the proper MySQL storage engine can have a dramatic impact on overall system efficiency and performance.

## 13.1.2. Pluggable Storage Engine Architecture

With MySQL 5.1, MySQL AB has introduced a new pluggable storage engine architecture that allows storage engines to be loaded into and unloaded from a running MySQL server.

### Plugging in a Storage Engine

Before a storage engine can be used, the storage engine plugin shared library must be loaded into MySQL using the `INSTALL PLUGIN` statement. For example, if the `EXAMPLE` engine plugin is named `ha_example` and the shared library is named `ha_example.so`, you load it with the following statement:

```
mysql> INSTALL PLUGIN ha_example SONAME 'ha_example.so';
```

To install a pluggable storage engine, the plugin file must be located in the MySQL plugin directory, and the user issuing the `INSTALL PLUGIN` statement must have the `INSERT` privilege for the `mysql.plugin` table.

The shared library must be located in the MySQL server plugin directory, the location of which is given by the `plugin_dir` system variable.

### Unplugging a Storage Engine

To unplug a storage engine, use the `UNINSTALL PLUGIN` statement:

```
mysql> UNINSTALL PLUGIN ha_example;
```

If you unplug a storage engine that is needed by existing tables, those tables become inaccessible, but will still be present on disk (where applicable). Ensure that there are no tables using a storage engine before you unplug the storage engine.

## 13.2. Supported Storage Engines

MySQL 5.1 supports the following storage engines:

- **MyISAM** — The default MySQL storage engine and the one that is used the most in Web, data warehousing, and other application environments. **MyISAM** is supported in all MySQL configurations, and is the default storage engine unless you have configured MySQL to use a different one by default.
- **InnoDB** — A transaction-safe (ACID compliant) storage engine for MySQL that has commit, rollback, and crash-recovery capabilities to protect user data. **InnoDB** row-level locking (without escalation to coarser granularity locks) and Oracle-style consistent non-locking reads increase multi-user concurrency and performance. **InnoDB** stores user data in clustered indexes to reduce I/O for common queries based on primary keys. To maintain data integrity, **InnoDB** also supports **FOREIGN KEY** referential-integrity constraints.
- **Memory** — Stores all data in RAM for extremely fast access in environments that require quick lookups of reference and other like data. This engine was formerly known as the **HEAP** engine.

- **Merge** — Allows a MySQL DBA or developer to logically group a series of identical **MyISAM** tables and reference them as one object. Good for VLDB environments such as data warehousing.
- **Archive** — Provides the perfect solution for storing and retrieving large amounts of seldom-referenced historical, archived, or security audit information.
- **Federated** — Offers the ability to link separate MySQL servers to create one logical database from many physical servers. Very good for distributed or data mart environments.
- **NDB** — The Clustered database engine that is particularly suited for applications with high performance lookup needs that also require the highest possible degree of uptime and availability.
- **CSV** — The CSV storage engine stores data in text files using comma-separated values format. You can use the CSV engine to easily exchange data between other software and applications that can import and export in CSV format.
- **Blackhole** — The Blackhole storage engine accepts but does not store data and retrievals always return an empty set. The functionality can be used in distributed database design where data is automatically replicated, but not stored locally.
- **Example** — The Example storage engine is “stub” engine that does nothing. You can create tables with this engine, but no data can be stored in them or retrieved from them. The purpose of this engine is to serve as an example in the MySQL source code that illustrates how to begin writing new storage engines. As such, it is primarily of interest to developers.

This chapter describes each of the MySQL storage engines except for **NDBCLUSTER**, which is covered in [MySQL Cluster NDB 6.X/7.X](#).

It is important to remember that you are not restricted to using the same storage engine for an entire server or schema: you can use a different storage engine for each table in your schema.

### 13.2.1. Choosing a Storage Engine

The various storage engines provided with MySQL are designed with different use-cases in mind. To use the pluggable storage architecture effectively, it is good to have an idea of the advantages and disadvantages of the various storage engines. The following table provides an overview of some storage engines provided with MySQL:

Feature	MyISAM	Memory	InnoDB	Archive	NDB
Storage limits	256TB	Yes	64TB	No	384EB <sup>a</sup>
Transactions	No	No	Yes	No	Yes
Locking granularity	Table	Table	Row	Row	Row
MVCC (snapshot read)	No	No	Yes	Yes	No
Geospatial datatype support	Yes	No	Yes	Yes	Yes
Geospatial indexing support	Yes	No	No	No	No
B-tree indexes	Yes	Yes	Yes	No	Yes
Hash indexes	No	Yes	No	No	Yes
Full-text search indexes	Yes	No	No	No	No
Clustered indexes	No	No	Yes	No	No
Data caches	No	N/A	Yes	No	Yes
Index caches	Yes	N/A	Yes	No	Yes
Compressed data	Yes <sup>b</sup>	No	No	Yes	No
Encrypted data <sup>c</sup>	Yes	Yes	Yes	Yes	Yes
Cluster database support	No	No	No	No	Yes
Replication support <sup>d</sup>	Yes	Yes	Yes	Yes	Yes
Foreign key support	No	No	Yes	No	No
Backup / point-in-time recovery <sup>e</sup>	Yes	Yes	Yes	Yes	Yes
Query cache support	Yes	Yes	Yes	Yes	Yes
Update statistics for data dictionary	Yes	Yes	Yes	Yes	Yes

<sup>a</sup> EB = exabyte (1024 \* 1024 terabyte)

<sup>b</sup> Compressed MyISAM tables are only supported when using the compressed row format. Tables using the compressed row format with MyISAM are read only.

<sup>c</sup> Implemented in the server (via encryption functions), rather than in the storage engine.

<sup>d</sup> Implemented in the server, rather than in the storage engine

<sup>e</sup> Implemented in the server, rather than in the storage engine

## 13.2.2. Comparing Transaction and Non-Transaction Engines

Transaction-safe tables (TSTs) have several advantages over non-transaction-safe tables (NTSTs):

- They are safer. Even if MySQL crashes or you get hardware problems, you can get your data back, either by automatic recovery or from a backup plus the transaction log.
- You can combine many statements and accept them all at the same time with the `COMMIT` statement (if autocommit is disabled).
- You can execute `ROLLBACK` to ignore your changes (if autocommit is disabled).
- If an update fails, all of your changes are reverted. (With non-transaction-safe tables, all changes that have taken place are permanent.)
- Transaction-safe storage engines can provide better concurrency for tables that get many updates concurrently with reads.

You can combine transaction-safe and non-transaction-safe tables in the same statements to get the best of both worlds. However, although MySQL supports several transaction-safe storage engines, for best results, you should not mix different storage engines within a transaction with autocommit disabled. For example, if you do this, changes to non-transaction-safe tables still are committed immediately and cannot be rolled back. For information about this and other problems that can occur in transactions that use mixed storage engines, see [Section 12.4.1, “START TRANSACTION, COMMIT, and ROLLBACK Syntax”](#).

Non-transaction-safe tables have several advantages of their own, all of which occur because there is no transaction overhead:

- Much faster
- Lower disk space requirements
- Less memory required to perform updates

## 13.2.3. Other Storage Engines

Other storage engines may be available from third parties and community members that have used the Custom Storage Engine interface.

You can find more information on the list of third party storage engines on the [MySQL Forge Storage Engines](#) page.

### Note

Third party engines are not supported by MySQL. For further information, documentation, installation guides, bug reporting or for any help or assistance with these engines, please contact the developer of the engine directly.

Third party engines that are known to be available include the following; please see the MySQL Forge links provided for more information:

- **PrimeBase XT (PBXT)** — PBXT has been designed for modern, web-based, high concurrency environments.
- **RitmarkFS** — RitmarkFS allows you to access and manipulate the file system using SQL queries. RitmarkFS also supports file system replication and directory change tracking.
- **Distributed Data Engine** — The Distributed Data Engine is an Open Source project that is dedicated to provide a Storage Engine for distributed data according to workload statistics.
- **mdbtools** — A pluggable storage engine that allows read-only access to Microsoft Access `.mdb` database files.
- **solidDB for MySQL** — solidDB Storage Engine for MySQL is an open source, transactional storage engine for MySQL Server. It is designed for mission-critical implementations that require a robust, transactional database. solidDB Storage Engine for MySQL is a multi-threaded storage engine that supports full ACID compliance with all expected transaction isolation levels, row-level locking, and Multi-Version Concurrency Control (MVCC) with non-blocking reads and writes.
- **BLOB Streaming Engine (MyBS)** — The Scalable BLOB Streaming infrastructure for MySQL will transform MySQL into a scalable media server capable of streaming pictures, films, MP3 files and other binary and text objects (BLOBs) directly in and

out of the database.

For more information on developing a custom storage engine that can be used with the Pluggable Storage Engine Architecture, see [Writing a Custom Storage Engine](#) on [MySQL Forge](#).

## 13.3. Setting the Storage Engine

When you create a new table, you can specify which storage engine to use by adding an `ENGINE` table option to the `CREATE TABLE` statement:

```
CREATE TABLE t (i INT) ENGINE = INNODB;
```

If you omit the `ENGINE` or `TYPE` option, the default storage engine is used. Normally, this is `MyISAM`, but you can change it by using the `--default-storage-engine` or `--default-table-type` server startup option, or by setting the `default-storage-engine` or `default-table-type` option in the `my.cnf` configuration file.

You can set the default storage engine to be used during the current session by setting the `storage_engine` variable:

```
SET storage_engine=MYISAM;
```

When MySQL is installed on Windows using the MySQL Configuration Wizard, the `InnoDB` storage engine can be selected as the default instead of `MyISAM`. See [Section 2.3.4.5, “The Database Usage Dialog”](#).

To convert a table from one storage engine to another, use an `ALTER TABLE` statement that indicates the new engine:

```
ALTER TABLE t ENGINE = MYISAM;
```

See [Section 12.1.17, “CREATE TABLE Syntax”](#), and [Section 12.1.7, “ALTER TABLE Syntax”](#).

If you try to use a storage engine that is not compiled in or that is compiled in but deactivated, MySQL instead creates a table using the default storage engine, usually `MyISAM`. This behavior is convenient when you want to copy tables between MySQL servers that support different storage engines. (For example, in a replication setup, perhaps your master server supports transactional storage engines for increased safety, but the slave servers use only non-transactional storage engines for greater speed.)

This automatic substitution of the default storage engine for unavailable engines can be confusing for new MySQL users. A warning is generated whenever a storage engine is automatically changed.

For new tables, MySQL always creates an `.frm` file to hold the table and column definitions. The table's index and data may be stored in one or more other files, depending on the storage engine. The server creates the `.frm` file above the storage engine level. Individual storage engines create any additional files required for the tables that they manage. If a table name contains special characters, the names for the table files contain encoded versions of those characters as described in [Section 8.2.3, “Mapping of Identifiers to File Names”](#).

A database may contain tables of different types. That is, tables need not all be created with the same storage engine.

## 13.4. The `MyISAM` Storage Engine

`MyISAM` is the default storage engine. It is based on the older `ISAM` code but has many useful extensions. (Note that MySQL 5.1 does *not* support `ISAM`.)

**Table 13.1. MyISAM Features**

<b>Storage limits</b>	256TB	<b>Transactions</b>	No	<b>Locking granularity</b>	Table
<b>MVCC</b>	No	<b>Geospatial datatype support</b>	Yes	<b>Geospatial indexing support</b>	Yes
<b>B-tree indexes</b>	Yes	<b>Hash indexes</b>	No	<b>Full-text search indexes</b>	Yes
<b>Clustered indexes</b>	No	<b>Data caches</b>	No	<b>Index caches</b>	Yes
<b>Compressed data</b>	Yes <sup>a</sup>	<b>Encrypted data<sup>b</sup></b>	Yes	<b>Cluster database support</b>	No
<b>Replication support<sup>c</sup></b>	Yes	<b>Foreign key support</b>	No	<b>Backup / point-in-time recovery<sup>d</sup></b>	Yes
<b>Query cache support</b>	Yes	<b>Update statistics for data dictionary</b>	Yes		

<sup>a</sup>Compressed `MyISAM` tables are supported only when using the compressed row format. Tables using the compressed row format with `MyISAM` are read only.

<sup>b</sup>Implemented in the server (via encryption functions), rather than in the storage engine.

<sup>c</sup>Implemented in the server, rather than in the storage engine

<sup>d</sup>Implemented in the server, rather than in the storage engine

Each `MyISAM` table is stored on disk in three files. The files have names that begin with the table name and have an extension to indicate the file type. An `.frm` file stores the table format. The data file has an `.MYD` (`MYData`) extension. The index file has an `.MYI` (`MYIndex`) extension.

To specify explicitly that you want a `MyISAM` table, indicate that with an `ENGINE` table option:

```
CREATE TABLE t (i INT) ENGINE = MYISAM;
```

Normally, it is unnecessary to use `ENGINE` to specify the `MyISAM` storage engine. `MyISAM` is the default engine unless the default has been changed. To ensure that `MyISAM` is used in situations where the default might have been changed, include the `ENGINE` option explicitly.

You can check or repair `MyISAM` tables with the `mysqlcheck` client or `myisamchk` utility. You can also compress `MyISAM` tables with `myisampack` to take up much less space. See [Section 4.5.3, “mysqlcheck — A Table Maintenance Program”](#), [Section 6.4.1, “Using myisamchk for Crash Recovery”](#), and [Section 4.6.5, “myisampack — Generate Compressed, Read-Only MyISAM Tables”](#).

`MyISAM` tables have the following characteristics:

- All data values are stored with the low byte first. This makes the data machine and operating system independent. The only requirements for binary portability are that the machine uses two's-complement signed integers and IEEE floating-point format. These requirements are widely used among mainstream machines. Binary compatibility might not be applicable to embedded systems, which sometimes have peculiar processors.

There is no significant speed penalty for storing data low byte first; the bytes in a table row normally are unaligned and it takes little more processing to read an unaligned byte in order than in reverse order. Also, the code in the server that fetches column values is not time critical compared to other code.

- All numeric key values are stored with the high byte first to allow better index compression.
- Large files (up to 63-bit file length) are supported on file systems and operating systems that support large files.
- There is a limit of  $2^{32}$  (~4.295E+09) rows in a `MyISAM` table. If you build MySQL with the `--with-big-tables` option, the row limitation is increased to  $(2^{32})^2$  (1.844E+19) rows. See [Section 2.10.2, “Typical configure Options”](#). Binary distributions for Unix and Linux are built with this option.
- The maximum number of indexes per `MyISAM` table is 64. This can be changed by recompiling. Beginning with MySQL 5.1.4, you can configure the build by invoking `configure` with the `--with-max-indexes=N` option, where `N` is the maximum number of indexes to permit per `MyISAM` table. `N` must be less than or equal to 128. Before MySQL 5.1.4, you must change the source.

The maximum number of columns per index is 16.

- The maximum key length is 1000 bytes. This can also be changed by changing the source and recompiling. For the case of a key longer than 250 bytes, a larger key block size than the default of 1024 bytes is used.
- When rows are inserted in sorted order (as when you are using an `AUTO_INCREMENT` column), the index tree is split so that the high node only contains one key. This improves space utilization in the index tree.
- Internal handling of one `AUTO_INCREMENT` column per table is supported. `MyISAM` automatically updates this column for `INSERT` and `UPDATE` operations. This makes `AUTO_INCREMENT` columns faster (at least 10%). Values at the top of the sequence are not reused after being deleted. (When an `AUTO_INCREMENT` column is defined as the last column of a multiple-column index, reuse of values deleted from the top of a sequence does occur.) The `AUTO_INCREMENT` value can be reset with `ALTER TABLE` or `myisamchk`.
- Dynamic-sized rows are much less fragmented when mixing deletes with updates and inserts. This is done by automatically combining adjacent deleted blocks and by extending blocks if the next block is deleted.
- `MyISAM` supports concurrent inserts: If a table has no free blocks in the middle of the data file, you can `INSERT` new rows into it at the same time that other threads are reading from the table. A free block can occur as a result of deleting rows or an update of a dynamic length row with more data than its current contents. When all free blocks are used up (filled in), future inserts become concurrent again. See [Section 7.3.3, “Concurrent Inserts”](#).
- You can put the data file and index file in different directories on different physical devices to get more speed with the `DATA DIRECTORY` and `INDEX DIRECTORY` table options to `CREATE TABLE`. See [Section 12.1.17, “CREATE TABLE Syntax”](#).
- `BLOB` and `TEXT` columns can be indexed.

- `NULL` values are allowed in indexed columns. This takes 0–1 bytes per key.
- Each character column can have a different character set. See [Section 9.1, “Character Set Support”](#).
- There is a flag in the `MyISAM` index file that indicates whether the table was closed correctly. If `mysqld` is started with the `--myisam-recover` option, `MyISAM` tables are automatically checked when opened, and are repaired if the table wasn't closed properly.
- `myisamchk` marks tables as checked if you run it with the `--update-state` option. `myisamchk --fast` checks only those tables that don't have this mark.
- `myisamchk --analyze` stores statistics for portions of keys, as well as for entire keys.
- `myisampack` can pack `BLOB` and `VARCHAR` columns.

`MyISAM` also supports the following features:

- Support for a true `VARCHAR` type; a `VARCHAR` column starts with a length stored in one or two bytes.
- Tables with `VARCHAR` columns may have fixed or dynamic row length.
- The sum of the lengths of the `VARCHAR` and `CHAR` columns in a table may be up to 64KB.
- Arbitrary length `UNIQUE` constraints.

#### Additional resources

- A forum dedicated to the `MyISAM` storage engine is available at <http://forums.mysql.com/list.php?21>.

## 13.4.1. `MyISAM` Startup Options

The following options to `mysqld` can be used to change the behavior of `MyISAM` tables. For additional information, see [Section 5.1.2, “Server Command Options”](#).

**Table 13.2. `mysqld` `MyISAM` Option/Variable Reference**

Name	Cmd-Line	Option file	System Var	Status Var	Var Scope	Dynamic
<code>bulk_insert_buffer_size</code>	Yes	Yes	Yes		Both	Yes
<code>concurrent_insert</code>	Yes	Yes	Yes		Global	Yes
<code>delay-key-write</code>	Yes	Yes			Global	Yes
- Variable: <code>delay_key_write</code>			Yes		Global	Yes
<code>have_rtree_keys</code>			Yes		Global	No
<code>key_buffer_size</code>	Yes	Yes	Yes		Global	Yes
<code>log-isam</code>	Yes	Yes				
<code>myisam-block-size</code>	Yes	Yes				
<code>myisam_data_pointer_size</code>	Yes	Yes	Yes		Global	Yes
<code>myisam_max_sort_file_size</code>	Yes	Yes	Yes		Global	Yes
<code>myisam-recover</code>	Yes	Yes				
<code>myisam_recover_options</code>			Yes		Global	No
<code>myisam_repair_threads</code>	Yes	Yes	Yes		Both	Yes
<code>myisam_sort_buffer_size</code>	Yes	Yes	Yes		Both	Yes
<code>myisam_stats_method</code>	Yes	Yes	Yes		Both	Yes
<code>myisam_use_mmap</code>	Yes	Yes	Yes		Global	Yes
<code>skip-concurrent-insert</code>	Yes	Yes				
- Variable: <code>concurrent_insert</code>						
<code>tmp_table_size</code>	Yes	Yes	Yes		Both	Yes

- `--myisam-recover=mode`

Set the mode for automatic recovery of crashed `MyISAM` tables.

- `--delay-key-write=ALL`

Don't flush key buffers between writes for any `MyISAM` table.

### Note

If you do this, you should not access `MyISAM` tables from another program (such as from another MySQL server or with `myisamchk`) when the tables are in use. Doing so risks index corruption. Using `--external-locking` does not eliminate this risk.

The following system variables affect the behavior of `MyISAM` tables. For additional information, see [Section 5.1.3, “Server System Variables”](#).

- `bulk_insert_buffer_size`

The size of the tree cache used in bulk insert optimization.

### Note

This is a limit *per thread*!

- `myisam_max_sort_file_size`

The maximum size of the temporary file that MySQL is allowed to use while re-creating a `MyISAM` index (during `REPAIR TABLE`, `ALTER TABLE`, or `LOAD DATA INFILE`). If the file size would be larger than this value, the index is created using the key cache instead, which is slower. The value is given in bytes.

- `myisam_sort_buffer_size`

Set the size of the buffer used when recovering tables.

Automatic recovery is activated if you start `mysqld` with the `--myisam-recover` option. In this case, when the server opens a `MyISAM` table, it checks whether the table is marked as crashed or whether the open count variable for the table is not 0 and you are running the server with external locking disabled. If either of these conditions is true, the following happens:

- The server checks the table for errors.
- If the server finds an error, it tries to do a fast table repair (with sorting and without re-creating the data file).
- If the repair fails because of an error in the data file (for example, a duplicate-key error), the server tries again, this time re-creating the data file.
- If the repair still fails, the server tries once more with the old repair option method (write row by row without sorting). This method should be able to repair any type of error and has low disk space requirements.

### MySQL Enterprise

Subscribers to MySQL Enterprise Monitor receive notification if the `--myisam-recover` option has not been set. For more information, see <http://www.mysql.com/products/enterprise/advisors.html>.

If the recovery wouldn't be able to recover all rows from previously completed statements and you didn't specify `FORCE` in the value of the `--myisam-recover` option, automatic repair aborts with an error message in the error log:

```
Error: Couldn't repair table: test.g00pages
```

If you specify `FORCE`, a warning like this is written instead:

```
Warning: Found 344 of 354 rows when repairing ./test/g00pages
```

Note that if the automatic recovery value includes `BACKUP`, the recovery process creates files with names of the form `tbl_name-datetime.BAK`. You should have a `cron` script that automatically moves these files from the database directories to backup media.



## 13.4.2. Space Needed for Keys

**MyISAM** tables use B-tree indexes. You can roughly calculate the size for the index file as  $(key\_length+4)/0.67$ , summed over all keys. This is for the worst case when all keys are inserted in sorted order and the table doesn't have any compressed keys.

String indexes are space compressed. If the first index part is a string, it is also prefix compressed. Space compression makes the index file smaller than the worst-case figure if a string column has a lot of trailing space or is a **VARCHAR** column that is not always used to the full length. Prefix compression is used on keys that start with a string. Prefix compression helps if there are many strings with an identical prefix.

In **MyISAM** tables, you can also prefix compress numbers by specifying the `PACK_KEYS=1` table option when you create the table. Numbers are stored with the high byte first, so this helps when you have many integer keys that have an identical prefix.

## 13.4.3. MyISAM Table Storage Formats

**MyISAM** supports three different storage formats. Two of them, fixed and dynamic format, are chosen automatically depending on the type of columns you are using. The third, compressed format, can be created only with the `mysampack` utility (see [Section 4.6.5, “mysampack — Generate Compressed, Read-Only MyISAM Tables”](#)).

When you use `CREATE TABLE` or `ALTER TABLE` for a table that has no **BLOB** or **TEXT** columns, you can force the table format to `FIXED` or `DYNAMIC` with the `ROW_FORMAT` table option.

See [Section 12.1.17, “CREATE TABLE Syntax”](#), for information about `ROW_FORMAT`.

You can decompress (unpack) compressed **MyISAM** tables using `mysamchk --unpack`; see [Section 4.6.3, “mysamchk — MyISAM Table-Maintenance Utility”](#), for more information.

### 13.4.3.1. Static (Fixed-Length) Table Characteristics

Static format is the default for **MyISAM** tables. It is used when the table contains no variable-length columns (**VARCHAR**, **VARBINARY**, **BLOB**, or **TEXT**). Each row is stored using a fixed number of bytes.

Of the three **MyISAM** storage formats, static format is the simplest and most secure (least subject to corruption). It is also the fastest of the on-disk formats due to the ease with which rows in the data file can be found on disk: To look up a row based on a row number in the index, multiply the row number by the row length to calculate the row position. Also, when scanning a table, it is very easy to read a constant number of rows with each disk read operation.

The security is evidenced if your computer crashes while the MySQL server is writing to a fixed-format **MyISAM** file. In this case, `mysamchk` can easily determine where each row starts and ends, so it can usually reclaim all rows except the partially written one. Note that **MyISAM** table indexes can always be reconstructed based on the data rows.

#### Note

Fixed-length row format is only available for tables without **BLOB** or **TEXT** columns. Creating a table with these columns with an explicit `ROW_FORMAT` clause will not raise an error or warning; the format specification will be ignored.

Static-format tables have these characteristics:

- **CHAR** and **VARCHAR** columns are space-padded to the specified column width, although the column type is not altered. **BINARY** and **VARBINARY** columns are padded with `0x00` bytes to the column width.
- Very quick.
- Easy to cache.
- Easy to reconstruct after a crash, because rows are located in fixed positions.
- Reorganization is unnecessary unless you delete a huge number of rows and want to return free disk space to the operating system. To do this, use `OPTIMIZE TABLE` or `mysamchk -r`.
- Usually require more disk space than dynamic-format tables.

### 13.4.3.2. Dynamic Table Characteristics

Dynamic storage format is used if a **MyISAM** table contains any variable-length columns (**VARCHAR**, **VARBINARY**, **BLOB**, or **TEXT**), or if the table was created with the `ROW_FORMAT=DYNAMIC` table option.



Dynamic format is a little more complex than static format because each row has a header that indicates how long it is. A row can become fragmented (stored in non-contiguous pieces) when it is made longer as a result of an update.

You can use `OPTIMIZE TABLE` or `myisamchk -r` to defragment a table. If you have fixed-length columns that you access or change frequently in a table that also contains some variable-length columns, it might be a good idea to move the variable-length columns to other tables just to avoid fragmentation.

Dynamic-format tables have these characteristics:

- All string columns are dynamic except those with a length less than four.
- Each row is preceded by a bitmap that indicates which columns contain the empty string (for string columns) or zero (for numeric columns). Note that this does not include columns that contain `NULL` values. If a string column has a length of zero after trailing space removal, or a numeric column has a value of zero, it is marked in the bitmap and not saved to disk. Non-empty strings are saved as a length byte plus the string contents.
- Much less disk space usually is required than for fixed-length tables.
- Each row uses only as much space as is required. However, if a row becomes larger, it is split into as many pieces as are required, resulting in row fragmentation. For example, if you update a row with information that extends the row length, the row becomes fragmented. In this case, you may have to run `OPTIMIZE TABLE` or `myisamchk -r` from time to time to improve performance. Use `myisamchk -ei` to obtain table statistics.
- More difficult than static-format tables to reconstruct after a crash, because rows may be fragmented into many pieces and links (fragments) may be missing.
- The expected row length for dynamic-sized rows is calculated using the following expression:

```
3
+ (number of columns + 7) / 8
+ (number of char columns)
+ (packed size of numeric columns)
+ (length of strings)
+ (number of NULL columns + 7) / 8
```

There is a penalty of 6 bytes for each link. A dynamic row is linked whenever an update causes an enlargement of the row. Each new link is at least 20 bytes, so the next enlargement probably goes in the same link. If not, another link is created. You can find the number of links using `myisamchk -ed`. All links may be removed with `OPTIMIZE TABLE` or `myisamchk -r`.

### 13.4.3.3. Compressed Table Characteristics

Compressed storage format is a read-only format that is generated with the `mysampack` tool. Compressed tables can be uncompressed with `myisamchk`.

Compressed tables have the following characteristics:

- Compressed tables take very little disk space. This minimizes disk usage, which is helpful when using slow disks (such as CD-ROMs).
- Each row is compressed separately, so there is very little access overhead. The header for a row takes up one to three bytes depending on the biggest row in the table. Each column is compressed differently. There is usually a different Huffman tree for each column. Some of the compression types are:
  - Suffix space compression.
  - Prefix space compression.
  - Numbers with a value of zero are stored using one bit.
  - If values in an integer column have a small range, the column is stored using the smallest possible type. For example, a `BIGINT` column (eight bytes) can be stored as a `TINYINT` column (one byte) if all its values are in the range from `-128` to `127`.
  - If a column has only a small set of possible values, the data type is converted to `ENUM`.
  - A column may use any combination of the preceding compression types.
- Can be used for fixed-length or dynamic-length rows.

**Note**

While a compressed table is read only, and you cannot therefore update or add rows in the table, DDL (Data Definition Language) operations are still valid. For example, you may still use `DROP` to drop the table, and `TRUNCATE` to empty the table.

### 13.4.4. MyISAM Table Problems

The file format that MySQL uses to store data has been extensively tested, but there are always circumstances that may cause database tables to become corrupted. The following discussion describes how this can happen and how to handle it.

#### 13.4.4.1. Corrupted MyISAM Tables

Even though the MyISAM table format is very reliable (all changes to a table made by an SQL statement are written before the statement returns), you can still get corrupted tables if any of the following events occur:

- The `mysqld` process is killed in the middle of a write.
- An unexpected computer shutdown occurs (for example, the computer is turned off).
- Hardware failures.
- You are using an external program (such as `myisamchk`) to modify a table that is being modified by the server at the same time.
- A software bug in the MySQL or MyISAM code.

Typical symptoms of a corrupt table are:

- You get the following error while selecting data from the table:

```
Incorrect key file for table: '...'. Try to repair it
```

- Queries don't find rows in the table or return incomplete results.

You can check the health of a MyISAM table using the `CHECK TABLE` statement, and repair a corrupted MyISAM table with `REPAIR TABLE`. When `mysqld` is not running, you can also check or repair a table with the `myisamchk` command. See [Section 12.5.2.3, “CHECK TABLE Syntax”](#), [Section 12.5.2.6, “REPAIR TABLE Syntax”](#), and [Section 4.6.3, “myisamchk — MyISAM Table-Maintenance Utility”](#).

If your tables become corrupted frequently, you should try to determine why this is happening. The most important thing to know is whether the table became corrupted as a result of a server crash. You can verify this easily by looking for a recent `restarted mysqld` message in the error log. If there is such a message, it is likely that table corruption is a result of the server dying. Otherwise, corruption may have occurred during normal operation. This is a bug. You should try to create a reproducible test case that demonstrates the problem. See [Section B.1.4.2, “What to Do If MySQL Keeps Crashing”](#), and [MySQL Internals: Porting](#).

**MySQL Enterprise**

Find out about problems before they occur. Subscribe to the MySQL Enterprise Monitor for expert advice about the state of your servers. For more information, see <http://www.mysql.com/products/enterprise/advisors.html>.

#### 13.4.4.2. Problems from Tables Not Being Closed Properly

Each MyISAM index file (`.MYI` file) has a counter in the header that can be used to check whether a table has been closed properly. If you get the following warning from `CHECK TABLE` or `myisamchk`, it means that this counter has gone out of sync:

```
clients are using or haven't closed the table properly
```

This warning doesn't necessarily mean that the table is corrupted, but you should at least check the table.

The counter works as follows:

- The first time a table is updated in MySQL, a counter in the header of the index files is incremented.

- The counter is not changed during further updates.
- When the last instance of a table is closed (because a `FLUSH TABLES` operation was performed or because there is no room in the table cache), the counter is decremented if the table has been updated at any point.
- When you repair the table or check the table and it is found to be okay, the counter is reset to zero.
- To avoid problems with interaction with other processes that might check the table, the counter is not decremented on close if it was zero.

In other words, the counter can become incorrect only under these conditions:

- A `MyISAM` table is copied without first issuing `LOCK TABLES` and `FLUSH TABLES`.
- MySQL has crashed between an update and the final close. (Note that the table may still be okay, because MySQL always issues writes for everything between each statement.)
- A table was modified by `myisamchk --recover` or `myisamchk --update-state` at the same time that it was in use by `mysqld`.
- Multiple `mysqld` servers are using the table and one server performed a `REPAIR TABLE` or `CHECK TABLE` on the table while it was in use by another server. In this setup, it is safe to use `CHECK TABLE`, although you might get the warning from other servers. However, `REPAIR TABLE` should be avoided because when one server replaces the data file with a new one, this is not known to the other servers.

In general, it is a bad idea to share a data directory among multiple servers. See [Section 5.6, “Running Multiple MySQL Servers on the Same Machine”](#), for additional discussion.

## 13.5. The `Maria` Storage Engine

`Maria` is a crash safe version of `MyISAM`. The `Maria` storage engine supports all of the main functionality of the `MyISAM` engine, but includes recovery support (in the event of a system crash), full logging (including `CREATE`, `DROP`, `RENAME` and `TRUNCATE` operations), all `MyISAM` row formats and a new `Maria` specific row format.

`Maria` has been designed as a replacement for the `MyISAM` storage engine, supporting the speed and flexibility of the original `MyISAM` implementation, in combination with MVCC transaction support. Within the current release, a limited level of concurrency for `INSERT/UPDATE` and `SELECT` functionality is supported. For more information, see [Section 13.5.6, “Maria Statement Concurrency”](#).

For more information on known bugs and limitations in `Maria`, see [Section 13.5.9, “Maria Open Bugs”](#)

To create a `Maria` table you must specify the engine when using the `CREATE TABLE` statement:

```
mysql> CREATE TABLE maria_table (id int) ENGINE=Maria;
```

You can also use `ALTER TABLE` to convert an existing table to the `Maria` engine:

```
mysql> ALTER TABLE myisam_table ENGINE=Maria;
```

Data in `Maria` tables is stored in three files:

- `table.frm` — the standard MySQL FRM file containing the table definition.
- `table.MAD` — the `Maria` data file.
- `table.MAI` — the `Maria` index file.

In addition, `Maria` creates at least two additional files in your standard `datadir` directory:

- `maria_log.????????` — the `Maria` log file. Each file is named numerically and sequentially, with new files automatically created when the log file limit has been reached. You can control the log file size using `maria_log_file_size` option, and control the deletion of logs using `maria_log_purge_type`. The newly created files stay in place until deleted either automatically or manually.

- `maria_log_control` — a control file that holds information about the current state of the `Maria` engine.

### Warning

You should not delete the `maria_log_control` file from an active `Maria` installation as it records information about the current state of the `Maria` engine, including information about the log files and the default page block size used for the log and data files.

The basic functionality of `Maria` matches the functionality of `MyISAM` with a number of differences. These are:

- Two types of tables are supported. Non-crash safe tables (non-transactional) are written immediately to their corresponding data file. Transactional tables are crash safe and data is written into the `Maria` log. For more information on the log, see [Section 13.5.3, “Maria Transaction Log”](#). Data which had already been written to the log is then applied to the data and index files as the statement completes.
- `Maria` supports auto-recovery in the event of a crash. For more information, see [Section 13.5.4, “Maria Recovery”](#).
- `Maria` supports a single writer and multiple readers. The writer supports both `INSERT` and `UPDATE` operations. `MyISAM` supports only concurrent `INSERT` and `SELECT` statements. For more information, see [Section 13.5.6, “Maria Statement Concurrency”](#).
- `Maria` provides a new row format, `PAGE`. For more information, see [Section 13.5.2, “Maria Table Options”](#). Existing `MyISAM` row formats are also supported on non-transactional tables.
- `Maria` supports crash-safe operations over many statements by enclosing statements within `LOCK TABLES` and `UNLOCK TABLES` statements.

## 13.5.1. Maria Configuration

`Maria` supports a number of configuration options to control the operation and performance of the storage engine. Many of the options are similar to options that are already available within the `MyISAM` configuration options. See [Section 13.4, “The MyISAM Storage Engine”](#).

`Maria` command options:

**Table 13.3. `mysqld` Option/Variable Reference**

Name	Cmd-Line	Option file	System Var	Status Var	Var Scope	Dynamic
<code>maria</code>	Yes	Yes				
<code>maria-block-size</code>	Yes	Yes				No
- Variable: <code>maria_block_size</code>			Yes			No
<code>maria-checkpoint-interval</code>	Yes	Yes	Yes		Global	Yes
<code>maria-force-start-after-recovery-failures</code>	Yes	Yes				
<code>maria-log-dir-path</code>	Yes	Yes				
<code>maria-log-file-size</code>	Yes	Yes			Global	Yes
- Variable: <code>maria_log_file_size</code>			Yes		Global	Yes
<code>maria-log-purge-type</code>	Yes	Yes			Global	Yes
- Variable: <code>maria_log_purge_type</code>			Yes		Global	Yes
<code>maria-max-sort-file-size</code>	Yes	Yes	Yes		Global	Yes
<code>maria-page-checksum</code>	Yes	Yes			Global	Yes
- Variable: <code>maria_page_checksum</code>			Yes		Global	Yes
<code>maria-pagecache-age-threshold</code>	Yes	Yes			Global	Yes
- Variable: <code>maria_pagecache_age_threshold</code>			Yes		Global	Yes
<code>maria-pagecache-buffer-size</code>	Yes	Yes			Global	No
- Variable: <code>maria_pagecache_buffer_size</code>			Yes		Global	No
<code>maria-pagecache-division-limit</code>	Yes	Yes			Global	Yes
- Variable: <code>maria_pagecache_division_limit</code>			Yes		Global	Yes

Name	Cmd-Line	Option file	System Var	Status Var	Var Scope	Dynamic
<a href="#">maria-recover</a>	Yes	Yes			Global	Yes
- Variable: <code>maria_recover</code>			Yes		Global	Yes
<a href="#">maria-repair-threads</a>	Yes	Yes			Both	Yes
- Variable: <code>maria_repair_threads</code>			Yes		Both	Yes
<a href="#">maria-sort-buffer-size</a>	Yes	Yes			Both	Yes
- Variable: <code>maria_sort_buffer_size</code>			Yes		Both	Yes
<a href="#">maria-stats-method</a>	Yes	Yes			Both	Yes
- Variable: <code>maria_stats_method</code>			Yes		Both	Yes
<a href="#">maria-sync-log-dir</a>	Yes	Yes			Global	Yes
- Variable: <code>maria_sync_log_dir</code>			Yes		Global	Yes

- [maria](#) enables the [Maria](#) plugin. You can disable [Maria](#) by using `--skip-maria`.

Default is for the [Maria](#) plugin to be enabled.

#### Note

You cannot disable [Maria](#) if you have enabled [Maria](#) as the default engine for temporary tables using the `configure --with-maria-tmp-tables` option. If `--with-maria-tmp-tables` has been enabled it will be used for all temporary tables, including `INFORMATION_SCHEMA` tables.

- [maria-block-size](#)

Sets the block size to be used for [Maria](#) index pages and data pages for the new `PAGE` row format. Once the page size has been set the first time `mysqld` has been run, you cannot change the page size without recreating all your [Maria](#) tables.

#### Note

To change the block size of existing tables, you should use `mysqldump` to save a copy of the table data, cleanly shut-down `mysqld`, remove the `maria_log_control` file and associated logs, and reconfigure the block size before starting up `mysqld` again.

The configuration setting of this value is recorded within the `maria_log_control` file the first time MySQL is started with the [Maria](#) engine enabled.

The default size is 8192 (8KB).

- [maria-checkpoint-interval](#)

Sets the interval between automatic checkpoints. Checkpoints in [Maria](#) synchronize the in-memory and on-disk data and then collate information about the current status of different transactions, before writing the information about the current status to the [Maria](#) log. The use of checkpoints improves the ability and speed of [Maria](#) when recovering from a crash, as recovery can continue from the last stable checkpoint in the log, instead of replaying the entire log.

The default checkpoint interval is 30 seconds. You can disable checkpoints by setting the value to 0, but disabling checkpoints will increase the time taken to recover in the event of a failure. You should only set the value to 0 during testing.

#### Note

This parameter was previously known as `maria_check_interval`.

- [maria-force-start-after-recovery-failures](#)

Sets the maximum number of recovery operations to attempt before deleting the [Maria](#) log files and forcing `mysqld` to start. Recovery of the [Maria](#) tables using the log files may fail during startup, preventing `mysqld` from starting.

Setting `maria-force-start-after-recovery-failures` to a nonzero value forces [Maria](#) to check the recovery count within the [Maria](#) log control file. This value is incremented each time a recovery is attempted. If the number of attempts matches the value of `maria-force-start-after-recovery-failures`, then [Maria](#) will delete all the current log files before `mysqld` starts.

Because forcing a start without recovery leaves tables in an inconsistent state, you should only set `maria-force-start-after-recovery-failures` in conjunction with the `maria-recovery` option, which forces check-

ing and recovery of tables during startup without requiring the Maria log files.

The default value is 0.

### Note

Setting `maria-force-start-after-recovery` may increase the downtime and recovery time, as the recovery will be attempted a number of times before startup is forced. However, without it, `mysqld` will fail to start up if there are broken tables.

- `maria_log_dir_path`

Sets the path to the directory where the transactional log files and the log control file will be stored. You can set this to another device to improve performance.

The default value is to use the same directory as the `datadir` option.

### Note

This option is only available through the configuration or command-line. You cannot change the location of the log files while `mysqld` is running.

- `maria_log_file_size`

Sets the size of each of the Maria log files. When the log reaches this figure, a new log file (with a new sequential log file number) is created, and the `maria_log_control` file is updated.

The default size is 1GB. The minimum log file size is 8MB and the maximum log file size is (4GB - 8192 bytes)

- `maria_log_purge_type`

Specifies how the transactional log will be purged. Supported types are as follows:

- `at_flush` — the logs will be removed (deleted from disk) only when they have been marked 'free' (i.e. there are no pending transactions), and a `FLUSH LOGS` statement has been executed.
- `immediate` — the logs are deleted as soon as they no longer have pending transactions.
- `external` — the logs are not deleted automatically; it is assumed an external utility is responsible for actually deleting the logs. This can be used in combination with a backup solution to delete the logs only once a backup has been completed.

Default is `immediate`.

- `maria_max_sort_file_size`

Don't use the fast sort index method to create the index if the temporary file would get bigger than this size.

Default is the maximum file size.

- `maria_page_checksum`

Sets the default mode for page checksums. If a table has page checksums, then Maria will use the checksum to ensure that the page information is not corrupted. You can override page checksums on a table by table level by using the `PAGE_CHECKSUM` or `CHECKSUM` option during `CREATE TABLE`.

Default is for `maria_page_checksum` to be enabled.

- `maria_pagecache_age_threshold`

The number of hits that a hot block in the page cache has to be untouched until it is considered old enough to be downgraded to a warm block. Lower values cause demotion to happen more quickly.

The default is 300.

- `maria_pagecache_buffer_size`

Sets the size of the buffer used for data and index pages to Maria tables. You should increase this value to improve performance on data and index reads and writes, ideally to the maximum figure supported by your environment.

The default value is 8MB.

- `maria_pagecache_division_limit`  
The minimum percentage of warm blocks in the page cache.  
The default value is 100.
- `maria_recover`  
Forces recovery of corrupted Maria tables without using the log files. Unlike the automatic recovery supported by Maria on transactional tables, `maria-recover` will work for all Maria tables.
- `maria_repair_threads`  
Number of threads to be used when repairing Maria tables when using `REPAIR TABLE`. The default value of 1 disables parallel repair.
- `maria_sort_buffer_size`  
Sets the size of the buffer that is allocated when sorting the index when doing a `REPAIR` or when creating indexes using `CREATE INDEX` or `ALTER TABLE`. Increasing this option will improve the speed of the index creation process.  
The default value is 8MB.
- `maria_stats_method`  
Specifies how index statistics collection treats `NULL` values. Valid choices are `nulls_unequal`, `nulls_equal`, `nulls_ignored`.  
The default setting is `nulls_unequal`.
- `maria_sync_log_dir`  
Controls the synchronization of the directory after a log file has been extended or a new log file has been created. Supported values are `never`, `newfile` (only when a new log file is created), and `always`.  
The default setting is `newfile`.

## 13.5.2. Maria Table Options

There are a number of options available when you create a new Maria table:

- `PAGE_CHECKSUM`  
The `PAGE_CHECKSUM` table option specifies whether a page checksum for the table should be enabled. The checksum can either be switched on (value 1) or off (value 0). The default value of this option is implied by the `maria_page_checksum` variable.  
Because the default value of the `PAGE_CHECKSUM` option is configurable, the checksum setting is always included in the output of `SHOW CREATE TABLE` if it was enabled when the table was created.
- `TRANSACTIONAL`  
Maria tables can be either transactional or non-transactional. For Maria versions less than 2.0, `TRANSACTIONAL` means crash-safe. Full transaction support will only be available with Maria 2.0 and later.

Changes to transactional tables are recorded in the Maria log and use slightly more space per row than non-transactional tables. By default all tables are transactional i.e. `TRANSACTIONAL=1` is implied within the `CREATE TABLE` definition. This means that the transactional status of the table is not written in the output of the `SHOW CREATE TABLE` output:

```
mysql> create table maria_trans (id int, title char(20)) engine=Maria;
Query OK, 0 rows affected (0.05 sec)

mysql> SHOW CREATE TABLE maria_trans;
+-----+-----+
| Table      | Create Table                               |
+-----+-----+
| maria_trans | CREATE TABLE `maria_trans` (           |
|   `id` int(11) DEFAULT NULL,           |
|   `title` char(20) DEFAULT NULL        |
| ) ENGINE=MARIA DEFAULT CHARSET=latin1 PAGE_CHECKSUM=1 |
+-----+-----+
1 row in set (0.00 sec)
```

If you create a non-crash safe (non-transactional) table then the option is shown

```
mysql> CREATE TABLE maria_nontrans (id INT, title CHAR(20)) ENGINE=Maria TRANSACTIONAL=0;
Query OK, 0 rows affected (0.02 sec)

mysql> SHOW CREATE TABLE maria_nontrans;
+-----+-----+
| Table          | Create Table                               |
+-----+-----+
| maria_nontrans | CREATE TABLE `maria_nontrans` (
  `id` int(11) DEFAULT NULL,
  `title` char(20) DEFAULT NULL
) ENGINE=MARIA DEFAULT CHARSET=latin1 PAGE_CHECKSUM=1 TRANSACTIONAL=0 |
+-----+-----+
1 row in set (0.00 sec)
```

Currently, transactional tables cannot handle [SPATIAL](#) or [FULLTEXT](#) indexes. You must use a non-transactional table if you want to use these index key types. If you try to create a table with these options, then an error will occur during [CREATE TABLE](#).

- [TABLE\\_CHECKSUM](#), [CHECKSUM](#)

Forces MySQL to maintain a live checksum for all rows in the table. This maintains a rolling checksum (i.e. one that changes when the table data changes), and can be used to identify corrupted tables. This is identical to the [CHECKSUM](#) on [MyISAM](#) tables.

The [CHECKSUM TABLE](#) statement, which returns the checksum for a given table, ignores record's columns which have a [NULL](#) value. This is different behavior from standard MySQL 5.1.

In addition, [Maria](#) supports the following row formats:

- [FIXED](#) — identical to the [FIXED](#) row format used by [MyISAM](#). Must be used with non-transactional tables (i.e. where [TRANSACTIONAL=0](#)).
- [DYNAMIC](#) — identical to the [DYNAMIC](#) row format used by [MyISAM](#). Must be used with non-transactional tables (i.e. where [TRANSACTIONAL=0](#)).
- [PAGE](#) — new [Maria](#) row format where data and index information is written into pages. The [PAGE](#) option can be used with [TRANSACTIONAL=0](#) or [TRANSACTIONAL=1](#). The [PAGE](#) format uses a different caching mechanism than [MyISAM](#). For more information, see [Section 13.5.1, “Maria Configuration”](#).

[Maria](#) data pages in [PAGE](#) format have an overhead of 10 bytes/page and 5 bytes/row. Transaction and multiple concurrent writer support will use an additional overhead of 7 bytes for new rows, 14 bytes for deleted rows and 0 bytes for old compacted rows.

### 13.5.3. Maria Transaction Log

The transaction log within [Maria](#) keeps a record of all changes, including DDL, to tables created using the [TRANSACTIONAL](#) table option. Events from all tables and all databases are written into a single log file sequence. The [Maria](#) log consists of one log control file ([maria\\_log\\_control](#)) and one or more maria log files (named [maria\\_log.????????](#), where [????????](#) is an eight-digit number with a maximum value of 16777215). The log control file and log file are created automatically when [mysqld](#) is started.

The log contains a copy of all the data and the log can be used to replay and verify the contents of the data files in the event of a crash. Checkpoints saves information about the current transactions, opened files and other statusw information that will be required if the log needs to be used during recover. Checkpoints are written every 30 seconds by default, although you can increase or decrease this value.

For tables using the transactional format, statements that change data (DML statements) are recorded in the log file and these changes are also ultimately written to the data and index files. There is no fixed point when the application of data written to the log is also written to the data and index files. The process happens continuously in the background during normal execution. Although the data and index files and the transaction log may be out of sync, all of the information is always available. In the event of a crash, the recovery process will replay and apply the contents of the log to bring the data and log files back into synchronization.

Additional log files are created when the log file reaches the configured maximum size (as controlled by [maria\\_log\\_file\\_size](#)). The default value is 1GB. This option can be controlled as a global variable and set with the configuration file or on the command line.

You can determine the list of current log files using the statement [SHOW ENGINE MARIA LOGS](#):



```
mysql> SHOW ENGINE MARIA LOGS;
+-----+-----+-----+
| Type | Name                                     | Status |
+-----+-----+-----+
| maria | Size 191627264 ; /usr/local/mysql/var/ | unknown |
|      | maria_log.00000009                      |         |
+-----+-----+-----+
1 row in set (0.00 sec)
```

The `Status` shows the current status of the log file:

- `unknown` — no checkpoint has taken place, so the current status of the log file is unknown.
- `in-use` — information is still being written to or read from the log, or outstanding statements are still active that have information active within the log file.
- `free` — the log file and any statements related to it have been completed and safely committed to disk, and the log file is no longer active.

Any other message indicates an error in reading the log file information.

New log files are created automatically as the size of the current log file reaches the configured size. For example, shown below are the log files after a statement that inserted a large volume of data was executed after the `maria_log_file_size` variable has been reduced to 8MB (the minimum supported value):

```
mysql> SHOW ENGINE MARIA LOGS;
+-----+-----+-----+
| Type | Name                                     | Status |
+-----+-----+-----+
| maria | Size 191627264 ; /usr/local/mysql/var/ | in use |
|      | maria_log.00000009                      |         |
| maria | Size 8388608 ; /usr/local/mysql/var/   | in use |
|      | maria_log.00000010                      |         |
| maria | Size 8388608 ; /usr/local/mysql/var/   | in use |
|      | maria_log.00000011                      |         |
| maria | Size 8388608 ; /usr/local/mysql/var/   | in use |
|      | maria_log.00000012                      |         |
| maria | Size 8388608 ; /usr/local/mysql/var/   | in use |
|      | maria_log.00000013                      |         |
| maria | Size 8388608 ; /usr/local/mysql/var/   | in use |
|      | maria_log.00000014                      |         |
| maria | Size 8388608 ; /usr/local/mysql/var/   | in use |
|      | maria_log.00000015                      |         |
| maria | Size 139264 ; /usr/local/mysql/var/    | in use |
|      | maria_log.00000016                      |         |
+-----+-----+-----+
8 rows in set (0.00 sec)
```

Log files that no longer have transactions or outstanding events where the data has been safely committed on disk are marked 'free':

```
mysql> SHOW ENGINE MARIA LOGS;
+-----+-----+-----+
| Type | Name                                     | Status |
+-----+-----+-----+
| maria | Size 8388608 ; /usr/local/mysql/var/   | free   |
|      | maria_log.00000002                      |         |
| maria | Size 2170880 ; /usr/local/mysql/var/    | in use |
|      | maria_log.00000003                      |         |
+-----+-----+-----+
2 rows in set (0.00 sec)
```

Log files are deleted according to the setting of the `maria_log_purge_type` dynamic variable. Three options are supported, `immediate`, `external` and `at_flush`.

In `immediate` mode, the log files are deleted as soon as they no longer have outstanding transactions or events. This reduces the disk space used by these logs, but means that the logs cannot be transferred to another machine for replaying. This setting should not affect recovery functionality, as only logs where there is no outstanding data to be committed are deleted.

In `at_flush` mode, the log files are only deleted when you execute the `FLUSH LOGS` statement. Issuing this statement will delete the logs that have the 'free' status, and therefore will not affect logs with outstanding transactions or events.

```
mysql> SHOW ENGINE MARIA LOGS;
+-----+-----+-----+
| Type | Name                                     | Status |
+-----+-----+-----+
| maria | Size 8388608 ; /usr/local/mysql/var/   | free   |
|      | maria_log.00000002                      |         |
| maria | Size 8388608 ; /usr/local/mysql/var/   | free   |
|      | maria_log.00000003                      |         |
| maria | Size 8388608 ; /usr/local/mysql/var/   | free   |
|      | maria_log.00000004                      |         |
| maria | Size 4325376 ; /usr/local/mysql/var/    | in use |
|      | maria_log.00000005                      |         |
+-----+-----+-----+
4 rows in set (0.00 sec)

mysql> FLUSH LOGS;
Query OK, 0 rows affected (0.00 sec)

mysql> SHOW ENGINE MARIA LOGS;
+-----+-----+-----+
| Type | Name                                     | Status |
+-----+-----+-----+
```

```
| maria | Size      4325376 | /usr/local/mysql/var/maria_log.00000005 | in use |
+-----+-----+-----+-----+
1 row in set (0.00 sec)
```

When `maria_log_purge_type` is set to `external`, log files are not deleted by MySQL at all. Instead, it is assumed that an external process is responsible for deleting log files. Care should be taken with this setting as you should only delete log files that Maria is no longer using.

Transaction log file events can be viewed using the `maria_read_log` command, which also provides the ability to replay log file contents and apply them to tables without running `mysqld`. For more information, see [Section 13.5.8, “Maria Command-line Tools”](#).

## 13.5.4. Maria Recovery

Any change (creation, insertion, deletion, update, etc.) in a Maria table using the transactional format is automatically written to the Maria log. Changes to non-transactional tables are not written to the log.

The basic operation of the recovery process is in two main stages:

- Replay the contents of the log and update the data and index information.
- Roll back any statements that had not completed, or where the transactions have not been committed.

More specifically, in the event of a crash or other failure of `mysqld`, the following takes place during the next invocation of `mysqld`:

- Last checkpoint will be read from the log and the log will be replayed from the point calculated on the data contained within the checkpoint record. This point may be before the actual checkpoint.
- If a checkpoint is not available (for example, if the log file was newly created and no checkpoint was written when the crash occurred), then all events are replayed from the start of the log file.
- For each active connection, events are replayed until the last statement that completed before the crash occurred, unless the statement was executed after a `LOCK TABLES` statement, in which case recovery takes place to the last statement executed before the `LOCK TABLES` statement was issued.

Because multiple connections can be active at the same time, recovery takes place for each connection individually.

- During recovery, if a statement fails due to a unique key violation, then the entire statement is not rolled back. Only the data that would have triggered the unique key violation is rolled back. For example, if you had executed the following statements into a table with a unique key:

```
INSERT VALUES (1);
INSERT VALUES (2),(1)
```

The second statement would generate a unique key violation, but during recovery the statement would not be rolled back. The table would still contain two rows containing the first two values.

You can see a sample of the recovery process after a crash below:

```
080111 16:42:05 mysqld_safe Number of processes running now: 0
080111 16:42:05 mysqld_safe mysqld restarted
080111 16:42:05 [Note] mysqld: Maria engine: starting recovery
recovered pages: 0% 99% 100% (0.9 seconds); transactions to roll back: 1 0 (3.8 seconds); tables to flush: 1 0 (0.5 seconds)
080111 16:42:10 [Note] mysqld: Maria engine: recovery done
080111 16:42:10 [Note] Event Scheduler: Loaded 0 events
080111 16:42:10 [Note] /usr/local/mysql/libexec/mysqld: ready for connections.
```

Recovery is automatic, but the length of time for recovery increases in line with the number of incomplete statements and tables known to be out of synchronization with the log. The recovery process is single-threaded and cannot be configured.

## 13.5.5. Maria Usage Notes

When using Maria you should be aware of the following information and notes:

- When using `Maria` tables and transactions, statements operate using the `REPEATABLE READ` isolation level, except when running `REPAIR TABLE`, `OPTIMIZE TABLE`, or `ALTER TABLE`, when all rows are exposed to all statements regardless of the isolation level.
- When `Maria` is enabled, and if MySQL has been built using the `configure` option `--with-maria-tmp-tables`, then all internal on-disk temporary tables, including `INFORMATION_SCHEMA`, will be created using the `Maria` storage engine, in place of `MyISAM`.
- You should not delete the `maria_log_control`, or the associated log files, except within the following circumstances:
  - When changing the size of the pages used in `Maria` data and index files.
  - If the `maria_log_control` gets corrupted.
  - If you want to rebuild all your `Maria` tables.

Outside of these situations, deleting the `maria_log_control` may cause loss of data.

If you delete `maria_log_control` and then want to use any existing `Maria` tables, you should shutdown `mysqld`. You can then either manually run `maria_check --zerofill` to check the structure and format of each `Maria` table, or you can wait until the first access of the table, when the check will be performed automatically. On very large tables, the check should be performed manually to ensure that there is no delay during usage.

- If you want to copy `Maria` tables from one system to another, use the following sequence:
  1. Check the status of the `Maria` logs and ensure that the events written to the log have been applied to the tables.
  2. Shutdown the `mysqld` server.
  3. Copy the `Maria` table files. Do not copy the log files or the `maria_log_control`.
  4. On the new system, run `maria_check --zerofill` on each table that you have copied to the new system.

### 13.5.6. `Maria` Statement Concurrency

The concurrency of statement execution on tables is handled differently in `Maria` depending on whether you are using non-transactional or transactional tables.

For non-transactional tables, the rules are identical to `MyISAM`:

- `SELECT`

All issued `SELECT`'s are running concurrently. While a `SELECT` is running, all writers (`INSERT`, `DELETE`, `UPDATE`) are blocked from using any of the used tables (i.e., they wait for the table to be free before continuing) . The only exception is that one `INSERT CONCURRENT` can be run on each table that doesn't have any deleted rows.

- `UPDATE`

Only one `UPDATE` statement can run at the same time on each table. While the `UPDATE` is running all other threads are blocked from using this table.

- `DELETE`

Only one `DELETE` statement can run at the same time on each table. While the `DELETE` is running all other threads are blocked from using this table.

- `INSERT`

If `INSERT CONCURRENT` is used, and there are no deleted rows in the table, only one `INSERT CONCURRENT` statement can run at the same time on each table. While the `INSERT CONCURRENT` is running all other writer threads are blocked for using this table. Any number of `SELECT` statements can use this table.

If normal `INSERT` is used or if there are deleted rows in the table, only one `INSERT` statement can run at the same time on the table. While the `INSERT` is running all `SELECT`, `INSERT`, `DELETE` and `UPDATE` are blocked from using this table.

- `CREATE` or `DROP`

`CREATE`'s on different tables can be run concurrently. On the same table, first creator wins. `DROP` waits until all statements using the tables are completed, after which the table is dropped.

When using transactional tables, *Maria* supports a single writer and multiple readers. The single writer supports both `INSERT` and `UPDATE` operations.

- `SELECT`

All issued `SELECT`'s are running concurrently. While a `SELECT` is running, all writers (`INSERT`, `DELETE`, `UPDATE`) are blocked from using any of the used tables (ie, they wait for the table to be free before continuing).

- `UPDATE`

As part of the single writer, only one `UPDATE` statement can run at the same time on each table. While the `UPDATE` is running all other threads using `UPDATE` or `INSERT` are blocked from using this table.

- `INSERT`

As part of the single writer, only one `INSERT` statement can run at the same time on the table. While the `INSERT` is running all other threads using `UPDATE` or `INSERT` are blocked from using this table.

- `DELETE`

Only one `DELETE` statement can run at the same time on each table. While the `DELETE` is running all other threads are blocked from using this table.

- `CREATE` or `DROP`

`CREATE` operations on different tables can be run concurrently. On the same table, first creator wins. `DROP` waits until all statements using the tables are completed, after which the table is dropped.

Starting with MySQL 5.1.27-maria, multiple concurrent `INSERT` statements are supported, with the following notes:

- To use multiple writers you should lock tables using the statement:

```
LOCK TABLES table_name WRITE CONCURRENT
```

- During multiple write operations, all `SELECT` statements operate in `REPEATABLE READ` mode.
- All `INSERT` statements are considered atomic, and will use concurrent insert locks to ensure consistency.
- Concurrent inserts are not supported on:
  - Non-transactional tables.
  - Transactional tables that have GIS (spatial) or `FULLTEXT` indexes.
  - Empty tables.

## 13.5.7. *Maria* Design Notes

*Maria* supports all aspects of *MyISAM*, except as noted below. This includes external and internal check/repair/compressing of rows, different row formats, different index compress formats, `maria_check` etc. After a normal shutdown one can copy *Maria* files between servers.

### Advantages of *Maria* (Compared to *MyISAM*)

- Data and indexes are crash safe. On crash, things will rollback to state of the start of statement or last `LOCK TABLES` commands.
- *Maria* can replay everything from the log. Including `CREATE/DROP/RENAME/TRUNCATE` tables.
- `LOAD INDEX` can skip index blocks for not wanted indexes
- Supports all *MyISAM* row formats and the new transactional format where data is stored in pages.
- When using transactional format (default) row data can be cached.
- *Maria* has unit tests of most parts

- Supports both crash safe (soon to be transactional) and not transactional tables. (Not transactional tables are not logged and rows uses less space.) `CREATE TABLE foo (...) TRANSACTIONAL=0|1`
- Transactional is the only crashsafe/transactional row format.
- Block format should give a notable speed improvement on systems with bad data caching (for example Windows).

#### Differences between **Maria** and **MyISAM**

- **Maria** uses big (1GB by default) log files.
- **Maria** has a log control file (`maria_log_control`) and log files (`maria_log.????????`). The log files can be automatically purged when not needed or purged on demand (after backup).
- **Maria** uses by default 8K pages for indexes (**MyISAM** 1K). **Maria** should be faster on static size indexes but slower on variable length keys (until we add a directory to index pages).

#### Disadvantages of **Maria** (compared to **MyISAM**), that will be fixed in forthcoming releases.

- **Maria** 1.0 has one writer or many readers. (**MyISAM** can have one inserter and many readers when using concurrent inserts.)
- Storage of very small rows (< 25 bytes) is not efficient for `PAGE` format.
- In **Maria** `PAGE` format there is an overhead of 10 bytes/page and 5 bytes/row. Transaction and multiple concurrent writer support will use an additional overhead of 7 bytes for new rows, 14 bytes for deleted rows and 0 bytes for old compacted rows.
- **Maria** doesn't support `INSERT DELAYED`.
- The `maria_page_buffer_size` system variable that controls the **Maria** page cache size is not dynamically settable like the corresponding **MyISAM** variable, `key_buffer_size`.

#### Differences that are not likely to be fixed

- No external locking (**MyISAM** has external locking, but it is not much used).
- **Maria** has one page size for both index and data (defined when **Maria** is used first time). **MyISAM** supports different page sizes per index.
- Index requires one extra byte per index page.
- **Maria** doesn't support RAID (disabled in **MyISAM** too).
- Minimum data file size for `PAGE` format is 16K (with 8K pages).

## 13.5.8. **Maria** Command-line Tools

**Maria** supports a number of command-line tools which operate in a similar fashion to the corresponding **MyISAM** tools. These are:

- `maria_chk` — checks **Maria** tables for corruption. Similar to the `myisamchk` command; see [Section 4.6.3, “myisamchk — MyISAM Table-Maintenance Utility”](#).
- `maria_ftdump` — dumps information about fulltext indexes in **Maria** tables. Similar to the `myisam_ftdump` command; see [Section 4.6.2, “myisam\\_ftdump — Display Full-Text Index information”](#).
- `maria_pack` — packs a **Maria** table to save space. Similar to the `myisampack` command; see [Section 4.6.5, “myisampack — Generate Compressed, Read-Only MyISAM Tables”](#).
- `maria_read_log` — displays the contents of a **Maria** log file or applies the contents to existing tables. This tool is a utility for the log files but is not used or required for recovery of data from the log file.
- `maria_dump_log` — used for interpreting log content for people who understand **maria** transaction log internals.

## 13.5.9. Maria Open Bugs

This section contains all known fatal bugs in the [Maria](#) storage engine for the last source or binary release. Minor bugs, extensions and feature requests and bugs, found since this release can be found in the MySQL bugs databases at: <http://bugs.mysql.com/>. When reporting a bug, make sure you select the [Maria](#) category for the bug.

### Note

You can find additional information in the `KNOWN_BUGS.txt` file within the [Maria](#) repository.

There shouldn't normally be any bugs that affect normal operations in any [Maria](#) release. Still, there are always exceptions and edge cases and that is what this section is for.

If you have found a bug that is not listed here, please add it to <http://bugs.mysql.com/> so that we can either fix it for next release or in the worst case add it here for others to know! When reporting a bug, make sure you select the [Maria](#) category for the bug.

### Known bugs that are planned to be fixed before next minor release

- If the log files are damaged or inconsistent, [Maria](#) may fail to start. We should fix that if this happens and `mysqld` is restarted (thanks to `mysqld_safe`, instance manager or other script) it should disregard the old logs, start anyway and automatically repair any tables that were found to be crashed on open.

Temporary fix is to remove `maria_log.????????` files from the data directory, restart `mysqld` and run `CHECK TABLE/REPAIR TABLE` or `mysqlcheck` on your [Maria](#) tables.

### Warning

Do not remove the `maria_log_control` file, as this contains the page size information required for reading [Maria](#) log and data files.

### Known bugs that are planned to be fixed before Beta

- If we get a write failure on disk for the log, we should stop all usage of transactional tables and mark all transactional tables that are changed as crashed.
- **Missing features that are planned to be fixed before Beta**
- We will add a `maria-recover` option to automatically repair any crashed tables on open. (This is needed for non-transactional tables and also in edge cases for transactional tables when the table crashed because of a bug in MySQL or [Maria](#) code)

### Features planned for future releases

You can find details on additional features and functionality planned for [Maria](#), see [MySQL Forge Worklog](#).

## 13.5.10. Maria FAQ

The following entries cover some of the frequently asked questions about [Maria](#).

### Questions

- [13.5.10.1](#): Is `DELAY_KEY_WRITE` honored on [Maria](#) tables?
- [13.5.10.2](#): Is there compression of text/blob columns or entire pages in [Maria](#)?

### Questions and Answers

#### 13.5.10.1: Is `DELAY_KEY_WRITE` honored on [Maria](#) tables?

If you are using non-transactional [Maria](#) tables (`CREATE TABLE... ENGINE=MARIA TRANSACTIONAL=0`), which are similar to [MyISAM](#), then `DELAY_KEY_WRITE` works as you expect. If you are using transactional [Maria](#) tables (the default), then `DELAY_KEY_WRITE` is always enabled. In [MyISAM](#) and non-transactional [Maria](#) tables (which have no logging), by default all the table's key pages are flushed to the OS at the end of each statement, to guarantee some durability. `DELAY_KEY_WRITE` removes this flush, giving less durability. In transactional [Maria](#) tables, key pages are flushed by a background job, regularly, not necessarily at the end of each statement, and durability is guaranteed thanks to logging.

**13.5.10.2: Is there compression of text/blob columns or entire pages in Maria?**

No, there is no compression of `TEXT/BLOB` in `Maria`. You can use the `compress()`/`uncompress()` functions on the SQL level to store/retrieve `BLOB/TEXT` in compressed format.

## 13.6. The `InnoDB` Storage Engine

`InnoDB` is a transaction-safe (ACID compliant) storage engine for MySQL that has commit, rollback, and crash-recovery capabilities to protect user data. `InnoDB` row-level locking (without escalation to coarser granularity locks) and Oracle-style consistent non-locking reads increase multi-user concurrency and performance. `InnoDB` stores user data in clustered indexes to reduce I/O for common queries based on primary keys. To maintain data integrity, `InnoDB` also supports `FOREIGN KEY` referential-integrity constraints. You can freely mix `InnoDB` tables with tables from other MySQL storage engines, even within the same statement.

To determine whether your server supports `InnoDB` use the `SHOW ENGINES` statement. See [Section 12.5.5.17, “SHOW ENGINES Syntax”](#).

**Table 13.4. `InnoDB` Features**

<b>Storage limits</b>	64TB	<b>Transactions</b>	Yes	<b>Locking granularity</b>	Row
<b>MVCC</b>	Yes	<b>Geospatial datatype support</b>	Yes	<b>Geospatial indexing support</b>	No
<b>B-tree indexes</b>	Yes	<b>Hash indexes</b>	No	<b>Full-text search indexes</b>	No
<b>Clustered indexes</b>	Yes	<b>Data caches</b>	Yes	<b>Index caches</b>	Yes
<b>Compressed data</b>	Yes <sup>a</sup>	<b>Encrypted data<sup>b</sup></b>	Yes	<b>Cluster database support</b>	No
<b>Replication support<sup>c</sup></b>	Yes	<b>Foreign key support</b>	Yes	<b>Backup / point-in-time recovery<sup>d</sup></b>	Yes
<b>Query cache support</b>	Yes	<b>Update statistics for data dictionary</b>	Yes		

<sup>a</sup>Compressed `InnoDB` tables are supported only by `InnoDB` Plugin.

<sup>b</sup>Implemented in the server (via encryption functions), rather than in the storage engine.

<sup>c</sup>Implemented in the server, rather than in the storage engine

<sup>d</sup>Implemented in the server, rather than in the storage engine

`InnoDB` has been designed for maximum performance when processing large data volumes. Its CPU efficiency is probably not matched by any other disk-based relational database engine.

The `InnoDB` storage engine maintains its own buffer pool for caching data and indexes in main memory. `InnoDB` stores its tables and indexes in a tablespace, which may consist of several files (or raw disk partitions). This is different from, for example, `MyISAM` tables where each table is stored using separate files. `InnoDB` tables can be very large even on operating systems where file size is limited to 2GB.

The Windows Essentials installer makes `InnoDB` the MySQL default storage engine on Windows, if the server being installed supports `InnoDB`.

`InnoDB` is used in production at numerous large database sites requiring high performance. The famous Internet news site Slashdot.org runs on `InnoDB`. Myrix, Inc. stores more than 1TB of data in `InnoDB`, and another site handles an average load of 800 inserts/updates per second in `InnoDB`.

`InnoDB` is published under the same GNU GPL License Version 2 (of June 1991) as MySQL. For more information on MySQL licensing, see <http://www.mysql.com/company/legal/licensing/>.

**Additional resources**

- A forum dedicated to the `InnoDB` storage engine is available at <http://forums.mysql.com/list.php?22>.
- Innobase Oy also hosts several forums, available at <http://forums.innodb.com>.
- At the 2008 MySQL User Conference, Innobase announced availability of an `InnoDB` Plugin for MySQL. This plugin for MySQL exploits the “pluggable storage engine” architecture of MySQL, to permit users to replace the “built-in” version of `InnoDB` in MySQL 5.1 with a new release of `InnoDB` that offers new features, improved performance, enhanced reliability and new capabilities for flexibility and ease of use. Among the new features of the `InnoDB` Plugin are “Fast index creation”, table and index compression, file format management and new `INFORMATION_SCHEMA` tables.

For a general description of the `InnoDB` Plugin, see [http://www.innodb.com/innodb\\_plugin/](http://www.innodb.com/innodb_plugin/), and for an overview of its features, see [http://www.innodb.com/innodb\\_plugin/features/](http://www.innodb.com/innodb_plugin/features/). You can download the `InnoDB` Plugin from the `InnoDB` web site:



[http://www.innodb.com/innodb\\_plugin/download/](http://www.innodb.com/innodb_plugin/download/). For the documentation for the `InnoDB` Plugin, see [http://www.innodb.com/innodb\\_plugin/plugin-documentation/](http://www.innodb.com/innodb_plugin/plugin-documentation/).

- `InnoDB Hot Backup` enables you to back up a running MySQL database, including `InnoDB` and `MyISAM` tables, with minimal disruption to operations while producing a consistent snapshot of the database. When `InnoDB Hot Backup` is copying `InnoDB` tables, reads and writes to both `InnoDB` and `MyISAM` tables can continue. During the copying of `MyISAM` tables, reads (but not writes) to those tables are permitted. In addition, `InnoDB Hot Backup` supports creating compressed backup files, and performing backups of subsets of `InnoDB` tables. In conjunction with MySQL's binary log, users can perform point-in-time recovery. `InnoDB Hot Backup` is commercially licensed by Innobase Oy. For a more complete description of `InnoDB Hot Backup`, see <http://www.innodb.com/hot-backup/features/> or download the documentation from [http://www.innodb.com/doc/hot\\_backup/manual.html](http://www.innodb.com/doc/hot_backup/manual.html). You can order trial, term, and perpetual licenses from Innobase at <http://www.innodb.com/hot-backup/order/>.

### 13.6.1. InnoDB Contact Information

Contact information for Innobase Oy, producer of the `InnoDB` engine:

Web site: <http://www.innodb.com/>

Email: `innodb_sales_ww at oracle.com` or use this contact form: <http://www.innodb.com/contact-form>

Phone:

```
+358-9-6969 3250 (office, Heikki Tuuri)
+358-40-5617367 (mobile, Heikki Tuuri)
+358-40-5939732 (mobile, Satu Sirén)
```

Address:

```
Innobase Oy Inc.
World Trade Center Helsinki
Aleksanterinkatu 17
P.O.Box 800
00101 Helsinki
Finland
```

### 13.6.2. InnoDB Configuration

If you do not want to use `InnoDB` tables, start the server with the `--skip-innodb` option to disable the `InnoDB` startup engine.

#### Caution

`InnoDB` is a transaction-safe (ACID compliant) storage engine for MySQL that has commit, rollback, and crash-recovery capabilities to protect user data. **However, it cannot do so** if the underlying operating system or hardware does not work as advertised. Many operating systems or disk subsystems may delay or reorder write operations to improve performance. On some operating systems, the very `fsync()` system call that should wait until all unwritten data for a file has been flushed might actually return before the data has been flushed to stable storage. Because of this, an operating system crash or a power outage may destroy recently committed data, or in the worst case, even corrupt the database because of write operations having been reordered. If data integrity is important to you, you should perform some “pull-the-plug” tests before using anything in production. On Mac OS X 10.3 and up, `InnoDB` uses a special `fcntl()` file flush method. Under Linux, it is advisable to **disable the write-back cache**.

On ATA/SATA disk drives, a command such `hdparm -W0 /dev/hda` may work to disable the write-back cache. **Beware that some drives or disk controllers may be unable to disable the write-back cache.**

Two important disk-based resources managed by the `InnoDB` storage engine are its tablespace data files and its log files. If you specify no `InnoDB` configuration options, MySQL creates an auto-extending 10MB data file named `ibdata1` and two 5MB log files named `ib_logfile0` and `ib_logfile1` in the MySQL data directory. To get good performance, you should explicitly provide `InnoDB` parameters as discussed in the following examples. Naturally, you should edit the settings to suit your hardware and requirements.

#### Caution

It is not a good idea to configure `InnoDB` to use data files or log files on NFS volumes. Otherwise, the files might be locked by other processes and become unavailable for use by MySQL.

#### MySQL Enterprise

For advice on settings suitable to your specific circumstances, subscribe to the MySQL Enterprise Monitor. For more information, see <http://www.mysql.com/products/enterprise/advisors.html>.



The examples shown here are representative. See [Section 13.6.3, “InnoDB Startup Options and System Variables”](#) for additional information about InnoDB-related configuration parameters.

To set up the InnoDB tablespace files, use the `innodb_data_file_path` option in the `[mysqld]` section of the `my.cnf` option file. On Windows, you can use `my.ini` instead. The value of `innodb_data_file_path` should be a list of one or more data file specifications. If you name more than one data file, separate them by semicolon (“;”) characters:

```
innodb_data_file_path=datafile_spec1[:datafile_spec2]...
```

For example, the following setting explicitly creates a tablespace having the same characteristics as the default:

```
[mysqld]
innodb_data_file_path=ibdata1:10M:autoextend
```

This setting configures a single 10MB data file named `ibdata1` that is auto-extending. No location for the file is given, so by default, InnoDB creates it in the MySQL data directory.

Sizes are specified using `K`, `M`, or `G` suffix letters to indicate units of KB, MB, or GB.

A tablespace containing a fixed-size 50MB data file named `ibdata1` and a 50MB auto-extending file named `ibdata2` in the data directory can be configured like this:

```
[mysqld]
innodb_data_file_path=ibdata1:50M;ibdata2:50M:autoextend
```

The full syntax for a data file specification includes the file name, its size, and several optional attributes:

```
file_name:file_size[:autoextend[:max:max_file_size]]
```

The `autoextend` and `max` attributes can be used only for the last data file in the `innodb_data_file_path` line.

If you specify the `autoextend` option for the last data file, InnoDB extends the data file if it runs out of free space in the tablespace. The increment is 8MB at a time by default. To modify the increment, change the `innodb_autoextend_increment` system variable.

If the disk becomes full, you might want to add another data file on another disk. For tablespace reconfiguration instructions, see [Section 13.6.5, “Adding, Removing, or Resizing InnoDB Data and Log Files”](#).

InnoDB is not aware of the file system maximum file size, so be cautious on file systems where the maximum file size is a small value such as 2GB. To specify a maximum size for an auto-extending data file, use the `max` attribute following the `autoextend` attribute. The following configuration allows `ibdata1` to grow up to a limit of 500MB:

```
[mysqld]
innodb_data_file_path=ibdata1:10M:autoextend:max:500M
```

InnoDB creates tablespace files in the MySQL data directory by default. To specify a location explicitly, use the `innodb_data_home_dir` option. For example, to use two files named `ibdata1` and `ibdata2` but create them in the `/ibdata` directory, configure InnoDB like this:

```
[mysqld]
innodb_data_home_dir = /ibdata
innodb_data_file_path=ibdata1:50M;ibdata2:50M:autoextend
```

## Note

InnoDB does not create directories, so make sure that the `/ibdata` directory exists before you start the server. This is also true of any log file directories that you configure. Use the Unix or DOS `mkdir` command to create any necessary directories.

Make sure that the MySQL server has the proper access rights to create files in the data directory. More generally, the server must have access rights in any directory where it needs to create data files or log files.

InnoDB forms the directory path for each data file by textually concatenating the value of `innodb_data_home_dir` to the data file name, adding a path name separator (slash or backslash) between values if necessary. If the `innodb_data_home_dir` option is not mentioned in `my.cnf` at all, the default value is the “dot” directory `./`, which means the MySQL data directory. (The MySQL server changes its current working directory to its data directory when it begins executing.)

If you specify `innodb_data_home_dir` as an empty string, you can specify absolute paths for the data files listed in the `innodb_data_file_path` value. The following example is equivalent to the preceding one:

```
[mysqld]
innodb_data_home_dir =
innodb_data_file_path=ibdata/ibdata1:50M;/ibdata/ibdata2:50M:autoextend
```

**A simple `my.cnf` example.** Suppose that you have a computer with 512MB RAM and one hard disk. The following example shows possible configuration parameters in `my.cnf` or `my.ini` for InnoDB, including the `autoextend` attribute. The example suits most users, both on Unix and Windows, who do not want to distribute InnoDB data files and log files onto several disks. It creates an auto-extending data file `ibdata1` and two InnoDB log files `ib_logfile0` and `ib_logfile1` in the MySQL data directory.

```
[mysqld]
# You can write your other MySQL server options here
# ...
# Data files must be able to hold your data and indexes.
# Make sure that you have enough free disk space.
innodb_data_file_path = ibdata1:10M:autoextend
#
# Set buffer pool size to 50-80% of your computer's memory
innodb_buffer_pool_size=256M
innodb_additional_mem_pool_size=20M
#
# Set the log file size to about 25% of the buffer pool size
innodb_log_file_size=64M
innodb_log_buffer_size=8M
#
innodb_flush_log_at_trx_commit=1
```

Note that data files must be less than 2GB in some file systems. The combined size of the log files must be less than 4GB. The combined size of data files must be at least 10MB.

When you create an InnoDB tablespace for the first time, it is best that you start the MySQL server from the command prompt. InnoDB then prints the information about the database creation to the screen, so you can see what is happening. For example, on Windows, if `mysqld` is located in `C:\Program Files\MySQL\MySQL Server 5.1\bin`, you can start it like this:

```
C:\> "C:\Program Files\MySQL\MySQL Server 5.1\bin\mysqld" --console
```

If you do not send server output to the screen, check the server's error log to see what InnoDB prints during the startup process.

For an example of what the information displayed by InnoDB should look like, see [Section 13.6.2.3, "Creating the InnoDB Tablespace"](#).

You can place InnoDB options in the `[mysqld]` group of any option file that your server reads when it starts. The locations for option files are described in [Section 4.2.3.2, "Using Option Files"](#).

If you installed MySQL on Windows using the installation and configuration wizards, the option file will be the `my.ini` file located in your MySQL installation directory. See [The Location of the my.ini File](#).

If your PC uses a boot loader where the `C:` drive is not the boot drive, your only option is to use the `my.ini` file in your Windows directory (typically `C:\WINDOWS`). You can use the `SET` command at the command prompt in a console window to print the value of `WINDIR`:

```
C:\> SET WINDIR
windir=C:\WINDOWS
```

To make sure that `mysqld` reads options only from a specific file, use the `--defaults-file` option as the first option on the command line when starting the server:

```
mysqld --defaults-file=your_path_to_my.cnf
```

**An advanced `my.cnf` example.** Suppose that you have a Linux computer with 2GB RAM and three 60GB hard disks at directory paths `/`, `/dr2` and `/dr3`. The following example shows possible configuration parameters in `my.cnf` for InnoDB.

```
[mysqld]
# You can write your other MySQL server options here
# ...
innodb_data_home_dir =
#
# Data files must be able to hold your data and indexes
innodb_data_file_path = /db/ibdata1:2000M;/dr2/db/ibdata2:2000M:autoextend
#
# Set buffer pool size to 50-80% of your computer's memory,
# but make sure on Linux x86 total memory usage is < 2GB
innodb_buffer_pool_size=1G
innodb_additional_mem_pool_size=20M
innodb_log_group_home_dir = /dr3/iblogs
#
# Set the log file size to about 25% of the buffer pool size
innodb_log_file_size=250M
```

```
innodb_log_buffer_size=8M
#
innodb_flush_log_at_trx_commit=1
innodb_lock_wait_timeout=50
#
# Uncomment the next line if you want to use it
#innodb_thread_concurrency=5
```

In some cases, database performance improves if the data is not all placed on the same physical disk. Putting log files on a different disk from data is very often beneficial for performance. The example illustrates how to do this. It places the two data files on different disks and places the log files on the third disk. InnoDB fills the tablespace beginning with the first data file. You can also use raw disk partitions (raw devices) as InnoDB data files, which may speed up I/O. See [Section 13.6.2.2, “Using Raw Devices for the Shared Tablespace”](#).

### Warning

On 32-bit GNU/Linux x86, you must be careful not to set memory usage too high. `glibc` may allow the process heap to grow over thread stacks, which crashes your server. It is a risk if the value of the following expression is close to or exceeds 2GB:

```
innodb_buffer_pool_size
+ key_buffer_size
+ max_connections*(sort_buffer_size+read_buffer_size+binlog_cache_size)
+ max_connections*2MB
```

Each thread uses a stack (often 2MB, but only 256KB in MySQL AB binaries) and in the worst case also uses `sort_buffer_size + read_buffer_size` additional memory.

**Tuning other `mysqld` server parameters.** The following values are typical and suit most users:

```
[mysqld]
skip-external-locking
max_connections=200
read_buffer_size=1M
sort_buffer_size=1M
#
# Set key_buffer to 5 - 50% of your RAM depending on how much
# you use MyISAM tables, but keep key_buffer_size + InnoDB
# buffer pool size < 80% of your RAM
key_buffer_size=value
```

On Linux, if the kernel is enabled for large page support, InnoDB can use large pages to allocate memory for its buffer pool and additional memory pool. See [Section 7.5.9, “Enabling Large Page Support”](#).

## 13.6.2.1. Using Per-Table Tablespaces

You can store each InnoDB table and its indexes in its own file. This feature is called “multiple tablespaces” because in effect each table has its own tablespace.

Using multiple tablespaces can be beneficial to users who want to move specific tables to separate physical disks or who wish to restore backups of single tables quickly without interrupting the use of other InnoDB tables.

To enable multiple tablespaces, start the server with the `--innodb_file_per_table` option. For example, add a line to the `[mysqld]` section of `my.cnf`:

```
[mysqld]
innodb_file_per_table
```

With multiple tablespaces enabled, InnoDB stores each newly created table into its own `tbl_name.ibd` file in the database directory where the table belongs. This is similar to what the MyISAM storage engine does, but MyISAM divides the table into a `tbl_name.MYD` data file and an `tbl_name.MYI` index file. For InnoDB, the data and the indexes are stored together in the `.ibd` file. The `tbl_name.frm` file is still created as usual.

You cannot freely move `.ibd` files between database directories as you can with MyISAM table files. This is because the table definition that is stored in the InnoDB shared tablespace includes the database name, and because InnoDB must preserve the consistency of transaction IDs and log sequence numbers.

If you remove the `innodb_file_per_table` line from `my.cnf` and restart the server, InnoDB creates tables inside the shared tablespace files again.

The `--innodb_file_per_table` option affects only table creation, not access to existing tables. If you start the server with this option, new tables are created using `.ibd` files, but you can still access tables that exist in the shared tablespace. If you start the server without this option, new tables are created in the shared tablespace, but you can still access any tables that were created using multiple tablespaces.

**Note**

InnoDB always needs the shared tablespace because it puts its internal data dictionary and undo logs there. The `.ibd` files are not sufficient for InnoDB to operate.

To move an `.ibd` file and the associated table from one database to another, use a `RENAME TABLE` statement:

```
RENAME TABLE db1.tbl_name TO db2.tbl_name;
```

If you have a “clean” backup of an `.ibd` file, you can restore it to the MySQL installation from which it originated as follows:

1. Issue this `ALTER TABLE` statement to delete the current `.ibd` file:

```
ALTER TABLE tbl_name DISCARD TABLESPACE;
```

2. Copy the backup `.ibd` file to the proper database directory.
3. Issue this `ALTER TABLE` statement to tell InnoDB to use the new `.ibd` file for the table:

```
ALTER TABLE tbl_name IMPORT TABLESPACE;
```

In this context, a “clean” `.ibd` file backup is one for which the following requirements are satisfied:

- There are no uncommitted modifications by transactions in the `.ibd` file.
- There are no unmerged insert buffer entries in the `.ibd` file.
- Purge has removed all delete-marked index records from the `.ibd` file.
- `mysqld` has flushed all modified pages of the `.ibd` file from the buffer pool to the file.

You can make a clean backup `.ibd` file using the following method:

1. Stop all activity from the `mysqld` server and commit all transactions.
2. Wait until `SHOW ENGINE INNODB STATUS` shows that there are no active transactions in the database, and the main thread status of InnoDB is `Waiting for server activity`. Then you can make a copy of the `.ibd` file.

Another method for making a clean copy of an `.ibd` file is to use the commercial `InnoDB Hot Backup` tool:

1. Use `InnoDB Hot Backup` to back up the InnoDB installation.
2. Start a second `mysqld` server on the backup and let it clean up the `.ibd` files in the backup.

### 13.6.2.2. Using Raw Devices for the Shared Tablespace

You can use raw disk partitions as data files in the shared tablespace. By using a raw disk, you can perform non-buffered I/O on Windows and on some Unix systems without file system overhead. This may improve performance, but you are advised to perform tests with and without raw partitions to verify whether this is actually so on your system.

When you create a new data file, you must put the keyword `newraw` immediately after the data file size in `innodb_data_file_path`. The partition must be at least as large as the size that you specify. Note that 1MB in InnoDB is 1024 × 1024 bytes, whereas 1MB in disk specifications usually means 1,000,000 bytes.

```
[mysqld]
innodb_data_home_dir=
innodb_data_file_path=/dev/hdd1:3Gnewraw:/dev/hdd2:2Gnewraw
```

The next time you start the server, InnoDB notices the `newraw` keyword and initializes the new partition. However, do not create or change any InnoDB tables yet. Otherwise, when you next restart the server, InnoDB reinitializes the partition and your changes are lost. (As a safety measure InnoDB prevents users from modifying data when any partition with `newraw` is specified.)

After `InnoDB` has initialized the new partition, stop the server, change `newraw` in the data file specification to `raw`:

```
[mysqld]
innodb_data_home_dir=
innodb_data_file_path=/dev/hdd1:5Graw:/dev/hdd2:2Graw
```

Then restart the server and `InnoDB` allows changes to be made.

On Windows, you can allocate a disk partition as a data file like this:

```
[mysqld]
innodb_data_home_dir=
innodb_data_file_path=//./D::10Gnewraw
```

The `//./` corresponds to the Windows syntax of `\\.\` for accessing physical drives.

When you use a raw disk partition, be sure that it has permissions that allow read and write access by the account used for running the MySQL server. For example, if you run the server as the `mysql` user, the partition must allow read and write access to `mysql`. If you run the server with the `--memlock` option, the server must be run as `root`, so the partition must allow access to `root`.

### 13.6.2.3. Creating the `InnoDB` Tablespace

Suppose that you have installed MySQL and have edited your option file so that it contains the necessary `InnoDB` configuration parameters. Before starting MySQL, you should verify that the directories you have specified for `InnoDB` data files and log files exist and that the MySQL server has access rights to those directories. `InnoDB` does not create directories, only files. Check also that you have enough disk space for the data and log files.

It is best to run the MySQL server `mysqld` from the command prompt when you first start the server with `InnoDB` enabled, not from `mysqld_safe` or as a Windows service. When you run from a command prompt you see what `mysqld` prints and what is happening. On Unix, just invoke `mysqld`. On Windows, start `mysqld` with the `--console` option to direct the output to the console window.

When you start the MySQL server after initially configuring `InnoDB` in your option file, `InnoDB` creates your data files and log files, and prints something like this:

```
InnoDB: The first specified datafile /home/heikki/data/ibdata1
did not exist:
InnoDB: a new database to be created!
InnoDB: Setting file /home/heikki/data/ibdata1 size to 134217728
InnoDB: Database physically writes the file full: wait...
InnoDB: datafile /home/heikki/data/ibdata2 did not exist:
new to be created
InnoDB: Setting file /home/heikki/data/ibdata2 size to 262144000
InnoDB: Database physically writes the file full: wait...
InnoDB: Log file /home/heikki/data/logs/ib_logfile0 did not exist:
new to be created
InnoDB: Setting log file /home/heikki/data/logs/ib_logfile0 size
to 5242880
InnoDB: Log file /home/heikki/data/logs/ib_logfile1 did not exist:
new to be created
InnoDB: Setting log file /home/heikki/data/logs/ib_logfile1 size
to 5242880
InnoDB: Doublewrite buffer not found: creating new
InnoDB: Doublewrite buffer created
InnoDB: Creating foreign key constraint system tables
InnoDB: Foreign key constraint system tables created
InnoDB: Started
mysqld: ready for connections
```

At this point `InnoDB` has initialized its tablespace and log files. You can connect to the MySQL server with the usual MySQL client programs like `mysql`. When you shut down the MySQL server with `mysqladmin shutdown`, the output is like this:

```
010321 18:33:34 mysqld: Normal shutdown
010321 18:33:34 mysqld: Shutdown Complete
InnoDB: Starting shutdown...
InnoDB: Shutdown completed
```

You can look at the data file and log directories and you see the files created there. When MySQL is started again, the data files and log files have been created already, so the output is much briefer:

```
InnoDB: Started
mysqld: ready for connections
```

If you add the `innodb_file_per_table` option to `my.cnf`, `InnoDB` stores each table in its own `.ibd` file in the same MySQL database directory where the `.frm` file is created. See [Section 13.6.2.1, “Using Per-Table Tablespaces”](#).

### 13.6.2.4. Dealing with InnoDB Initialization Problems

If InnoDB prints an operating system error during a file operation, usually the problem has one of the following causes:

- You did not create the InnoDB data file directory or the InnoDB log directory.
- `mysqld` does not have access rights to create files in those directories.
- `mysqld` cannot read the proper `my.cnf` or `my.ini` option file, and consequently does not see the options that you specified.
- The disk is full or a disk quota is exceeded.
- You have created a subdirectory whose name is equal to a data file that you specified, so the name cannot be used as a file name.
- There is a syntax error in the `innodb_data_home_dir` or `innodb_data_file_path` value.

If something goes wrong when InnoDB attempts to initialize its tablespace or its log files, you should delete all files created by InnoDB. This means all `ibdata` files and all `ib_logfile` files. In case you have already created some InnoDB tables, delete the corresponding `.frm` files for these tables (and any `.ibd` files if you are using multiple tablespaces) from the MySQL database directories as well. Then you can try the InnoDB database creation again. It is best to start the MySQL server from a command prompt so that you see what is happening.

### 13.6.3. InnoDB Startup Options and System Variables

This section describes the InnoDB-related command options and system variables. System variables that are true or false can be enabled at server startup by naming them, or disabled by using a `--skip` prefix. For example, to enable or disable InnoDB checksums, you can use `--innodb_checksums` or `--skip-innodb_checksums` on the command line, or `innodb_checksums` or `skip-innodb_checksums` in an option file. System variables that take a numeric value can be specified as `--var_name=value` on the command line or as `var_name=value` in option files. For more information on specifying options and system variables, see Section 4.2.3, “Specifying Program Options”. Many of the system variables can be changed at runtime (see Section 5.1.5.2, “Dynamic System Variables”).

#### MySQL Enterprise

The MySQL Enterprise Monitor provides expert advice on InnoDB start-up options and related system variables. For more information, see <http://www.mysql.com/products/enterprise/advisors.html>.

**Table 13.5. `mysqld` InnoDB Option/Variable Reference**

Name	Cmd-Line	Option file	System Var	Status Var	Var Scope	Dynamic
<code>Com_show_innodb_status</code>				Yes	Both	No
<code>Com_show_ndb_status</code>				Yes	Both	No
<code>foreign_key_checks</code>			Yes		Session	Yes
<code>have_innodb</code>			Yes		Global	No
<code>innodb</code>	Yes	Yes				
<code>innodb_adaptive_hash_index</code>	Yes	Yes	Yes		Global	No
<code>innodb_additional_mem_pool_size</code>	Yes	Yes	Yes		Global	No
<code>innodb_autoextend_increment</code>	Yes	Yes	Yes		Global	Yes
<code>innodb_autoinc_lock_mode</code>	Yes	Yes	Yes		Global	No
<code>innodb_buffer_pool_awesome_mem_mb</code>	Yes	Yes	Yes		Global	No
<code>Innodb_buffer_pool_pages_data</code>				Yes	Global	No
<code>Innodb_buffer_pool_pages_dirty</code>				Yes	Global	No
<code>Innodb_buffer_pool_pages_flushed</code>				Yes	Global	No
<code>Innodb_buffer_pool_pages_free</code>				Yes	Global	No
<code>Innodb_buffer_pool_pages_latched</code>				Yes	Global	No
<code>Innodb_buffer_pool_pages_misc</code>				Yes	Global	No
<code>Innodb_buffer_pool_pages_total</code>				Yes	Global	No
<code>Innodb_buffer_pool_read_ahead_rnd</code>				Yes	Global	No

Name	Cmd-Line	Option file	System Var	Status Var	Var Scope	Dynamic
Innodb_buffer_pool_read_ahead_seq				Yes	Global	No
Innodb_buffer_pool_read_requests				Yes	Global	No
Innodb_buffer_pool_reads				Yes	Global	No
innodb_buffer_pool_size	Yes	Yes	Yes		Global	No
Innodb_buffer_pool_wait_free				Yes	Global	No
Innodb_buffer_pool_write_requests				Yes	Global	No
innodb_checksums	Yes	Yes	Yes		Global	No
innodb_commit_concurrency	Yes	Yes	Yes		Global	Yes
innodb_concurrency_tickets	Yes	Yes	Yes		Global	Yes
innodb_data_file_path	Yes	Yes	Yes		Global	No
Innodb_data_fsyncs				Yes	Global	No
innodb_data_home_dir	Yes	Yes	Yes		Global	No
Innodb_data_pending_fsyncs				Yes	Global	No
Innodb_data_pending_reads				Yes	Global	No
Innodb_data_pending_writes				Yes	Global	No
Innodb_data_read				Yes	Global	No
Innodb_data_reads				Yes	Global	No
Innodb_data_writes				Yes	Global	No
Innodb_data_written				Yes	Global	No
Innodb_dblwr_pages_written				Yes	Global	No
Innodb_dblwr_writes				Yes	Global	No
innodb_doublewrite	Yes	Yes	Yes		Global	No
innodb_fast_shutdown	Yes	Yes	Yes		Global	Yes
innodb_file_io_threads	Yes	Yes	Yes		Global	No
innodb_file_per_table	Yes	Yes	Yes		Global	No
innodb_flush_log_at_trx_commit	Yes	Yes	Yes		Global	Yes
innodb_flush_method	Yes	Yes	Yes		Global	No
innodb_force_recovery	Yes	Yes	Yes		Global	No
innodb_lock_wait_timeout	Yes	Yes	Yes		Global	No
innodb_locks_unsafe_for_binlog	Yes	Yes	Yes		Global	No
innodb_log_arch_dir	Yes	Yes	Yes		Global	No
innodb_log_archive	Yes	Yes	Yes		Global	No
innodb_log_buffer_size	Yes	Yes	Yes		Global	No
innodb_log_file_size	Yes	Yes	Yes		Global	No
innodb_log_files_in_group	Yes	Yes	Yes		Global	No
innodb_log_group_home_dir	Yes	Yes	Yes		Global	No
Innodb_log_waits				Yes	Global	No
Innodb_log_write_requests				Yes	Global	No
Innodb_log_writes				Yes	Global	No
innodb_max_dirty_pages_pct	Yes	Yes	Yes		Global	Yes
innodb_max_purge_lag	Yes	Yes	Yes		Global	Yes
innodb_mirrored_log_groups	Yes	Yes	Yes		Global	No
innodb_open_files	Yes	Yes	Yes		Global	No
Innodb_os_log_fsyncs				Yes	Global	No
Innodb_os_log_pending_fsyncs				Yes	Global	No
Innodb_os_log_pending_writes				Yes	Global	No
Innodb_os_log_written				Yes	Global	No



Name	Cmd-Line	Option file	System Var	Status Var	Var Scope	Dynamic
<a href="#">InnoDB_page_size</a>				Yes	Global	No
<a href="#">InnoDB_pages_created</a>				Yes	Global	No
<a href="#">InnoDB_pages_read</a>				Yes	Global	No
<a href="#">InnoDB_pages_written</a>				Yes	Global	No
<a href="#">innodb_rollback_on_timeout</a>	Yes	Yes	Yes		Global	No
<a href="#">InnoDB_row_lock_current_waits</a>				Yes	Global	No
<a href="#">InnoDB_row_lock_time</a>				Yes	Global	No
<a href="#">InnoDB_row_lock_time_avg</a>				Yes	Global	No
<a href="#">InnoDB_row_lock_time_max</a>				Yes	Global	No
<a href="#">InnoDB_row_lock_waits</a>				Yes	Global	No
<a href="#">InnoDB_rows_deleted</a>				Yes	Global	No
<a href="#">InnoDB_rows_inserted</a>				Yes	Global	No
<a href="#">InnoDB_rows_read</a>				Yes	Global	No
<a href="#">InnoDB_rows_updated</a>				Yes	Global	No
<a href="#">innodb_stats_on_metadata</a>	Yes	Yes	Yes		Global	Yes
<a href="#">innodb_status_file</a>	Yes	Yes				
<a href="#">innodb_support_xa</a>	Yes	Yes	Yes		Both	Yes
<a href="#">innodb_sync_spin_loops</a>	Yes	Yes	Yes		Global	Yes
<a href="#">innodb_table_locks</a>	Yes	Yes	Yes		Both	Yes
<a href="#">innodb_thread_concurrency</a>	Yes	Yes	Yes		Global	Yes
<a href="#">innodb_thread_sleep_delay</a>	Yes	Yes	Yes		Global	Yes
<a href="#">innodb_use_legacy_cardinality_algorithm</a>	Yes	Yes	Yes		Global	Yes
<a href="#">skip-innodb</a>	Yes	Yes				
<a href="#">skip-innodb-checksums</a>	Yes	Yes				
<a href="#">timed_mutexes</a>	Yes	Yes	Yes		Global	Yes
<a href="#">unique_checks</a>			Yes		Session	Yes

#### InnoDB command options:

- `--ignore-builtin-innodb`

This option that causes the server to behave as if the built-in InnoDB is not present. It causes other InnoDB options not to be recognized. This option was added in MySQL 5.1.33.

- `--innodb`

Enables the InnoDB storage engine, if the server was compiled with InnoDB support. Use `--skip-innodb` to disable InnoDB.

- `--innodb_status_file`

Controls whether InnoDB creates a file named `innodb_status.<pid>` in the MySQL data directory. If enabled, InnoDB periodically writes the output of `SHOW ENGINE INNODB STATUS` to this file.

By default, the file is not created. To create it, start `mysqld` with the `--innodb_status_file=1` option. The file is deleted during normal shutdown.

#### InnoDB system variables:

- `ignore_builtin_innodb`

Whether the server was started with the `--ignore-builtin-innodb` option, which causes the server to behave as if the built-in InnoDB is not present. This variable was added in MySQL 5.1.33.



- `innodb_adaptive_hash_index`

Whether InnoDB adaptive hash indexes are enabled or disabled (see [Section 13.6.10.4, “Adaptive Hash Indexes”](#)). This variable is enabled by default. Use `--skip-innodb_adaptive_hash_index` at server startup to disable it. This variable was added in MySQL 5.1.24.

- `innodb_additional_mem_pool_size`

The size in bytes of a memory pool InnoDB uses to store data dictionary information and other internal data structures. The more tables you have in your application, the more memory you need to allocate here. If InnoDB runs out of memory in this pool, it starts to allocate memory from the operating system and writes warning messages to the MySQL error log. The default value is 1MB.

- `innodb_autoextend_increment`

The increment size (in MB) for extending the size of an auto-extending tablespace file when it becomes full. The default value is 8.

- `innodb_buffer_pool_ave_mem_mb`

The size of the buffer pool (in MB), if it is placed in the AWE memory. If it is greater than 0, `innodb_buffer_pool_size` is the window in the 32-bit address space of `mysqld` where InnoDB maps that AWE memory. A good value for `innodb_buffer_pool_size` is 500MB. The maximum possible value is 63000.

To take advantage of AWE memory, you will need to recompile MySQL yourself. The current project settings needed for doing this can be found in the `storage/innobase/os/os0proc.c` source file.

This variable was removed in MySQL 5.1.13. Before that, it is relevant only in 32-bit Windows. If your 32-bit Windows operating system supports more than 4GB memory, using so-called “Address Windowing Extensions,” you can allocate the InnoDB buffer pool into the AWE physical memory using this variable.

- `innodb_autoinc_lock_mode`

The locking mode to use for generating auto-increment values. The allowable values are 0, 1, or 2, for “traditional”, “consecutive”, or “interleaved” lock mode, respectively. [Section 13.6.4.3, “AUTO\\_INCREMENT Handling in InnoDB”](#), describes the characteristics of these modes.

This variable was added in MySQL 5.1.22 with a default of 1 (“consecutive” lock mode). Before 5.1.22, InnoDB uses “traditional” lock mode.

- `innodb_buffer_pool_size`

The size in bytes of the memory buffer InnoDB uses to cache data and indexes of its tables. The default value is 8MB. The larger you set this value, the less disk I/O is needed to access data in tables. On a dedicated database server, you may set this to up to 80% of the machine physical memory size. However, do not set it too large because competition for physical memory might cause paging in the operating system.

- `innodb_checksums`

InnoDB can use checksum validation on all pages read from the disk to ensure extra fault tolerance against broken hardware or data files. This validation is enabled by default. However, under some rare circumstances (such as when running benchmarks) this extra safety feature is unneeded and can be disabled with `--skip-innodb-checksums`.

- `innodb_commit_concurrency`

The number of threads that can commit at the same time. A value of 0 (the default) allows any number of transactions to commit simultaneously.

As of MySQL 5.1.36, the value of `innodb_commit_concurrency` cannot be changed at runtime from zero to nonzero or vice versa. The value can still be changed from one nonzero value to another.

- `innodb_concurrency_tickets`

The number of threads that can enter InnoDB concurrently is determined by the `innodb_thread_concurrency` variable. A thread is placed in a queue when it tries to enter InnoDB if the number of threads has already reached the concurrency limit. When a thread is allowed to enter InnoDB, it is given a number of “free tickets” equal to the value of `innodb_concurrency_tickets`, and the thread can enter and leave InnoDB freely until it has used up its tickets. After that point, the thread again becomes subject to the concurrency check (and possible queuing) the next time it tries to enter InnoDB. The default value is 500.

- `innodb_data_file_path`

The paths to individual data files and their sizes. The full directory path to each data file is formed by concatenating `innodb_data_home_dir` to each path specified here. The file sizes are specified in KB, MB, or GB (1024MB) by appending `K`, `M`, or `G` to the size value. The sum of the sizes of the files must be at least 10MB. If you do not specify `innodb_data_file_path`, the default behavior is to create a single 10MB auto-extending data file named `ibdata1`. The size limit of individual files is determined by your operating system. You can set the file size to more than 4GB on those operating systems that support big files. You can also use raw disk partitions as data files. For detailed information on configuring InnoDB tablespace files, see [Section 13.6.2, “InnoDB Configuration”](#).

- `innodb_data_home_dir`

The common part of the directory path for all InnoDB data files. The default value is the MySQL data directory. If you specify the value as an empty string, you can use absolute file paths in `innodb_data_file_path`.

- `innodb_doublewrite`

If this variable is enabled (the default), InnoDB stores all data twice, first to the doublewrite buffer, and then to the actual data files. This variable can be turned off with `--skip-innodb_doublewrite` for benchmarks or cases when top performance is needed rather than concern for data integrity or possible failures.

- `innodb_fast_shutdown`

The InnoDB shutdown mode. By default, the value is 1, which causes a “fast” shutdown (the normal type of shutdown). If the value is 0, InnoDB does a full purge and an insert buffer merge before a shutdown. These operations can take minutes, or even hours in extreme cases. If the value is 1, InnoDB skips these operations at shutdown. If the value is 2, InnoDB will just flush its logs and then shut down cold, as if MySQL had crashed; no committed transaction will be lost, but crash recovery will be done at the next startup. A value of 2 cannot be used on NetWare.

- `innodb_file_io_threads`

The number of file I/O threads in InnoDB. Normally, this should be left at the default value of 4, but disk I/O on Windows may benefit from a larger number. On Unix, increasing the number has no effect; InnoDB always uses the default value.

- `innodb_file_per_table`

If `innodb_file_per_table` is disabled (the default), InnoDB creates tables in the shared tablespace. If `innodb_file_per_table` is enabled, InnoDB creates each new table using its own `.ibd` file for storing data and indexes, rather than in the shared tablespace. See [Section 13.6.2.1, “Using Per-Table Tablespaces”](#).

- `innodb_flush_log_at_trx_commit`

If the value of `innodb_flush_log_at_trx_commit` is 0, the log buffer is written out to the log file once per second and the flush to disk operation is performed on the log file, but nothing is done at a transaction commit. When the value is 1 (the default), the log buffer is written out to the log file at each transaction commit and the flush to disk operation is performed on the log file. When the value is 2, the log buffer is written out to the file at each commit, but the flush to disk operation is not performed on it. However, the flushing on the log file takes place once per second also when the value is 2. Note that the once-per-second flushing is not 100% guaranteed to happen every second, due to process scheduling issues.

The default value of 1 is the value required for ACID compliance. You can achieve better performance by setting the value different from 1, but then you can lose at most one second worth of transactions in a crash. With a value of 0, any `mysqld` process crash can erase the last second of transactions. With a value of 2, then only an operating system crash or a power outage can erase the last second of transactions. However, InnoDB's crash recovery is not affected and thus crash recovery does work regardless of the value.

For the greatest possible durability and consistency in a replication setup using InnoDB with transactions, use `innodb_flush_log_at_trx_commit = 1` and `sync_binlog = 1` in your master server `my.cnf` file.

### Caution

Many operating systems and some disk hardware fool the flush-to-disk operation. They may tell `mysqld` that the flush has taken place, even though it has not. Then the durability of transactions is not guaranteed even with the setting 1, and in the worst case a power outage can even corrupt the InnoDB database. Using a battery-backed disk cache in the SCSI disk controller or in the disk itself speeds up file flushes, and makes the operation safer. You can also try using the Unix command `hdparm` to disable the caching of disk writes in hardware caches, or use some other command specific to the hardware vendor.

- `innodb_flush_method`

By default, InnoDB uses `fsync()` to flush both the data and log files. If `innodb_flush_method` option is set to `O_DSYNC`, InnoDB uses `O_SYNC` to open and flush the log files, and `fsync()` to flush the data files. If `O_DIRECT` is specified (available on some GNU/Linux versions, FreeBSD, and Solaris), InnoDB uses `O_DIRECT` (or `directio()` on Solar-

is) to open the data files, and uses `fsync()` to flush both the data and log files. Note that InnoDB uses `fsync()` instead of `fdatasync()`, and it does not use `O_DSYNC` by default because there have been problems with it on many varieties of Unix. This variable is relevant only for Unix. On Windows, the flush method is always `async_unbuffered` and cannot be changed.

Different values of this variable can have a marked effect on InnoDB performance. For example, on some systems where InnoDB data and log files are located on a SAN, it has been found that setting `innodb_flush_method` to `O_DIRECT` can degrade performance of simple `SELECT` statements by a factor of three.

Formerly it was possible to specify a value of `fdatasync` to obtain the default behavior. This is no longer possible as of MySQL 5.1.24 because it can be confusing that a value of `fdatasync` causes use of `fsync()` rather than `fdatasync()` for flushing.

- `innodb_force_recovery`

The crash recovery mode. Possible values are from 0 to 6. The meanings of these values are described in [Section 13.6.6.2, “Forcing InnoDB Recovery”](#).

### Warning

This variable should be set greater than 0 only in an emergency situation when you want to dump your tables from a corrupt database! As a safety measure, InnoDB prevents any changes to its data when this variable is greater than 0.

- `innodb_lock_wait_timeout`

The timeout in seconds an InnoDB transaction may wait for a row lock before giving up. The default value is 50 seconds. A transaction that tries to access a row that is locked by another InnoDB transaction will hang for at most this many seconds before issuing the following error:

```
ERROR 1205 (HY000): Lock wait timeout exceeded; try restarting transaction
```

When a lock wait timeout occurs, the current statement is not executed. The current transaction is *not* rolled back. (To have the entire transaction roll back, start the server with the `--innodb_rollback_on_timeout` option, available as of MySQL 5.1.15. See also [Section 13.6.12, “InnoDB Error Handling”](#).)

`innodb_lock_wait_timeout` applies to InnoDB row locks only. A MySQL table lock does not happen inside InnoDB and this timeout does not apply to waits for table locks.

InnoDB does detect transaction deadlocks in its own lock table immediately and rolls back one transaction. The lock wait timeout value does not apply to such a wait.

- `innodb_locks_unsafe_for_binlog`

This variable affects how InnoDB uses gap locking for searches and index scans. Normally, InnoDB uses an algorithm called *next-key locking* that combines index-row locking with gap locking. InnoDB performs row-level locking in such a way that when it searches or scans a table index, it sets shared or exclusive locks on the index records it encounters. Thus, the row-level locks are actually index-record locks. In addition, a next-key lock on an index record also affects the “gap” before that index record. That is, a next-key lock is an index-record lock plus a gap lock on the gap preceding the index record. If one session has a shared or exclusive lock on record *R* in an index, another session cannot insert a new index record in the gap immediately before *R* in the index order. See [Section 13.6.8.4, “InnoDB Record, Gap, and Next-Key Locks”](#).

By default, the value of `innodb_locks_unsafe_for_binlog` is 0 (disabled), which means that gap locking is enabled: InnoDB uses next-key locks for searches and index scans. To enable the variable, set it to 1. This causes gap locking to be disabled: InnoDB uses only index-record locks for searches and index scans.

Enabling `innodb_locks_unsafe_for_binlog` does not disable the use of gap locking for foreign-key constraint checking or duplicate-key checking.

The effect of enabling `innodb_locks_unsafe_for_binlog` is similar to but not identical to setting the transaction isolation level to `READ COMMITTED`:

- Enabling `innodb_locks_unsafe_for_binlog` is a global setting and affects all sessions, whereas the isolation level can be set globally for all sessions, or individually per session.
- `innodb_locks_unsafe_for_binlog` can be set only at server startup, whereas the isolation level can be set at startup or changed at runtime.

`READ COMMITTED` therefore offers finer and more flexible control than `innodb_locks_unsafe_for_binlog`. For additional details about the effect of isolation level on gap locking, see [Section 12.4.6, “SET TRANSACTION Syntax”](#).

Enabling `innodb_locks_unsafe_for_binlog` may cause phantom problems because other sessions can insert new rows into the gaps when gap locking is disabled. Suppose that there is an index on the `id` column of the `child` table and that you want to read and lock all rows from the table having an identifier value larger than 100, with the intention of updating some column in the selected rows later:

```
SELECT * FROM child WHERE id > 100 FOR UPDATE;
```

The query scans the index starting from the first record where `id` is greater than 100. If the locks set on the index records in that range do not lock out inserts made in the gaps, another session can insert a new row into the table. Consequently, if you were to execute the same `SELECT` again within the same transaction, you would see a new row in the result set returned by the query. This also means that if new items are added to the database, `InnoDB` does not guarantee serializability. Therefore, if `innodb_locks_unsafe_for_binlog` is enabled, `InnoDB` guarantees at most an isolation level of `READ COMMITTED`. (Conflict serializability is still guaranteed.) For additional information about phantoms, see [Section 13.6.8.5, “Avoiding the Phantom Problem Using Next-Key Locking”](#).

Enabling `innodb_locks_unsafe_for_binlog` has additional effects:

- For `UPDATE` or `DELETE` statements, `InnoDB` holds locks only for rows that it updates or deletes. Record locks for non-matching rows are released after MySQL has evaluated the `WHERE` condition. This greatly reduces the probability of deadlocks, but they can still happen.
- For `UPDATE` statements, if a row is already locked, `InnoDB` performs a “semi-consistent” read, returning the latest committed version to MySQL so that MySQL can determine whether the row matches the `WHERE` condition of the `UPDATE`. If the row matches (must be updated), MySQL reads the row again and this time `InnoDB` either locks it or waits for a lock on it.

Consider the following example, beginning with this table:

```
CREATE TABLE t (a INT NOT NULL, b INT) ENGINE = InnoDB;
INSERT INTO t VALUES (1,2), (2,3), (3,2), (4,3), (5,2);
COMMIT;
```

In this case, table has no indexes, so searches and index scans use the hidden clustered index for record locking (see [Section 13.6.10.1, “Clustered and Secondary Indexes”](#)).

Suppose that one client performs an `UPDATE` using these statements:

```
SET autocommit = 0;
UPDATE t SET b = 5 WHERE b = 3;
```

Suppose also that a second client performs an `UPDATE` by executing these statements following those of the first client:

```
SET autocommit = 0;
UPDATE t SET b = 4 WHERE b = 2;
```

As `InnoDB` executes each `UPDATE`, it first acquires an exclusive lock for each row, and then determines whether to modify it. If `InnoDB` does not modify the row and `innodb_locks_unsafe_for_binlog` is enabled, it releases the lock. Otherwise, `InnoDB` retains the lock until the end of the transaction. This affects transaction processing as follows.

If `innodb_locks_unsafe_for_binlog` is disabled, the first `UPDATE` acquires x-locks and does not release any of them:

```
x-lock(1,2); retain x-lock
x-lock(2,3); update(2,3) to (2,5); retain x-lock
x-lock(3,2); retain x-lock
x-lock(4,3); update(4,3) to (4,5); retain x-lock
x-lock(5,2); retain x-lock
```

The second `UPDATE` blocks as soon as it tries to acquire any locks (because first update has retained locks on all rows), and does not proceed until the first `UPDATE` commits or rolls back:

```
x-lock(1,2); block and wait for first UPDATE to commit or roll back
```

If `innodb_locks_unsafe_for_binlog` is enabled, the first `UPDATE` acquires x-locks and releases those for rows that it does not modify:

```
x-lock(1,2); unlock(1,2)
x-lock(2,3); update(2,3) to (2,5); retain x-lock
x-lock(3,2); unlock(3,2)
x-lock(4,3); update(4,3) to (4,5); retain x-lock
x-lock(5,2); unlock(5,2)
```

For the second `UPDATE`, `InnoDB` does a “semi-consistent” read, returning the latest committed version of each row to MySQL so that MySQL can determine whether the row matches the `WHERE` condition of the `UPDATE`:

```
x-lock(1,2); update(1,2) to (1,4); retain x-lock
x-lock(2,3); unlock(2,3)
x-lock(3,2); update(3,2) to (3,4); retain x-lock
x-lock(4,3); unlock(4,3)
x-lock(5,2); update(5,2) to (5,4); retain x-lock
```

Semi-consistent read is available as of MySQL 5.1.5. Before 5.1.5, the second `UPDATE` proceeds part way before it blocks. It begins acquiring x-locks, and blocks when it tries to acquire one for a row still locked by first `UPDATE`. The second `UPDATE` does not proceed until the first `UPDATE` commits or rolls back:

```
x-lock(1,2); update(1,2) to (1,4); retain x-lock
x-lock(2,3); block and wait for first UPDATE to commit or roll back
```

In this case, the second `UPDATE` must wait for a commit or rollback of the first `UPDATE`, even though it affects different rows. The first `UPDATE` has an exclusive lock on row (2,3) that it has not released. As the second `UPDATE` scans rows, it tries to acquire an exclusive lock for that same row, which it cannot have. Thus, before MySQL 5.1.5, enabling `innodb_locks_unsafe_for_binlog` still does not allow operations such as `UPDATE` to overtake other similar operations (such as another `UPDATE`) even when they affect different rows.

- `innodb_log_arch_dir`

This variable is deprecated, and was removed in MySQL 5.1.21.

- `innodb_log_archive`

This variable is deprecated, and was removed in MySQL 5.1.18.

- `innodb_log_buffer_size`

The size in bytes of the buffer that `InnoDB` uses to write to the log files on disk. The default value is 1MB. Sensible values range from 1MB to 8MB. A large log buffer allows large transactions to run without a need to write the log to disk before the transactions commit. Thus, if you have big transactions, making the log buffer larger saves disk I/O.

- `innodb_log_file_size`

The size in bytes of each log file in a log group. The combined size of log files must be less than 4GB. The default value is 5MB. Sensible values range from 1MB to 1/*N*-th of the size of the buffer pool, where *N* is the number of log files in the group. The larger the value, the less checkpoint flush activity is needed in the buffer pool, saving disk I/O. But larger log files also mean that recovery is slower in case of a crash.

- `innodb_log_files_in_group`

The number of log files in the log group. `InnoDB` writes to the files in a circular fashion. The default (and recommended) value is 2.

- `innodb_log_group_home_dir`

The directory path to the `InnoDB` log files. If you do not specify any `InnoDB` log variables, the default is to create two 5MB files names `ib_logfile0` and `ib_logfile1` in the MySQL data directory.

- `innodb_max_dirty_pages_pct`

This is an integer in the range from 0 to 100. The default value is 90. The main thread in `InnoDB` tries to write pages from the buffer pool so that the percentage of dirty (not yet written) pages will not exceed this value.

- `innodb_max_purge_lag`

This variable controls how to delay `INSERT`, `UPDATE`, and `DELETE` operations when purge operations are lagging (see [Section 13.6.9, “InnoDB Multi-Versioning”](#)). The default value 0 (no delays).

The `InnoDB` transaction system maintains a list of transactions that have delete-marked index records by `UPDATE` or `DELETE` operations. Let the length of this list be `purge_lag`. When `purge_lag` exceeds `innodb_max_purge_lag`, each `INSERT`, `UPDATE`, and `DELETE` operation is delayed by  $((\text{purge\_lag}/\text{innodb\_max\_purge\_lag}) \times 10) - 5$  milliseconds. The delay is computed in the beginning of a purge batch, every ten seconds. The operations are not delayed if purge cannot run because of an old consistent read view that could see the rows to be purged.

A typical setting for a problematic workload might be 1 million, assuming that transactions are small, only 100 bytes in size, and it is allowable to have 100MB of unpurged `InnoDB` table rows.

- `innodb_mirrored_log_groups`

The number of identical copies of log groups to keep for the database. This should be set to 1.

- `innodb_open_files`

This variable is relevant only if you use multiple tablespaces in `InnoDB`. It specifies the maximum number of `.ibd` files that `InnoDB` can keep open at one time. The minimum value is 10. The default value is 300.

The file descriptors used for `.ibd` files are for `InnoDB` only. They are independent of those specified by the `-open-files-limit` server option, and do not affect the operation of the table cache.

- `innodb_rollback_on_timeout`

In MySQL 5.1, `InnoDB` rolls back only the last statement on a transaction timeout by default. If `-innodb_rollback_on_timeout` is specified, a transaction timeout causes `InnoDB` to abort and roll back the entire transaction (the same behavior as in MySQL 4.1). This variable was added in MySQL 5.1.15.

- `innodb_stats_on_metadata`

When this variable is enabled (which is the default, as before the variable was created), `InnoDB` updates statistics during metadata statements such as `SHOW TABLE STATUS` or `SHOW INDEX`, or when accessing the `INFORMATION_SCHEMA` tables `TABLES` or `STATISTICS`. (These updates are similar to what happens for `ANALYZE TABLE`.) When disabled, `InnoDB` does not update statistics during these operations. Disabling this variable can improve access speed for schemas that have a large number of tables or indexes. It can also improve the stability of execution plans for queries that involve `InnoDB` tables.

This variable was added in MySQL 5.1.17.

- `innodb_support_xa`

When the variable is enabled (the default), `InnoDB` support for two-phase commit in XA transactions is enabled, which causes an extra disk flush for transaction preparation.

If you do not wish to use XA transactions, you can disable this variable to reduce the number of disk flushes and get better `InnoDB` performance.

Having `innodb_support_xa` enabled on a replication master — or on any MySQL server where binary logging is in use — ensures that the binary log does not get out of sync compared to the table data.

- `innodb_sync_spin_loops`

The number of times a thread waits for an `InnoDB` mutex to be freed before the thread is suspended. The default value is 20.

- `innodb_table_locks`

If `autocommit = 0`, `InnoDB` honors `LOCK TABLES`; MySQL does not return from `LOCK TABLES ... WRITE` until all other threads have released all their locks to the table. The default value of `innodb_table_locks` is 1, which means that `LOCK TABLES` causes `InnoDB` to lock a table internally if `autocommit = 0`.

- `innodb_thread_concurrency`

`InnoDB` tries to keep the number of operating system threads concurrently inside `InnoDB` less than or equal to the limit given by this variable. Once the number of threads reaches this limit, additional threads are placed into a wait state within a FIFO queue for execution. Threads waiting for locks are not counted in the number of concurrently executing threads.

The correct value for this variable is dependent on environment and workload. You will need to try a range of different values to determine what value works for your applications.

The range of this variable is 0 to 1000. A value of 20 or higher is interpreted as infinite concurrency before MySQL 5.1.12. From 5.1.12 on, you can disable thread concurrency checking by setting the value to 0. Disabling thread concurrency checking allows `InnoDB` to create as many threads as it needs.

The default value is 20 before MySQL 5.1.11, and 8 from 5.1.11 on.

- `innodb_thread_sleep_delay`

How long `InnoDB` threads sleep before joining the `InnoDB` queue, in microseconds. The default value is 10,000. A value of 0 disables sleep.

- `innodb_use_legacy_cardinality_algorithm`



InnoDB uses random numbers to generate dives into indexes for calculating index cardinality. However, under certain conditions, the algorithm does not generate random numbers, so `ANALYZE TABLE` sometimes does not update cardinality estimates properly. An alternative algorithm was introduced in MySQL 5.1.35 with better randomization properties, and the `innodb_use_legacy_cardinality_algorithm`, system variable which algorithm to use. The default value of the variable is 1 (ON), to use the original algorithm for compatibility with existing applications. The variable can be set to 0 (OFF) to use the new algorithm with improved randomness.

- `sync_binlog`

If the value of this variable is greater than 0, the MySQL server synchronizes its binary log to disk (using `fdatasync()`) after every `sync_binlog` writes to the binary log. There is one write to the binary log per statement if autocommit is enabled, and one write per transaction otherwise. The default value of `sync_binlog` is 0, which does no synchronizing to disk. A value of 1 is the safest choice, because in the event of a crash you lose at most one statement or transaction from the binary log. However, it is also the slowest choice (unless the disk has a battery-backed cache, which makes synchronization very fast).

## 13.6.4. Creating and Using InnoDB Tables

To create an InnoDB table, specify an `ENGINE = InnoDB` option in the `CREATE TABLE` statement:

```
CREATE TABLE customers (a INT, b CHAR (20), INDEX (a)) ENGINE=InnoDB;
```

The statement creates a table and an index on column `a` in the InnoDB tablespace that consists of the data files that you specified in `my.cnf`. In addition, MySQL creates a file `customers.frm` in the `test` directory under the MySQL database directory. Internally, InnoDB adds an entry for the table to its own data dictionary. The entry includes the database name. For example, if `test` is the database in which the `customers` table is created, the entry is for `'test/customers'`. This means you can create a table of the same name `customers` in some other database, and the table names do not collide inside InnoDB.

You can query the amount of free space in the InnoDB tablespace by issuing a `SHOW TABLE STATUS` statement for any InnoDB table. The amount of free space in the tablespace appears in the `Data_free` section in the output of `SHOW TABLE STATUS` (or the `Comment` section prior to MySQL 5.1.24). For example:

```
SHOW TABLE STATUS FROM test LIKE 'customers'
```

The statistics `SHOW` displays for InnoDB tables are only approximate. They are used in SQL optimization. Table and index reserved sizes in bytes are accurate, though.

### 13.6.4.1. How to Use Transactions in InnoDB with Different APIs

By default, each client that connects to the MySQL server begins with autocommit mode enabled, which automatically commits every SQL statement as you execute it. To use multiple-statement transactions, you can switch autocommit off with the SQL statement `SET autocommit = 0` and end each transaction with either `COMMIT` or `ROLLBACK`. If you want to leave autocommit on, you can begin your transactions within `START TRANSACTION` and end them with `COMMIT` or `ROLLBACK`. The following example shows two transactions. The first is committed; the second is rolled back.

```
shell> mysql test
mysql> CREATE TABLE customer (a INT, b CHAR (20), INDEX (a))
-> ENGINE=InnoDB;
Query OK, 0 rows affected (0.00 sec)
mysql> START TRANSACTION;
Query OK, 0 rows affected (0.00 sec)
mysql> INSERT INTO customer VALUES (10, 'Heikki');
Query OK, 1 row affected (0.00 sec)
mysql> COMMIT;
Query OK, 0 rows affected (0.00 sec)
mysql> SET autocommit=0;
Query OK, 0 rows affected (0.00 sec)
mysql> INSERT INTO customer VALUES (15, 'John');
Query OK, 1 row affected (0.00 sec)
mysql> ROLLBACK;
Query OK, 0 rows affected (0.00 sec)
mysql> SELECT * FROM customer;
+-----+-----+
| a    | b      |
+-----+-----+
| 10  | Heikki |
+-----+-----+
1 row in set (0.00 sec)
mysql>
```

In APIs such as PHP, Perl DBI, JDBC, ODBC, or the standard C call interface of MySQL, you can send transaction control statements such as `COMMIT` to the MySQL server as strings just like any other SQL statements such as `SELECT` or `INSERT`. Some APIs also offer separate special transaction commit and rollback functions or methods.

### 13.6.4.2. Converting Tables from Other Storage Engines to InnoDB

To convert a non-InnoDB table to use InnoDB use `ALTER TABLE`:

```
ALTER TABLE t1 ENGINE=InnoDB;
```

#### Important

Do not convert MySQL system tables in the `mysql` database (such as `user` or `host`) to the InnoDB type. This is an unsupported operation. The system tables must always be of the MyISAM type.

InnoDB does not have a special optimization for separate index creation the way the MyISAM storage engine does. Therefore, it does not pay to export and import the table and create indexes afterward. The fastest way to alter a table to InnoDB is to do the inserts directly to an InnoDB table. That is, use `ALTER TABLE ... ENGINE=INNODB`, or create an empty InnoDB table with identical definitions and insert the rows with `INSERT INTO ... SELECT * FROM ...`.

If you have `UNIQUE` constraints on secondary keys, you can speed up a table import by turning off the uniqueness checks temporarily during the import operation:

```
SET unique_checks=0;
... import operation ...
SET unique_checks=1;
```

For big tables, this saves a lot of disk I/O because InnoDB can then use its insert buffer to write secondary index records as a batch. Be certain that the data contains no duplicate keys. `unique_checks` allows but does not require storage engines to ignore duplicate keys.

To get better control over the insertion process, it might be good to insert big tables in pieces:

```
INSERT INTO newtable SELECT * FROM oldtable
WHERE yourkey > something AND yourkey <= somethingelse;
```

After all records have been inserted, you can rename the tables.

During the conversion of big tables, you should increase the size of the InnoDB buffer pool to reduce disk I/O. Do not use more than 80% of the physical memory, though. You can also increase the sizes of the InnoDB log files.

Make sure that you do not fill up the tablespace: InnoDB tables require a lot more disk space than MyISAM tables. If an `ALTER TABLE` operation runs out of space, it starts a rollback, and that can take hours if it is disk-bound. For inserts, InnoDB uses the insert buffer to merge secondary index records to indexes in batches. That saves a lot of disk I/O. For rollback, no such mechanism is used, and the rollback can take 30 times longer than the insertion.

In the case of a runaway rollback, if you do not have valuable data in your database, it may be advisable to kill the database process rather than wait for millions of disk I/O operations to complete. For the complete procedure, see [Section 13.6.6.2, “Forcing InnoDB Recovery”](#).

If you want all your (non-system) tables to be created as InnoDB tables, add the line `default-storage-engine=innodb` to the `[mysqld]` section of your server option file.

### 13.6.4.3. AUTO\_INCREMENT Handling in InnoDB

Beginning with MySQL 5.1.22, InnoDB provides a locking strategy that significantly improves scalability and performance of SQL statements that add rows to tables with `AUTO_INCREMENT` columns. This section provides background information on the original (“traditional”) implementation of auto-increment locking in InnoDB, explains the configurable locking mechanism, documents the parameter for configuring the mechanism, and describes its behavior and interaction with replication.

#### 13.6.4.3.1. “Traditional” InnoDB Auto-Increment Locking

The original implementation of auto-increment handling in InnoDB uses the following strategy to prevent problems when using the binary log for statement-based replication or for certain recovery scenarios.

If you specify an `AUTO_INCREMENT` column for an InnoDB table, the table handle in the InnoDB data dictionary contains a special counter called the auto-increment counter that is used in assigning new values for the column. This counter is stored only in main memory, not on disk.

InnoDB uses the following algorithm to initialize the auto-increment counter for a table `t` that contains an `AUTO_INCREMENT` column named `ai_col`: After a server startup, for the first insert into a table `t`, InnoDB executes the equivalent of this statement:

```
SELECT MAX(ai_col) FROM t FOR UPDATE;
```



`InnoDB` increments by one the value retrieved by the statement and assigns it to the column and to the auto-increment counter for the table. If the table is empty, `InnoDB` uses the value 1. If a user invokes a `SHOW TABLE STATUS` statement that displays output for the table `t` and the auto-increment counter has not been initialized, `InnoDB` initializes but does not increment the value and stores it for use by later inserts. This initialization uses a normal exclusive-locking read on the table and the lock lasts to the end of the transaction.

`InnoDB` follows the same procedure for initializing the auto-increment counter for a freshly created table.

After the auto-increment counter has been initialized, if a user does not explicitly specify a value for an `AUTO_INCREMENT` column, `InnoDB` increments the counter by one and assigns the new value to the column. If the user inserts a row that explicitly specifies the column value, and the value is bigger than the current counter value, the counter is set to the specified column value.

When accessing the auto-increment counter, `InnoDB` uses a special table-level `AUTO-INC` lock that it keeps to the end of the current SQL statement, not to the end of the transaction. The special lock release strategy was introduced to improve concurrency for inserts into a table containing an `AUTO_INCREMENT` column. Nevertheless, two transactions cannot have the `AUTO-INC` lock on the same table simultaneously, which can have a performance impact if the `AUTO-INC` lock is held for a long time. That might be the case for a statement such as `INSERT INTO t1 ... SELECT ... FROM t2` that inserts all rows from one table into another.

`InnoDB` uses the in-memory auto-increment counter as long as the server runs. When the server is stopped and restarted, `InnoDB` reinitializes the counter for each table for the first `INSERT` to the table, as described earlier.

You may see gaps in the sequence of values assigned to the `AUTO_INCREMENT` column if you roll back transactions that have generated numbers using the counter.

If a user specifies `NULL` or 0 for the `AUTO_INCREMENT` column in an `INSERT`, `InnoDB` treats the row as if the value had not been specified and generates a new value for it.

The behavior of the auto-increment mechanism is not defined if a user assigns a negative value to the column or if the value becomes bigger than the maximum integer that can be stored in the specified integer type.

An `AUTO_INCREMENT` column must appear as the first column in an index on an `InnoDB` table.

`InnoDB` supports the `AUTO_INCREMENT = N` table option in `CREATE TABLE` and `ALTER TABLE` statements, to set the initial counter value or alter the current counter value. The effect of this option is canceled by a server restart, for reasons discussed earlier in this section.

### 13.6.4.3.2. Configurable `InnoDB` Auto-Increment Locking

As described in the previous section, `InnoDB` uses a special lock called the table-level `AUTO-INC` lock for inserts into tables with `AUTO_INCREMENT` columns. This lock is normally held to the end of the statement (not to the end of the transaction), to ensure that auto-increment numbers are assigned in a predictable and repeatable order for a given sequence of `INSERT` statements.

In the case of statement-based replication, this means that when an SQL statement is replicated on a slave server, the same values are used for the auto-increment column as on the master server. The result of execution of multiple `INSERT` statements is deterministic, and the slave reproduces the same data as on the master. If auto-increment values generated by multiple `INSERT` statements were interleaved, the result of two concurrent `INSERT` statements would be non-deterministic, and could not reliably be propagated to a slave server using statement-based replication.

To make this clear, consider an example that uses this table:

```
CREATE TABLE t1 (
  c1 INT(11) NOT NULL AUTO_INCREMENT,
  c2 VARCHAR(10) DEFAULT NULL,
  PRIMARY KEY (c1)
) ENGINE=InnoDB;
```

Suppose that there are two transactions running, each inserting rows into a table with an `AUTO_INCREMENT` column. One transaction is using an `INSERT ... SELECT` statement that inserts 1000 rows, and another is using a simple `INSERT` statement that inserts one row:

```
Tx1: INSERT INTO t1 (c2) SELECT 1000 rows from another table ...
Tx2: INSERT INTO t1 (c2) VALUES ('xxx');
```

`InnoDB` cannot tell in advance how many rows will be retrieved from the `SELECT` in the `INSERT` statement in Tx1, and it assigns the auto-increment values one at a time as the statement proceeds. With a table-level lock, held to the end of the statement, only one `INSERT` statement referring to table `t1` can execute at a time, and the generation of auto-increment numbers by different statements is not interleaved. The auto-increment value generated by the Tx1 `INSERT ... SELECT` statement will be consecutive, and the (single) auto-increment value used by the `INSERT` statement in Tx2 will either be smaller or larger than all those used for Tx1, depending on which statement executes first.

As long as the SQL statements execute in the same order when replayed from the binary log (when using statement-based replication, or in recovery scenarios), the results will be the same as they were when Tx1 and Tx2 first ran. Thus, table-level locks held until the end of a statement make `INSERT` statements using auto-increment safe for use with statement-based replication. However, those locks limit concurrency and scalability when multiple transactions are executing insert statements at the same time.

In the preceding example, if there were no table-level lock, the value of the auto-increment column used for the `INSERT` in Tx2 depends on precisely when the statement executes. If the `INSERT` of Tx2 executes while the `INSERT` of Tx1 is running (rather than before it starts or after it completes), the specific auto-increment values assigned by the two `INSERT` statements are non-deterministic, and may vary from run to run.

As of MySQL 5.1.22, `InnoDB` can avoid using the table-level `AUTO-INC` lock for a class of `INSERT` statements where the number of rows is known in advance, and still preserve deterministic execution and safety for statement-based replication. Further, if you are not using the binary log to replay SQL statements as part of recovery or replication, you can entirely eliminate use of the table-level `AUTO-INC` lock for even greater concurrency and performance—at the cost of permitting gaps in auto-increment numbers assigned by a statement and potentially having the numbers assigned by concurrently executing statements interleaved.

For `INSERT` statements where the number of rows to be inserted is known at the beginning of processing the statement, `InnoDB` quickly allocates the required number of auto-increment values without taking any lock, but only if there is no concurrent session already holding the table-level `AUTO-INC` lock (because that other statement will be allocating auto-increment values one-by-one as it proceeds). More precisely, such an `INSERT` statement obtains auto-increment values under the control of a mutex (a light-weight lock) that is *not* held until the statement completes, but only for the duration of the allocation process.

This new locking scheme allows much greater scalability, but it does introduce some subtle differences in how auto-increment values are assigned compared to the original mechanism. To describe the way auto-increment works in `InnoDB`, the following discussion defines some terms, and explains how `InnoDB` behaves using different settings of the new `innodb_autoinc_lock_mode` configuration parameter. Additional considerations are described following the explanation of auto-increment locking behavior.

First, some definitions:

- “`INSERT-like`” statements

All statements that generate new rows in a table, including `INSERT`, `INSERT ... SELECT`, `REPLACE`, `REPLACE ... SELECT`, and `LOAD DATA`.

- “Simple inserts”

Statements for which the number of rows to be inserted can be determined in advance (when the statement is initially processed). This includes single-row and multiple-row `INSERT` and `REPLACE` statements that do not have a nested subquery, but not `INSERT ... ON DUPLICATE KEY UPDATE`.

- “Bulk inserts”

Statements for which the number of rows to be inserted (and the number of required auto-increment values) is not known in advance. This includes `INSERT ... SELECT`, `REPLACE ... SELECT`, and `LOAD DATA` statements. `InnoDB` will assign new values for the `AUTO_INCREMENT` column one at a time as each row is processed.

- “Mixed-mode inserts”

These are “simple insert” statements that specify the auto-increment value for some (but not all) of the new rows. An example follows, where `c1` is an `AUTO_INCREMENT` column of table `t1`:

```
INSERT INTO t1 (c1,c2) VALUES (1,'a'), (NULL,'b'), (5,'c'), (NULL,'d');
```

Another type of “mixed-mode insert” is `INSERT ... ON DUPLICATE KEY UPDATE`, which in the worst case is in effect an `INSERT` followed by a `UPDATE`, where the allocated value for the `AUTO_INCREMENT` column may or may not be used during the update phase.

Beginning with MySQL 5.1.22, there is a configuration parameter that controls how `InnoDB` uses locking when generating values for `AUTO_INCREMENT` columns. This parameter can be set using the `--innodb-autoinc-lock-mode` option at `mysqld` startup.

In general, if you encounter problems with the way auto-increment works (which will most likely involve replication), you can force use of the original behavior by setting the lock mode to 0.

There are three possible settings for the `innodb_autoinc_lock_mode` parameter:

- `innodb_autoinc_lock_mode = 0` (“traditional” lock mode)

This lock mode provides the same behavior as before `innodb_autoinc_lock_mode` existed. For all “INSERT-like” statements, a special table-level `AUTO-INC` lock is obtained and held to the end of the statement. This assures that the auto-increment values assigned by any given statement are consecutive (although “gaps” can exist within a table if a transaction that generated auto-increment values is rolled back, as discussed later).

This lock mode is provided only for backward compatibility and performance testing. There is little reason to use this lock mode unless you use “mixed-mode inserts” and care about the important difference in semantics described later.

- `innodb_autoinc_lock_mode = 1` (“consecutive” lock mode)

This is the default lock mode. In this mode, “bulk inserts” use the special `AUTO-INC` table-level lock and hold it until the end of the statement. This applies to all `INSERT ... SELECT`, `REPLACE ... SELECT`, and `LOAD DATA` statements. Only one statement holding the `AUTO-INC` lock can execute at a time.

With this lock mode, “simple inserts” (only) use a new locking model where a light-weight mutex is used during the allocation of auto-increment values, and no table-level `AUTO-INC` lock is used, unless an `AUTO-INC` lock is held by another transaction. If another transaction does hold an `AUTO-INC` lock, a “simple insert” waits for the `AUTO-INC` lock, as if it too were a “bulk insert.”

This lock mode ensures that, in the presence of `INSERT` statements where the number of rows is not known in advance (and where auto-increment numbers are assigned as the statement progresses), all auto-increment values assigned by any “INSERT-like” statement are consecutive, and operations are safe for statement-based replication.

Simply put, the important impact of this lock mode is significantly better scalability. This mode is safe for use with statement-based replication. Further, as with “traditional” lock mode, auto-increment numbers assigned by any given statement are *consecutive*. In this mode, there is *no change* in semantics compared to “traditional” mode for any statement that uses auto-increment, with one important exception.

The exception is for “mixed-mode inserts”, where the user provides explicit values for an `AUTO_INCREMENT` column for some, but not all, rows in a multiple-row “simple insert.” For such inserts, `InnoDB` will allocate more auto-increment values than the number of rows to be inserted. However, all values automatically assigned are consecutively generated (and thus higher than) the auto-increment value generated by the most recently executed previous statement. “Excess” numbers are lost.

A similar situation exists if you use `INSERT ... ON DUPLICATE KEY UPDATE`. This statement is also classified as a “mixed-mode insert” since an auto-increment value is not necessarily generated for each row. Because `InnoDB` allocates the auto-increment value before the insert is actually attempted, it cannot know whether an inserted value will be a duplicate of an existing value and thus cannot know whether the auto-increment value it generates will be used for a new row. Therefore, if you are using statement-based replication, you must either avoid `INSERT ... ON DUPLICATE KEY UPDATE` or use `innodb_autoinc_lock_mode = 0` (“traditional” lock mode).

- `innodb_autoinc_lock_mode = 2` (“interleaved” lock mode)

In this lock mode, no “INSERT-like” statements use the table-level `AUTO-INC` lock, and multiple statements can execute at the same time. This is the fastest and most scalable lock mode, but it is *not safe* when using statement-based replication or recovery scenarios when SQL statements are replayed from the binary log.

In this lock mode, auto-increment values are guaranteed to be unique and monotonically increasing across all concurrently executing “INSERT-like” statements. However, because multiple statements can be generating numbers at the same time (that is, allocation of numbers is *interleaved* across statements), the values generated for the rows inserted by any given statement may not be consecutive.

If the only statements executing are “simple inserts” where the number of rows to be inserted is known ahead of time, there will be no gaps in the numbers generated for a single statement, except for “mixed-mode inserts.” However, when “bulk inserts” are executed, there may be gaps in the auto-increment values assigned by any given statement.

The auto-increment locking modes provided by `innodb_autoinc_lock_mode` have several usage implications:

- Using auto-increment with replication

If you are using statement-based replication, you should set `innodb_autoinc_lock_mode` to 0 or 1 and use the same value on the master and its slaves. Auto-increment values are not ensured to be the same on the slaves as on the master if you use `innodb_autoinc_lock_mode = 2` (“interleaved”) or configurations where the master and slaves do not use the same lock mode.

If you are using row-based replication, all of the auto-increment lock modes are safe. Row-based replication is not sensitive to the order of execution of the SQL statements.

- “Lost” auto-increment values and sequence gaps

In all lock modes (0, 1, and 2), if a transaction that generated auto-increment values rolls back, those auto-increment values are “lost.” Once a value is generated for an auto-increment column, it cannot be rolled back, whether or not the “`INSERT`-like” statement is completed, and whether or not the containing transaction is rolled back. Such lost values are not reused. Thus, there may be gaps in the values stored in an `AUTO_INCREMENT` column of a table.

- Auto-increment values assigned by “mixed-mode inserts”

Consider a “mixed-mode insert,” where a “simple insert” specifies the auto-increment value for some (but not all) resulting rows. Such a statement will behave differently in lock modes 0, 1, and 2. For example, assume `c1` is an `AUTO_INCREMENT` column of table `t1`, and that the most recent automatically generated sequence number is 100. Consider the following “mixed-mode insert” statement:

```
INSERT INTO t1 (c1,c2) VALUES (1,'a'), (NULL,'b'), (5,'c'), (NULL,'d');
```

With `innodb_autoinc_lock_mode` set to 0 (“traditional”), the four new rows will be:

c1	c2
1	a
101	b
5	c
102	d

The next available auto-increment value will be 103 because the auto-increment values are allocated one at a time, not all at once at the beginning of statement execution. This result is true whether or not there are concurrently executing “`INSERT`-like” statements (of any type).

With `innodb_autoinc_lock_mode` set to 1 (“consecutive”), the four new rows will also be:

c1	c2
1	a
101	b
5	c
102	d

However, in this case, the next available auto-increment value will be 105, not 103 because four auto-increment values are allocated at the time the statement is processed, but only two are used. This result is true whether or not there are concurrently executing “`INSERT`-like” statements (of any type).

With `innodb_autoinc_lock_mode` set to mode 2 (“interleaved”), the four new rows will be:

c1	c2
1	a
<i>x</i>	b
5	c
<i>y</i>	d

The values of *x* and *y* will be unique and larger than any previously generated rows. However, the specific values of *x* and *y* will depend on the number of auto-increment values generated by concurrently executing statements.

Finally, consider the following statement, issued when the most-recently generated sequence number was the value 4:

```
INSERT INTO t1 (c1,c2) VALUES (1,'a'), (NULL,'b'), (5,'c'), (NULL,'d');
```

With any `innodb_autoinc_lock_mode` setting, this statement will generate a duplicate-key error 23000 (`Can't write; duplicate key in table`) because 5 will be allocated for the row (`NULL, 'b'`) and insertion of the row (`5, 'c'`) will fail.

- Gaps in auto-increment values for “bulk inserts”

With `innodb_autoinc_lock_mode` set to 0 (“traditional”) or 1 (“consecutive”), the auto-increment values generated by any given statement will be consecutive, without gaps, because the table-level `AUTO-INC` lock is held until the end of the statement, and only one such statement can execute at a time.

With `innodb_autoinc_lock_mode` set to 2 (“interleaved”), there may be gaps in the auto-increment values generated by

“bulk inserts,” but only if there are concurrently executing “INSERT-like” statements.

### 13.6.4.4. FOREIGN KEY Constraints

InnoDB supports foreign key constraints. The syntax for a foreign key constraint definition in InnoDB looks like this:

```
[CONSTRAINT symbol] FOREIGN KEY
  [index_name] (index_col_name, ...)
REFERENCES tbl_name (index_col_name, ...)
[ON DELETE reference_option]
[ON UPDATE reference_option]

reference_option:
  RESTRICT | CASCADE | SET NULL | NO ACTION
```

*index\_name* represents a foreign key ID. If given, this is ignored if an index for the foreign key is defined explicitly. Otherwise, if InnoDB creates an index for the foreign key, it uses *index\_name* for the index name.

Foreign key definitions are subject to the following conditions:

- Both tables must be InnoDB tables and they must not be TEMPORARY tables.
- Corresponding columns in the foreign key and the referenced key must have similar internal data types inside InnoDB so that they can be compared without a type conversion. *The size and sign of integer types must be the same.* The length of string types need not be the same. For nonbinary (character) string columns, the character set and collation must be the same.
- InnoDB requires indexes on foreign keys and referenced keys so that foreign key checks can be fast and not require a table scan. In the referencing table, there must be an index where the foreign key columns are listed as the *first* columns in the same order. Such an index is created on the referencing table automatically if it does not exist. (This is in contrast to some older versions, in which indexes had to be created explicitly or the creation of foreign key constraints would fail.) *index\_name*, if given, is used as described previously.
- InnoDB allows a foreign key to reference any index column or group of columns. However, in the referenced table, there must be an index where the referenced columns are listed as the *first* columns in the same order.
- Index prefixes on foreign key columns are not supported. One consequence of this is that BLOB and TEXT columns cannot be included in a foreign key because indexes on those columns must always include a prefix length.
- If the CONSTRAINT *symbol* clause is given, the *symbol* value must be unique in the database. If the clause is not given, InnoDB creates the name automatically.

InnoDB rejects any INSERT or UPDATE operation that attempts to create a foreign key value in a child table if there is no a matching candidate key value in the parent table. The action InnoDB takes for any UPDATE or DELETE operation that attempts to update or delete a candidate key value in the parent table that has some matching rows in the child table is dependent on the *referential action* specified using ON UPDATE and ON DELETE subclauses of the FOREIGN KEY clause. When the user attempts to delete or update a row from a parent table, and there are one or more matching rows in the child table, InnoDB supports five options regarding the action to be taken. If ON DELETE or ON UPDATE are not specified, the default action is RESTRICT.

- **CASCADE:** Delete or update the row from the parent table and automatically delete or update the matching rows in the child table. Both ON DELETE CASCADE and ON UPDATE CASCADE are supported. Between two tables, you should not define several ON UPDATE CASCADE clauses that act on the same column in the parent table or in the child table.

#### Note

Currently, cascaded foreign key actions do not activate triggers.

- **SET NULL:** Delete or update the row from the parent table and set the foreign key column or columns in the child table to NULL. This is valid only if the foreign key columns do not have the NOT NULL qualifier specified. Both ON DELETE SET NULL and ON UPDATE SET NULL clauses are supported.

If you specify a SET NULL action, *make sure that you have not declared the columns in the child table as NOT NULL.*

- **NO ACTION:** In standard SQL, NO ACTION means *no action* in the sense that an attempt to delete or update a primary key value is not allowed to proceed if there is a related foreign key value in the referenced table. InnoDB rejects the delete or update operation for the parent table.
- **RESTRICT:** Rejects the delete or update operation for the parent table. Specifying RESTRICT (or NO ACTION) is the same as omitting the ON DELETE or ON UPDATE clause. (Some database systems have deferred checks, and NO ACTION is a de-

ferred check. In MySQL, foreign key constraints are checked immediately, so `NO ACTION` is the same as `RESTRICT`.)

- `SET DEFAULT`: This action is recognized by the parser, but `InnoDB` rejects table definitions containing `ON DELETE SET DEFAULT` or `ON UPDATE SET DEFAULT` clauses.

`InnoDB` supports foreign key references within a table. In these cases, “child table records” really refers to dependent records within the same table.

Here is a simple example that relates `parent` and `child` tables through a single-column foreign key:

```
CREATE TABLE parent (id INT NOT NULL,
                     PRIMARY KEY (id))
ENGINE=INNODB;
CREATE TABLE child (id INT, parent_id INT,
                    INDEX par_ind (parent_id),
                    FOREIGN KEY (parent_id) REFERENCES parent(id)
                    ON DELETE CASCADE)
ENGINE=INNODB;
```

A more complex example in which a `product_order` table has foreign keys for two other tables. One foreign key references a two-column index in the `product` table. The other references a single-column index in the `customer` table:

```
CREATE TABLE product (category INT NOT NULL, id INT NOT NULL,
                      price DECIMAL,
                      PRIMARY KEY(category, id)) ENGINE=INNODB;
CREATE TABLE customer (id INT NOT NULL,
                       PRIMARY KEY (id)) ENGINE=INNODB;
CREATE TABLE product_order (no INT NOT NULL AUTO_INCREMENT,
                             product_category INT NOT NULL,
                             product_id INT NOT NULL,
                             customer_id INT NOT NULL,
                             PRIMARY KEY(no),
                             INDEX (product_category, product_id),
                             FOREIGN KEY (product_category, product_id)
                             REFERENCES product(category, id)
                             ON UPDATE CASCADE ON DELETE RESTRICT,
                             INDEX (customer_id),
                             FOREIGN KEY (customer_id)
                             REFERENCES customer(id)) ENGINE=INNODB;
```

`InnoDB` allows you to add a new foreign key constraint to a table by using `ALTER TABLE`:

```
ALTER TABLE tbl_name
ADD [CONSTRAINT [symbol]] FOREIGN KEY
[index_name] (index_col_name, ...)
REFERENCES tbl_name (index_col_name,...)
[ON DELETE reference_option]
[ON UPDATE reference_option]
```

The foreign key can be self referential (referring to the same table). When you add a foreign key constraint to a table using `ALTER TABLE`, *remember to create the required indexes first*.

`InnoDB` supports the use of `ALTER TABLE` to drop foreign keys:

```
ALTER TABLE tbl_name DROP FOREIGN KEY fk_symbol;
```

If the `FOREIGN KEY` clause included a `CONSTRAINT` name when you created the foreign key, you can refer to that name to drop the foreign key. Otherwise, the `fk_symbol` value is internally generated by `InnoDB` when the foreign key is created. To find out the symbol value when you want to drop a foreign key, use the `SHOW CREATE TABLE` statement. For example:

```
mysql> SHOW CREATE TABLE ibtest11c\G
***** 1. row *****
      Table: ibtest11c
Create Table: CREATE TABLE `ibtest11c` (
  `A` int(11) NOT NULL auto_increment,
  `D` int(11) NOT NULL default '0',
  `B` varchar(200) NOT NULL default '',
  `C` varchar(175) default NULL,
  PRIMARY KEY (`A`,`D`,`B`),
  KEY `B` (`B`,`C`),
  KEY `C` (`C`),
  CONSTRAINT `0_38775` FOREIGN KEY (`A`, `D`)
REFERENCES `ibtest11a` (`A`, `D`)
ON DELETE CASCADE ON UPDATE CASCADE,
  CONSTRAINT `0_38776` FOREIGN KEY (`B`, `C`)
REFERENCES `ibtest11a` (`B`, `C`)
ON DELETE CASCADE ON UPDATE CASCADE
) ENGINE=INNODB CHARSET=latin1
1 row in set (0.01 sec)

mysql> ALTER TABLE ibtest11c DROP FOREIGN KEY `0_38775`;
```



You cannot add a foreign key and drop a foreign key in separate clauses of a single `ALTER TABLE` statement. Separate statements are required.

If `ALTER TABLE` for an `InnoDB` table results in changes to column values (for example, because a column is truncated), `InnoDB`'s `FOREIGN KEY` constraint checks do not notice possible violations caused by changing the values.

The `InnoDB` parser allows table and column identifiers in a `FOREIGN KEY ... REFERENCES ...` clause to be quoted with in backticks. (Alternatively, double quotes can be used if the `ANSI_QUOTES SQL` mode is enabled.) The `InnoDB` parser also takes into account the setting of the `lower_case_table_names` system variable.

`InnoDB` returns a table's foreign key definitions as part of the output of the `SHOW CREATE TABLE` statement:

```
SHOW CREATE TABLE tbl_name;
```

`mysqldump` also produces correct definitions of tables in the dump file, and does not forget about the foreign keys.

You can also display the foreign key constraints for a table like this:

```
SHOW TABLE STATUS FROM db_name LIKE 'tbl_name';
```

The foreign key constraints are listed in the `Comment` column of the output.

When performing foreign key checks, `InnoDB` sets shared row-level locks on child or parent records it has to look at. `InnoDB` checks foreign key constraints immediately; the check is not deferred to transaction commit.

To make it easier to reload dump files for tables that have foreign key relationships, `mysqldump` automatically includes a statement in the dump output to set `foreign_key_checks` to 0. This avoids problems with tables having to be reloaded in a particular order when the dump is reloaded. It is also possible to set this variable manually:

```
mysql> SET foreign_key_checks = 0;
mysql> SOURCE dump_file_name;
mysql> SET foreign_key_checks = 1;
```

This allows you to import the tables in any order if the dump file contains tables that are not correctly ordered for foreign keys. It also speeds up the import operation. Setting `foreign_key_checks` to 0 can also be useful for ignoring foreign key constraints during `LOAD DATA` and `ALTER TABLE` operations. However, even if `foreign_key_checks = 0`, `InnoDB` does not allow the creation of a foreign key constraint where a column references a non-matching column type. Also, if an `InnoDB` table has foreign key constraints, `ALTER TABLE` cannot be used to change the table to use another storage engine. To alter the storage engine, you must drop any foreign key constraints first.

`InnoDB` does not allow you to drop a table that is referenced by a `FOREIGN KEY` constraint, unless you do `SET foreign_key_checks = 0`. When you drop a table, the constraints that were defined in its create statement are also dropped.

If you re-create a table that was dropped, it must have a definition that conforms to the foreign key constraints referencing it. It must have the right column names and types, and it must have indexes on the referenced keys, as stated earlier. If these are not satisfied, MySQL returns error number 1005 and refers to error 150 in the error message.

If MySQL reports an error number 1005 from a `CREATE TABLE` statement, and the error message refers to error 150, table creation failed because a foreign key constraint was not correctly formed. Similarly, if an `ALTER TABLE` fails and it refers to error 150, that means a foreign key definition would be incorrectly formed for the altered table. You can use `SHOW ENGINE INNODB STATUS` to display a detailed explanation of the most recent `InnoDB` foreign key error in the server.

### Important

For users familiar with the ANSI/ISO SQL Standard, please note that no storage engine, including `InnoDB`, recognizes or enforces the `MATCH` clause used in referential-integrity constraint definitions. Use of an explicit `MATCH` clause will not have the specified effect, and also causes `ON DELETE` and `ON UPDATE` clauses to be ignored. For these reasons, specifying `MATCH` should be avoided.

The `MATCH` clause in the SQL standard controls how `NULL` values in a composite (multiple-column) foreign key are handled when comparing to a primary key. `InnoDB` essentially implements the semantics defined by `MATCH SIMPLE`, which allow a foreign key to be all or partially `NULL`. In that case, the (child table) row containing such a foreign key is allowed to be inserted, and does not match any row in the referenced (parent) table. It is possible to implement other semantics using triggers.

Additionally, MySQL and `InnoDB` require that the referenced columns be indexed for performance. However, the system does not enforce a requirement that the referenced columns be `UNIQUE` or be declared `NOT NULL`. The handling of foreign key references to non-unique keys or keys that contain `NULL` values is not well defined for operations such as `UPDATE` or `DELETE CASCADE`. You are advised to use foreign keys that reference only `UNIQUE` and `NOT NULL` keys.

Furthermore, **InnoDB** does not recognize or support “inline **REFERENCES** specifications” (as defined in the SQL standard) where the references are defined as part of the column specification. **InnoDB** accepts **REFERENCES** clauses only when specified as part of a separate **FOREIGN KEY** specification. For other storage engines, MySQL Server parses and ignores foreign key specifications.

**Deviation from SQL standards:** If there are several rows in the parent table that have the same referenced key value, **InnoDB** acts in foreign key checks as if the other parent rows with the same key value do not exist. For example, if you have defined a **RESTRICT** type constraint, and there is a child row with several parent rows, **InnoDB** does not allow the deletion of any of those parent rows.

**InnoDB** performs cascading operations through a depth-first algorithm, based on records in the indexes corresponding to the foreign key constraints.

**Deviation from SQL standards:** A **FOREIGN KEY** constraint that references a non-**UNIQUE** key is not standard SQL. It is an **InnoDB** extension to standard SQL.

**Deviation from SQL standards:** If **ON UPDATE CASCADE** or **ON UPDATE SET NULL** recurses to update the *same table* it has previously updated during the cascade, it acts like **RESTRICT**. This means that you cannot use self-referential **ON UPDATE CASCADE** or **ON UPDATE SET NULL** operations. This is to prevent infinite loops resulting from cascaded updates. A self-referential **ON DELETE SET NULL**, on the other hand, is possible, as is a self-referential **ON DELETE CASCADE**. Cascading operations may not be nested more than 15 levels deep.

**Deviation from SQL standards:** Like MySQL in general, in an SQL statement that inserts, deletes, or updates many rows, **InnoDB** checks **UNIQUE** and **FOREIGN KEY** constraints row-by-row. According to the SQL standard, the default behavior should be deferred checking. That is, constraints are only checked after the *entire SQL statement* has been processed. Until **InnoDB** implements deferred constraint checking, some things will be impossible, such as deleting a record that refers to itself via a foreign key.

### 13.6.4.5. **InnoDB** and MySQL Replication

MySQL replication works for **InnoDB** tables as it does for **MyISAM** tables. It is also possible to use replication in a way where the storage engine on the slave is not the same as the original storage engine on the master. For example, you can replicate modifications to an **InnoDB** table on the master to a **MyISAM** table on the slave.

To set up a new slave for a master, you have to make a copy of the **InnoDB** tablespace and the log files, as well as the **.frm** files of the **InnoDB** tables, and move the copies to the slave. If the `innodb_file_per_table` variable is enabled, you must also copy the **.ibd** files as well. For the proper procedure to do this, see [Section 13.6.6, “Backing Up and Recovering an InnoDB Database”](#).

If you can shut down the master or an existing slave, you can take a cold backup of the **InnoDB** tablespace and log files and use that to set up a slave. To make a new slave without taking down any server you can also use the commercial **InnoDB Hot Backup tool**.

You cannot set up replication for **InnoDB** using the **LOAD TABLE FROM MASTER** statement, which works only for **MyISAM** tables. There are two possible workarounds:

- Dump the table on the master and import the dump file into the slave.
- Use **ALTER TABLE *tbl\_name* ENGINE=MyISAM** on the master before setting up replication with **LOAD TABLE *tbl\_name* FROM MASTER**, and then use **ALTER TABLE** to convert the master table back to **InnoDB** afterward. However, this should not be done for tables that have foreign key definitions because the definitions will be lost.

Transactions that fail on the master do not affect replication at all. MySQL replication is based on the binary log where MySQL writes SQL statements that modify data. A transaction that fails (for example, because of a foreign key violation, or because it is rolled back) is not written to the binary log, so it is not sent to slaves. See [Section 12.4.1, “START TRANSACTION, COMMIT, and ROLLBACK Syntax”](#).

**Replication and CASCADE.** Cascading actions for **InnoDB** tables on the master are replicated on the slave *only* if the tables sharing the foreign key relation use **InnoDB** on both the master and slave. This is true whether you are using statement-based or row-based replication. For example, suppose you have started replication, and then create two tables on the master using the following **CREATE TABLE** statements:

```
CREATE TABLE fc1 (
  i INT PRIMARY KEY,
  j INT
) ENGINE = InnoDB;

CREATE TABLE fc2 (
  m INT PRIMARY KEY,
  n INT,
  FOREIGN KEY ni (n) REFERENCES fc1 (i)
```



```

    ON DELETE CASCADE
) ENGINE = InnoDB;

```

Suppose that the slave does not have `InnoDB` support enabled. If this is the case, then the tables on the slave are created, but they use the `MyISAM` storage engine, and the `FOREIGN KEY` option is ignored. Now we insert some rows into the tables on the master:

```

master> INSERT INTO fc1 VALUES (1, 1), (2, 2);
Query OK, 2 rows affected (0.09 sec)
Records: 2 Duplicates: 0 Warnings: 0

master> INSERT INTO fc2 VALUES (1, 1), (2, 2), (3, 1);
Query OK, 3 rows affected (0.19 sec)
Records: 3 Duplicates: 0 Warnings: 0

```

At this point, on both the master and the slave, table `fc1` contains 2 rows, and table `fc2` contains 3 rows, as shown here:

```

master> SELECT * FROM fc1;
+----+----+
| i  | j  |
+----+----+
| 1  | 1  |
| 2  | 2  |
+----+----+
2 rows in set (0.00 sec)

master> SELECT * FROM fc2;
+----+----+
| m  | n  |
+----+----+
| 1  | 1  |
| 2  | 2  |
| 3  | 1  |
+----+----+
3 rows in set (0.00 sec)

slave> SELECT * FROM fc1;
+----+----+
| i  | j  |
+----+----+
| 1  | 1  |
| 2  | 2  |
+----+----+
2 rows in set (0.00 sec)

slave> SELECT * FROM fc2;
+----+----+
| m  | n  |
+----+----+
| 1  | 1  |
| 2  | 2  |
| 3  | 1  |
+----+----+
3 rows in set (0.00 sec)

```

Now suppose that you perform the following `DELETE` statement on the master:

```

master> DELETE FROM fc1 WHERE i=1;
Query OK, 1 row affected (0.09 sec)

```

Due to the cascade, table `fc2` on the master now contains only 1 row:

```

master> SELECT * FROM fc2;
+----+----+
| m  | n  |
+----+----+
| 2  | 2  |
+----+----+
1 row in set (0.00 sec)

```

However, the cascade does not propagate on the slave because on the slave the `DELETE` for `fc1` deletes no rows from `fc2`. The slave's copy of `fc2` still contains all of the rows that were originally inserted:

```

slave> SELECT * FROM fc2;
+----+----+
| m  | n  |
+----+----+
| 1  | 1  |
| 3  | 1  |
| 2  | 2  |
+----+----+
3 rows in set (0.00 sec)

```

This difference is due to the fact that the cascading deletes are handled internally by the `InnoDB` storage engine, which means that none of the changes are logged.

### 13.6.5. Adding, Removing, or Resizing `InnoDB` Data and Log Files

This section describes what you can do when your `InnoDB` tablespace runs out of room or when you want to change the size of the log files.

The easiest way to increase the size of the **InnoDB** tablespace is to configure it from the beginning to be auto-extending. Specify the `autoextend` attribute for the last data file in the tablespace definition. Then **InnoDB** increases the size of that file automatically in 8MB increments when it runs out of space. The increment size can be changed by setting the value of the `innodb_autoextend_increment` system variable, which is measured in MB.

Alternatively, you can increase the size of your tablespace by adding another data file. To do this, you have to shut down the MySQL server, change the tablespace configuration to add a new data file to the end of `innodb_data_file_path`, and start the server again.

If your last data file was defined with the keyword `autoextend`, the procedure for reconfiguring the tablespace must take into account the size to which the last data file has grown. Obtain the size of the data file, round it down to the closest multiple of  $1024 \times 1024$  bytes (= 1MB), and specify the rounded size explicitly in `innodb_data_file_path`. Then you can add another data file. Remember that only the last data file in the `innodb_data_file_path` can be specified as auto-extending.

As an example, assume that the tablespace has just one auto-extending data file `ibdata1`:

```
innodb_data_home_dir =
innodb_data_file_path = /ibdata/ibdata1:10M:autoextend
```

Suppose that this data file, over time, has grown to 988MB. Here is the configuration line after modifying the original data file to not be auto-extending and adding another auto-extending data file:

```
innodb_data_home_dir =
innodb_data_file_path = /ibdata/ibdata1:988M;/disk2/ibdata2:50M:autoextend
```

When you add a new file to the tablespace configuration, make sure that it does not exist. **InnoDB** will create and initialize the file when you restart the server.

Currently, you cannot remove a data file from the tablespace. To decrease the size of your tablespace, use this procedure:

1. Use `mysqldump` to dump all your **InnoDB** tables.
2. Stop the server.
3. Remove all the existing tablespace files, including the `ibdata` and `ib_log` files. If you want to keep a backup copy of the information, then copy all the `ib*` files to another location before the removing the files in your MySQL installation.
4. Remove any `.frm` files for **InnoDB** tables.
5. Configure a new tablespace.
6. Restart the server.
7. Import the dump files.

If you want to change the number or the size of your **InnoDB** log files, use the following instructions. The procedure to use depends on the value of `innodb_fast_shutdown`:

- If `innodb_fast_shutdown` is not set to 2: Stop the MySQL server and make sure that it shuts down without errors (to ensure that there is no information for outstanding transactions in the log). Copy the old log files into a safe place in case something went wrong during the shutdown and you need them to recover the tablespace. Delete the old log files from the log file directory, edit `my.cnf` to change the log file configuration, and start the MySQL server again. `mysqld` sees that no **InnoDB** log files exist at startup and creates new ones.
- If `innodb_fast_shutdown` is set to 2: Set `innodb_fast_shutdown` to 1:

```
mysql> SET GLOBAL innodb_fast_shutdown = 1;
```

Then follow the instructions in the previous item.

## 13.6.6. Backing Up and Recovering an **InnoDB** Database

The key to safe database management is making regular backups.

**InnoDB Hot Backup** enables you to back up a running MySQL database, including **InnoDB** and **MyISAM** tables, with minimal disruption to operations while producing a consistent snapshot of the database. When **InnoDB Hot Backup** is copying **In-**

`noDB` tables, reads and writes to both `InnoDB` and `MyISAM` tables can continue. During the copying of `MyISAM` tables, reads (but not writes) to those tables are permitted. In addition, `InnoDB Hot Backup` supports creating compressed backup files, and performing backups of subsets of `InnoDB` tables. In conjunction with MySQL's binary log, users can perform point-in-time recovery. `InnoDB Hot Backup` is commercially licensed by Innobase Oy. For a more complete description of `InnoDB Hot Backup`, see <http://www.innodb.com/hot-backup/features/> or download the documentation from [http://www.innodb.com/doc/hot\\_backup/manual.html](http://www.innodb.com/doc/hot_backup/manual.html). You can order trial, term, and perpetual licenses from Innobase at <http://www.innodb.com/hot-backup/order/>.

If you are able to shut down your MySQL server, you can make a binary backup that consists of all files used by `InnoDB` to manage its tables. Use the following procedure:

1. Shut down your MySQL server and make sure that it shuts down without errors.
2. Copy all your data files (`ibdata` files and `.ibd` files) into a safe place.
3. Copy all your `ib_logfile` files to a safe place.
4. Copy your `my.cnf` configuration file or files to a safe place.
5. Copy all the `.frm` files for your `InnoDB` tables to a safe place.

Replication works with `InnoDB` tables, so you can use MySQL replication capabilities to keep a copy of your database at database sites requiring high availability.

In addition to making binary backups as just described, you should also regularly make dumps of your tables with `mysqldump`. The reason for this is that a binary file might be corrupted without you noticing it. Dumped tables are stored into text files that are human-readable, so spotting table corruption becomes easier. Also, because the format is simpler, the chance for serious data corruption is smaller. `mysqldump` also has a `--single-transaction` option that you can use to make a consistent snapshot without locking out other clients. See [Section 6.2.1, “Backup Policy”](#).

To be able to recover your `InnoDB` database to the present from the binary backup just described, you have to run your MySQL server with binary logging turned on. To achieve point-in-time recovery after restoring a backup, you can apply changes from the binary log that occurred after the backup was made. See [Section 6.3, “Point-in-Time Recovery”](#).

To recover from a crash of your MySQL server, the only requirement is to restart it. `InnoDB` automatically checks the logs and performs a roll-forward of the database to the present. `InnoDB` automatically rolls back uncommitted transactions that were present at the time of the crash. During recovery, `mysqld` displays output something like this:

```
InnoDB: Database was not shut down normally.
InnoDB: Starting recovery from log files...
InnoDB: Starting log scan based on checkpoint at
InnoDB: log sequence number 0 13674004
InnoDB: Doing recovery: scanned up to log sequence number 0 13739520
InnoDB: Doing recovery: scanned up to log sequence number 0 13805056
InnoDB: Doing recovery: scanned up to log sequence number 0 13870592
InnoDB: Doing recovery: scanned up to log sequence number 0 13936128
...
InnoDB: Doing recovery: scanned up to log sequence number 0 20555264
InnoDB: Doing recovery: scanned up to log sequence number 0 20620800
InnoDB: Doing recovery: scanned up to log sequence number 0 20664692
InnoDB: 1 uncommitted transaction(s) which must be rolled back
InnoDB: Starting rollback of uncommitted transactions
InnoDB: Rolling back trx no 16745
InnoDB: Rolling back of trx no 16745 completed
InnoDB: Rollback of uncommitted transactions completed
InnoDB: Starting an apply batch of log records to the database...
InnoDB: Apply batch completed
InnoDB: Started
mysqld: ready for connections
```

If your database gets corrupted or your disk fails, you have to do the recovery from a backup. In the case of corruption, you should first find a backup that is not corrupted. After restoring the base backup, do the recovery from the binary log files using `mysql-binlog` and `mysql` to restore the changes that occurred after the backup was made.

In some cases of database corruption it is enough just to dump, drop, and re-create one or a few corrupt tables. You can use the `CHECK TABLE` SQL statement to check whether a table is corrupt, although `CHECK TABLE` naturally cannot detect every possible kind of corruption. You can use the Tablespace Monitor to check the integrity of the file space management inside the tablespace files.

In some cases, apparent database page corruption is actually due to the operating system corrupting its own file cache, and the data on disk may be okay. It is best first to try restarting your computer. Doing so may eliminate errors that appeared to be database page corruption.

### 13.6.6.1. The `InnoDB` Recovery Process

InnoDB crash recovery consists of several steps. The first step, redo log application, is performed during the initialization, before accepting any connections. If all changes were flushed from the buffer pool to the tablespaces (`ibdata*` and `*.ibd` files) at the time of the shutdown or crash, the redo log application can be skipped. If the redo log files are missing at startup, InnoDB skips the redo log application.

The remaining steps after redo log application do not depend on the redo log (other than for logging the writes) and are performed in parallel with normal processing. These include:

- Rolling back incomplete transactions: Any transactions that were active at the time of crash or fast shutdown.
- Insert buffer merge: Applying changes from the insert buffer tree (from the shared tablespace) to leaf pages of secondary indexes as the index pages are read to the buffer pool.
- Purge: Deleting delete-marked records that are no longer visible for any active transaction.

Of these, only rollback of incomplete transactions is special to crash recovery. The insert buffer merge and the purge are performed during normal processing.

### 13.6.6.2. Forcing InnoDB Recovery

If there is database page corruption, you may want to dump your tables from the database with `SELECT INTO ... OUTFILE`. Usually, most of the data obtained in this way is intact. However, it is possible that the corruption might cause `SELECT * FROM tbl_name` statements or InnoDB background operations to crash or assert, or even cause InnoDB roll-forward recovery to crash. In such cases, you can use the `innodb_force_recovery` option to force the InnoDB storage engine to start up while preventing background operations from running, so that you are able to dump your tables. For example, you can add the following line to the `[mysqld]` section of your option file before restarting the server:

```
[mysqld]
innodb_force_recovery = 4
```

`innodb_force_recovery` is 0 by default (normal startup without forced recovery). The allowable nonzero values for `innodb_force_recovery` follow. A larger number includes all precautions of smaller numbers. If you are able to dump your tables with an option value of at most 4, then you are relatively safe that only some data on corrupt individual pages is lost. A value of 6 is more drastic because database pages are left in an obsolete state, which in turn may introduce more corruption into B-trees and other database structures.

- 1 (`SRV_FORCE_IGNORE_CORRUPT`)

Let the server run even if it detects a corrupt page. Try to make `SELECT * FROM tbl_name` jump over corrupt index records and pages, which helps in dumping tables.

- 2 (`SRV_FORCE_NO_BACKGROUND`)

Prevent the main thread from running. If a crash would occur during the purge operation, this recovery value prevents it.

- 3 (`SRV_FORCE_NO_TRX_UNDO`)

Do not run transaction rollbacks after recovery.

- 4 (`SRV_FORCE_NO_IBUF_MERGE`)

Prevent insert buffer merge operations. If they would cause a crash, do not do them. Do not calculate table statistics.

- 5 (`SRV_FORCE_NO_UNDO_LOG_SCAN`)

Do not look at undo logs when starting the database: InnoDB treats even incomplete transactions as committed.

- 6 (`SRV_FORCE_NO_LOG_REDO`)

Do not do the log roll-forward in connection with recovery.

The database must not otherwise be used with any nonzero value of `innodb_force_recovery`. As a safety measure, InnoDB prevents users from performing `INSERT`, `UPDATE`, or `DELETE` operations when `innodb_force_recovery` is greater than 0.

You can `SELECT` from tables to dump them, or `DROP` or `CREATE` tables even if forced recovery is used. If you know that a given table is causing a crash on rollback, you can drop it. You can also use this to stop a runaway rollback caused by a failing mass import or `ALTER TABLE`. You can kill the `mysqld` process and set `innodb_force_recovery` to 3 to bring the database up

without the rollback, then [DROP](#) the table that is causing the runaway rollback.

### 13.6.6.3. InnoDB Checkpoints

[InnoDB](#) implements a checkpoint mechanism known as “fuzzy” checkpointing. [InnoDB](#) flushes modified database pages from the buffer pool in small batches. There is no need to flush the buffer pool in one single batch, which would in practice stop processing of user SQL statements during the checkpointing process.

During crash recovery, [InnoDB](#) looks for a checkpoint label written to the log files. It knows that all modifications to the database before the label are present in the disk image of the database. Then [InnoDB](#) scans the log files forward from the checkpoint, applying the logged modifications to the database.

[InnoDB](#) writes to its log files on a rotating basis. All committed modifications that make the database pages in the buffer pool different from the images on disk must be available in the log files in case [InnoDB](#) has to do a recovery. This means that when [InnoDB](#) starts to reuse a log file, it has to make sure that the database page images on disk contain the modifications logged in the log file that [InnoDB](#) is going to reuse. In other words, [InnoDB](#) must create a checkpoint and this often involves flushing of modified database pages to disk.

The preceding description explains why making your log files very large may reduce disk I/O in checkpointing. It often makes sense to set the total size of the log files as large as the buffer pool or even larger. The disadvantage of using large log files is that crash recovery can take longer because there is more logged information to apply to the database.

### 13.6.7. Moving an InnoDB Database to Another Machine

On Windows, [InnoDB](#) always stores database and table names internally in lowercase. To move databases in a binary format from Unix to Windows or from Windows to Unix, you should create all databases and tables using lowercase names. A convenient way to accomplish this is to add the following line to the `[mysqld]` section of your `my.cnf` or `my.ini` file before creating any databases or tables:

```
[mysqld]
lower_case_table_names=1
```

Like [MyISAM](#) data files, [InnoDB](#) data and log files are binary-compatible on all platforms having the same floating-point number format. You can move an [InnoDB](#) database simply by copying all the relevant files listed in [Section 13.6.6, “Backing Up and Recovering an InnoDB Database”](#). If the floating-point formats differ but you have not used `FLOAT` or `DOUBLE` data types in your tables, then the procedure is the same: simply copy the relevant files. If you use `mysqldump` to dump your tables on one machine and then import the dump files on the other machine, it does not matter whether the formats differ or your tables contain floating-point data.

One way to increase performance is to switch off autocommit mode when importing data, assuming that the tablespace has enough space for the big rollback segment that the import transactions generate. Do the commit only after importing a whole table or a segment of a table.

### 13.6.8. The InnoDB Transaction Model and Locking

In the [InnoDB](#) transaction model, the goal is to combine the best properties of a multi-versioning database with traditional two-phase locking. [InnoDB](#) does locking on the row level and runs queries as non-locking consistent reads by default, in the style of Oracle. The lock table in [InnoDB](#) is stored so space-efficiently that lock escalation is not needed: Typically several users are allowed to lock every row in [InnoDB](#) tables, or any random subset of the rows, without causing [InnoDB](#) memory exhaustion.

In [InnoDB](#), all user activity occurs inside a transaction. If autocommit mode is enabled, each SQL statement forms a single transaction on its own. By default, MySQL starts the session for each new connection with autocommit enabled, so MySQL does a commit after each SQL statement if that statement did not return an error. If a statement returns an error, the commit or rollback behavior depends on the error. See [Section 13.6.12, “InnoDB Error Handling”](#).

A session that has autocommit enabled can perform a multiple-statement transaction by starting it with an explicit `START TRANSACTION` or `BEGIN` statement and ending it with a `COMMIT` or `ROLLBACK` statement.

If autocommit mode is disabled within a session with `SET autocommit = 0`, the session always has a transaction open. A `COMMIT` or `ROLLBACK` statement ends the current transaction and a new one starts.

A `COMMIT` means that the changes made in the current transaction are made permanent and become visible to other sessions. A `ROLLBACK` statement, on the other hand, cancels all modifications made by the current transaction. Both `COMMIT` and `ROLLBACK` release all [InnoDB](#) locks that were set during the current transaction.

In terms of the SQL:1992 transaction isolation levels, the default [InnoDB](#) level is `REPEATABLE READ`. [InnoDB](#) offers all four transaction isolation levels described by the SQL standard: `READ UNCOMMITTED`, `READ COMMITTED`, `REPEATABLE READ`, and `SERIALIZABLE`.

A user can change the isolation level for a single session or for all subsequent connections with the `SET TRANSACTION` state-

ment. To set the server's default isolation level for all connections, use the `--transaction-isolation` option on the command line or in an option file. For detailed information about isolation levels and level-setting syntax, see [Section 12.4.6, “SET TRANSACTION Syntax”](#).

In row-level locking, `InnoDB` normally uses next-key locking. That means that besides index records, `InnoDB` can also lock the “gap” preceding an index record to block insertions by other sessions in the gap immediately before the index record. A next-key lock refers to a lock that locks an index record and the gap before it. A gap lock refers to a lock that locks only the gap before some index record.

For more information about row-level locking, and the circumstances under which gap locking is disabled, see [Section 13.6.8.4, “InnoDB Record, Gap, and Next-Key Locks”](#).

### 13.6.8.1. InnoDB Lock Modes

`InnoDB` implements standard row-level locking where there are two types of locks:

- A shared (*S*) lock allows a transaction to read a row.
- An exclusive (*X*) lock allows a transaction to update or delete a row.

If transaction `T1` holds a shared (*S*) lock on row `r`, then requests from some distinct transaction `T2` for a lock on row `r` are handled as follows:

- A request by `T2` for an *S* lock can be granted immediately. As a result, both `T1` and `T2` hold an *S* lock on `r`.
- A request by `T2` for an *X* lock cannot be granted immediately.

If a transaction `T1` holds an exclusive (*X*) lock on row `r`, a request from some distinct transaction `T2` for a lock of either type on `r` cannot be granted immediately. Instead, transaction `T2` has to wait for transaction `T1` to release its lock on row `r`.

Additionally, `InnoDB` supports *multiple granularity locking* which allows coexistence of record locks and locks on entire tables. To make locking at multiple granularity levels practical, additional types of locks called *intention locks* are used. Intention locks are table locks in `InnoDB`. The idea behind intention locks is for a transaction to indicate which type of lock (shared or exclusive) it will require later for a row in that table. There are two types of intention locks used in `InnoDB` (assume that transaction `T` has requested a lock of the indicated type on table `t`):

- Intention shared (*IS*): Transaction `T` intends to set *S* locks on individual rows in table `t`.
- Intention exclusive (*IX*): Transaction `T` intends to set *X* locks on those rows.

For example, `SELECT ... LOCK IN SHARE MODE` sets an *IS* lock and `SELECT ... FOR UPDATE` sets an *IX* lock.

The intention locking protocol is as follows:

- Before a transaction can acquire an *S* lock on a row in table `t`, it must first acquire an *IS* or stronger lock on `t`.
- Before a transaction can acquire an *X* lock on a row, it must first acquire an *IX* lock on `t`.

These rules can be conveniently summarized by means of the following *lock type compatibility matrix*.

	<i>X</i>	<i>IX</i>	<i>S</i>	<i>IS</i>
<i>X</i>	Conflict	Conflict	Conflict	Conflict
<i>IX</i>	Conflict	Compatible	Conflict	Compatible
<i>S</i>	Conflict	Conflict	Compatible	Compatible
<i>IS</i>	Conflict	Compatible	Compatible	Compatible

A lock is granted to a requesting transaction if it is compatible with existing locks, but not if it conflicts with existing locks. A transaction waits until the conflicting existing lock is released. If a lock request conflicts with an existing lock and cannot be granted because it would cause deadlock, an error occurs.

Thus, intention locks do not block anything except full table requests (for example, `LOCK TABLES ... WRITE`). The main pur-

pose of *IX* and *IS* locks is to show that someone is locking a row, or going to lock a row in the table.

The following example illustrates how an error can occur when a lock request would cause a deadlock. The example involves two clients, A and B.

First, client A creates a table containing one row, and then begins a transaction. Within the transaction, A obtains an *S* lock on the row by selecting it in share mode:

```
mysql> CREATE TABLE t (i INT) ENGINE = InnoDB;
Query OK, 0 rows affected (1.07 sec)

mysql> INSERT INTO t (i) VALUES(1);
Query OK, 1 row affected (0.09 sec)

mysql> START TRANSACTION;
Query OK, 0 rows affected (0.00 sec)

mysql> SELECT * FROM t WHERE i = 1 LOCK IN SHARE MODE;
+-----+
| i     |
+-----+
| 1    |
+-----+
1 row in set (0.10 sec)
```

Next, client B begins a transaction and attempts to delete the row from the table:

```
mysql> START TRANSACTION;
Query OK, 0 rows affected (0.00 sec)

mysql> DELETE FROM t WHERE i = 1;
```

The delete operation requires an *X* lock. The lock cannot be granted because it is incompatible with the *S* lock that client A holds, so the request goes on the queue of lock requests for the row and client B blocks.

Finally, client A also attempts to delete the row from the table:

```
mysql> DELETE FROM t WHERE i = 1;
ERROR 1213 (40001): Deadlock found when trying to get lock;
try restarting transaction
```

Deadlock occurs here because client A needs an *X* lock to delete the row. However, that lock request cannot be granted because client B already has a request for an *X* lock and is waiting for client A to release its *S* lock. Nor can the *S* lock held by A be upgraded to an *X* lock because of the prior request by B for an *X* lock. As a result, *InnoDB* generates an error for client A and releases its locks. At that point, the lock request for client B can be granted and B deletes the row from the table.

### 13.6.8.2. Consistent Non-Locking Reads

A consistent read means that *InnoDB* uses multi-versioning to present to a query a snapshot of the database at a point in time. The query sees the changes made by transactions that committed before that point of time, and no changes made by later or uncommitted transactions. The exception to this rule is that the query sees the changes made by earlier statements within the same transaction. This exception causes the following anomaly: If you update some rows in a table, a *SELECT* will see the latest version of the updated rows, but it might also see older versions of any rows. If other sessions simultaneously update the same table, the anomaly means that you may see the table in a state that never existed in the database.

If the transaction isolation level is *REPEATABLE READ* (the default level), all consistent reads within the same transaction read the snapshot established by the first such read in that transaction. You can get a fresher snapshot for your queries by committing the current transaction and after that issuing new queries.

With *READ COMMITTED* isolation level, each consistent read within a transaction sets and reads its own fresh snapshot.

Consistent read is the default mode in which *InnoDB* processes *SELECT* statements in *READ COMMITTED* and *REPEATABLE READ* isolation levels. A consistent read does not set any locks on the tables it accesses, and therefore other sessions are free to modify those tables at the same time a consistent read is being performed on the table.

Suppose that you are running in the default *REPEATABLE READ* isolation level. When you issue a consistent read (that is, an ordinary *SELECT* statement), *InnoDB* gives your transaction a timepoint according to which your query sees the database. If another transaction deletes a row and commits after your timepoint was assigned, you do not see the row as having been deleted. Inserts and updates are treated similarly.

You can advance your timepoint by committing your transaction and then doing another *SELECT*.

This is called *multi-versioned concurrency control*.

In the following example, session A sees the row inserted by B only when B has committed the insert and A has committed as well,



so that the timepoint is advanced past the commit of B.

	Session A	Session B
time	SET autocommit=0;	SET autocommit=0;
	SELECT * FROM t; empty set	
		INSERT INTO t VALUES (1, 2);
v	SELECT * FROM t; empty set	COMMIT;
	SELECT * FROM t; empty set	
	COMMIT;	
	SELECT * FROM t;	
	-----	
	1   2	
	-----	
	1 row in set	

If you want to see the “freshest” state of the database, you should use either the [READ COMMITTED](#) isolation level or a locking read:

```
SELECT * FROM t LOCK IN SHARE MODE;
```

With [READ COMMITTED](#) isolation level, each consistent read within a transaction sets and reads its own fresh snapshot. With [LOCK IN SHARE MODE](#), a locking read occurs instead: A [SELECT](#) blocks until the transaction containing the freshest rows ends (see [Section 13.6.8.3](#), “[SELECT ... FOR UPDATE and SELECT ... LOCK IN SHARE MODE Locking Reads](#)”).

Consistent read does not work over [DROP TABLE](#) or over [ALTER TABLE](#):

- Consistent read does not work over [DROP TABLE](#) because MySQL cannot use a table that has been dropped and [InnoDB](#) destroys the table.
- Consistent read does not work over [ALTER TABLE](#) because [ALTER TABLE](#) works by making a temporary copy of the original table and deleting the original table when the temporary copy is built. When you reissue a consistent read within a transaction, rows in the new table are not visible because those rows did not exist when the transaction's snapshot was taken.

[InnoDB](#) uses a consistent read for select in clauses like [INSERT INTO ... SELECT](#), [UPDATE ... \(SELECT\)](#), and [CREATE TABLE ... SELECT](#) that do not specify [FOR UPDATE](#) or [LOCK IN SHARE MODE](#) if the [innodb\\_locks\\_unsafe\\_for\\_binlog](#) option is set and the isolation level of the transaction is not set to [SERIALIZABLE](#). Thus, no locks are set on rows read from the selected table. Otherwise, [InnoDB](#) uses stronger locks and the [SELECT](#) part acts like [READ COMMITTED](#), where each consistent read, even within the same transaction, sets and reads its own fresh snapshot.

### 13.6.8.3. [SELECT ... FOR UPDATE and SELECT ... LOCK IN SHARE MODE Locking Reads](#)

In some circumstances, a consistent (non-locking) read is not convenient and a locking read is required instead. [InnoDB](#) supports two types of locking reads:

- [SELECT ... LOCK IN SHARE MODE](#) sets a shared mode lock on the rows read. A shared mode lock enables other sessions to read the rows but not to modify them. The rows read are the latest available, so if they belong to another transaction that has not yet committed, the read blocks until that transaction ends.
- For index records the search encounters, [SELECT ... FOR UPDATE](#) blocks other sessions from doing [SELECT ... LOCK IN SHARE MODE](#) or from reading in certain transaction isolation levels. Consistent reads will ignore any locks set on the records that exist in the read view. (Old versions of a record cannot be locked; they will be reconstructed by applying undo logs on an in-memory copy of the record.)

Locks set by [LOCK IN SHARE MODE](#) and [FOR UPDATE](#) reads are released when the transaction is committed or rolled back.

As an example of a situation in which a locking read is useful, suppose that you want to insert a new row into a table [child](#), and make sure that the child row has a parent row in table [parent](#). The following discussion describes how to implement referential integrity in application code.

Suppose that you use a consistent read to read the table [parent](#) and indeed see the parent row of the to-be-inserted child row in



the table. Can you safely insert the child row to table `child`? No, because it is possible for some other session to delete the parent row from the table `parent` in the meantime without you being aware of it.

The solution is to perform the `SELECT` in a locking mode using `LOCK IN SHARE MODE`:

```
SELECT * FROM parent WHERE NAME = 'Jones' LOCK IN SHARE MODE;
```

A read performed with `LOCK IN SHARE MODE` reads the latest available data and sets a shared mode lock on the rows read. A shared mode lock prevents others from updating or deleting the row read. Also, if the latest data belongs to a yet uncommitted transaction of another session, we wait until that transaction ends. After we see that the `LOCK IN SHARE MODE` query returns the parent 'Jones', we can safely add the child record to the `child` table and commit our transaction.

Let us look at another example: We have an integer counter field in a table `child_codes` that we use to assign a unique identifier to each child added to table `child`. It is not a good idea to use either consistent read or a shared mode read to read the present value of the counter because two users of the database may then see the same value for the counter, and a duplicate-key error occurs if two users attempt to add children with the same identifier to the table.

Here, `LOCK IN SHARE MODE` is not a good solution because if two users read the counter at the same time, at least one of them ends up in deadlock when it attempts to update the counter.

In this case, there are two good ways to implement reading and incrementing the counter:

- First update the counter by incrementing it by 1, and then read it.
- First perform a locking read of the counter using `FOR UPDATE`, and then increment the counter.

The latter approach can be implemented as follows:

```
SELECT counter_field FROM child_codes FOR UPDATE;
UPDATE child_codes SET counter_field = counter_field + 1;
```

A `SELECT ... FOR UPDATE` reads the latest available data, setting exclusive locks on each row it reads. Thus, it sets the same locks a searched `SQL UPDATE` would set on the rows.

The preceding description is merely an example of how `SELECT ... FOR UPDATE` works. In MySQL, the specific task of generating a unique identifier actually can be accomplished using only a single access to the table:

```
UPDATE child_codes SET counter_field = LAST_INSERT_ID(counter_field + 1);
SELECT LAST_INSERT_ID();
```

The `SELECT` statement merely retrieves the identifier information (specific to the current connection). It does not access any table.

### Note

Locking of rows for update using `SELECT FOR UPDATE` only applies when autocommit is disabled (either by beginning transaction with `START TRANSACTION` or by setting `autocommit` to 0. If autocommit is enabled, the rows matching the specification are not locked.

## 13.6.8.4. InnoDB Record, Gap, and Next-Key Locks

InnoDB has several types of record-level locks:

- Record lock: This is a lock on an index record.
- Gap lock: This is a lock on a gap between index records, or a lock on the gap before the first or after the last index record.
- Next-key lock: This is a combination of a record lock on the index record and a gap lock on the gap before the index record.

Record locks always lock index records, even if a table is defined with no indexes. For such cases, InnoDB creates a hidden clustered index and uses this index for record locking. See [Section 13.6.10.1, “Clustered and Secondary Indexes”](#).

By default, InnoDB operates in `REPEATABLE READ` transaction isolation level and with the `innodb_locks_unsafe_for_binlog` system variable disabled. In this case, InnoDB uses next-key locks for searches and index scans, which prevents phantom rows (see [Section 13.6.8.5, “Avoiding the Phantom Problem Using Next-Key Locking”](#)).

Next-key locking combines index-row locking with gap locking. InnoDB performs row-level locking in such a way that when it searches or scans a table index, it sets shared or exclusive locks on the index records it encounters. Thus, the row-level locks are ac-

tually index-record locks. In addition, a next-key lock on an index record also affects the “gap” before that index record. That is, a next-key lock is an index-record lock plus a gap lock on the gap preceding the index record. If one session has a shared or exclusive lock on record *R* in an index, another session cannot insert a new index record in the gap immediately before *R* in the index order.

Suppose that an index contains the values 10, 11, 13, and 20. The possible next-key locks for this index cover the following intervals, where ( or ) denote exclusion of the interval endpoint and [ or ] denote inclusion of the endpoint:

```
(negative infinity, 10]
(10, 11]
(11, 13]
(13, 20]
(20, positive infinity)
```

For the last interval, the next-key lock locks the gap above the largest value in the index and the “supremum” pseudo-record having a value higher than any value actually in the index. The supremum is not a real index record, so, in effect, this next-key lock locks only the gap following the largest index value.

The preceding example shows that a gap might span a single index value, multiple index values, or even be empty.

Gap locking is not needed for statements that lock rows using a unique index to search for a unique row. For example, if the *id* column has a unique index, the following statement uses only an index-record lock for the row having *id* value 100 and it does not matter whether other sessions insert rows in the preceding gap:

```
SELECT * FROM child WHERE id = 100;
```

If *id* is not indexed or has a non-unique index, the statement does lock the preceding gap.

A type of gap lock called an insertion intention gap lock is set by *INSERT* operations prior to row insertion. This lock signals the intent to insert in such a way that multiple transactions inserting into the same index gap need not wait for each other if they are not inserting at the same position within the gap. Suppose that there are index records with values of 4 and 7. Separate transactions that attempt to insert values of 5 and 6 each lock the gap between 4 and 7 with insert intention locks prior to obtaining the exclusive lock on the inserted row, but do not block each other because the rows are non-conflicting.

Gap locking can be disabled explicitly. This occurs if you change the transaction isolation level to *READ COMMITTED* or enable the *innodb\_locks\_unsafe\_for\_binlog* system variable. Under these circumstances, gap locking is disabled for searches and index scans and is used only for foreign-key constraint checking and duplicate-key checking.

There are also other effects of using the *READ COMMITTED* isolation level or enabling *innodb\_locks\_unsafe\_for\_binlog*: Record locks for non-matching rows are released after MySQL has evaluated the *WHERE* condition. For *UPDATE* statements, *InnoDB* does a “semi-consistent” read, such that it returns the latest committed version to MySQL so that MySQL can determine whether the row matches the *WHERE* condition of the *UPDATE*.

### 13.6.8.5. Avoiding the Phantom Problem Using Next-Key Locking

The so-called *phantom* problem occurs within a transaction when the same query produces different sets of rows at different times. For example, if a *SELECT* is executed twice, but returns a row the second time that was not returned the first time, the row is a “phantom” row.

Suppose that there is an index on the *id* column of the *child* table and that you want to read and lock all rows from the table having an identifier value larger than 100, with the intention of updating some column in the selected rows later:

```
SELECT * FROM child WHERE id > 100 FOR UPDATE;
```

The query scans the index starting from the first record where *id* is bigger than 100. Let the table contain rows having *id* values of 90 and 102. If the locks set on the index records in the scanned range do not lock out inserts made in the gaps (in this case, the gap between 90 and 102), another session can insert a new row into the table with an *id* of 101. If you were to execute the same *SELECT* within the same transaction, you would see a new row with an *id* of 101 (a “phantom”) in the result set returned by the query. If we regard a set of rows as a data item, the new phantom *child* would violate the isolation principle of transactions that a transaction should be able to run so that the data it has read does not change during the transaction.

To prevent phantoms, *InnoDB* uses an algorithm called *next-key locking* that combines index-row locking with gap locking. *InnoDB* performs row-level locking in such a way that when it searches or scans a table index, it sets shared or exclusive locks on the index records it encounters. Thus, the row-level locks are actually index-record locks. In addition, a next-key lock on an index record also affects the “gap” before that index record. That is, a next-key lock is an index-record lock plus a gap lock on the gap preceding the index record. If one session has a shared or exclusive lock on record *R* in an index, another session cannot insert a new index record in the gap immediately before *R* in the index order.

When *InnoDB* scans an index, it can also lock the gap after the last record in the index. Just that happens in the preceding example: To prevent any insert into the table where *id* would be bigger than 100, the locks set by *InnoDB* include a lock on the gap following *id* value 102.

You can use next-key locking to implement a uniqueness check in your application: If you read your data in share mode and do not see a duplicate for a row you are going to insert, then you can safely insert your row and know that the next-key lock set on the successor of your row during the read prevents anyone meanwhile inserting a duplicate for your row. Thus, the next-key locking allows you to “lock” the non-existence of something in your table.

Gap locking can be disabled as discussed in [Section 13.6.8.4, “InnoDB Record, Gap, and Next-Key Locks”](#). This may cause phantom problems because other sessions can insert new rows into the gaps when gap locking is disabled.

### 13.6.8.6. Locks Set by Different SQL Statements in InnoDB

A locking read, an `UPDATE`, or a `DELETE` generally set record locks on every index record that is scanned in the processing of the SQL statement. It does not matter whether there are `WHERE` conditions in the statement that would exclude the row. `InnoDB` does not remember the exact `WHERE` condition, but only knows which index ranges were scanned. The locks are normally next-key locks that also block inserts into the “gap” immediately before the record. However, gap locking can be disabled explicitly, which causes next-key locking not to be used. For more information, see [Section 13.6.8.4, “InnoDB Record, Gap, and Next-Key Locks”](#).

Differences between shared and exclusive locks are described in [Section 13.6.8.1, “InnoDB Lock Modes”](#).

If you have no indexes suitable for your statement and MySQL must scan the entire table to process the statement, every row of the table becomes locked, which in turn blocks all inserts by other users to the table. It is important to create good indexes so that your queries do not unnecessarily scan many rows.

For `SELECT ... FOR UPDATE` or `SELECT ... LOCK IN SHARE MODE`, locks are acquired for scanned rows, and expected to be released for rows that do not qualify for inclusion in the result set (for example, if they do not meet the criteria given in the `WHERE` clause). However, in some cases, rows might not be unlocked immediately because the relationship between a result row and its original source is lost during query execution. For example, in a `UNION`, scanned (and locked) rows from a table might be inserted into a temporary table before evaluation whether they qualify for the result set. In this circumstance, the relationship of the rows in the temporary table to the rows in the original table is lost and the latter rows are not unlocked until the end of query execution.

`InnoDB` sets specific types of locks as follows. If a secondary index is used in the search and index record locks to be set are exclusive, `InnoDB` also retrieves the corresponding clustered index records and sets locks on them.

- `SELECT ... FROM` is a consistent read, reading a snapshot of the database and setting no locks unless the transaction isolation level is set to `SERIALIZABLE`. For `SERIALIZABLE` level, the search sets shared next-key locks on the index records it encounters.
- `SELECT ... FROM ... LOCK IN SHARE MODE` sets shared next-key locks on all index records the search encounters.
- For index records the search encounters, `SELECT ... FROM ... FOR UPDATE` blocks other sessions from doing `SELECT ... FROM ... LOCK IN SHARE MODE` or from reading in certain transaction isolation levels. Consistent reads will ignore any locks set on the records that exist in the read view.
- `UPDATE ... WHERE ...` sets an exclusive next-key lock on every record the search encounters.
- `DELETE FROM ... WHERE ...` sets an exclusive next-key lock on every record the search encounters.
- `INSERT` sets an exclusive lock on the inserted row. This lock is an index-record lock, not a next-key lock (that is, there is no gap lock) and does not prevent other sessions from inserting into the gap before the inserted row.

Prior to inserting the row, a type of gap lock called an insertion intention gap lock is set. This lock signals the intent to insert in such a way that multiple transactions inserting into the same index gap need not wait for each other if they are not inserting at the same position within the gap. Suppose that there are index records with values of 4 and 7. Separate transactions that attempt to insert values of 5 and 6 each lock the gap between 4 and 7 with insert intention locks prior to obtaining the exclusive lock on the inserted row, but do not block each other because the rows are non-conflicting.

If a duplicate-key error occurs, a shared lock on the duplicate index record is set. This use of a shared lock can result in deadlock should there be multiple sessions trying to insert the same row if another session already has an exclusive lock. This can occur if another session deletes the row. Suppose that an `InnoDB` table `t1` has the following structure:

```
CREATE TABLE t1 (i INT, PRIMARY KEY (i)) ENGINE = InnoDB;
```

Now suppose that three sessions perform the following operations in order:

Session 1:

```
START TRANSACTION;
INSERT INTO t1 VALUES(1);
```

Session 2:

```
START TRANSACTION;
INSERT INTO t1 VALUES(1);
```

Session 3:

```
START TRANSACTION;
INSERT INTO t1 VALUES(1);
```

Session 1:

```
ROLLBACK;
```

The first operation by session 1 acquires an exclusive lock for the row. The operations by sessions 2 and 3 both result in a duplicate-key error and they both request a shared lock for the row. When session 1 rolls back, it releases its exclusive lock on the row and the queued shared lock requests for sessions 2 and 3 are granted. At this point, sessions 2 and 3 deadlock: Neither can acquire an exclusive lock for the row because of the shared lock held by the other.

A similar situation occurs if the table already contains a row with key value 1 and three sessions perform the following operations in order:

Session 1:

```
START TRANSACTION;
DELETE FROM t1 WHERE i = 1;
```

Session 2:

```
START TRANSACTION;
INSERT INTO t1 VALUES(1);
```

Session 3:

```
START TRANSACTION;
INSERT INTO t1 VALUES(1);
```

Session 1:

```
COMMIT;
```

The first operation by session 1 acquires an exclusive lock for the row. The operations by sessions 2 and 3 both result in a duplicate-key error and they both request a shared lock for the row. When session 1 commits, it releases its exclusive lock on the row and the queued shared lock requests for sessions 2 and 3 are granted. At this point, sessions 2 and 3 deadlock: Neither can acquire an exclusive lock for the row because of the shared lock held by the other.

- `REPLACE` is done like an `INSERT` if there is no collision on a unique key. Otherwise, an exclusive next-key lock is placed on the row that must be updated.
- `INSERT INTO T SELECT ... FROM S WHERE ...` sets an exclusive index record without a gap lock on each row inserted into `T`. If `innodb_locks_unsafe_for_binlog` is enabled or the transaction isolation level is `READ COMMITTED`, `InnoDB` does the search on `S` as a consistent read (no locks). Otherwise, `InnoDB` sets shared next-key locks on rows from `S`. `InnoDB` has to set locks in the latter case: In roll-forward recovery from a backup, every SQL statement must be executed in exactly the same way it was done originally.

`CREATE TABLE ... SELECT ...` performs the `SELECT` with shared next-key locks or as a consistent read, as for `INSERT ... SELECT`.

For `REPLACE INTO T SELECT ... FROM S WHERE ...`, `InnoDB` sets shared next-key locks on rows from `S`.

- While initializing a previously specified `AUTO_INCREMENT` column on a table, `InnoDB` sets an exclusive lock on the end of the index associated with the `AUTO_INCREMENT` column. In accessing the auto-increment counter, `InnoDB` uses a specific `AUTO-INC` table lock mode where the lock lasts only to the end of the current SQL statement, not to the end of the entire transaction. Other sessions cannot insert into the table while the `AUTO-INC` table lock is held; see [Section 13.6.8, “The InnoDB Transaction Model and Locking”](#).

`InnoDB` fetches the value of a previously initialized `AUTO_INCREMENT` column without setting any locks.

- If a [FOREIGN KEY](#) constraint is defined on a table, any insert, update, or delete that requires the constraint condition to be checked sets shared record-level locks on the records that it looks at to check the constraint. [InnoDB](#) also sets these locks in the case where the constraint fails.
- [LOCK TABLES](#) sets table locks, but it is the higher MySQL layer above the [InnoDB](#) layer that sets these locks. [InnoDB](#) is aware of table locks if `innodb_table_locks = 1` (the default) and `autocommit = 0`, and the MySQL layer above [InnoDB](#) knows about row-level locks.

Otherwise, [InnoDB](#)'s automatic deadlock detection cannot detect deadlocks where such table locks are involved. Also, because in this case the higher MySQL layer does not know about row-level locks, it is possible to get a table lock on a table where another session currently has row-level locks. However, this does not endanger transaction integrity, as discussed in [Section 13.6.8.8, “Deadlock Detection and Rollback”](#). See also [Section 13.6.14, “Restrictions on InnoDB Tables”](#).

### 13.6.8.7. Implicit Transaction Commit and Rollback

By default, MySQL starts the session for each new connection with autocommit mode enabled, so MySQL does a commit after each SQL statement if that statement did not return an error. If a statement returns an error, the commit or rollback behavior depends on the error. See [Section 13.6.12, “InnoDB Error Handling”](#).

If a session that has autocommit disabled ends without explicitly committing the final transaction, MySQL rolls back that transaction.

Some statements implicitly end a transaction, as if you had done a [COMMIT](#) before executing the statement. For details, see [Section 12.4.3, “Statements That Cause an Implicit Commit”](#).

### 13.6.8.8. Deadlock Detection and Rollback

[InnoDB](#) automatically detects transaction deadlocks and rolls back a transaction or transactions to break the deadlock. [InnoDB](#) tries to pick small transactions to roll back, where the size of a transaction is determined by the number of rows inserted, updated, or deleted.

[InnoDB](#) is aware of table locks if `innodb_table_locks = 1` (the default) and `autocommit = 0`, and the MySQL layer above it knows about row-level locks. Otherwise, [InnoDB](#) cannot detect deadlocks where a table lock set by a MySQL [LOCK TABLES](#) statement or a lock set by a storage engine other than [InnoDB](#) is involved. You must resolve these situations by setting the value of the `innodb_lock_wait_timeout` system variable.

When [InnoDB](#) performs a complete rollback of a transaction, all locks set by the transaction are released. However, if just a single SQL statement is rolled back as a result of an error, some of the locks set by the statement may be preserved. This happens because [InnoDB](#) stores row locks in a format such that it cannot know afterward which lock was set by which statement.

As of MySQL 5.1.24, if a [SELECT](#) calls a stored function in a transaction, and a statement within the function fails, that statement rolls back. Furthermore, if [ROLLBACK](#) is executed after that, the entire transaction rolls back. Before 5.1.24, the failed statement did not roll back when it failed (even though it might ultimately get rolled back by a [ROLLBACK](#) later that rolls back the entire transaction).

### 13.6.8.9. How to Cope with Deadlocks

Deadlocks are a classic problem in transactional databases, but they are not dangerous unless they are so frequent that you cannot run certain transactions at all. Normally, you must write your applications so that they are always prepared to re-issue a transaction if it gets rolled back because of a deadlock.

[InnoDB](#) uses automatic row-level locking. You can get deadlocks even in the case of transactions that just insert or delete a single row. That is because these operations are not really “atomic”; they automatically set locks on the (possibly several) index records of the row inserted or deleted.

You can cope with deadlocks and reduce the likelihood of their occurrence with the following techniques:

- Use [SHOW ENGINE INNODB STATUS](#) to determine the cause of the latest deadlock. That can help you to tune your application to avoid deadlocks.
- Always be prepared to re-issue a transaction if it fails due to deadlock. Deadlocks are not dangerous. Just try again.
- Commit your transactions often. Small transactions are less prone to collision.
- If you are using locking reads ([SELECT ... FOR UPDATE](#) or [SELECT ... LOCK IN SHARE MODE](#)), try using a lower isolation level such as [READ COMMITTED](#).
- Access your tables and rows in a fixed order. Then transactions form well-defined queues and do not deadlock.

- Add well-chosen indexes to your tables. Then your queries need to scan fewer index records and consequently set fewer locks. Use `EXPLAIN SELECT` to determine which indexes the MySQL server regards as the most appropriate for your queries.
- Use less locking. If you can afford to allow a `SELECT` to return data from an old snapshot, do not add the clause `FOR UPDATE` or `LOCK IN SHARE MODE` to it. Using the `READ COMMITTED` isolation level is good here, because each consistent read within the same transaction reads from its own fresh snapshot.
- If nothing else helps, serialize your transactions with table-level locks. The correct way to use `LOCK TABLES` with transactional tables, such as `InnoDB` tables, is to begin a transaction with `SET autocommit = 0` (not `START TRANSACTION`) followed by `LOCK TABLES`, and to not call `UNLOCK TABLES` until you commit the transaction explicitly. For example, if you need to write to table `t1` and read from table `t2`, you can do this:

```
SET autocommit=0;
LOCK TABLES t1 WRITE, t2 READ, ...;
... do something with tables t1 and t2 here ...
COMMIT;
UNLOCK TABLES;
```

Table-level locks make your transactions queue nicely and avoid deadlocks.

- Another way to serialize transactions is to create an auxiliary “semaphore” table that contains just a single row. Have each transaction update that row before accessing other tables. In that way, all transactions happen in a serial fashion. Note that the `InnoDB` instant deadlock detection algorithm also works in this case, because the serializing lock is a row-level lock. With MySQL table-level locks, the timeout method must be used to resolve deadlocks.

### 13.6.9. InnoDB Multi-Versioning

Because `InnoDB` is a multi-versioned storage engine, it must keep information about old versions of rows in the tablespace. This information is stored in a data structure called a *rollback segment* (after an analogous data structure in Oracle).

Internally, `InnoDB` adds three fields to each row stored in the database. A 6-byte `DB_TRX_ID` field indicates the transaction identifier for the last transaction that inserted or updated the row. Also, a deletion is treated internally as an update where a special bit in the row is set to mark it as deleted. Each row also contains a 7-byte `DB_ROLL_PTR` field called the roll pointer. The roll pointer points to an undo log record written to the rollback segment. If the row was updated, the undo log record contains the information necessary to rebuild the content of the row before it was updated. A 6-byte `DB_ROW_ID` field contains a row ID that increases monotonically as new rows are inserted. If `InnoDB` generates a clustered index automatically, the index contains row ID values. Otherwise, the `DB_ROW_ID` column does not appear in any index.

`InnoDB` uses the information in the rollback segment to perform the undo operations needed in a transaction rollback. It also uses the information to build earlier versions of a row for a consistent read.

Undo logs in the rollback segment are divided into insert and update undo logs. Insert undo logs are needed only in transaction rollback and can be discarded as soon as the transaction commits. Update undo logs are used also in consistent reads, but they can be discarded only after there is no transaction present for which `InnoDB` has assigned a snapshot that in a consistent read could need the information in the update undo log to build an earlier version of a database row.

You must remember to commit your transactions regularly, including those transactions that issue only consistent reads. Otherwise, `InnoDB` cannot discard data from the update undo logs, and the rollback segment may grow too big, filling up your tablespace.

The physical size of an undo log record in the rollback segment is typically smaller than the corresponding inserted or updated row. You can use this information to calculate the space need for your rollback segment.

In the `InnoDB` multi-versioning scheme, a row is not physically removed from the database immediately when you delete it with an SQL statement. Only when `InnoDB` can discard the update undo log record written for the deletion can it also physically remove the corresponding row and its index records from the database. This removal operation is called a purge, and it is quite fast, usually taking the same order of time as the SQL statement that did the deletion.

In a scenario where the user inserts and deletes rows in smallish batches at about the same rate in the table, it is possible that the purge thread starts to lag behind, and the table grows bigger and bigger, making everything disk-bound and very slow. Even if the table carries just 10MB of useful data, it may grow to occupy 10GB with all the “dead” rows. In such a case, it would be good to throttle new row operations and allocate more resources to the purge thread. The `innodb_max_purge_lag` system variable exists for exactly this purpose. See [Section 13.6.3, “InnoDB Startup Options and System Variables”](#), for more information.

### 13.6.10. InnoDB Table and Index Structures

MySQL stores its data dictionary information for tables in `.frm` files in database directories. This is true for all MySQL storage engines, but every `InnoDB` table also has its own entry in the `InnoDB` internal data dictionary inside the tablespace. When MySQL drops a table or a database, it has to delete one or more `.frm` files as well as the corresponding entries inside the `InnoDB` data dictionary. Consequently, you cannot move `InnoDB` tables between databases simply by moving the `.frm` files.



### 13.6.10.1. Clustered and Secondary Indexes

Every `InnoDB` table has a special index called the *clustered index* where the data for the rows is stored:

- If you define a `PRIMARY KEY` on your table, `InnoDB` uses it as the clustered index.
- If you do not define a `PRIMARY KEY` for your table, MySQL picks the first `UNIQUE` index that has only `NOT NULL` columns as the primary key and `InnoDB` uses it as the clustered index.
- If the table has no `PRIMARY KEY` or suitable `UNIQUE` index, `InnoDB` internally generates a hidden clustered index on a synthetic column containing row ID values. The rows are ordered by the ID that `InnoDB` assigns to the rows in such a table. The row ID is a 6-byte field that increases monotonically as new rows are inserted. Thus, the rows ordered by the row ID are physically in insertion order.

Accessing a row through the clustered index is fast because the row data is on the same page where the index search leads. If a table is large, the clustered index architecture often saves a disk I/O operation when compared to storage organizations that store row data using a different page from the index record. (For example, `MyISAM` uses one file for data rows and another for index records.)

In `InnoDB`, the records in non-clustered indexes (also called secondary indexes) contain the primary key columns for the row that are not in the secondary index. `InnoDB` uses this primary key value to search for the row in the clustered index. If the primary key is long, the secondary indexes use more space, so it is advantageous to have a short primary key.

### 13.6.10.2. Physical Structure of an Index

All `InnoDB` indexes are B-trees where the index records are stored in the leaf pages of the tree. The default size of an index page is 16KB. When new records are inserted, `InnoDB` tries to leave 1/16 of the page free for future insertions and updates of the index records.

If index records are inserted in a sequential order (ascending or descending), the resulting index pages are about 15/16 full. If records are inserted in a random order, the pages are from 1/2 to 15/16 full. If the fill factor of an index page drops below 1/2, `InnoDB` tries to contract the index tree to free the page.

### 13.6.10.3. Insert Buffering

It is a common situation in database applications that the primary key is a unique identifier and new rows are inserted in the ascending order of the primary key. Thus, insertions into the clustered index do not require random reads from a disk.

On the other hand, secondary indexes are usually non-unique, and insertions into secondary indexes happen in a relatively random order. This would cause a lot of random disk I/O operations without a special mechanism used in `InnoDB`.

If an index record should be inserted into a non-unique secondary index, `InnoDB` checks whether the secondary index page is in the buffer pool. If that is the case, `InnoDB` does the insertion directly to the index page. If the index page is not found in the buffer pool, `InnoDB` inserts the record to a special insert buffer structure. The insert buffer is kept so small that it fits entirely in the buffer pool, and insertions can be done very fast.

Periodically, the insert buffer is merged into the secondary index trees in the database. Often it is possible to merge several insertions into the same page of the index tree, saving disk I/O operations. It has been measured that the insert buffer can speed up insertions into a table up to 15 times.

The insert buffer merging may continue to happen *after* the inserting transaction has been committed. In fact, it may continue to happen after a server shutdown and restart (see [Section 13.6.6.2, “Forcing InnoDB Recovery”](#)).

Insert buffer merging may take many hours when many secondary indexes must be updated and many rows have been inserted. During this time, disk I/O will be increased, which can cause significant slowdown on disk-bound queries. Another significant background I/O operation is the purge thread (see [Section 13.6.9, “InnoDB Multi-Versioning”](#)).

### 13.6.10.4. Adaptive Hash Indexes

If a table fits almost entirely in main memory, the fastest way to perform queries on it is to use hash indexes. `InnoDB` has a mechanism that monitors index searches made to the indexes defined for a table. If `InnoDB` notices that queries could benefit from building a hash index, it does so automatically.

The hash index is always built based on an existing B-tree index on the table. `InnoDB` can build a hash index on a prefix of any length of the key defined for the B-tree, depending on the pattern of searches that `InnoDB` observes for the B-tree index. A hash index can be partial: It is not required that the whole B-tree index is cached in the buffer pool. `InnoDB` builds hash indexes on demand for those pages of the index that are often accessed.

In a sense, [InnoDB](#) tailors itself through the adaptive hash index mechanism to amply main memory, coming closer to the architecture of main-memory databases.

### 13.6.10.5. Physical Row Structure

The physical row structure for an [InnoDB](#) table depends on the row format specified when the table was created. For MySQL 5.1, [InnoDB](#) uses the [COMPACT](#) format by default, but the [REDUNDANT](#) format is available to retain compatibility with older versions of MySQL. To check the row format of an [InnoDB](#) table, use `SHOW TABLE STATUS`.

The compact row format decreases row storage space by about 20% at the cost of increasing CPU use for some operations. If your workload is a typical one that is limited by cache hit rates and disk speed, compact format is likely to be faster. If the workload is a rare case that is limited by CPU speed, compact format might be slower.

Rows in [InnoDB](#) tables that use [REDUNDANT](#) row format have the following characteristics:

- Each index record contains a six-byte header. The header is used to link together consecutive records, and also in row-level locking.
- Records in the clustered index contain fields for all user-defined columns. In addition, there is a six-byte transaction ID field and a seven-byte roll pointer field.
- If no primary key was defined for a table, each clustered index record also contains a six-byte row ID field.
- Each secondary index record also contains all the primary key fields defined for the clustered index key that are not in the secondary index.
- A record contains a pointer to each field of the record. If the total length of the fields in a record is less than 128 bytes, the pointer is one byte; otherwise, two bytes. The array of these pointers is called the record directory. The area where these pointers point is called the data part of the record.
- Internally, [InnoDB](#) stores fixed-length character columns such as `CHAR(10)` in a fixed-length format. [InnoDB](#) does not truncate trailing spaces from [VARCHAR](#) columns.
- An SQL `NULL` value reserves one or two bytes in the record directory. Besides that, an SQL `NULL` value reserves zero bytes in the data part of the record if stored in a variable length column. In a fixed-length column, it reserves the fixed length of the column in the data part of the record. Reserving the fixed space for `NULL` values enables an update of the column from `NULL` to a non-`NULL` value to be done in place without causing fragmentation of the index page.

Rows in [InnoDB](#) tables that use [COMPACT](#) row format have the following characteristics:

- Each index record contains a five-byte header that may be preceded by a variable-length header. The header is used to link together consecutive records, and also in row-level locking.
- The variable-length part of the record header contains a bit vector for indicating `NULL` columns. If the number of columns in the index that can be `NULL` is  $N$ , the bit vector occupies  $(N+7)/8$  bytes. Columns that are `NULL` do not occupy space other than the bit in this vector. The variable-length part of the header also contains the lengths of variable-length columns. Each length takes one or two bytes, depending on the maximum length of the column. If all columns in the index are `NOT NULL` and have a fixed length, the record header has no variable-length part.
- For each non-`NULL` variable-length field, the record header contains the length of the column in one or two bytes. Two bytes will only be needed if part of the column is stored externally in overflow pages or the maximum length exceeds 255 bytes and the actual length exceeds 127 bytes. For an externally stored column, the two-byte length indicates the length of the internally stored part plus the 20-byte pointer to the externally stored part. The internal part is 768 bytes, so the length is 768+20. The 20-byte pointer stores the true length of the column.
- The record header is followed by the data contents of the non-`NULL` columns.
- Records in the clustered index contain fields for all user-defined columns. In addition, there is a six-byte transaction ID field and a seven-byte roll pointer field.
- If no primary key was defined for a table, each clustered index record also contains a six-byte row ID field.
- Each secondary index record also contains all the primary key fields defined for the clustered index key that are not in the secondary index. If any of these primary key fields are variable length, the record header for each secondary index will have a variable-length part to record their lengths, even if the secondary index is defined on fixed-length columns.
- Internally, [InnoDB](#) stores fixed-length, fixed-width character columns such as `CHAR(10)` in a fixed-length format. [InnoDB](#) does not truncate trailing spaces from [VARCHAR](#) columns.



- Internally, `InnoDB` attempts to store UTF-8 `CHAR(N)` columns in `N` bytes by trimming trailing spaces. (With `REDUNDANT` row format, such columns occupy  $3 \times N$  bytes.) Reserving the minimum space `N` in many cases enables column updates to be done in place without causing fragmentation of the index page.

## 13.6.11. InnoDB Disk I/O and File Space Management

### 13.6.11.1. InnoDB Disk I/O

`InnoDB` uses simulated asynchronous disk I/O: `InnoDB` creates a number of threads to take care of I/O operations, such as read-ahead.

There are two read-ahead heuristics in `InnoDB`:

- In sequential read-ahead, if `InnoDB` notices that the access pattern to a segment in the tablespace is sequential, it posts in advance a batch of reads of database pages to the I/O system.
- In random read-ahead, if `InnoDB` notices that some area in a tablespace seems to be in the process of being fully read into the buffer pool, it posts the remaining reads to the I/O system.

`InnoDB` uses a novel file flush technique called *doublewrite*. It adds safety to recovery following an operating system crash or a power outage, and improves performance on most varieties of Unix by reducing the need for `fsync()` operations.

Doublewrite means that before writing pages to a data file, `InnoDB` first writes them to a contiguous tablespace area called the doublewrite buffer. Only after the write and the flush to the doublewrite buffer has completed does `InnoDB` write the pages to their proper positions in the data file. If the operating system crashes in the middle of a page write, `InnoDB` can later find a good copy of the page from the doublewrite buffer during recovery.

### 13.6.11.2. File Space Management

The data files that you define in the configuration file form the `InnoDB` tablespace. The files are simply concatenated to form the tablespace. There is no striping in use. Currently, you cannot define where within the tablespace your tables are allocated. However, in a newly created tablespace, `InnoDB` allocates space starting from the first data file.

The tablespace consists of database pages with a default size of 16KB. The pages are grouped into extents of size 1MB (64 consecutive pages). The “files” inside a tablespace are called *segments* in `InnoDB`. The term “rollback segment” is somewhat confusing because it actually contains many tablespace segments.

When a segment grows inside the tablespace, `InnoDB` allocates the first 32 pages to it individually. After that, `InnoDB` starts to allocate whole extents to the segment. `InnoDB` can add up to 4 extents at a time to a large segment to ensure good sequentiality of data.

Two segments are allocated for each index in `InnoDB`. One is for non-leaf nodes of the B-tree, the other is for the leaf nodes. The idea here is to achieve better sequentiality for the leaf nodes, which contain the data.

Some pages in the tablespace contain bitmaps of other pages, and therefore a few extents in an `InnoDB` tablespace cannot be allocated to segments as a whole, but only as individual pages.

When you ask for available free space in the tablespace by issuing a `SHOW TABLE STATUS` statement, `InnoDB` reports the extents that are definitely free in the tablespace. `InnoDB` always reserves some extents for cleanup and other internal purposes; these reserved extents are not included in the free space.

When you delete data from a table, `InnoDB` contracts the corresponding B-tree indexes. Whether the freed space becomes available for other users depends on whether the pattern of deletes frees individual pages or extents to the tablespace. Dropping a table or deleting all rows from it is guaranteed to release the space to other users, but remember that deleted rows are physically removed only in an (automatic) purge operation after they are no longer needed for transaction rollbacks or consistent reads. (See [Section 13.6.9, “InnoDB Multi-Versioning”](#).)

The maximum row length, except for variable-length columns (`VARBINARY`, `VARCHAR`, `BLOB` and `TEXT`), is slightly less than half of a database page. That is, the maximum row length is about 8000 bytes. `LONGLOB` and `LONGTEXT` columns must be less than 4GB, and the total row length, including `BLOB` and `TEXT` columns, must be less than 4GB.

If a row is less than half a page long, all of it is stored locally within the page. If it exceeds half a page, variable-length columns are chosen for external off-page storage until the row fits within half a page. For a column chosen for off-page storage, `InnoDB` stores the first 768 bytes locally in the row, and the rest externally into overflow pages. Each such column has its own list of overflow pages. The 768-byte prefix is accompanied by a 20-byte value that stores the true length of the column and points into the overflow list where the rest of the value is stored.

To see information about the tablespace, use the Tablespace Monitor. See [Section 13.6.13.2, “SHOW ENGINE INNODB STATUS and the InnoDB Monitors”](#).

### 13.6.11.3. Defragmenting a Table

If there are random insertions into or deletions from the indexes of a table, the indexes may become fragmented. Fragmentation means that the physical ordering of the index pages on the disk is not close to the index ordering of the records on the pages, or that there are many unused pages in the 64-page blocks that were allocated to the index.

One symptom of fragmentation is that a table takes more space than it “should” take. How much that is exactly, is difficult to determine. All InnoDB data and indexes are stored in B-trees, and their fill factor may vary from 50% to 100%. Another symptom of fragmentation is that a table scan such as this takes more time than it “should” take:

```
SELECT COUNT(*) FROM t WHERE a_non_indexed_column <> 12345;
```

(In the preceding query, we are “fooling” the SQL optimizer into scanning the clustered index rather than a secondary index.) Most disks can read 10MB/s to 50MB/s, which can be used to estimate how fast a table scan should be.

It can speed up index scans if you periodically perform a “null” `ALTER TABLE` operation, which causes MySQL to rebuild the table:

```
ALTER TABLE tbl_name ENGINE=INNODB
```

Another way to perform a defragmentation operation is to use `mysqldump` to dump the table to a text file, drop the table, and reload it from the dump file.

If the insertions into an index are always ascending and records are deleted only from the end, the InnoDB filespace management algorithm guarantees that fragmentation in the index does not occur.

## 13.6.12. InnoDB Error Handling

Error handling in InnoDB is not always the same as specified in the SQL standard. According to the standard, any error during an SQL statement should cause rollback of that statement. InnoDB sometimes rolls back only part of the statement, or the whole transaction. The following items describe how InnoDB performs error handling:

- If you run out of file space in the tablespace, a MySQL `Table is full` error occurs and InnoDB rolls back the SQL statement.
- A transaction deadlock causes InnoDB to roll back the entire transaction. You should normally retry the whole transaction when this happens.

A lock wait timeout causes InnoDB to roll back only the single statement that was waiting for the lock and encountered the timeout. (To have the entire transaction roll back, start the server with the `--innodb_rollback_on_timeout` option, available as of MySQL 5.1.15.) You should normally retry the statement if using the current behavior or the entire transaction if using `--innodb_rollback_on_timeout`.

Both deadlocks and lock wait timeouts are normal on busy servers and it is necessary for applications to be aware that they may happen and handle them by retrying. You can make them less likely by doing as little work as possible between the first change to data during a transaction and the commit, so the locks are held for the shortest possible time and for the smallest possible number of rows. Sometimes splitting work between different transactions may be practical and helpful.

When a transaction rollback occurs due to a deadlock or lock wait timeout, it cancels the effect of the statements within the transaction. But if the start-transaction statement was `START TRANSACTION` or `BEGIN` statement, rollback does not cancel that statement. Further SQL statements become part of the transaction until the occurrence of `COMMIT`, `ROLLBACK`, or some SQL statement that causes an implicit commit.

- A duplicate-key error rolls back the SQL statement, if you have not specified the `IGNORE` option in your statement.
- A `row too long error` rolls back the SQL statement.
- Other errors are mostly detected by the MySQL layer of code (above the InnoDB storage engine level), and they roll back the corresponding SQL statement. Locks are not released in a rollback of a single SQL statement.

During implicit rollbacks, as well as during the execution of an explicit `ROLLBACK` SQL statement, `SHOW PROCESSLIST` displays `Rolling back` in the `State` column for the relevant connection.

### 13.6.12.1. InnoDB Error Codes

The following is a non-exhaustive list of common `InnoDB`-specific errors that you may encounter, with information about why each occurs and how to resolve the problem.

- `1005 (ER_CANT_CREATE_TABLE)`  
Cannot create table. If the error message refers to error 150, table creation failed because a foreign key constraint was not correctly formed. If the error message refers to error -1, table creation probably failed because the table includes a column name that matched the name of an internal `InnoDB` table.
- `1016 (ER_CANT_OPEN_FILE)`  
Cannot find the `InnoDB` table from the `InnoDB` data files, although the `.frm` file for the table exists. See [Section 13.6.13.4, “Troubleshooting InnoDB Data Dictionary Operations”](#).
- `1114 (ER_RECORD_FILE_FULL)`  
`InnoDB` has run out of free space in the tablespace. You should reconfigure the tablespace to add a new data file.
- `1205 (ER_LOCK_WAIT_TIMEOUT)`  
Lock wait timeout expired. Transaction was rolled back.
- `1213 (ER_LOCK_DEADLOCK)`  
Transaction deadlock. You should rerun the transaction.
- `1216 (ER_NO_REFERENCED_ROW)`  
You are trying to add a row but there is no parent row, and a foreign key constraint fails. You should add the parent row first.
- `1217 (ER_ROW_IS_REFERENCED)`  
You are trying to delete a parent row that has children, and a foreign key constraint fails. You should delete the children first.

### 13.6.12.2. Operating System Error Codes

To print the meaning of an operating system error number, use the `perro` program that comes with the MySQL distribution.

The following table provides a list of some common Linux system error codes. For a more complete list, see [Linux source code](#).

- `1 (EPERM)`  
Operation not permitted
- `2 (ENOENT)`  
No such file or directory
- `3 (ESRCH)`  
No such process
- `4 (EINTR)`  
Interrupted system call
- `5 (EIO)`  
I/O error
- `6 (ENXIO)`  
No such device or address
- `7 (E2BIG)`  
Arg list too long
- `8 (ENOEXEC)`

- Exec format error
- 9 (EBADF)
- Bad file number
- 10 (ECHILD)
- No child processes
- 11 (EAGAIN)
- Try again
- 12 (ENOMEM)
- Out of memory
- 13 (EACCES)
- Permission denied
- 14 (EFAULT)
- Bad address
- 15 (ENOTBLK)
- Block device required
- 16 (EBUSY)
- Device or resource busy
- 17 (EEXIST)
- File exists
- 18 (EXDEV)
- Cross-device link
- 19 (ENODEV)
- No such device
- 20 (ENOTDIR)
- Not a directory
- 21 (EISDIR)
- Is a directory
- 22 (EINVAL)
- Invalid argument
- 23 (ENFILE)
- File table overflow
- 24 (EMFILE)
- Too many open files
- 25 (ENOTTY)
- Inappropriate ioctl for device
- 26 (ETXTBSY)

Text file busy

- 27 (EFBIG)

File too large

- 28 (ENOSPC)

No space left on device

- 29 (ESPIPE)

Illegal seek

- 30 (EROFS)

Read-only file system

- 31 (EMLINK)

Too many links

The following table provides a list of some common Windows system error codes. For a complete list, see the [Microsoft Web site](#).

- 1 (ERROR\_INVALID\_FUNCTION)  
Incorrect function.
- 2 (ERROR\_FILE\_NOT\_FOUND)  
The system cannot find the file specified.
- 3 (ERROR\_PATH\_NOT\_FOUND)  
The system cannot find the path specified.
- 4 (ERROR\_TOO\_MANY\_OPEN\_FILES)  
The system cannot open the file.
- 5 (ERROR\_ACCESS\_DENIED)  
Access is denied.
- 6 (ERROR\_INVALID\_HANDLE)  
The handle is invalid.
- 7 (ERROR\_ARENA\_TRASHED)  
The storage control blocks were destroyed.
- 8 (ERROR\_NOT\_ENOUGH\_MEMORY)  
Not enough storage is available to process this command.
- 9 (ERROR\_INVALID\_BLOCK)  
The storage control block address is invalid.
- 10 (ERROR\_BAD\_ENVIRONMENT)  
The environment is incorrect.
- 11 (ERROR\_BAD\_FORMAT)  
An attempt was made to load a program with an incorrect format.
- 12 (ERROR\_INVALID\_ACCESS)

The access code is invalid.

- 13 (ERROR\_INVALID\_DATA)

The data is invalid.

- 14 (ERROR\_OUTOFMEMORY)

Not enough storage is available to complete this operation.

- 15 (ERROR\_INVALID\_DRIVE)

The system cannot find the drive specified.

- 16 (ERROR\_CURRENT\_DIRECTORY)

The directory cannot be removed.

- 17 (ERROR\_NOT\_SAME\_DEVICE)

The system cannot move the file to a different disk drive.

- 18 (ERROR\_NO\_MORE\_FILES)

There are no more files.

- 19 (ERROR\_WRITE\_PROTECT)

The media is write protected.

- 20 (ERROR\_BAD\_UNIT)

The system cannot find the device specified.

- 21 (ERROR\_NOT\_READY)

The device is not ready.

- 22 (ERROR\_BAD\_COMMAND)

The device does not recognize the command.

- 23 (ERROR\_CRC)

Data error (cyclic redundancy check).

- 24 (ERROR\_BAD\_LENGTH)

The program issued a command but the command length is incorrect.

- 25 (ERROR\_SEEK)

The drive cannot locate a specific area or track on the disk.

- 26 (ERROR\_NOT\_DOS\_DISK)

The specified disk or diskette cannot be accessed.

- 27 (ERROR\_SECTOR\_NOT\_FOUND)

The drive cannot find the sector requested.

- 28 (ERROR\_OUT\_OF\_PAPER)

The printer is out of paper.

- 29 (ERROR\_WRITE\_FAULT)

The system cannot write to the specified device.

- 30 (ERROR\_READ\_FAULT)

The system cannot read from the specified device.

- 31 (`ERROR_GEN_FAILURE`)

A device attached to the system is not functioning.

- 32 (`ERROR_SHARING_VIOLATION`)

The process cannot access the file because it is being used by another process.

- 33 (`ERROR_LOCK_VIOLATION`)

The process cannot access the file because another process has locked a portion of the file.

- 34 (`ERROR_WRONG_DISK`)

The wrong diskette is in the drive. Insert %2 (Volume Serial Number: %3) into drive %1.

- 36 (`ERROR_SHARING_BUFFER_EXCEEDED`)

Too many files opened for sharing.

- 38 (`ERROR_HANDLE_EOF`)

Reached the end of the file.

- 39 (`ERROR_HANDLE_DISK_FULL`)

The disk is full.

- 87 (`ERROR_INVALID_PARAMETER`)

The parameter is incorrect.

- 112 (`ERROR_DISK_FULL`)

The disk is full.

- 123 (`ERROR_INVALID_NAME`)

The file name, directory name, or volume label syntax is incorrect.

- 1450 (`ERROR_NO_SYSTEM_RESOURCES`)

Insufficient system resources exist to complete the requested service.

## 13.6.13. InnoDB Performance Tuning and Troubleshooting

### 13.6.13.1. InnoDB Performance Tuning Tips

- In `InnoDB`, having a long `PRIMARY KEY` wastes a lot of disk space because its value must be stored with every secondary index record. (See [Section 13.6.10, “InnoDB Table and Index Structures”](#).) Create an `AUTO_INCREMENT` column as the primary key if your primary key is long.
- If you have `UNIQUE` constraints on secondary keys, you can speed up table imports by temporarily turning off the uniqueness checks during the import session:

```
SET unique_checks=0;
... import operation ...
SET unique_checks=1;
```

For big tables, this saves a lot of disk I/O because `InnoDB` can use its insert buffer to write secondary index records in a batch. Be certain that the data contains no duplicate keys.

- If you have `FOREIGN KEY` constraints in your tables, you can speed up table imports by turning the foreign key checks off for the duration of the import session:

```
SET foreign_key_checks=0;
... import operation ...
```

```
SET foreign_key_checks=1;
```

For big tables, this can save a lot of disk I/O.

- If the Unix `top` tool or the Windows Task Manager shows that the CPU usage percentage with your workload is less than 70%, your workload is probably disk-bound. Maybe you are making too many transaction commits, or the buffer pool is too small. Making the buffer pool bigger can help, but do not set it equal to more than 80% of physical memory.
- Wrap several modifications into a single transaction to reduce the number of flush operations. `InnoDB` must flush the log to disk at each transaction commit if that transaction made modifications to the database. The rotation speed of a disk is typically at most 167 revolutions/second, which constrains the number of commits to the same 167<sup>th</sup> of a second if the disk does not “fool” the operating system.
- If you can afford the loss of some of the latest committed transactions if a crash occurs, you can set the `innodb_flush_log_at_trx_commit` parameter to 0. `InnoDB` tries to flush the log once per second anyway, although the flush is not guaranteed. You should also set the value of `innodb_support_xa` to 0, which will reduce the number of disk flushes due to synchronizing on disk data and the binary log.
- Make your log files big, even as big as the buffer pool. When `InnoDB` has written the log files full, it must write the modified contents of the buffer pool to disk in a checkpoint. Small log files cause many unnecessary disk writes. The disadvantage of big log files is that the recovery time is longer.
- Make the log buffer quite large as well (on the order of 8MB).
- Use the `VARCHAR` data type instead of `CHAR` if you are storing variable-length strings or if the column may contain many `NULL` values. A `CHAR(N)` column always takes `N` characters to store data, even if the string is shorter or its value is `NULL`. Smaller tables fit better in the buffer pool and reduce disk I/O.

When using `COMPACT` row format (the default `InnoDB` format in MySQL 5.1) and variable-length character sets, such as `utf8` or `sjis`, `CHAR(N)` will occupy a variable amount of space, at least `N` bytes.

- In some versions of GNU/Linux and Unix, flushing files to disk with the Unix `fsync()` call (which `InnoDB` uses by default) and other similar methods is surprisingly slow. If you are dissatisfied with database write performance, you might try setting the `innodb_flush_method` parameter to `O_DSYNC`. The `O_DSYNC` flush method seems to perform slower on most systems, but yours might not be one of them.
- When using the `InnoDB` storage engine on Solaris 10 for x86\_64 architecture (AMD Opteron), it is important to mount any file systems used for storing `InnoDB`-related files using the `forcedirectio` option. (The default on Solaris 10/x86\_64 is *not* to use this option.) Failure to use `forcedirectio` causes a serious degradation of `InnoDB`'s speed and performance on this platform.

When using the `InnoDB` storage engine with a large `innodb_buffer_pool_size` value on any release of Solaris 2.6 and up and any platform (sparc/x86/x64/amd64), a significant performance gain might be achieved by placing `InnoDB` data files and log files on raw devices or on a separate direct I/O UFS file system (using the `forcedirectio` mount option; see `mount_ufs(1M)`). Users of the Veritas file system VxFS should use the `convosync=direct` mount option. You are advised to perform tests with and without raw partitions or direct I/O file systems to verify whether performance is improved on your system.

Other MySQL data files, such as those for `MyISAM` tables, should not be placed on a direct I/O file system. Executables or libraries *must not* be placed on a direct I/O file system.

- When importing data into `InnoDB`, make sure that MySQL does not have autocommit mode enabled because that requires a log flush to disk for every insert. To disable autocommit during your import operation, surround it with `SET autocommit` and `COMMIT` statements:

```
SET autocommit=0;
... SQL import statements ...
COMMIT;
```

If you use the `mysqldump` option `--opt`, you get dump files that are fast to import into an `InnoDB` table, even without wrapping them with the `SET autocommit` and `COMMIT` statements.

- Beware of big rollbacks of mass inserts: `InnoDB` uses the insert buffer to save disk I/O in inserts, but no such mechanism is used in a corresponding rollback. A disk-bound rollback can take 30 times as long to perform as the corresponding insert. Killing the database process does not help because the rollback starts again on server startup. The only way to get rid of a run-away rollback is to increase the buffer pool so that the rollback becomes CPU-bound and runs fast, or to use a special procedure. See Section 13.6.6.2, “Forcing `InnoDB` Recovery”.
- Beware also of other big disk-bound operations. Use `DROP TABLE` and `CREATE TABLE` to empty a table, not `DELETE FROM tbl_name`.



- Use the multiple-row `INSERT` syntax to reduce communication overhead between the client and the server if you need to insert many rows:

```
INSERT INTO yourtable VALUES (1,2), (5,5), ...;
```

This tip is valid for inserts into any table, not just `InnoDB` tables.

- If you often have recurring queries for tables that are not updated frequently, enable the query cache:

```
[mysqld]
query_cache_type = 1
query_cache_size = 10M
```

- Unlike `MyISAM`, `InnoDB` does not store an index cardinality value in its tables. Instead, `InnoDB` computes a cardinality for a table the first time it accesses it after startup. With a large number of tables, this might take significant time. It is the initial table open operation that is important, so to “warm up” a table for later use, access it immediately after startup by issuing a statement such as `SELECT 1 FROM tbl_name LIMIT 1`.

### MySQL Enterprise

For optimization recommendations geared to your specific circumstances subscribe to the MySQL Enterprise Monitor. For more information, see <http://www.mysql.com/products/enterprise/advisors.html>.

## 13.6.13.2. SHOW ENGINE INNODB STATUS and the InnoDB Monitors

`InnoDB` Monitors provide information about the `InnoDB` internal state. This information is useful for performance tuning. Each Monitor can be enabled by creating a table with a special name, which causes `InnoDB` to write Monitor output periodically. Also, output for the standard `InnoDB` Monitor is available on demand via the `SHOW ENGINE INNODB STATUS` SQL statement.

There are several types of `InnoDB` Monitors:

- The standard `InnoDB` Monitor displays the following types of information:
  - Table and record locks held by each active transaction
  - Lock waits of a transactions
  - Semaphore waits of threads
  - Pending file I/O requests
  - Buffer pool statistics
  - Purge and insert buffer merge activity of the main `InnoDB` thread

For a discussion of `InnoDB` lock modes, see [Section 13.6.8.1, “InnoDB Lock Modes”](#).

To enable the standard `InnoDB` Monitor for periodic output, create a table named `innodb_monitor`. To obtain Monitor output on demand, use the `SHOW ENGINE INNODB STATUS` SQL statement to fetch the output to your client program. If you are using the `mysql` interactive client, the output is more readable if you replace the usual semicolon statement terminator with `\G`:

```
mysql> SHOW ENGINE INNODB STATUS\G
```

- The `InnoDB` Lock Monitor is like the standard Monitor but also provides extensive lock information. To enable this Monitor for periodic output, create a table named `innodb_lock_monitor`.
- The `InnoDB` Tablespace Monitor prints a list of file segments in the shared tablespace and validates the tablespace allocation data structures. To enable this Monitor for periodic output, create a table named `innodb_tablespace_monitor`.
- The `InnoDB` Table Monitor prints the contents of the `InnoDB` internal data dictionary. To enable this Monitor for periodic output, create a table named `innodb_table_monitor`.

To enable an `InnoDB` Monitor for periodic output, use a `CREATE TABLE` statement to create the table associated with the Monitor. For example, to enable the standard `InnoDB` Monitor, create the `innodb_monitor` table:

```
CREATE TABLE innodb_monitor (a INT) ENGINE=INNODB;
```

To stop the Monitor, drop the table:

```
DROP TABLE innodb_monitor;
```

The `CREATE TABLE` syntax is just a way to pass a command to the InnoDB engine through MySQL's SQL parser: The only things that matter are the table name `innodb_monitor` and that it be an InnoDB table. The structure of the table is not relevant at all for the InnoDB Monitor. If you shut down the server, the Monitor does not restart automatically when you restart the server. You must drop the Monitor table and issue a new `CREATE TABLE` statement to start the Monitor. (This syntax may change in a future release.)

As of MySQL 5.1.24, the `PROCESS` privilege is required to start or stop the InnoDB Monitor tables.

When you enable InnoDB Monitors for periodic output, InnoDB writes their output to the `mysqld` server standard error output (`stderr`). In this case, no output is sent to clients. When switched on, InnoDB Monitors print data about every 15 seconds. Server output usually is directed to the error log (see Section 5.2.2, “The Error Log”). This data is useful in performance tuning. On Windows, you must start the server from a command prompt in a console window with the `--console` option if you want to direct the output to the window rather than to the error log.

InnoDB sends diagnostic output to `stderr` or to files rather than to `stdout` or fixed-size memory buffers, to avoid potential buffer overflows. As a side effect, the output of `SHOW ENGINE INNODB STATUS` is written to a status file in the MySQL data directory every fifteen seconds. The name of the file is `innodb_status.pid`, where `pid` is the server process ID. InnoDB removes the file for a normal shutdown. If abnormal shutdowns have occurred, instances of these status files may be present and must be removed manually. Before removing them, you might want to examine them to see whether they contain useful information about the cause of abnormal shutdowns. The `innodb_status.pid` file is created only if the configuration option `innodb_status_file=1` is set.

InnoDB Monitors should be enabled only when you actually want to see Monitor information because output generation does result in some performance decrement. Also, if you enable monitor output by creating the associated table, your error log may become quite large if you forget to remove the table later.

For additional information about InnoDB monitors, see the following resources:

- Mark Leith: [InnoDB Table and Tablespace Monitors](#)
- MySQL Performance Blog: [SHOW INNODB STATUS walk through](#)

Each monitor begins with a header containing a timestamp and the monitor name. For example:

```
=====
090407 12:06:19 INNODB TABLESPACE MONITOR OUTPUT
=====
```

The header for the standard Monitor (`INNODB MONITOR OUTPUT`) is also used for the Lock Monitor because the latter produces the same output with the addition of extra lock information.

The following sections describe the output for each Monitor.

### 13.6.13.2.1. InnoDB Standard Monitor and Lock Monitor Output

The Lock Monitor is the same as the standard Monitor except that it includes additional lock information. Enabling either monitor for periodic output by creating the associated InnoDB table turns on the same output stream, but the stream includes the extra information if the Lock Monitor is enabled. For example, if you create the `innodb_monitor` and `innodb_lock_monitor` tables, that turns on a single output stream. The stream includes extra lock information until you disable the Lock Monitor by removing the `innodb_lock_monitor` table.

Example InnoDB Monitor output:

```
mysql> SHOW ENGINE INNODB STATUS\G
***** 1. row *****
Status:
=====
030709 13:00:59 INNODB MONITOR OUTPUT
=====
Per second averages calculated from the last 18 seconds
-----
SEMAPHORES
-----
OS WAIT ARRAY INFO: reservation count 413452, signal count 378357
--Thread 32782 has waited at btr0sea.c line 1477 for 0.00 seconds the
semaphore: X-lock on RW-latch at 41a28668 created in file btr0sea.c line 135
a writer (thread id 32782) has reserved it in mode wait exclusive
number of readers 1, waiters flag 1
Last time read locked in file btr0sea.c line 731
```



```

34831 rollback of SQL statement
ROLLING BACK 14 lock struct(s), heap size 2496, undo log entries 9
MySQL thread id 25, query id 4668733 localhost heikki update
insert into ibtest11a (D, B, C) values (5, 'khDk', 'khDk')
---TRANSACTION 0 290327208, ACTIVE 1 sec, process no 3190, OS thread id
32782
58 lock struct(s), heap size 5504, undo log entries 159
MySQL thread id 23, query id 4668732 localhost heikki update
REPLACE INTO alex1 VALUES(86, 46, 538,'aa95666','bb','c95666','d9486t',
'e200498f','g86814','h538',date_format('2001-04-03 12:54:22','%Y-%m-%d
%H:%i'),
---TRANSACTION 0 290323325, ACTIVE 3 sec, process no 3185, OS thread id
30733 inserting
4 lock struct(s), heap size 1024, undo log entries 165
MySQL thread id 21, query id 4668735 localhost heikki update
INSERT INTO alex1 VALUES(NULL, 49, NULL,'aa42837','','c56319','d1719t','','
NULL,'h321', NULL, NULL, 7.31,7.31,7.31,200)
-----
FILE I/O
-----
I/O thread 0 state: waiting for i/o request (insert buffer thread)
I/O thread 1 state: waiting for i/o request (log thread)
I/O thread 2 state: waiting for i/o request (read thread)
I/O thread 3 state: waiting for i/o request (write thread)
Pending normal aio reads: 0, aio writes: 0,
  ibuf aio reads: 0, log i/o's: 0, sync i/o's: 0
Pending flushes (fsync) log: 0; buffer pool: 0
151671 OS file reads, 94747 OS file writes, 8750 OS fsyncs
25.44 reads/s, 18494 avg bytes/read, 17.55 writes/s, 2.33 fsyncs/s
-----
INSERT BUFFER AND ADAPTIVE HASH INDEX
-----
Ibuf for space 0: size 1, free list len 19, seg size 21,
85004 inserts, 85004 merged recs, 26669 merges
Hash table size 207619, used cells 14461, node heap has 16 buffer(s)
1877.67 hash searches/s, 5121.10 non-hash searches/s
---
LOG
---
Log sequence number 18 1212842764
Log flushed up to 18 1212665295
Last checkpoint at 18 1135877290
0 pending log writes, 0 pending chkp writes
4341 log i/o's done, 1.22 log i/o's/second
-----
BUFFER POOL AND MEMORY
-----
Total memory allocated 84966343; in additional pool allocated 1402624
Buffer pool size 3200
Free buffers 110
Database pages 3074
Modified db pages 2674
Pending reads 0
Pending writes: LRU 0, flush list 0, single page 0
Pages read 171380, created 51968, written 194688
28.72 reads/s, 20.72 creates/s, 47.55 writes/s
Buffer pool hit rate 999 / 1000
-----
ROW OPERATIONS
-----
0 queries inside InnoDB, 0 queries in queue
Main thread process no. 3004, id 7176, state: purging
Number of rows inserted 3738558, updated 127415, deleted 33707, read 755779
1586.13 inserts/s, 50.89 updates/s, 28.44 deletes/s, 107.88 reads/s
-----
END OF INNODB MONITOR OUTPUT
=====

```

InnoDB Monitor output is limited to 64,000 bytes when produced via the `SHOW ENGINE INNODB STATUS` statement. This limit does not apply to output written to the server's error output.

Some notes on the output sections:

- [SEMAPHORES](#)

This section reports threads waiting for a semaphore and statistics on how many times threads have needed a spin or a wait on a mutex or a rw-lock semaphore. A large number of threads waiting for semaphores may be a result of disk I/O, or contention problems inside InnoDB. Contention can be due to heavy parallelism of queries or problems in operating system thread scheduling. Setting the `innodb_thread_concurrency` system variable smaller than the default value might help in such situations.

- [LATEST FOREIGN KEY ERROR](#)

This section provides information about the most recent foreign key constraint error. It is not present if no such error has occurred. The contents include the statement that failed as well as information about the constraint that failed and the referenced and referencing tables.

- [LATEST DETECTED DEADLOCK](#)

This section provides information about the most recent deadlock. It is not present if no deadlock has occurred. The contents show which transactions are involved, the statement each was attempting to execute, the locks they have and need, and which transaction `InnoDB` decided to roll back to break the deadlock. The lock modes reported in this section are explained in [Section 13.6.8.1, “InnoDB Lock Modes”](#).

- [TRANSACTIONS](#)

If this section reports lock waits, your applications might have lock contention. The output can also help to trace the reasons for transaction deadlocks.

- [FILE I/O](#)

This section provides information about threads that `InnoDB` uses to perform various types of I/O. The first few of these are dedicated to general `InnoDB` processing. The contents also display information for pending I/O operations and statistics for I/O performance.

On Unix, the number of threads is always 4. On Windows, the number depends on the setting of the `innodb_file_io_threads` system variable.

- [INSERT BUFFER AND ADAPTIVE HASH INDEX](#)

This section shows the status of the `InnoDB` insert buffer and adaptive hash index. (See [Section 13.6.10.3, “Insert Buffering”](#), and [Section 13.6.10.4, “Adaptive Hash Indexes”](#).) The contents include the number of operations performed for each, plus statistics for hash index performance.

- [LOG](#)

This section displays information about the `InnoDB` log. The contents include the current log sequence number, how far the log has been flushed to disk, and the position at which `InnoDB` last took a checkpoint. (See [Section 13.6.6.3, “InnoDB Checkpoints”](#).) The section also displays information about pending writes and write performance statistics.

- [BUFFER POOL AND MEMORY](#)

This section gives you statistics on pages read and written. You can calculate from these numbers how many data file I/O operations your queries currently are doing.

- [ROW OPERATIONS](#)

This section shows what the main thread is doing, including the number and performance rate for each type of row operation.

### 13.6.13.2.2. `InnoDB` Tablespace Monitor Output

The `InnoDB` Tablespace Monitor prints information about the file segments in the shared tablespace and validates the tablespace allocation data structures. If you use individual tablespaces by enabling `innodb_file_per_table`, the Tablespace Monitor does not describe those tablespaces.

Example `InnoDB` Tablespace Monitor output:

```
=====
090408 21:28:09 INNODB TABLESPACE MONITOR OUTPUT
=====
FILE SPACE INFO: id 0
size 13440, free limit 3136, free extents 28
not full frag extents 2: used pages 78, full frag extents 3
first seg id not used 0 23845
SEGMENT id 0 1 space 0; page 2; res 96 used 46; full ext 0
fragm pages 32; free extents 0; not full extents 1: pages 14
SEGMENT id 0 2 space 0; page 2; res 1 used 1; full ext 0
fragm pages 1; free extents 0; not full extents 0: pages 0
SEGMENT id 0 3 space 0; page 2; res 1 used 1; full ext 0
fragm pages 1; free extents 0; not full extents 0: pages 0
...
SEGMENT id 0 15 space 0; page 2; res 160 used 160; full ext 2
fragm pages 32; free extents 0; not full extents 0: pages 0
SEGMENT id 0 488 space 0; page 2; res 1 used 1; full ext 0
fragm pages 1; free extents 0; not full extents 0: pages 0
SEGMENT id 0 17 space 0; page 2; res 1 used 1; full ext 0
fragm pages 1; free extents 0; not full extents 0: pages 0
...
SEGMENT id 0 171 space 0; page 2; res 592 used 481; full ext 7
fragm pages 16; free extents 0; not full extents 2: pages 17
SEGMENT id 0 172 space 0; page 2; res 1 used 1; full ext 0
fragm pages 1; free extents 0; not full extents 0: pages 0
SEGMENT id 0 173 space 0; page 2; res 96 used 44; full ext 0
fragm pages 32; free extents 0; not full extents 1: pages 12
...
SEGMENT id 0 601 space 0; page 2; res 1 used 1; full ext 0
```

```

fragm pages 1; free extents 0; not full extents 0: pages 0
NUMBER of file segments: 73
Validating tablespace
Validation ok
-----
END OF INNODB TABLESPACE MONITOR OUTPUT
=====

```

The Tablespace Monitor output includes information about the shared tablespace as a whole, followed by a list containing a breakdown for each segment within the tablespace.

The tablespace consists of database pages with a default size of 16KB. The pages are grouped into extents of size 1MB (64 consecutive pages).

The initial part of the output that displays overall tablespace information has this format:

```

FILE SPACE INFO: id 0
size 13440, free limit 3136, free extents 28
not full frag extents 2: used pages 78, full frag extents 3
first seg id not used 0 23845

```

Overall tablespace information includes these values:

- **id**: The tablespace ID. A value of 0 refers to the shared tablespace.
- **size**: The current tablespace size in pages.
- **free limit**: The minimum page number for which the free list has not been initialized. Pages at or above this limit are free.
- **free extents**: The number of free extents.
- **not full frag extents, used pages**: The number of fragment extents that are not completely filled, and the number of pages in those extents that have been allocated.
- **full frag extents**: The number of completely full fragment extents.
- **first seg id not used**: The first unused segment ID.

Individual segment information has this format:

```

SEGMENT id 0 15 space 0; page 2; res 160 used 160; full ext 2
fragm pages 32; free extents 0; not full extents 0: pages 0

```

Segment information includes these values:

**id**: The segment ID.

**space, page**: The tablespace number and page within the tablespace where the segment “inode” is located. A tablespace number of 0 indicates the shared tablespace. **InnoDB** uses inodes to keep track of segments in the tablespace. The other fields displayed for a segment (**id**, **res**, and so forth) are derived from information in the inode.

**res**: The number of pages allocated (reserved) for the segment.

**used**: The number of allocated pages in use by the segment.

**full ext**: The number of extents allocated for the segment that are completely used.

**fragm pages**: The number of initial pages that have been allocated to the segment.

**free extents**: The number of extents allocated for the segment that are completely unused.

**not full extents**: The number of extents allocated for the segment that are partially used.

**pages**: The number of pages used within the not-full extents.

When a segment grows, it starts as a single page, and **InnoDB** allocates the first pages for it individually, up to 32 pages (this is the **fragm pages** value). After that, **InnoDB** allocates complete 64-page extents. **InnoDB** can add up to 4 extents at a time to a large segment to ensure good sequentiality of data.

For the example segment shown earlier, it has 32 fragment pages, plus 2 full extents (64 pages each), for a total of 160 pages used out of 160 pages allocated. The following segment has 32 fragment pages and one partially full extent using 14 pages for a total of

46 pages used out of 96 pages allocated:

```
SEGMENT id 0 1 space 0; page 2; res 96 used 46; full ext 0
fragm pages 32; free extents 0; not full extents 1: pages 14
```

It is possible for a segment that has extents allocated to it to have a `fragm pages` value less than 32 if some of the individual pages have been deallocated subsequent to extent allocation.

### 13.6.13.2.3. InnoDB Table Monitor Output

The `InnoDB` Table Monitor prints the contents of the `InnoDB` internal data dictionary.

The output contains one section per table. The `SYS_FOREIGN` and `SYS_FOREIGN_COLS` sections are for internal data dictionary tables that maintain information about foreign keys. There are also sections for the Table Monitor table and each user-created `InnoDB` table. Suppose that the following two tables have been created in the `test` database:

```
CREATE TABLE parent
(
  par_id      INT NOT NULL,
  fname      CHAR(20),
  lname      CHAR(20),
  PRIMARY KEY (par_id),
  UNIQUE INDEX (lname, fname)
) ENGINE = INNODB;

CREATE TABLE child
(
  par_id      INT NOT NULL,
  child_id   INT NOT NULL,
  name       VARCHAR(40),
  birth      DATE,
  weight     DECIMAL(10,2),
  misc_info  VARCHAR(255),
  last_update TIMESTAMP,
  PRIMARY KEY (par_id, child_id),
  INDEX (name),
  FOREIGN KEY (par_id) REFERENCES parent (par_id)
  ON DELETE CASCADE
  ON UPDATE CASCADE
) ENGINE = INNODB;
```

Then the Table Monitor output will look something like this (reformatted slightly):

```
=====
090420 12:09:32 INNODB TABLE MONITOR OUTPUT
=====
TABLE: name SYS_FOREIGN, id 0 11, columns 7, indexes 3, appr.rows 1
  COLUMNS: ID: DATA_VARCHAR DATA_ENGLISH len 0;
            FOR_NAME: DATA_VARCHAR DATA_ENGLISH len 0;
            REF_NAME: DATA_VARCHAR DATA_ENGLISH len 0;
            N_COLS: DATA_INT len 4;
            DB_ROW_ID: DATA_SYS prtype 256 len 6;
            DB_TRX_ID: DATA_SYS prtype 257 len 6;
  INDEX: name ID_IND, id 0 11, fields 1/6, uniq 1, type 3
        root page 46, appr.key vals 1, leaf pages 1, size pages 1
        FIELDS: ID DB_TRX_ID DB_ROLL_PTR FOR_NAME REF_NAME N_COLS
  INDEX: name FOR_IND, id 0 12, fields 1/2, uniq 2, type 0
        root page 47, appr.key vals 1, leaf pages 1, size pages 1
        FIELDS: FOR_NAME ID
  INDEX: name REF_IND, id 0 13, fields 1/2, uniq 2, type 0
        root page 48, appr.key vals 1, leaf pages 1, size pages 1
        FIELDS: REF_NAME ID
-----
TABLE: name SYS_FOREIGN_COLS, id 0 12, columns 7, indexes 1, appr.rows 1
  COLUMNS: ID: DATA_VARCHAR DATA_ENGLISH len 0;
            POS: DATA_INT len 4;
            FOR_COL_NAME: DATA_VARCHAR DATA_ENGLISH len 0;
            REF_COL_NAME: DATA_VARCHAR DATA_ENGLISH len 0;
            DB_ROW_ID: DATA_SYS prtype 256 len 6;
            DB_TRX_ID: DATA_SYS prtype 257 len 6;
  INDEX: name ID_IND, id 0 14, fields 2/6, uniq 2, type 3
        root page 49, appr.key vals 1, leaf pages 1, size pages 1
        FIELDS: ID POS DB_TRX_ID DB_ROLL_PTR FOR_COL_NAME REF_COL_NAME
-----
TABLE: name test/child, id 0 14, columns 10, indexes 2, appr.rows 201
  COLUMNS: par_id: DATA_INT DATA_BINARY_TYPE DATA_NOT_NULL len 4;
            child_id: DATA_INT DATA_BINARY_TYPE DATA_NOT_NULL len 4;
            name: DATA_VARCHAR prtype 524303 len 40;
            birth: DATA_INT DATA_BINARY_TYPE len 3;
            weight: DATA_FIXBINARY DATA_BINARY_TYPE len 5;
            misc_info: DATA_VARCHAR prtype 524303 len 255;
            last_update: DATA_INT DATA_UNSIGNED DATA_BINARY_TYPE DATA_NOT_NULL len 4;
            DB_ROW_ID: DATA_SYS prtype 256 len 6;
            DB_TRX_ID: DATA_SYS prtype 257 len 6;
  INDEX: name PRIMARY, id 0 17, fields 2/9, uniq 2, type 3
        root page 52, appr.key vals 201, leaf pages 5, size pages 6
        FIELDS: par_id child_id DB_TRX_ID DB_ROLL_PTR name birth weight misc_info last_update
```

```

INDEX: name name, id 0 18, fields 1/3, uniq 3, type 0
root page 53, appr.key vals 210, leaf pages 1, size pages 1
FIELDS: name par_id child_id
FOREIGN KEY CONSTRAINT test/child_ibfk_1: test/child ( par_id )
REFERENCES test/parent ( par_id )
-----
TABLE: name test/innodb_table_monitor, id 0 15, columns 4, indexes 1, appr.rows 0
COLUMNS: i: DATA_INT DATA_BINARY_TYPE len 4;
          DB_ROW_ID: DATA_SYS prtype 256 len 6;
          DB_TRX_ID: DATA_SYS prtype 257 len 6;
INDEX: name GEN_CLUST_INDEX, id 0 19, fields 0/4, uniq 1, type 1
root page 193, appr.key vals 0, leaf pages 1, size pages 1
FIELDS: DB_ROW_ID DB_TRX_ID DB_ROLL_PTR i
-----
TABLE: name test/parent, id 0 13, columns 6, indexes 2, appr.rows 299
COLUMNS: par_id: DATA_INT DATA_BINARY_TYPE DATA_NOT_NULL len 4;
          fname: DATA_CHAR prtype 524542 len 20;
          lname: DATA_CHAR prtype 524542 len 20;
          DB_ROW_ID: DATA_SYS prtype 256 len 6;
          DB_TRX_ID: DATA_SYS prtype 257 len 6;
INDEX: name PRIMARY, id 0 15, fields 1/5, uniq 1, type 3
root page 50, appr.key vals 299, leaf pages 2, size pages 3
FIELDS: par_id DB_TRX_ID DB_ROLL_PTR fname lname
INDEX: name lname, id 0 16, fields 2/3, uniq 2, type 2
root page 51, appr.key vals 300, leaf pages 1, size pages 1
FIELDS: lname fname par_id
FOREIGN KEY CONSTRAINT test/child_ibfk_1: test/child ( par_id )
REFERENCES test/parent ( par_id )
-----
END OF INNODB TABLE MONITOR OUTPUT
=====

```

For each table, Table Monitor output contains a section that displays general information about the table and specific information about its columns, indexes, and foreign keys.

The general information for each table includes the table name (in *db\_name/tbl\_name* format except for internal tables), its ID, the number of columns and indexes, and an approximate row count.

The **COLUMNS** part of a table section lists each column in the table. Information for each column indicates its name and data type characteristics. Some internal columns are added by InnoDB, such as **DB\_ROW\_ID** (row ID), **DB\_TRX\_ID** (transaction ID), and **DB\_ROLL\_PTR** (a pointer to the rollback/undo data).

- **DATA\_xxx**: These symbols indicate the data type. There may be multiple **DATA\_xxx** symbols for a given column.
- **prtype**: The column's "precise" type. This field includes information such as the column data type, character set code, nullability, signedness, and whether it is a binary string. This field is described in the [innobase/include/data0type.h](#) source file.
- **len**: The column length in bytes.

Each **INDEX** part of the table section provides the name and characteristics of one table index:

- **name**: The index name. If the name is **PRIMARY**, the index is a primary key. If the name is **GEN\_CLUST\_INDEX**, the index is the clustered index that is created automatically if the table definition doesn't include a primary key or non-NULL unique index. See [Section 13.6.10.1, "Clustered and Secondary Indexes"](#).
- **id**: The index ID.
- **fields**: The number of fields in the index, as a value in *m/n* format:
  - **m** is the number of user-defined columns; that is, the number of columns you would see in the index definition in a **CREATE TABLE** statement.
  - **n** is the total number of index columns, including those added internally. For the clustered index, the total includes the other columns in the table definition, plus any columns added internally. For a secondary index, the total includes the columns from the primary key that are not part of the secondary index.
- **uniq**: The number of leading fields that are enough to determine index values uniquely.
- **type**: The index type. This is a bit field. For example, 1 indicates a clustered index and 2 indicates a unique index, so a clustered index (which always contains unique values), will have a **type** value of 3. An index with a **type** value of 0 is neither clustered nor unique. The flag values are defined in the [innobase/include/dict0mem.h](#) source file.
- **root page**: The index root page number.
- **appr. key vals**: The approximate index cardinality.



- `leaf pages`: The approximate number of leaf pages in the index.
- `size pages`: The approximate total number of pages in the index.
- `FIELDS`: The names of the fields in the index. For a clustered index that was generated automatically, the field list begins with the internal `DB_ROW_ID` (row ID) field. `DB_TRX_ID` and `DB_ROLL_PTR` are always added internally to the clustered index, following the fields that comprise the primary key. For a secondary index, the final fields are those from the primary key that are not part of the secondary index.

The end of the table section lists the `FOREIGN KEY` definitions that apply to the table. This information appears whether the table is a referencing or referenced table.

### 13.6.13.3. InnoDB General Troubleshooting

The following general guidelines apply to troubleshooting `InnoDB` problems:

- When an operation fails or you suspect a bug, you should look at the MySQL server error log (see [Section 5.2.2, “The Error Log”](#)).
- When troubleshooting, it is usually best to run the MySQL server from the command prompt, rather than through `mysqld_safe` or as a Windows service. You can then see what `mysqld` prints to the console, and so have a better grasp of what is going on. On Windows, start `mysqld` with the `--console` option to direct the output to the console window.
- Use the `InnoDB` Monitors to obtain information about a problem (see [Section 13.6.13.2, “SHOW ENGINE INNODB STATUS and the InnoDB Monitors”](#)). If the problem is performance-related, or your server appears to be hung, you should use the standard Monitor to print information about the internal state of `InnoDB`. If the problem is with locks, use the Lock Monitor. If the problem is in creation of tables or other data dictionary operations, use the Table Monitor to print the contents of the `InnoDB` internal data dictionary. To see tablespace information use the Tablespace Monitor.
- If you suspect that a table is corrupt, run `CHECK TABLE` on that table.

#### MySQL Enterprise

The MySQL Enterprise Monitor provides a number of advisors specifically designed for monitoring `InnoDB` tables. In some cases, these advisors can anticipate potential problems. For more information, see <http://www.mysql.com/products/enterprise/advisors.html>.

### 13.6.13.4. Troubleshooting InnoDB Data Dictionary Operations

A specific issue with tables is that the MySQL server keeps data dictionary information in `.frm` files it stores in the database directories, whereas `InnoDB` also stores the information into its own data dictionary inside the tablespace files. If you move `.frm` files around, or if the server crashes in the middle of a data dictionary operation, the locations of the `.frm` files may end up out of synchrony with the locations recorded in the `InnoDB` internal data dictionary.

A symptom of an out-of-sync data dictionary is that a `CREATE TABLE` statement fails. If this occurs, you should look in the server's error log. If the log says that the table already exists inside the `InnoDB` internal data dictionary, you have an orphaned table inside the `InnoDB` tablespace files that has no corresponding `.frm` file. The error message looks like this:

```
InnoDB: Error: table test/parent already exists in InnoDB internal
InnoDB: data dictionary. Have you deleted the .frm file
InnoDB: and not used DROP TABLE? Have you used DROP DATABASE
InnoDB: for InnoDB tables in MySQL version <= 3.23.43?
InnoDB: See the Restrictions section of the InnoDB manual.
InnoDB: You can drop the orphaned table inside InnoDB by
InnoDB: creating an InnoDB table with the same name in another
InnoDB: database and moving the .frm file to the current database.
InnoDB: Then MySQL thinks the table exists, and DROP TABLE will
InnoDB: succeed.
```

You can drop the orphaned table by following the instructions given in the error message. If you are still unable to use `DROP TABLE` successfully, the problem may be due to name completion in the `mysql` client. To work around this problem, start the `mysql` client with the `--skip-auto-rehash` option and try `DROP TABLE` again. (With name completion on, `mysql` tries to construct a list of table names, which fails when a problem such as just described exists.)

Another symptom of an out-of-sync data dictionary is that MySQL prints an error that it cannot open a `.InnoDB` file:

```
ERROR 1016: Can't open file: 'child2.InnoDB'. (errno: 1)
```

In the error log you can find a message like this:

```
InnoDB: Cannot find table test/child2 from the internal data dictionary
InnoDB: of InnoDB though the .frm file for the table exists. Maybe you
InnoDB: have deleted and recreated InnoDB data files but have forgotten
InnoDB: to delete the corresponding .frm files of InnoDB tables?
```

This means that there is an orphaned `.frm` file without a corresponding table inside `InnoDB`. You can drop the orphaned `.frm` file by deleting it manually.

If MySQL crashes in the middle of an `ALTER TABLE` operation, you may end up with an orphaned temporary table inside the `InnoDB` tablespace. Using the Table Monitor, you can see listed a table with a name that begins with `#sql-`. You can perform SQL statements on tables whose name contains the character “#” if you enclose the name within backticks. Thus, you can drop such an orphaned table like any other orphaned table using the method described earlier. To copy or rename a file in the Unix shell, you need to put the file name in double quotes if the file name contains “#”.

### 13.6.14. Restrictions on `InnoDB` Tables

#### Warning

Do *not* convert MySQL system tables in the `mysql` database from `MyISAM` to `InnoDB` tables! This is an unsupported operation. If you do this, MySQL does not restart until you restore the old system tables from a backup or regenerate them with the `mysql_install_db` script.

#### Warning

It is not a good idea to configure `InnoDB` to use data files or log files on NFS volumes. Otherwise, the files might be locked by other processes and become unavailable for use by MySQL.

- A table cannot contain more than 1000 columns.
- The `InnoDB` internal maximum key length is 3500 bytes, but MySQL itself restricts this to 3072 bytes.
- Index key prefixes can be up to 767 bytes. See [Section 12.1.13, “CREATE INDEX Syntax”](#).
- The maximum row length, except for variable-length columns (`VARBINARY`, `VARCHAR`, `BLOB` and `TEXT`), is slightly less than half of a database page. That is, the maximum row length is about 8000 bytes. `LONGBLOB` and `LONGTEXT` columns must be less than 4GB, and the total row length, including `BLOB` and `TEXT` columns, must be less than 4GB.

If a row is less than half a page long, all of it is stored locally within the page. If it exceeds half a page, variable-length columns are chosen for external off-page storage until the row fits within half a page, as described in [Section 13.6.11.2, “File Space Management”](#).

- Although `InnoDB` supports row sizes larger than 65535 internally, you cannot define a row containing `VARBINARY` or `VARCHAR` columns with a combined size larger than 65535:

```
mysql> CREATE TABLE t (a VARCHAR(8000), b VARCHAR(10000),
-> c VARCHAR(10000), d VARCHAR(10000), e VARCHAR(10000),
-> f VARCHAR(10000), g VARCHAR(10000)) ENGINE=InnoDB;
ERROR 1118 (42000): Row size too large. The maximum row size for the
used table type, not counting BLOBs, is 65535. You have to change some
columns to TEXT or BLOBs
```

- On some older operating systems, files must be less than 2GB. This is not a limitation of `InnoDB` itself, but if you require a large tablespace, you will need to configure it using several smaller data files rather than one or a file large data files.
- The combined size of the `InnoDB` log files must be less than 4GB.
- The minimum tablespace size is 10MB. The maximum tablespace size is four billion database pages (64TB). This is also the maximum size for a table.
- `InnoDB` tables do not support `FULLTEXT` indexes.
- `InnoDB` tables support spatial data types, but not indexes on them.
- `ANALYZE TABLE` determines index cardinality (as displayed in the `Cardinality` column of `SHOW INDEX` output) by doing ten random dives to each of the index trees and updating index cardinality estimates accordingly. Because these are only estimates, repeated runs of `ANALYZE TABLE` may produce different numbers. This makes `ANALYZE TABLE` fast on `InnoDB` tables but not 100% accurate because it does not take all rows into account.

MySQL uses index cardinality estimates only in join optimization. If some join is not optimized in the right way, you can try using `ANALYZE TABLE`. In the few cases that `ANALYZE TABLE` does not produce values good enough for your particular

tables, you can use `FORCE INDEX` with your queries to force the use of a particular index, or set the `max_seeks_for_key` system variable to ensure that MySQL prefers index lookups over table scans. See [Section 5.1.3, “Server System Variables”](#), and [Section B.1.6, “Optimizer-Related Issues”](#).

- `SHOW TABLE STATUS` does not give accurate statistics on `InnoDB` tables, except for the physical size reserved by the table. The row count is only a rough estimate used in SQL optimization.
- `InnoDB` does not keep an internal count of rows in a table. (In practice, this would be somewhat complicated due to multi-versioning.) To process a `SELECT COUNT(*) FROM t` statement, `InnoDB` must scan an index of the table, which takes some time if the index is not entirely in the buffer pool. If your table does not change often, using the MySQL query cache is a good solution. To get a fast count, you have to use a counter table you create yourself and let your application update it according to the inserts and deletes it does. `SHOW TABLE STATUS` also can be used if an approximate row count is sufficient. See [Section 13.6.13.1, “InnoDB Performance Tuning Tips”](#).
- On Windows, `InnoDB` always stores database and table names internally in lowercase. To move databases in a binary format from Unix to Windows or from Windows to Unix, you should create all databases and tables using lowercase names.
- For an `AUTO_INCREMENT` column, you must always define an index for the table, and that index must contain just the `AUTO_INCREMENT` column. In `MyISAM` tables, the `AUTO_INCREMENT` column may be part of a multi-column index.
- While initializing a previously specified `AUTO_INCREMENT` column on a table, `InnoDB` sets an exclusive lock on the end of the index associated with the `AUTO_INCREMENT` column. In accessing the auto-increment counter, `InnoDB` uses a specific table lock mode `AUTO-INC` where the lock lasts only to the end of the current SQL statement, not to the end of the entire transaction. Other clients cannot insert into the table while the `AUTO-INC` table lock is held; see [Section 13.6.4.3, “AUTO\\_INCREMENT Handling in InnoDB”](#).
- When you restart the MySQL server, `InnoDB` may reuse an old value that was generated for an `AUTO_INCREMENT` column but never stored (that is, a value that was generated during an old transaction that was rolled back).
- When an `AUTO_INCREMENT` column runs out of values, `InnoDB` wraps a `BIGINT` to `-9223372036854775808` and `BIGINT UNSIGNED` to `1`. However, `BIGINT` values have 64 bits, so if you were to insert one million rows per second, it would still take nearly three hundred thousand years before `BIGINT` reached its upper bound. With all other integer type columns, a duplicate-key error results. This is similar to how `MyISAM` works, because it is mostly general MySQL behavior and not about any storage engine in particular.
- `DELETE FROM tbl_name` does not regenerate the table but instead deletes all rows, one by one.
- Under some conditions, `TRUNCATE tbl_name` for an `InnoDB` table is mapped to `DELETE FROM tbl_name`. See [Section 12.2.10, “TRUNCATE Syntax”](#).
- In MySQL 5.1, the MySQL `LOCK TABLES` operation acquires two locks on each table if `innodb_table_locks = 1` (the default). In addition to a table lock on the MySQL layer, it also acquires an `InnoDB` table lock. Older versions of MySQL did not acquire `InnoDB` table locks; the old behavior can be selected by setting `innodb_table_locks = 0`. If no `InnoDB` table lock is acquired, `LOCK TABLES` completes even if some records of the tables are being locked by other transactions.
- All `InnoDB` locks held by a transaction are released when the transaction is committed or aborted. Thus, it does not make much sense to invoke `LOCK TABLES` on `InnoDB` tables in `autocommit = 1` mode, because the acquired `InnoDB` table locks would be released immediately.
- Sometimes it would be useful to lock further tables in the course of a transaction. Unfortunately, `LOCK TABLES` in MySQL performs an implicit `COMMIT` and `UNLOCK TABLES`. An `InnoDB` variant of `LOCK TABLES` has been planned that can be executed in the middle of a transaction.
- The `LOAD TABLE FROM MASTER` statement for setting up replication slave servers does not work for `InnoDB` tables. A workaround is to alter the table to `MyISAM` on the master, then do the load, and after that alter the master table back to `InnoDB`. Do not do this if the tables use `InnoDB`-specific features such as foreign keys.
- The default database page size in `InnoDB` is 16KB. By recompiling the code, you can set it to values ranging from 8KB to 64KB. You must update the values of `UNIV_PAGE_SIZE` and `UNIV_PAGE_SIZE_SHIFT` in the `univ.i` source file.
- Currently, cascaded foreign key actions do not activate triggers.
- You cannot create a table with a column name that matches the name of an internal `InnoDB` column (including `DB_ROW_ID`, `DB_TRX_ID`, `DB_ROLL_PTR`, and `DB_MIX_ID`). In versions of MySQL before 5.1.10 this would cause a crash, since 5.1.10 the server will report error 1005 and refers to error -1 in the error message. This limitation applies only to use of the names in uppercase.
- `InnoDB` has a limit of 1023 concurrent transactions that have created undo records by modifying data. Workarounds include keeping transactions as small and fast as possible, delaying changes until near the end of the transaction, and using stored routines to reduce client-server latency delays. Applications should commit transactions before doing time-consuming client-

side operations.

## 13.7. The MERGE Storage Engine

The **MERGE** storage engine, also known as the **MRG\_MyISAM** engine, is a collection of identical **MyISAM** tables that can be used as one. “Identical” means that all tables have identical column and index information. You cannot merge **MyISAM** tables in which the columns are listed in a different order, do not have exactly the same columns, or have the indexes in different order. However, any or all of the **MyISAM** tables can be compressed with **myisampack**. See [Section 4.6.5, “myisampack — Generate Compressed, Read-Only MyISAM Tables”](#). Differences in table options such as **AVG\_ROW\_LENGTH**, **MAX\_ROWS**, or **PACK\_KEYS** do not matter.

When you create a **MERGE** table, MySQL creates two files on disk. The files have names that begin with the table name and have an extension to indicate the file type. An **.frm** file stores the table format, and an **.MRG** file contains the names of the tables that should be used as one. The tables do not have to be in the same database as the **MERGE** table itself.

You can use **SELECT**, **DELETE**, **UPDATE**, and **INSERT** on **MERGE** tables. You must have **SELECT**, **UPDATE**, and **DELETE** privileges on the **MyISAM** tables that you map to a **MERGE** table.

### Note

The use of **MERGE** tables entails the following security issue: If a user has access to **MyISAM** table *t*, that user can create a **MERGE** table *m* that accesses *t*. However, if the user's privileges on *t* are subsequently revoked, the user can continue to access *t* by doing so through *m*.

If you **DROP** the **MERGE** table, you are dropping only the **MERGE** specification. The underlying tables are not affected.

To create a **MERGE** table, you must specify a **UNION=(list-of-tables)** clause that indicates which **MyISAM** tables you want to use as one. You can optionally specify an **INSERT\_METHOD** option if you want inserts for the **MERGE** table to take place in the first or last table of the **UNION** list. Use a value of **FIRST** or **LAST** to cause inserts to be made in the first or last table, respectively. If you do not specify an **INSERT\_METHOD** option or if you specify it with a value of **NO**, attempts to insert rows into the **MERGE** table result in an error.

The following example shows how to create a **MERGE** table:

```
mysql> CREATE TABLE t1 (
->   a INT NOT NULL AUTO_INCREMENT PRIMARY KEY,
->   message CHAR(20)) ENGINE=MyISAM;
mysql> CREATE TABLE t2 (
->   a INT NOT NULL AUTO_INCREMENT PRIMARY KEY,
->   message CHAR(20)) ENGINE=MyISAM;
mysql> INSERT INTO t1 (message) VALUES ('Testing'),('table'),('t1');
mysql> INSERT INTO t2 (message) VALUES ('Testing'),('table'),('t2');
mysql> CREATE TABLE total (
->   a INT NOT NULL AUTO_INCREMENT,
->   message CHAR(20), INDEX(a))
->   ENGINE=MERGE UNION=(t1,t2) INSERT_METHOD=LAST;
```

Note that the **a** column is indexed as a **PRIMARY KEY** in the underlying **MyISAM** tables, but not in the **MERGE** table. There it is indexed but not as a **PRIMARY KEY** because a **MERGE** table cannot enforce uniqueness over the set of underlying tables.

In MySQL 5.1.15 and later, when a table that is part of a **MERGE** table is opened, the following checks are applied before opening each table. If any table fails the conformance checks, then the operation that triggered the opening of the table will fail. The conformance checks applied to each table are:

- Table must have exactly the same amount of columns that **MERGE** table has.
- Column order in the **MERGE** table must match the column order in the underlying tables.
- Additionally, the specification for each column in the parent **MERGE** table and the underlying table are compared. For each column, MySQL checks:
  - Column type in the underlying table equals the column type of **MERGE** table.
  - Column length in the underlying table equals the column length of **MERGE** table.
  - Column of underlying table and column of **MERGE** table can be **NULL**.
- Underlying table must have at least the same amount of keys that merge table has. The underlying table may have more keys than the **MERGE** table, but cannot have less.

### Note

A known issue exists that keys on the some columns must be identical in order in both the `MERGE` table and the underlying `MyISAM` table. See [Bug#33653](#).

For each key:

- Check if the key type of underlying table equals the key type of merge table.
- Check if number of key parts (i.e. multiple columns within a compound key) in the underlying table key definition equals the number of key parts in merge table key definition.
- For each key part:
  - Check if key part lengths are equal.
  - Check if key part types are equal.
  - Check if key part languages are equal.
  - Check if key part can be `NULL`.

After creating the `MERGE` table, you can issue queries that operate on the group of tables as a whole:

```
mysql> SELECT * FROM total;
+----+-----+
| a  | message |
+----+-----+
| 1  | Testing |
| 2  | table   |
| 3  | t1      |
| 1  | Testing |
| 2  | table   |
| 3  | t2      |
+----+-----+
```

To remap a `MERGE` table to a different collection of `MyISAM` tables, you can use one of the following methods:

- `DROP` the `MERGE` table and re-create it.
- Use `ALTER TABLE tbl_name UNION=(...)` to change the list of underlying tables. Beginning with MySQL 5.1.24, it is also possible to use `ALTER TABLE ... UNION=()` (that is, with an empty `UNION` clause) to remove all of the underlying tables. ([Bug#28248](#))

`MERGE` tables can help you solve the following problems:

- Easily manage a set of log tables. For example, you can put data from different months into separate tables, compress some of them with `myisampack`, and then create a `MERGE` table to use them as one.
- Obtain more speed. You can split a big read-only table based on some criteria, and then put individual tables on different disks. A `MERGE` table on this could be much faster than using the big table.
- Perform more efficient searches. If you know exactly what you are looking for, you can search in just one of the split tables for some queries and use a `MERGE` table for others. You can even have many different `MERGE` tables that use overlapping sets of tables.
- Perform more efficient repairs. It is easier to repair individual tables that are mapped to a `MERGE` table than to repair a single large table.
- Instantly map many tables as one. A `MERGE` table need not maintain an index of its own because it uses the indexes of the individual tables. As a result, `MERGE` table collections are *very* fast to create or remap. (Note that you must still specify the index definitions when you create a `MERGE` table, even though no indexes are created.)
- If you have a set of tables from which you create a large table on demand, you should instead create a `MERGE` table on them on demand. This is much faster and saves a lot of disk space.
- Exceed the file size limit for the operating system. Each `MyISAM` table is bound by this limit, but a collection of `MyISAM` tables is not.
- You can create an alias or synonym for a `MyISAM` table by defining a `MERGE` table that maps to that single table. There should

be no really notable performance impact from doing this (only a couple of indirect calls and `memcpy()` calls for each read).

The disadvantages of `MERGE` tables are:

- You can use only identical `MyISAM` tables for a `MERGE` table.
- You cannot use a number of `MyISAM` features in `MERGE` tables. For example, you cannot create `FULLTEXT` indexes on `MERGE` tables. (You can, of course, create `FULLTEXT` indexes on the underlying `MyISAM` tables, but you cannot search the `MERGE` table with a full-text search.)
- If the `MERGE` table is non-temporary, all underlying `MyISAM` tables must be non-temporary, too. If the `MERGE` table is temporary, the `MyISAM` tables can be any mix of temporary and non-temporary.
- `MERGE` tables use more file descriptors. If 10 clients are using a `MERGE` table that maps to 10 tables, the server uses  $(10 \times 10) + 10$  file descriptors. (10 data file descriptors for each of the 10 clients, and 10 index file descriptors shared among the clients.)
- Key reads are slower. When you read a key, the `MERGE` storage engine needs to issue a read on all underlying tables to check which one most closely matches the given key. To read the next key, the `MERGE` storage engine needs to search the read buffers to find the next key. Only when one key buffer is used up does the storage engine need to read the next key block. This makes `MERGE` keys much slower on `eq_ref` searches, but not much slower on `ref` searches. See [Section 12.3.2, “EXPLAIN Syntax”](#), for more information about `eq_ref` and `ref`.

#### Additional resources

- A forum dedicated to the `MERGE` storage engine is available at <http://forums.mysql.com/list.php?93>.

### 13.7.1. `MERGE` Table Problems

The following are known problems with `MERGE` tables:

- If you use `ALTER TABLE` to change a `MERGE` table to another storage engine, the mapping to the underlying tables is lost. Instead, the rows from the underlying `MyISAM` tables are copied into the altered table, which then uses the specified storage engine.
- `REPLACE` does not work as expected because the `MERGE` engine cannot enforce uniqueness over the set of underlying tables. The two key facts are:
  - `REPLACE` can detect unique key violations only in the underlying table to which it is going to write (which is determined by `INSERT_METHOD`). This differs from violations in the `MERGE` table itself.
  - If `REPLACE` detects such a violation, it will only change the corresponding row in the first underlying table in which the row is present, whereas a row with the same unique key value may be present in all underlying tables.

Similar considerations apply for `INSERT ... ON DUPLICATE KEY UPDATE`.

- `MERGE` tables do not support partitioning. That is, you cannot partition a `MERGE` table, nor can any of a `MERGE` table's underlying `MyISAM` tables be partitioned.
- You cannot use `REPAIR TABLE`, `OPTIMIZE TABLE`, `DROP TABLE`, `ALTER TABLE`, `DELETE` without a `WHERE` clause, `TRUNCATE TABLE`, or `ANALYZE TABLE` on any of the tables that are mapped into an open `MERGE` table. If you do so, the `MERGE` table may still refer to the original table, which yields unexpected results. The easiest way to work around this deficiency is to ensure that no `MERGE` tables remain open by issuing a `FLUSH TABLES` statement prior to performing any of those operations.

The unexpected results include the possibility that the operation on the `MERGE` table will report table corruption. However, if this occurs after operations on the underlying `MyISAM` tables such as those listed in the previous paragraph (`REPAIR TABLE`, `OPTIMIZE TABLE`, and so forth), the corruption message is spurious. To deal with this, issue a `FLUSH TABLES` statement after modifying the `MyISAM` tables.

- `DROP TABLE` on a table that is in use by a `MERGE` table does not work on Windows because the `MERGE` storage engine's table mapping is hidden from the upper layer of MySQL. Windows does not allow open files to be deleted, so you first must flush all `MERGE` tables (with `FLUSH TABLES`) or drop the `MERGE` table before dropping the table.
- A `MERGE` table cannot maintain uniqueness constraints over the entire table. When you perform an `INSERT`, the data goes into the first or last `MyISAM` table (depending on the value of the `INSERT_METHOD` option). MySQL ensures that unique key val-



ues remain unique within that `MyISAM` table, but not across all the tables in the collection.

- The `INSERT_METHOD` table option for a `MERGE` table indicates which underlying `MyISAM` table to use for inserts into the `MERGE` table. However, use of the `AUTO_INCREMENT` table option for that `MyISAM` table has no effect for inserts into the `MERGE` table until at least one row has been inserted directly into the `MyISAM` table.
- In MySQL 5.1.15 and later, the definition of the `MyISAM` tables and the `MERGE` table are checked when the tables are accessed (for example, as part of a `SELECT` or `INSERT` statement). The checks ensure that the definitions of the tables and the parent `MERGE` table definition match by comparing column order, types, sizes and associated indexes. If there is a difference between the tables then an error will be returned and the statement will fail.

Because these checks take place when the tables are opened, any changes to the definition of a single table, including column changes, column ordering and engine alterations will cause the statement to fail.

In MySQL 5.1.14 and earlier:

- When you create or alter `MERGE` table, there is no check to ensure that the underlying tables are existing `MyISAM` tables and have identical structures. When the `MERGE` table is used, MySQL checks that the row length for all mapped tables is equal, but this is not foolproof. If you create a `MERGE` table from dissimilar `MyISAM` tables, you are very likely to run into strange problems.
- Similarly, if you create a `MERGE` table from non-`MyISAM` tables, or if you drop an underlying table or alter it to be a non-`MyISAM` table, no error for the `MERGE` table occurs until later when you attempt to use it.
- Because the underlying `MyISAM` tables need not exist when the `MERGE` table is created, you can create the tables in any order, as long as you do not use the `MERGE` table until all of its underlying tables are in place. Also, if you can ensure that a `MERGE` table will not be used during a given period, you can perform maintenance operations on the underlying tables, such as backing up or restoring them, altering them, or dropping and recreating them. It is not necessary to redefine the `MERGE` table temporarily to exclude the underlying tables while you are operating on them.
- The order of indexes in the `MERGE` table and its underlying tables should be the same. If you use `ALTER TABLE` to add a `UNIQUE` index to a table used in a `MERGE` table, and then use `ALTER TABLE` to add a non-unique index on the `MERGE` table, the index ordering is different for the tables if there was already a non-unique index in the underlying table. (This happens because `ALTER TABLE` puts `UNIQUE` indexes before non-unique indexes to facilitate rapid detection of duplicate keys.) Consequently, queries on tables with such indexes may return unexpected results.
- If you encounter an error message similar to `ERROR 1017 (HY000): CAN'T FIND FILE: 'MM.MRG' (ERRNO: 2)` it generally indicates that some of the base tables are not using the `MyISAM` storage engine. Confirm that all of these tables are `MyISAM`.
- The maximum number of rows in a `MERGE` table is  $2^{64}$  (~1.844E+19; the same as for a `MyISAM` table), provided that the server was built using the `--with-big-tables` option. (All standard MySQL 5.1 standard binaries are built with this option; for more information, see [Section 2.10.2, “Typical configure Options”](#).) It is not possible to merge multiple `MyISAM` tables into a single `MERGE` table that would have more than this number of rows.
- The `MERGE` storage engine does not support `INSERT DELAYED` statements.
- Using different underlying row formats in `MyISAM` tables with a parent `MERGE` table is currently known to fail. See [Bug#32364](#).
- As of MySQL 5.1.20, if a `MERGE` table cannot be opened or used because of a problem with an underlying table, `CHECK TABLE` displays information about which table caused the problem.
- Starting with MySQL 5.1.23, you cannot change the union list of a non-temporary `MERGE` table when `LOCK TABLES` is in effect. The following does *not* work:

```
CREATE TABLE m1 ... ENGINE=MRG_MYISAM ...;
LOCK TABLES t1 WRITE, t2 WRITE, m1 WRITE;
ALTER TABLE m1 ... UNION=(t1,t2) ...;
```

However, you can do this with a temporary `MERGE` table.

- Starting with MySQL 5.1.23, you cannot create a `MERGE` table with `CREATE ... SELECT`, neither as a temporary `MERGE` table, nor as a non-temporary `MERGE` table. For example:

```
CREATE TABLE m1 ... ENGINE=MRG_MYISAM ... SELECT ...;
```

Gives error message: table is not `BASE TABLE`.

## 13.8. The `MEMORY (HEAP)` Storage Engine

The `MEMORY` storage engine creates tables with contents that are stored in memory. Formerly, these were known as `HEAP` tables. `MEMORY` is the preferred term, although `HEAP` remains supported for backward compatibility.

**Table 13.6. Memory Features**

<b>Storage limits</b>	RAM	<b>Transactions</b>	No	<b>Locking granularity</b>	Table
<b>MVCC</b>	No	<b>Geospatial datatype support</b>	No	<b>Geospatial indexing support</b>	No
<b>B-tree indexes</b>	Yes	<b>Hash indexes</b>	Yes	<b>Full-text search indexes</b>	No
<b>Clustered indexes</b>	No	<b>Data caches</b>	N/A	<b>Index caches</b>	N/A
<b>Compressed data</b>	No	<b>Encrypted data<sup>a</sup></b>	Yes	<b>Cluster database support</b>	No
<b>Replication support<sup>b</sup></b>	Yes	<b>Foreign key support</b>	No	<b>Backup / point-in-time recovery<sup>c</sup></b>	Yes
<b>Query cache support</b>	Yes	<b>Update statistics for data dictionary</b>	Yes		

<sup>a</sup>Implemented in the server (via encryption functions), rather than in the storage engine.

<sup>b</sup>Implemented in the server, rather than in the storage engine

<sup>c</sup>Implemented in the server, rather than in the storage engine

Each `MEMORY` table is associated with one disk file. The file name begins with the table name and has an extension of `.frm` to indicate that it stores the table definition.

To specify explicitly that you want to create a `MEMORY` table, indicate that with an `ENGINE` table option:

```
CREATE TABLE t (i INT) ENGINE = MEMORY;
```

As indicated by the name, `MEMORY` tables are stored in memory. They use hash indexes by default, which makes them very fast, and very useful for creating temporary tables. However, when the server shuts down, all rows stored in `MEMORY` tables are lost. The tables themselves continue to exist because their definitions are stored in `.frm` files on disk, but they are empty when the server restarts.

This example shows how you might create, use, and remove a `MEMORY` table:

```
mysql> CREATE TABLE test ENGINE=MEMORY
-> SELECT ip,SUM(downloads) AS down
-> FROM log_table GROUP BY ip;
mysql> SELECT COUNT(ip),AVG(down) FROM test;
mysql> DROP TABLE test;
```

`MEMORY` tables have the following characteristics:

- Space for `MEMORY` tables is allocated in small blocks. Tables use 100% dynamic hashing for inserts. No overflow area or extra key space is needed. No extra space is needed for free lists. Deleted rows are put in a linked list and are reused when you insert new data into the table. `MEMORY` tables also have none of the problems commonly associated with deletes plus inserts in hashed tables.
- `MEMORY` tables can have up to 32 indexes per table, 16 columns per index and a maximum key length of 500 bytes.
- The `MEMORY` storage engine implements both `HASH` and `BTREE` indexes. You can specify one or the other for a given index by adding a `USING` clause as shown here:

```
CREATE TABLE lookup
(id INT, INDEX USING HASH (id))
ENGINE = MEMORY;
CREATE TABLE lookup
(id INT, INDEX USING BTREE (id))
ENGINE = MEMORY;
```

General characteristics of B-tree and hash indexes are described in [Section 7.4.4, “How MySQL Uses Indexes”](#).

- You can have non-unique keys in a `MEMORY` table. (This is an uncommon feature for implementations of hash indexes.)
- If you have a hash index on a `MEMORY` table that has a high degree of key duplication (many index entries containing the same value), updates to the table that affect key values and all deletes are significantly slower. The degree of this slowdown is proportional to the degree of duplication (or, inversely proportional to the index cardinality). You can use a `BTREE` index to avoid this problem.



- Columns that are indexed can contain `NULL` values.
- `MEMORY` tables use a fixed-length row storage format.
- `MEMORY` tables cannot contain `BLOB` or `TEXT` columns.
- `MEMORY` includes support for `AUTO_INCREMENT` columns.
- You can use `INSERT DELAYED` with `MEMORY` tables. See [Section 12.2.5.2, “INSERT DELAYED Syntax”](#).
- `MEMORY` tables are shared among all clients (just like any other non-`TEMPORARY` table).
- `MEMORY` table contents are stored in memory, which is a property that `MEMORY` tables share with internal tables that the server creates on the fly while processing queries. However, the two types of tables differ in that `MEMORY` tables are not subject to storage conversion, whereas internal tables are:
  - If an internal table becomes too large, the server automatically converts it to an on-disk table. The size limit is determined by the value of the `tmp_table_size` system variable.
  - `MEMORY` tables are never converted to disk tables.
  - The maximum size of `MEMORY` tables is limited by the `max_heap_table_size` system variable, which has a default value of 16MB. To have larger (or smaller) `MEMORY` tables, you must change the value of this variable. The value in effect at the time a `MEMORY` table is created is the value used for the life of the table. (If you use `ALTER TABLE` or `TRUNCATE TABLE`, the value in effect at that time becomes the new maximum size for the table. A server restart also sets the maximum size of existing `MEMORY` tables to the global `max_heap_table_size` value.) You can set the size for individual tables as described later in this section.
- The server needs sufficient memory to maintain all `MEMORY` tables that are in use at the same time.
- Memory used by a `MEMORY` table is not reclaimed if you delete individual rows from the table. Memory is only reclaimed when the entire table is deleted. Memory that was previously used for rows that have been deleted will be re-used for new rows only within the same table. To free up the memory used by rows that have been deleted you should use `ALTER TABLE ENGINE=MEMORY` to force a table rebuild.

To free all the memory used by a `MEMORY` table when you no longer require its contents, you should execute `DELETE` or `TRUNCATE TABLE`, or remove the table altogether using `DROP TABLE`.

- If you want to populate a `MEMORY` table when the MySQL server starts, you can use the `--init-file` option. For example, you can put statements such as `INSERT INTO ... SELECT` or `LOAD DATA INFILE` into this file to load the table from a persistent data source. See [Section 5.1.2, “Server Command Options”](#), and [Section 12.2.6, “LOAD DATA INFILE Syntax”](#).
- If you are using replication, the master server's `MEMORY` tables become empty when it is shut down and restarted. However, a slave is not aware that these tables have become empty, so it returns out-of-date content if you select data from them. When a `MEMORY` table is used on the master for the first time since the master was started, a `DELETE` statement is written to the master's binary log automatically, thus synchronizing the slave to the master again. Note that even with this strategy, the slave still has outdated data in the table during the interval between the master's restart and its first use of the table. However, if you use the `--init-file` option to populate the `MEMORY` table on the master at startup, it ensures that this time interval is zero.
- The memory needed for one row in a `MEMORY` table is calculated using the following expression:

```
SUM_OVER_ALL_BTREE_KEYS(max_length_of_key + sizeof(char*) × 4)
+ SUM_OVER_ALL_HASH_KEYS(sizeof(char*) × 2)
+ ALIGN(length_of_row+1, sizeof(char*))
```

`ALIGN()` represents a round-up factor to cause the row length to be an exact multiple of the `char` pointer size. `sizeof(char*)` is 4 on 32-bit machines and 8 on 64-bit machines.

As mentioned earlier, the `max_heap_table_size` system variable sets the limit on the maximum size of `MEMORY` tables. To control the maximum size for individual tables, set the session value of this variable before creating each table. (Do not change the global `max_heap_table_size` value unless you intend the value to be used for `MEMORY` tables created by all clients.) The following example creates two `MEMORY` tables, with a maximum size of 1MB and 2MB, respectively:

```
mysql> SET max_heap_table_size = 1024*1024;
Query OK, 0 rows affected (0.00 sec)

mysql> CREATE TABLE t1 (id INT, UNIQUE(id)) ENGINE = MEMORY;
Query OK, 0 rows affected (0.01 sec)

mysql> SET max_heap_table_size = 1024*1024*2;
Query OK, 0 rows affected (0.00 sec)

mysql> CREATE TABLE t2 (id INT, UNIQUE(id)) ENGINE = MEMORY;
```

```
Query OK, 0 rows affected (0.00 sec)
```

Both tables will revert to the server's global `max_heap_table_size` value if the server restarts.

You can also specify a `MAX_ROWS` table option in `CREATE TABLE` statements for `MEMORY` tables to provide a hint about the number of rows you plan to store in them. This does not allow the table to grow beyond the `max_heap_table_size` value, which still acts as a constraint on maximum table size. For maximum flexibility in being able to use `MAX_ROWS`, set `max_heap_table_size` at least as high as the value to which you want each `MEMORY` table to be able to grow.

#### Additional resources

- A forum dedicated to the `MEMORY` storage engine is available at <http://forums.mysql.com/list.php?92>.

## 13.9. The `EXAMPLE` Storage Engine

The `EXAMPLE` storage engine is a stub engine that does nothing. Its purpose is to serve as an example in the MySQL source code that illustrates how to begin writing new storage engines. As such, it is primarily of interest to developers.

To enable the `EXAMPLE` storage engine if you build MySQL from source, invoke `configure` with the `--with-example-storage-engine` option.

To examine the source for the `EXAMPLE` engine, look in the `storage/example` directory of a MySQL source distribution.

When you create an `EXAMPLE` table, the server creates a table format file in the database directory. The file begins with the table name and has an `.frm` extension. No other files are created. No data can be stored into the table. Retrievals return an empty result.

```
mysql> CREATE TABLE test (i INT) ENGINE = EXAMPLE;
Query OK, 0 rows affected (0.78 sec)

mysql> INSERT INTO test VALUES(1),(2),(3);
ERROR 1031 (HY000): Table storage engine for 'test' doesn't >
      have this option

mysql> SELECT * FROM test;
Empty set (0.31 sec)
```

The `EXAMPLE` storage engine does not support indexing.

## 13.10. The `FEDERATED` Storage Engine

The `FEDERATED` storage engine enables data to be accessed from a remote MySQL database on a local server without using replication or cluster technology. When using a `FEDERATED` table, queries on the local server are automatically executed on the remote (federated) tables. No data is stored on the local tables.

To include the `FEDERATED` storage engine if you build MySQL from source, invoke `configure` with the `--with-federated-storage-engine` option.

Beginning with MySQL 5.1.26, the `FEDERATED` storage engine is not enabled by default in the running server; to enable `FEDERATED`, you must start the MySQL server binary using the `--federated` option.

To examine the source for the `FEDERATED` engine, look in the `storage/federated` directory of a MySQL source distribution.

### MySQL Enterprise

MySQL Enterprise subscribers will find MySQL Knowledge Base articles about the `FEDERATED` storage engine at [FEDERATED Storage Engine](#). Access to the Knowledge Base collection of articles is one of the advantages of subscribing to MySQL Enterprise. For more information, see <http://www.mysql.com/products/enterprise/advisors.html>.

### 13.10.1. `FEDERATED` Storage Engine Overview

When you create a table using one of the standard storage engines (such as `MyISAM`, `CSV` or `InnoDB`), the table consists of the table definition and the associated data. When you create a `FEDERATED` table, the table definition is the same, but the physical storage of the data is handled on a remote server.

A `FEDERATED` table consists of two elements:

- A *remote server* with a database table, which in turn consists of the table definition (stored in the `.frm` file) and the associated

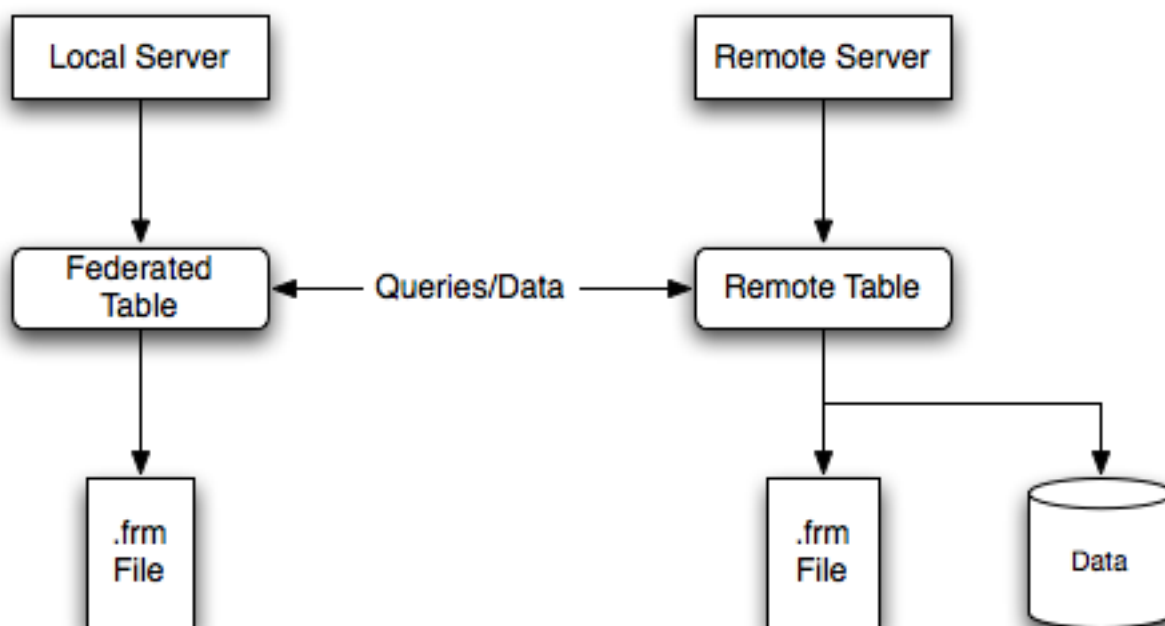
table. The table type of the remote table may be any type supported by the remote `mysqld` server, including `MyISAM` or `InnoDB`.

- A *local server* with a database table, where the table definition matches that of the corresponding table on the remote server. The table definition is stored within the `.frm` file. However, there is no data file on the local server. Instead, the table definition includes a connection string that points to the remote table.

When executing queries and statements on a `FEDERATED` table on the local server, the operations that would normally insert, update or delete information from a local data file are instead sent to the remote server for execution, where they update the data file on the remote server or return matching rows from the remote server.

The basic structure of a `FEDERATED` table setup is shown in Figure 13.2, “`FEDERATED` table structure”.

**Figure 13.2. `FEDERATED` table structure**



When a client issues an SQL statement that refers to a `FEDERATED` table, the flow of information between the local server (where the SQL statement is executed) and the remote server (where the data is physically stored) is as follows:

1. The storage engine looks through each column that the `FEDERATED` table has and constructs an appropriate SQL statement that refers to the remote table.
2. The statement is sent to the remote server using the MySQL client API.
3. The remote server processes the statement and the local server retrieves any result that the statement produces (an affected-rows count or a result set).
4. If the statement produces a result set, each column is converted to internal storage engine format that the `FEDERATED` engine expects and can use to display the result to the client that issued the original statement.

The local server communicates with the remote server using MySQL client C API functions. It invokes `mysql_real_query()` to send the statement. To read a result set, it uses `mysql_store_result()` and fetches rows one at a time using `mysql_fetch_row()`.

## 13.10.2. How to Create `FEDERATED` Tables

To create a `FEDERATED` table you should follow these steps:

1. Create the table on the remote server. Alternatively, make a note of the table definition of an existing table, perhaps using the `SHOW CREATE TABLE` statement.
2. Create the table on the local server with an identical table definition, but adding the connection information that links the local table to the remote table.

For example, you could create the following table on the remote server:

```
CREATE TABLE test_table (
  id      INT(20) NOT NULL AUTO_INCREMENT,
  name    VARCHAR(32) NOT NULL DEFAULT '',
  other   INT(20) NOT NULL DEFAULT '0',
  PRIMARY KEY (id),
  INDEX name (name),
  INDEX other_key (other)
)
ENGINE=MyISAM
DEFAULT CHARSET=latin1;
```

To create the local table that will be federated to the remote table, there are two options available. You can either create the local table and specify the connection string (containing the server name, login, password) to be used to connect to the remote table using the `CONNECTION`, or you can use an existing connection that you have previously created using the `CREATE SERVER` statement.

### Important

When you create the local table it *must* have an identical field definition to the remote table.

### Note

You can improve the performance of a `FEDERATED` table by adding indexes to the table on the host, even though the tables will not actually be created locally. The optimization will occur because the query sent to the remote server will include the contents of the `WHERE` clause will be sent to the remote server and executed locally. This reduces the network traffic that would otherwise request the entire table from the server for local processing.

## 13.10.2.1. Creating a `FEDERATED` Table Using `CONNECTION`

To use the first method, you must specify the `CONNECTION` string after the engine type in a `CREATE TABLE` statement. For example:

```
CREATE TABLE federated_table (
  id      INT(20) NOT NULL AUTO_INCREMENT,
  name    VARCHAR(32) NOT NULL DEFAULT '',
  other   INT(20) NOT NULL DEFAULT '0',
  PRIMARY KEY (id),
  INDEX name (name),
  INDEX other_key (other)
)
ENGINE=FEDERATED
DEFAULT CHARSET=latin1
CONNECTION='mysql://fed_user@remote_host:9306/federated/test_table';
```

### Note

`CONNECTION` replaces the `COMMENT` used in some previous versions of MySQL.

The `CONNECTION` string contains the information required to connect to the remote server containing the table that will be used to physically store the data. The connection string specifies the server name, login credentials, port number and database/table information. In the example, the remote table is on the server `remote_host`, using port 9306. The name and port number should match the host name (or IP address) and port number of the remote MySQL server instance you want to use as your remote table.

The format the connection string is as follows:

```
scheme://user_name[:password]@host_name[:port_num]/db_name/tbl_name
```

Where:

- `scheme` — is a recognized connection protocol. Only `mysql` is supported as the `scheme` value at this point.
- `user_name` — the user name for the connection. This user must have been created on the remote server, and must have suitable privileges to perform the required actions (`SELECT`, `INSERT`, `UPDATE`, and so forth) on the remote table.
- `password` — (optional) the corresponding password for `user_name`.

- *host\_name* — the host name or IP address of the remote server.
- *port\_num* — (optional) the port number for the remote server. The default is 3306.
- *db\_name* — the name of the database holding the remote table.
- *tbl\_name* — the name of the remote table. The name of the local and the remote table do not have to match.

Sample connection strings:

```
CONNECTION='mysql://username:password@hostname:port/database/tablename'
CONNECTION='mysql://username@hostname/database/tablename'
CONNECTION='mysql://username:password@hostname/database/tablename'
```

### 13.10.2.2. Creating a **FEDERATED** Table Using **CREATE SERVER**

If you are creating a number of **FEDERATED** tables on the same server, or if you want to simplify the process of creating **FEDERATED** tables, you can use the **CREATE SERVER** statement to define the server connection parameters, just as you would with the **CONNECTION** string.

The format of the **CREATE SERVER** statement is:

```
CREATE SERVER
  server_name
  FOREIGN DATA WRAPPER wrapper_name
  OPTIONS (option [, option] ...)
```

The *server\_name* is used in the connection string when creating a new **FEDERATED** table.

For example, to create a server connection identical to the **CONNECTION** string:

```
CONNECTION='mysql://fed_user@remote_host:9306/federated/test_table';
```

You would use the following statement:

```
CREATE SERVER fedlink
  FOREIGN DATA WRAPPER mysql
  OPTIONS (USER 'fed_user', HOST 'remote_host', PORT 9306, DATABASE 'federated');
```

To create a **FEDERATED** table that uses this connection, you still use the **CONNECTION** keyword, but specify the name you used in the **CREATE SERVER** statement.

```
CREATE TABLE test_table (
  id      INT(20) NOT NULL AUTO_INCREMENT,
  name    VARCHAR(32) NOT NULL DEFAULT '',
  other   INT(20) NOT NULL DEFAULT '0',
  PRIMARY KEY (id),
  INDEX name (name),
  INDEX other_key (other)
)
ENGINE=FEDERATED
DEFAULT CHARSET=latin1
CONNECTION='fedlink/test_table';
```

The connection name in this example contains the name of the connection (*fedlink*) and the name of the table (*test\_table*) to link to, separated by a slash. If you specify only the connection name without a table name, the table name of the local table is used instead.

For more information on **CREATE SERVER**, see [Section 12.1.16, “CREATE SERVER Syntax”](#).

The **CREATE SERVER** statement accepts the same arguments as the **CONNECTION** string. The **CREATE SERVER** statement updates the rows in the `mysql.servers` table. See the following table for information on the correspondence between parameters in a connection string, options in the **CREATE SERVER** statement, and the columns in the `mysql.servers` table. For reference, the format of the **CONNECTION** string is as follows:

```
scheme://user_name[:password]@host_name[:port_num]/db_name/tbl_name
```

Description	<b>CONNECTION</b> string	<b>CREATE SERVER</b> option	<code>mysql.servers</code> column
Connection scheme	<i>scheme</i>	<i>wrapper_name</i>	Wrapper
Remote user	<i>user_name</i>	USER	Username

Description	CONNECTION string	CREATE SERVER option	mysql.servers column
Remote password	<i>password</i>	PASSWORD	Password
Remote host	<i>host_name</i>	HOST	Host
Remote port	<i>port_num</i>	PORT	Port
Remote database	<i>db_name</i>	DATABASE	Db

### 13.10.3. FEDERATED Storage Engine Notes and Tips

You should be aware of the following points when using the **FEDERATED** storage engine:

- **FEDERATED** tables may be replicated to other slaves, but you must ensure that the slave servers are able to use the user/password combination that is defined in the **CONNECTION** string (or the row in the `mysql.servers` table) to connect to the remote server.

The following items indicate features that the **FEDERATED** storage engine does and does not support:

- The remote server must be a MySQL server. Support by **FEDERATED** for other database engines may be added in the future.
- The remote table that a **FEDERATED** table points to *must* exist before you try to access the table through the **FEDERATED** table.
- It is possible for one **FEDERATED** table to point to another, but you must be careful not to create a loop.
- A **FEDERATED** table does not support indexes per se. Because access to the table is handled remotely, it is the remote table that supports the indexes. Care should be taken when creating a **FEDERATED** table since the index definition from an equivalent **MyISAM** or other table may not be supported. For example, creating a **FEDERATED** table with an index prefix on **VARCHAR**, **TEXT** or **BLOB** columns will fail. The following definition in **MyISAM** is valid:

```
CREATE TABLE `T1`(`A` VARCHAR(100),UNIQUE KEY(`A`(30))) ENGINE=MYISAM;
```

The key prefix in this example is incompatible with the **FEDERATED** engine, and the equivalent statement will fail:

```
CREATE TABLE `T1`(`A` VARCHAR(100),UNIQUE KEY(`A`(30))) ENGINE=FEDERATED
CONNECTION='MYSQL://127.0.0.1:3306/TEST/T1';
```

If possible, you should try to separate the column and index definition when creating tables on both the remote server and the local server to avoid these index issues.

- Internally, the implementation uses **SELECT**, **INSERT**, **UPDATE**, and **DELETE**, but not **HANDLER**.
- The **FEDERATED** storage engine supports **SELECT**, **INSERT**, **UPDATE**, **DELETE**, **TRUNCATE**, and indexes. It does not support **ALTER TABLE**, or any Data Definition Language statements that directly affect the structure of the table, other than **DROP TABLE**. The current implementation does not use prepared statements.
- **FEDERATED** accepts **INSERT ... ON DUPLICATE KEY UPDATE** statements, but if a duplicate-key violation occurs, the statement fails with an error.
- Performance on a **FEDERATED** table when performing bulk inserts (for example, on a **INSERT INTO ... SELECT ...** statement) is slower than with other table types because each selected row is treated as an individual **INSERT** statement on the **FEDERATED** table.
- Transactions are not supported.
- Before MySQL 5.1.21, for a multiple-row insert into a **FEDERATED** table that refers to a remote transactional table, if the insert failed for a row due to constraint failure, the remote table would contain a partial commit (the rows preceding the failed one) instead of rolling back the statement completely. This occurred because the rows were treated as individual inserts.

As of MySQL 5.1.21, **FEDERATED** performs bulk-insert handling such that multiple rows are sent to the remote table in a batch. This provides a performance improvement and enables the remote table to perform improvement. Also, if the remote table is transactional, it enables the remote storage engine to perform statement rollback properly should an error occur. This capability has the following limitations:

- The size of the insert cannot exceed the maximum packet size between servers. If the insert exceeds this size, it is broken into multiple packets and the rollback problem can occur.

- Bulk-insert handling does not occur for `INSERT ... ON DUPLICATE KEY UPDATE`.
- There is no way for the `FEDERATED` engine to know if the remote table has changed. The reason for this is that this table must work like a data file that would never be written to by anything other than the database system. The integrity of the data in the local table could be breached if there was any change to the remote database.
- When using a `CONNECTION` string, you cannot use an '@' character in the password. You can get round this limitation by using the `CREATE SERVER` statement to create a server connection.
- The `insert_id` and `timestamp` options are not propagated to the data provider.
- Any `DROP TABLE` statement issued against a `FEDERATED` table drops only the local table, not the remote table.
- `FEDERATED` tables do not work with the query cache.
- User-defined partitioning is not supported for `FEDERATED` tables. Beginning with MySQL 5.1.15, it is no longer possible to create such tables at all.

Some of these limitations may be lifted in future versions of the `FEDERATED` handler.

### 13.10.4. `FEDERATED` Storage Engine Resources

The following additional resources are available for the `FEDERATED` storage engine:

- A forum dedicated to the `FEDERATED` storage engine is available at <http://forums.mysql.com/list.php?105>.

## 13.11. The `ARCHIVE` Storage Engine

The `ARCHIVE` storage engine is used for storing large amounts of data without indexes in a very small footprint.

**Table 13.7. Archive Features**

<b>Storage limits</b>	None	<b>Transactions</b>	No	<b>Locking granularity</b>	Row
<b>MVCC</b>	No	<b>Geospatial datatype support</b>	Yes	<b>Geospatial indexing support</b>	No
<b>B-tree indexes</b>	No	<b>Hash indexes</b>	No	<b>Full-text search indexes</b>	No
<b>Clustered indexes</b>	No	<b>Data caches</b>	No	<b>Index caches</b>	No
<b>Compressed data</b>	Yes	<b>Encrypted data<sup>a</sup></b>	Yes	<b>Cluster database support</b>	No
<b>Replication support<sup>b</sup></b>	Yes	<b>Foreign key support</b>	No	<b>Backup / point-in-time recovery<sup>c</sup></b>	Yes
<b>Query cache support</b>	Yes	<b>Update statistics for data dictionary</b>	Yes		

<sup>a</sup>Implemented in the server (via encryption functions), rather than in the storage engine.

<sup>b</sup>Implemented in the server, rather than in the storage engine

<sup>c</sup>Implemented in the server, rather than in the storage engine

The `ARCHIVE` storage engine is included in MySQL binary distributions. To enable this storage engine if you build MySQL from source, invoke `configure` with the `--with-archive-storage-engine` option.

To examine the source for the `ARCHIVE` engine, look in the `storage/archive` directory of a MySQL source distribution.

You can check whether the `ARCHIVE` storage engine is available with the `SHOW ENGINES` statement.

When you create an `ARCHIVE` table, the server creates a table format file in the database directory. The file begins with the table name and has an `.frm` extension. The storage engine creates other files, all having names beginning with the table name. The data file has an extension of `.ARZ`. (Prior to MySQL 5.1.15, a metadata file with an extension of `.ARM` is created as well.) An `.ARN` file may appear during optimization operations.

The `ARCHIVE` engine supports `INSERT` and `SELECT`, but not `DELETE`, `REPLACE`, or `UPDATE`. It does support `ORDER BY` operations, `BLOB` columns, and basically all but spatial data types (see Section 11.13.4.1, “MySQL Spatial Data Types”). The `ARCHIVE` engine uses row-level locking.



As of MySQL 5.1.6, the `ARCHIVE` engine supports the `AUTO_INCREMENT` column attribute. The `AUTO_INCREMENT` column can have either a unique or non-unique index. Attempting to create an index on any other column results in an error. The `ARCHIVE` engine also supports the `AUTO_INCREMENT` table option in `CREATE TABLE` and `ALTER TABLE` statements to specify the initial sequence value for a new table or reset the sequence value for an existing table, respectively.

As of MySQL 5.1.6, the `ARCHIVE` engine ignores `BLOB` columns if they are not requested and scans past them while reading. Formerly, the following two statements had the same cost, but as of 5.1.6, the second is much more efficient than the first:

```
SELECT a, b, blob_col FROM archive_table;
SELECT a, b FROM archive_table;
```

**Storage:** Rows are compressed as they are inserted. The `ARCHIVE` engine uses `zlib` lossless data compression (see <http://www.zlib.net/>). You can use `OPTIMIZE TABLE` to analyze the table and pack it into a smaller format (for a reason to use `OPTIMIZE TABLE`, see later in this section). The engine also supports `CHECK TABLE`. There are several types of insertions that are used:

- An `INSERT` statement just pushes rows into a compression buffer, and that buffer flushes as necessary. The insertion into the buffer is protected by a lock. A `SELECT` forces a flush to occur, unless the only insertions that have come in were `INSERT DELAYED` (those flush as necessary). See [Section 12.2.5.2, “INSERT DELAYED Syntax”](#).
- A bulk insert is visible only after it completes, unless other inserts occur at the same time, in which case it can be seen partially. A `SELECT` never causes a flush of a bulk insert unless a normal insert occurs while it is loading.

**Retrieval:** On retrieval, rows are uncompressed on demand; there is no row cache. A `SELECT` operation performs a complete table scan: When a `SELECT` occurs, it finds out how many rows are currently available and reads that number of rows. `SELECT` is performed as a consistent read. Note that lots of `SELECT` statements during insertion can deteriorate the compression, unless only bulk or delayed inserts are used. To achieve better compression, you can use `OPTIMIZE TABLE` or `REPAIR TABLE`. The number of rows in `ARCHIVE` tables reported by `SHOW TABLE STATUS` is always accurate. See [Section 12.5.2.5, “OPTIMIZE TABLE Syntax”](#), [Section 12.5.2.6, “REPAIR TABLE Syntax”](#), and [Section 12.5.5.38, “SHOW TABLE STATUS Syntax”](#).

#### Additional resources

- A forum dedicated to the `ARCHIVE` storage engine is available at <http://forums.mysql.com/list.php?112>.

## 13.12. The CSV Storage Engine

The `CSV` storage engine stores data in text files using comma-separated values format.

To enable the `CSV` storage engine if you build MySQL from source, invoke `configure` with the `-with-csv-storage-engine` option.

To examine the source for the `CSV` engine, look in the `storage/csv` directory of a MySQL source distribution.

When you create a `CSV` table, the server creates a table format file in the database directory. The file begins with the table name and has an `.frm` extension. The storage engine also creates a data file. Its name begins with the table name and has a `.CSV` extension. The data file is a plain text file. When you store data into the table, the storage engine saves it into the data file in comma-separated values format.

```
mysql> CREATE TABLE test (i INT NOT NULL, c CHAR(10) NOT NULL)
-> ENGINE = CSV;
Query OK, 0 rows affected (0.12 sec)

mysql> INSERT INTO test VALUES(1,'record one'),(2,'record two');
Query OK, 2 rows affected (0.00 sec)
Records: 2 Duplicates: 0 Warnings: 0

mysql> SELECT * FROM test;
+----+-----+
| i  | c      |
+----+-----+
| 1  | record one |
| 2  | record two |
+----+-----+
2 rows in set (0.00 sec)
```

Starting with MySQL 5.1.9, creating a `CSV` table also creates a corresponding Metafile that stores the state of the table and the number of rows that exist in the table. The name of this file is the same as the name of the table with the extension `CSM`.

If you examine the `test.CSV` file in the database directory created by executing the preceding statements, its contents should look like this:



```
"1","record one"
"2","record two"
```

This format can be read, and even written, by spreadsheet applications such as Microsoft Excel or StarOffice Calc.

## 13.12.1. Repairing and Checking CSV Tables

### Functionality introduced in version 5.1.9

The CSV storage engines supports the `CHECK` and `REPAIR` commands to verify and if possible repair a damaged CSV table.

When running the `CHECK` command, the CSV file will be checked for validity by looking for the correct field separators, escaped fields (matching quotes and/or missing quotes), the correct number of fields compared to the table definition and the existence of a corresponding CSV metafile. The first invalid row discovered will report an error. Checking a valid table produces output like that shown below:

```
mysql> check table csvtest;
+-----+-----+-----+-----+
| Table      | Op    | Msg_type | Msg_text |
+-----+-----+-----+-----+
| test.csvtest | check | status   | OK       |
+-----+-----+-----+-----+
1 row in set (0.00 sec)
```

A check on a corrupted table returns a fault:

```
mysql> check table csvtest;
+-----+-----+-----+-----+
| Table      | Op    | Msg_type | Msg_text |
+-----+-----+-----+-----+
| test.csvtest | check | error    | Corrupt  |
+-----+-----+-----+-----+
1 row in set (0.01 sec)
```

If the check fails, the table is marked as crashed (corrupt). Once a table has been marked as corrupt, it is automatically repaired when you next run `CHECK` or execute a `SELECT` statement. The corresponding corrupt status and new status will be displayed when running `CHECK`:

```
mysql> check table csvtest;
+-----+-----+-----+-----+
| Table      | Op    | Msg_type | Msg_text |
+-----+-----+-----+-----+
| test.csvtest | check | warning  | Table is marked as crashed |
| test.csvtest | check | status   | OK       |
+-----+-----+-----+-----+
2 rows in set (0.08 sec)
```

To repair a table you can use `REPAIR`, this copies as many valid rows from the existing CSV data as possible, and then replaces the existing CSV file with the recovered rows. Any rows beyond the corrupted data are lost.

```
mysql> repair table csvtest;
+-----+-----+-----+-----+
| Table      | Op    | Msg_type | Msg_text |
+-----+-----+-----+-----+
| test.csvtest | repair | status   | OK       |
+-----+-----+-----+-----+
1 row in set (0.02 sec)
```

### Warning

Note that during repair, only the rows from the CSV file up to the first damaged row are copied to the new table. All other rows from the first damaged row to the end of the table are removed, even valid rows.

## 13.12.2. CSV Limitations

### Important

The `CSV` storage engine does not support indexing.

Partitioning is not supported for tables using the `CSV` storage engine. Beginning with MySQL 5.1.12, it is no longer possible to create partitioned `CSV` tables. (See [Bug#19307](#))

Beginning with MySQL 5.1.23, tables using the `CSV` storage engine can no longer be created with `NULL` columns. However, for backward compatibility, you can continue to use such tables that were created in previous MySQL releases. ([Bug#32050](#))

## 13.13. The **BLACKHOLE** Storage Engine

The **BLACKHOLE** storage engine acts as a “black hole” that accepts data but throws it away and does not store it. Retrievals always return an empty result:

```
mysql> CREATE TABLE test(i INT, c CHAR(10)) ENGINE = BLACKHOLE;
Query OK, 0 rows affected (0.03 sec)

mysql> INSERT INTO test VALUES(1,'record one'),(2,'record two');
Query OK, 2 rows affected (0.00 sec)
Records: 2 Duplicates: 0 Warnings: 0

mysql> SELECT * FROM test;
Empty set (0.00 sec)
```

To enable the **BLACKHOLE** storage engine if you build MySQL from source, invoke `configure` with the `--with-blackhole-storage-engine` option.

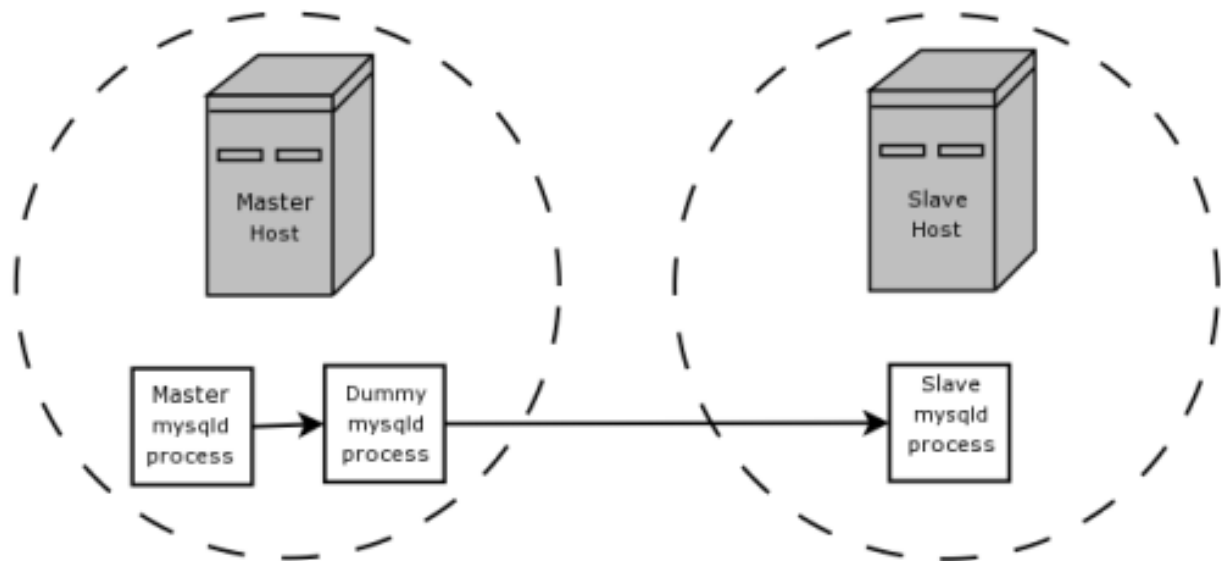
To examine the source for the **BLACKHOLE** engine, look in the `sql` directory of a MySQL source distribution.

When you create a **BLACKHOLE** table, the server creates a table format file in the database directory. The file begins with the table name and has an `.frm` extension. There are no other files associated with the table.

The **BLACKHOLE** storage engine supports all kinds of indexes. That is, you can include index declarations in the table definition.

You can check whether the **BLACKHOLE** storage engine is available with the `SHOW ENGINES` statement.

Inserts into a **BLACKHOLE** table do not store any data, but if the binary log is enabled, the SQL statements are logged (and replicated to slave servers). This can be useful as a repeater or filter mechanism. For example, suppose that your application requires slave-side filtering rules, but transferring all binary log data to the slave first results in too much traffic. In such a case, it is possible to set up on the master host a “dummy” slave process whose default storage engine is **BLACKHOLE**, depicted as follows:



The master writes to its binary log. The “dummy” `mysqld` process acts as a slave, applying the desired combination of `replicate-do-*` and `replicate-ignore-*` rules, and writes a new, filtered binary log of its own. (See Section 16.1.3, “Replication and Binary Logging Options and Variables”.) This filtered log is provided to the slave.

The dummy process does not actually store any data, so there is little processing overhead incurred by running the additional `mysqld` process on the replication master host. This type of setup can be repeated with additional replication slaves.

`INSERT` triggers for **BLACKHOLE** tables work as expected. However, because the **BLACKHOLE** table does not actually store any data, `UPDATE` and `DELETE` triggers are not activated: The `FOR EACH ROW` clause in the trigger definition does not apply because there are no rows.

Other possible uses for the **BLACKHOLE** storage engine include:

- Verification of dump file syntax.
- Measurement of the overhead from binary logging, by comparing performance using **BLACKHOLE** with and without binary

logging enabled.

- `BLACKHOLE` is essentially a “no-op” storage engine, so it could be used for finding performance bottlenecks not related to the storage engine itself.

The `BLACKHOLE` storage engine does not support `INSERT DELAYED`, `LOCK TABLES`, or `UNLOCK TABLES` statements prior to MySQL 5.1.19.

As of MySQL 5.1.4, the `BLACKHOLE` engine is transaction-aware, in the sense that committed transactions are written to the binary log and rolled-back transactions are not.

---

# Chapter 14. High Availability and Scalability

When using MySQL you may need to ensure the availability or scalability of your MySQL installation. Availability refers to the ability to cope with, and if necessary recover from, failures on the host, including failures of MySQL, the operating system, or the hardware. Scalability refers to the ability to spread the load of your application queries across multiple MySQL servers. As your application and usage increases, you may need to spread the queries for the application across multiple servers to improve response times.

There are a number of solutions available for solving issues of availability and scalability. The two primary solutions supported by MySQL are MySQL Replication and MySQL Cluster. Further options are available using third-party solutions such as DRBD (Distributed Replicated Block Device) and Heartbeat, and more complex scenarios can be solved through a combination of these technologies. These tools work in different ways:

- *MySQL Replication* enables statements and data from one MySQL server instance to be replicated to another MySQL server instance. Without using more complex setups, data can only be replicated from a single master server to any number of slaves. The replication is asynchronous, so the synchronization does not take place in real time, and there is no guarantee that data from the master will have been replicated to the slaves.
  - **Advantages**
    - MySQL Replication is available on all platforms supported by MySQL, and since it isn't operating system-specific it can operate across different platforms.
    - Replication is asynchronous and can be stopped and restarted at any time, making it suitable for replicating over slower links, partial links and even across geographical boundaries.
    - Data can be replicated from one master to any number of slaves, making replication suitable in environments with heavy reads, but light writes (for example, many web applications), by spreading the load across multiple slaves.
  - **Disadvantages**
    - Data can only be written to the master. In advanced configurations, though, you can set up a multiple-master configuration where the data is replicated around a ring configuration.
    - There is no guarantee that data on master and slaves will be consistent at a given point in time. Because replication is asynchronous there may be a small delay between data being written to the master and it being available on the slaves. This can cause problems in applications where a write to the master must be available for a read on the slaves (for example a web application).
  - **Recommended uses**
    - Scale-out solutions that require a large number of reads but fewer writes (for example, web serving).
    - Logging/data analysis of live data. By replicating live data to a slave you can perform queries on the slave without affecting the operation of the master.
    - Online backup (availability), where you need an active copy of the data available. You need to combine this with other tools, such as custom scripts or Heartbeat. However, because of the asynchronous architecture, the data may be incomplete.
    - Offline backup. You can use replication to keep a copy of the data. By replicating the data to a slave, you take the slave down and get a reliable snapshot of the data (without MySQL running), then restart MySQL and replication to catch up. The master (and any other slaves) can be kept running during this period.

For information on setting up and configuring replication, see [Chapter 16, Replication](#).

- *MySQL Cluster* is a synchronous solution that enables multiple MySQL instances to share database information. Unlike replication, data in a cluster can be read from or written to any node within the cluster, and information will be distributed to the other nodes.
  - **Advantages**
    - Offers multiple read and write nodes for data storage.
    - Provides automatic failover between nodes. Only transaction information for the active node being used is lost in the event of a failure.
    - Data on nodes is instantaneously distributed to the other data nodes.

- **Disadvantages**

- Available on a limited range of platforms.
- Nodes within a cluster should be connected via a LAN; geographically separate nodes are not supported. However, you can replicate from one cluster to another using MySQL Replication, although the replication in this case is still asynchronous.

- **Recommended uses**

- Applications that need very high availability, such as telecoms and banking.
- Applications that require an equal or higher number of writes compared to reads.

For information on MySQL Cluster, see [MySQL Cluster NDB 6.X/7.X](#).

- *DRBD (Distributed Replicated Block Device)* is a solution from Linbit supported only on Linux. DRBD creates a virtual block device (which is associated with an underlying physical block device) that can be replicated from the primary server to a secondary server. You create a file system on the virtual block device, and this information is then replicated, at the block level, to the secondary server.

Because the block device, not the data you are storing on it, is being replicated the validity of the information is more reliable than with data-only replication solutions. DRBD can also ensure data integrity by only returning from a write operation on the primary server when the data has been written to the underlying physical block device on both the primary and secondary servers.

- **Advantages**

- Provides high availability and data integrity across two servers in the event of hardware or system failure.
- Can ensure data integrity by enforcing write consistency on the primary and secondary nodes.

- **Disadvantages**

- Only provides a method for duplicating data across the nodes. Secondary nodes cannot use the DRBD device while data is being replicated, and so the MySQL on the secondary node cannot be simultaneously active.
- Can not be used to scale performance, since you can not redirect reads to the secondary node.

- **Recommended uses**

- High availability situations where concurrent access to the data is not required, but instant access to the active data in the event of a system or hardware failure is required.

For information on configuring DRBD and configuring MySQL for use with a DRBD device, see [Section 14.1, “Using MySQL with DRBD”](#).

- *memcached* is a simple, yet highly-scalable key-based cache that stores data and objects wherever dedicated or spare RAM is available for very quick access by applications. You use *memcached* in combination with your application and MySQL to reduce the number of reads from the database.

When writing your application, you first try to load the data from the *memcached* cache, if the data you are looking for cannot be found, you then load the data from the MySQL database as normal, and populate the cache with the information that you loaded. Because *memcached* can be used to store entire objects that might normally consist of multiple table lookups and aggregations, you can significantly increase the speed of your application because the requirement to load data directly from the database is reduced or even eliminated. Because the cache is entirely in RAM, the response time is very fast, and the information can be distributed among many servers to make the best use of any spare RAM capacity.

- **Advantages**

- Very fast, RAM based, cache.
- Reduces load on the MySQL server, allowing MySQL to concentrate on persistent storage and data writes.
- Highly distributable and scalable, allowing multiple servers to be part of the cache group.
- Highly portable - the *memcached* interface is supported by many languages and systems, including Perl, Python, PHP, Ruby, Java and the MySQL server.

- **Disadvantages**

- Data is not persistent - you should only use the cache to store information that can otherwise be loaded from a MySQL database.
- Fault tolerance is implied, rather than explicit. If a [memcached](#) node fails then your application must be capable of loading the data from MySQL and updating the cache.
- **Recommended uses**
  - High scalability situations where you have a very high number of reads, particularly of complex data objects that can easily be cached in the final, usable, form directly within the cache.

For information on installing, configuring and using [memcached](#), including using the many APIs available for communicating with [memcached](#), see [Section 14.5, “Using MySQL with memcached”](#).

- *Heartbeat* is a software solution for Linux. It is not a data replication or synchronization solution, but a solution for monitoring servers and switching active MySQL servers automatically in the event of failure. Heartbeat needs to be combined with MySQL Replication or DRBD to provide automatic failover.

For more information on configuring Heartbeat for use with MySQL and DRBD, see [Section 14.2, “Using Linux HA Heartbeat”](#).

The information and suitability of the various technologies and different scenarios is summarized in the following table.

Requirements	MySQL Replication	MySQL Replication + Heartbeat	MySQL Heartbeat + DRBD	MySQL Cluster	MySQL + memcached
<b>Availability</b>					
Automated IP failover	No	Yes	Yes	No	No
Automated database failover	No	No	Yes	Yes	No
Typical failover time	User/script-dependent	Varies	< 30 seconds	< 3 seconds	App dependent
Automatic resynchronization of data	No	No	Yes	Yes	No
Geographic redundancy support	Yes	Yes	Yes, when combined with MySQL Replication	Yes, when combined with MySQL Replication	No
<b>Scalability</b>					
Built-in load balancing	No	No	No	Yes	Yes
Supports Read-intensive applications	Yes	Yes	Yes, when combined with MySQL Replication	Yes	Yes
Supports Write-intensive applications	No	No	Yes	Yes	No
Maximum number of nodes per group	One master, multiple slaves	One master, multiple slaves	One active (primary), one passive (secondary) node	255	Unlimited
Maximum number of slaves	Unlimited (reads only)	Unlimited (reads only)	One (failover only)	Unlimited (reads only)	Unlimited

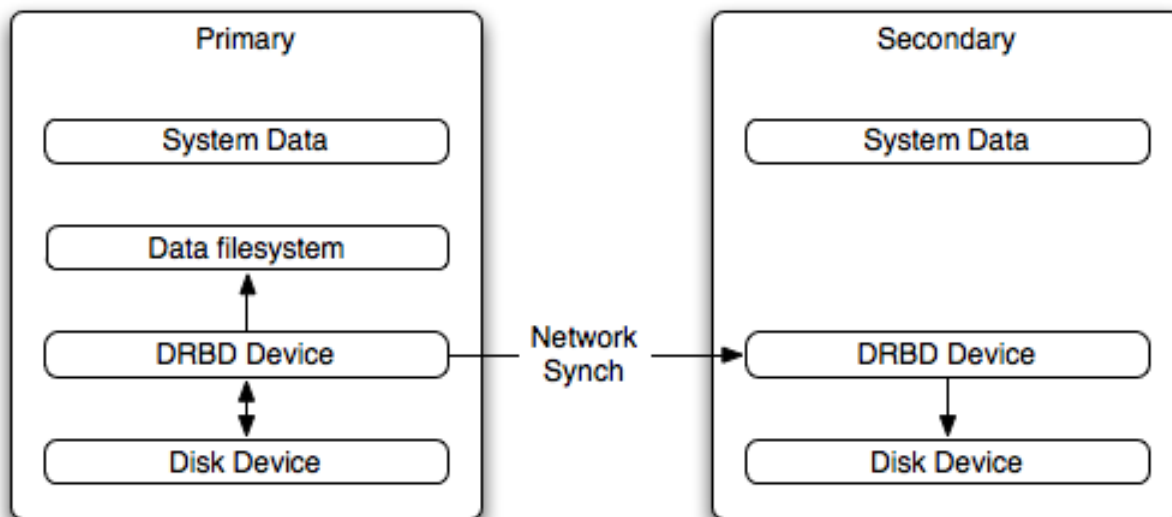
## 14.1. Using MySQL with DRBD

The Distributed Replicated Block Device (DRBD) is a Linux Kernel module that constitutes a distributed storage system. You can use DRBD to share block devices between Linux servers and, in turn, share file systems and data.

DRBD implements a block device which can be used for storage and which is replicated from a primary server to one or more secondary servers. The distributed block device is handled by the DRBD service. Writes to the DRBD block device are distributed among the servers. Each DRBD service writes the information from the DRBD block device to a local physical block device (hard disk).

On the primary data writes are written both to the underlying physical block device and distributed to the secondary DRBD services. On the secondary, the writes received through DRBD and written to the local physical block device. On both the primary and the secondary, reads from the DRBD block device are handled by the underlying physical block device. The information is shared between the primary DRBD server and the secondary DRBD server synchronously and at a block level, and this means that DRBD can be used in high-availability solutions where you need failover support.

**Figure 14.1. DRBD Architecture Overview**



When used with MySQL, DRBD can be used to ensure availability in the event of a failure. MySQL is configured to store information on the DRBD block device, with one server acting as the primary and a second machine available to operate as an immediate replacement in the event of a failure.

For automatic failover support you can combine DRBD with the Linux Heartbeat project, which will manage the interfaces on the two servers and automatically configure the secondary (passive) server to replace the primary (active) server in the event of a failure. You can also combine DRBD with MySQL Replication to provide both failover and scalability within your MySQL environment.

For information on how to configure DRBD and MySQL, including Heartbeat support, see [Section 14.1.1, “Configuring the DRBD Environment”](#).

An FAQ for using DRBD and MySQL is available. See [Section A.14, “MySQL 5.1 FAQ — MySQL, DRBD, and Heartbeat”](#).

### Note

Because DRBD is a Linux Kernel module it is currently not supported on platforms other than Linux.

## 14.1.1. Configuring the DRBD Environment

To set up DRBD, MySQL and Heartbeat you need to follow a number of steps that affect the operating system, DRBD and your MySQL installation.

Before starting the installation process, you should be aware of the following information, terms and requirements on using DRBD:

- DRBD is a solution for enabling high-availability, and therefore you need to ensure that the two machines within your DRBD setup are as identically configured as possible so that the secondary machine can act as a direct replacement for the primary machine in the event of system failure.
- DRBD works through two (or more) servers, each called a *node*
- The node that contains the primary data, has read/write access to the data, and in an HA environment is the currently active node is called the *primary*.
- The server to which the data is replicated is referred as *secondary*.

- A collection of nodes that are sharing information are referred to as a *DRBD cluster*.
- For DRBD to operate you must have a block device on which the information can be stored on *each* DRBD node. The *lower level* block device can be a physical disk partition, a partition from a volume group or RAID device or any other block device.

Typically you use a spare partition on which the physical data will be stored. On the primary node, this disk will hold the raw data that you want replicated. On the secondary nodes, the disk will hold the data replicated to the secondary server by the DRBD service. Ideally, the size of the partition on the two DRBD servers should be identical, but this is not necessary as long as there is enough space to hold the data that you want distributed between the two servers.

- For the distribution of data to work, DRBD is used to create a logical block device that uses the lower level block device for the actual storage of information. To store information on the distributed device, a file system is created on the DRBD logical block device.
- When used with MySQL, once the file system has been created, you move the MySQL data directory (including InnoDB data files and binary logs) to the new file system.
- When you set up the secondary DRBD server, you set up the physical block device and the DRBD logical block device that will store the data. The block device data is then copied from the primary to the secondary server.

The overview for the installation and configuration sequence is as follows:

1. First you need to set up your operating system and environment. This includes setting the correct host name, updating the system and preparing the available packages and software required by DRBD, and configuring a physical block device to be used with the DRBD block device. See [Section 14.1.1.1, “Setting Up Your Operating System for DRBD”](#).
2. Installing DRBD requires installing or compiling the DRBD source code and then configuring the DRBD service to set up the block devices that will be shared. See [Section 14.1.1.2, “Installing and Configuring DRBD”](#).
3. Once DRBD has been configured, you must alter the configuration and storage location of the MySQL data. See [Section 14.1.2, “Configuring MySQL for DRBD”](#).

You may optionally want to configure high availability using the Linux Heartbeat service. See [Section 14.2, “Using Linux HA Heartbeat”](#), for more information.

### 14.1.1.1. Setting Up Your Operating System for DRBD

To set your Linux environment for using DRBD there are a number of system configuration steps that you must follow.

- Make sure that the primary and secondary DRBD servers have the correct host name, and that the host names are unique. You can verify this by using the `uname` command:

```
shell> uname -n
drbd-one
```

If the host name is not set correctly, edit the appropriate file (usually `/etc/sysconfig/network`, `/etc/hostname`, or `/etc/conf.d/hostname`) and set the name correctly.

- Each DRBD node must have a unique IP address. Make sure that the IP address information is set correctly within the network configuration and that the host name and IP address has been set correctly within the `/etc/hosts` file.
- Although you can rely on the DNS or NIS system for host resolving, in the event of a major network failure these services may not be available. If possible, add the IP address and host name of each DRBD node into the `/etc/hosts` file for each machine. This will ensure that the node information can always be determined even if the DNS/NIS servers are unavailable.
- As a general rule, the faster your network connection the better. Because the block device data is exchanged over the network, everything that will be written to the local disk on the DRBD primary will also be written to the network for distribution to the DRBD secondary.

For tips on configuring a faster network connection see [Section 14.1.3, “Optimizing Performance and Reliability”](#).

- You must have a spare disk or disk partition that you can use as the physical storage location for the DRBD data that will be replicated. You do not have to have a complete disk available, a partition on an existing disk is acceptable.

If the disk is unpartitioned, partition the disk using `fdisk`, `cfdisk` or other partitioning solution. Do not create a file system on the new partition.



Remember that you must have a physical disk available for the storage of the replicated information on each DRBD node. Ideally the partitions that will be used on each node should be of an identical size, although this is not strictly necessary. Do, however, ensure that the physical partition on the DRBD secondary is at least as big as the partitions on the DRBD primary node.

- If possible, upgrade your system to the latest available Linux kernel for your distribution. Once the kernel has been installed, you must reboot to make the kernel active. To use DRBD you will also need to install the relevant kernel development and header files that are required for building kernel modules. Platform specification information for this is available later in this section.

Before you compile or install DRBD, you must make sure the following tools and files are in place:

- Kernel header files
- Kernel source files
- GCC Compiler
- `glib 2`
- `flex`

Here are some operating system specific tips for setting up your installation:

- **Tips for Red Hat (including CentOS and Fedora):**

Use `up2date` or `yum` to update and install the latest kernel and kernel header files:

```
root-shell> up2date kernel-smp-devel kernel-smp
```

Reboot. If you are going to build DRBD from source, then update your system with the required development packages:

```
root-shell> up2date glib-devel openssl-devel libgcrypt-devel glib2-devel \
pkgconfig ncurses-devel rpm-build rpm-devel redhat-rpm-config gcc \
gcc-c++ bison flex gnutls-devel lm_sensors-devel net-snmp-devel \
python-devel bzip2-devel libselinux-devel perl-DBI
```

If you are going to use the pre-built DRBD RPMs:

```
root-shell> up2date gnutls lm_sensors net-snmp ncurses libgcrypt glib2 openssl glib
```

- **Tips for Debian, Ubuntu, Kubuntu:**

Use `apt-get` to install the kernel packages

```
root-shell> apt-get install linux-headers linux-image-server
```

If you are going to use the pre-built Debian packages for DRBD then you should not need any additional packages.

If you want to build DRBD from source, you will need to use the following command to install the required components:

```
root-shell> apt-get install devscripts flex bison build-essential \
dpkg-dev kernel-package debconf-utils dpatch debhelper \
libnet1-dev e2fslibs-dev libglib2.0-dev automake1.9 \
libgnutls-dev libtool libltdl3 libltdl3-dev
```

- **Tips for Gentoo:**

Gentoo is a source based Linux distribution and therefore many of the source files and components that you will need are either already installed or will be installed automatically by `emerge`.

To install DRBD 0.8.x, you must unmask the `sys-cluster/drbd` build by adding the following line to `/etc/portage/package.keywords`:

```
sys-cluster/drbd ~x86
sys-cluster/drbd-kernel ~x86
```

If your kernel does not already have the userspace to kernelspace linker enabled, then you will need to rebuild the kernel with this option. The best way to do this is to use `genkernel` with the `--menuconfig` option to select the option and then rebuild the kernel. For example, at the command line as `root`:

```
root-shell> genkernel --menuconfig all
```

Then through the menu options, select **DEVICE DRIVERS, CONNECTOR - UNIFIED USERSPACE <-> KERNELSPACE LINKER** and finally press 'y' or 'space' to select the **CONNECTOR - UNIFIED USERSPACE <-> KERNELSPACE LINKER** option. Then exit the menu configuration. The kernel will be rebuilt and installed. If this is a new kernel, make sure you update your bootloader accordingly. Now reboot to enable the new kernel.

### 14.1.1.2. Installing and Configuring DRBD

To install DRBD you can choose either the pre-built binary installation packages or you can use the source packages and build from source. If you want to build from source you must have installed the source and development packages.

If you are installing using a binary distribution then you must ensure that the kernel version number of the binary package matches your currently active kernel. You can use `uname` to find out this information:

```
shell> uname -r
2.6.20-gentoo-r6
```

Once DRBD has been built and installed, you need to edit the `/etc/drbd.conf` file and then run a number of commands to build the block device and set up the replication.

Although the steps below are split into those for the primary node and the secondary node, it should be noted that the configuration files for all nodes should be identical, and many of the same steps have to be repeated on each node to enable the DRBD block device.

Building from source:

To download and install from the source code:

1. Download the source code.
2. Unpack the package:

```
shell> tar xzf drbd-8.3.0.tar.gz
```

3. Change to the extracted directory, and then run `make` to build the DRBD driver:

```
shell> cd drbd-8.3.0
shell> make
```

4. Install the kernel driver and commands:

```
shell> make install
```

Binary Installation:

- **SUSE Linux Enterprise Server (SLES)**

For SUSE, use `yast`:

```
shell> yast -i drbd
```

Alternatively:

```
shell> rug install drbd
```

- **Debian**

Use `apt-get` to install the modules. You do not need to install any other components.

```
shell> apt-get install drbd8-utils drbd8-module
```

- **Debian 3.1 and 4.0**

You must install the `module-assistant` to build the DRBD kernel module, in addition to the DRBD components.

```
shell> apt-get install drbd0.7-utils drbd0.7-module-source \
  build-essential module-assistant
shell> module-assistant auto-install drbd0.7
```

- **CentOS**

DRBD can be installed using yum:

```
shell> yum install drbd kmod-drbd
```

- **Ubuntu**

You must enable the universe component for your preferred Ubuntu mirror in `/etc/apt/sources.list`, and then issue these commands:

```
shell> apt-get update
shell> apt-get install drbd8-utils drbd8-module-source \
  build-essential module-assistant
shell> module-assistant auto-install drbd8
```

- **Gentoo**

You can now `emerge` DRBD 0.8.x into your Gentoo installation:

```
root-shell> emerge drbd
```

Once `drbd` has been downloaded and installed, you need to decompress and copy the default configuration file from `/usr/share/doc/drbd-8.0.7/drbd.conf.bz2` into `/etc/drbd.conf`.

### 14.1.1.3. Setting Up a DRBD Primary Node

To set up a DRBD primary node you need to configure the DRBD service, create the first DRBD block device and then create a file system on the device so that you can store files and data.

The DRBD configuration file `/etc/drbd.conf` defines a number of parameters for your DRBD configuration, including the frequency of updates and block sizes, security information and the definition of the DRBD devices that you want to create.

The key elements to configure are the `on` sections which specify the configuration of each node.

To follow the configuration, the sequence below shows only the changes from the default `drbd.conf` file. Configurations within the file can be both global or tied to specific resource.

1. Set the synchronization rate between the two nodes. This is the rate at which devices are synchronized in the background after a disk failure, device replacement or during the initial setup. You should keep this in check compared to the speed of your network connection. Gigabit Ethernet can support up to 125 MB/second, 100Mbps Ethernet slightly less than a tenth of that (12MBps). If you are using a shared network connection, rather than a dedicated, then you should gauge accordingly.

To set the synchronization rate, edit the `rate` setting within the `syncer` block:

```
syncer {
  rate 10M;
}
```

You may additionally want to set the `al-extents` parameter. The default for this parameter is 257.

For more detailed information on synchronization, the effects of the synchronization rate and the effects on network performance, see [Section 14.1.3.2, “Optimizing the Synchronization Rate”](#).

2. Set up some basic authentication. DRBD supports a simple password hash exchange mechanism. This helps to ensure that only those hosts with the same shared secret are able to join the DRBD node group.

```
cram-hmac-alg "sha1";
```

```
shared-secret "shared-string";
```

- Now you must configure the host information. Remember that you must have the node information for the primary and secondary nodes in the `drbd.conf` file on each host. You need to configure the following information for each node:
  - `device` — the path of the logical block device that will be created by DRBD.
  - `disk` — the block device that will be used to store the data.
  - `address` — the IP address and port number of the host that will hold this DRBD device.
  - `meta-disk` — the location where the metadata about the DRBD device will be stored. You can set this to `internal` and DRBD will use the physical block device to store the information, by recording the metadata within the last sections of the disk. The exact size will depend on the size of the logical block device you have created, but it may involve up to 128MB.

A sample configuration for our primary server might look like this:

```
on drbd-one {
device /dev/drbd0;
disk /dev/hdd1;
address 192.168.0.240:8888;
meta-disk internal;
}
```

The `on` configuration block should be repeated for the secondary node (and any further) nodes:

```
on drbd-two {
device /dev/drbd0;
disk /dev/hdd1;
address 192.168.0.241:8888;
meta-disk internal;
}
```

The IP address of each `on` block must match the IP address of the corresponding host. Do not set this value to the IP address of the corresponding primary or secondary in each case.

- Before starting the primary node, you should create the metadata for the devices:

```
root-shell> drbdadm create-md all
```

- You are now ready to start DRBD:

```
root-shell> /etc/init.d/drbd start
```

DRBD should now start and initialize, creating the DRBD devices that you have configured.

- DRBD creates a standard block device - to make it usable, you must create a file system on the block device just as you would with any standard disk partition. Before you can create the file system, you must mark the new device as the primary device (i.e. where the data will be written and stored), and initialize the device. Because this is a destructive operation, you must specify the command line option to overwrite the raw data:

```
root-shell> drbdadm -- --overwrite-data-of-peer primary all
```

If you are using a version of DRBD 0.7.x or earlier, then you need to use a different command-line option:

```
root-shell> drbdadm -- --do-what-I-say primary all
```

Now create a file system using your chosen file system type:

```
root-shell> mkfs.ext3 /dev/drbd0
```

- You can now mount the file system and if necessary copy files to the mount point:

```
root-shell> mkdir /mnt/drbd
root-shell> mount /dev/drbd0 /mnt/drbd
root-shell> echo "DRBD Device" >/mnt/drbd/samplefile
```

Your primary node is now ready to use. You should now configure your secondary node or nodes.

### 14.1.1.4. Setting Up a DRBD Secondary Node

The configuration process for setting up a secondary node is the same as for the primary node, except that you do not have to create the file system on the secondary node device, as this information will automatically be transferred from the primary node.

To set up a secondary node:

1. Copy the `/etc/drbd.conf` file from your primary node to your secondary node. It should already contain all the information and configuration that you need, since you had to specify the secondary node IP address and other information for the primary node configuration.
2. Create the DRBD metadata on the underlying disk device:

```
root-shell> drbdadm create-md all
```

3. Start DRBD:

```
root-shell> /etc/init.d/drbd start
```

Once DRBD has started, it will start the copy the data from the primary node to the secondary node. Even with an empty file system this will take some time, since DRBD is copying the block information from a block device, not simply copying the file system data.

You can monitor the progress of the copy between the primary and secondary nodes by viewing the output of `/proc/drbd`:

```
root-shell> cat /proc/drbd
version: 8.0.4 (api:86/proto:86)
SVN Revision: 2947 build by root@drbd-one, 2007-07-30 16:43:05
0: cs:SyncSource st:Primary/Secondary ds:UpToDate/Inconsistent C r---
ns:252284 nr:0 dw:0 dr:257280 al:0 bm:15 lo:0 pe:7 ua:157 ap:0
[==>.....] sync'ed: 12.3% (1845088/2097152)K
finish: 0:06:06 speed: 4,972 (4,580) K/sec
resync: used:1/31 hits:15901 misses:16 starving:0 dirty:0 changed:16
act_log: used:0/257 hits:0 misses:0 starving:0 dirty:0 changed:0
```

You can monitor the synchronization process by using the `watch` command to run the command at specific intervals:

```
root-shell> watch -n 10 'cat /proc/drbd'
```

### 14.1.1.5. Monitoring DRBD Device

Once the primary and secondary machines are configured and synchronized, you can get the status information about your DRBD device by viewing the output from `/proc/drbd`:

```
root-shell> cat /proc/drbd
version: 8.0.4 (api:86/proto:86)
SVN Revision: 2947 build by root@drbd-one, 2007-07-30 16:43:05
0: cs:Connected st:Primary/Secondary ds:UpToDate/UpToDate C r---
ns:2175704 nr:0 dw:99192 dr:2076641 al:33 bm:128 lo:0 pe:0 ua:0 ap:0
resync: used:0/31 hits:134841 misses:135 starving:0 dirty:0 changed:135
act_log: used:0/257 hits:24765 misses:33 starving:0 dirty:0 changed:33
```

The first line provides the version/revision and build information.

The second line starts the detailed status information for an individual resource. The individual field headings are as follows:

- `cs` — connection state
- `st` — node state (local/remote)
- `ld` — local data consistency
- `ds` — data consistency
- `ns` — network send
- `nr` — network receive
- `dw` — disk write

- `dr` — disk read
- `pe` — pending (waiting for ack)
- `ua` — unack'd (still need to send ack)
- `al` — access log write count

In the previous example, the information shown indicates that the nodes are connected, the local node is the primary (because it is listed first), and the local and remote data is up to date with each other. The remainder of the information is statistical data about the device, and the data exchanged that kept the information up to date.

You can also get the status information for DRBD by using the startup script with the `status` option:

```
root-shell> /etc/init.d/drbd status
* status: started
* drbd driver loaded OK; device status: ...
version: 8.3.0 (api:88/proto:86-89)
GIT-hash: 9ba8b93e24d842f0dd3fblf9b90e8348ddb95829 build by root@gentool.vmbear, 2009-03-14 23:00:06
0: cs:Connected ro:Secondary/Secondary ds:UpToDate/UpToDate C r---
ns:0 nr:0 dw:0 dr:8385604 al:0 bm:0 lo:0 pe:0 ua:0 ap:0 ep:1 wo:b oos:0
```

The information and statistics are the same.

### 14.1.1.6. Managing your DRBD Installation

For administration, the main command is `drbdadm`. There are a number of commands supported by this tool to control the connectivity and status of the DRBD devices.

#### Note

For convenience, a bash completion script is available. This will provide tab completion for options to `drbdadm`. The file `drbdadm.bash_completion` can be found within the standard DRBD source package within the `scripts` directory. To enable, copy the file to `/etc/bash_completion.d/drbdadm`. You can load it manually by using:

```
shell> source /etc/bash_completion.d/drbdadm
```

The most common commands are those to set the primary/secondary status of the local device. You can manually set this information for a number of reasons, including when you want to check the physical status of the secondary device (since you cannot mount a DRBD device in primary mode), or when you are temporarily moving the responsibility of keeping the data in check to a different machine (for example, during an upgrade or physical move of the normal primary node). You can set state of all local device to be the primary using this command:

```
root-shell> drbdadm primary all
```

Or switch the local device to be the secondary using:

```
root-shell> drbdadm secondary all
```

To change only a single DRBD resource, specify the resource name instead of `all`.

You can temporarily disconnect the DRBD nodes:

```
root-shell> drbdadm disconnect all
```

Reconnect them using `connect`:

```
root-shell> drbdadm connect all
```

For other commands and help with `drbdadm` see the DRBD documentation.

### 14.1.1.7. Additional DRBD Configuration Options

Additional options you may want to configure:

- `protocol` — specifies the level of consistency to be used when information is written to the block device. The option is similar in principle to the `innodb_flush_log_at_trx_commit` option within MySQL. Three levels are supported:

- **A** — data is considered written when the information reaches the TCP send buffer and the local physical disk. There is no guarantee that the data has been written to the remote server or the remote physical disk.
- **B** — data is considered written when the data has reached the local disk and the remote node's network buffer. The data has reached the remote server, but there is no guarantee it has reached the remote server's physical disk.
- **C** — data is considered written when the data has reached the local disk and the remote node's physical disk.

The preferred and recommended protocol is C, as it is the only protocol which ensures the consistency of the local and remote physical storage.

- **size** — if you do not want to use the entire partition space with your DRBD block device then you can specify the size of the DRBD device to be created. The size specification can include a quantifier. For example, to set the maximum size of the DRBD partition to 1GB you would use:

```
size 1G;
```

With the configuration file suitably configured and ready to use, you now need to populate the lower-level device with the metadata information, and then start the DRBD service.

## 14.1.2. Configuring MySQL for DRBD

Once you have configured DRBD and have an active DRBD device and file system, you can configure MySQL to use the chosen device to store the MySQL data.

When performing a new installation of MySQL, you can either select to install MySQL entirely onto the DRBD device, or just configure the data directory to be located on the new file system.

In either case, the files and installation must take place on the primary node, because that is the only DRBD node on which you can mount the DRBD device file system as read/write.

You should store the following files and information on your DRBD device:

- MySQL data files, including the binary log, and InnoDB data files.
- MySQL configuration file (`my.cnf`).

To set up MySQL to use your new DRBD device and file system:

1. If you are migrating an existing MySQL installation, stop MySQL:

```
shell> mysqladmin shutdown
```

2. Copy the `my.cnf` onto the DRBD device. If you are not already using a configuration file, copy one of the sample configuration files from the MySQL distribution.

```
root-shell> mkdir /mnt/drbd/mysql
root-shell> cp /etc/my.cnf /mnt/drbd/mysql
```

3. Copy your MySQL data directory to the DRBD device and mounted file system.

```
root-shell> cp -R /var/lib/mysql /drbd/mysql/data
```

4. Edit the configuration file to reflect the change of directory by setting the value of the `datadir` option. If you have not already enabled the binary log, also set the value of the `log-bin` option.

```
datadir = /drbd/mysql/data
log-bin = mysql-bin
```

5. Create a symbolic link from `/etc/my.cnf` to the new configuration file on the DRBD device file system.

```
root-shell> ln -s /drbd/mysql/my.cnf /etc/my.cnf
```

6. Now start MySQL and check that the data that you copied to the DRBD device file system is present.

```
root-shell> /etc/init.d/mysql start
```

Your MySQL data should now be located on the file system running on your DRBD device. The data will be physically stored on the underlying device that you configured for the DRBD device. Meanwhile, the content of your MySQL databases will be copied to the secondary DRBD node.

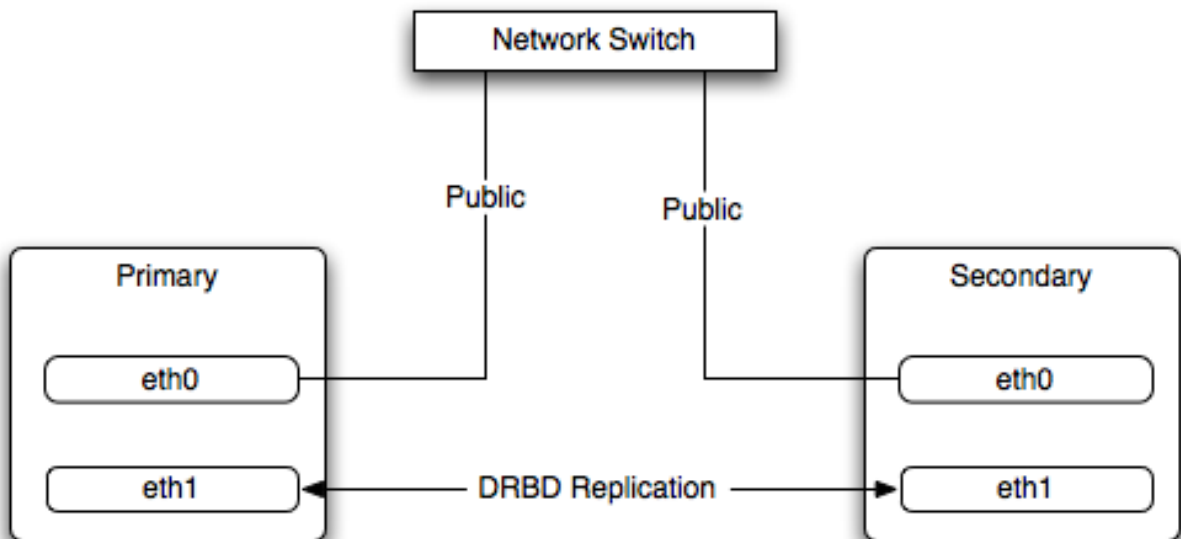
Note that you cannot access the information on your secondary node, as a DRBD device working in secondary mode is not available for use.

### 14.1.3. Optimizing Performance and Reliability

Because of the nature of the DRBD system, the critical requirements are for a very fast exchange of the information between the two hosts. To ensure that your DRBD setup is available to switch over in the event of a failure as quickly as possible, you must transfer the information between the two hosts using the fastest method available.

Typically, a dedicated network circuit should be used for exchanging DRBD data between the two hosts. You should then use a separate, additional, network interface for your standard network connection. For an example of this layout, see [Figure 14.2, “DRBD Architecture Using Separate Network Interfaces”](#).

**Figure 14.2. DRBD Architecture Using Separate Network Interfaces**



The dedicated DRBD network interfaces should be configured to use a non-routed TCP/IP network configuration. For example, you might want to set the primary to use 192.168.0.1 and the secondary 192.168.0.2. These networks and IP addresses should not be part of normal network subnet.

#### Note

The preferred setup, whenever possible, is to use a direct cable connection (using a crossover cable with Ethernet, for example) between the two machines. This eliminates the risk of loss of connectivity due to switch failures.

#### 14.1.3.1. Using Bonded Ethernet Network Interfaces

For a set-up where there is a high-throughput of information being written, you may want to use bonded network interfaces. This is where you combine the connectivity of more than one network port, increasing the throughput linearly according to the number of bonded connections.

Bonding also provides an additional benefit in that with multiple network interfaces effectively supporting the same communications channel, a fault within a single network interface in a bonded group does not stop communication. For example, imagine you have a bonded setup with four network interfaces providing a single interface channel between two DRBD servers. If one network interface fails, communication can continue on the other three without interruption, although it will be at a lower speed.



To enable bonded connections you must enable bonding within the kernel. You then need to configure the module to specify the bonded devices and then configure each new bonded device just as you would a standard network device:

- To configure the bonded devices, you need to edit the `/etc/modprobe.conf` file (RedHat) or add a file to the `/etc/modprobe.d` directory. In each case you will define the parameters for the kernel module. First, you need to specify each bonding device:

```
alias bond0 bonding
```

You can then configure additional parameters for the kernel module. Typical parameters are the `mode` option and the `miimon` option.

The `mode` option specifies how the network interfaces are used. The default setting is 0, which means that each network interface is used in a round-robin fashion (this supports aggregation and fault tolerance). Using setting 1 sets the bonding mode to active-backup. This means that only one network interface is used as a time, but that the link will automatically failover to a new interface if the primary interface fails. This settings only supports fault-tolerance.

The `miimon` option enables the MII link monitoring. A positive value greater than zero indicates the monitoring frequency in milliseconds for checking each slave network interface that is configured as part of the bonded interface. A typical value is 100.

You set th options within the module parameter file, and you must set the options for each bonded device individually:

```
options bond0 miimon=100 mode=1
```

- Reboot your server to enable the bonded devices.
- Configure the network device parameters. There are two parts to this, you need to setup the bonded device configuration, and then configure the original network interfaces as 'slaves' of the new bonded interface.

- For RedHat Linux:

Edit the configuration file for the bonded device. For device `bond0` this would be `/etc/sysconfig/network-scripts/ifcfg-bond0`:

```
DEVICE=bond0
BOOTPROTO=none
ONBOOT=yes
GATEWAY=192.168.0.254
NETWORK=192.168.0.0
NETMASK=255.255.255.0
IPADDR=192.168.0.1
USERCTL=no
```

Then for each network interface that you want to be part of the bonded device, configure the interface as a slave to the 'master' bond. For example, the configuration of `eth0` in `/etc/sysconfig/network-scripts/ifcfg-eth0` might look like this::

```
DEVICE=eth0
BOOTPROTO=none
HWADDR=00:11:22:33:44:55
ONBOOT=yes
TYPE=Ethernet
MASTER=bond0
SLAVE=yes
```

- For Debian Linux:

Edit the `/etc/iftab` file and configure the logical name and MAC address for each devices. For example:

```
eth0 mac 00:11:22:33:44:55
```

Now you need to set the configuration of the devices in `/etc/network/interfaces`:

```
auto bond0
iface bond0 inet static
address 192.168.0.1
netmask 255.255.255.0
network 192.168.0.0
gateway 192.168.0.254
up /sbin/ifenslave bond0 eth0
up /sbin/ifenslave bond0 eth1
```

- For Gentoo:

Use `emerge` to add the `net-misc/ifenslave` package to your system.

Edit the `/etc/conf.d/net` file and specify the network interface slaves in a bond, the dependencies and then the configuration for the bond itself. A sample configuration might look like this:

```
slaves_bond0="eth0 eth1 eth2"

config_bond0=( "192.168.0.1 netmask 255.255.255.0" )

depend_bond0() {
  need net.eth0 net.eth1 net.eth2
}
```

Then make sure that you add the new network interface to list of interfaces configured during boot:

```
root-shell> rc-update add default net.bond0
```

Once the bonded devices are configured you should reboot your systems.

You can monitor the status of a bonded connection using the `/proc` file system:

```
root-shell> cat /proc/net/bonding/bond0
Bonding Mode: fault-tolerance (active-backup)
Primary Slave: None
Currently Active Slave: eth1
MII Status: up
MII Polling Interval (ms): 100
Up Delay (ms): 200
Down Delay (ms): 200
Slave Interface: eth1
MII Status: up
Link Failure Count: 0
Permanent HW addr: 00:11:22:33:44:55
Slave Interface: eth2
MII Status: up
Link Failure Count: 0
Permanent HW addr: 00:11:22:33:44:56
```

### 14.1.3.2. Optimizing the Synchronization Rate

The `syncer rate` configuration parameter should be configured with care as the synchronization rate can have a significant effect on the performance of the DRBD setup in the event of a node or disk failure where the information is being synchronized from the Primary to the Secondary node.

In DRBD, there are two distinct ways of data being transferred between peer nodes:

- *Replication* refers to the transfer of modified blocks being transferred from the primary to the secondary node. This happens automatically when the block is modified on the primary node, and the replication process uses whatever bandwidth is available over the replication link. The replication process cannot be throttled, because you want to transfer of the block information to happen as quickly as possible during normal operation.
- *Synchronization* refers to the process of bringing peers back in sync after some sort of outage, due to manual intervention, node failure, disk swap, or the initial setup. Synchronization is limited to the `syncer rate` configured for the DRBD device.

Both replication and synchronization can take place at the same time. For example, the block devices can be being synchronized while they are actively being used by the primary node. Any I/O that updates on the primary node will automatically trigger replication of the modified block. In the event of a failure within an HA environment, it is highly likely that synchronization and replication will take place at the same time.

Unfortunately, if the synchronization rate is set too high, then the synchronization process will use up all the available network bandwidth between the primary and secondary nodes. In turn, the bandwidth available for replication of changed blocks is zero, which means replication will stall and I/O will block, and ultimately the application will fail or degrade.

To avoid enabling the `syncer rate` to consume the available network bandwidth and prevent the replication of changed blocks you should set the `syncer rate` to less than the maximum network bandwidth.

You should avoid setting the sync rate to more than 30% of the maximum bandwidth available to your device and network bandwidth. For example, if your network bandwidth is based on Gigabit ethernet, you should achieve 110MB/s. Assuming your disk interface is capable of handling data at 110MB/s or more, then the sync rate should be configured as `33M` (33MB/s). If your disk sys-

tem works at a rate lower than your network interface, use 30% of your disk interface speed.

Depending on the application, you may wish to limit the synchronization rate. For example, on a busy server you may wish to configure a significantly slower synchronization rate to ensure the replication rate is not affected.

The `al-extents` parameter controls the number of 4MB blocks of the underlying disk that can be written to at the same time. Increasing this parameter lowers the frequency of the meta data transactions required to log the changes to the DRBD device, which in turn lowers the number of interruptions in your I/O stream when synchronizing changes. This can lower the latency of changes to the DRBD device. However, if a crash occurs on your primary, then all of the blocks in the activity log (i.e. the number of `al-extents` blocks) will need to be completely resynchronized before replication can continue.

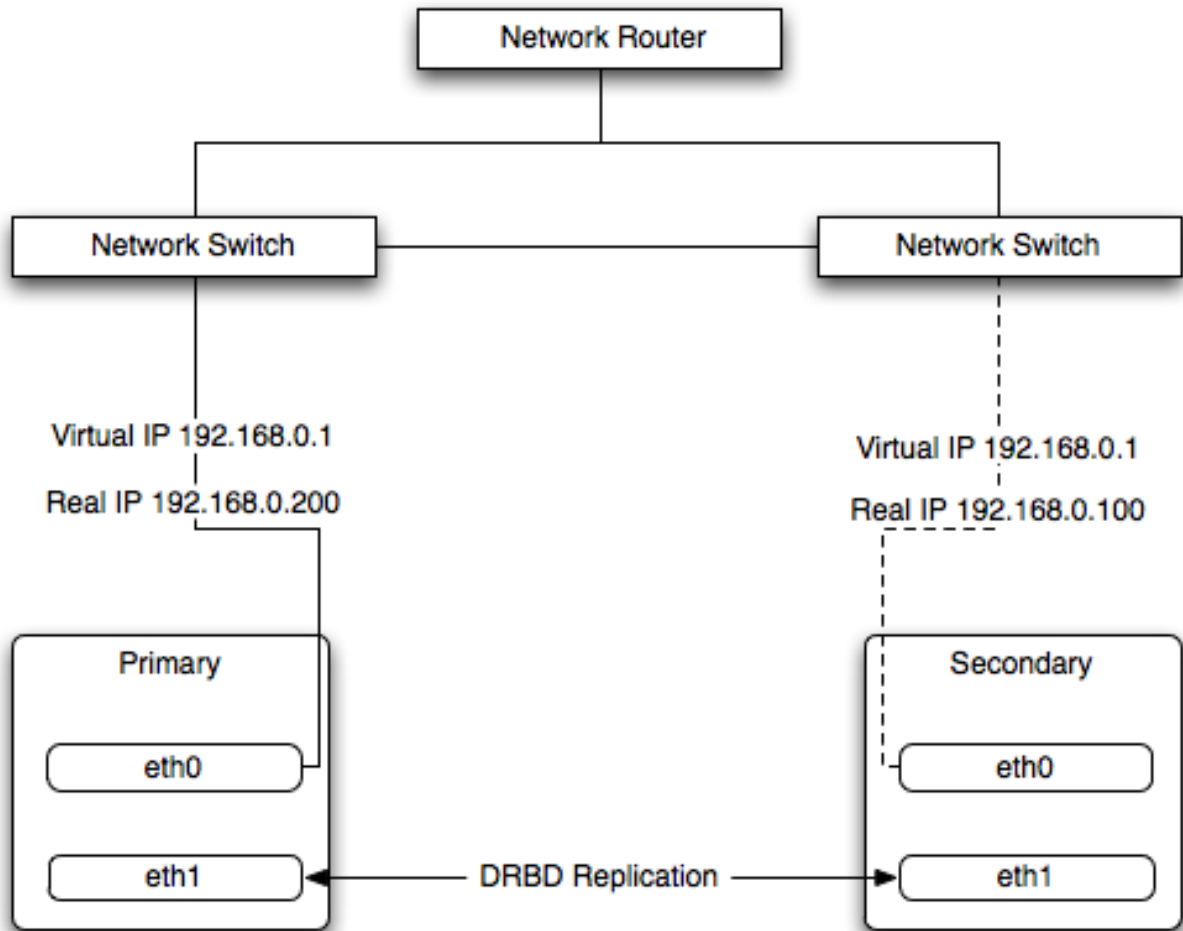
## 14.2. Using Linux HA Heartbeat

The Heartbeat program provides a basis for verifying the availability of resources on one or more systems within a cluster. In this context a resource includes MySQL, the file systems on which the MySQL data is being stored and, if you are using DRBD, the DRBD device being used for the file system. Heartbeat also manages a virtual IP address, and the virtual IP address should be used for all communication to the MySQL instance.

A cluster within the context of Heartbeat is defined as two computers notionally providing the same service. By definition, each computer in the cluster is physically capable of providing the same services as all the others in the cluster. However, because the cluster is designed for high-availability, only one of the servers is actively providing the service at any one time. Each additional server within the cluster is a “hot-spare” that can be brought into service in the event of a failure of the master, its next connectivity or the connectivity of the network in general.

The basics of Heartbeat are very simple. Within the Heartbeat cluster (see [Figure 14.3, “Heartbeat Architecture”](#)), each machine sends a 'heartbeat' signal to the other hosts in the cluster. The other cluster nodes monitor this heartbeat. The heartbeat can be transmitted over many different systems, including shared network devices, dedicated network interfaces and serial connections. Failure to get a heartbeat from a node is treated as failure of the node. Although we do not know the reason for the failure (it could be an OS failure, a hardware failure in the server, or a failure in the network switch), it is safe to assume that if no heartbeat is produced there is a fault.

### Figure 14.3. Heartbeat Architecture



In addition to checking the heartbeat from the server, the system can also check the connectivity (using `ping`) to another host on the network, such as the network router. This allows Heartbeat to detect a failure of communication between a server and the router (and therefore failure of the server, since it is no longer capable of providing the necessary service), even if the heartbeat between the servers in the clusters is working fine.

In the event of a failure, the resources on the failed host are disabled, and the resources on one of the replacement hosts is enabled instead. In addition, the Virtual IP address for the cluster is redirected to the new host in place of the failed device.

When used with MySQL and DRBD, the MySQL data is replicated from the master to the slave using the DRBD device, but MySQL is only running on the master. When the master fails, the slave switches the DRBD devices to be primary, the file systems on those devices are mounted, and MySQL is started. The original master (if still available) has its resources disabled, which means shutting down MySQL and unmounting the file systems and switching the DRBD device to secondary.

### 14.2.1. Heartbeat Configuration

Heartbeat configuration requires three files located in `/etc/ha.d`. The `ha.cf` contains the main heartbeat configuration, including the list of the nodes and times for identifying failures. `haresources` contains the list of resources to be managed within the cluster. The `authkeys` file contains the security information for the cluster.

The contents of these files should be identical on each host within the Heartbeat cluster. It is important that you keep these files in sync across all the hosts. Any changes in the information on one host should be copied to the all the others.

For these examples an example of the `ha.cf` file is shown below:

```
logfacility local0
keepalive 500ms
deadtime 10
warntime 5
initdead 30
mcast bond0 225.0.0.1 694 2 0
mcast bond1 225.0.0.2 694 1 0
auto_failback off
```

```
node drbd1
node drbd2
```

The individual lines in the file can be identified as follows:

- `logfacility` — sets the logging, in this case setting the logging to use `syslog`.
- `keepalive` — defines how frequently the heartbeat signal is sent to the other hosts.
- `deadtime` — the delay in seconds before other hosts in the cluster are considered 'dead' (failed).
- `warntime` — the delay in seconds before a warning is written to the log that a node cannot be contacted.
- `initdead` — the period in seconds to wait during system startup before the other host is considered to be down.
- `mcast` — defines a method for sending a heartbeat signal. In the above example, a multicast network address is being used over a bonded network device. If you have multiple clusters then the multicast address for each cluster should be unique on your network. Other choices for the heartbeat exchange exist, including a serial connection.

If you are using multiple network interfaces (for example, one interface for your server connectivity and a secondary and/or bonded interface for your DRBD data exchange) then you should use both interfaces for your heartbeat connection. This decreases the chance of a transient failure causing an invalid failure event.

- `auto_failback` — sets whether the original (preferred) server should be enabled again if it becomes available. Switching this to `on` may cause problems if the preferred went offline and then comes back on line again. If the DRBD device has not been synced properly, or if the problem with the original server happens again you may end up with two different datasets on the two servers, or with a continually changing environment where the two servers flip-flop as the preferred server reboots and then starts again.
- `node` — sets the nodes within the Heartbeat cluster group. There should be one `node` for each server.

An optional additional set of information provides the configuration for a ping test that will check the connectivity to another host. You should use this to ensure that you have connectivity on the public interface for your servers, so the ping test should be to a reliable host such as a router or switch. The additional lines specify the destination machine for the `ping`, which should be specified as an IP address, rather than a host name; the command to run when a failure occurs, the authority for the failure and the timeout before a non-response triggers a failure. A sample configure is shown below:

```
ping 10.0.0.1
respawn hacluster /usr/lib64/heartbeat/ipfail
apiauth ipfail gid=haclient uid=hacluster
deadping 5
```

In the above example, the `ipfail` command, which is part of the Heartbeat solution, is called on a failure and 'fakes' a fault on the currently active server. You need to configure the user and group ID under which the command should be executed (using the `apiauth`). The failure will be triggered after 5 seconds.

### Note

The `deadping` value must be less than the `deadtime` value.

The `authkeys` file holds the authorization information for the Heartbeat cluster. The authorization relies on a single unique 'key' that is used to verify the two machines in the Heartbeat cluster. The file is used only to confirm that the two machines are in the same cluster and is used to ensure that the multiple clusters can co-exist within the same network.

## 14.2.2. Using Heartbeat with MySQL and DRBD

To use Heartbeat in combination with MySQL you should be using DRBD (see [Section 14.1, “Using MySQL with DRBD”](#)) or another solution that allows for sharing of the MySQL database files in event of a system failure. In these examples, DRBD is used as the data sharing solution.

Heartbeat manages the configuration of different resources to manage the switching between two servers in the event of a failure. The resource configuration defines the individual services that should be brought up (or taken down) in the event of a failure.

The `haresources` file within `/etc/ha.d` defines the resources that should be managed, and the individual resource mentioned in this file in turn relates to scripts located within `/etc/ha.d/resource.d`. The resource definition is defined all on one line:

```
drbd1 drbddisk Filesystem::/dev/drbd0::/drbd::ext3 mysql 10.0.0.100
```

The line is notionally split by whitespace. The first entry (`drbd1`) is the name of the preferred host, i.e. the server that is normally responsible for handling the service. The last field is virtual IP address or name that should be used to share the service. This is the IP address that should be used to connect to the MySQL server. It will automatically be allocated to the server that is active when Heartbeat starts.

The remaining fields between these two fields define the resources that should be managed. Each Field should contain the name of the resource (and each name should refer to a script within `/etc/ha.d/resource.d`). In the event of a failure, these resources are started on the backup server by calling the corresponding script (with a single argument, `start`), in order from left to right. If there are additional arguments to the script, you can use a double colon to separate each additional argument.

In the above example, we manage the following resources:

- `drbddisk` — the DRBD resource script, this will switch the DRBD disk on the secondary host into primary mode, making the device read/write.
- `Filesystem` — manages the Filesystem resource. In this case we have supplied additional arguments to specify the DRBD device, mount point and file system type. When executed this should mount the specified file system.
- `mysql` — manages the MySQL instances and starts the MySQL server. You should copy the `mysql.resource` file from the `support-files` directory from any MySQL release into the `/etc/ha.d/resources.d` directory.

If this file is not available in your distribution, you can use the following as the contents of the `/etc/ha.d/resource.d/mysql.resource` file:

```
#!/bin/bash
#
# This script is intended to be used as resource script by heartbeat
#
# Mar 2006 by Monty Taylor
#
###
. /etc/ha.d/shellfuncs
case "$1" in
  start)
    res=`/etc/init.d/mysql start`
    ret=$?
    ha_log $res
    exit $ret
    ;;
  stop)
    res=`/etc/init.d/mysql stop`
    ret=$?
    ha_log $res
    exit $ret
    ;;
  status)
    if [ `ps -ef | grep '[mysqld]'` ]; then
      echo "running"
    else
      echo "stopped"
    fi
    ;;
  *)
    echo "Usage: mysql {start|stop|status}"
    exit 1
    ;;
esac
exit 0
```

If you want to be notified of the failure by email, you can add another line to the `haresources` file with the address for warnings and the warning text:

```
MailTo::youremail@address.com::DRBDFailure
```

With the Heartbeat configuration in place, copy the `haresources`, `authkeys` and `ha.cf` files from your primary and secondary servers to make sure that the configuration is identical. Then start the Heartbeat service, either by calling `/etc/init.d/heartbeat start` or by rebooting both primary and secondary servers.

You can test the configuration by running a manual failover, connect to the primary node and run:

```
root-shell> /usr/lib64/heartbeat/hb_standby
```

This will cause the current node to relinquish its resources cleanly to the other node.

### 14.2.3. Using Heartbeat with DRBD and `dopd`

As a further extension to using DRBD and Heartbeat together, you can enable `dopd`. The `dopd` daemon handles the situation where a DRBD node is out of date compared to the master and prevents the slave from being promoted to master in the event of a failure. This stops a situation where you have two machines that have been masters ending up with different data on the underlying device.

For example, imagine that you have a two server DRBD setup, master and slave. If the DRBD connectivity between master and slave fails then the slave would be out of the sync with the master. If Heartbeat identifies a connectivity issue for master and then switches over to the slave, the slave DRBD device will be promoted to the primary device, even though the data on the slave and the master is not in synchronization.

In this situation, with `dopd` enabled, the connectivity failure between the master and slave would be identified and the metadata on the slave would be set to `Outdated`. Heartbeat will then refuse to switch over to the slave even if the master failed. In a dual-host solution this would effectively render the cluster out of action, as there is no additional fail over server. In an HA cluster with three or more servers, control would be passed to the slave that has an up to date version of the DRBD device data.

To enable `dopd`, you need to modify the Heartbeat configuration and specify `dopd` as part of the commands executed during the monitoring process. Add the following lines to your `ha.cf` file:

```
respawn hacluster /usr/lib/heartbeat/dopd
apiauth dopd gid=haclient uid=hacluster
```

Make sure you make the same modification on both your primary and secondary nodes.

You will need to reload the Heartbeat configuration:

```
root-shell> /etc/init.d/heartbeat reload
```

You will also need to modify your DRBD configuration by configuration the `outdate-peer` option. You will need to add the configuration line into the `common` section of `/etc/drbd.conf` on both hosts. An example of the full block is shown below:

```
common {
  handlers {
    outdate-peer "/usr/lib/heartbeat/drbd-peer-outdater";
  }
}
```

Finally, set the `fencing` option on your DRBD configured resources:

```
resource my-resource {
  disk {
    fencing resource-only;
  }
}
```

Now reload your DRBD configuration:

```
root-shell> drbdadmin adjust all
```

You can test the system by unplugging your DRBD link and monitoring the output from `/proc/drbd`.

### 14.2.4. Dealing with System Level Errors

Because a kernel panic or oops may indicate potential problem with your server, you should configure your server to remove itself from the cluster in the event of a problem. Typically on a kernel panic your system will automatically trigger a hard reboot. For a kernel oops a reboot may not happen automatically, but the issue that caused that oops may still lead to potential problems.

You can force a reboot by setting the `kernel.panic` and `kernel.panic_on_oops` parameters of the kernel control file `/etc/sysctl.conf`. For example:

```
kernel.panic_on_oops = 1
kernel.panic = 1
```

You can also set these parameters during runtime by using the `sysctl` command. You can either specify the parameters on the command line:

```
shell> sysctl -w kernel.panic=1
```

Or you can edit your `sysctl.conf` file and then reload the configuration information:

```
shell> sysctl -p
```

By setting both these parameters to a positive value (actually the number of seconds to wait before triggering the reboot), the system will reboot. Your second heartbeat node should then detect that the server is down and then switch over to the failover host.

## 14.3. MySQL and Virtualization

Using virtualization can be an effective way of better utilizing the hardware of your machine when using MySQL, or to provide improved security or isolation of different instances of MySQL on the same machine. In some circumstances, virtualization may be a suitable solution for scaling out your database environment by enabling you to easily deploy additional instances of a pre-configured MySQL server and application environment to new virtualization hosts.

With any virtualization solution there is often a tradeoff between the flexibility and ease of deployment and performance, or between the potential performance advantage and complexities of effectively configuring multiple instances of MySQL to reside within a single physical host.

Different issues are experienced according to the virtualization environment you are using. Virtualization generally falls into one of the following categories:

- **Native virtualization**, including products like VMware Workstation, Parallels Desktop/Parallels Workstation, Microsoft Virtual PC and VirtualBox, all work by acting as an application that runs within an existing operating system environment. Recent versions can take advantage of the virtualization extensions in the Intel and AMD CPUs to help improve performance.

The application-based solutions have a number of advantages, including the ability to prioritize CPU usage (including multiple CPUs) and easily run multiple virtualized environments simultaneously.

With these solutions, you also have the ability to easily create a virtualized environment that can be packaged and shared among different virtualization hosts. For example, you can create a MySQL environment and configuration that can be deployed multiple times to help extend an existing scalability or HA environment.

The major disadvantage of this type of virtualization environment is the effect of the host on the performance of the virtualization instances. Disk storage is typically provided by using one or more files on the host OS which are then emulated to provide physical disks within the virtual instance. Other resources on the host are similarly shared, including CPU, network interfaces and additional devices (USB). It is also difficult to directly share lower-level components, such as PCI devices and that the ability to take advantage of RAID storage solutions.

- **Paravirtualization (Hypervisor)**, including Xen, Solaris xVM (based on Xen), VMware ESX Server, Windows Server 2008 Hyper-V, and Solaris Logical Domains (LDOM), work by running a specialized version of the host operating system. The host OS then allows slightly modified versions of different operating systems to run within the virtualized environment.

With paravirtualization, the level of performance and the control over the underlying hardware used to support the virtualized environments is higher than native virtualization solutions. For example, using paravirtualization you can dedicate individual CPU cores, RAM, disk drives and even PCI devices to be accessible to individual and specific virtual instances.

For example, within a paravirtualized environment you could dedicate a physical disk drive or subsystem to a particular virtual environment and gain a performance benefit over a typical file-based solution virtual disk.

- **Operating system-level virtualization**, including BSD jails, and Solaris Containers/Zones, offer methods for isolating different instances of an operating system environment while sharing the same hardware environment. Unlike the other virtualization solutions, operating system level virtualization is not normally used to run other operating systems, but instead to provide a level of security isolation and resource control within the core operating environment.

The isolation of these different instances is the key advantage of this type of virtualization. Each virtualized instance sees its environment as if it were completely different system. The solution can be an effective method to provide isolated computing resources for different departments or users, or to provide unique instances for testing and development.

The main reasons for using virtualization, particularly with a database or an application stack that includes a database component, include:

- **Security** — separate instances of different operating systems running within a single host but with effective isolation from each other. When used with MySQL, you can provide an increased level of security between different instances of each server.
- **Consolidation** — merging a number of individual systems with a relatively small load onto a single, larger, server. This can help reduce footprint and energy costs, or make more efficient use of a larger machine. Performance is the main issue with this



solution as the load of many MySQL databases running in individual virtual instances on a single machine can be considerable.

- **Development/QA/Testing** — by creating different instances of different environments and operating systems you can test your MySQL-based application in different environments.
- **Scalability** — although using virtualization imposes a performance hit, many virtualization solutions allow you to create a packaged version of an environment, including MySQL and the other application components. By distributing the virtualization environment package to new hosts you can often very quickly scale out by adding new hosts and deploying the virtualized environment.

The remainder of this chapter looks at common issues with using MySQL in a virtualized environment and tips for using MySQL within different virtualization tools.

For advice on common issues and problems, including performance and configuration issues, when using virtualized instances, see [Section 14.3.1, “Common Issues with Virtualization”](#).

### 14.3.1. Common Issues with Virtualization

There are many issues related to using MySQL within a virtualized environment that are common across the different virtualization types. Most are directly related to the performance or security of the environment in which you are deploying the MySQL server compared to the host on which you are running the virtualization solution.

Before deciding to use virtualization as a solution for your database, you should ensure that the expected load for the server and the expected performance when run in a virtualized environment meet your needs and requirements.

To help you determine the issues and some of the potential solutions, use the following sections:

- For general performance issues, problems and the probable causes, see [Section 14.3.1.1, “Virtualization Performance Issues”](#).
- Disk and storage concerns directly affect database storage because most database access is limited by the I/O bandwidth. For some examples and issues, see [Section 14.3.1.2, “Virtualization Storage Issues”](#).
- Issues related to network configuration and performance may need more careful planning, especially if you are using network-specific technologies such as MySQL replication. For further examples and details, see [Section 14.3.1.3, “Virtualization Networking Issues”](#).

#### 14.3.1.1. Virtualization Performance Issues

Often the biggest consideration is the performance of a virtualized environment once hosted. In most cases, the virtualized environment involves some level of emulation of one or more of the hardware interfaces (CPU, network or disk) of the host environment. The effect is to reduce the effective performance of the virtualized environment compared to running an application natively on the host.

Some core resourcing issues to be aware of include:

- Using virtualization does not reduce the amount of CPU required to support a particular application or environment. If your application stack requires 2GB of RAM on an individual machine, the same RAM requirement will apply within your virtualized environment. The additional overhead of the virtualization layer and host operating system or environment often mean that you will need 2.5GB or 3GB of RAM to run the same application within the virtualized environment.

You should configure your virtualization environment with the correct RAM allocation according to your applications needs, and not to maximize the number of virtualized environments that you can execute within the virtualization host.

- Virtualization of the CPU resources is more complex. If your MySQL database and application stack do not have a high CPU load, then consolidating multiple environments onto a single host is often more efficient. You should keep in mind that at peak times your application and database CPU requirement may need to grow beyond your default allocation.

With some virtualization environments (Xen, Solaris Containers, Solaris LDOMs) you can dedicate CPU or core to a virtual instance. You should use this functionality to improve performance for database or application loads that have a high constant CPU requirement as the performance benefit will outweigh the flexibility of dynamic allocation of the CPU resources.

- Contention of resources within the host should be taken into account. In a system with high CPU loads, even when dedicating RAM and CPU resources, the I/O channels and interfaces to storage and networking resources may exceed the capacity of the host. Solutions such as Xen and Solaris LDOMs dedicate specific resources to individual virtual instances, but this will not eliminate the effects of the overall load on the host.

- If your database application is time sensitive, including logging and real-time database applications, or you are using MySQL Cluster, then the effects of virtualization may severely reduce the performance of your application. Because of the way the virtualized instances are executed and shared between CPUs and the effects of load on other resources, the response times for your database or application may be much higher than normal. This is especially true if you are running a large number of virtualized instances on a single host.
- Be aware of the limitation of using a single host to run multiple virtualized instances. In the event of a machine or component failure, the problem will affect more than just one database instance. For example, a failure in a storage device could bring down all your virtualized instances. Using a RAID solution that supports fault tolerance (RAID levels 1,3,4,5 or 6) will help protect you from the effects of this.

### 14.3.1.2. Virtualization Storage Issues

Due to the random I/O nature of any database solution, running MySQL within a virtualized environment places a heavy load on the storage solution you are using. To help keep the performance of your virtualized solution at the highest level, you should use the following notes to help configure your systems.

- Some virtualization solutions allow you to use a physical disk directly within your virtual host as if it were a local disk. You should use this whenever possible to ensure that disk contention issues do not affect the performance of your virtual environment.

When running multiple virtual machines, you should use an individual disk for each virtual instance. Using a single disk and multiple partitions, with each partition dedicated to a virtual host, will lead to the same contention issues.

- If you are using standard file-based storage for your virtualized disks:
  - File-based storage is subject to fragmentation on the host disk. To prevent fragmentation, create a fixed-size disk (that is, one where the entire space for the disk file is preallocated) instead of a dynamic disk that will grow with usage. Also be prepared to defragment the disk hosting the files at regular intervals to reduce the fragmentation.
  - Use separate disk files for the operating system and database disks, and try to avoid partitioning a disk file as this increases the contention within the file.
  - Use a high-performance disk solution, such as RAID or SAN, to store the disk files for your virtualized environments. This will improve the performance of what is essentially a large single file on a physical device.
  - When running a number of different virtualized environments within a single host, do not use the same physical host drive for multiple virtual disks. Instead, spread the virtual disks among multiple physical disks. Even when using a RAID device, be aware that each virtual host is equivalent to increasing the load linearly on the host RAID device.

### 14.3.1.3. Virtualization Networking Issues

When running multiple virtual machines on a host, you should be aware of the networking implications of each virtualized instance. If your host machine has only one network card, then you will be sharing the networking throughput for all of your machines through only one card, and this may severely limit the performance of your virtual environments.

If possible, you should use multiple network cards to support your virtualized instances. Depending on the expected load of each instance, you should dedicate or spread the allocation of the virtual network devices across these physical devices to ensure that you do not reach saturation.

If you are using packaged virtual machines as the basis for deployment of your MySQL database solution, you should make sure that the network interfaces are correctly reconfigured. Some solutions duplicate the hardware MAC address which will cause problems when you start up additional instances of the same virtualized environment.

## 14.3.2. Using MySQL within an Amazon EC2 Instance

The Amazon Elastic Compute Cloud (EC2) service provides virtual servers that you can build and deploy to run a variety of different applications and services, including MySQL. The EC2 service is based around the Xen framework, supporting x86, Linux based, platforms with individual instances of a virtual machine referred to as an Amazon Machine Image (AMI). You have complete (root) access to the AMI instance that you create, allowing you to configure and install your AMI in any way you choose.

To use EC2, you create an AMI based on the configuration and applications that you want to use and upload the AMI to the Amazon Simple Storage Service (S3). From the S3 resource, you can deploy one or more copies of the AMI to run as an instance within the EC2 environment. The EC2 environment provides management and control of the instance and contextual information about the instance while it is running.

Because you can create and control the AMI, the configuration, and the applications, you can deploy and create any environment

you choose. This includes a basic MySQL server in addition to more extensive replication, HA and scalability scenarios that enable you to take advantage of the EC2 environment, and the ability to deploy additional instances as the demand for your MySQL services and applications grow.

To aid the deployment and distribution of work, three different Amazon EC2 instances are available, small (identified as `m1.small`), large (`m1.large`) and extra large (`m1.xlarge`). The different types provide different levels of computing power measured in EC2 computer units (ECU). A summary of the different instance configurations is shown here.

	Small	Large	Extra Large
Platform	32-bit	64-bit	64-bit
CPU cores	1	2	4
ECUs	1	4	8
RAM	1.7GB	7.5GB	15GB
Storage	150GB	840GB	1680GB
I/O Performance	Medium	High	High

The typical model for deploying and using MySQL within the EC2 environment is to create a basic AMI that you can use to hold your database data and application. Once the basic environment for your database and application has been created you can then choose to deploy the AMI to a suitable instance. Here the flexibility of having an AMI that can be re-deployed from the small to the large or extra large EC2 instance makes it easy to upgrade the hardware environment without rebuilding your application or database stack.

To get started with MySQL on EC2, including information on how to set up and install MySQL within an EC2 installation and how to port and migrate your data to the running instance, see [Section 14.3.2.1, “Setting Up MySQL on an EC2 AMI”](#).

For tips and advice on how to create a scalable EC2 environment using MySQL, including guides on setting up replication, see [Section 14.3.2.3, “Deploying a MySQL Database Using EC2”](#).

### 14.3.2.1. Setting Up MySQL on an EC2 AMI

There are many different ways of setting up an EC2 AMI with MySQL, including using any of the pre-configured AMIs supplied by Amazon.

The default *Getting Started* AMI provided by Amazon uses Fedora Core 4, and you can install MySQL by using `yum`:

```
shell> yum install mysql
```

This will install both the MySQL server and the Perl DBD::mysql driver for the Perl DBI API.

Alternatively, you can use one of the AMIs that include MySQL within the standard installation.

Finally, you can also install a standard version of MySQL downloaded from the MySQL website. The installation process and instructions are identical to any other installation of MySQL on Linux. See [Chapter 2, \*Installing and Upgrading MySQL\*](#).

The standard configuration for MySQL places the data files in the default location, `/var/lib/mysql`. The default data directory on an EC2 instance is `/mnt` (although on the large and extra large instance you can alter this configuration). You must edit `/etc/my.cnf` to set the `datadir` option to point to the larger storage area.

#### Important

The first time you use the main storage location within an EC2 instance it needs to be initialized. The initialization process starts automatically the first time you write to the device. You can start using the device right away, but the write performance of the new device is significantly lower on the initial writes until the initialization process has finished.

To avoid this problem when setting up a new instance, you should start the initialization process before populating your MySQL database. One way to do this is to use `dd` to write to the file system:

```
root-shell> dd if=/dev/zero of=initialize bs=1024M count=50
```

The preceding will create a 50GB on the file system and start the initialization process. You should delete the file once the process has finished.

The initialization process can be time-consuming. On the small instance, initialization will take between two and three hours. For the large and extra large drives, the initialization will be 10 or 20 hours, respectively.

In addition to configuring the correct storage location for your MySQL data files, you should also consider setting the following other settings in your instance before you save the instance configuration for deployment:

- Set the MySQL server ID so that when you use it for replication the ID information is set correctly.
- Enabling binary logging so that replication can be initialized without starting and stopping the server.
- Set the caching and memory parameters for your storage engines. There are no limitations or restrictions on what storage engines you use in your EC2 environment. Choose a configuration, possibly using one of the standard configurations provided with MySQL appropriate for the instance on which you expect to deploy. The large and extra large instances have RAM that can be dedicated to caching. Be aware that if you choose to install [memcached](#) on the servers as part of your application stack you must ensure there is enough memory for both MySQL and [memcached](#).

Once you have configured your AMI with MySQL and the rest of your application stack, you should save the AMI so that you can deploy and reuse the instance.

Once you have your application stack configured in an AMI, populating your MySQL database with data should be performed by creating a dump of your database using [mysqldump](#), transferring the dump to the EC2 instance, and then reloading the information into the EC2 instance database.

Before using your instance with your application in a production situation you should be aware of the limitations of the EC2 instance environment. See [Section 14.3.2.2, “EC2 Instance Limitations”](#). To begin using your MySQL AMI, you should consult the notes on deployment. See [Section 14.3.2.3, “Deploying a MySQL Database Using EC2”](#).

### 14.3.2.2. EC2 Instance Limitations

There are some limitations of the EC2 instances that you should be aware of before deploying your applications. Although these shouldn't affect your ability to deploy within the Amazon EC2 environment, they may alter the way you setup and configure your environment to support your application.

- Data stored within instances is not persistent. If you create an instance and populate the instance with data, then the data will only remain in place while the machine is running. The data will survive a reboot. If you shut down the instance, any data it contained will be lost.

To ensure that you do not lose information, take regular backups using [mysqldump](#). If the data being stored is critical, consider using replication to keep a “live” backup of your data in the event of a failure. When creating a backup, write the data to the Amazon S3 service to avoid the transfer charges applied when copying data offsite.

- EC2 instances are not persistent. If the hardware on which an instance is running fails, then the instance will be shut down. This can lead to loss of data or service.
- If you want to use replication with your EC2 instances to a non-EC2 environment, be aware of the transfer costs to and from the EC2 service. Data transfer between different EC2 instances is free, so using replication within the EC2 environment does not incur additional charges.
- Certain HA features are either not directly supported, or have limiting factors or problems that may reduce their utility. For example, using DRBD or MySQL Cluster may not work. The default storage configuration is also not redundant. You can use software-based RAID to improve redundancy, but this implies a further performance hit.

### 14.3.2.3. Deploying a MySQL Database Using EC2

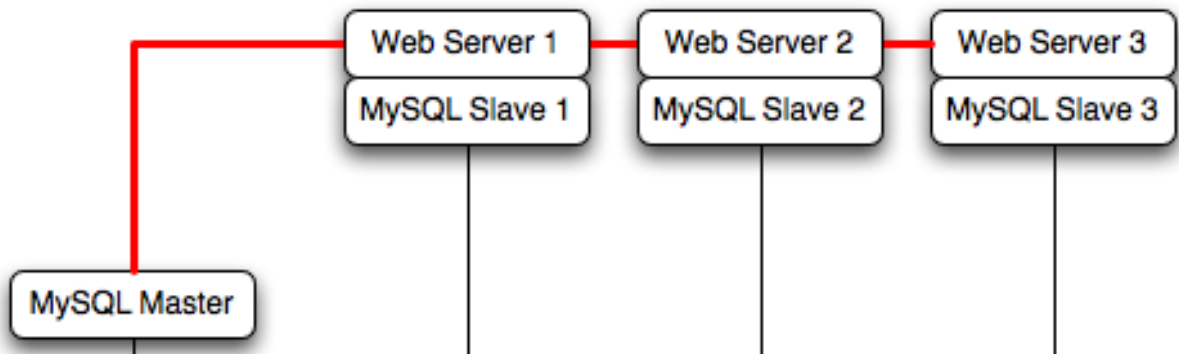
Because you cannot guarantee the uptime and availability of your EC2 instances, when deploying MySQL within the EC2 environment you should use an approach that enables you to easily distribute work among your EC2 instances. There are a number of ways of doing this. Using sharding techniques, where you split the application across multiple servers dedicating specific blocks of your dataset and users to different servers is an effective way of doing this. As a general rule, it is easier to create more EC2 instances to support more users than to upgrade the instance to a larger machine.

The EC2 architecture means that you should treat the EC2 instances as temporary, cache-based solutions, rather than as a long-term, high availability solution. In addition to using multiple machines, you should also take advantage of other services, such as [memcached](#) to provide additional caching for your application to help reduce the load on the MySQL server so that it can concentrate on writes. On the large and extra large instances within EC2, the RAM available can be used to provide a large memory cache for data.

Most types of scale out topology that you would use with your own hardware can be used and applied within the EC2 environment. However, you should be use the limitations and advice already given to ensure that any potential failures do not lose you any data. Also, because the relative power of each EC2 instance is so low, you should be prepared to alter your application to use sharding

and add further EC2 instances to improve the performance of your application.

For example, take the typical scale-out environment shown following, where a single master replicates to one or more slaves (three in this example), with a web server running on each replication slave.

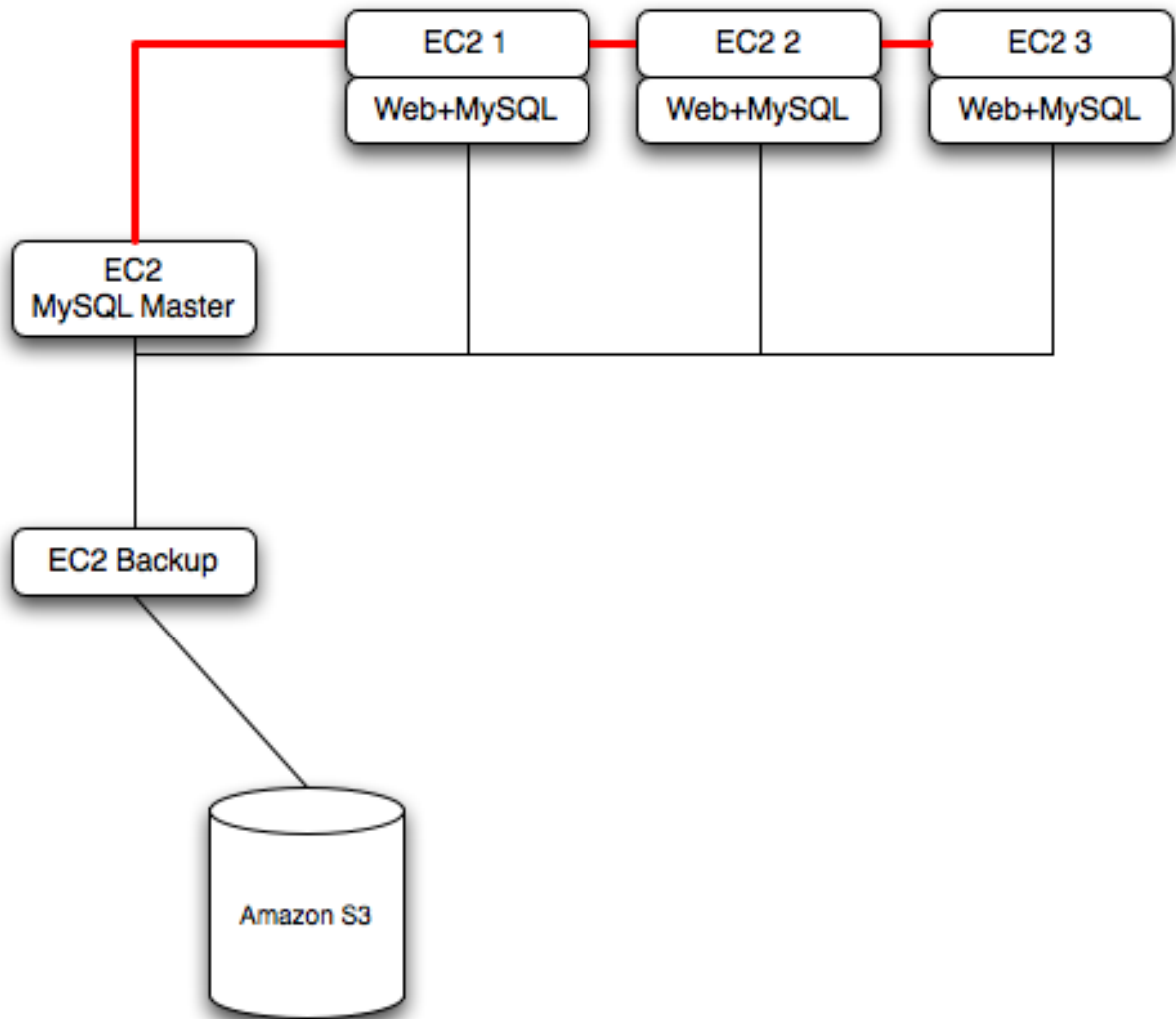


You can reproduce this structure completely within the EC2 environment, using an EC2 instance for the master, and one instance for each of the web and MySQL slave servers.

**Note**

Within the EC2 environment, internal (private) IP addresses used by the EC2 instances are constant. You should always use these internal addresses and names when communicating between instances. Only use public IP addresses when communicating with the outside world - for example, when publicizing your application.

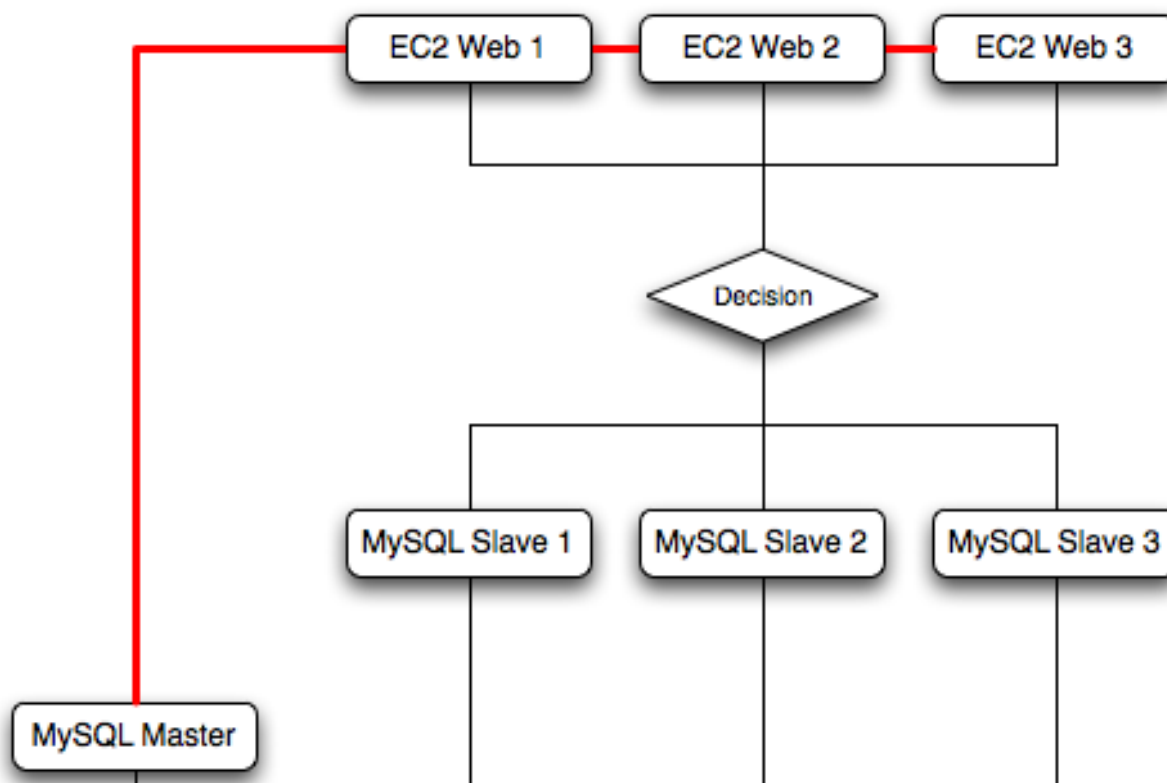
To ensure reliability of your database, you should add at least one replication slave dedicated to providing an active backup and storage to the Amazon S3 facility. You can see an example of this in the following topology.



Using [memcached](#) within your EC2 instances should provide better performance. The large and extra large instances have a significant amount of RAM. To use [memcached](#) in your application, when loading information from the database, first check whether the item exists in the cache. If the data you are looking for exists in the cache, use it. If not, reload the data from the database and populate the cache.

**Sharding** divides up data in your entire database by allocating individual machines or machine groups to provide a unique set of data according to an appropriate group. For example, you might put all users with a surname ending in the letters A-D onto a single server. When a user connects to the application and their surname is known, queries can be redirected to the appropriate MySQL server.

When using sharding with EC2 you should separate the web server and MySQL server into separate EC2 instances, and then apply the sharding decision logic into your application. Once you know which MySQL server you should be using for accessing the data you then distribute queries to the appropriate server. You can see a sample of this in the following illustration.

**Warning**

With sharding and EC2 you should be careful that the potential for failure of an instance does not affect your application. If the EC2 instance that provides the MySQL server for a particular shard fails, then all of the data on that shard will be unavailable.

### 14.3.3. Virtualization Resources

For more information on virtualization, see the following links:

- [MySQL Virtualization Forum](#)
- [Amazon Elastic Compute Cloud \(Amazon EC2\)](#)
- [MySQL and Cloud Computing](#)
- [MySQL Enterprise for Amazon EC2](#)

## 14.4. Using ZFS Replication

To support high availability environments, providing an instant copy of the information on both the currently active machine and the hot backup is a critical part of the HA solution. There are many solutions to this problem, including [Chapter 16, Replication](#) and [Section 14.1, “Using MySQL with DRBD”](#).

The ZFS filesystem provides functionality that allows you to create a snapshot of the filesystem contents and to then transfer the snapshot to another machine and extract the snapshot to recreate the filesystem. You can create a snapshot at any time, and you can create as many snapshots as you like. By continually creating, transferring and restoring snapshots you can provide synchronization between one or more machines in a fashion similar to DRBD.

To understand the replication solution within ZFS, you must first understand the ZFS environment. Below is a simple OpenSolaris system running with two pools, the `root` pool and another pool mounted at `/opt`:

```

Filesystem      size  used  avail capacity  Mounted on
rpool/ROOT/opensolaris-1
                 7.3G  3.6G  508M   88%      /
  
```

/devices	0K	0K	0K	0%	/devices
/dev	0K	0K	0K	0%	/dev
ctfs	0K	0K	0K	0%	/system/contract
proc	0K	0K	0K	0%	/proc
mnttab	0K	0K	0K	0%	/etc/mnttab
swap	465M	312K	465M	1%	/etc/svc/volatile
objfs	0K	0K	0K	0%	/system/object
sharefs	0K	0K	0K	0%	/etc/dfs/sharetab
/usr/lib/libc/libc_hwcap1.so.1					
fd	4.1G	3.6G	508M	88%	/lib/libc.so.1
fd	0K	0K	0K	0%	/dev/fd
swap	466M	744K	465M	1%	/tmp
swap	465M	40K	465M	1%	/var/run
rpool/export	7.3G	19K	508M	1%	/export
rpool/export/home	7.3G	1.5G	508M	75%	/export/home
rpool	7.3G	60K	508M	1%	/rpool
rpool/ROOT	7.3G	18K	508M	1%	/rpool/ROOT
opt	7.8G	1.0G	6.8G	14%	/opt

The MySQL data will be stored in a directory on `/opt`. To help demonstrate some of the basic replication functionality, there are also other items stored in `/opt` as well:

```
total 17
drwxr-xr-x  31 root   bin          50 Jul 21 07:32 DTT/
drwxr-xr-x   4 root   bin           5 Jul 21 07:32 SUNWmlib/
drwxr-xr-x  14 root   sys          16 Nov  5 09:56 SUNWspro/
drwxrwxrwx  19 1000  1000        40 Nov  6 19:16 emacs-22.1/
```

To create a snapshot of the filesystem, you use `zfs snapshot`, and then specify the pool and the snapshot name:

```
root-shell> zfs snapshot opt@snap1
```

To get a list of snapshots already taken:

```
root-shell> zfs list -t snapshot
NAME                                USED  AVAIL  REFER  MOUNTPOINT
opt@snap1                           0      -    1.03G  -
rpool@install                        19.5K  -      55K   -
rpool/ROOT@install                   15K    -      18K   -
rpool/ROOT/opensolaris-1@install     59.8M  -     2.22G  -
rpool/ROOT/opensolaris-1@opensolaris-1 100M   -     2.29G  -
rpool/ROOT/opensolaris-1/opt@install  0      -     3.61M  -
rpool/ROOT/opensolaris-1/opt@opensolaris-1 0      -     3.61M  -
rpool/export@install                 15K    -      19K   -
rpool/export/home@install            20K    -      21K   -
```

The snapshots themselves are stored within the filesystem metadata, and the space required to keep them will vary as time goes on because of the way the snapshots are created. The initial creation of a snapshot is really quick, because instead of taking an entire copy of the data and metadata required to hold the entire snapshot, ZFS merely records the point in time and metadata of when the snapshot was created.

As more changes to the original filesystem are made, the size of the snapshot increases because more space is required to keep the record of the old blocks. Furthermore, if you create lots of snapshots, say one per day, and then delete the snapshots from earlier in the week, the size of the newer snapshots may also increase, as the changes that make up the newer state have to be included in the more recent snapshots, rather than being spread over the seven snapshots that make up the week.

The only issue, from a backup perspective, is that snapshots exist within the confines of the original filesystem. To get the snapshot out into a format that you can copy to another filesystem, tape, etc. you use the `zfs send` command to create a stream version of the snapshot.

For example, to write out the snapshot to a file:

```
root-shell> zfs send opt@snap1 >/backup/opt-snap1
```

Or tape:

```
root-shell> zfs send opt@snap1 >/dev/rmt/0
```

You can also write out the incremental changes between two snapshots using `zfs send`:

```
root-shell> zfs send opt@snap1 opt@snap2 >/backup/opt-changes
```

To recover a snapshot, you use `zfs recv` which applies the snapshot information either to a new filesystem, or to an existing one.

## 14.4.1. Using ZFS for Filesystem Replication



Because `zfs send` and `zfs recv` use streams to exchange data, you can use them to replicate information from one system to another by combining `zfs send`, `ssh`, and `zfs recv`.

For example, if a snapshot of the `opt` filesystem has been created and this needs to be copied to a new system or filesystem called `slavepool`. You would use the following command, combining the snapshot of `opt`, the transmission to the slave machine (using `ssh`), and the recovery of the snapshot on the slave using `zfs recv`:

```
root-shell> zfs send opt@snap1 | ssh mc@slave pfexec zfs recv -F slavepool
```

The first part, `zfs send opt@snap1`, streams the snapshot, the second, `ssh mc@slave`, and the third, `pfexec zfs recv -F slavepool`, receives the streamed snapshot data and writes it to `slavepool`. In this instance, I've specified the `-F` option which forces the snapshot data to be applied, and is therefore destructive. This is fine, as I'm creating the first version of my replicated filesystem.

On the slave machine, the replicated filesystem contains the exact same content:

```
root-shell> ls -al /slavepool/
total 23
drwxr-xr-x  6 root  root      7 Nov  8 09:13 ./
drwxr-xr-x 29 root  root     34 Nov  9 07:06 ../
drwxr-xr-x 31 root  bin     50 Jul 21 07:32 DTT/
drwxr-xr-x  4 root  bin     5 Jul 21 07:32 SUNWmlib/
drwxr-xr-x 14 root  sys    16 Nov  5 09:56 SUNWspro/
drwxrwxrwx 19 1000 1000   40 Nov  6 19:16 emacs-22.1/
```

Once a snapshot has been created, to synchronize the filesystem again, you need to create a new snapshot, and then use the incremental snapshot feature of `zfs send` to send the changes between the two snapshots to the slave machine again:

```
root-shell> zfs send -i opt@snapshot1 opt@snapshot2 | ssh mc@192.168.0.93 pfexec zfs recv slavepool
```

Without further modification, this operation will fail. The reason is that the filesystem on the slave machine can currently be modified, and you can't apply the incremental changes to a destination filesystem that has changed. It is the metadata that has changed. The metadata about the filesystem, like the last time it was accessed - in this case, it will have been our `ls` that caused the problem.

To prevent changes on the slave filesystem, you must set the filesystem on the slave to be read-only:

```
root-shell> zfs set readonly=on slavepool
```

Setting `readonly` means that you cannot change the filesystem on the slave by normal means, including the filesystem metadata. Operations that would normally update metadata (like our `ls`) will silently perform their function without attempting to update the filesystem state.

In essence, the slave filesystem is nothing but a static copy of the original filesystem. However, even when configured to be read-only, a filesystem can have snapshots applied to it. Now the filesystem is read only, re-run the initial copy:

```
root-shell> zfs send opt@snap1 | ssh mc@slave pfexec zfs recv -F slavepool
```

Now you can make changes to the original filesystem and replicate them to the slave.

## 14.4.2. Configuring MySQL for ZFS Replication

Configuring MySQL on the source filesystem is a case of creating the data on the filesystem that you will be replicating. The configuration file in the example below has been updated to use `/opt/mysql-data` as the data directory, and now I can initialize the tables:

```
root-shell> mysql_install_db --defaults-file=/etc/mysql/5.0/my.cnf --user=mysql
```

To synchronize the initial information, perform a new snapshot and then send an incremental snapshot to the slave using `zfs send`:

```
root-shell> zfs snapshot opt@snap2
root-shell> zfs send -i opt@snap1 opt@snap2 | ssh mc@192.168.0.93 pfexec zfs recv slavepool
```

Double check that the slave has the data by looking at the MySQL data directory on the `slavepool`:

```
root-shell> ls -al /slavepool/mysql-data/
```

Now we can start up MySQL, create some data, and then replicate the changes using `zfs send/ zfs recv` to the slave to synchronize the changes.

The rate at which you perform the synchronization is dependent on your application and environment. The limitation is the speed required to perform the snapshot and then to send the changes over the network.

To automate the process, you should create a script that performs the snapshot, send, and receive operation, and then use `cron` to synchronize the changes at set times or intervals. For automated operations, see [Tim Foster's zfs replication tool](#).

### 14.4.3. Handling MySQL Recovery with ZFS

When using ZFS replication to provide a constant copy of your data, you should ensure that you can recover your tables, either manually or automatically, in the event of a failure of the original system.

In the event of a failure, you should follow this sequence:

1. Stop the script on the master, if it is still up and running.
2. Set the slave filesystem to be read/write:

```
root-shell> zfs set readonly=off slavepool
```

3. Start up `mysqld` on the slave. If you are using `InnoDB`, `Falcon` or `Maria` you should get auto-recovery, if it is needed, to make sure the table data is correct, as shown here when I started up from our mid-INSERT snapshot:

```
InnoDB: The log sequence number in ibdata files does not match
InnoDB: the log sequence number in the ib_logfiles!
081109 15:59:59 InnoDB: Database was not shut down normally!
InnoDB: Starting crash recovery.
InnoDB: Reading tablespace information from the .ibd files...
InnoDB: Restoring possible half-written data pages from the doublewrite
InnoDB: buffer...
081109 16:00:03 InnoDB: Started; log sequence number 0 1142807951
081109 16:00:03 [Note] /slavepool/mysql-5.0.67-solaris10-i386/bin/mysqld: ready for connections.
Version: '5.0.67' socket: '/tmp/mysql.sock' port: 3306 MySQL Community Server (GPL)
```

On MyISAM, or other tables, you may need to run `REPAIR TABLE`, and you might even have lost some information. You should use a recovery-capable storage engine and a regular synchronization schedule to reduce the risk for significant data loss.

## 14.5. Using MySQL with `memcached`

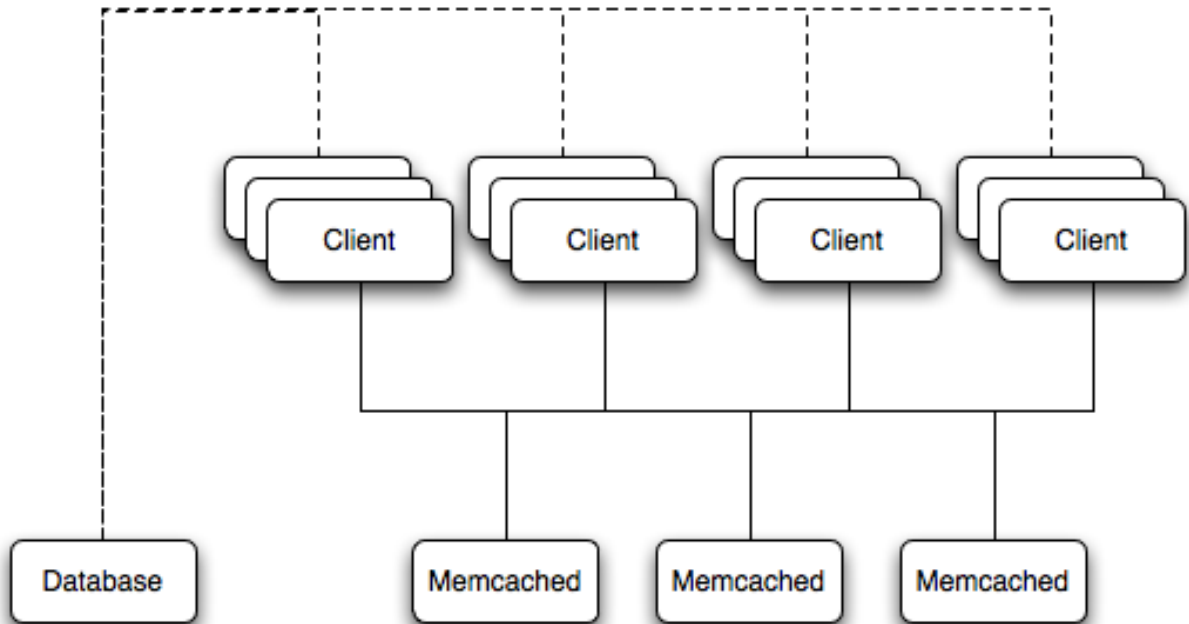
The largest problem with scalability within a typical environment is the speed with which you can access information. For frequently accessed information, using MySQL can be slow because each access of information requires execution of the SQL query and recovery of the information from the database. This also means that queries on tables that are locked or blocking may delay your query and reduce the speed of recovery of information.

`memcached` is a simple, yet highly-scalable key-based cache that stores data and objects wherever dedicated or spare RAM is available for very quick access by applications. To use, you run `memcached` on one or more hosts and then use the shared cache to store objects. Because each host's RAM is storing information, the access speed will be much faster than having to load the information from disk. This can provide a significant performance boost in retrieving data versus loading the data natively from a database. Also, because the cache is just a repository for information, you can use the cache to store any data, including complex structures that would normally require a significant amount of effort to create, but in a ready-to-use format, helping to reduce the load on your MySQL servers.

The typical usage environment is to modify your application so that information is read from the cache provided by `memcached`. If the information isn't in `memcached`, then the data is loaded from the MySQL database and written into the cache so that future requests for the same object benefit from the cached data.

For a typical deployment layout, see [Figure 14.4, "memcached Architecture Overview"](#).

### Figure 14.4. `memcached` Architecture Overview



In the example structure, any of the clients can contact one of the `memcached` servers to request a given key. Each client is configured to talk to all of the servers shown in the illustration. Within the client, when the request is made to store the information, the key used to reference the data is hashed and this hash is then used to select one of the `memcached` servers. The selection of the `memcached` server takes place on the client before the server is contacted, keeping the process lightweight.

The same algorithm is used again when a client requests the same key. The same key will generate the same hash, and the same `memcached` server will be selected as the source for the data. Using this method, the cached data is spread among all of the `memcached` servers, and the cached information is accessible from any client. The result is a distributed, memory-based, cache that can return information, particularly complex data and structures, much faster than natively reading the information from the database.

The data held within a `memcached` server is never stored on disk (only in RAM, which means there is no persistence of data), and the RAM cache is always populated from the backing store (a MySQL database). If a `memcached` server fails, the data can always be recovered from the MySQL database, albeit at a slower speed than loading the information from the cache.

## 14.5.1. Installing `memcached`

You can build and install `memcached` from the source code directly, or you can use an existing operating system package or installation.

### Installing `memcached` from a Binary Distribution

To install `memcached` on a RedHat, Fedora or CentOS host, use `yum`:

```
root-shell> yum install memcached
```

To install `memcached` on a Debian or Ubuntu host, use `apt-get`:

```
root-shell> apt-get install memcached
```

To install `memcached` on a Gentoo host, use `emerge`:

```
root-shell> emerge install memcached
```

To install on OpenSolaris, use the `pkg` command to install the `SUNWmemcached` package:

```
root-shell> pkg install SUNWmemcached
```

You may also find `memcached` in the Coolstack project. For more details, see <http://cooltools.sunsource.net/coolstack/>.

### Building `memcached` from Source

On other Unix-based platforms, including Solaris, AIX, HP-UX and Mac OS X, and Linux distributions not mentioned already, you will need to install from source. For Linux, make sure you have a 2.6-based kernel, which includes the improved `epoll` interface. For all platforms, ensure that you have `libevent` 1.1 or higher installed. You can obtain `libevent` from [libevent web page](#).

You can obtain the source for `memcached` from [memcached website](#).

To build `memcached`, follow these steps:

1. Extract the `memcached` source package:

```
shell> gunzip -c memcached-1.2.5.tar.gz | tar xf -
```

2. Change to the `memcached-1.2.5` directory:

```
shell> cd memcached-1.2.5
```

3. Run `configure`

```
shell> ./configure
```

Some additional options you may want to specify to `configure`:

- `--prefix`

If you want to specify a different installation directory, use the `--prefix` option:

```
shell> ./configure --prefix=/opt
```

The default is to use the `/usr/local` directory.

- `--with-libevent`

If you have installed `libevent` and `configure` cannot find the library, use the `--with-libevent` option to specify the location of the installed library.

- `--enable-64bit`

To build a 64-bit version of `memcached` (which will allow you to use a single instance with a large RAM allocation), use `--enable-64bit`.

- `--enable-threads`

To enable multi-threading support in `memcached`, which will improve the response times on servers with a heavy load, use `--enable-threads`. You must have support for the POSIX threads within your operating system to enable thread support. For more information on the threading support, see [Section 14.5.2.7, “memcached thread Support”](#).

- `--enable-dtrace`

`memcached` includes a range of DTrace threads that can be used to monitor and benchmark a `memcached` instance. For more information, see [Section 14.5.2.5, “Using memcached and DTrace”](#).

4. Run `make` to build `memcached`:

```
shell> make
```

5. Run `make install` to install `memcached`:

```
shell> make install
```

## 14.5.2. Using `memcached`

To start using `memcached`, you must start the `memcached` service on one or more servers. Running `memcached` sets up the server, allocates the memory and starts listening for connections from clients.

### ■ Note

You do not need to be privileged user (`root`) to run `memcached` unless you want to listen on one of the privileged TCP/IP ports (below 1024). You must, however, use a user that has not had their memory limits restricted using `setrlimit` or similar.

To start the server, run `memcached` as a non-privileged (i.e. non-root) user:

```
shell> memcached
```

By default, `memcached` uses the following settings:

- Memory allocation of 64MB
- Listens for connections on all network interfaces, using port 11211
- Supports a maximum of 1024 simultaneous connections

Typically, you would specify the full combination of options that you want when starting `memcached`, and normally provide a startup script to handle the initialization of `memcached`. For example, the following line starts `memcached` with a maximum of 1024MB RAM for the cache, listening on port 11211 on the IP address 192.168.0.110, running as a background daemon:

```
shell> memcached -d -m 1024 -p 11211 -l 192.168.0.110
```

To ensure that `memcached` is started up on boot you should check the init script and configuration parameters. On OpenSolaris, `memcached` is controlled by SMF. You can enable it by using:

```
root-shell> svcadm enable memcached
```

`memcached` supports the following options:

- `-u user`

If you start `memcached` as `root`, use the `-u` option to specify the user for executing `memcached`:

```
shell> memcached -u memcache
```

- `-m memory`

Set the amount of memory allocated to `memcached` for object storage. Default is 64MB.

To increase the amount of memory allocated for the cache, use the `-m` option to specify the amount of RAM to be allocated (in megabytes). The more RAM you allocate, the more data you can store and therefore the more effective your cache will be.

## Warning

Do not specify a memory allocation larger than your available RAM. If you specify too large a value, then some RAM allocated for `memcached` will be using swap space, and not physical RAM. This may lead to delays when storing and retrieving values, because data will be swapped to disk, instead of storing the data directly in RAM.

You can use the output of the `vmstat` command to get the free memory, as shown in `free` column:

```
shell> vmstat
kthr      memory          page        disk          faults         cpu
r  b  w    swap free  re  mf  pi  po  fr  de  sr  sl  s2  --  --   in  sy   cs us  sy id
0  0  0  5170504 3450392 2   7   2  0  0  0  4  0  0  0  0  296  54  199  0  0  100
```

For example, to allocate 3GB of RAM:

```
shell> memcached -m 3072
```

On 32-bit x86 systems where you are using PAE to access memory above the 4GB limit, you will be unable to allocate RAM beyond the maximum process size. You can get around this by running multiple instances of `memcached`, each listening on a different port:

```
shell> memcached -m 1024 -p11211
shell> memcached -m 1024 -p11212
shell> memcached -m 1024 -p11213
```

- `-l interface`

Specify a network interface/address to listen for connections. The default is to listen on all available address (`INADDR_ANY`).

```
shell> memcached -l 192.168.0.110
```

Support for IPv6 address support was added in `memcached` 1.2.5.

- `-p port`

Specify the TCP port to use for connections. Default is 18080.

```
shell> memcached -p 18080
```

- `-U port`

Specify the UDP port to use for connections. Default is 0 (off).

```
shell> memcached -U 18080
```

- `-s socket`

Specify a Unix socket to listen on.

If you are running `memcached` on the same server as the clients, you can disable the network interface and use a local UNIX socket using the `-s` option:

```
shell> memcached -s /tmp/memcached
```

Using a UNIX socket automatically disables network support, and saves network ports (allowing more ports to be used by your web server or other process).

- `-a mask`

Specify the access mask to be used for the Unix socket, in octal. Default is 0700.

- `-c connections`

Specify the maximum number of simultaneous connections to the `memcached` service. The default is 1024.

```
shell> memcached -c 2048
```

You should use this option, either to reduce the number of connections (to prevent overloading `memcached` service) or to increase the number to make more effective use of the server running `memcached` server.

- `-t threads`

Specify the number of threads to use when processing incoming requests.

By default, `memcached` is configured to use 4 concurrent threads. The threading improves the performance of storing and retrieving data in the cache, using a locking system to prevent different threads overwriting or updating the same values. You may want to increase or decrease the number of threads, use the `-t` option:

```
shell> memcached -t 8
```

- `-d`

Run `memcached` as a daemon (background) process:

```
shell> memcached -d
```

- `-r`

Maximize the size of the core file limit. In the event of a failure, this will attempt to dump the entire memory space to disk as a core file, up to any limits imposed by `setrlimit`.

- `-M`

Return an error to the client when the memory has been exhausted. This replaces the normal behavior of removing older items

from the cache to make way for new items.

- `-k`

Lock down all paged memory.

#### Note

There is a user-level limit on how much memory you may lock. Trying to allocate more than the available memory will fail. You can set the limit for the user you started the daemon with (not for the `-u user` user) within the shell by using `ulimit -S -l NUM_KB`

- `-v`

Verbose mode. Prints errors and warnings while executing the main event loop.

- `-vv`

Very verbose mode. In addition to information printed by `-v`, also prints each client command and the response.

- `-h`

Print the help message and exit.

- `-i`

Print the `memcached` and `libevent` license.

- `-b`

Run a managed instance.

- `-P pidfile`

Save the process ID of the `memcached` instance into `file`.

- `-f`

Set the chunk size growth factor. When allocating new memory chunks, the allocated size of new chunks will be determined by multiple the default slab size by this factor.

- `-n bytes`

The minimum space allocated for the key+value+flags information. The default is 48 bytes.

- `-L`

On systems that support large memory pages, enables large memory page use. Using large memory pages enables `memcached` to allocate the item cache in one large chunk, which can improve the performance by reducing the number misses when accessing memory.

### 14.5.2.1. `memcached` Deployment

When using `memcached` you can use a number of different potential deployment strategies and topologies. The exact strategy you use will depend on your application and environment. When developing a system for deploying `memcached` within your system, you should keep in mind the following points:

- `memcached` is only a caching mechanism. It shouldn't be used to store information that you cannot otherwise afford to lose and then load from a different location.
- There is no security built into the `memcached` protocol. At a minimum you should make sure that the servers running `memcached` are only accessible from inside your network, and that the network ports being used are blocked (using a firewall or similar). If the information on the `memcached` servers that is being stored is any sensitive, then encrypt the information before storing it in `memcached`.
- `memcached` does not provide any sort of failover. Because there is no communication between different `memcached` instances. If an instance fails, your application must be capable of removing it from the list, reloading the data and then writing data to another `memcached` instance.

- Latency between the clients and the `memcached` can be a problem if you are using different physical machines for these tasks. If you find that the latency is a problem, move the `memcached` instances to be on the clients.
- Key length is determined by the `memcached` server. The default maximum key size is 250 bytes.
- Using a single `memcached` instance, especially for multiple clients, is generally a bad idea as it introduces a single point of failure. Instead provide at least two `memcached` instances so that a failure can be handled appropriately. If possible, you should create as many `memcached` nodes as possible. When adding and removing `memcached` instances from a pool, the hashing and distribution of key/value pairs may be affected. For information on how to avoid problems, see [Section 14.5.2.4, “memcached Distribution Types”](#).

### 14.5.2.2. Using namespaces

The `memcached` cache is a very simple massive key/value storage system, and as such there is no way of compartmentalizing data automatically into different sections. For example, if you are storing information by the unique ID returned from a MySQL database, then storing the data from two different tables will run into issues because the same ID will probably be valid in both tables.

Some interfaces provide an automated mechanism for creating *namespaces* when storing information into the cache. In practice, these namespaces are merely a prefix before a given ID that is applied every time a value is stored or retrieve from the cache.

You can implement the same basic principle by using keys that describe the object and the unique identifier within the key that you supply when the object is stored. For example, when storing user data, prefix the ID of the user with `user:` or `user-`.

#### Note

Using namespaces or prefixes only controls the keys stored/retrieved. There is no security within `memcached`, and therefore no way to enforce that a particular client only accesses keys with a particular namespace. Namespaces are only useful as a method of identifying data and preventing corruption of key/value pairs.

### 14.5.2.3. Data Expiry

There are two types of data expiry within a `memcached` instance. The first type is applied at the point when you store a new key/value pair into the `memcached` instance. If there is not enough space within a suitable slab to store the value, then an existing least recently used (LRU) object is removed (evicted) from the cache to make room for the new item.

The LRU algorithm ensures that the object that is removed is one that is either no longer in active use or that was used so long ago that its data is potentially out of date or of little value. However, in a system where the memory allocated to `memcached` is smaller than the number of regularly used objects required in the cache you will see a lot of expired items being removed from the cache even though they are in active use. You use the statistics mechanism to get a better idea of the level of evictions (expired objects). For more information, see [Section 14.5.4, “Getting memcached Statistics”](#).

You can change this eviction behavior by setting the `-M` command-line option when starting `memcached`. This option forces an error to be returned when the memory has been exhausted, instead of automatically evicting older data.

The second type of expiry system is an explicit mechanism that you can set when a key/value pair is inserted into the cache, or when deleting an item from the cache. Using an expiration time can be a useful way of ensuring that the data in the cache is up to date and in line with your application needs and requirements.

A typical scenario for explicitly setting the expiry time might include caching session data for a user when accessing a website. `memcached` uses a lazy expiry mechanism where the explicit expiry time that has been set is compared with the current time when the object is requested. Only objects that have not expired are returned.

You can also set the expiry time when explicitly deleting an object from the cache. In this case, the expiry time is really a timeout and indicates the period when any attempts to set the value for a given key are rejected.

### 14.5.2.4. memcached Distribution Types

The `memcached` client interface supports a number of different distribution algorithms that are used in multi-server configurations to determine which host should be used when setting or getting data from a given `memcached` instance. When you get or set a value, a hash is constructed from the supplied key and then used to select a host from the list of configured servers. Because the hashing mechanism uses the supplied key as the basis for the hash, the selected server will be the same during both set and get operations.

For example, if you have three servers, A, B, and C, and you set the value `myid`, then the `memcached` client will create a hash based on the ID and select server B. When the same key is requested, the same hash is generated, and the same server, B, will be selected to request the value.

Because the hashing mechanism is part of the client interface, not the server interface, the hashing process and selection is very fast. By performing the hashing on the client, it also means that if you want to access the same data by the same ID from the same



list of servers but from different client interfaces, you must use the same or compatible hashing mechanisms. If you do not use the same hashing mechanism then the same data may be recorded on different servers by different interfaces, both wasting space on your `memcached` and leading to potential differences in the information.

### Note

One way to use a multi-interface compatible hashing mechanism is to use the `libmemcached` library and the associated interfaces. Because the interfaces for the different languages (including C, Ruby, Perl and Python) are using the same client library interface, they will always generate the same hash code from the ID.

One issue with the client-side hashing mechanism is that when using multiple servers and extending or shrinking the list of servers that you have configured for use with `memcached`, the resulting hash may change. For example, if you have servers A, B, and C; the computed hash for key `myid` may equate to server B. If you add another server, D, into this list, then computing the hash for the same ID again may result in the selection of server D for that key.

This means that servers B and D both contain the information for key `myid`, but there may be differences between the data held by the two instances. A more significant problem is that you will get a much higher number of cache-misses when retrieving data as the addition of a new server will change the distribution of keys, and this will in turn require rebuilding the cached data on the `memcached` instances and require an increase in database reads.

For this reason, there are two common types of hashing algorithm, *consistent* and *modula*.

With *consistent* hashing algorithms, the same key when applied to a list of servers will always use the same server to store or retrieve the keys, even if the list of configured servers changes. This means that you can add and remove servers from the configure list and always use the same server for a given key. There are two types of consistent hashing algorithms available, Ketama and Wheel. Both types are supported by `libmemcached`, and implementations are available for PHP and Java.

There are some limitations with any consistent hashing algorithm. When adding servers to an existing list of configured servers, then keys will be distributed to the new servers as part of the normal distribution. When removing servers from the list, the keys will be re-allocated to another server within the list, which will mean that the cache will need to be re-populated with the information. Also, a consistent hashing algorithm does not resolve the issue where you want consistent selection of a server across multiple clients, but where each client contains a different list of servers. The consistency is enforced only within a single client.

With a *modula* hashing algorithm, the client will select a server by first computing the hash and then choosing a server from the list of configured servers. As the list of servers changes, so the server selected when using a modula hashing algorithm will also change. The result is the behavior described above; changes to the list of servers will mean different servers are selected when retrieving data leading to cache misses and increase in database load as the cache is re-seeded with information.

If you use only a single `memcached` instance for each client, or your list of `memcached` servers configured for a client never changes, then the selection of a hashing algorithm is irrelevant, as you will not notice the effect.

If you change your servers regularly, or you use a common set of servers that are shared among a large number of clients, then using a consistent hashing algorithm should help to ensure that your cache data is not duplicated and the data is evenly distributed.

## 14.5.2.5. Using `memcached` and DTrace

`memcached` includes a number of different DTrace probes that can be used to monitor the operation of the server. The probes included can monitor individual connections, slab allocations, and modifications to the hash table when a key/value pair is added, updated, or removed.

For more information on DTrace and writing DTrace scripts, read the [DTrace User Guide](#).

Support for DTrace probes was added to `memcached` 1.2.6 includes a number of DTrace probes that can be used to help monitor your application. DTrace is supported on Solaris 10, OpenSolaris, Mac OS X 10.5 and FreeBSD. To enable the DTrace probes in `memcached`, you should build from source and use the `--enable-dtrace` option. For more information, see [Section 14.5.1, "Installing memcached"](#).

The probes supported by `memcached` are:

- `conn-allocate(connid)`

Fired when a connection object is allocated from the connection pool.

- `connid` — the connection id
- `conn-release(connid)`

Fired when a connection object is released back to the connection pool.

Arguments:

- `connid` — the connection id
- `conn-create(ptr)`

Fired when a new connection object is being created (i.e. there are no free connection objects in the connection pool).

Arguments:

- `ptr` — pointer to the connection object
- `conn-destroy(ptr)`

Fired when a connection object is being destroyed.

Arguments:

- `ptr` — pointer to the connection object
- `conn-dispatch(connid, threadid)`

Fired when a connection is dispatched from the main or connection-management thread to a worker thread.

Arguments:

- `connid` — the connection id
- `threadid` — the thread id
- `slabs-allocate(size, slabclass, slabsize, ptr)`

Allocate memory from the slab allocator

Arguments:

- `size` — the requested size
- `slabclass` — the allocation will be fulfilled in this class
- `slabsize` — the size of each item in this class
- `ptr` — pointer to allocated memory
- `slabs-allocate-failed(size, slabclass)`

Failed to allocate memory (out of memory)

Arguments:

- `size` — the requested size
- `slabclass` — the class that failed to fulfill the request
- `slabs-slabclass-allocate(slabclass)`

Fired when a slab class needs more space

Arguments:

- `slabclass` — class that needs more memory
- `slabs-slabclass-allocate-failed(slabclass)`

Failed to allocate memory (out of memory)

Arguments:

- `slabclass` — the class that failed grab more memory
- `slabs-free(size, slabclass, ptr)`

Release memory

Arguments:

- `size` — the size of the memory
- `slabclass` — the class the memory belongs to
- `ptr` — pointer to the memory to release
- `assoc-find(key, depth)`

Fired when the when we have searched the hash table for a named key. These two elements provide an insight in how well the hash function operates. Traversals are a sign of a less optimal function, wasting cpu capacity.

Arguments:

- `key` — the key searched for
- `depth` — the depth in the list of hash table
- `assoc-insert(key, nokeys)`

Fired when a new item has been inserted.

Arguments:

- `key` — the key just inserted
- `nokeys` — the total number of keys currently being stored, including the key for which insert was called.
- `assoc-delete(key, nokeys)`

Fired when a new item has been removed.

Arguments:

- `key` — the key just deleted
- `nokeys` — the total number of keys currently being stored, excluding the key for which delete was called.
- `item-link(key, size)`

Fired when an item is being linked in the cache

Arguments:

- `key` — the items key
- `size` — the size of the data
- `item-unlink(key, size)`

Fired when an item is being deleted

Arguments:

- `key` — the items key
- `size` — the size of the data
- `item-remove(key, size)`

Fired when the refcount for an item is reduced

Arguments:

- `key` — the items key
- `size` — the size of the data

- `item-update(key, size)`

Fired when the "last referenced" time is updated

Arguments:

- `key` — the items key
- `size` — the size of the data

- `item-replace(oldkey, oldsize, newkey, newsize)`

Fired when an item is being replaced with another item

Arguments:

- `oldkey` — the key of the item to replace
- `oldsize` — the size of the old item
- `newkey` — the key of the new item
- `newsiz` — the size of the new item

- `process-command-start(connid, request, size)`

Fired when the processing of a command starts

Arguments:

- `connid` — the connection id
- `request` — the incoming request
- `size` — the size of the request

- `process-command-end(connid, response, size)`

Fired when the processing of a command is done

Arguments:

- `connid` — the connection id
- `response` — the response to send back to the client
- `size` — the size of the response

- `command-get(connid, key, size)`

Fired for a get-command

Arguments:

- `connid` — connection id
- `key` — requested key
- `size` — size of the key's data (or -1 if not found)

- `command-gets(connid, key, size, casid)`

Fired for a gets command

Arguments:

- `connid` — connection id
- `key` — requested key
- `size` — size of the key's data (or -1 if not found)

- `casid` — the casid for the item
- `command-add(connid, key, size)`

Fired for a add-command

Arguments:

  - `connid` — connection id
  - `key` — requested key
  - `size` — the new size of the key's data (or -1 if not found)
- `command-set(connid, key, size)`

Fired for a set-command

Arguments:

  - `connid` — connection id
  - `key` — requested key
  - `size` — the new size of the key's data (or -1 if not found)
- `command-replace(connid, key, size)`

Fired for a replace-command

Arguments:

  - `connid` — connection id
  - `key` — requested key
  - `size` — the new size of the key's data (or -1 if not found)
- `command-prepend(connid, key, size)`

Fired for a prepend-command

Arguments:

  - `connid` — connection id
  - `key` — requested key
  - `size` — the new size of the key's data (or -1 if not found)
- `command-append(connid, key, size)`

Fired for a append-command

Arguments:

  - `connid` — connection id
  - `key` — requested key
  - `size` — the new size of the key's data (or -1 if not found)
- `command-cas(connid, key, size, casid)`

Fired for a cas-command

Arguments:

  - `connid` — connection id
  - `key` — requested key

- `size` — size of the key's data (or -1 if not found)
- `casid` — the cas id requested
- `command-incr(connid, key, val)`

Fired for incr command

Arguments:

- `connid` — connection id
- `key` — the requested key
- `val` — the new value
- `command-decr(connid, key, val)`

Fired for decr command

Arguments:

- `connid` — connection id
- `key` — the requested key
- `val` — the new value
- `command-delete(connid, key, exptime)`

Fired for a delete command

Arguments:

- `connid` — connection id
- `key` — the requested key
- `exptime` — the expiry time

### 14.5.2.6. Memory allocation within `memcached`

When you first start `memcached`, the memory that you have configured is not automatically allocated. Instead, `memcached` only starts allocating and reserving physical memory once you start saving information into the cache.

When you start to store data into the cache, `memcached` does not allocate the memory for the data on an item by item basis. Instead, a slab allocation is used to optimize memory usage and prevent memory fragmentation when information expires from the cache.

With slab allocation, memory is reserved in blocks of 1MB. The slab is divided up into a number of blocks of equal size. When you try to store a value into the cache, `memcached` checks the size of the value that you are adding to the cache and determines which slab contains the right size allocation for the item. If a slab with the item size already exists, the item is written to the block within the slab.

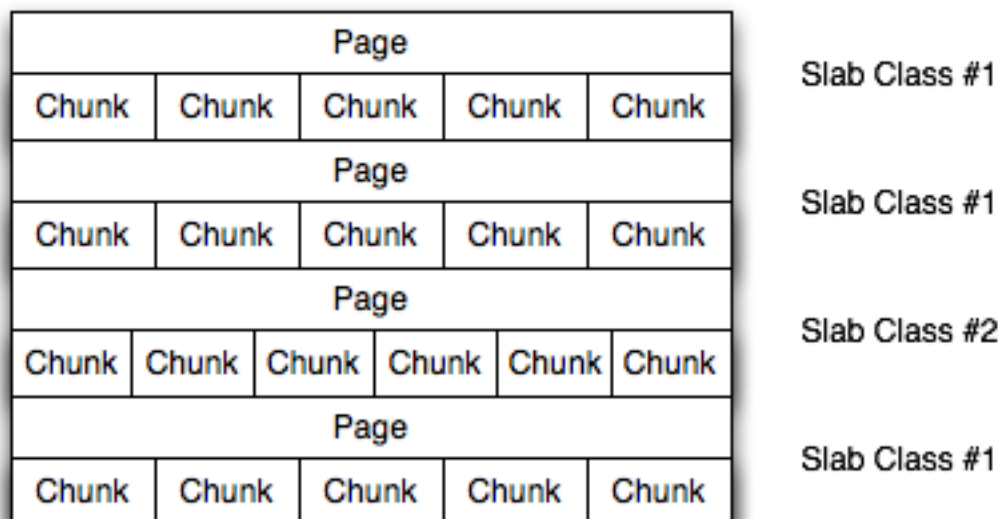
If the new item is bigger than the size of any existing blocks, then a new slab is created, divided up into blocks of a suitable size. If an existing slab with the right block size already exists, but there are no free blocks, a new slab is created. If you update an existing item with data that is larger than the existing block allocation for that key, then the key is re-allocated into a suitable slab.

For example, the default size for the smallest block is 88 bytes (40 bytes of value, and the default 48 bytes for the key and flag data). If the size of the first item you store into the cache is less than 40 bytes, then a slab with a block size of 88 bytes is created and the value stored.

If the size of the data that you want to store is larger than this value, then the block size is increased by the chunk size factor until a block size large enough to hold the value is determined. The block size is always a function of the scale factor, rounded up to a block size which is exactly divisible into the chunk size.

For a sample of the structure, see [Figure 14.5, “Memory Allocation in `memcached`”](#).

#### Figure 14.5. Memory Allocation in `memcached`



The result is that you have multiple pages allocated within the range of memory allocated to `memcached`. Each page is 1MB in size (by default), and will be split into a different number of chunks, according to the chunk size required to store the key/value pairs. Each instance will have multiple pages allocated, and a page will always be created when a new item needs to be created requiring a chunk of a particular size. A slab may consist of multiple pages, and each page within a slab will contain an equal number of chunks.

The chunk size of a new slab is determined by the base chunk size combined with the chunk size growth factor. For example, if the initial chunks are 104 bytes in size, and the default chunk size growth factor is used (1.25), then the next chunk size allocated would be the best power of 2 fit for  $104 * 1.25$ , or 136 bytes.

Allocating the pages in this way ensures that memory does not get fragmented. However, depending on the distribution of the objects that you want to store, it may lead to an inefficient distribution of the slabs and chunks if you have significantly different sized items. For example, having a relatively small number of items within each chunk size may waste a lot of memory with just few chunks in each allocated page.

You can tune the growth factor to reduce this effect by using the `-f` command line option. This will adapt the growth factor applied to make more effective use of the chunks and slabs allocated. For information on how to determine the current slab allocation statistics, see [Section 14.5.4.2, “memcached Slabs Statistics”](#).

If your operating system supports it, you can also start `memcached` with the `-L` command line option. With this option enabled, it will preallocate all the memory during startup using large memory pages. This can improve performance by reducing the number of misses in the CPU memory cache.

### 14.5.2.7. `memcached` thread Support

If you enable the thread implementation within when building `memcached` from source, then `memcached` will use multiple threads in addition to the `libevent` system to handle requests.

When enabled, the threading implementation operates as follows:

- Threading is handled by wrapping functions within the code to provide basic protection from updating the same global structures at the same time.
- Each thread uses its own instance of the `libevent` to help improve performance.
- TCP/IP connections are handled with a single thread listening on the TCP/IP socket. Each connection is then distribution to one of the active threads on a simple round-robin basis. Each connection then operates solely within this thread while the connection remains open.
- For UDP connections, all the threads listen to a single UDP socket for incoming requests. Threads that are not currently dealing with another request ignore the incoming packet. One of the remaining, non-busy, threads will read the request and send the response. This implementation can lead to increased CPU load as threads will wake from sleep to potentially process the request.

Using threads can increase the performance on servers that have multiple CPU cores available, as the requests to update the hash table can be spread between the individual threads. However, because of the locking mechanism employed you may want to experiment with different thread values to achieve the best performance based on the number and type of requests within your given workload.

### 14.5.3. `memcached` Interfaces

A number of interfaces from different languages exist for interacting with `memcached` servers and storing and retrieving information. Interfaces for the most common language platforms including Perl, PHP, Python, Ruby, C and Java.

Data stored into a `memcached` server is referred to by a single string (the key), with storage into the cache and retrieval from the cache using the key as the reference. The cache therefore operates like a large associative array or hash. It is not possible to structure or otherwise organize the information stored in the cache. If you want to store information in a structured way, you must use 'formatted' keys.

The following tips may be useful to you when using `memcached`:

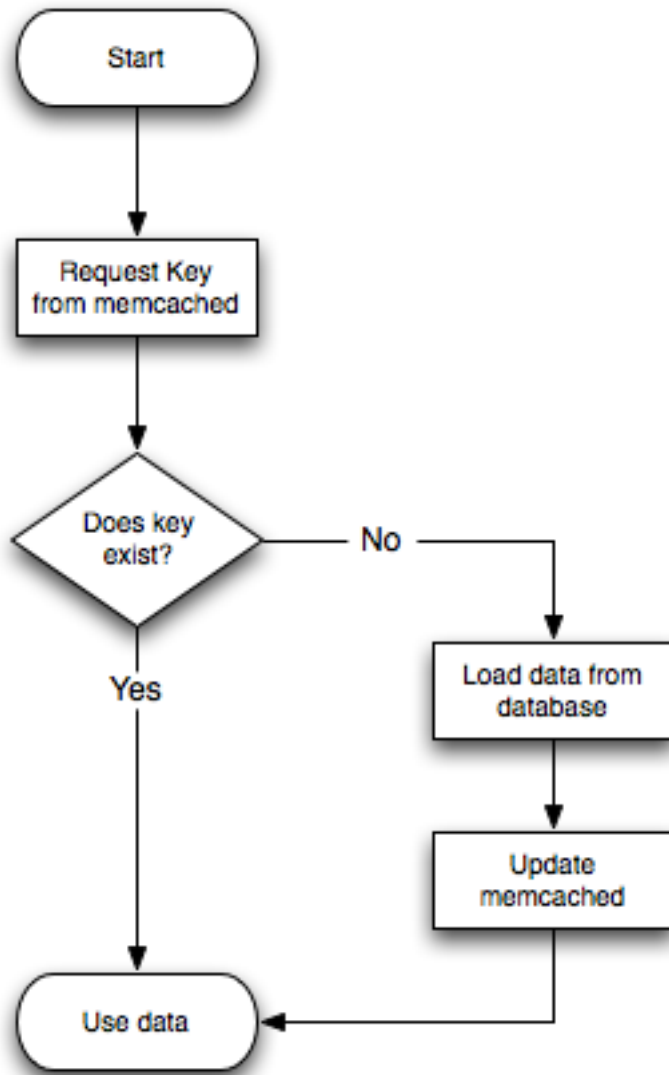
The general sequence for using `memcached` in any language as a caching solution is as follows:

1. Request the item from the cache.
2. If the item exists, use the item data.
3. If the item does not exist, load the data from MySQL, and store the value into the cache. This means the value will be available to the next client that requests it from the cache.

For a flow diagram of this sequence, see [Figure 14.6, "Typical `memcached` Application Flowchart"](#).

#### **Figure 14.6. Typical `memcached` Application Flowchart**





The interface to `memcached` supports the following methods for storing and retrieving information in the cache, and these are consistent across all the different APIs, even though the language specific mechanics may be different:

- `get(key)` — retrieves information from the cache. Returns the value if it exists, or `NULL`, `nil`, or `undefined` or the closest equivalent in the corresponding language, if the specified key does not exist.
- `set(key, value [, expiry])` — sets the key in the cache to the specified value. Note that this will either update an existing key if it already exists, or add a new key/value pair if the key doesn't exist. If the expiry time is specified, then the key will expire (be deleted) when the expiry time is reached. The time should be specified in seconds, and is taken as a relative time if the value is less than 30 days ( $30*24*60*60$ ), or an absolute time (epoch) if larger than this value.
- `add(key, value [, expiry])` — adds the key to the cache, if the specified key doesn't already exist.
- `replace(key, value [, expiry])` — replace the `value` of the specified `key`, only if the key already exists.
- `delete(key [, time])` — Deletes the `key` from the cache. If you supply a `time`, then adding a value with the specified `key` is blocked for the specified period.
- `incr(key [, value])` — Increment the specified `key` by one or the specified `value`.
- `decr(key [, value])` — Decrement the specified `key` by one or the specified `value`.
- `flush_all` — invalidates (or expires) all the current items in the cache. Technically they will still exist (they are not deleted), but they will be silently destroyed the next time you try to access them.

In all implementations, most or all of these functions are duplicated through the corresponding native language interface.

For all languages and interfaces, you should use `memcached` to store full items, rather than simply caching single rows of information from the database. For example, when displaying a record about an object (invoice, user history, or blog post), all the data for the associated entry should be loaded from the database, and compiled into the internal structure that would normally be required by the application. You then save the complete object into the cache.

Data cannot be stored directly, it needs to be serialized, and most interfaces will serialize the data for you. Perl uses `Storable`, PHP uses `serialize`, Python uses `cPickle` (or `Pickle`) and Java uses the `Serializable` interface. In most cases, the serialization interface used is customizable. If you want to share data stored in `memcached` instances between different language interfaces, consider using a common serialization solution such as JSON (Javascript Object Notation).

### 14.5.3.1. Using `libmemcached`

The `libmemcached` library provides both C and C++ interfaces to `memcached` and is also the basis for a number of different additional API implementations, including Perl, Python and Ruby. Understanding the core `libmemcached` functions can help when using these other interfaces.

The C library is the most comprehensive interface library for `memcached` and provides a wealth of functions and operational systems not always exposed in the other interfaces not based on the `libmemcached` library.

The different functions can be divided up according to their basic operation. In addition to functions that interface to the core API, there are a number of utility functions that provide extended functionality, such as appending and prepending data.

To build and install `libmemcached`, download the `libmemcached` package, run configure, and then build and install:

```
shell> tar xjf libmemcached-0.21.tar.gz
shell> cd libmemcached-0.21
shell> ./configure
shell> make
shell> make install
```

On many Linux operating systems, you can install the corresponding `libmemcached` package through the usual `yum`, `apt-get` or similar commands. On OpenSolaris, use `pkg` to install the `SUNWlibmemcached` package.

To build an application that uses the library, you need to first set the list of servers. You can do this either by directly manipulating the servers configured within the main `memcached_st` structure, or by separately populating a list of servers, and then adding this list to the `memcached_st` structure. The latter method is used in the following example. Once the server list has been set, you can call the functions to store or retrieve data. A simple application for setting a preset value to localhost is provided here:

```
#include <stdio.h>
#include <string.h>
#include <unistd.h>
#include <libmemcached/memcached.h>

int main(int argc, char *argv[])
{
    memcached_server_st *servers = NULL;
    memcached_st *memc;
    memcached_return rc;
    char *key= "keystring";
    char *value= "keyvalue";

    memcached_server_st *memcached_servers_parse (char *server_strings);
    memc= memcached_create(NULL);

    servers= memcached_server_list_append(servers, "localhost", 11211, &rc);
    rc= memcached_server_push(memc, servers);

    if (rc == MEMCACHED_SUCCESS)
        fprintf(stderr, "Added server successfully\n");
    else
        fprintf(stderr, "Couldn't add server: %s\n", memcached_strerror(memc, rc));

    rc= memcached_set(memc, key, strlen(key), value, strlen(value), (time_t)0, (uint32_t)0);

    if (rc == MEMCACHED_SUCCESS)
        fprintf(stderr, "Key stored successfully\n");
    else
        fprintf(stderr, "Couldn't store key: %s\n", memcached_strerror(memc, rc));

    return 0;
}
```

You can test the success of an operation by using the return value, or populated result code, for a given function. The value will always be set to `MEMCACHED_SUCCESS` if the operation succeeded. In the event of a failure, use the `memcached_strerror()` function to translate the result code into a printable string.

To build the application, you must specify the `memcached` library:

```
shell> gcc -o memc_basic memc_basic.c -lmemcached
```

Running the above sample application, after starting a `memcached` server, should return a success message:

```
shell> memc_basic
Added server successfully
Key stored successfully
```

### 14.5.3.1.1. libmemcached Base Functions

The base `libmemcached` functions allow you to create, destroy and clone the main `memcached_st` structure that is used to interface to the `memcached` servers. The main functions are defined below:

```
memcached_st *memcached_create (memcached_st *ptr);
```

Creates a new `memcached_st` structure for use with the other `libmemcached` API functions. You can supply an existing, static, `memcached_st` structure, or `NULL` to have a new structured allocated. Returns a pointer to the created structure, or `NULL` on failure.

```
void memcached_free (memcached_st *ptr);
```

Free the structure and memory allocated to a previously created `memcached_st` structure.

```
memcached_st *memcached_clone(memcached_st *clone, memcached_st *source);
```

Clone an existing `memcached` structure from the specified `source`, copying the defaults and list of servers defined in the structure.

### 14.5.3.1.2. libmemcached Server Functions

The `libmemcached` API uses a list of servers, stored within the `memcached_server_st` structure, to act as the list of servers used by the rest of the functions. To use `memcached`, you first create the server list, and then apply the list of servers to a valid `libmemcached` object.

Because the list of servers, and the list of servers within an active `libmemcached` object can be manipulated separately, you can update and manage server lists while an active `libmemcached` interface is running.

The functions for manipulating the list of servers within a `memcached_st` structure are given below:

```
memcached_return
memcached_server_add (memcached_st *ptr,
                     char *hostname,
                     unsigned int port);
```

Add a server, using the given `hostname` and `port` into the `memcached_st` structure given in `ptr`.

```
memcached_return
memcached_server_add_unix_socket (memcached_st *ptr,
                                 char *socket);
```

Add a Unix socket to the list of servers configured in the `memcached_st` structure.

```
unsigned int memcached_server_count (memcached_st *ptr);
```

Return a count of the number of configured servers within the `memcached_st` structure.

```
memcached_server_st *
memcached_server_list (memcached_st *ptr);
```

Returns an array of all the defined hosts within a `memcached_st` structure.

```
memcached_return
memcached_server_push (memcached_st *ptr,
                      memcached_server_st *list);
```

Pushes an existing list of servers onto list of servers configured for a current `memcached_st` structure. This adds servers to the end of the existing list, and duplicates are not checked.

The `memcached_server_st` structure can be used to create a list of `memcached` servers which can then be applied individu-

ally to `memcached_st` structures.

```
memcached_server_st *
    memcached_server_list_append (memcached_server_st *ptr,
                                  char *hostname,
                                  unsigned int port,
                                  memcached_return *error);
```

Add a server, with `hostname` and `port`, to the server list in `ptr`. The result code is handled by the `error` argument, which should point to an existing `memcached_return` variable. The function returns a pointer to the returned list.

```
unsigned int memcached_server_list_count (memcached_server_st *ptr);
```

Return the number of the servers in the server list.

```
void memcached_server_list_free (memcached_server_st *ptr);
```

Free up the memory associated with a server list.

```
memcached_server_st *memcached_servers_parse (char *server_strings);
```

Parses a string containing a list of servers, where individual servers are separated by a comma and/or space, and where individual servers are of the form `server[:port]`. The return value is a server list structure.

### 14.5.3.1.3. libmemcached Set Functions

The set related functions within `libmemcached` provide the same functionality as the core functions supported by the `memcached` protocol. The full definition for the different functions is the same for all the base functions (add, replace, prepend, append). For example, the function definition for `memcached_set()` is:

```
memcached_return
    memcached_set (memcached_st *ptr,
                  const char *key,
                  size_t key_length,
                  const char *value,
                  size_t value_length,
                  time_t expiration,
                  uint32_t flags);
```

The `ptr` is the `memcached_st` structure. The `key` and `key_length` define the key name and length, and `value` and `value_length` the corresponding value and length. You can also set the expiration and optional flags. For more information, see [Section 14.5.3.1.5, “libmemcached Behaviors”](#).

The following table outlines the remainder of the set-related functions.

libmemcached Function	Equivalent to
<code>memcached_set(memc, key, key_length, value, value_length, expiration, flags)</code>	Generic <code>set()</code> operation.
<code>memcached_add(memc, key, key_length, value, value_length, expiration, flags)</code>	Generic <code>add()</code> function.
<code>memcached_replace(memc, key, key_length, value, value_length, expiration, flags)</code>	Generic <code>replace()</code> .
<code>memcached_prepend(memc, key, key_length, value, value_length, expiration, flags)</code>	Prepends the specified <code>value</code> before the current value of the specified <code>key</code> .
<code>memcached_append(memc, key, key_length, value, value_length, expiration, flags)</code>	Appends the specified <code>value</code> after the current value of the specified <code>key</code> .
<code>memcached_cas(memc, key, key_length, value, value_length, expiration, flags, cas)</code>	Overwrites the data for a given key as long as the corresponding <code>cas</code> value is still the same within the server.
<code>memcached_set_by_key(memc, master_key, master_key_length, key, key_length, value, value_length, expiration, flags)</code>	Similar to the generic <code>set()</code> , but has the option of an additional master key that can be used to identify an individual server.
<code>memcached_add_by_key(memc, master_key, master_key_length, key, key_length, value, value_length, expiration, flags)</code>	Similar to the generic <code>add()</code> , but has the option of an additional master key that can be used to identify an individual server.
<code>memcached_replace_by_key(memc, master_key, master_key_length, key, key_length, value, value_length, expiration, flags)</code>	Similar to the generic <code>replace()</code> , but has the option of an additional master key that can be used to identify an individual server.

libmemcached Function	Equivalent to
<code>memcached_prepend_by_key(memc, master_key, master_key_length, key, key_length, value, value_length, expiration, flags)</code>	Similar to the <code>memcached_prepend()</code> , but has the option of an additional master key that can be used to identify an individual server.
<code>memcached_append_by_key(memc, master_key, master_key_length, key, key_length, value, value_length, expiration, flags)</code>	Similar to the <code>memcached_append()</code> , but has the option of an additional master key that can be used to identify an individual server.
<code>memcached_cas_by_key(memc, master_key, master_key_length, key, key_length, value, value_length, expiration, flags)</code>	Similar to the <code>memcached_cas()</code> , but has the option of an additional master key that can be used to identify an individual server.

The `by_key` methods add two further arguments, the master key, to be used and applied during the hashing stage for selecting the servers. You can see this in the following definition:

```
memcached_return
memcached_set_by_key(memcached_st *ptr,
                    const char *master_key,
                    size_t master_key_length,
                    const char *key,
                    size_t key_length,
                    const char *value,
                    size_t value_length,
                    time_t expiration,
                    uint32_t flags);
```

All the functions return a value of type `memcached_return`, which you can compare against the `MEMCACHED_SUCCESS` constant.

#### 14.5.3.1.4. libmemcached Get Functions

The `libmemcached` functions provide both direct access to a single item, and a multiple-key request mechanism that provides much faster responses when fetching a large number of keys simultaneously.

The main get-style function, which is equivalent to the generic `get()` is `memcached_get()`. The function a string pointer to the returned value for a corresponding key.

```
char *memcached_get (memcached_st *ptr,
                   const char *key, size_t key_length,
                   size_t *value_length,
                   uint32_t *flags,
                   memcached_return *error);
```

A multi-key get, `memcached_mget()`, is also available. Using a multiple key get operation is much quicker to do in one block than retrieving the key values with individual calls to `memcached_get()`. To start the multi-key get, you need to call `memcached_mget()`:

```
memcached_return
memcached_mget (memcached_st *ptr,
               char **keys, size_t *key_length,
               unsigned int number_of_keys);
```

The return value is the success of the operation. The `keys` parameter should be an array of strings containing the keys, and `key_length` an array containing the length of each corresponding key. `number_of_keys` is the number of keys supplied in the array.

To fetch the individual values, you need to use `memcached_fetch()` to get each corresponding value.

```
char *memcached_fetch (memcached_st *ptr,
                     const char *key, size_t *key_length,
                     size_t *value_length,
                     uint32_t *flags,
                     memcached_return *error);
```

The function returns the key value, with the `key`, `key_length` and `value_length` parameters being populated with the corresponding key and length information. The function returns `NULL` when there are no more values to be returned. A full example, including the populating of the key data and the return of the information is provided here.

```
#include <stdio.h>
#include <sstring.h>
#include <unistd.h>
#include <libmemcached/memcached.h>

int main(int argc, char *argv[])
```

```

{
    memcached_server_st *servers = NULL;
    memcached_st *memc;
    memcached_return rc;
    char *keys[] = {"huey", "dewey", "louie"};
    size_t key_length[3];
    char *values[] = {"red", "blue", "green"};
    size_t value_length[3];
    unsigned int x;
    uint32_t flags;

    char return_key[MEMCACHED_MAX_KEY];
    size_t return_key_length;
    char *return_value;
    size_t return_value_length;

    memc= memcached_create(NULL);

    servers= memcached_server_list_append(servers, "localhost", 11211, &rc);
    rc= memcached_server_push(memc, servers);

    if (rc == MEMCACHED_SUCCESS)
        fprintf(stderr, "Added server successfully\n");
    else
        fprintf(stderr, "Couldn't add server: %s\n", memcached_strerror(memc, rc));

    for(x= 0; x < 3; x++)
    {
        key_length[x] = strlen(keys[x]);
        value_length[x] = strlen(values[x]);

        rc= memcached_set(memc, keys[x], key_length[x], values[x],
            value_length[x], (time_t)0, (uint32_t)0);
        if (rc == MEMCACHED_SUCCESS)
            fprintf(stderr, "Key %s stored successfully\n", keys[x]);
        else
            fprintf(stderr, "Couldn't store key: %s\n", memcached_strerror(memc, rc));
    }

    rc= memcached_mget(memc, keys, key_length, 3);

    if (rc == MEMCACHED_SUCCESS)
    {
        while ((return_value= memcached_fetch(memc, return_key, &return_key_length,
            &return_value_length, &flags, &rc)) != NULL)
        {
            if (rc == MEMCACHED_SUCCESS)
            {
                fprintf(stderr, "Key %s returned %s\n", return_key, return_value);
            }
        }
    }

    return 0;
}

```

Running the above application:

```

shell> memc_multi_fetch
Added server successfully
Key huey stored successfully
Key dewey stored successfully
Key louie stored successfully
Key huey returned red
Key dewey returned blue
Key louie returned green

```

#### 14.5.3.1.5. libmemcached Behaviors

The behavior of `libmemcached` can be modified by setting one or more behavior flags. These can either be set globally, or they can be applied during the call to individual functions. Some behaviors also accept an additional setting, such as the hashing mechanism used when selecting servers.

To set global behaviors:

```

memcached_return
    memcached_behavior_set (memcached_st *ptr,
        memcached_behavior flag,
        uint64_t data);

```

To get the current behavior setting:

```

uint64_t
    memcached_behavior_get (memcached_st *ptr,
        memcached_behavior flag);

```

Behavior	Description
<code>MEMCACHED_BEHAVIOR_NO_BLOCK</code>	Caused <code>libmemcached</code> to use asynchronous I/O.
<code>MEMCACHED_BEHAVIOR_TCP_NODELAY</code>	Turns on no-delay for network sockets.
<code>MEMCACHED_BEHAVIOR_HASH</code>	Without a value, sets the default hashing algorithm for keys to use MD5. Other valid values include <code>MEMCACHED_HASH_DEFAULT</code> , <code>MEMCACHED_HASH_MD5</code> , <code>MEMCACHED_HASH_CRC</code> , <code>MEMCACHED_HASH_FNV1_64</code> , <code>MEMCACHED_HASH_FNV1A_64</code> , <code>MEMCACHED_HASH_FNV1_32</code> , and <code>MEMCACHED_HASH_FNV1A_32</code> .
<code>MEMCACHED_BEHAVIOR_DISTRIBUTION</code>	Changes the method of selecting the server used to store a given value. The default method is <code>MEMCACHED_DISTRIBUTION_MODULA</code> . You can enable consistent hashing by setting <code>MEMCACHED_DISTRIBUTION_CONSISTENT</code> . <code>MEMCACHED_DISTRIBUTION_CONSISTENT</code> is an alias for the value <code>MEMCACHED_DISTRIBUTION_CONSISTENT_KETAMA</code> .
<code>MEMCACHED_BEHAVIOR_CACHE_LOOKUPS</code>	Cache the lookups made to the DNS service. This can improve the performance if you are using names instead of IP addresses for individual hosts.
<code>MEMCACHED_BEHAVIOR_SUPPORT_CAS</code>	Support CAS operations. By default, this is disabled because it imposes a performance penalty.
<code>MEMCACHED_BEHAVIOR_KETAMA</code>	Sets the default distribution to <code>MEMCACHED_DISTRIBUTION_CONSISTENT_KETAMA</code> and the hash to <code>MEMCACHED_HASH_MD5</code> .
<code>MEMCACHED_BEHAVIOR_POLL_TIMEOUT</code>	Modify the timeout value used by <code>poll()</code> . You should supply a <code>signed int</code> pointer for the timeout value.
<code>MEMCACHED_BEHAVIOR_BUFFER_REQUESTS</code>	Buffers IO requests instead of them being sent. A get operation, or closing the connection will cause the data to be flushed.
<code>MEMCACHED_BEHAVIOR_VERIFY_KEY</code>	Forces <code>libmemcached</code> to verify that a specified key is valid.
<code>MEMCACHED_BEHAVIOR_SORT_HOSTS</code>	If set, hosts added to the list of configured hosts for a <code>memcached_st</code> structure will be placed into the host list in sorted order. This will break consistent hashing if that behavior has been enabled.
<code>MEMCACHED_BEHAVIOR_CONNECT_TIMEOUT</code>	In non-blocking mode this changes the value of the timeout during socket connection.

### 14.5.3.1.6. libmemcached Command-line Utilities

In addition to the main C library interface, `libmemcached` also includes a number of command line utilities that can be useful when working with and debugging `memcached` applications.

All of the command line tools accept a number of arguments, the most critical of which is `servers`, which specifies the list of servers to connect to when returning information.

The main tools are:

- `memcat` — display the value for each ID given on the command line:

```
shell> memcat --servers=localhost hwkey
Hello world
```

- `memcp` — copy the contents of a file into the cache, using the file names as the key:

```
shell> echo "Hello World" > hwkey
shell> memcp --servers=localhost hwkey
shell> memcat --servers=localhost hwkey
Hello world
```

- `memrm` — remove an item from the cache:

```
shell> memcat --servers=localhost hwkey
Hello world
shell> memrm --servers=localhost hwkey
shell> memcat --servers=localhost hwkey
```

- `memslap` — test the load on one or more `memcached` servers, simulating get/set and multiple client operations. For example, you can simulate the load of 100 clients performing get operations:

```
shell> memslap --servers=localhost --concurrency=100 --flush --test=get
memslap --servers=localhost --concurrency=100 --flush --test=get Threads connecting to servers 100
Took 13.571 seconds to read data
```

- `memflush` — flush (empty) the contents of the `memcached` cache.

```
shell> memflush --servers=localhost
```

### 14.5.3.2. Using MySQL and `memcached` with Perl

The `Cache::Memcached` module provides a native interface to the Memcache protocol, and provides support for the core functions offered by `memcached`. You should install the module using your hosts native package management system. Alternatively, you can install the module using CPAN:

```
root-shell> perl -MCPAN -e 'install Cache::Memcached'
```

To use `memcached` from Perl through `Cache::Memcached` module, you first need to create a new `Cache::Memcached` object that defines the list of servers and other parameters for the connection. The only argument is a hash containing the options for the cache interface. For example, to create a new instance that uses three `memcached` servers:

```
use Cache::Memcached;

my $cache = new Cache::Memcached {
    'servers' => [
        '192.168.0.100:11211',
        '192.168.0.101:11211',
        '192.168.0.102:11211',
    ],
};
```

#### Note

When using the `Cache::Memcached` interface with multiple servers, the API automatically performs certain operations across all the servers in the group. For example, getting statistical information through `Cache::Memcached` returns a hash that contains data on a host by host basis, as well as generalized statistics for all the servers in the group.

You can set additional properties on the cache object instance when it is created by specifying the option as part of the option hash. Alternatively, you can use a corresponding method on the instance:

- `servers` or method `set_servers()` — specifies the list of the servers to be used. The servers list should be a reference to an array of servers, with each element as the address and port number combination (separated by a colon). You can also specify a local connection through a UNIX socket (for example `/tmp/sock/memcached`). You can also specify the server with a weight (indicating how much more frequently the server should be used during hashing) by specifying an array reference with the `memcached` server instance and a weight number. Higher numbers give higher priority.
- `compress_threshold` or method `set_compress_threshold()` — specifies the threshold when values are compressed. Values larger than the specified number are automatically compressed (using `zlib`) during storage and retrieval.
- `no_rehash` or method `set_norehash()` — disables finding a new server if the original choice is unavailable.
- `readonly` or method `set_readonly()` — disables writes to the `memcached` servers.

Once the `Cache::Memcached` object instance has been configured you can use the `set()` and `get()` methods to store and retrieve information from the `memcached` servers. Objects stored in the cache are automatically serialized and deserialized using the `Storable` module.

The `Cache::Memcached` interface supports the following methods for storing/retrieving data, and relate to the generic methods as shown in the table.

<code>Cache::Memcached</code> Function	Equivalent to
<code>get()</code>	Generic <code>get()</code>
<code>get_multi(keys)</code>	Gets multiple <code>keys</code> from memcache using just one query. Returns a hash reference of key/value pairs.
<code>set()</code>	Generic <code>set()</code>
<code>add()</code>	Generic <code>add()</code>



Cache::Memcached Function	Equivalent to
<code>replace()</code>	Generic <code>replace()</code>
<code>delete()</code>	Generic <code>delete()</code>
<code>incr()</code>	Generic <code>incr()</code>
<code>decr()</code>	Generic <code>decr()</code>

Below is a complete example for using `memcached` with Perl and the `Cache::Memcached` module:

```

root-shell>! /usr/bin/perl
use Cache::Memcached;
use DBI;
use Data::Dumper;

# Configure the memcached server
my $cache = new Cache::Memcached {
    'servers' => [
        'localhost:11211',
    ],
};

# Get the film name from the command line
# memcached keys must not contain spaces, so create
# a key name by replacing spaces with underscores
my $filename = shift or die "Must specify the film name\n";
my $filmkey = $filename;
$filmkey =~ s/ /_/;

# Load the data from the cache
my $filmdata = $cache->get($filmkey);

# If the data wasn't in the cache, then we load it from the database
if (!defined($filmdata))
{
    $filmdata = load_filmdata($filename);
    if (defined($filmdata))
    {
# Set the data into the cache, using the key
        if ($cache->set($filmkey,$filmdata))
        {
            print STDERR "Film data loaded from database and cached\n";
        }
        else
        {
            print STDERR "Couldn't store to cache\n";
        }
    }
    else
    {
        die "Couldn't find $filename\n";
    }
}
else
{
    print STDERR "Film data loaded from Memcached\n";
}

sub load_filmdata
{
    my ($filename) = @_;

    my $dsn = "DBI:mysql:database=sakila;host=localhost;port=3306";
    $dbh = DBI->connect($dsn, 'sakila','password');

    my ($filmbase) = $dbh->selectrow_hashref(sprintf('select * from film where title = %s',
                                                    $dbh->quote($filename)));

    if (!defined($filename))
    {
        return (undef);
    }

    $filmbase->{stars} =
        $dbh->selectall_arrayref(sprintf('select concat(first_name," ",last_name) ' .
                                        'from film_actor left join (actor) ' .
                                        'on (film_actor.actor_id = actor.actor_id) ' .
                                        'where film_id=%s',
                                        $dbh->quote($filmbase->{film_id})));

    return($filmbase);
}

```

The example uses the Sakila database, obtaining film data from the database and writing a composite record of the film and actors to memcache. When calling it for a film that does not exist, you should get this result:

```
shell> memcached-sakila.pl "ROCK INSTINCT"
Film data loaded from database and cached
```

When accessing a film that has already been added to the cache:

```
shell> memcached-sakila.pl "ROCK INSTINCT"
Film data loaded from Memcached
```

### 14.5.3.3. Using MySQL and memcached with Python

The Python `memcache` module interfaces to `memcached` servers, and is written in pure python (i.e. without using one of the C APIs). You can download and install a copy from [Python Memcached](#).

To install, download the package and then run the Python installer:

```
python setup.py install
running install
running bdist_egg
running egg_info
creating python_memcached.egg-info
...
removing 'build/bdist.linux-x86_64/egg' (and everything under it)
Processing python_memcached-1.43-py2.4.egg
creating /usr/lib64/python2.4/site-packages/python_memcached-1.43-py2.4.egg
Extracting python_memcached-1.43-py2.4.egg to /usr/lib64/python2.4/site-packages
Adding python-memcached 1.43 to easy-install.pth file

Installed /usr/lib64/python2.4/site-packages/python_memcached-1.43-py2.4.egg
Processing dependencies for python-memcached==1.43
Finished processing dependencies for python-memcached==1.43
```

Once installed, the `memcache` module provides a class-based interface to your `memcached` servers. Serialization of Python structures is handled by using the Python `cPickle` or `pickle` modules.

To create a new `memcache` interface, import the `memcache` module and create a new instance of the `memcache.Client` class:

```
import memcache
memc = memcache.Client(['127.0.0.1:11211'])
```

The first argument should be an array of strings containing the server and port number for each `memcached` instance you want to use. You can enable debugging by setting the optional `debug` parameter to 1.

By default, the hashing mechanism used is `crc32`. This provides a basic module hashing algorithm for selecting among multiple servers. You can change the function used by setting the value of `memcache.serverHashFunction` to the alternate function you want to use. For example:

```
from zlib import Adler32
memcache.serverHashFunction = Adler32
```

Once you have defined the servers to use within the `memcache` instance, the core functions provide the same functionality as in the generic interface specification. A summary of the supported functions is provided in the following table.

Python <code>memcache</code> Function	Equivalent to
<code>get()</code>	Generic <code>get()</code>
<code>get_multi(keys)</code>	Gets multiple values from the supplied array of <code>keys</code> . Returns a hash reference of key/value pairs.
<code>set()</code>	Generic <code>set()</code>
<code>set_multi(dict [, expiry [, key_prefix]])</code>	Sets multiple key/value pairs from the supplied <code>dict</code> .
<code>add()</code>	Generic <code>add()</code>
<code>replace()</code>	Generic <code>replace()</code>
<code>prepend(key, value [, expiry])</code>	Prepends the supplied <code>value</code> to the value of the existing <code>key</code> .
<code>append(key, value [, expiry])</code>	Appends the supplied <code>value</code> to the value of the existing <code>key</code> .
<code>delete()</code>	Generic <code>delete()</code>

Python <code>memcache</code> Function	Equivalent to
<code>delete_multi(keys [, expiry [, key_prefix]] )</code>	Deletes all the keys from the hash matching each string in the array <code>keys</code> .
<code>incr()</code>	Generic <code>incr()</code>
<code>decr()</code>	Generic <code>decr()</code>

### Note

Within the Python `memcache` module, all the `*_multi()` functions support an optional `key_prefix` parameter. If supplied, then the string is used as a prefix to all key lookups. For example, if you call:

```
memc.get_multi(['a','b'], key_prefix='users:')
```

The function will retrieve the keys `users:a` and `users:b` from the servers.

An example showing the storage and retrieval of information to a `memcache` instance, loading the raw data from MySQL, is shown below:

```
import sys
import MySQLdb
import memcache

memc = memcache.Client(['127.0.0.1:11211'], debug=1);

try:
    conn = MySQLdb.connect (host = "localhost",
                            user = "sakila",
                            passwd = "password",
                            db = "sakila")
except MySQLdb.Error, e:
    print "Error %d: %s" % (e.args[0], e.args[1])
    sys.exit (1)

popularfilms = memc.get('top5films')

if not popularfilms:
    cursor = conn.cursor()
    cursor.execute('select film_id,title from film order by rental_rate desc limit 5')
    rows = cursor.fetchall()
    memc.set('top5films',rows,60)
    print "Updated memcached with MySQL data"
else:
    print "Loaded data from memcached"
    for row in popularfilms:
        print "%s, %s" % (row[0], row[1])
```

When executed for the first time, the data is loaded from the MySQL database and stored to the `memcached` server.

```
shell> python memc_python.py
Updated memcached with MySQL data
```

The data is automatically serialized using `cPickle/pickle`. This means when you load the data back from `memcached`, you can use the object directly. In the example above, the information stored to `memcached` is in the form of rows from a Python DB cursor. When accessing the information (within the 60 second expiry time), the data is loaded from `memcached` and dumped:

```
shell> python memc_python.py
Loaded data from memcached
2, ACE GOLDFINGER
7, AIRPLANE SIERRA
8, AIRPORT POLLOCK
10, ALADDIN CALENDAR
13, ALI FOREVER
```

The serialization and deserialization happens automatically, but be aware that serialization of Python data may be incompatible with other interfaces and languages. You can change the serialization module used during initialization, for example to use JSON, which will be more easily exchanged.

### 14.5.3.4. Using MySQL and `memcached` with PHP

PHP provides support for the Memcache functions through a PECL extension. To enable the PHP `memcache` extensions, you must build PHP using the `--enable-memcache` option to `configure` when building from source.

If you are installing on a RedHat based server, you can install the `php-pecl-memcache` RPM:

```
root-shell> yum --install php-pecl-memcache
```

On Debian based distributions, use the `php-memcache` package.

You can set global runtime configuration options by specifying the values in the following table within your `php.ini` file.

Configuration option	Default	Description
<code>memcache.allow_failover</code>	1	Specifies whether another server in the list should be queried if the first server selected fails.
<code>memcache.max_failover_attempts</code>	20	Specifies the number of servers to try before returning a failure.
<code>memcache.chunk_size</code>	8192	Defines the size of network chunks used to exchange data with the <code>memcached</code> server.
<code>memcache.default_port</code>	11211	Defines the default port to use when communicating with the <code>memcached</code> servers.
<code>memcache.hash_strategy</code>	standard	Specifies which hash strategy to use. Set to <code>consistent</code> to allow servers to be added or removed from the pool without causing the keys to be remapped to other servers. When set to <code>standard</code> , an older (modula) strategy is used that potentially uses different servers for storage.
<code>memcache.hash_function</code>	crc32	Specifies which function to use when mapping keys to servers. <code>crc32</code> uses the standard CRC32 hash. <code>fnv</code> uses the FNV-1a hashing algorithm.

To create a connection to a `memcached` server, you need to create a new `Memcache` object and then specifying the connection options. For example:

```
<?php
$cache = new Memcache;
$cache->connect('localhost',11211);
?>
```

This opens an immediate connection to the specified server.

To use multiple `memcached` servers, you need to add servers to the `memcache` object using `addServer()`:

```
bool Memcache::addServer ( string $host [, int $port [, bool $persistent
                        [, int $weight [, int $timeout [, int $retry_interval
                        [, bool $status [, callback $failure_callback
                        ]]]]]] )
```

The server management mechanism within the `php-memcache` module is a critical part of the interface as it controls the main interface to the `memcached` instances and how the different instances are selected through the hashing mechanism.

To create a simple connection to two `memcached` instances:

```
<?php
$cache = new Memcache;
$cache->addServer('192.168.0.100',11211);
$cache->addServer('192.168.0.101',11211);
?>
```

In this scenario the instance connection is not explicitly opened, but only opened when you try to store or retrieve a value. You can enable persistent connections to `memcached` instances by setting the `$persistent` argument to true. This is the default setting, and will cause the connections to remain open.

To help control the distribution of keys to different instances, you should use the global `memcache.hash_strategy` setting. This sets the hashing mechanism used to select. You can also add an additional weight to each server, which effectively increases the number of times the instance entry appears in the instance list, therefore increasing the likelihood of the instance being chosen over other instances. To set the weight, set the value of the `$weight` argument to more than one.

The functions for setting and retrieving information are identical to the generic functional interface offered by `memcached`, as shown in this table.

PECL <code>memcache</code> Function	Equivalent to
<code>get()</code>	Generic <code>get()</code>

PECL <code>memcache</code> Function	Equivalent to
<code>set()</code>	Generic <code>set()</code>
<code>add()</code>	Generic <code>add()</code>
<code>replace()</code>	Generic <code>replace()</code>
<code>delete()</code>	Generic <code>delete()</code>
<code>increment()</code>	Generic <code>incr()</code>
<code>decrement()</code>	Generic <code>decr()</code>

A full example of the PECL `memcache` interface is provided below. The code loads film data from the Sakila database when the user provides a film name. The data stored into the `memcached` instance is recorded as a `mysqli` result row, and the API automatically serializes the information for you.

```
<?php
$memc = new Memcache;
$memc->addServer('localhost', '11211');
?>

<html xmlns="http://www.w3.org/1999/xhtml" xml:lang="en" lang="en">
<head>
<meta http-equiv="Content-Type" content="text/html; charset=utf-8" />
<title>Simple Memcache Lookup</title>
</head>
<body>
<form method="post">
<p><b>Film</b>: <input type="text" size="20" name="film"></p>
<input type="submit">
</form>
<hr/>
<?php
    echo "Loading data...\n";
$value = $memc->get($_REQUEST['film']);
if ($value)
{
    printf("<p>Film data for %s loaded from memcache</p>", $value['title']);
    foreach (array_keys($value) as $key)
    {
        printf("<p><b>%s</b>: %s</p>", $key, $value[$key]);
    }
}
else
{
    $con = new mysqli('localhost', 'sakila', 'password', 'sakila') or
        die("<h1>Database problem</h1>" . mysqli_connect_error());
    $result = $con->query(sprintf('select * from film where title = "%s"', $_REQUEST['film']));
    $row = $result->fetch_array(MYSQLI_ASSOC);
    $memc->set($row['title'], $row);
    printf("<p>Loaded %s from MySQL</p>", $row['title']);
}
?>
```

With PHP, the connections to the `memcached` instances are kept open as long as the PHP and associated Apache instance remain running. When adding a removing servers from the list in a running instance (for example, when starting another script that mentions additional servers), the connections will be shared, but the script will only select among the instances explicitly configured within the script.

To ensure that changes to the server list within a script do not cause problems, make sure to use the consistent hashing mechanism.

### 14.5.3.5. Using MySQL and `memcached` with Ruby

There are a number of different modules for interfacing to `memcached` within Ruby. The `Ruby-MemCache` client library provides a native interface to `memcached` that does not require any external libraries, such as `libmemcached`. You can obtain the installer package from <http://www.deveiate.org/projects/RMemCache>.

To install, extract the package and then run `install.rb`:

```
shell> install.rb
```

If you have RubyGems, you can install the [Ruby-MemCache](#) gem:

```
shell> gem install Ruby-MemCache
Bulk updating Gem source index for: http://gems.rubyforge.org
Install required dependency io-reactor? [Yn] y
Successfully installed Ruby-MemCache-0.0.1
Successfully installed io-reactor-0.05
Installing ri documentation for io-reactor-0.05...
Installing RDoc documentation for io-reactor-0.05...
```

To use a `memcached` instance from within Ruby, create a new instance of the `MemCache` object.

```
require 'memcache'
memc = MemCache::new '192.168.0.100:11211'
```

You can add a weight to each server to increase the likelihood of the server being selected during hashing by appending the weight count to the server host name/port string:

```
require 'memcache'
memc = MemCache::new '192.168.0.100:11211:3'
```

To add servers to an existing list, you can append them directly to the `MemCache` object:

```
memc += ["192.168.0.101:11211"]
```

To set data into the cache, you can just assign a value to a key within the new cache object, which works just like a standard Ruby hash object:

```
memc["key"] = "value"
```

Or to retrieve the value:

```
print memc["key"]
```

For more explicit actions, you can use the method interface, which mimics the main `memcached` API functions, as summarized in the following table.

Ruby <code>MemCache</code> Method	Equivalent to
<code>get()</code>	Generic <code>get()</code>
<code>get_hash(keys)</code>	Get the values of multiple <code>keys</code> , returning the information as a hash of the keys and their values.
<code>set()</code>	Generic <code>set()</code>
<code>set_many(pairs)</code>	Set the values of the keys and values in the hash <code>pairs</code> .
<code>add()</code>	Generic <code>add()</code>
<code>replace()</code>	Generic <code>replace()</code>
<code>delete()</code>	Generic <code>delete()</code>
<code>incr()</code>	Generic <code>incr()</code>
<code>decr()</code>	Generic <code>decr()</code>

### 14.5.3.6. Using MySQL and `memcached` with Java

The `com.danga.MemCached` class within Java provides a native interface to `memcached` instances. You can obtain the client from <http://whalin.com/memcached/>. The Java class uses hashes that are compatible with `libmemcached`, so you can mix and match Java and `libmemcached` applications accessing the same `memcached` instances. The serialization between Java and other interfaces will not be compatible. If this is a problem, use JSON or a similar nonbinary serialization format.

On most systems you can download the package and use the `jar` directly. On OpenSolaris, use `pkg` to install the `SUNWmem-cached-java` package.

To use the `com.danga.MemCached` interface, you create a `MemCachedClient` instance and then configure the list of servers by configuring the `SocketIOPool`. Through the pool specification you set up the server list, weighting, and the connection parameters to optimized the connections between your client and the `memcached` instances that you configure.

Generally you can configure the `memcached` interface once within a single class and then use this interface throughout the rest of

your application.

For example, to create a basic interface, first configure the `MemCachedClient` and base `SockIOPool` settings:

```
public class MyClass {
    protected static MemCachedClient mcc = new MemCachedClient();
    static {
        String[] servers =
            {
                "localhost:11211",
            };
        Integer[] weights = { 1 };
        SockIOPool pool = SockIOPool.getInstance();
        pool.setServers( servers );
        pool.setWeights( weights );
    }
}
```

In the above sample, the list of servers is configured by creating an array of the `memcached` instances that you want to use. You can then configure individual weights for each server.

The remainder of the properties for the connection are optional, but you can set the connection numbers (initial connections, minimum connections, maximum connections, and the idle timeout) by setting the pool parameters:

```
pool.setInitConn( 5 );
pool.setMinConn( 5 );
pool.setMaxConn( 250 );
pool.setMaxIdle( 1000 * 60 * 60 * 6 );
```

Once the parameters have been configured, initialize the connection pool:

```
pool.initialize();
```

The pool, and the connection to your `memcached` instances should now be ready to use.

To set the hashing algorithm used to select the server used when storing a given key you can use `pool.setHashingAlg()`:

```
pool.setHashingAlg( SockIOPool.NEW_COMPAT_HASH );
```

Valid values are `NEW_COMPAT_HASH`, `OLD_COMPAT_HASH` and `NATIVE_HASH` are also basic modular hashing algorithms. For a consistent hashing algorithm, use `CONSISTENT_HASH`. These constants are equivalent to the corresponding hash settings within `libmemcached`.

Java <code>com.danga.MemCached</code> Method	Equivalent to
<code>get()</code>	Generic <code>get()</code>
<code>getMulti(keys)</code>	Get the values of multiple <code>keys</code> , returning the information as Hash map using <code>java.lang.String</code> for the keys and <code>java.lang.Object</code> for the corresponding values.
<code>set()</code>	Generic <code>set()</code>
<code>add()</code>	Generic <code>add()</code>
<code>replace()</code>	Generic <code>replace()</code>
<code>delete()</code>	Generic <code>delete()</code>
<code>incr()</code>	Generic <code>incr()</code>
<code>decr()</code>	Generic <code>decr()</code>

### 14.5.3.7. Using the MySQL `memcached` UDFs

The `memcached` MySQL User Defined Functions (UDFs) enable you to set and retrieve objects from within MySQL 5.0 or greater.

To install the MySQL `memcached` UDFs, download the UDF package from [http://tangent.org/586/Memcached\\_Functions\\_for\\_MySQL.html](http://tangent.org/586/Memcached_Functions_for_MySQL.html). You will need to unpack the package and run `configure` to configure the build process. When running `configure`, use the `--with-mysql` option and specify the location of the `mysql_config` command. Note that you must be running :

```
shell> tar zxf memcached_functions_mysql-0.5.tar.gz
shell> cd memcached_functions_mysql-0.5
shell> ./configure --with-mysql-config=/usr/local/mysql/bin/mysql_config
```

Now build and install the functions:

```
shell> make
shell> make install
```

You may want to copy the MySQL `memcached` UDFs into your MySQL plugins directory:

```
shell> cp /usr/local/lib/libmemcached_functions_mysql* /usr/local/mysql/lib/mysql/plugins/
```

Once installed, you must initialize the function within MySQL using `CREATE` and specifying the return value and library. For example, to add the `memc_get()` function:

```
mysql> CREATE FUNCTION memc_get RETURNS STRING SONAME "libmemcached_functions_mysql.so";
```

You must repeat this process for each function that you want to provide access to within MySQL. Once you have created the association, the information will be retained, even over restarts of the MySQL server. You can simplify the process by using the SQL script provided in the `memcached` UDFs package:

```
shell> mysql <sql/install_functions.sql
```

Alternatively, if you have Perl installed, then you can use the supplied Perl script, which will check for the existence of each function and create the function/library association if it has not already been defined:

```
shell> utils/install.pl --silent
```

The `--silent` option installs everything automatically. Without this option, the script will ask whether you want to install each of the available functions.

The interface remains consistent with the other APIs and interfaces. To set up a list of servers, use the `memc_servers_set()` function, which accepts a single string containing and comma-separated list of servers:

```
mysql> SELECT memc_servers_set('192.168.0.1:11211,192.168.0.2:11211');
```

### Note

The list of servers used by the `memcached` UDFs is not persistent over restarts of the MySQL server. If the MySQL server fails, then you must re-set the list of `memcached` servers.

To set a value, use `memc_set()`:

```
mysql> SELECT memc_set('myid', 'myvalue');
```

To retrieve a stored value:

```
mysql> SELECT memc_get('myid');
```

The list of functions supported by the UDFs, in relation to the standard protocol functions, is shown in the following table.

MySQL <code>memcached</code> UDF Function	Equivalent to
<code>memc_get()</code>	Generic <code>get()</code>
<code>memc_get_by_key(master_key, key, value)</code>	Like the generic <code>get()</code> , but uses the supplied master key to select the server to use.
<code>memc_set()</code>	Generic <code>set()</code>
<code>memc_set_by_key(master_key, key, value)</code>	Like the generic <code>set()</code> , but uses the supplied master key to select the server to use.
<code>memc_add()</code>	Generic <code>add()</code>
<code>memc_add_by_key(master_key, key, value)</code>	Like the generic <code>add()</code> , but uses the supplied master key to select the server to use.
<code>memc_replace()</code>	Generic <code>replace()</code>
<code>memc_replace_by_key(master_key, key, value)</code>	Like the generic <code>replace()</code> , but uses the supplied master key



MySQL <code>memcached</code> UDF Function	Equivalent to
	to select the server to use.
<code>memc_prepend(key, value)</code>	Prepend the specified <code>value</code> to the current value of the specified <code>key</code> .
<code>memc_prepend_by_key(master_key, key, value)</code>	Prepend the specified <code>value</code> to the current value of the specified <code>key</code> , but uses the supplied master key to select the server to use.
<code>memc_append(key, value)</code>	Append the specified <code>value</code> to the current value of the specified <code>key</code> .
<code>memc_append_by_key(master_key, key, value)</code>	Append the specified <code>value</code> to the current value of the specified <code>key</code> , but uses the supplied master key to select the server to use.
<code>memc_delete()</code>	Generic <code>delete()</code>
<code>memc_delete_by_key(master_key, key, value)</code>	Like the generic <code>delete()</code> , but uses the supplied master key to select the server to use.
<code>memc_increment()</code>	Generic <code>incr()</code>
<code>memc_decrement()</code>	Generic <code>decr()</code>

The respective `*_by_key()` functions are useful when you want to store a specific value into a specific `memcached` server, possibly based on a differently calculated or constructed key.

The `memcached` UDFs include some additional functions:

- `memc_server_count()`

Returns a count of the number of servers in the list of registered servers.

- `memc_servers_set_behavior(behavior_type, value), memc_set_behavior(behavior_type, value)`

Set behaviors for the list of servers. These behaviors are identical to those provided by the `libmemcached` library. For more information on `libmemcached` behaviors, see [Section 14.5.3.1, “Using libmemcached”](#).

You can use the behavior name as the `behavior_type`:

```
mysql> SELECT memc_servers_behavior_set("MEMCACHED_BEHAVIOR_KETAMA",1);
```

- `memc_servers_behavior_get(behavior_type), memc_get_behavior(behavior_type, value)`

Returns the value for a given behavior.

- `memc_list_behaviors()`

Returns a list of the known behaviors.

- `memc_list_hash_types()`

Returns a list of the supported key-hashing algorithms.

- `memc_list_distribution_types()`

Returns a list of the supported distribution types to be used when selecting a server to use when storing a particular key.

- `memc_libmemcached_version()`

Returns the version of the `libmemcached` library.

- `memc_stats()`

Returns the general statistics information from the server.

### 14.5.3.8. `memcached` Protocol

Communicating with a `memcached` server can be achieved through either the TCP or UDP protocols. When using the TCP protocol you can use a simple text based interface for the exchange of information.

### 14.5.3.8.1. Using the TCP text protocol

When communicating with `memcached` you can connect to the server using the port configured for the server. You can open a connection with the server without requiring authorization or login. As soon as you have connected, you can start to send commands to the server. When you have finished, you can terminate the connection without sending any specific disconnection command. Clients are encouraged to keep their connections open to decrease latency and improve performance.

Data is sent to the `memcached` server in two forms:

- Text lines, which are used to send commands to the server, and receive responses from the server.
- Unstructured data, which is used to receive or send the value information for a given key. Data is returned to the client in exactly the format it was provided.

Both text lines (commands and responses) and unstructured data are always terminated with the string `\r\n`. Because the data being stored may contain this sequence, the length of the data (returned by the client before the unstructured data is transmitted) should be used to determine the end of the data.

Commands to the server are structured according to their operation:

- **Storage commands:** `set`, `add`, `replace`, `append`, `prepend`, `cas`

Storage commands to the server take the form:

```
command key [flags] [exptime] length [noreply]
```

Or when using compare and swap (`cas`):

```
cas key [flags] [exptime] length [casunique] [noreply]
```

Where:

- `command` — the command name.
  - `set` — Store value against key
  - `add` — Store this value against key if the key does not already exist
  - `replace` — Store this value against key if the key already exists
  - `append` — Append the supplied value to the end of the value for the specified key. The `flags` and `exptime` arguments should not be used.
  - `prepend` — Append value currently in the cache to the end of the supplied value for the specified key. The `flags` and `exptime` arguments should not be used.
  - `cas` — Set the specified key to the supplied value, only if the supplied `casunique` matches. This is effectively the equivalent of change the information if nobody has updated it since I last fetched it.
- `key` — the key. All data is stored using a the specific key. The key cannot contain control characters or whitespace, and can be up to 250 characters in size.
- `flags` — the flags for the operation (as an integer). Flags in `memcached` are transparent. The `memcached` server ignores the contents of the flags. They can be used by the client to indicate any type of information. In `memcached` 1.2.0 and lower the value is a 16-bit integer value. In `memcached` 1.2.1 and higher the value is a 32-bit integer.
- `exptime` — the expiry time, or zero for no expiry.
- `length` — the length of the supplied value block in bytes, excluding the terminating `\r\n` characters.
- `casunique` — is a unique 64-bit value of an existing entry. This will be used to compare against the existing value. You should use the value returned by the `gets` command when issuing `cas` updates.
- `noreply` — tells the server not to reply to the command.

For example, to store the value `abcdef` into the key `xyzkey`, you would use:

```
set xyzkey 0 0 6\r\nabcdef\r\n
```

The return value from the server will be one line, specifying the status or error information. For more information, see [Table 14.2, “memcached Protocol Responses”](#).

- **Retrieval commands:** `get`, `gets`

Retrieval commands take the form:

```
get key1 [key2 ... keyn]
gets key1 [key2 ... keyn]
```

You can supply multiple keys to the commands, with each requested key separated by whitespace.

The server will respond with an information line of the form:

```
VALUE key flags bytes [casunique]
```

Where:

- `key` — the key name.
- `flags` — the value of the flag integer supplied to the `memcached` server when the value was stored.
- `bytes` — the size (excluding the terminating `\r\n` character sequence) of the stored value.
- `casunique` — the unique 64-bit integer that identifies the item.

The information line will immediately be followed by the value data block. For example:

```
get xyzkey\r\n
VALUE xyzkey 0 6\r\n
abcdef\r\n
```

If you have requested multiple keys, an information line and data block will be returned for each key found. If a requested key does not exist in the cache, no information is returned.

- **Delete commands:** `delete`

Deletion commands take the form:

```
delete key [time] [noreply]
```

Where:

- `key` — the key name.
- `time` — the time in seconds (or a specific Unix time) for which the client wishes the server to refuse `add` or `replace` commands on this key. All `add`, `replace`, `get`, and `gets` commands will fail during this period. `set` operations will succeed. After this period, the key will be deleted permanently and all commands will be accepted.

If not supplied, the value is assumed to be zero (delete immediately).

- `noreply` — tells the server not to reply to the command.

Responses to the command will either be `DELETED` to indicate that the key was successfully removed, or `NOT_FOUND` to indicate that the specified key could not be found.

- **Increment/Decrement:** `incr`, `decr`

The increment and decrement commands change the value of a key within the server without performing a separate `get/set` sequence. The operations assume that the currently stored value is a 64-bit integer. If the stored value is not a 64-bit integer, then the value is assumed to be zero before the increment or decrement operation is applied.

Increment and decrement commands take the form:

```
incr key value [noreply]
decr key value [noreply]
```

Where:

- `key` — the key name.
- `value` — an integer to be used as the increment or decrement value.
- `noreply` — tells the server not to reply to the command.

The response will be:

- `NOT_FOUND` — the specified key could not be located.
- `value` — the new value of the specified key.

Values are assumed to be unsigned. For `decr` operations the value will never be decremented below 0. For `incr` operations, the value will be wrap around the 64-bit maximum.

- **Statistics commands: `stats`**

The `stats` command provides detailed statistical information about the current status of the `memcached` instance and the data it is storing.

Statistics commands take the form:

```
STAT [name] [value]
```

Where:

- `name` — is the optional name of the statistics to return. If not specified, the general statistics are returned.
- `value` — a specific value to be used when performing certain statistics operations.

The return value is a list of statistics data, formatted as follows:

```
STAT name value
```

The statistics are terminated with a single line, `END`.

For more information, see [Section 14.5.4, “Getting memcached Statistics”](#).

For reference, a list of the different commands supported and their formats is provided below.

**Table 14.1. memcached Command Reference**

Command	Command Formats
<code>set</code>	<code>set key flags exptime length, set key flags exptime length noreply</code>
<code>add</code>	<code>add key flags exptime length, add key flags exptime length noreply</code>
<code>replace</code>	<code>replace key flags exptime length, replace key flags exptime length noreply</code>
<code>append</code>	<code>append key length, append key length noreply</code>
<code>prepend</code>	<code>prepend key length, prepend key length noreply</code>
<code>cas</code>	<code>cas key flags exptime length casunique, cas key flags exptime length casunique noreply</code>
<code>get</code>	<code>get key1 [key2 ... keyn]</code>
<code>gets</code>	
<code>delete</code>	<code>delete key, delete key noreply, delete key expiry, delete key expiry noreply</code>
<code>incr</code>	<code>incr key, incr key noreply, incr key value, incr key value noreply</code>
<code>decr</code>	<code>decr key, decr key noreply, decr key value, decr key value noreply</code>
<code>stat</code>	<code>stat, stat name, stat name value</code>

When sending a command to the server, the response from the server will be one of the settings in the following table. All response values from the server are terminated by `\r\n`:

**Table 14.2. memcached Protocol Responses**

String	Description
STORED	Value has successfully been stored.
NOT_STORED	The value was not stored, but not because of an error. For commands where you are adding a or updating a value if it exists (such as <code>add</code> and <code>replace</code> ), or where the item has already been set to be deleted.
EXISTS	When using a <code>cas</code> command, the item you are trying to store already exists and has been modified since you last checked it.
NOT_FOUND	The item you are trying to store, update or delete does not exist or has already been deleted.
ERROR	You submitted a non-existent command name.
CLIENT_ERROR error-string	There was an error in the input line, the detail is contained in <code>errorstring</code> .
SERVER_ERROR error-string	There was an error in the server that prevents it from returning the information. In extreme conditions, the server may disconnect the client after this error occurs.
VALUE keys flags length	The requested key has been found, and the stored <code>key</code> , <code>flags</code> and data block will be returned, of the specified <code>length</code> .
DELETED	The requested key was deleted from the server.
STAT name value	A line of statistics data.
END	The end of the statistics data.

#### 14.5.4. Getting memcached Statistics

The `memcached` system has a built in statistics system that collects information about the data being stored into the cache, cache hit ratios, and detailed information on the memory usage and distribution of information through the slab allocation used to store individual items. Statistics are provided at both a basic level that provide the core statistics, and more specific statistics for specific areas of the `memcached` server.

This information can prove be very useful to ensure that you are getting the correct level of cache and memory usage, and that your slab allocation and configuration properties are set at an optimal level.

The stats interface is available through the standard `memcached` protocol, so the reports can be accessed by using `telnet` to connect to the `memcached`. Alternatively, most of the language API interfaces provide a function for obtaining the statistics from the server.

For example, to get the basic stats using `telnet`:

```
shell> telnet localhost 11211
Trying ::1...
Connected to localhost.
Escape character is '^]'.
stats
STAT pid 23599
STAT uptime 675
STAT time 1211439587
STAT version 1.2.5
STAT pointer_size 32
STAT rusage_user 1.404992
STAT rusage_system 4.694685
STAT curr_items 32
STAT total_items 56361
STAT bytes 2642
STAT curr_connections 53
STAT total_connections 438
STAT connection_structures 55
STAT cmd_get 113482
STAT cmd_set 80519
STAT get_hits 78926
STAT get_misses 34556
STAT evictions 0
STAT bytes_read 6379783
STAT bytes_written 4860179
STAT limit_maxbytes 67108864
STAT threads 1
END
```

When using Perl and the `Cache::Memcached` module, the `stats()` function returns information about all the servers cur-

rently configured in the connection object, and total statistics for all the `memcached` servers as a whole.

For example, the following Perl script will obtain the stats and dump the hash reference that is returned:

```
use Cache::Memcached;
use Data::Dumper;

my $memc = new Cache::Memcached;
$memc->set_servers(\@ARGV);

print Dumper($memc->stats());
```

When executed on the same `memcached` as used in the `Telnet` example above we get a hash reference with the host by host and total statistics:

```
$VAR1 = {
  'hosts' => {
    'localhost:11211' => {
      'misc' => {
        'bytes' => '2421',
        'curr_connections' => '3',
        'connection_structures' => '56',
        'pointer_size' => '32',
        'time' => '1211440166',
        'total_items' => '410956',
        'cmd_set' => '588167',
        'bytes_written' => '35715151',
        'evictions' => '0',
        'curr_items' => '31',
        'pid' => '23599',
        'limit_maxbytes' => '67108864',
        'uptime' => '1254',
        'rusage_user' => '9.857805',
        'cmd_get' => '838451',
        'rusage_system' => '34.096988',
        'version' => '1.2.5',
        'get_hits' => '581511',
        'bytes_read' => '46665716',
        'threads' => '1',
        'total_connections' => '3104',
        'get_misses' => '256940'
      },
      'sizes' => {
        '128' => '16',
        '64' => '15'
      }
    }
  },
  'self' => {},
  'total' => {
    'cmd_get' => 838451,
    'bytes' => 2421,
    'get_hits' => 581511,
    'connection_structures' => 56,
    'bytes_read' => 46665716,
    'total_items' => 410956,
    'total_connections' => 3104,
    'cmd_set' => 588167,
    'bytes_written' => 35715151,
    'curr_items' => 31,
    'get_misses' => 256940
  }
};
```

The statistics are divided up into a number of distinct sections, and then can be requested by adding the type to the `stats` command. Each statistics output is covered in more detail in the following sections.

- General statistics, see [Section 14.5.4.1, “memcached General Statistics”](#).
- Slab statistics (`slabs`), see [Section 14.5.4.2, “memcached Slabs Statistics”](#).
- Item statistics (`items`), see [Section 14.5.4.3, “memcached Item Statistics”](#).
- Size statistics (`sizes`), see [Section 14.5.4.4, “memcached Size Statistics”](#).

#### 14.5.4.1. memcached General Statistics

The output of the general statistics provides an overview of the performance and use of the `memcached` instance. The statistics returned by the command and their meaning is shown in the following table.

The following terms are used to define the value type for each statistics value:

- `32u` — 32-bit unsigned integer
- `64u` — 64-bit unsigned integer
- `32u32u` — Two 32-bit unsigned integers separated by a colon
- `String` — Character string

Statistic	Description	
<code>pid</code>	<code>32u</code>	Process id of the <code>memcached</code> instance.
<code>uptime</code>	<code>32u</code>	Uptime (in seconds) for this <code>memcached</code> instance.
<code>time</code>	<code>32u</code>	Current time (as epoch).
<code>version</code>	<code>string</code>	Version string of this instance.
<code>pointer_size</code>	<code>string</code>	Size of pointers for this host specified in bits (32 or 64).
<code>rusage_user</code>	<code>32u:32u</code>	Total user time for this instance (seconds:microseconds).
<code>rusage_system</code>	<code>32u:32u</code>	Total system time for this instance (seconds:microseconds).
<code>curr_items</code>	<code>32u</code>	Current number of items stored by this instance.
<code>total_items</code>	<code>32u</code>	Total number of items stored during the life of this instance.
<code>bytes</code>	<code>64u</code>	Current number of bytes used by this server to store items.
<code>curr_connections</code>	<code>32u</code>	Current number of open connections.
<code>total_connections</code>	<code>32u</code>	Total number of connections opened since the server started running.
<code>connection_structures</code>	<code>32u</code>	Number of connection structures allocated by the server.
<code>cmd_get</code>	<code>64u</code>	Total number of retrieval requests ( <code>get</code> operations).
<code>cmd_set</code>	<code>64u</code>	Total number of storage requests ( <code>set</code> operations).
<code>get_hits</code>	<code>64u</code>	Number of keys that have been requested and found present.
<code>get_misses</code>	<code>64u</code>	Number of items that have been requested and not found.
<code>evictions</code>	<code>64u</code>	Number of valid items removed from cache to free memory for new items.
<code>bytes_read</code>	<code>64u</code>	Total number of bytes read by this server from network.
<code>bytes_written</code>	<code>64u</code>	Total number of bytes sent by this server to network.
<code>limit_maxbytes</code>	<code>32u</code>	Number of bytes this server is allowed to use for storage.
<code>threads</code>	<code>32u</code>	Number of worker threads requested.

The most useful statistics from those given here are the number of cache hits, misses, and evictions.

A large number of `get_misses` may just be an indication that the cache is still being populated with information. The number should, over time, decrease in comparison to the number of cache `get_hits`. If, however, you have a large number of cache misses compared to cache hits after an extended period of execution, it may be an indication that the size of the cache is too small and you either need to increase the total memory size, or increase the number of the `memcached` instances to improve the hit ratio.

A large number of `evictions` from the cache, particularly in comparison to the number of items stored is a sign that your cache is too small to hold the amount of information that you regularly want to keep cached. Instead of items being retained in the cache, items are being evicted to make way for new items keeping the turnover of items in the cache high, reducing the efficiency of the cache.

#### 14.5.4.2. `memcached` Slabs Statistics

To get the `slabs` statistics, use the `stats slabs` command, or the API equivalent.

The slab statistics provide you with information about the slabs that have created and allocated for storing information within the cache. You get information both on each individual slab-class and total statistics for the whole slab.

```
STAT 1:chunk_size 104
STAT 1:chunks_per_page 10082
STAT 1:total_pages 1
STAT 1:total_chunks 10082
STAT 1:used_chunks 10081
STAT 1:free_chunks 1
STAT 1:free_chunks_end 10079
STAT 9:chunk_size 696
STAT 9:chunks_per_page 1506
STAT 9:total_pages 63
```

```

STAT 9:total_chunks 94878
STAT 9:used_chunks 94878
STAT 9:free_chunks 0
STAT 9:free_chunks_end 0
STAT active_slabs 2
STAT total_malloced 67083616
END

```

Individual stats for each slab class are prefixed with the slab ID. A unique ID is given to each allocated slab from the smallest size up to the largest. The prefix number indicates the slab class number in relation to the calculated chunk from the specified growth factor. Hence in the example, 1 is the first chunk size and 9 is the 9th chunk allocated size.

The different parameters returned for each chunk size and the totals are shown in the following table.

Statistic	Description
chunk_size	Space allocated to each chunk within this slab class.
chunks_per_page	Number of chunks within a single page for this slab class.
total_pages	Number of pages allocated to this slab class.
total_chunks	Number of chunks allocated to the slab class.
used_chunks	Number of chunks allocated to an item..
free_chunks	Number of chunks not yet allocated to items.
free_chunks_end	Number of free chunks at the end of the last allocated page.
active_slabs	Total number of slab classes allocated.
total_malloced	Total amount of memory allocated to slab pages.

The key values in the slab statistics are the `chunk_size`, and the corresponding `total_chunks` and `used_chunks` parameters. These given an indication of the size usage of the chunks within the system. Remember that one key/value pair will be placed into a chunk of a suitable size.

From these stats you can get an idea of your size and chunk allocation and distribution. If you are storing many items with a number of largely different sizes, then you may want to adjust the chunk size growth factor to increase in larger steps to prevent chunk and memory wastage. A good indication of a bad growth factor is a high number of different slab classes, but with relatively few chunks actually in use within each slab. Increasing the growth factor will create fewer slab classes and therefore make better use of the allocated pages.

### 14.5.4.3. memcached Item Statistics

To get the `items` statistics, use the `stats items` command, or the API equivalent.

The `items` statistics give information about the individual items allocated within a given slab class.

```

STAT items:2:number 1
STAT items:2:age 452
STAT items:2:evicted 0
STAT items:2:outofmemory 0
STAT items:27:number 1
STAT items:27:age 452
STAT items:27:evicted 0
STAT items:27:outofmemory 0

```

The prefix number against each statistics relates to the corresponding chunk size, as returned by the `stats slabs` statistics. The result is a display of the number of items stored within each chunk within each slab size, and specific statistics about their age, eviction counts, and out of memory counts. A summary of the statistics is given in the following table.

Statistic	Description
number	The number of items currently stored in this slab class.
age	The age of the oldest item within the slab class, in seconds.
evicted	The number of items evicted to make way for new entries.
outofmemory	The number of items for this slab class that have triggered an out of memory error (only value when the <code>-M</code> command line option is in effect).

Item level statistics can be used to determine how many items are stored within a given slab and their freshness and recycle rate. You can use this to help identify whether there are certain slab classes that are triggering a much larger number of evictions than others.



#### 14.5.4.4. memcached Size Statistics

To get size statistics, use the `stats sizes` command, or the API equivalent.

The size statistics provide information about the sizes and number of items of each size within the cache. The information is returned as two columns, the first column is the size of the item (rounded up to the nearest 32 byte boundary), and the second column is the count of the number of items of that size within the cache:

```
96 35
128 38
160 807
192 804
224 410
256 222
288 83
320 39
352 53
384 33
416 64
448 51
480 30
512 54
544 39
576 10065
```

#### Caution

Running this statistic will lock up your cache as each item is read from the cache and its size calculated. On a large cache, this may take some time and prevent any set or get operations until the process completes.

The item size statistics are useful only to determine the sizes of the objects you are storing. Since the actual memory allocation is relevant only in terms of the chunk size and page size, the information will only be useful during a careful debugging or diagnostic session.

#### 14.5.5. memcached FAQ

##### Questions

- [14.5.5.1](#): How does an event such as a crash of one of the `memcached` servers handled by the `memcached` client?
- [14.5.5.2](#): Are there any, or are there any plans to introduce, a framework to hide the interaction of memcached from the application, i.e., within hibernate?
- [14.5.5.3](#): What's a recommended hardware config for a memcached server? Linux or Windows?
- [14.5.5.4](#): How expensive is it to establish a memcache connection? Should those connections be pooled?
- [14.5.5.5](#): How will the data will be handled when the `memcached` server is down?
- [14.5.5.6](#): Can memcached be run on a Windows environment?
- [14.5.5.7](#): What is the max size of an object you can store in memcache and is that configurable?
- [14.5.5.8](#): Is it true `memcached` will be much more effective with db-read-intensive applications than with db-write-intensive applications?
- [14.5.5.9](#): What are best practices for testing an implementation, to ensure that it is an improvement over the MySQL query cache, and to measure the impact of `memcached` configuration changes? And would you recommend keeping the configuration very simple to start?
- [14.5.5.10](#): Can MySQL actually trigger/store the changed data to memcached?
- [14.5.5.11](#): So the responsibility lies with the application to populate and get records from the database as opposed to being a transparent cache layer for the db?
- [14.5.5.12](#): `memcached` is fast - is there any overhead in not using persistent connections? If persistent is always recommended, what are the downsides (e.g. locking up)?
- [14.5.5.13](#): Is compression available?
- [14.5.5.14](#): File socket support for `memcached` from the localhost use to the local memcached server?
- [14.5.5.15](#): What are the advantages of using UDFs when the get/sets are manageable from within the client code rather than the

db?

- [14.5.5.16](#): Is `memcached` typically a better solution for improving speed than MySQL Cluster and/or MySQL Proxy?
- [14.5.5.17](#): What speed trade offs is there between `memcached` vs MySQL Query Cache? Where you check `memcached`, and get data from MySQL and put it in `memcached` or just make a query and results are put into MySQL Query Cache.
- [14.5.5.18](#): Does the `-L` flag automatically sense how much memory is being used by other `memcached`?
- [14.5.5.19](#): Is the data inside of `memcached` secure?
- [14.5.5.20](#): Can we implement different types of `memcached` as different nodes in the same server - so can there be deterministic and non deterministic in the same server?
- [14.5.5.21](#): How easy is it to introduce `memcached` to an existing enterprise application instead of inclusion at project design?
- [14.5.5.22](#): Can `memcached` work with ASPX?
- [14.5.5.23](#): If I have an object larger than a MB, do I have to manually split it or can I configure `memcached` to handle larger objects?
- [14.5.5.24](#): How does `memcached` compare to nCache?
- [14.5.5.25](#): Doing a direct telnet to the `memcached` port, is that just for that one machine, or does it magically apply across all nodes?
- [14.5.5.26](#): Is `memcached` more effective for video and audio as opposed to textual read/writes
- [14.5.5.27](#): We are caching XML by serialising using `saveXML()`, because PHP cannot serialise DOM objects; Some of the XML is variable and is modified per-request. Do you recommend caching then using XPath, or is it better to rebuild the DOM from separate node-groups?
- [14.5.5.28](#): Do the `memcache` UDFs work under 5.1?
- [14.5.5.29](#): How are auto-increment columns in the MySQL database coordinated across multiple instances of `memcached`?
- [14.5.5.30](#): If you log a complex class (with methods that do calculation etc) will the get from Memcache re-create the class on the way out?

## Questions and Answers

### **14.5.5.1: How does an event such as a crash of one of the `memcached` servers handled by the `memcached` client?**

There is no automatic handling of this. If your client fails to get a response from a server then it should fall back to loading the data from the MySQL database.

The client APIs all provide the ability to add and remove `memcached` instances on the fly. If within your application you notice that `memcached` server is no longer responding, you can remove the server from the list of servers, and keys will automatically be redistributed to another `memcached` server in the list. If retaining the cache content on all your servers is important, make sure you use an API that supports a consistent hashing algorithm. For more information, see [Section 14.5.2.4](#), “`memcached` Distribution Types”.

### **14.5.5.2: Are there any, or are there any plans to introduce, a framework to hide the interaction of `memcached` from the application, i.e., within hibernate?**

There are lots of projects working with `memcached`. There is a Google Code implementation of Hibernate and `memcached` working together. See <http://code.google.com/p/hibernate-memcached/>.

### **14.5.5.3: What's a recommended hardware config for a `memcached` server? Linux or Windows?**

`memcached` is only available on Unix/Linux, so using a Windows machine is not an option. Outside of this, `memcached` has a very low processing overhead. All that is required is spare physical RAM capacity. The point is not that you should necessarily deploy a dedicated `memcached` server. If you have web, application, or database servers that have spare RAM capacity, then use them with `memcached`.

If you want to build and deploy a dedicated `memcached` servers, then you use a relatively low-power CPU, lots of RAM and one or more Gigabit Ethernet interfaces.

### **14.5.5.4: How expensive is it to establish a memcache connection? Should those connections be pooled?**

Opening the connection is relatively inexpensive, because there is no security, authentication or other handshake taking place before you can start sending requests and getting results. Most APIs support a persistent connection to a `memcached` instance to reduce the latency. Connection pooling would depend on the API you are using, but if you are communicating directly over TCP/IP, then connection pooling would provide some small performance benefit.

**14.5.5.5: How will the data will be handled when the `memcached` server is down?**

The behavior is entirely application dependent. Most applications will fall back to loading the data from the database (just as if they were updating the `memcached`) information. If you are using multiple `memcached` servers, you may also want to remove a server from the list to prevent the missing server affecting performance. This is because the client will still attempt to communicate the `memcached` that corresponds to the key you are trying to load.

**14.5.5.6: Can memcached be run on a Windows environment?**

No. Currently `memcached` is available only on the Unix/Linux platform. There is an unofficial port available, see <http://www.codeplex.com/memcachedproviders>.

**14.5.5.7: What is the max size of an object you can store in memcache and is that configurable?**

The default maximum object size is 1MB. If you want to increase this size, you have to re-compile `memcached`. You can modify the value of the `POWER_BLOCK` within the `slabs.c` file within the source.

**14.5.5.8: Is it true `memcached` will be much more effective with db-read-intensive applications than with db-write-intensive applications?**

Yes. `memcached` plays no role in database writes, it is a method of caching data already read from the database in RAM.

**14.5.5.9: What are best practices for testing an implementation, to ensure that it is an improvement over the MySQL query cache, and to measure the impact of `memcached` configuration changes? And would you recommend keeping the configuration very simple to start?**

The best way to test the performance is to start up a `memcached` instance. First, modify your application so that it stores the data just before the data is about to be used or displayed into `memcached`. Since the APIs handle the serialization of the data, it should just be a one line modification to your code. Then, modify the start of the process that would normally load that information from MySQL with the code that requests the data from `memcached`. If the data cannot be loaded from `memcached`, default to the MySQL process.

All of the changes required will probably amount to just a few lines of code. To get the best benefit, make sure you cache entire objects (for example, all the components of a web page, blog post, discussion thread, etc.), rather than using `memcached` as a simple cache of individuals rows of MySQL tables. You should see performance benefits almost immediately.

Keeping the configuration very simple at the start, or even over the long term, is very easy with `memcached`. Once you have the basic structure up and running, the only addition you may want to make is to add more servers into the list of servers used by your clients. You don't need to manage the `memcached` servers, and there is no complex configuration, just add more servers to the list and let the client API and the `memcached` servers make the decisions.

**14.5.5.10: Can MySQL actually trigger/store the changed data to memcached?**

Yes. You can use the MySQL UDFs for `memcached` and either write statements that directly set the values in the `memcached` server, or use triggers or stored procedures to do it for you. For more information, see [Section 14.5.3.7, "Using the MySQL memcached UDFs"](#)

**14.5.5.11: So the responsibility lies with the application to populate and get records from the database as opposed to being a transparent cache layer for the db?**

Yes. You load the data from the database and write it into the cache provided by `memcached`. Using `memcached` as a simple database row cache, however, is probably inefficient. The best way to use `memcached` is to load all of the information from the database relating to a particular object, and then cache the entire object. For example, in a blogging environment, you might load the blog, associated comments, categories and so on, and then cache all of the information relating to that blog post. The reading of the data from the database will require multiple SQL statements and probably multiple rows of data to complete, which is time consuming. Loading the entire blog post and the associated information from `memcached` is just one operation and doesn't involve using the disk or parsing the SQL statement.

**14.5.5.12: `memcached` is fast - is there any overhead in not using persistent connections? If persistent is always recommended, what are the downsides (e.g. locking up?)**

If you don't use persistent connections when communicating with `memcached` then there will be a small increase in the latency of opening the connection each time. The effect is comparable to use non-persistent connections with MySQL.

In general, the chance of locking or other issues with persistent connections is minimal, because there is very little locking within `memcached`. If there is a problem then eventually your request will timeout and return no result so your application will need to

load from MySQL again.

**14.5.5.13: Is compression available?**

Yes. Most of the client APIs support some sort of compression, and some even allow you to specify the threshold at which a value is deemed appropriate for compression during storage.

**14.5.5.14: File socket support for memcached from the localhost use to the local memcached server?**

You can use the `-s` option to `memcached` to specify the location of a file socket. This automatically disables network support.

**14.5.5.15: What are the advantages of using UDFs when the get/sets are manageable from within the client code rather than the db?**

Sometimes you want to be able to update the information within `memcached` based on a generic database activity, rather than relying on your client code. For example, you may want to update status or counter information in `memcached` through the use of a trigger or stored procedure. For some situations and applications the existing use of a stored procedure for some operations means that updating the value in `memcached` from the database is easier than separately loading and communicating that data to the client just so the client can talk to `memcached`.

In other situations, when you are using a number of different clients and different APIs, you don't want to have to write (and maintain) the code required to update `memcached` in all the environments. Instead, you do this from within the database and the client never gets involved.

**14.5.5.16: Is memcached typically a better solution for improving speed than MySQL Cluster and/or MySQL Proxy?**

Both MySQL Cluster and MySQL Proxy still require access to the underlying database to retrieve the information. This implies both a parsing overhead for the statement and, often, disk based access to retrieve the data you have selected.

The advantage of `memcached` is that you can store entire objects or groups of information that may require multiple SQL statements to obtain. Restoring the result of 20 SQL statements formatted into a structure that your application can use directly without requiring any additional processing is always going to be faster than building that structure by loading the rows from a database.

**14.5.5.17: What speed trade offs is there between memcached vs MySQL Query Cache? Where you check memcached, and get data from MySQL and put it in memcached or just make a query and results are put into MySQL Query Cache.**

In general, the time difference between getting data from the MySQL Query Cache and getting the exact same data from `memcached` is very small.

However, the benefit of `memcached` is that you can store any information, including the formatted and processed results of many queries into a single `memcached` key. Even if all the queries that you executed could be retrieved from the Query Cache without having to go to disk, you would still be running multiple queries (with network and other overhead) compared to just one for the `memcached` equivalent. If your application uses objects, or does any kind of processing on the information, with `memcached` you can store the post-processed version, so the data you load is immediately available to be used. With data loaded from the Query Cache, you would still have to do that processing.

In addition to these considerations, keep in mind that keeping data in the MySQL Query Cache is difficult as you have no control over the queries that are stored. This means that a slightly unusual query can temporarily clear a frequently used (and normally cached) query, reducing the effectiveness of your Query Cache. With `memcached` you can specify which objects are stored, when they are stored, and when they should be deleted giving you much more control over the information stored in the cache.

**14.5.5.18: Does the -L flag automatically sense how much memory is being used by other memcached?**

No. There is no communication or sharing of information between `memcached` instances.

**14.5.5.19: Is the data inside of memcached secure?**

No, there is no security required to access or update the information within a `memcached` instance, which means that anybody with access to the machine has the ability to read, view and potentially update the information. If you want to keep the data secure, you can encrypt and decrypt the information before storing it. If you want to restrict the users capable of connecting to the server, your only choice is to either disable network access, or use IPTables or similar to restrict access to the `memcached` ports to a select set of hosts.

**14.5.5.20: Can we implement different types of memcached as different nodes in the same server - so can there be deterministic and non deterministic in the same server?**

Yes. You can run multiple instances of `memcached` on a single server, and in your client configuration you choose the list of servers you want to use.

**14.5.5.21: How easy is it to introduce memcached to an existing enterprise application instead of inclusion at project design?**

In general, it is very easy. In many languages and environments the changes to the application will be just a few lines, first to attempt to read from the cache when loading data and then fall back to the old method, and to update the cache with information once the data has been read.

`memcached` is designed to be deployed very easily, and you shouldn't require significant architectural changes to your application to use `memcached`.

#### **14.5.5.22: Can `memcached` work with ASPX?**

There are ports and interfaces for many languages and environments. ASPX relies on an underlying language such as C# or Visual-Basic, and if you are using ASP.NET then there is a C# `memcached` library. For more information, see .

#### **14.5.5.23: If I have an object larger than a MB, do I have to manually split it or can I configure `memcached` to handle larger objects?**

You would have to manually split it. `memcached` is very simple, you give it a key and some data, it tries to cache it in RAM. If you try to store more than the default maximum size, the value is just truncated for speed reasons.

#### **14.5.5.24: How does `memcached` compare to nCache?**

The main benefit of `memcached` is that is very easy to deploy and works with a wide range of languages and environments, including .NET, Java, Perl, Python, PHP, even MySQL. `memcached` is also very lightweight in terms of systems and requirements, and you can easily add as many or as few `memcached` servers as you need without changing the individual configuration. `memcached` does require additional modifications to the application to take advantage of functionality such as multiple `memcached` servers.

#### **14.5.5.25: Doing a direct telnet to the memcached port, is that just for that one machine, or does it magically apply across all nodes?**

Just one. There is no communication between different instances of `memcached`, even if each instance is running on the same machine.

#### **14.5.5.26: Is memcached more effective for video and audio as opposed to textual read/writes**

`memcached` doesn't care what information you are storing. To `memcached`, any value you store is just a stream of data. Remember, though, that the maximum size of an object you can store in `memcached` without modifying the source code is 1MB, so its usability with audio and video content is probably significantly reduced. Also remember that `memcached` is a solution for caching information for reading. It shouldn't be used for writes, except when updating the information in the cache.

#### **14.5.5.27: We are caching XML by serialising using `saveXML()`, because PHP cannot serialise DOM objects; Some of the XML is variable and is modified per-request. Do you recommend caching then using XPath, or is it better to rebuild the DOM from separate node-groups?**

You would need to test your application using the different methods to determine this information. You may find that the default serialization within PHP may allow you to store DOM objects directly into the cache.

#### **14.5.5.28: Do the memcache UDFs work under 5.1?**

Yes.

#### **14.5.5.29: How are auto-increment columns in the MySQL database coordinated across multiple instances of memcached?**

They aren't. There is no relationship between MySQL and `memcached` unless your application (or, if you are using the MySQL UDFs for `memcached`, your database definition) creates one.

If you are storing information based on an auto-increment key into multiple instances of `memcached` then the information will only be stored on one of the `memcached` instances anyway. The client uses the key value to determine which `memcached` instance to store the information, it doesn't store the same information across all the instances, as that would be a waste of cache memory.

#### **14.5.5.30: If you log a complex class (with methods that do calculation etc) will the get from Memcache re-create the class on the way out?**

In general, yes. If the serialization method within the API/language that you are using supports it, then methods and other information will be stored and retrieved.

## **14.6. MySQL Proxy**

The MySQL Proxy is an application that communicates over the network using the MySQL Network Protocol and provides communication between one or more MySQL servers and one or more MySQL clients. In the most basic configuration, MySQL Proxy

simply passes on queries from the client to the MySQL Server and returns the responses from the MySQL Server to the client.

Because MySQL Proxy uses the MySQL network protocol, any MySQL compatible client (include the command line client, any clients using the MySQL client libraries, and any connector that supports the MySQL network protocol) can connect to the proxy without modification.

In addition to the basic pass-through configuration, the MySQL Proxy is also capable of monitoring and altering the communication between the client and the server. This interception of the queries enables you to add profiling, and the interception of the exchanges is scriptable using the Lua scripting language.

By intercepting the queries from the client, the proxy can insert additional queries into the list of queries sent to the server, and remove the additional results when they are returned by the server. Using this functionality you can add informational statements to each query, for example to monitor their execution time or progress, and separately log the results, while still returning the results from the original query to the client.

The proxy allows you to perform additional monitoring, filtering or manipulation on queries without you having to make any modifications to the client and without the client even being aware that it is communicating with anything but a genuine MySQL server.

### **Warning**

MySQL Proxy is currently an Alpha release and should not be used within production environments.

### **Important**

MySQL Proxy is compatible with MySQL 5.0.x or later. Testing has not been performed with Version 4.1. Please provide feedback on your experiences via the [MySQL Proxy Forum](#).

## 14.6.1. MySQL Proxy Supported Platforms

MySQL Proxy is currently available as a pre-compiled binary for the following platforms:

- Linux (including RedHat, Fedora, Debian, SuSE) and derivatives.
- Mac OS X
- FreeBSD
- IBM AIX
- Sun Solaris
- Microsoft Windows (including Microsoft Windows XP, and Microsoft Windows Server 2003)

Other Unix/Linux platforms not listed should be compatible by using the source package and building MySQL Proxy locally.

System requirements for the MySQL Proxy application are the same as the main MySQL server. Currently MySQL Proxy is compatible only with MySQL 5.0.1 and later. MySQL Proxy is provided as a standalone, statically linked binary. You do not need to have MySQL or Lua installed.

## 14.6.2. Installing MySQL Proxy

You have three choices for installing MySQL Proxy:

- Pre-compiled binaries are available for a number of different platforms. See [Section 14.6.2.1, “Installing MySQL Proxy from a binary distribution”](#).
- You can install from the source code if you want to build on an environment not supported by the binary distributions. See [Section 14.6.2.2, “Installing MySQL Proxy from a source distribution”](#).
- The latest version of the MySQL proxy source code is available through a development repository is the best way to stay up to date with the latest fixes and revisions. See [Section 14.6.2.3, “Installing MySQL Proxy from the Subversion repository”](#).

### 14.6.2.1. Installing MySQL Proxy from a binary distribution

If you download the binary packages then you need only to extract the package and then copy the `mysql-proxy` file to your desired location. For example:

```
shell> tar zxf mysql-proxy-0.5.0.tar.gz
shell> cp ./mysql-proxy-0.5.0/sbin/mysql-proxy /usr/local/sbin
```

### 14.6.2.2. Installing MySQL Proxy from a source distribution

If you have downloaded the source package then you will need to compile the MySQL Proxy before using it. To build you will need to have the following installed:

- [libevent](#) 1.x or higher (1.3b or later is preferred)
- [lua](#) 5.1.x or higher
- [glib2](#) 2.6.0 or higher
- [pkg-config](#)
- MySQL 5.0.x or higher developer files

#### Note

On some operating systems you may need to manually build the required components to get the latest version. If you are having trouble compiling MySQL Proxy then consider using one of the binary distributions.

Once these components are installed, you need to configure and then build:

```
shell> tar zxf mysql-proxy-0.5.0.tar.gz
shell> cd mysql-proxy-0.5.0
shell> ./configure
shell> make
```

If you want to test the build, then use the `check` target to `make`:

```
shell> make check
```

The tests try to connect to `localhost` using the `root` user. If you need to provide a password, set the `MYSQL_PASSWORD` environment variable:

```
shell> MYSQL_PASSWORD=root_pwd make check
```

You can install using the `install` target:

```
shell> make install
```

By default `mysql-proxy` is installed into `/usr/local/sbin/mysql-proxy`. The Lua example scripts are copied into `/usr/local/share`.

### 14.6.2.3. Installing MySQL Proxy from the Subversion repository

The MySQL Proxy source is available through a public Subversion repository and is the quickest way to get hold of the latest releases and fixes.

To build from the Subversion repository, you need the following components already installed:

- Subversion 1.3.0 or higher
- [libtool](#) 1.5 or higher
- [autoconf](#) 2.56 or higher
- [automake](#) 1.9 or higher
- [libevent](#) 1.x or higher (1.3b or later is preferred)
- [lua](#) 5.1.x or higher
- [glib2](#) 2.4.0 or higher



- `pkg-config`
- MySQL 5.0.x or higher developer files

To checkout a local copy of the Subversion repository, use `svn`:

```
shell> svn co http://svn.MySQL.com/svnpublic/mysql-proxy/ mysql-proxy
```

The above command will download a complete version of the Subversion repository for `mysql-proxy`. The main source files are located within the `trunk` subdirectory. The configuration scripts need to be generated before you can configure and build `mysql-proxy`. The `autogen.sh` script will generate the configuration scripts for you:

```
shell> sh ./autogen.sh
```

The script creates the standard `configure` script, which you can then use to configure and build with `make`:

```
shell> ./configure
shell> make
shell> make install
```

If you want to create a standalone source distribution, identical to the source distribution available for download:

```
shell> make distcheck
```

The above will create the file `mysql-proxy-0.5.0.tar.gz` within the current directory.

### 14.6.3. MySQL Proxy Command-Line Options

To start `mysql-proxy` you can just run the command directly. However, for most situations you will want to specify at the very least the address/host name and port number of the backend MySQL server to which the MySQL Proxy should pass on queries.

You can get a list of the supported command-line options using the `--help-all` command-line option. The majority of these options set up the environment, either in terms of the address/port number that `mysql-proxy` should listen on for connections, or the onward connection to a MySQL server. A full description of the options is shown below:

- `--help-all` — show all help options.
- `--help-admin` — show options for the admin-module.
- `--help-proxy` — Show options for the proxy-module.
- `--admin-address=host:port` — specify the host name (or IP address) and port for the administration port. The default is `localhost:4041`.
- `--proxy-address=host:port` — the listening host name (or IP address) and port of the proxy server. The default is `localhost:4040`.
- `--proxy-read-only-backend-address=host:port` — the listening host name (or IP address) and port of the proxy server for read-only connections. The default is for this information not to be set.
- `--proxy-backend-addresses=host:port` — the host name (or IP address) and port of the MySQL server to connect to. You can specify multiple backend servers by supplying multiple options. Clients are connected to each backend server in round-robin fashion. For example, if you specify two servers A and B, the first client connection will go to server A; the second client connection to server B and the third client connection to server A.
- `--proxy-skip-profiling` — disables profiling of queries (tracking time statistics). The default is for tracking to be enabled.
- `--proxy-fix-bug-25371` — gets round an issue when connecting to a MySQL server later than 5.1.12 when using a MySQL client library of any earlier version.
- `--proxy-lua-script=file` — specify the Lua script file to be loaded. Note that the script file is not physically loaded and parsed until a connection is made. Also note that the specified Lua script is reloaded for each connection; if the content of the Lua script changes while `mysql-proxy` is running then the updated content will automatically be used when a new connection is made.
- `--daemon` — starts the proxy in daemon mode.



- `--pid-file=file` — sets the name of the file to be used to store the process ID.
- `--version` — show the version number.

The most common usage is as a simple proxy service (i.e. without addition scripting). For basic proxy operation you must specify at least one `proxy-backend-addresses` option to specify the MySQL server to connect to by default:

```
shell> mysql-proxy
--proxy-backend-addresses=MySQL.example.com:3306
```

The default proxy port is `4040`, so you can connect to your MySQL server through the proxy by specifying the host name and port details:

```
shell> mysql --host=localhost --port=4040
```

If your server requires authentication information then this will be passed through natively without alteration by `mysql-proxy`, so you must also specify the authentication information if required:

```
shell> mysql --host=localhost --port=4040 \
--user=username --password=password
```

You can also connect to a read-only port (which filters out `UPDATE` and `INSERT` queries) by connecting to the read-only port. By default the host name is the default, and the port is `4042`, but you can alter the host/port information by using the `-proxy-read-only-address` command-line option.

For more detailed information on how to use these command line options, and `mysql-proxy` in general in combination with Lua scripts, see [Section 14.6.5, “Using MySQL Proxy”](#).

## 14.6.4. MySQL Proxy Scripting

You can control how MySQL Proxy manipulates and works with the queries and results that are passed on to the MySQL server through the use of the embedded Lua scripting language. You can find out more about the Lua programming language from the [Lua Website](#).

The primary interaction between MySQL Proxy and the server is provided by defining one or more functions through an Lua script. A number of functions are supported, according to different events and operations in the communication sequence between a client and one or more backend MySQL servers:

- `connect_server()` — this function is called each time a connection is made to MySQL Proxy from a client. You can use this function during load-balancing to intercept the original connection and decide which server the client should ultimately be attached to. If you do not define a special solution, then a simple round-robin style distribution is used by default.
- `read_handshake()` — this function is called when the initial handshake information is returned by the server. You can capture the handshake information returned and provide additional checks before the authorization exchange takes place.
- `read_auth()` — this function is called when the authorization packet (user name, password, default database) are submitted by the client to the server for authentication.
- `read_auth_result()` — this function is called when the server returns an authorization packet to the client indicating whether the authorization succeeded.
- `read_query()` — this function is called each time a query is sent by the client to the server. You can use this to edit and manipulate the original query, including adding new queries before and after the original statement. You can also use this function to return information directly to the client, bypassing the server, which can be useful to filter unwanted queries or queries that exceed known limits.
- `read_query_result()` — this function is called each time a result is returned from the server, providing you have manually injected queries into the query queue. If you have not explicitly inject queries within the `read_query()` function then this function is not triggered. You can use this to edit the result set, or to remove or filter the result sets generated from additional queries you injected into the queue when using `read_query()`.

The table below describes the direction of flow of information at the point when the function is triggered.

Function	Supplied Information	Direction
<code>connect_server()</code>	None	Client to Server
<code>read_handshake()</code>	Handshake packet	Server to Client

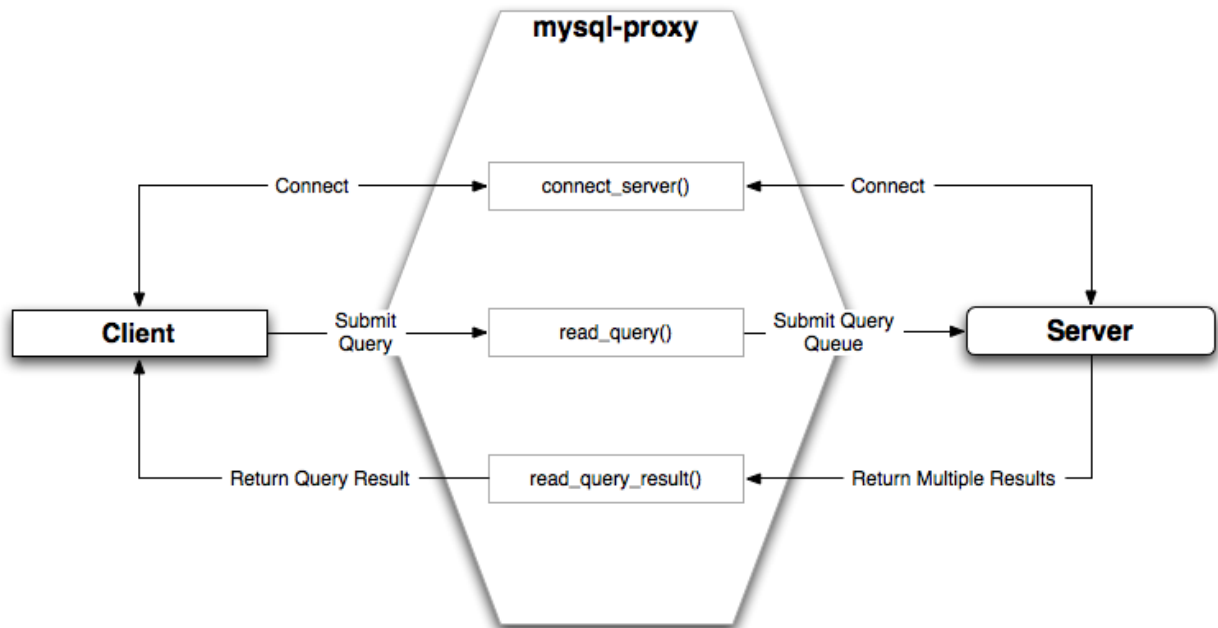
Function	Supplied Information	Direction
<code>read_auth()</code>	Authorization packet	Client to Server
<code>read_auth_result()</code>	Authorization response	Server to Client
<code>read_query()</code>	Query	Client to Server
<code>read_query_result()</code>	Query result	Server to Client

By default, all functions return a result that indicates that the data should be passed on to the client or server (depending on the direction of the information being transferred). This return value can be overridden by explicitly returning a constant indicating that a particular response should be sent. For example, it is possible to construct result set information by hand within `read_query()` and to return the resultset directly to the client without ever sending the original query to the server.

In addition to these functions, a number of built-in structures provide control over how MySQL Proxy forwards on queries and returns the results by providing a simplified interface to elements such as the list of queries and the groups of result sets that are returned.

### 14.6.4.1. Proxy Scripting Sequence During Query Injection

The figure below gives an example of how the proxy might be used when injecting queries into the query queue. Because the proxy sits between the client and MySQL server, what the proxy sends to the server, and the information that the proxy ultimately returns to the client do not have to match or correlate. Once the client has connected to the proxy, the following sequence occurs for each individual query sent by the client.



1. The client submits one query to the proxy, the `read_query()` function within the proxy is triggered. The function adds the query to the query queue.
2. Once manipulation by `read_query()` has completed, the queries are submitted, sequentially, to the MySQL server.
3. The MySQL server returns the results from each query, one result set for each query submitted. The `read_query_result()` function is triggered for each result set, and each invocation can decide which result set to return to the client

For example, you can queue additional queries into the global query queue to be processed by the server. This can be used to add statistical information by adding queries before and after the original query, changing the original query:

```
SELECT * FROM City;
```

Into a sequence of queries:

```
SELECT NOW();
```

```
SELECT * FROM City;
SELECT NOW();
```

You can also modify the original statement, for example to add `EXPLAIN` to each statement executed to get information on how the statement was processed, again altering our original SQL statement into a number of statements:

```
SELECT * FROM City;
EXPLAIN SELECT * FROM City;
```

In both of these examples, the client would have received more result sets than expected. Regardless of how you manipulate the incoming query and the returned result, the number of queries returned by the proxy must match the number of original queries sent by the client.

You could adjust the client to handle the multiple result sets sent by the proxy, but in most cases you will want the existence of the proxy to remain transparent. To ensure that the number of queries and result sets match, you can use the MySQL Proxy `read_query_result()` to extract the additional result set information and return only the result set the client originally requested back to the client. You can achieve this by giving each query that you add to the query queue a unique ID, and then filter out queries that do not match the original query ID when processing them with `read_query_result()`.

### 14.6.4.2. Internal Structures

There are a number of internal structures within the scripting element of MySQL Proxy. The primary structure is `proxy` and this provides an interface to the many common structures used throughout the script, such as connection lists and configured backend servers. Other structures, such as the incoming packet from the client and result sets are only available within the context of one of the scriptable functions.

Attribute	Description
<code>connection</code>	A structure containing the active client connections. For a list of attributes, see <code>proxy.connection</code> .
<code>servers</code>	A structure containing the list of configured backend servers. For a list of attributes, see <code>proxy.backends</code> .
<code>queries</code>	A structure containing the queue of queries that will be sent to the server during a single client query. For a list of attributes, see <code>proxy.queries</code> .
<code>PROXY_VERSION</code>	The version number of MySQL Proxy, encoded in hex. You can use this to check that the version number supports a particular option from within the Lua script. Note that the value is encoded as a hex value, so to check the version is at least 0.5.1 you compare against <code>0x00501</code> .

#### `proxy.connection`

The `proxy.connection` object is read only, and provides information about the current connection.

Attribute	Description
<code>thread_id</code>	The thread ID of the connection.
<code>backend_ndx</code>	The ID of the server used for this connection. This is an ID valid against the list of configured servers available through the <code>proxy.backends</code> object.

#### `proxy.backends`

The `proxy.backends` table is partially writable and contains an array of all the configured backend servers and the server metadata (IP address, status, etc.). You can determine the array index of the current connection using `proxy.connection["backend_ndx"]` which is the index into this table of the backend server being used by the active connection.

The attributes for each entry within the `proxy.backends` table are shown in this table.

Attribute	Description
<code>address</code>	The host name/port combination used for this connection
<code>connected_clients</code>	The number of clients currently connected.
<code>state</code>	The status of the backend server. See <a href="#">Section 14.6.4.2, “Internal Structures” [1201]</a>

#### `proxy.queries`

The `proxy.queries` object is a queue representing the list of queries to be sent to the server. The queue is not populated automatically, but if you do not explicitly populate the queue then queries are passed on to the backend server verbatim. Also, if you do not populate the query queue by hand, then the `read_query_result()` function is not triggered.

The following methods are supported for populating the `proxy.queries` object.

Function	Description
<code>append(id,packet)</code>	Appends a query to the end of the query queue. The <code>id</code> is an integer identifier that you can use to recognize the query results when they are returned by the server. The packet should be a properly formatted query packet.
<code>prepend(id,packet)</code>	Prepends a query to the query queue. The <code>id</code> is an identifier that you can use to recognize the query results when they are returned by the server. The packet should be a properly formatted query packet.
<code>reset()</code>	Empties the query queue.
<code>len()</code>	Returns the number of query packets in the queue.

For example, you could append a query packet to the `proxy.queries` queue by using the `append()`:

```
proxy.queries:append(1,packet)
```

### proxy.response

The `proxy.response` structure is used when you want to return your own MySQL response, instead of forwarding a packet that you have received a backend server. The structure holds the response type information, an optional error message, and the result set (rows/columns) that you want to return.

Attribute	Description
<code>type</code>	The type of the response. The type must be either <code>MYSQLD_PACKET_OK</code> or <code>MYSQLD_PACKET_ERR</code> . If the <code>MYSQLD_PACKET_ERR</code> , then you should set the value of the <code>mysql.response.errmsg</code> with a suitable error message.
<code>errmsg</code>	A string containing the error message that will be returned to the client.
<code>resultset</code>	A structure containing the result set information (columns and rows), identical to what would be returned when returning a results from a <code>SELECT</code> query.

When using `proxy.response` you either set `proxy.response.type` to `proxy.MYSQLD_PACKET_OK` and then build `resultset` to contain the results that you want to return, or set `proxy.response.type` to `proxy.MYSQLD_PACKET_ERR` and set the `proxy.response.errmsg` to a string with the error message. To send the completed resultset or error message, you should return the `proxy.PROXY_SEND_RESULT` to trigger the return of the packet information.

An example of this can be seen in the `tutorial-resultset.lua` script within the MySQL Proxy package:

```
if string.lower(command) == "show" and string.lower(option) == "querycounter" then
    ---
    -- proxy.PROXY_SEND_RESULT requires
    --
    -- proxy.response.type to be either
    -- * proxy.MYSQLD_PACKET_OK or
    -- * proxy.MYSQLD_PACKET_ERR
    --
    -- for proxy.MYSQLD_PACKET_OK you need a resultset
    -- * fields
    -- * rows
    --
    -- for proxy.MYSQLD_PACKET_ERR
    -- * errmsg
    proxy.response.type = proxy.MYSQLD_PACKET_OK
    proxy.response.resultset = {
        fields = {
            { type = proxy.MYSQL_TYPE_LONG, name = "global_query_counter", },
            { type = proxy.MYSQL_TYPE_LONG, name = "query_counter", },
        },
        rows = {
            { proxy.global.query_counter, query_counter }
        }
    }

    -- we have our result, send it back
    return proxy.PROXY_SEND_RESULT
elseif string.lower(command) == "show" and string.lower(option) == "myerror" then
    proxy.response.type = proxy.MYSQLD_PACKET_ERR
    proxy.response.errmsg = "my first error"

    return proxy.PROXY_SEND_RESULT
```

**proxy.response.resultset**

The `proxy.response.resultset` structure should be populated with the rows and columns of data that you want to return. The structure contains the information about the entire result set, with the individual elements of the data shown in the table below.

Attribute	Description
<code>fields</code>	The definition of the columns being returned. This should be a dictionary structure with the <code>type</code> specifying the MySQL data type, and the <code>name</code> specifying the column name. Columns should be listed in the order of the column data that will be returned.
<code>flags</code>	A number of flags related to the resultset. Valid flags include <code>auto_commit</code> (whether an automatic commit was triggered), <code>no_good_index_used</code> (the query executed without using an appropriate index), and <code>no_index_used</code> (the query executed without using any index).
<code>rows</code>	The actual row data. The information should be returned as an array of arrays. Each inner array should contain the column data, with the outer array making up the entire result set.
<code>warning_count</code>	The number of warnings for this result set.
<code>affected_rows</code>	The number of rows affected by the original statement.
<code>insert_id</code>	The last insert ID for an auto-incremented column in a table.
<code>query_status</code>	The status of the query operation. You can use the <code>MYSQLD_PACKET_OK</code> or <code>MYSQLD_PACKET_ERR</code> constants to populate this parameter.

For an example of the population of this table, see [Section 14.6.4.2, “Internal Structures” \[1200\]](#).

**Proxy Return State Constants**

The following constants are used internally by the proxy to specify the response to send to the client or server. All constants are exposed as values within the main `proxy` table.

Constant	Description
<code>PROXY_SEND_QUERY</code>	Causes the proxy to send the current contents of the queries queue to the server.
<code>PROXY_SEND_RESULT</code>	Causes the proxy to send a result set back to the client.
<code>PROXY_IGNORE_RESULT</code>	Causes the proxy to drop the result set (nothing is returned to the client).

As constants, these entities are available without qualification in the Lua scripts. For example, at the end of the `read_query_result()` you might return `PROXY_IGNORE_RESULT`:

```
return proxy.PROXY_IGNORE_RESULT
```

**Packet State Constants**

The following states describe the status of a network packet. These items are entries within the main `proxy` table.

Constant	Description
<code>MYSQLD_PACKET_OK</code>	The packet is OK.
<code>MYSQLD_PACKET_ERR</code>	The packet contains error information.
<code>MYSQLD_PACKET_RAW</code>	The packet contains raw data.

**Backend State/Type Constants**

The following constants are used either to define the status of the backend server (the MySQL server to which the proxy is connected) or the type of backend server. These items are entries within the main `proxy` table.

Constant	Description
<code>BACKEND_STATE_UNKNOWN</code>	The current status is unknown.
<code>BACKEND_STATE_UP</code>	The backend is known to be up (available).
<code>BACKEND_STATE_DOWN</code>	The backend is known to be down (unavailable).
<code>BACKEND_TYPE_UNKNOWN</code>	Backend type is unknown.

Constant	Description
BACKEND_TYPE_RW	Backend is available for read/write.
BACKEND_TYPE_RO	Backend is available only for read-only use.

### Server Command Constants

The following values are used in the packets exchanged between the client and server to identify the information in the rest of the packet. These items are entries within the main `proxy` table. The packet type is defined as the first character in the sent packet. For example, when intercepting packets from the client to edit or monitor a query you would check that the first byte of the packet was of type `proxy.COM_QUERY`.

Constant	Description
COM_SLEEP	Sleep
COM_QUIT	Quit
COM_INIT_DB	Initialize database
COM_QUERY	Query
COM_FIELD_LIST	Field List
COM_CREATE_DB	Create database
COM_DROP_DB	Drop database
COM_REFRESH	Refresh
COM_SHUTDOWN	Shutdown
COM_STATISTICS	Statistics
COM_PROCESS_INFO	Process List
COM_CONNECT	Connect
COM_PROCESS_KILL	Kill
COM_DEBUG	Debug
COM_PING	Ping
COM_TIME	Time
COM_DELAYED_INSERT	Delayed insert
COM_CHANGE_USER	Change user
COM_BINLOG_DUMP	Binlog dump
COM_TABLE_DUMP	Table dump
COM_CONNECT_OUT	Connect out
COM_REGISTER_SLAVE	Register slave
COM_STMT_PREPARE	Prepare server-side statement
COM_STMT_EXECUTE	Execute server-side statement
COM_STMT_SEND_LONG_DATA	Long data
COM_STMT_CLOSE	Close server-side statement
COM_STMT_RESET	Reset statement
COM_SET_OPTION	Set option
COM_STMT_FETCH	Fetch statement
COM_DAEMON	Daemon (MySQL 5.1 only)
COM_ERROR	Error

### MySQL Type Constants

These constants are used to identify the field types in the query result data returned to clients from the result of a query. These items are entries within the main `proxy` table.

Constant	Field Type
MYSQL_TYPE_DECIMAL	Decimal
MYSQL_TYPE_NEWDECIMAL	Decimal (MySQL 5.0 or later)

Constant	Field Type
<code>MYSQL_TYPE_TINY</code>	Tiny
<code>MYSQL_TYPE_SHORT</code>	Short
<code>MYSQL_TYPE_LONG</code>	Long
<code>MYSQL_TYPE_FLOAT</code>	Float
<code>MYSQL_TYPE_DOUBLE</code>	Double
<code>MYSQL_TYPE_NULL</code>	Null
<code>MYSQL_TYPE_TIMESTAMP</code>	Timestamp
<code>MYSQL_TYPE_LONGLONG</code>	Long long
<code>MYSQL_TYPE_INT24</code>	Integer
<code>MYSQL_TYPE_DATE</code>	Date
<code>MYSQL_TYPE_TIME</code>	Time
<code>MYSQL_TYPE_DATETIME</code>	Datetime
<code>MYSQL_TYPE_YEAR</code>	Year
<code>MYSQL_TYPE_NEWDATE</code>	Date (MySQL 5.0 or later)
<code>MYSQL_TYPE_ENUM</code>	Enumeration
<code>MYSQL_TYPE_SET</code>	Set
<code>MYSQL_TYPE_TINY_BLOB</code>	Tiny Blob
<code>MYSQL_TYPE_MEDIUM_BLOB</code>	Medium Blob
<code>MYSQL_TYPE_LONG_BLOB</code>	Long Blob
<code>MYSQL_TYPE_BLOB</code>	Blob
<code>MYSQL_TYPE_VAR_STRING</code>	Varstring
<code>MYSQL_TYPE_STRING</code>	String
<code>MYSQL_TYPE_TINY</code>	Tiny (compatible with <code>MYSQL_TYPE_CHAR</code> )
<code>MYSQL_TYPE_ENUM</code>	Enumeration (compatible with <code>MYSQL_TYPE_INTERVAL</code> )
<code>MYSQL_TYPE_GEOMETRY</code>	Geometry
<code>MYSQL_TYPE_BIT</code>	Bit

#### 14.6.4.3. Capturing a connection with `connect_server()`

When the proxy accepts a connection from a MySQL client, the `connect_server()` function is called.

There are no arguments to the function, but you can use and if necessary manipulate the information in the `proxy.connection` table, which is unique to each client session.

For example, if you have multiple backend servers then you can set the server to be used by that connection by setting the value of `proxy.connection.backend_ndx` to a valid server number. The code below will choose between two servers based on whether the current time in minutes is odd or even:

```
function connect_server()
    print("--> a client really wants to talk to a server")
    if (tonumber(os.date("%M")) % 2 == 0) then
        proxy.connection.backend_ndx = 2
        print("Choosing backend 2")
    else
        proxy.connection.backend_ndx = 1
        print("Choosing backend 1")
    end
    print("Using " .. proxy.backends[proxy.connection.backend_ndx].address)
end
```

In this example the IP address/port combination is also displayed by accessing the information from the internal `proxy.backends` table.

#### 14.6.4.4. Examining the handshake with `read_handshake()`

Handshake information is sent by the server to the client after the initial connection (through `connect_server()`) has been made. The handshake information contains details about the MySQL version, the ID of the thread that will handle the connection information, and the IP address of the client and server. This information is exposed through a Lua table as the only argument to the

function.

- `mysqld_version` — the version of the MySQL server.
- `thread_id` — the thread ID.
- `scramble` — the password scramble buffer.
- `server_addr` — the IP address of the server.
- `client_addr` — the IP address of the client.

For example, you can print out the handshake data and refuse clients by IP address with the following function:

```
function read_handshake( auth )
  print("<-- let's send him some information about us")
  print("  mysqld-version: " .. auth.mysqld_version)
  print("  thread-id      : " .. auth.thread_id)
  print("  scramble-buf   : " .. string.format("%q", auth.scramble))
  print("  server-addr    : " .. auth.server_addr)
  print("  client-addr    : " .. auth.client_addr)

  if not auth.client_addr:match("^127.0.0.1:") then
    proxy.response.type = proxy.MYSQLD_PACKET_ERR
    proxy.response.errmsg = "only local connects are allowed"

    print("we don't like this client");

    return proxy.PROXY_SEND_RESULT
  end
end
```

Note that you have to return an error packet to the client by using `proxy.PROXY_SEND_RESULT`.

#### 14.6.4.5. Examining the authentication credentials with `read_auth()`

The `read_auth()` function is triggered when an authentication handshake is initiated by the client. In the execution sequence, `read_auth()` occurs immediately after `read_handshake()`, so the server selection has already been made, but the connection and authorization information has not yet been provided to the backend server.

The function accepts a single argument, an Lua table containing the authorization information for the handshake process. The entries in the table are:

- `username` — the user login for connecting to the server.
- `password` — the password, encrypted, to be used when connecting.
- `default_db` — the default database to be used once the connection has been made.

For example, you can print the user name and password supplied during authorization using:

```
function read_auth( auth )
  print("  username      : " .. auth.username)
  print("  password     : " .. string.format("%q", auth.password))
end
```

You can interrupt the authentication process within this function and return an error packet back to the client by constructing a new packet and returning `proxy.PROXY_SEND_RESULT`:

```
proxy.response.type = proxy.MYSQLD_PACKET_ERR
proxy.response.errmsg = "Logins are not allowed"
return proxy.PROXY_SEND_RESULT
```

#### 14.6.4.6. Accessing authentication information with `read_auth_result()`

The return packet from the server during authentication is captured by `read_auth_result()`. The only argument to this function is the authentication packet returned by the server. As the packet is a raw MySQL network protocol packet, you must access the first byte to identify the packet type and contents. The `MYSQLD_PACKET_ERR` and `MYSQLD_PACKET_OK` constants can be used to identify whether the authentication was successful:

```
function read_auth_result( auth )
  local state = auth.packet:byte()
```



```

if state == proxy.MYSQLD_PACKET_OK then
    print("<-- auth ok");
elseif state == proxy.MYSQLD_PACKET_ERR then
    print("<-- auth failed");
else
    print("<-- auth ... don't know: " .. string.format("%q", auth.packet));
end
end

```

#### 14.6.4.7. Manipulating Queries with `read_query()`

The `read_query()` function is called once for each query submitted by the client and accepts a single argument, the query packet that was provided. To access the content of the packet you must parse the packet contents manually.

For example, you can intercept a query packet and print out the contents using the following function definition:

```

function read_query( packet )
    if packet:byte() == proxy.COM_QUERY then
        print("we got a normal query: " .. packet:sub(2))
    end
end

```

This example checks the first byte of the packet to determine the type. If the type is `COM_QUERY` (see [Section 14.6.4.2, "Internal Structures" \[1202\]](#)), then we extract the query from the packet and print it out. The structure of the packet type supplied is important. In the case of a `COM_QUERY` packet, the remaining contents of the packet are the text of the query string. In this example, no changes have been made to the query or the list of queries that will ultimately be sent to the MySQL server.

To modify a query, or add new queries, you must populate the query queue (`proxy.queries`) and then execute the queries that you have placed into the queue. If you do not modify the original query or the queue, then the query received from the client is sent to the MySQL server verbatim.

When adding queries to the queue, you should follow these guidelines:

- The packets inserted into the queue must be valid query packets. For each packet, you must set the initial byte to the packet type. If you are appending a query, you can append the query statement to the rest of the packet.
- Once you add a query to the queue, the queue is used as the source for queries sent to the server. If you add a query to the queue to add more information, you must also add the original query to the queue or it will not be executed.
- Once the queue has been populated, you must set the return value from `read_query()` to indicate whether the query queue should be sent to the server.
- When you add queries to the queue, you should add an ID. The ID you specify is returned with the result set so that you identify each query and corresponding result set. The ID has no other purpose than as an identifier for correlating the query and result-set. When operating in a passive mode, during profiling for example, you want to identify the original query and the corresponding resultset so that the results expect by the client can be returned correctly.
- Unless your client is designed to cope with more result sets than queries, you should ensure that the number of queries from the client match the number of results sets returned to the client. Using the unique ID and removing result sets you inserted will help.

Normally, the `read_query()` and `read_query_result()` function are used in conjunction with each other to inject additional queries and remove the additional result sets. However, `read_query_result()` is only called if you populate the query queue within `read_query()`.

#### 14.6.4.8. Manipulating Results with `read_query_result()`

The `read_query_result()` is called for each result set returned by the server only if you have manually injected queries into the query queue. If you have not manipulated the query queue then this function is not called. The function supports a single argument, the result packet, which provides a number of properties:

- `id` — the ID of the result set, which corresponds to the ID that was set when the query packet was submitted to the server when using `append(id)` on the query queue.
- `query` — the text of the original query.
- `query_time` — the number of microseconds required to receive the first row of a result set.
- `response_time` — the number of microseconds required to receive the last row of the result set.

- `resultset` — the content of the result set data.

By accessing the result information from the MySQL server you can extract the results that match the queries that you injected, return different result sets (for example, from a modified query), and even create your own result sets.

The Lua script below, for example, will output the query, followed by the query time and response time (i.e. the time to execute the query and the time to return the data for the query) for each query sent to the server:

```
function read_query( packet )
    if packet:byte() == proxy.COM_QUERY then
        print("we got a normal query: " .. packet:sub(2))

        proxy.queries:append(1, packet )

        return proxy.PROXY_SEND_QUERY
    end
end

function read_query_result(inj)
    print("query-time: " .. (inj.query_time / 1000) .. "ms")
    print("response-time: " .. (inj.response_time / 1000) .. "ms")
end
```

You can access the rows of returned results from the resultset by accessing the rows property of the resultset property of the result that is exposed through `read_query_result()`. For example, you can iterate over the results showing the first column from each row using this Lua fragment:

```
for row in inj.resultset.rows do
    print("injected query returned: " .. row[1])
end
```

Just like `read_query()`, `read_query_result()` can return different values for each result according to the result returned. If you have injected additional queries into the query queue, for example, then you will want to remove the results returned from those additional queries and only return the results from the query originally submitted by the client.

The example below injects additional `SELECT NOW()` statements into the query queue, giving them a different ID to the ID of the original query. Within `read_query_result()`, if the ID for the injected queries is identified, we display the result row, and return the `proxy.PROXY_IGNORE_RESULT` from the function so that the result is not returned to the client. If the result is from any other query, we print out the query time information for the query and return the default, which passes on the result set unchanged. We could also have explicitly returned `proxy.PROXY_IGNORE_RESULT` to the MySQL client.

```
function read_query( packet )
    if packet:byte() == proxy.COM_QUERY then
        proxy.queries:append(2, string.char(proxy.COM_QUERY) .. "SELECT NOW()" )
        proxy.queries:append(1, packet )
        proxy.queries:append(2, string.char(proxy.COM_QUERY) .. "SELECT NOW()" )

        return proxy.PROXY_SEND_QUERY
    end
end

function read_query_result(inj)
    if inj.id == 2 then
        for row in inj.resultset.rows do
            print("injected query returned: " .. row[1])
        end
        return proxy.PROXY_IGNORE_RESULT
    else
        print("query-time: " .. (inj.query_time / 1000) .. "ms")
        print("response-time: " .. (inj.response_time / 1000) .. "ms")
    end
end
```

For further examples, see [Section 14.6.5, “Using MySQL Proxy”](#).

## 14.6.5. Using MySQL Proxy

There are a number of different ways to use MySQL Proxy. At the most basic level, you can allow MySQL Proxy to pass on queries from clients to a single server. To use MySQL proxy in this mode, you just have to specify the backend server that the proxy should connect to on the command line:

```
shell> mysql-proxy --proxy-backend-addresses=sakila:3306
```

If you specify multiple backend MySQL servers then the proxy will connect each client to each server in a round-robin fashion. For example, imagine you have two MySQL servers, A and B. The first client to connect will be connected to server A, the second to server B, the third to server C. For example:

```
shell> mysql-proxy \
--proxy-backend-addresses=narcissus:3306 \
--proxy-backend-addresses=nostromo:3306
```

When you have specified multiple servers in this way, the proxy will automatically identify when a MySQL server has become unavailable and mark it accordingly. New connections will automatically be attached to a server that is available, and a warning will be reported to the standard output from `mysql-proxy`:

```
network-mysqld.c.367: connect(nostromo:3306) failed: Connection refused
network-mysqld-proxy.c.2405: connecting to backend (nostromo:3306) failed, marking it as down for ...
```

Lua scripts enable a finer level of control, both over the connections and their distribution and how queries and result sets are processed. When using an Lua script, you must specify the name of the script on the command line using the `--proxy-lua-script` option:

```
shell> mysql-proxy --proxy-lua-script=mc.lua --proxy-backend-addresses=sakila:3306
```

When you specify a script, the script is not executed until a connection is made. This means that faults with the script will not be raised until the script is executed. Script faults will not affect the distribution of queries to backend MySQL servers.

### Note

Because the script is not read until the connection is made, you can modify the contents of the Lua script file while the proxy is still running and the script will automatically be used for the next connection. This ensures that MySQL Proxy remains available because it does not have to be restarted for the changes to take effect.

## 14.6.5.1. Using the Administration Interface

The `mysql-proxy` administration interface can be accessed using any MySQL client using the standard protocols. You can use the administration interface to gain information about the proxy server as a whole - standard connections to the proxy are isolated to operate as if you were connected directly to the backend MySQL server. Currently, the interface supports a limited set of functionality designed to provide connection and configuration information.

Because connectivity is provided over the standard MySQL protocol, you must access this information using SQL syntax. By default, the administration port is configured as 4041. You can change this port number using the `--admin-address` command-line option.

To get a list of the currently active connections to the proxy:

```
mysql> select * from proxy_connections;
+----+-----+-----+-----+
| id  | type  | state | db    |
+----+-----+-----+-----+
| 0   | server | 0     |      |
| 1   | proxy  | 0     |      |
| 2   | server | 10    |      |
+----+-----+-----+-----+
3 rows in set (0.00 sec)
```

To get the current configuration:

```
mysql> select * from proxy_config;
+-----+-----+
| option                    | value |
+-----+-----+
| admin.address              | :4041 |
| proxy.address              | :4040 |
| proxy.lua_script           | mc.lua |
| proxy.backend_addresses[0] | mysql:3306 |
| proxy.fix_bug_25371        | 0     |
| proxy.profiling            | 1     |
+-----+-----+
6 rows in set (0.01 sec)
```

## 14.6.6. MySQL Proxy FAQ

### Questions

- **14.6.6.1:** Is the system context switch expensive, how much overhead does the lua script add?
- **14.6.6.2:** How do I use a socket with MySQL Proxy? Proxy change logs mention that support for UNIX sockets has been added.

- [14.6.6.3](#): Can I use MySQL Proxy with all versions of MySQL?
- [14.6.6.4](#): If MySQL Proxy has to live on same machine as MySQL, are there any tuning considerations to ensure both perform optimally?
- [14.6.6.5](#): Do proxy applications run on a separate server? If not, what is the overhead incurred by Proxy on the DB server side?
- [14.6.6.6](#): Can MySQL Proxy handle SSL connections?
- [14.6.6.7](#): What is the limit for `max-connections` on the server?
- [14.6.6.8](#): As the script is re-read by proxy, does it cache this or is it looking at the file system with each request?
- [14.6.6.9](#): With load balancing, what happen to transactions ? Are all queries sent to the same server ?
- [14.6.6.10](#): Can I run MySQL Proxy as a daemon?
- [14.6.6.11](#): What about caching the authorization info so clients connecting are given back-end connections that were established with identical authorization information, thus saving a few more round trips?
- [14.6.6.12](#): Could MySQL Proxy be used to capture passwords?
- [14.6.6.13](#): Can MySQL Proxy be used on slaves and intercept binlog messages?
- [14.6.6.14](#): MySQL Proxy can handle about 5000 connections, what is the limit on a MySQL server?
- [14.6.6.15](#): How does MySQL Proxy compare to DBSlayer ?
- [14.6.6.16](#): I currently use SQL Relay for efficient connection pooling with a number of apache processes connecting to a MySQL server. Can MySQL proxy currently accomplish this. My goal is to minimize connection latency while keeping temporary tables available.
- [14.6.6.17](#): The global namespace variable example with quotas does not persist after a reboot, is that correct?
- [14.6.6.18](#): I tried using MySQL Proxy without any Lua script to try a round-robin type load balancing. In this case, if the first database in the list is down, MySQL Proxy would not connect the client to the second database in the list.
- [14.6.6.19](#): Would the Java-only connection pooling solution work for multiple web servers? With this, I'd assume you can pool across many web servers at once?
- [14.6.6.20](#): Is the MySQL Proxy an API ?
- [14.6.6.21](#): If you have multiple databases on the same box, can you use proxy to connect to databases on default port 3306?
- [14.6.6.22](#): Will Proxy be deprecated for use with connection pooling once MySQL 6.x comes out? Or will 6.x integrate proxy more deeply?
- [14.6.6.23](#): In load balancing, how can I separate reads from writes?
- [14.6.6.24](#): We've looked at using MySQL Proxy but we're concerned about the alpha status - when do you think the proxy would be considered production ready?
- [14.6.6.25](#): Will the proxy road map involve moving popular features from lua to C? For example Read/Write splitting
- [14.6.6.26](#): Are these reserved function names (e.g., `error_result`) that get automatically called?
- [14.6.6.27](#): Can you explain the status of your work with `memcached` and MySQL Proxy?
- [14.6.6.28](#): Is there any big web site using MySQL Proxy ? For what purpose and what transaction rate have they achieved.
- [14.6.6.29](#): So the authentication when connection pooling has to be done at every connection? What's the authentication latency?
- [14.6.6.30](#): Is it possible to use the MySQL proxy w/ updating a Lucene index (or Solr) by making TCP calls to that server to update?
- [14.6.6.31](#): Isn't MySQL Proxy similar to what is provided by Java connection pools?
- [14.6.6.32](#): Are there tools for isolating problems? How can someone figure out if a problem is in the client, in the db or in the proxy?
- [14.6.6.33](#): Can you dynamically reconfigure the pool of MySQL servers that MySQL Proxy will load balance to?

- [14.6.6.34](#): Given that there is a `connect_server` function, can a Lua script link up with multiple servers?
- [14.6.6.35](#): Adding a proxy must add latency to the connection, how big is that latency?
- [14.6.6.36](#): In the quick poll, I see "Load Balancer: read-write splitting" as an option, so would it be correct to say that there are no scripts written for Proxy yet to do this?
- [14.6.6.37](#): Is it "safe" to use `LuaSocket` with proxy scripts?
- [14.6.6.38](#): How different is MySQL Proxy from DBCP (Database connection pooling) for Apache in terms of connection pooling?
- [14.6.6.39](#): Do you have make one large script and call at proxy startup, can I change scripts without stopping and restarting (interrupting) the proxy?

## Questions and Answers

### **14.6.6.1: Is the system context switch expensive, how much overhead does the lua script add?**

Lua is fast and the overhead should be small enough for most applications. The raw packet-overhead is around 400 microseconds.

### **14.6.6.2: How do I use a socket with MySQL Proxy? Proxy change logs mention that support for UNIX sockets has been added.**

Just specify the path to the socket:

```
--proxy-backend-addresses=/path/to/socket
```

However it appears that `--proxy-address=/path/to/socket` does not work on the front end. It would be nice if someone added this feature.

### **14.6.6.3: Can I use MySQL Proxy with all versions of MySQL?**

MySQL Proxy is designed to work with MySQL 5.0 or higher, and supports the MySQL network protocol for 5.0 and higher.

### **14.6.6.4: If MySQL Proxy has to live on same machine as MySQL, are there any tuning considerations to ensure both perform optimally?**

MySQL Proxy can live on any box: application, db or its own box. MySQL Proxy uses comparatively little CPU or RAM, so additional requirements or overhead is negligible.

### **14.6.6.5: Do proxy applications run on a separate server? If not, what is the overhead incurred by Proxy on the DB server side?**

You can run the proxy on the application server, on its own box or on the DB-server depending on the use-case

### **14.6.6.6: Can MySQL Proxy handle SSL connections?**

No, being the man-in-the-middle, Proxy can't handle encrypted sessions because it cannot share the SSL information.

### **14.6.6.7: What is the limit for `max-connections` on the server?**

Around 1024 connections the MySQL Server may run out of threads it can spawn. Leaving it at around 100 is advised.

### **14.6.6.8: As the script is re-read by proxy, does it cache this or is it looking at the file system with each request?**

It looks for the script at client-connect and reads it if it has changed, otherwise it uses the cached version.

### **14.6.6.9: With load balancing, what happen to transactions ? Are all queries sent to the same server ?**

Without any special customization the whole connection is sent to the same server. That keeps the whole connection state intact.

### **14.6.6.10: Can I run MySQL Proxy as a daemon?**

Starting from version 0.6.0, the Proxy is launched as a daemon by default. If you want to avoid this, use the `-D` or `--no-daemon` option. To keep track of the process ID, the daemon can be started with the additional option `--pid-file=file`, to save the PID to a known file name. On version 0.5.x, the Proxy can't be started natively as a daemon

### **14.6.6.11: What about caching the authorization info so clients connecting are given back-end connections that were established with identical authorization information, thus saving a few more round trips?**

There is an option that provides this functionality `--proxy-pool-no-change-user`.

**14.6.6.12: Could MySQL Proxy be used to capture passwords?**

The MySQL network protocol does not allow passwords to be sent in clear-text, all you could capture is the encrypted version.

**14.6.6.13: Can MySQL Proxy be used on slaves and intercept binlog messages?**

We are working on that. See <http://jan.kneschke.de/2008/5/30/mysql-proxy-rbr-to-sbr-decoding> for an example.

**14.6.6.14: MySQL Proxy can handle about 5000 connections, what is the limit on a MySQL server?**

See your `max-connections` settings. By default the setting is 150, the proxy can handle a lot more.

**14.6.6.15: How does MySQL Proxy compare to DBSLayer ?**

DBSLayer is a REST->MySQL tool, MySQL Proxy is transparent to your application. No change to the application is needed.

**14.6.6.16: I currently use SQL Relay for efficient connection pooling with a number of apache processes connecting to a MySQL server. Can MySQL proxy currently accomplish this. My goal is to minimize connection latency while keeping temporary tables available.**

Yes.

**14.6.6.17: The global namespace variable example with quotas does not persist after a reboot, is that correct?**

Yes. if you restart the proxy, you lose the results, unless you save them in a file.

**14.6.6.18: I tried using MySQL Proxy without any Lua script to try a round-robin type load balancing. In this case, if the first database in the list is down, MySQL Proxy would not connect the client to the second database in the list.**

This issue is fixed in version 0.7.0.

**14.6.6.19: Would the Java-only connection pooling solution work for multiple web servers? With this, I'd assume you can pool across many web servers at once?**

Yes. But you can also start one proxy on each application server to get a similar behaviour as you have it already.

**14.6.6.20: Is the MySQL Proxy an API ?**

No, MySQL Proxy is an application that forwards packets from a client to a server using the MySQL network protocol. The MySQL proxy provides a API allowing you to change its behaviour.

**14.6.6.21: If you have multiple databases on the same box, can you use proxy to connect to databases on default port 3306?**

Yes, MySQL Proxy can listen on any port. Providing none of the MySQL servers are listening on the same port.

**14.6.6.22: Will Proxy be deprecated for use with connection pooling once MySQL 6.x comes out? Or will 6.x integrate proxy more deeply?**

The logic about the pooling is controlled by the lua scripts, you can enable and disable it if you like. There are no plans to embed the current MySQL Proxy functionality into the MySQL Server.

**14.6.6.23: In load balancing, how can I separate reads from writes?**

There is no automatic separation of queries that perform reads or writes to the different backend servers. However, you can specify to `mysql-proxy` that one or more of the 'backend' MySQL servers are read-only.

```
$ mysql-proxy \  
--proxy-backend-addresses=10.0.1.2:3306 \  
--proxy-read-only-backend-addresses=10.0.1.3:3306 &
```

In the next releases we will add connection pooling and read/write splitting to make this more useful. See also [MySQL Load Balancer](#).

**14.6.6.24: We've looked at using MySQL Proxy but we're concerned about the alpha status - when do you think the proxy would be considered production ready?**

We are on the road to the next feature release: 0.7.0. It will improve the performance quite a bit. After that we may be able to enter the beta phase.

**14.6.6.25: Will the proxy road map involve moving popular features from lua to C? For example Read/Write splitting**

We will keep the high-level parts in the Lua layer to be able to adjust to special situations without a rebuild. Read/Write splitting sometimes needs external knowledge that may only be available by the DBA.

**14.6.6.26: Are these reserved function names (e.g., `error_result`) that get automatically called?**

Only functions and values starting with `proxy.` are provided by the proxy. All others are provided by you.

**14.6.6.27: Can you explain the status of your work with `memcached` and MySQL Proxy?**

There are some ideas to integrate proxy and `memcache` a bit, but no code yet.

**14.6.6.28: Is there any big web site using MySQL Proxy ? For what purpose and what transaction rate have they achieved.**

Yes, [gaiaonline](#). They have tested MySQL Proxy and seen it handle 2400 queries per second through the proxy.

**14.6.6.29: So the authentication when connection pooling has to be done at every connection? What's the authentication latency?**

You can skip the round-trip and use the connection as it was added to the pool. As long as the application cleans up the temporary tables it used. The overhead is (as always) around 400 microseconds.

**14.6.6.30: Is it possible to use the MySQL proxy w/ updating a Lucene index (or Solr) by making TCP calls to that server to update?**

Yes, but it isn't advised for now.

**14.6.6.31: Isn't MySQL Proxy similar to what is provided by Java connection pools?**

Yes and no. Java connection pools are specific to Java applications, MySQL Proxy works with any client API that talks the MySQL network protocol. Also, connection pools do not provide any functionality for intelligently examining the network packets and modifying the contents.

**14.6.6.32: Are there tools for isolating problems? How can someone figure out if a problem is in the client, in the db or in the proxy?**

You can set a debug script in the proxy, which is an exceptionally good tool for this purpose. You can see very clearly which component is causing the problem, if you set the right breakpoints.

**14.6.6.33: Can you dynamically reconfigure the pool of MySQL servers that MySQL Proxy will load balance to?**

Not yet, it is on the list. We are working on a administration interface for that purpose.

**14.6.6.34: Given that there is a `connect_server` function, can a Lua script link up with multiple servers?**

The proxy provides some tutorials in the source-package, one is `examples/tutorial-keepalive.lua`.

**14.6.6.35: Adding a proxy must add latency to the connection, how big is that latency?**

In the range of 400microseconds

**14.6.6.36: In the quick poll, I see "Load Balancer: read-write splitting" as an option, so would it be correct to say that there are no scripts written for Proxy yet to do this?**

There is a proof of concept script for that included. But its far from perfect and may not work for you yet.

**14.6.6.37: Is it "safe" to use `LuaSocket` with proxy scripts?**

You can, but it is not advised as it may block.

**14.6.6.38: How different is MySQL Proxy from DBCP (Database connection pooling) for Apache in terms of connection pooling?**

Connection Pooling is just one use-case of the MySQL Proxy. You can use it for a lot more and it works in cases where you can't use DBCP (like if you don't have Java).

**14.6.6.39: Do you have make one large script and call at proxy startup, can I change scripts without stopping and restarting (interrupting) the proxy?**

You can just change the script and the proxy will reload it when a client connects.



---

## Chapter 15. MySQL Enterprise Monitor

### Note

MySQL Enterprise subscription, MySQL Enterprise Monitor, MySQL Replication Monitor, and MySQL Query Analyzer are only available to commercial customers. To learn more, see: <http://www.mysql.com/products/enterprise/features.html>.

The MySQL Enterprise Monitor serves as an automated assistant for MySQL database administrators. This service is designed to help administrators with their day-to-day tasks by monitoring MySQL servers and identifying potential problems. These features are designed to save the database administrator's time and effort by providing the information you need through a simplified interface.

An extension of existing MySQL Enterprise services, MySQL Enterprise Monitor monitors enterprise database environments and provides expert advice on how customers can tighten security and optimize the performance and uptime of their MySQL servers.

MySQL Enterprise Monitor helps administrators:

- Intelligently stay up to date with releases and bug fixes
- Know what's going on with their system
- Manage day-to-day database maintenance tasks
- Improve the performance of their system
- Manage and prevent crises

The MySQL Enterprise Monitor was designed to tackle the job of managing the performance of any number of MySQL database servers, regardless of their physical or geographical location. Although MySQL Enterprise Monitor can easily track just a handful of MySQL servers, the service is specifically designed to greatly curtail the time it takes to get a handle on the availability and performance levels of many database servers at once.

The MySQL Enterprise Monitor does this by providing a web-based interface — called the Enterprise Dashboard — that serves as the portal for viewing information about your MySQL database servers. MySQL professionals can manage all their servers by group or individually if need be.

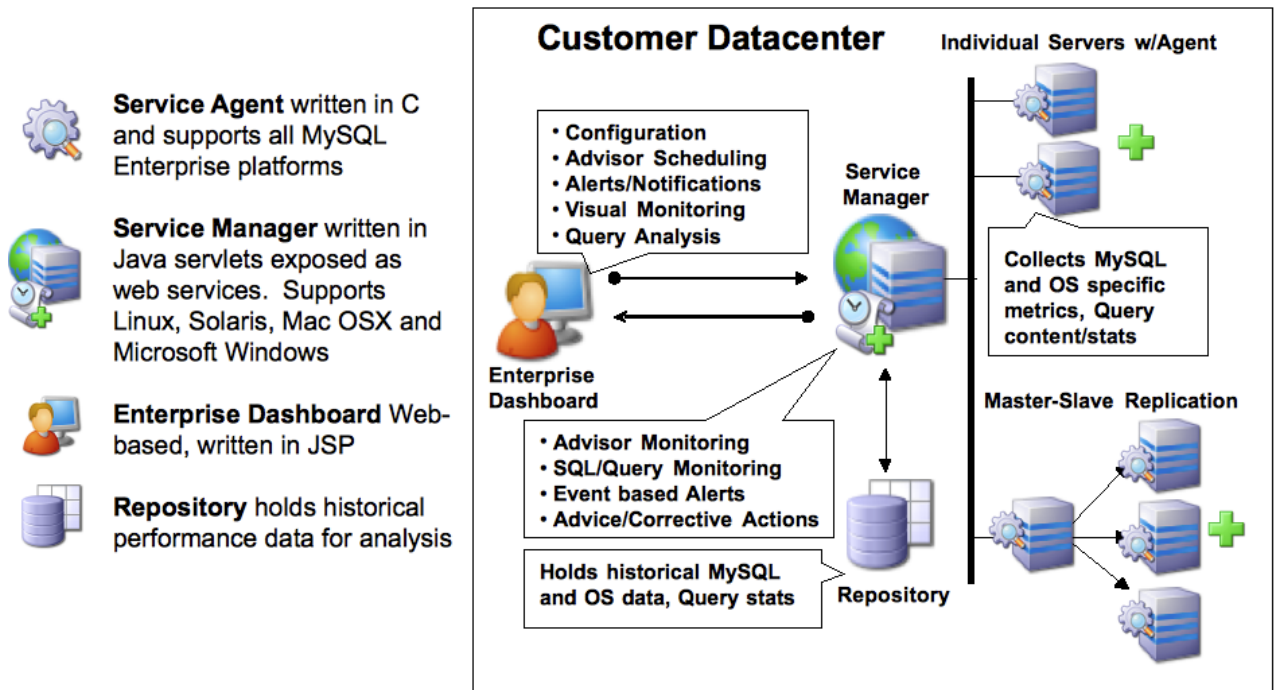
The Enterprise Dashboard web interface does not have to be installed on individual desktops, but is instead available from a centrally located machine that serves as the main location for the Monitoring and Advisory service.

### 15.1. An Overview of the Service

The MySQL Enterprise Monitor is a collection of components that work together to monitor and help administer your MySQL server installations. This service includes server management agents, advisors, and a central MySQL Enterprise Service Manager, all working in tandem with the MySQL Enterprise to keep your MySQL servers secure and up to date. All of this is controlled through the MySQL Enterprise Dashboard — a lightweight web-based interface that gives you complete control of your MySQL servers from any location.

#### Figure 15.1. MySQL Enterprise Monitor Architecture





The service is made up of a number of components, including the Monitor Agent (MySQL Enterprise Monitor Agent), the Service Manager (MySQL Enterprise Service Manager), the Enterprise Dashboard, the Repository and the Advisors.

### 15.1.1. The Service Architecture

The MySQL Enterprise Monitor is powered by a distributed web-based application that is deployed within the confines of the corporate firewall. The Enterprise Dashboard provides the interface to the server data, advisor notifications, live information and communication with the MySQL Enterprise Update Service.

Subscribers are kept up to date about the latest releases of the MySQL server or issues that may affect their specific implementation of MySQL by using the MySQL Enterprise Update Service. This same mechanism is used to notify MySQL Enterprise Monitor users of updates to the application or to the MySQL Advisors and Rules. The various components are described below.

- **Monitor Agent**

Monitor Agents are the foot soldiers of the MySQL Enterprise Monitor; they monitor each MySQL server. Running as a Windows service or Unix daemon, the Agent uses a combination of MySQL specific commands, SQL queries, and custom scripts to collect and report MySQL server or operating system (OS) specific data. The Monitor Agent initiates a “heartbeat” to the Service Manager on a regular basis to ensure specific MySQL server and OS level data collections are current.

In the overall architecture, the Monitor Agent is the only component of the MySQL Enterprise Monitor that establishes or maintains a connection with the monitored MySQL Server. As with any MySQL client, the Monitor Agent is authenticated on the monitored MySQL server and requires a user name and password to establish a connection.

In addition, the MySQL Enterprise Monitor Agent also provides a proxy service that allows for information about queries to be captured and reported as part of the Query Analyzer functionality. The MySQL Enterprise Monitor Agent accepts client connections and forwards the SQL statements on to the server and returns the results. In the background, the agent is collecting information about the query execution, row counts, times and other data so that queries and their execution can be monitored.

- **Service Manager**

The Service Manager is the heart and soul of the MySQL Enterprise Monitor. It is built on a collection of Java services hosted on a single Windows or Unix server. The Service Manager interacts with all of the Monitor Agents under its domain to collect MySQL server and OS level data for each of the monitored MySQL servers.

The Service Manager performs many duties including:

- Enterprise Dashboard, the main interface to the MySQL Enterprise Service Manager.
- Autodiscovery of monitored MySQL Servers.

- Creation and management of Monitor Agent tasks.
- Storage of data collections from Monitor Agents.
- Monitoring of key MySQL server and OS level metric data collections.
- Reporting MySQL best practice events and violations.
- Providing MySQL expert advice for MySQL best practice violations.
- Autodiscovery of replication topology (Not available for all subscription levels)

- **The Repository**

The Repository is built on MySQL 5.0.x and is used to store MySQL server and OS level data collections for each of the monitored MySQL Servers. This information is used by the Service Manager to evaluate and report the health and status of the monitored MySQL environment(s).

- **The Enterprise Dashboard**

The MySQL Enterprise web client provides the graphical user interface (GUI) for the MySQL Enterprise Monitor. This interface is the primary means of monitoring the state of your MySQL servers, identifying rule violations and providing advice on how best to address and correct any underlying issues.

This interface also provides an easy means of configuring advisors, adding users, creating notification groups, and receiving updates from MySQL Enterprise.

## 15.1.2. Service Features

The key features of the MySQL Enterprise Monitor can be summarized as follows:

- Group-level or Server-level management options
- Enterprise Dashboard for managing all MySQL Servers from a consolidated console
- Monitoring page for “at a glance” global health check of key systems
- MySQL-provided Advisors and Advisor Rules for enforcing MySQL Best Practices
- Advisor Rule Scheduling for unattended operations
- Customizable Thresholds and Alerts for identifying Advisor Rule violations
- User-Defined Advisor Rules
- Event/Alert History browser for researching advisor-specific events and annotations
- Query Analyzer functionality allowing you to monitor the execution times, row counts and other data about queries executed on your MySQL server.

These features are presented through the MySQL Enterprise Dashboard which is made up of six main pages:

- The **MONITOR** page comprises:
  - The **SERVER TREE**: Easily navigate monitored servers
  - The **GRAPHING**: This capability is built in so you can quickly assess critical functions such as activity, performance metrics, and number of connections
  - The **HEAT CHART**: Color-coded buttons provide key operating system and database metrics
- The **ADVISORS** page

This page shows the advisors that are currently scheduled. There are advisors for a variety of topics such as security and indexing. Users can add, edit, or create their own advisors.

- The **EVENTS** page

This page shows rule violations, indicating the server, severity, and time of occurrence. A number of filter options are available, allowing various views of events.

- The **GRAPHS** page

Use this page to view all the available graphs and to adjust the scale of the graphs, for a more or less detailed view as the situation requires.

- The **QUERY ANALYZER** page

- The **REPLICATION** page

Use this page to keep track of your masters and their slaves (Not available for all subscription levels)

- The **SETTINGS** page

On this page you configure servers, users, email addresses, and notification groups. Entering a user name and password for MySQL Enterprise provides automatic updates.

### 15.1.3. Security

Using the Tomcat/Apache web server for the user interface allows an administrator to configure the web server to meet any security regulations. The MySQL Enterprise Monitor architecture is designed to be as secure as possible, even when monitoring systems outside of the local network.

Communications between the MySQL Enterprise Monitor Agent and MySQL Enterprise Service Manager can be protected by Secure Socket Layer (SSL) encryption and server and agent can use SSL certificates to provide authentication and prevent spoofing.

The MySQL Enterprise Monitor Agent is like a web browser—it is an HTTP client application that initiates all communication with the MySQL Enterprise Service Manager. If the server requires action from the agent, it must wait until the agent next initiates contact and sends its request in a response. This means you do not need to open an inbound port on the machine on which the agent is running because it does not listen for requests. However, an outbound port must be open for the agent to contact the MySQL Enterprise Service Manager.

As an additional security feature, each Agent can have a separate Advisory Service login which minimizes exposure should any one agent be compromised.

## 15.2. Conventions Used in This Document

This document uses certain typographical conventions:

- *Text in this style* is used for SQL statements; database, table, and column names; program listings and source code; and environment variables. Example: “To reload the grant tables, use the `FLUSH PRIVILEGES` statement.”
- *Text in this style* indicates input that you type in examples.
- *Text in this style* indicates the names of executable programs and scripts, examples being `mysql` (the MySQL command line client program) and `mysqld` (the MySQL server executable).
- *Text in this style* is used for variable input for which you should substitute a value of your own choosing.
- File names and directory names are written like this: “The global `my.cnf` file is located in the `/etc` directory.”
- Character sequences are written like this: “To specify a wildcard, use the `%` character.”
- *Text in this style* is used for emphasis.
- **Text in this style** is used in table headings and to convey especially strong emphasis.

When commands are shown that are meant to be executed from within a particular program, the prompt shown preceding the command indicates which command to use. For example, `shell>` indicates a command that you execute from your login shell or from the command line in Windows:

```
shell> type a shell command here
```

The “shell” is your command interpreter. On Unix, this is typically a program such as `sh`, `csh`, or `bash`. On Windows, the equivalent program is `command.com` or `cmd.exe`, typically run in a console window.

When you enter a command or statement shown in an example, do not type the prompt shown in the example.

Sometimes, what appears on one line in a console window cannot be represented in the documentation on a single line. In cases such as this the character ‘`»`’ is used. For example:

```
Please specify the directory where the MySQL Enterprise Monitor Â»
will be installed.
```

Where Unix commands are concerned, the continuation character ‘`\`’ is used. Doing this allows commands to be copied and pasted to the command line verbatim. For example:

```
shell> /opt/mysql/enterprise/agent/bin/mysql-monitor-agent -f \
/opt/mysql/enterprise/agent/etc/mysql-monitor-agent.ini
```

SQL keywords are not case sensitive and may be written in either case. This document uses uppercase.

In syntax descriptions, square brackets (‘`[`’ and ‘`]`’) indicate optional words or clauses. For example, in the following statement, `IF EXISTS` is optional:

```
DROP TABLE [IF EXISTS] tbl_name
```

When a syntax element consists of a number of alternatives, the alternatives are separated by vertical bars (‘`|`’). When one member from a set of choices *may* be chosen, the alternatives are listed within square brackets (‘`[`’ and ‘`]`’):

```
TRIM([[BOTH | LEADING | TRAILING] [remstr] FROM] str)
```

When one member from a set of choices *must* be chosen, the alternatives are listed within braces (‘`{`’ and ‘`}`’):

```
{DESCRIBE | DESC} tbl_name [col_name | wild]
```

An ellipsis (‘`...`’) indicates the omission of a section of a statement, typically to provide a shorter version of more complex syntax. For example, `INSERT ... SELECT` is shorthand for the form of `INSERT` statement that is followed by a `SELECT` statement.

An ellipsis can also indicate that the preceding syntax element of a statement may be repeated. In the following example, multiple `reset_option` values may be given, with each of those after the first preceded by commas:

```
RESET reset_option [,reset_option] ...
```

Commands for setting shell variables are shown using Bourne shell syntax. For example, the sequence to set the `CC` environment variable and run the `configure` command looks like this in Bourne shell syntax:

```
shell> CC=gcc ./configure
```

If you are using `csh` or `tcsh`, you must issue commands somewhat differently:

```
shell> setenv CC gcc
shell> ./configure
```

Throughout this document the term ‘`Unix`’ is used to describe any Unix or Unix-like operating system. For an up-to-date list of operating systems supported by the MySQL Enterprise Monitor please see the [MySQL Enterprise web site](#).

## 15.3. Installation and Upgrades

### Note

MySQL Enterprise subscription, MySQL Enterprise Monitor, MySQL Replication Monitor, and MySQL Query Analyzer are only available to commercial customers. To learn more, see: <http://www.mysql.com/products/enterprise/features.html>.

This chapter describes the process of installing the MySQL Enterprise Monitor on all operating systems. A working installation requires the installation of a MySQL Enterprise Service Manager, the MySQL Enterprise Advisors and one or more MySQL Enterprise Monitor Agents. Simply described, the agent inspects the MySQL server it is monitoring, reports to the Service Manager, and the results are interpreted by the advisors and displayed in the MySQL Enterprise Dashboard for viewing in a web browser.

One Monitor Agent is installed for each MySQL server that is being monitored. The Monitor Agent usually runs on the same machine that hosts the monitored MySQL server but it may run on any machine that has access to both the monitored MySQL server and the MySQL Enterprise Dashboard. The agent reports its findings to the Service Manager and these results are interpreted by Advisors and displayed in the dashboard. The end user opens a web browser to view the information presented in the dashboard. The Service Manager and dashboard run on the same machine and both have access to a local MySQL server installed as part of the MySQL Enterprise Monitor. This server is known as the repository and provides storage for the data provided by the agent.

Installation is a three step process:

1. Install and start the Service Manager on the monitoring system.
2. Configure the Service Manager and install the Advisors.
3. Install and start the Monitor Agent to monitor the targeted MySQL server.

### Installation Requirements

The Service Manager is available for Windows, Mac OS X, and a variety of Unix and Linux operating systems.

#### Note

The Mac OS X Service Manager is only supported on Intel architecture. However, the Mac OS X agent is supported for both Intel and the PowerPC.

To install the MySQL Enterprise Monitor on Windows requires approximately 260 MB of space and approximately 450 MB on Unix, Linux and Mac OS X. The installer checks that there is enough free space on the destination disk. However, disk space usage will increase with time since the repository stores historical data.

The minimum recommended requirements for the service manager are at least a 2GHz CPU and at least 1GB of RAM. If you are monitoring a large number of services, then there will be an increased load on the server manager. Running the service manager on a machine that is already running other tasks is only recommended if you are monitoring a small number of agents. For monitor five or more agents simultaneously, you should dedicate a machine to the process.

For more information, see [Section 15.4.4, “Choosing Suitable MySQL Enterprise Service Manager Hardware Configurations”](#).

The Monitor Agent is available for a wide range of operating systems. For an up-to-date list please see the [MySQL Enterprise web site](#). The agent can be used to monitor any MySQL server from version 4.0.x through 6.0.x.

## 15.3.1. User Roles

Prior to installation you will need to have at hand credentials for access to the MySQL server you plan to monitor and also your MySQL Enterprise credentials. *During* installation and when first logging in, you will set up a variety of users with different roles and credentials. This can become confusing. This section outlines the various users associated with the MySQL Enterprise Monitor and gives a brief description of their roles.

### 15.3.1.1. Existing Users

The **MySQL Enterprise user** – These are the credentials you use to log in to the MySQL Enterprise web site. You will need them in order to acquire the Advisor files and receive updates and, if necessary, acquire a product key.

The **MySQL user** – For Monitor Agents to report the status of a MySQL server they must have privileges on that server. To perform all functions an agent must have `SHOW DATABASES`, `REPLICATION CLIENT`, `SUPER`, `CREATE`, and `SELECT` privileges. In short, the Monitor Agent needs to have read access to all data. Details about this account are given in [Section 15.3.3.1, “Creating a MySQL User Account for the Monitor Agent”](#).

### 15.3.1.2. User Created During Installation

The **Repository user** – This user is the only user in the `user` table in the `mysql` database in the bundled MySQL server. To avoid confusion with monitored MySQL servers, this server is referred to throughout this document as the *repository*. The repository user can log in from `localhost` using the password specified during installation and has all privileges on all databases. These credentials are used to create the repository and its tables and to record data in them. During installation the default value for the user name for this role is `service_manager`. No default password is specified. You can use these credentials to manage the repository from the command line or when using a program such as MySQL Administrator.

During installation the file `configuration_report.txt` is created. Reference this file for the credentials of the repository manager. After the MySQL Enterprise Service Manager is installed, look for this file in the following directories:

- Windows – `C:\Program Files\MySQL\Enterprise\Monitor`
- Unix – `/opt/mysql/enterprise/monitor`
- Mac OS X – `/Applications/mysql/enterprise/monitor`

### 15.3.1.3. Users Created on First Log-in

The **Root user** – This user is the administrator of the dashboard. The first time you log in to the dashboard you must log in as this user. The default user name for this user is `admin`. There is no default password for this user.

The **Agent user** – The Monitor Agent needs to report the status of the MySQL server it is monitoring. For this reason it needs to log in to the dashboard. The default user name for this user is `agent`. There is no default password for this user.

#### Note

The Monitor Agent has two roles in the MySQL Enterprise Monitor; it must have access to the dashboard and to the MySQL server it is monitoring. For a description of the agent as a MySQL user see [Section 15.3.1.1, “Existing Users”](#).

## 15.3.2. Service Manager Installation

The MySQL Enterprise Service Manager is the core element of the MySQL Enterprise Monitor. The installation process for this element is completely self-contained, but the installation includes the following components:

- Apache Tomcat
- MySQL Server
- Java VM

#### Note

After installation you can determine the version number of the various components by entering `http://server_name:18080/main?command=list_versions` into the web browsers address bar.

During installation, versions of MySQL and Tomcat will be installed onto the machine. The installer automatically provides default network ports that are different from standard installation for these applications. You can change the ports during installation.

During installation, default values are shown for user names and ports. This is for your convenience only; you may choose different values. The installer detect ports that are already in use and allows you to select different ports.

#### Warning

The MySQL Enterprise Service Manager version 2.0 requires agents using 2.0 or higher.

All the installations share the same basic configuration parameters that you will be asked to confirm during installation. Before you start your installation, please review the section on these common parameters, then proceed to section specific to your installation platform. For details of the common parameters, see [Section 15.3.2.1, “Service Manager Installation Common Parameters”](#). For information on installation under Windows, see [Section 15.3.2.2, “Service Manager Installation on Windows”](#), for Mac OS X see [Section 15.3.2.3, “Service Manager Installation on Mac OS X”](#), and for Unix/Linux, see [Section 15.3.2.4, “Service Manager Installation on Unix”](#).

### 15.3.2.1. Service Manager Installation Common Parameters

All installations of the Service Manager install the Tomcat and MySQL applications using the same basic set of parameters. The defaults provided by the installation process are designed to be unique so that they do not interfere with existing installations of either product. However, you should check these parameters before installation to ensure that you do not experience any problems.

The common parameters are divided into those applying to the Tomcat server, and the MySQL server (Repository Configuration):

- **Tomcat Server Options**
  - Tomcat Server port — the default port that the Tomcat server will use when listening for connections. If you change this option, then the port that you need to use when connecting to the Service Manager must be modified accordingly. The default value is 18080.

**Note**

If you are not currently running a web server on port 80 you may find it more convenient to use the well known port rather than 18080. Since port 80 is the default for a web server, you can then open the dashboard without specifying a port.

- Tomcat Shutdown port —the port used by the management scripts that is used to shut the Tomcat server down when you need to stop the Service Manager. The default value is 18005.
- Tomcat SSL Port — the standard port used to connect to the Service Manager when you want to use Secure Sockets Layer (SSL) encrypted communication. The default value is 18443.
- **Repository Configuration (MySQL Server)**
  - Repository Username — the user name created and used to store information within the MySQL server to hold the information used by the Service Manager. In normal use, you should not need to use or modify this information, but it may be required if you have a support issue. The default value is `service_manager`.
  - Repository User password — the password to be used for the Repository Username. This should be set to a secure password so that the repository data is secure.

The information that you configure during installation will always be recorded within the `configuration_report.txt` file within the installation directory for the Service Manager.

**Caution**

Because the information stored within the `configuration_report.txt` file is in plain text, the Repository user name and password information are also exposed within this file. Make sure that the installation directory and file are secure that they can only be accessed by those users who would need to use the information.

### 15.3.2.2. Service Manager Installation on Windows

On Windows the installation modes are `win32` and `unattended` only. `unattended` mode is especially useful if you are doing multiple installations. For more information on this topic see [Section 15.3.4, “Unattended Installation”](#).

**Note**

In order to install the Service Manager as a Windows service, you must do the installation as a privileged user.

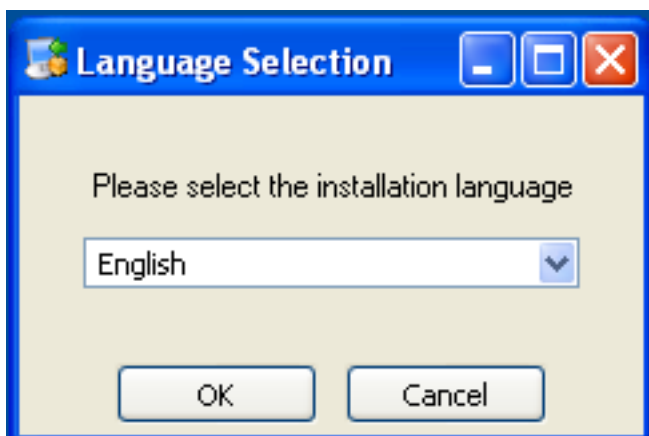
On Windows Vista, if user account control is on, an operating system dialog box requests confirmation of the installation.

To install the Service Manager on Windows, find the executable file named `mysqlmonitor-version-windows-installer.exe` (where `version` represents the three-part version number).

1. Double click on the MySQL Monitor installer. You should be presented with the Language Selection prompt. Select the language to use for the installer and then click OK.

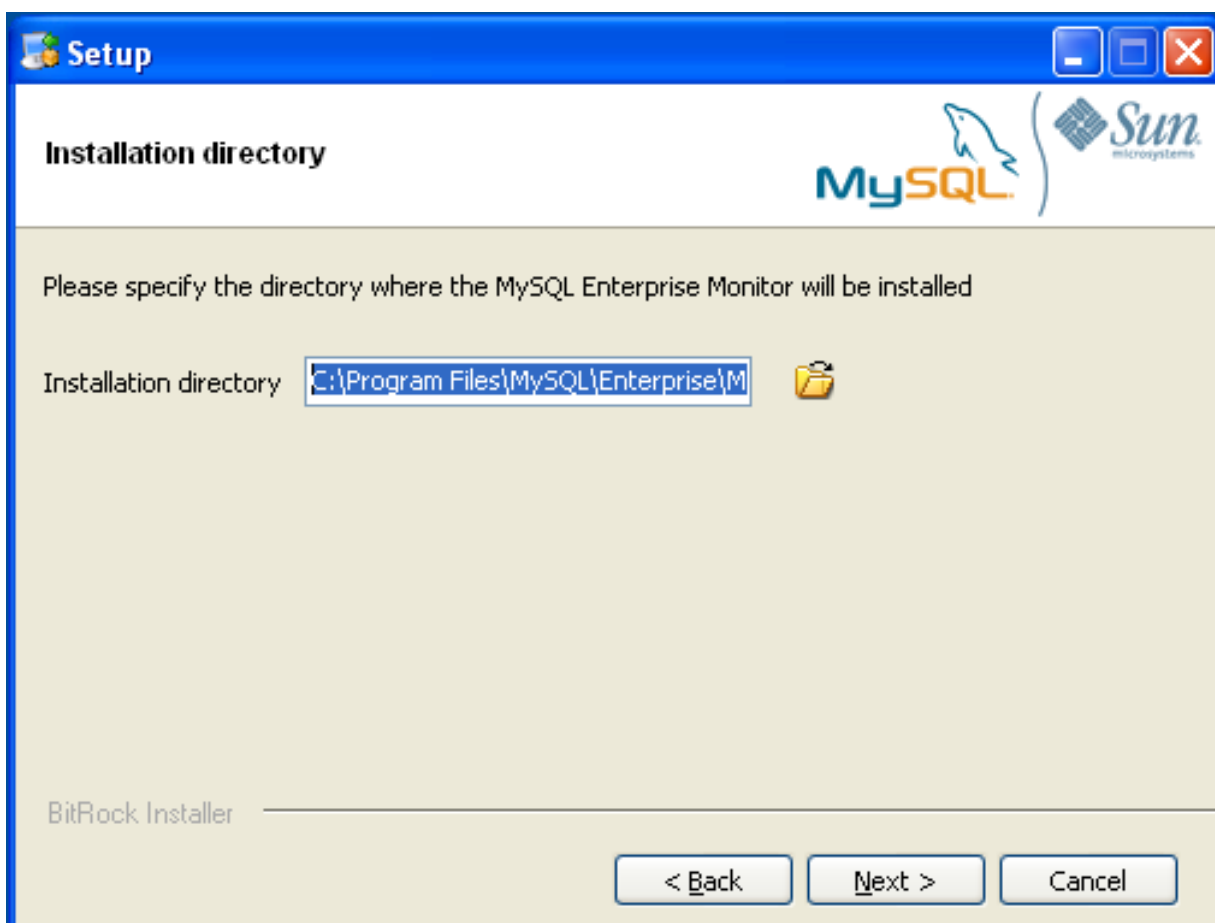
#### Figure 15.2. MySQL Enterprise Monitor: Installing Monitor on Windows: Language Selection





2. With the installation language selected, the remainder of the installation sets up the installation location and the main configuration parameters required by MySQL Enterprise Service Manager. Click NEXT to continue.
3. Select the installation directory where you want the MySQL Enterprise Service Manager components installed. By default on Windows the directory is `C:\Program Files\MySQL\Enterprise\Monitor`. You click the button next to the installation directory field to select a directory using the File chooser, or type the directory manually. Click NEXT to continue.

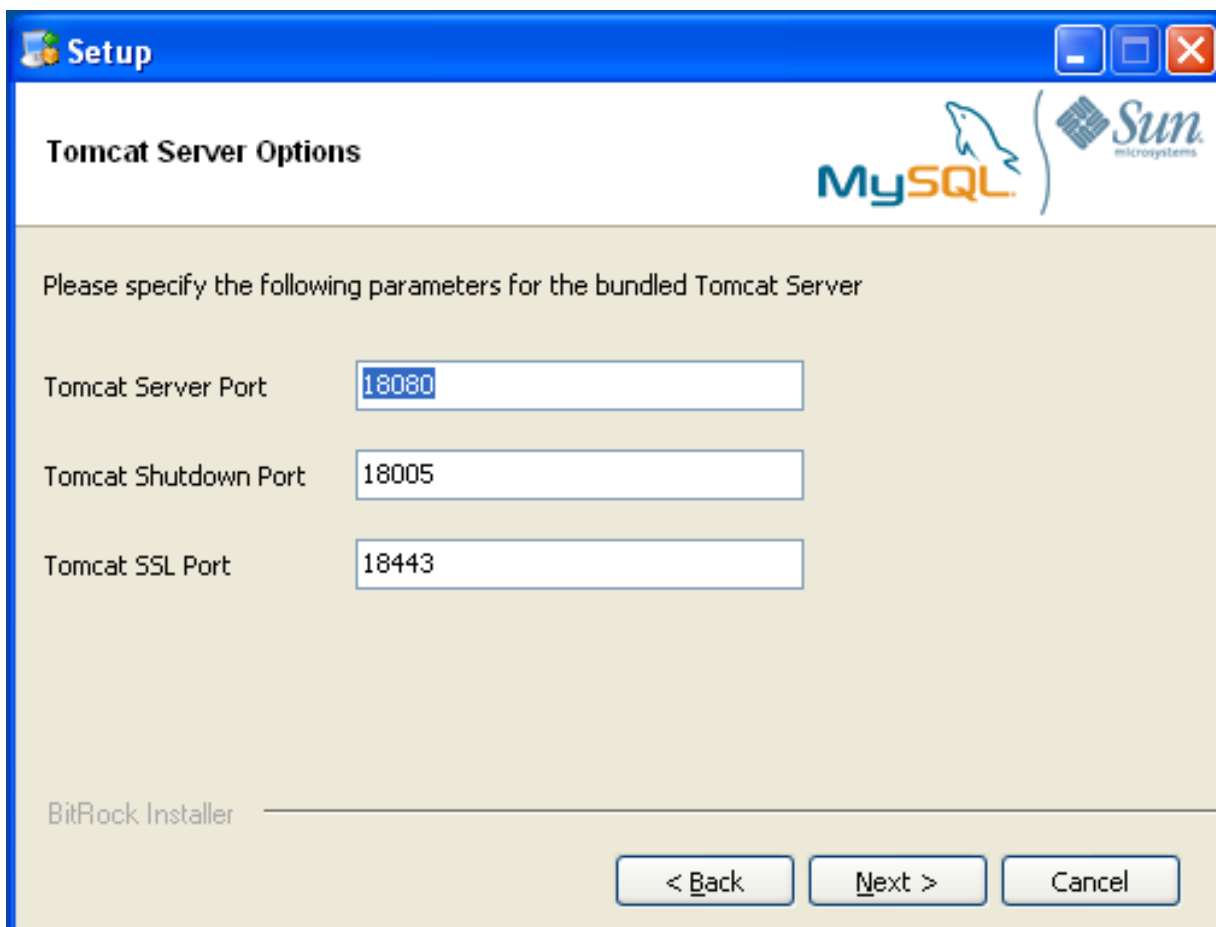
**Figure 15.3. MySQL Enterprise Monitor: Installing Monitor on Windows: Installation Directory**



4. Configure the options that set the network ports used by the Tomcat server. For more information, see [Section 15.3.2.1, "Service Manager Installation Common Parameters"](#). Click NEXT to continue.

**Figure 15.4. MySQL Enterprise Monitor: Installing Monitor on Windows: Tomcat Server Options**



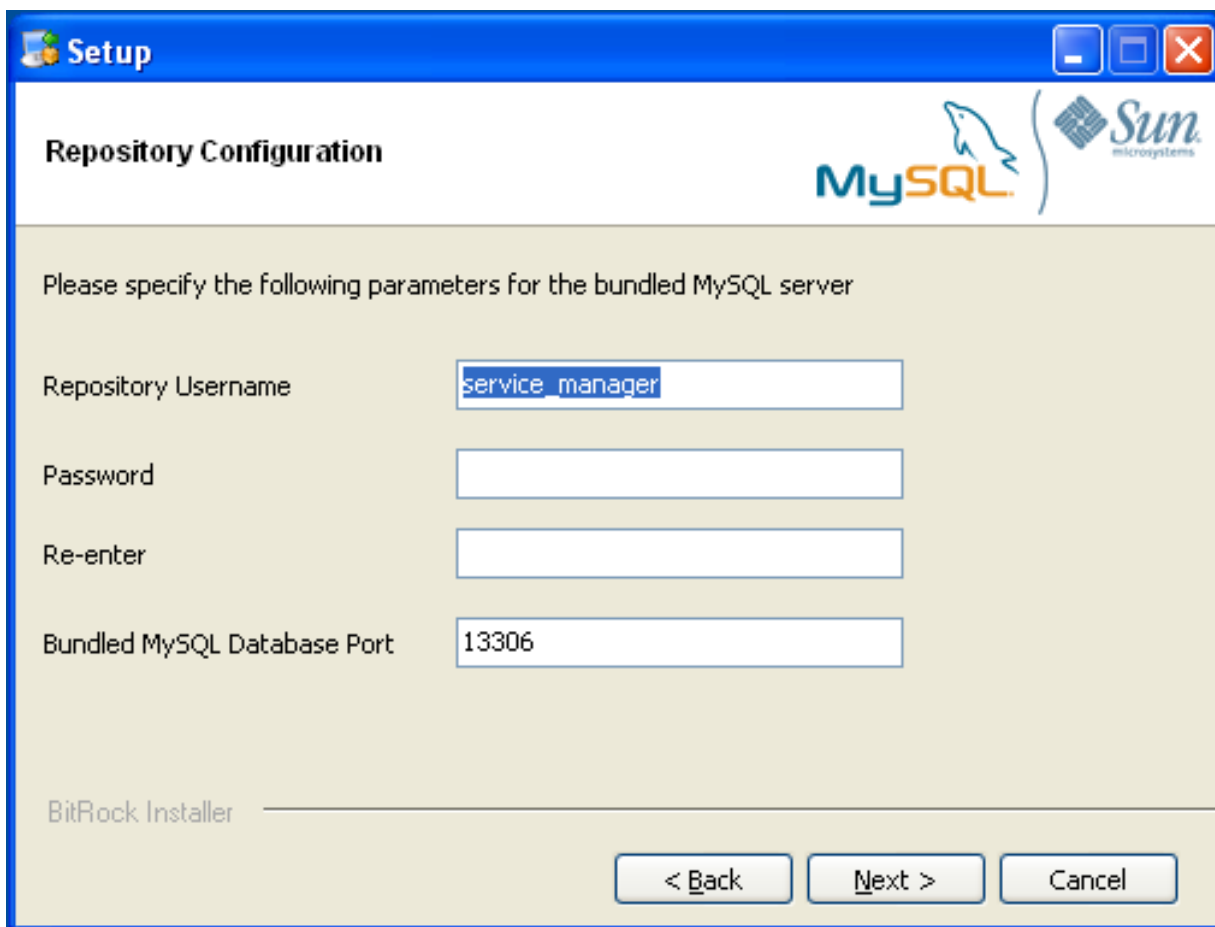


5. Configure the repository settings, setting the user name, password and port used to communicate with the bundled MySQL server that will be used to store the information and statistics for your installation. For more information, see [Section 15.3.2.1, "Service Manager Installation Common Parameters"](#). Click NEXT to continue.

**Note**

If the Windows firewall is enabled you will be asked to unblock ports for Apache/Tomcat and the MySQL server.

**Figure 15.5. MySQL Enterprise Monitor: Installing Monitor on Windows: Repository Configuration**



6. You will be provided with information and a warning about the configuration options and how they are stored in the `configuration_report.txt` file, and its location. Take a note of the full path to this file in case you need to look up the information later. Click NEXT to continue.
7. You should now be prompted to start the installation process. Click NEXT to continue.
8. Once the installation has been completed, you will be provided with the information on how to uninstall MySQL Enterprise Service Manager. Click NEXT to continue.
9. To complete the installation and set up your MySQL Enterprise Service Manager, you will need to login to the Dashboard. You can do this automatically by checking the box on the final window before clicking FINISH. This checkbox is selected by default. If you do not want to run the Dashboard at this time, uncheck the box and click FINISH.

For instructions on starting the MySQL Enterprise Monitor services under Windows, see [Section 15.3.2.5, “Starting/Stopping the MySQL Enterprise Monitor Service on Windows”](#).

### 15.3.2.3. Service Manager Installation on Mac OS X

On Mac OS X there are three installation modes `osx`, `text`, and `unattended`. For more information on this topic see [Section 15.3.4, “Unattended Installation”](#). The `text` mode installation for Mac OS X is identical to `text` installation under Unix. For `text` mode installation instructions see [Section 15.3.2.4, “Service Manager Installation on Unix”](#).

Installing the MySQL Enterprise Service Manager on Mac OS X requires an existing installation of Java. The minimum required version is 1.5.0\_7. If this version is not installed on your machine you can download it from Apple. This version of Java requires Mac OS X version 10.4.5 as a minimum, so you may need to upgrade your operating system in order to install it.

For reasons of backwards compatibility, Mac OS X is usually installed with multiple versions of Java. When installing in `osx` mode, version 1.5.0\_7 must be the default version. Upon installation, Java 1.5.0\_7 sets itself as the default so this is usually not a problem.

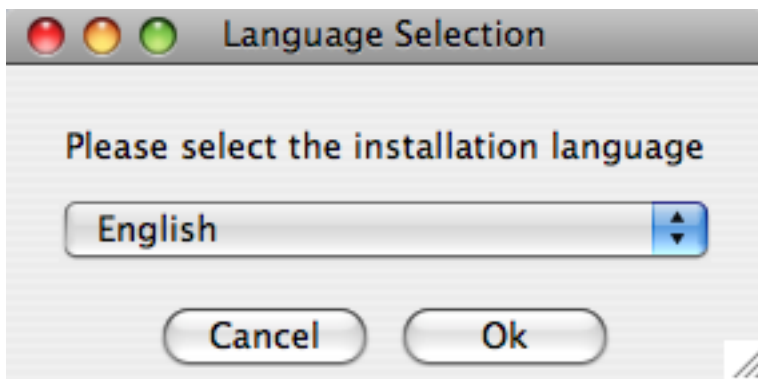
If you have changed the default you can reset it or you may install the MySQL Enterprise Service Manager in `text` mode, setting the environment variables to point to the correct version of Java. To install in `text` mode, find the `installbuilder` file in the

`Contents/MacOS` directory immediately below the `mysqlmonitor-version-osx-installer.app` directory. Installing the MySQL Enterprise Service Manager in `text` mode is identical to the procedure described in Section 15.3.2.4, “Service Manager Installation on Unix” with the minor differences noted above.

To install using the GUI (osx) installation, follow these instructions:

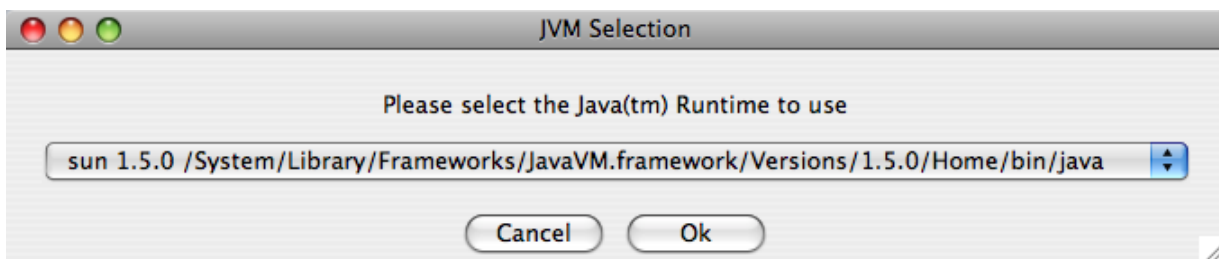
1. Double click on the MySQL Monitor installer. You should be presented with the Language Selection prompt. Select the language to use for the installer and then click OK.

**Figure 15.6. MySQL Enterprise Monitor: Installing Monitor on OS X: Language Selection**



2. If you have multiple Java installations on your machine, you will be asked to choose which Java to use with your MySQL Enterprise Service Manager installation. Choose the Java version you want to use (1.5.0 or later is required), and click OK.

**Figure 15.7. MySQL Enterprise Monitor: Installing Monitor on OS X: Java Selection**



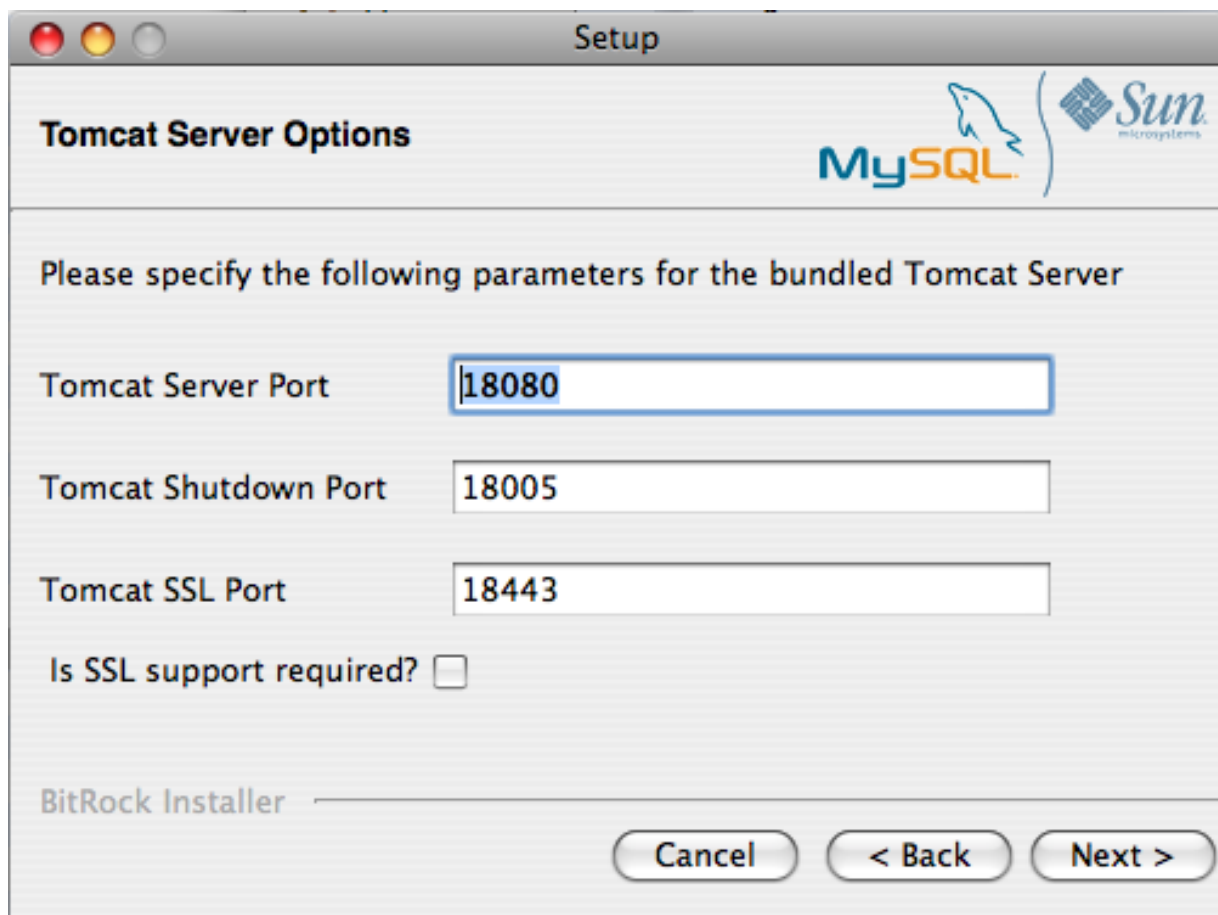
3. With the installation language and Java version selected, the remainder of the installation sets up the installation location and the main configuration parameters required by MySQL Enterprise Service Manager. Click NEXT to continue.
4. Select the installation directory where you want the MySQL Enterprise Service Manager components installed. By default on Mac OS X the directory is `/Applications/mysql/enterprise/monitor`. You click the button next to the installation directory field to select a directory using the File chooser, or type the directory manually. Click NEXT to continue.

**Figure 15.8. MySQL Enterprise Monitor: Installing Monitor on OS X: Installation Directory**



5. Configure the options that set the network ports used by the Tomcat server. For more information, see [Section 15.3.2.1, “Service Manager Installation Common Parameters”](#). Click NEXT to continue.

**Figure 15.9. MySQL Enterprise Monitor: Installing Monitor on OS X: Tomcat Server Options**



6. Configure the repository settings, setting the user name, password and port used to communicate with the bundled MySQL server that will be used to store the information and statistics for your installation. For more information, see [Section 15.3.2.1, "Service Manager Installation Common Parameters"](#). Click NEXT to continue.

**Figure 15.10. MySQL Enterprise Monitor: Installing Monitor on OS X: Repository Configuration**

**Setup**

**Repository Configuration**

Please specify the following parameters for the bundled MySQL server

Repository Username:

Password:

Re-enter:

Bundled MySQL Database Port:

BitRock Installer

Cancel < Back Next >

7. You will be provided with information and a warning about the configuration options and how they are stored in the `configuration_report.txt` file, and its location. Take a note of the full path to this file in case you need to look up the information later. Click NEXT to continue.
8. You should now be prompted to start the installation process. Click NEXT to continue.
9. Once the installation has been completed, you will be provided with the information on how to uninstall MySQL Enterprise Service Manager. Click NEXT to continue.
10. To complete the installation and set up your MySQL Enterprise Service Manager, you will need to login to the Dashboard. You can do this automatically by checking the box on the final window before clicking FINISH. This checkbox is selected by default. If you do not want to run the Dashboard at this time, uncheck the box and click FINISH.

Your installation should now be complete. To continue with the configuration of MySQL Enterprise Service Manager, see [Section 15.3.2.7, “MySQL Enterprise Service Manager Configuration Settings and Advisor Installation”](#).

#### 15.3.2.4. Service Manager Installation on Unix

To install the Service Manager find the file named `mysqlmonitor-version-installer.bin` (where `version` indicates the version number, the OS, and the architecture ). Ensure that this file is executable by typing:

```
shell> chmod +x mysqlmonitor-version-installer.bin
```

To install to the default directory (`/opt/mysql/enterprise/monitor`) you need to be logged in as `root`. Installing as an unprivileged user installs to the `/home/user_name/mysql/enterprise/monitor/` directory.

What follows describes installation from the command line. You may install the Service Manager graphically by running the installer from within a windows manager. In both cases the steps are identical. You may also install the Service Manager in `unattended` mode. This is especially useful if you are doing multiple installations. For more information on this topic see [Section 15.3.4, “Unattended Installation”](#).

1. Begin installation by typing:

```
shell> ./mysqlmonitor-version-installer.bin
```

2. First choose the language for the installation:

```
Language Selection
Please select the installation language
[1] English
[2] Japanese
Please choose an option [1] :
```

3. Throughout the installation process you will be asked the configuration questions for different options. Default values are shown between square brackets; to use the default press **Enter**. Otherwise, enter the new value and press **Enter**:

First, select the directory where you want MySQL Enterprise Service Manager to be installed. The default is `/opt/mysql/enterprise/monitor/`. Make sure that the location you choose has enough space to hold the installation files and the database information that will be created when MySQL Enterprise Service Manager is running.

```
Please specify the directory where the MySQL Enterprise Service Manager
will be installed.
Installation directory [/opt/mysql/enterprise/monitor/]:
```

4. Now set the Tomcat Server options. For more details on these parameters, see [Section 15.3.2.1, “Service Manager Installation Common Parameters”](#).

```
-----
Tomcat Server Options
Please specify the following parameters for the bundled Tomcat Server
Tomcat Server Port [18080]:
Tomcat Shutdown Port [18005]:
Tomcat SSL Port [18443]:
```

You will also be asked if SSL support is required. SSL support allows your agents and monitor to communicate with each other using SSL. Using SSL means that the data exchanged by the agent and MySQL Enterprise Service Manager are secure and can be used to monitor servers securely, or to monitor agents over a public connection.

You can enable SSL by pressing **Y** when prompted during installation:

```
Is SSL support required?          [y/N]:
```

5. Set the repository (embedded MySQL server) configuration options. For more details on these parameters, see [Section 15.3.2.1, “Service Manager Installation Common Parameters”](#).

```
-----
Repository Configuration
Please specify the following parameters for the bundled MySQL server
Repository Username [service_manager]:
Password :
Re-enter :
Bundled MySQL Database Port [13306]:
```

6. Before the final installation process, you will be provided with the location of the file that contains a copy of all of the settings. Be sure to follow the instructions and store this report in a secure location. There is no password recovery feature.

```
-----
Configuration Report
Note:
The settings you specified will be saved here:
/opt/mysql/enterprise/monitor/configuration_report.txt
```

```
IMPORTANT: This configuration report includes passwords stored in plain text; it
is intended to help you install and configure your agents. We strongly advise
you to secure or delete this text file immediately after installation.
```

```
Press [Enter] to continue :
```

7. You will now be asked to confirm the installation process.

```
Setup is now ready to begin installing MySQL Enterprise Monitor
on your computer.
```

```
Do you want to continue? [Y/n]: Y
```

```
Please wait while Setup installs MySQL Enterprise Monitor
on your computer.
```

The installation process may take a few minutes to complete. Upon completion you should see:

```
Completed installing files
```

```
Setup has completed installing MySQL Enterprise files on your computer
```

```
Uninstalling the MySQL Enterprise files can be done by invoking:
```

```
/opt/mysql/enterprise/monitor/uninstall
```

```
To complete the installation, launch the MySQL Enterprise Dashboard and complete
the initial setup and product activation information. Refer to the readme file
for additional information and a list of known issues.
```

```
Press [Enter] to continue :
```

8. Finally, you will be given the opportunity to read a supplied [Readme](#) file that is supplied with the installation. The [Readme](#) contains important information about how to use and start your MySQL Enterprise Service Manager.

```
-----
Setup has finished installing MySQL Enterprise Monitor on your computer.
```

```
View Readme File [Y/n]: n
```

Once the [Readme](#) file has been displayed, or if you did not elect to read the file, the installation provides information about how to continue with your installation.

```
Info: To access the MySQL Enterprise Monitor please visit the
following page: http://localhost:18080/Auth.action
```

```
Press [Enter] to continue :
```

The Enterprise Dashboard will not start up automatically if you perform a [text](#) mode installation. For more information on starting and stopping MySQL Enterprise Service Manager, see [Section 15.3.2.6, “Starting/Stopping the MySQL Enterprise Monitor Service on Unix and Mac OS X”](#).

### 15.3.2.5. Starting/Stopping the MySQL Enterprise Monitor Service on Windows

You can choose to start up the MySQL Enterprise Service Manager on installation. The installed services are called:

- MySQL Enterprise Tomcat
- MySQL Enterprise MySQL

You can stop or start the services from the Microsoft Management Console Services window. Look for the [MySQL Enterprise Tomcat](#) and the [MySQL Enterprise MySQL](#) entries.

#### Note

On Windows Vista, starting these services requires administrative privileges — you must be logged in as an administrator. To start or stop a service right click it and choose the [RUN AS ADMINISTRATOR](#) menu option. The same restric-



tion applies to using the menu options discussed in the following and to starting the services from the command line. To open an administrator `cmd` window right click the `cmd` icon and choose the `RUN AS ADMINISTRATOR` menu option.

To start or stop a service, right click it and choose from the options in the pop-up menu.

There is also a menu entry for starting and stopping the services. Navigate to the `Program, MySQL, MySQL Enterprise Monitor, Services` entry to stop or start the services.

You can also stop or start a service from the command line. To start the Tomcat service type:

```
shell> sc start MySQLEnterpriseTomcat
```

or:

```
shell> net start MySQLEnterpriseTomcat
```

To stop this service type:

```
shell> sc stop MySQLEnterpriseTomcat
```

or:

```
shell> net stop MySQLEnterpriseTomcat
```

In similar fashion, you may stop or start the MySQL server from the command line. The service name is `MySQLEnterpriseMySQL`.

You may also start, stop, and restart a specific service or both services using the `mysqlmonitorctl.bat` file. To execute this file, go to the command line and navigate to the `C:\Program Files\MySQL\Enterprise\Monitor` directory. Typing `mysqlmonitorctl.bat help` produces the following output:

```
usage: mysqlmonitorctl.bat help
mysqlmonitorctl.bat (start|stop|restart|install|uninstall)
mysqlmonitorctl.bat (start|stop|restart) tomcat
mysqlmonitorctl.bat (start|stop|restart) mysql

help      - this screen
start     - start the service(s)
stop      - stop the service(s)
restart   - restart or start the service(s)
install   - install the service(s)
uninstall - uninstall the service(s)
```

To stop a specific service, pass the argument `tomcat` or `mysql` in addition to the status change argument. If you wish to change the status of both services, do not specify a service name. You may also uninstall the services using this batch file.

Configuration of the dashboard begins immediately after the Service Manager is installed. To continue a Windows installation skip the next section and go to [Section 15.3.2.7, "MySQL Enterprise Service Manager Configuration Settings and Advisor Installation"](#).

### 15.3.2.6. Starting/Stopping the MySQL Enterprise Monitor Service on Unix and Mac OS X

The services incorporated into the MySQL Enterprise Service Manager are:

- The MySQL Server
- The Apache/Tomcat Server

Should you need to stop, start, or restart the MySQL Enterprise Service Manager call the `mysqlmonitorctl.sh` file located in the `/opt/mysql/enterprise/monitor/` directory on Unix or the `/Applications/mysql/enterprise/monitor/` on Mac OS X. To see all the available options navigate to the appropriate directory and type:

```
shell> /opt/mysql/enterprise/monitor/mysqlmonitorctl.sh help
```

Executing this script produces the following output:

```
usage: ./mysqlmonitorctl.sh help
./mysqlmonitorctl.sh (start|stop|status|restart)
./mysqlmonitorctl.sh (start|stop|status|restart) mysql
./mysqlmonitorctl.sh (start|stop|status|restart) tomcat
```

```

help      - this screen
start     - start the service(s)
stop      - stop the service(s)
restart   - restart or start the service(s)
status    - report the status of the service

```

Using this script you can stop, start, or restart all the Service Manager components. To do this make a call to `mysqlmonitorctl.sh start` from your start-up script.

To start the service:

```

shell> ./mysqlmonitorctl.sh start
./mysqlmonitorctl.sh : mysql started
nohup: redirecting stderr to stdout
Starting mysqld daemon with databases from /opt/mysql/enterprise/monitor/mysql/data/
Using CATALINA_BASE:   /opt/mysql/enterprise/monitor/apache-tomcat
Using CATALINA_HOME:   /opt/mysql/enterprise/monitor/apache-tomcat
Using CATALINA_TMPDIR: /opt/mysql/enterprise/monitor/apache-tomcat/temp
Using JRE_HOME:        /opt/mysql/enterprise/monitor/java

```

If you try to start the service and it is already running, you will be warned that the services are already running:

```

shell> ./mysqlmonitorctl.sh start
./mysqlmonitorctl.sh : mysql (pid 18403) already running
./mysqlmonitorctl.sh : tomcat (pid 18480) already running

```

To stop the service:

```

shell> ./mysqlmonitorctl.sh stop
Using CATALINA_BASE:   /Applications/mysql/enterprise/monitor/apache-tomcat
Using CATALINA_HOME:   /Applications/mysql/enterprise/monitor/apache-tomcat
Using CATALINA_TMPDIR: /Applications/mysql/enterprise/monitor/apache-tomcat/temp
Using JRE_HOME:        /System/Library/Frameworks/JavaVM.framework/Versions/1.5.0/Home
Stopping tomcat service .. [ OK ]
STOPPING server from pid file /Applications/mysql/enterprise/monitor/mysql/data/mysqld.pid
090209 15:37:09 mysqld ended

```

The `restart` command is equivalent to executing a `stop` and then `start` operation.

This script can also be used to check the status of the Tomcat web server or the MySQL repository.

```

shell> ./mysqlmonitorctl.sh status
MySQL Network MySQL is running
MySQL Network Tomcat is running

```

Configuration of the dashboard begins immediately after the MySQL Enterprise Service Manager is installed.

### 15.3.2.7. MySQL Enterprise Service Manager Configuration Settings and Advisor Installation

The Enterprise Dashboard is the web-based interface to the Service Manager so the procedure for starting the dashboard is identical for all platforms. From the dashboard you can configure the settings necessary for receiving updates from MySQL Enterprise and for the initial installation of the Advisors.

If you installed the Service Manager using a graphical interface, you have the option of launching the dashboard on the final installation screen (as long as the LAUNCH MYSQL ENTERPRISE MONITOR NOW checkbox is checked).

Otherwise, you can view the dashboard by typing `http://localhost:18080/Auth.action` into the address bar of your web browser. If you are unsure of the host name and port to use, check the `configuration_report.txt` file.

Under Windows it is also possible to open the dashboard by choosing the `MySQL` menu item and finding the `MySQL Enterprise Monitor` entry. Under this entry choose `Start Service Manager`.

#### 15.3.2.7.1. Initial Dashboard Log-in

If this is the first time that you have attempted to log in to the dashboard you should see a screen similar to the following:

**Figure 15.11. MySQL Enterprise Monitor: Initial dashboard log-in**

**Welcome to the MySQL Enterprise Dashboard Setup.**  
Before proceeding, you must complete the form below.

**Enterprise Credentials and Subscription Information**

**To enable this application, please provide a MySQL Enterprise Product Key or your MySQL Enterprise credentials**  
When you press "complete setup", your Enterprise credentials will be validated at enterprise.mysql.com. These credentials will that you may update your credentials or Product Key at any time on the Settings page.

**Email Address** (MySQL Enterprise Login)

**Enterprise Password** (MySQL Enterprise Password)

**Confirm Password**

- OR -

**MySQL Enterprise Product Key**

**Advisor .jar File** (recommended)

Create Administrator	Configure Agent Credentials
<b>Username</b> <input type="text" value="admin"/>	<b>Username</b> <input type="text" value="agent"/>
<b>Password</b> <input type="password"/>	<b>Password</b> <input type="password"/>
<b>Confirm Password</b> <input type="password"/>	<b>Confirm Password</b> <input type="password"/>

Use this screen to perform the following tasks:

- Install the Advisors
- Set up your MySQL Enterprise credentials
- Create a user name and password for the dashboard administrator
- Create a user name and password for the Monitor Agent

If you have been provided with a [MySQL Enterprise Product Key](#) and an Advisors file click the BROWSE button and locate these files. The advisor file bears the name, `AdvisorScript-version.jar` and the product key, `Subscription-level_date.xml`. If you do not allow Internet access from the dashboard you must install the advisors in this way. It is strongly recommended that you install the Advisors at this point, but you may do so later. For instructions on doing this see, [Section 15.3.2.7.3, "Installing Advisors After Initial Log-in"](#). If the product key that you provide is invalid a notification appears and you will be unable to import the advisors.

**Note**

If you are activating the MySQL Enterprise Monitor using a product key *do not* enter your MySQL credentials; entering both produces an error message.

If you have Internet access from the dashboard, activate MySQL Enterprise Monitor by supplying your MySQL Enterprise credentials. Enter your email address as the [MySQL Enterprise Login](#) and enter and confirm your MySQL Enterprise password. If you specify incorrect credentials, you receive the error message, “Unable to connect to verify credentials.”

In the **CREATE ADMINISTRATOR** section of this screen, enter credentials for the dashboard administrator. This creates the [root user](#) described in [Section 15.3.1.3, “Users Created on First Log-in”](#). Make note of the user name and password as these credentials are required for any future login.

In the **CONFIGURE AGENT CREDENTIALS** section of this screen enter the credentials for the agent. This is the [agent user](#) also described in [Section 15.3.1.3, “Users Created on First Log-in”](#). The agent needs to log in in order to report its findings. Make note of the agent's credentials; this information is required when installing the agent.

When all the settings have been specified, click the COMPLETE SETUP button. If you log in successfully you should see a message displaying the number of graphs and advisors that have been imported. This number varies depending upon your subscription level.

If importation of the advisor files fails, you will see the message:

```
Unable to import Advisor Jar. You may download the jar manually from the Enterprise Portal and import it from the 'Check For Updates' page.
```

In this case you may download the advisor file from the Enterprise website and install it as described in [Section 15.3.2.7.3, “Installing Advisors After Initial Log-in”](#).

### 15.3.2.7.2. Setting the Timezone and Locale

If this is the first time that you have launched the dashboard you are asked to set your time zone and locale. Choose the appropriate values from the drop-down list boxes. Setting the time zone ensures that you have an accurate time reference for any notifications from the MySQL Enterprise Advisors.

**Warning**

It is especially important that the time zone be set correctly as this may also affect the way the graphs display. For this reason, also ensure that the time reported by the operating system is correct. To change the time zone or locale see [Section 15.6.2, “User Preferences”](#).

The locale chosen determines the user's default language when logging in to the Dashboard. Note that this will override the default browser settings whenever this specific user logs in.

After specifying your time zone and locale, the dashboard opens on the [Monitor](#) page. For a detailed examination of the [Monitor](#) Screen see, [Section 15.5, “MySQL Enterprise Dashboard”](#).

### 15.3.2.7.3. Installing Advisors After Initial Log-in

The Advisors interpret the data sent by the Monitor Agents and display the results in the dashboard. A minimal set of Advisors are preinstalled with the Service Manager. To obtain the full set of Advisors and get the most value from the MySQL Enterprise Monitor, you must download Advisors from MySQL Enterprise.

If you did not install the Advisors when you first logged in to the MySQL Enterprise Dashboard, open the dashboard, find the [Advisors](#) tab, and choose the [Check for Updates](#) link. Doing this downloads the latest version of the Advisors from the MySQL Enterprise web site. In order to install the advisors in this fashion you must specify your MySQL Enterprise credentials. Find instructions for doing this in [Section 15.6.1, “Global Settings”](#).

If you do not allow Internet access from the dashboard, you must install the Advisors from a local file. To do this you need an advisor file bearing the name, [AdvisorScript-version.jar](#). If you don't already have this file, you can find it on the MySQL Enterprise downloads page. Download the Advisors file to a location that is accessible from the dashboard. Use the BROWSE button to find the Advisors file and then choose IMPORT to load the advisors.

### 15.3.2.7.4. Upgrading and Updating Advisors

The process for upgrading advisors is exactly the same as the initial installation. Advisors are updated by choosing the UPDATE button on the [Check for Updates](#) page. If you do not have Internet access from the dashboard you can import the Advisors from a local file as described in [Section 15.3.2.7.3, “Installing Advisors After Initial Log-in”](#).

**Note**

You may choose to upgrade your MySQL Enterprise Monitor subscription level at any time.

### 15.3.2.7.5. Outgoing Email Settings

Alert notification via email is a key component of the MySQL Enterprise Monitor Advisor solution. For this reason you may want to immediately configure an SMTP account for at least one recipient.

To do this choose the [Settings](#) tab and go to the [Global Settings](#) screen by clicking the appropriate link. Here you can configure the email settings. These settings apply to the currently logged-in user.

Find the [Outgoing Email Settings](#) on the left of this page.

**Figure 15.12. MySQL Enterprise Monitor: Outgoing email settings**

**Outgoing Email Settings**

**Enable Email Notifications**  
From Address (ex. "MySQL Dashboard" <name@domain.com>)

**SMTP Server**

**SMTP Server Login**

**Disable JavaMail TLS/SSL**

**Update Password On Save**

**SMTP Server Password**      **Confirm Password**  
                     

**On Save, Send Test Email Message to** (optional)

Ensure that the [Enable Email Notifications](#) checkbox is checked and enter information as appropriate.

The default value for the SMTP port is 25. If your mail server runs on a different port simply specify it, separating it from the server name using a colon. For example, if your mail server runs on port 587 enter `email.myserver.com:587` into the **SMTP SERVER** text box.

#### Note

An email server must be available for sending email alerts.

The SMTP client uses Transport Layer Security (TLS) if the SMTP server supports it.

If your SMTP server incorrectly indicates that it supports TLS, check the **DISABLE JAVAMAIL TLS/SSL** check box.

The email settings page is dealt with in more detail in [Section 15.6, "The Settings Page"](#).

### 15.3.3. Monitor Agent Installation

A MySQL Enterprise Monitor Agent monitors a MySQL server and sends data to the Advisors. These data are interpreted and displayed in the dashboard. The Monitor Agent is installed on all platforms using the steps described in the next section.

#### Warning

The MySQL Enterprise Service Manager version 2.0 or higher requires agents with a version number of 2.0 or higher.

#### 15.3.3.1. Creating a MySQL User Account for the Monitor Agent

Before setting up an agent to monitor a MySQL server you need to ensure that there is a user account for the agent on that server.

The privileges required for this user account vary depending on the information you wish to gather using the MySQL Enterprise Monitor Agent. The following privileges allow the Monitor Agent to perform its assigned duties without limitation:

- **SHOW DATABASES:** Allows the MySQL Enterprise Monitor Agent to gather inventory about the monitored MySQL server.
- **REPLICATION CLIENT:** Allows the MySQL Enterprise Monitor Agent to gather Replication master/slave status data. This privilege is only needed if the MySQL Replication Advisor Rules are employed.
- **SELECT:** Allows the MySQL Enterprise Monitor Agent to collect statistics for table objects.
- **SUPER:** Allows the MySQL Enterprise Monitor Agent to execute `SHOW ENGINE INNODB STATUS` in order to collect data about InnoDB tables.
- **PROCESS:** When monitoring a MySQL server running MySQL 5.1.24 or above with InnoDB, the **PROCESS** privilege is required to execute `SHOW ENGINE INNODB STATUS`.
- **INSERT:** Required to create the UUID required by the agent.
- **CREATE:** Allows the MySQL Enterprise Monitor Agent to create tables. During discovery, the agent creates the table `inventory` within the `mysql` database that is used to the UUID for the server. Without this table, the agent cannot determine the UUID of the server and therefore use this when sending information to MySQL Enterprise Service Manager.

For example, the following **GRANT** statement will give the agent the required **SELECT**, **REPLICATION CLIENT**, **SHOW DATABASES** and **SUPER** rights:

```
GRANT SELECT, REPLICATION CLIENT, SHOW DATABASES, SUPER, PROCESS
ON *.*
TO 'mysqluser'@'localhost'
IDENTIFIED BY 'agent_password';
```

For security reasons, you may wish to limit the **CREATE** and **INSERT** privileges to the agent so that it can only create tables within the `mysql` database:

```
GRANT CREATE, INSERT
ON mysql.*
TO 'mysqluser'@'localhost'
IDENTIFIED BY 'agent_password';
```

To enable replication discovery to work, you should also grant the **SELECT** privilege on the `mysql.inventory` table for each user with replication privileges on the corresponding replication master. This is required to let the MySQL Enterprise Monitor Agent read the replication master UUID. For example:

```
GRANT SELECT
ON mysql.inventory
TO 'replicationuser'@'%'
IDENTIFIED BY 'replication_password';
```

If the agent is unable to access the information from the table then a warning containing this information will be written to the agent log.

#### Note

You may want to disable logging for the grant statement to prevent the grant information being replicated to the slaves. If this is the case, execute the statement `SET SQL_LOG_BIN=0` before you execute the above **GRANT** statement.

In a typical configuration, the agent runs on the same machine as the MySQL server it is monitoring so the host name will be `loc-`

*alhost*. However, this will change if the agent is running on a machine other than the one that hosts the monitored MySQL server. In this case, change *localhost* to the appropriate value. For more information about remote monitoring see [Section 15.3.3.6.4, “Configuring an Agent to Monitor a Remote MySQL Server”](#).

### 15.3.3.2. Installing the Agent on Microsoft Windows

To install the MySQL Enterprise Monitor Agent on Windows, double-click the `mysqlmonitoragent-version-windows-installer.exe` (where *version* indicates the three-part version number) installer.

#### Note

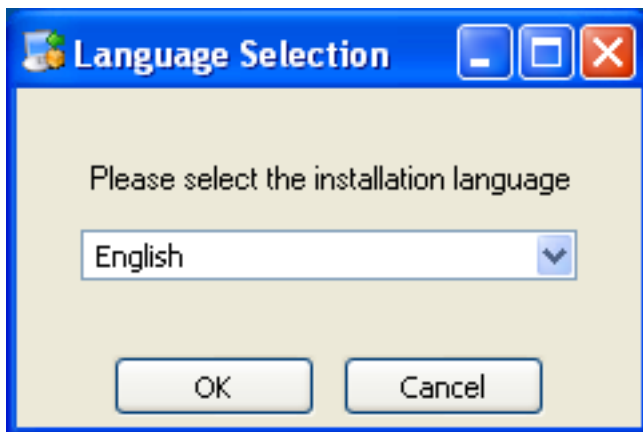
In order to install the agent as a Windows service, you must do the installation as a privileged user.

On Windows Vista, if user account control is on, an operating system dialog box requests confirmation of the installation.

You may also install the Monitor Agent in *unattended* mode. This is especially useful if you are doing multiple installations. For more information on this topic see, [Section 15.3.4, “Unattended Installation”](#).

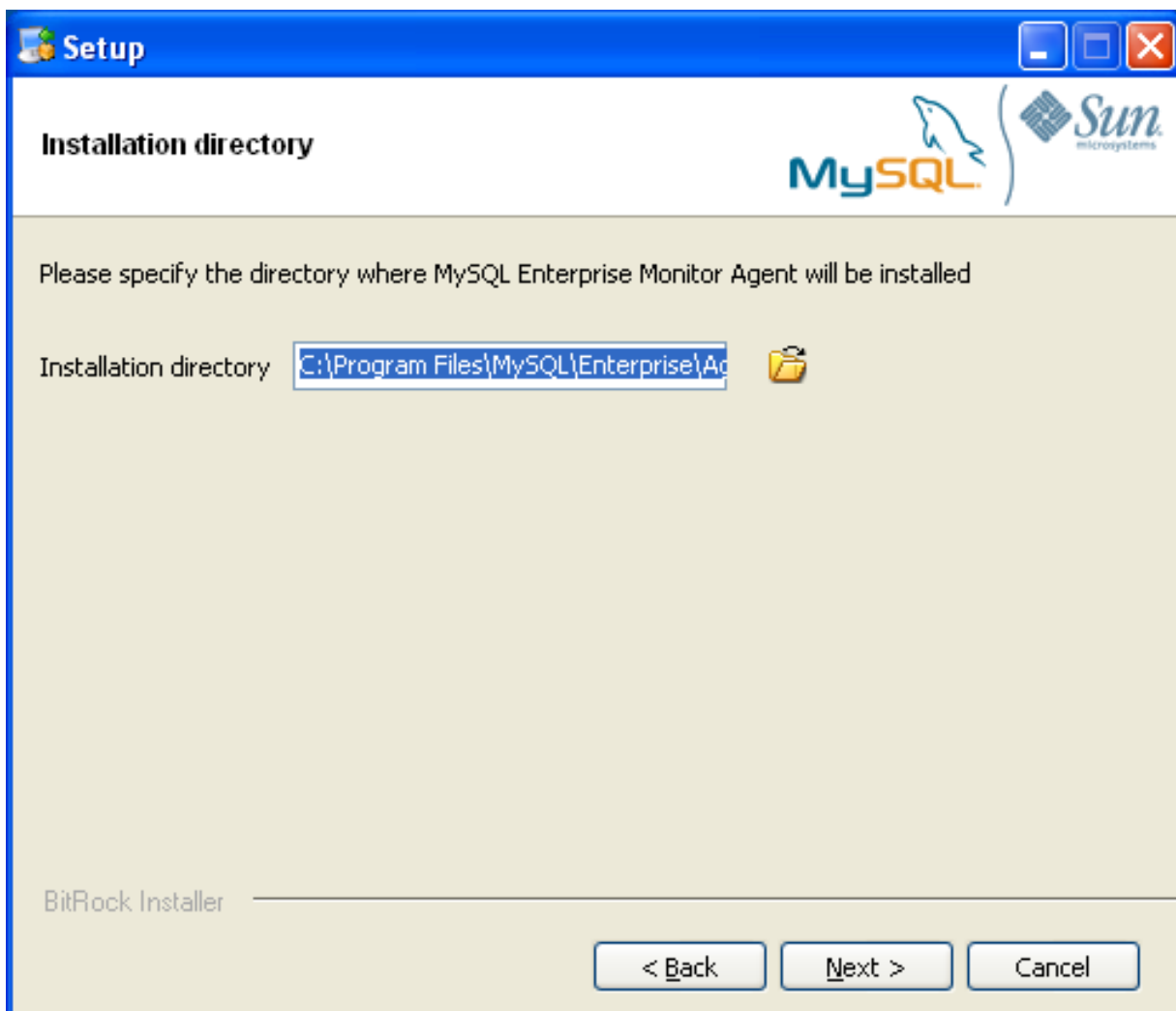
1. First, select the language for the MySQL Enterprise Monitor Agent installation. Click OK to continue installation.

**Figure 15.13. MySQL Enterprise Monitor: Installing Agent on Windows: Language Selection**



2. Click NEXT to start the installation process.
3. Select the installation directory. The default installation directory is `C:\Program Files\MySQL\Enterprise\Agent`. Select the installation directory, or type the new directory location. Click NEXT to continue the installation process.

**Figure 15.14. MySQL Enterprise Monitor: Installing Agent on Windows: Installation Directory**



4. You need to specify the information about the MySQL server that you want to monitor. You must enter the IP address or host name of the host you want to monitor, and the port, user name and password that you will use to connect to the MySQL server. If you want to confirm that the MySQL server is currently reachable using the information, ensure that the **VALIDATE MYSQL HOST NAME OR IP ADDRESS** checkbox is selected.

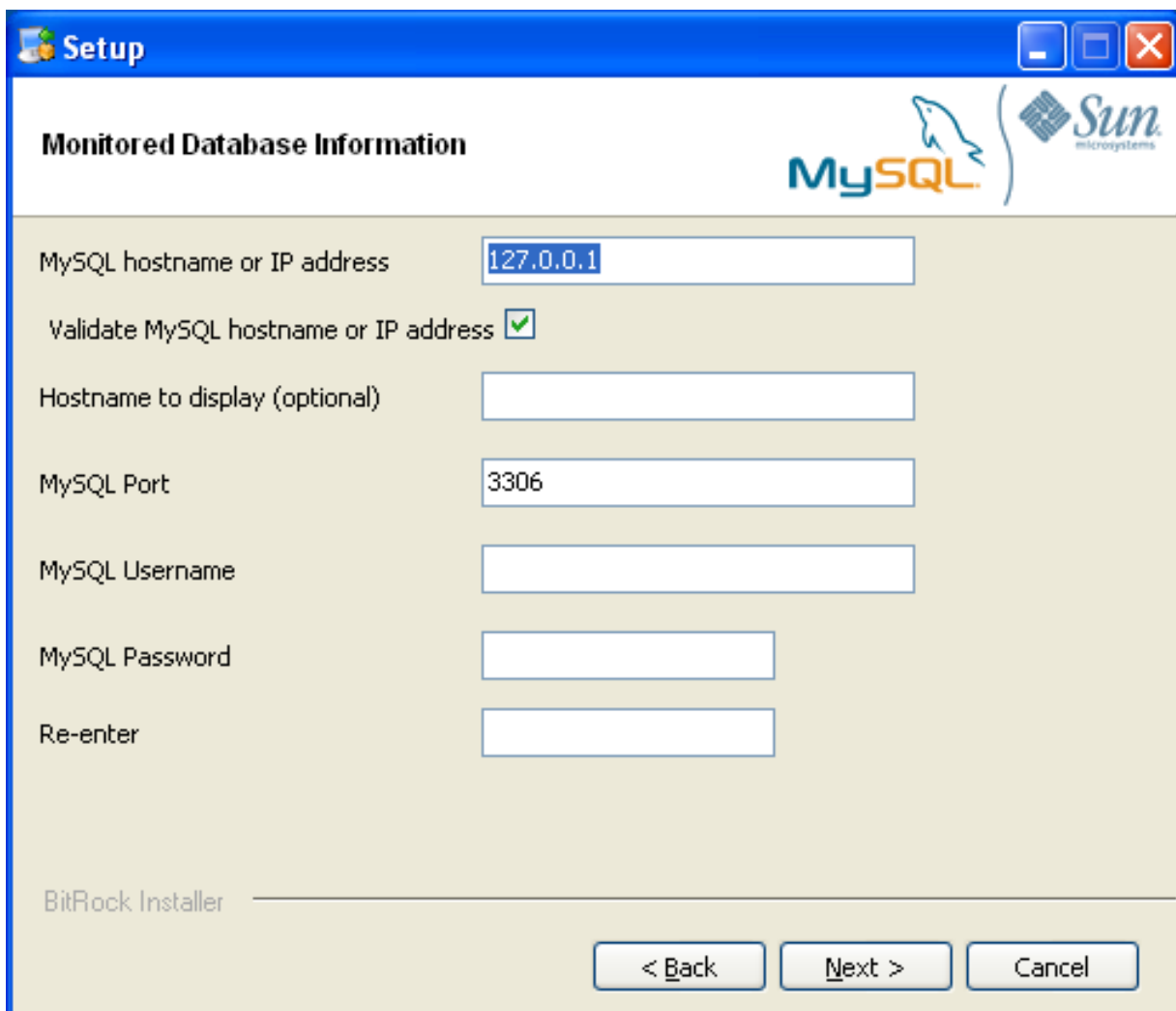
#### Note

Currently, on Windows, the service agent only includes support for connecting to the server to be monitored via TCP/IP, so if the server has been started with `--skip-networking` it cannot be monitored.

If the MySQL server to be monitored has been started using the command option `--bind-address` then the server will only listen for connections on the IP address specified, that is, the IP address of the MySQL server. If the service agent has been started using TCP/IP networking and the default address of 127.0.0.1 it will not be able to connect to the server to be monitored. Also, if "localhost" is specified as the host name during agent configuration, a connection will not be established, as the server will be listening for connections on the address specified with the `--bind-address` option, not 127.0.0.1.

**Figure 15.15. MySQL Enterprise Monitor: Installing Agent on Windows: Monitored Database Information**





The screenshot shows a Windows-style window titled "Setup" with a blue header bar. The main content area is titled "Monitored Database Information" and features the MySQL and Sun Microsystems logos in the top right corner. The configuration fields are as follows:

MySQL hostname or IP address	<input type="text" value="127.0.0.1"/>
Validate MySQL hostname or IP address	<input checked="" type="checkbox"/>
Hostname to display (optional)	<input type="text"/>
MySQL Port	<input type="text" value="3306"/>
MySQL Username	<input type="text"/>
MySQL Password	<input type="password"/>
Re-enter	<input type="password"/>

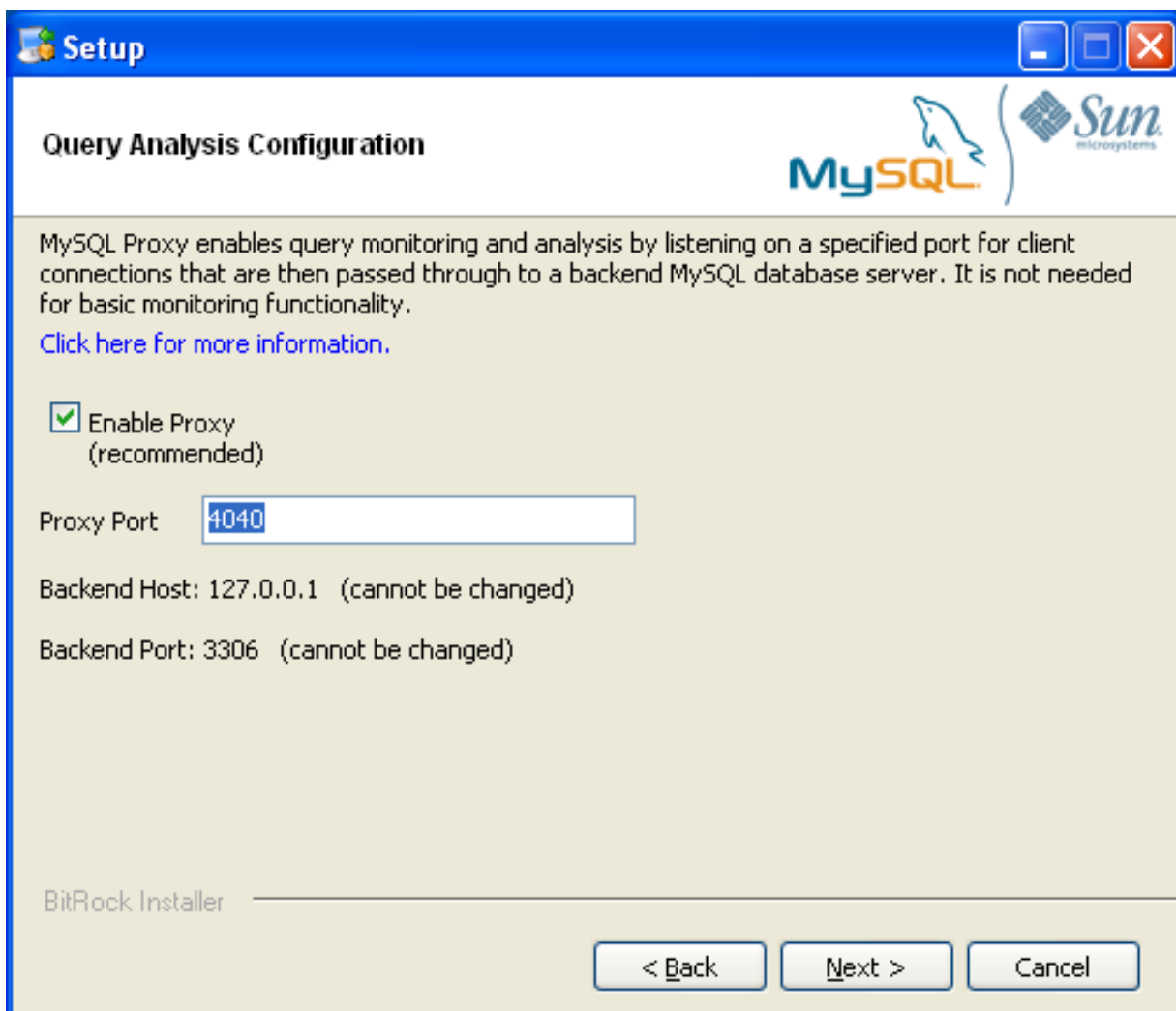
At the bottom left, it says "BitRock Installer". At the bottom right, there are three buttons: "< Back", "Next >", and "Cancel".

Click NEXT to continue the installation.

5. If you want to use Query Analyzer, then you need to enable the MySQL Enterprise Monitor Agent Proxy. The Proxy is enabled by default. If you disable the Proxy during installation, you will need to enable it later before you are able to use Query Analysis. For more information on Query Analyzer, see [Section 15.10, "The Query Analyzer Page"](#).

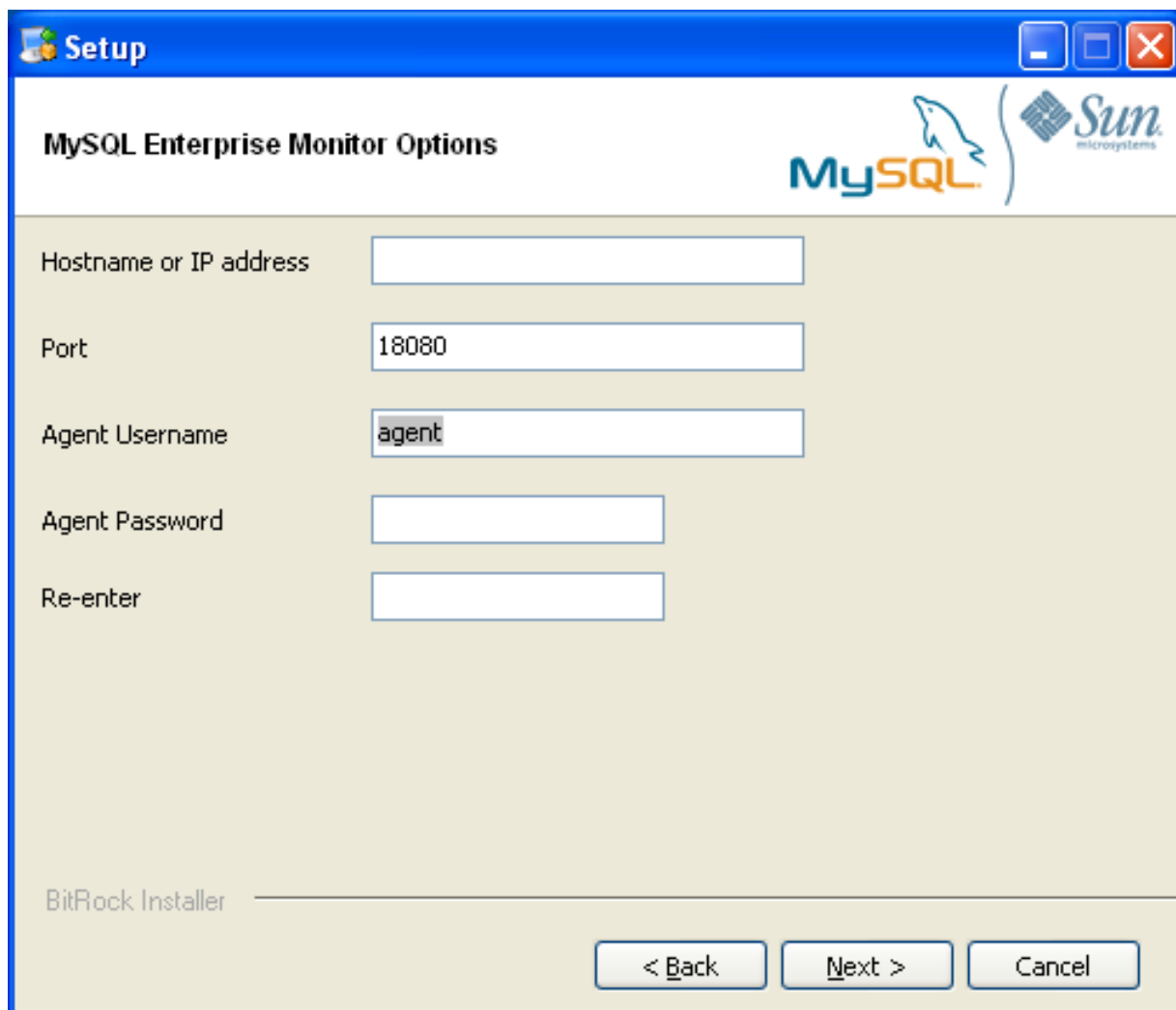
When Proxy is enabled, MySQL Enterprise Monitor Agent listens on a network port for client applications, and forwards the connections to the backend MySQL server. You can change the port number that MySQL Enterprise Monitor Agent listens for connections. The default port is 4040.

**Figure 15.16. MySQL Enterprise Monitor: Installing Agent on Windows: Query Analyzer Configuration**



6. The MySQL Enterprise Service Manager that you want to use must be configured during installation. The host name, port and agent authentication information must be entered. If you have already installed MySQL Enterprise Service Manager then you can locate the information in the installation report file created during installation. Enter the required information and then click NEXT to continue.

**Figure 15.17. MySQL Enterprise Monitor: Installing Agent on Windows: MySQL Enterprise Service Manager Options**



7. You will be provided with a Configuration Report containing the information that you have entered during the installation. Check the information provided in the report. If you see a problem, use BACK to go back to the configuration screen and change the information. If the information is correct, click NEXT to continue.
8. You are given a final opportunity to change the installation parameters. Click NEXT to start the installation process.
9. Once the agent has been installed, you will get a confirmation message. Click NEXT to finalize the installation.
10. You can start the MySQL Enterprise Monitor Agent automatically now the installation has been completed. To allow the agent to be started, leave the checkbox selected. To start the agent separately, uncheck the checkbox. Click FINISH to exit the installation.

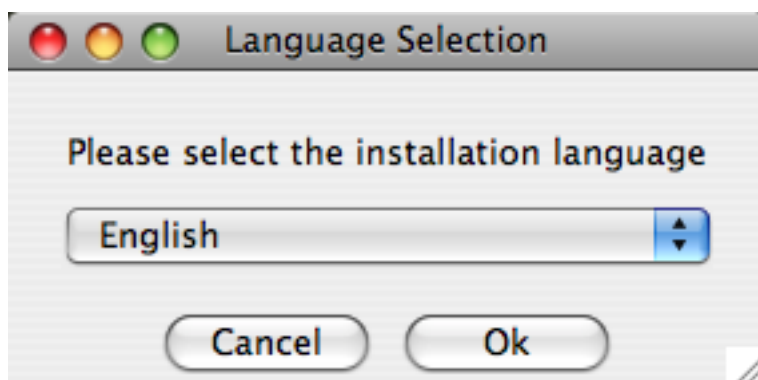
Once the Monitor Agent is installed, it needs to be started. For information on how to start and stop the Agent, see [Section 15.3.3.5.1, "Starting/Stopping the Agent on Windows"](#).

### 15.3.3.3. Installing the Agent on Mac OS X

To install the MySQL Enterprise Monitor Agent on Mac OS X, decompress the `mysqlmonitoragent-version-installer.app.zip` and then run the `mysqlenterpriseagent-version-installer` application.

1. First, select the language for the MySQL Enterprise Monitor Agent installation. Click OK to continue installation.

**Figure 15.18. MySQL Enterprise Monitor: Installing Agent on Mac OS X: Language Selection**



2. Click NEXT to start the installation process.
3. Select the installation directory. The default installation directory is `C:\Program Files\MySQL\Enterprise\Agent`. Select the installation directory, or type the new directory location.

You also need to select the method that the agent will use to communicate with the MySQL server. You can choose either to use a TCP/IP (network) connection, or a Socket (local) connection. Choose the connection method, and click NEXT.

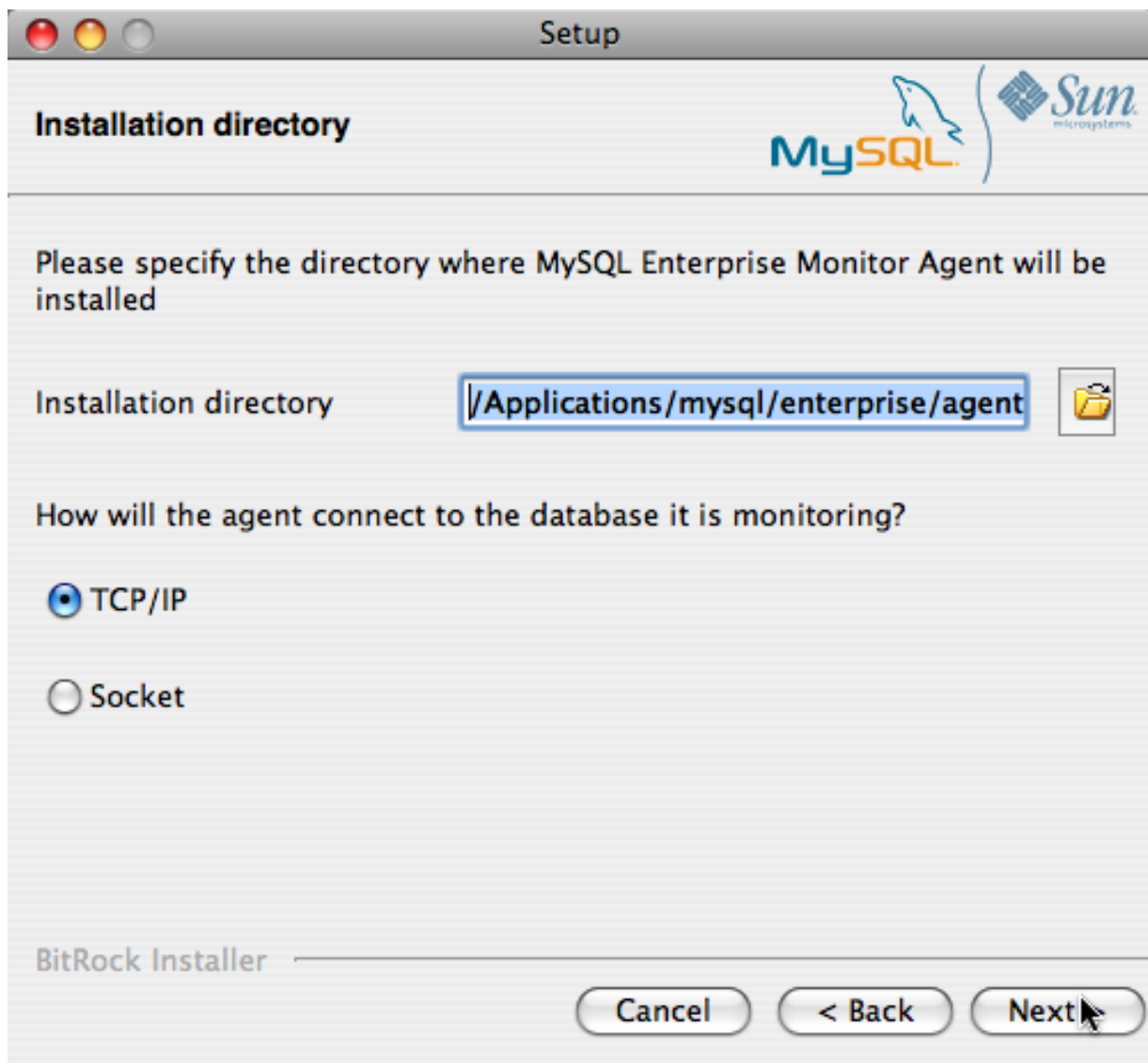
#### Note

The service agent always associates “localhost” with the TCP/IP address 127.0.0.1, not the MySQL socket. This is in contrast to the MySQL Command Line Tool, which connects via the MySQL socket by default on Unix, if the host-name “localhost” is specified.

If the MySQL server you wish to monitor has been started with the `--skip-networking` command option then you will not be able to connect to it via TCP/IP, as the server will not listen for TCP/IP connections. In this case the service agent will need to be configured to use the MySQL socket. This can be done during installation by selecting “socket” rather than “TCP/IP” and then specifying the MySQL socket name. This can also be configured after installation by editing the `agent-instance.ini` configuration file, for further information on this refer to [Section 15.3.3.6.2, “MySQL Server \(agent-instance.ini\) Configuration”](#).

If the MySQL server to be monitored has been started using the command option `--bind-address` then the server will only listen for connections on the IP address specified, that is, the IP address of the MySQL server. If the service agent has been started using TCP/IP networking and the default address of 127.0.0.1 it will not be able to connect to the server to be monitored. Also, if “localhost” is specified as the host name during agent configuration, a connection will not be established, as the server will be listening for connections on the address specified with the `--bind-address` option, not 127.0.0.1.

**Figure 15.19. MySQL Enterprise Monitor: Installing Agent on Mac OS X: Installation Directory**



4. You need to specify the information about the MySQL server that you want to monitor. The configuration information you enter will depend on the connection method selected in the previous screen.
  - If you chose TCP/IP as the connection method, you must enter the IP address or host name of the host you want to monitor, and the port, user name and password that you will use to connect to the MySQL server. If you want to confirm that the MySQL server is currently reachable using the information, ensure that the **VALIDATE MYSQL HOST NAME OR IP ADDRESS** checkbox is selected.

**Figure 15.20. MySQL Enterprise Monitor: Installing Agent on Mac OS X: Monitored Database Information**

Setup

**Monitored Database Information**

MySQL

Sun  
microsystems

IMPORTANT: The agent user account specified below requires special MySQL privileges.  
[Click here for more information.](#)

MySQL hostname or IP address

Validate MySQL hostname or IP address

MySQL Port

MySQL Username

MySQL Password

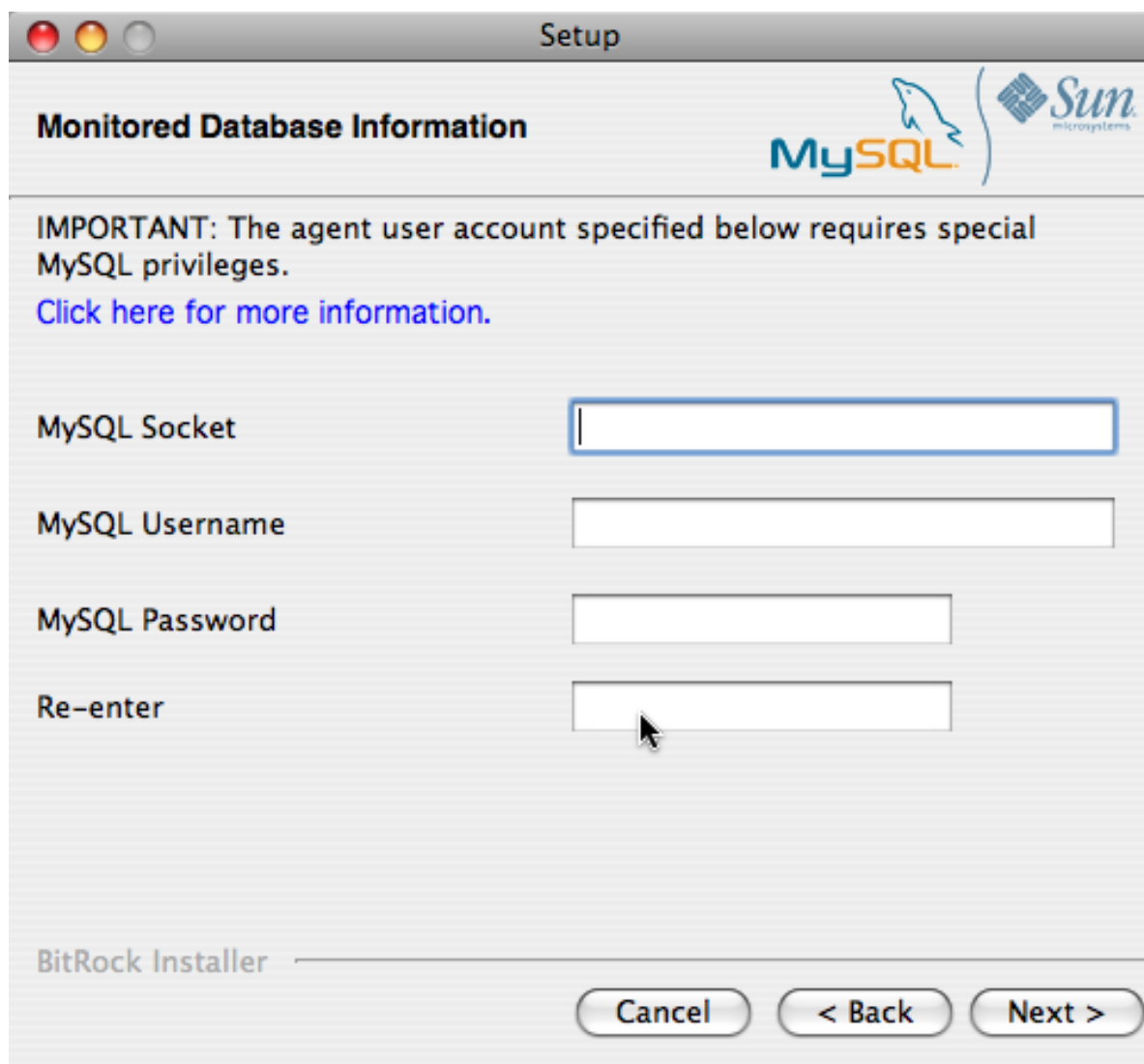
Re-enter

BitRock Installer

Cancel < Back Next >

- If you chose Socket as the connection method, you must enter the full path name to the Unix socket created by your MySQL server, and the user name and password that will be used to authenticate with the server. Typical values include `/tmp/mysql.sock` and `/var/mysql/mysql.sock`.

**Figure 15.21. MySQL Enterprise Monitor: Installing Agent on Mac OS X: Monitored Database Information**

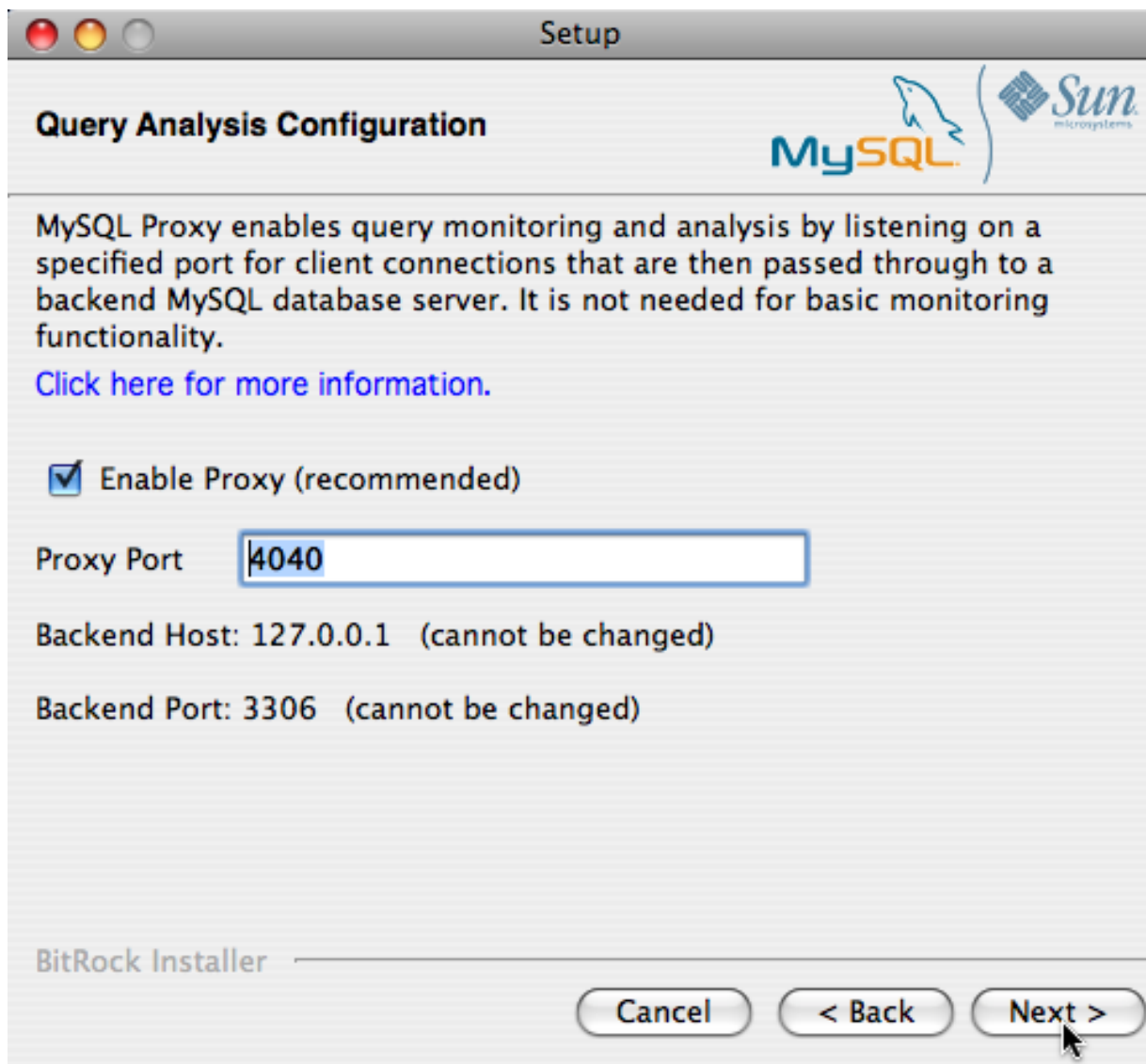


Click NEXT to continue the installation.

5. If you want to use Query Analyzer, then you need to enable the MySQL Enterprise Monitor Agent Proxy. The Proxy is enabled by default. If you disable the Proxy during installation, you will need to enable it later before you are able to use Query Analysis. For more information on Query Analyzer, see [Section 15.10, "The Query Analyzer Page"](#).

When Proxy is enabled, MySQL Enterprise Monitor Agent listens on a network port for client applications, and forwards the connections to the backend MySQL server. You can change the port number that MySQL Enterprise Monitor Agent listens for connections. The default port is 4040.

**Figure 15.22. MySQL Enterprise Monitor: Installing Agent on Mac OS X: Query Analyzer Configuration**



6. The MySQL Enterprise Service Manager that you want to use must be configured during installation. The host name, port and agent authentication information must be entered. If you have already installed MySQL Enterprise Service Manager then you can locate the information in the installation report file created during installation. Enter the required information and then click NEXT to continue.

**Figure 15.23. MySQL Enterprise Monitor: Installing Agent on Mac OS X: MySQL Enterprise Service Manager Options**



**MySQL Enterprise Monitor Options**

Hostname or IP address

Port

Agent Username

Agent Password

Re-enter

BitRock Installer

Cancel < Back Next >

7. You will be provided with a Configuration Report containing the information that you have entered during the installation. Check the information provided in the report. If you see a problem, use BACK to go back to the configuration screen and change the information. If the information is correct, click NEXT to continue.
8. You are given a final opportunity to change the installation parameters. Click NEXT to start the installation process.
9. Once the agent has been installed, you will get a confirmation message. Click NEXT to finalize the installation.
10. You can start the MySQL Enterprise Monitor Agent automatically now the installation has been completed. To allow the agent to be started, leave the checkbox selected. To start the agent separately, uncheck the checkbox. Click FINISH to exit the installation.

Once the Monitor Agent is installed, it needs to be started. For information on how to start and stop the Agent, see [Section 15.3.3.5.2, "Starting/Stopping the Agent on Mac OS X"](#).

#### 15.3.3.4. Installing the Monitor Agent on Unix

As a prerequisite for installing the MySQL Enterprise Monitor Agent on Linux systems you must have the Linux Standards Base (LSB) initialization functions installed.

To install the agent navigate to the directory that contains the file, `mysqlmonitoragent-version-installer.bin` (where *version* indicates the three-part version number, the OS, and the architecture). Ensure that this file is executable by typing:

```
shell> chmod +x mysqlmonitoragent-version-installer.bin
```

To install to the default directory (`/opt/mysql/enterprise/agent`) you need to be logged in as `root`. Installing as an unprivileged user installs to the `/home/user_name/mysql/enterprise/agent` directory.

### Note

If you install the agent as an unprivileged user, it will not automatically start up on rebooting.

What follows describes installation from the command line. You may install the Monitor Agent graphically by running the installer from within a windows manager. In both cases the steps are identical. You may also install the Monitor Agent in `unattended` mode. This is especially useful if you are doing multiple installations. For more information on this topic see [Section 15.3.4, “Unattended Installation”](#).

Begin installation from the command line by typing:

```
shell> ./mysqlmonitoragent-version-installer.bin --mode text
```

The various options are shown in what follows. Default values are indicated by square brackets; to select them press ENTER. Otherwise enter a value of your choosing.

1. First, you must select the Language you want to use during the installation process:

```
Language Selection
Please select the installation language
[1] English
[2] Japanese
Please choose an option [1] :
```

2. Next, specify the directory where you want the agent installed:

```
-----
Welcome to the MySQL Enterprise Monitor Agent Setup Wizard.
-----
Please specify the directory where MySQL Enterprise Monitor Agent will be installed
Installation directory [/opt/mysql/enterprise/agent]:
```

3. Specify the MySQL server that you want to monitor. First, you must specify whether you want to use a TCP/IP or socket-based connection to communicate with the MySQL Server:

```
How will the agent connect to the database it is monitoring?

[1] TCP/IP
[2] Socket
Please choose an option [1] :
```

If you select TCP/IP, then you will be asked to enter the TCP/IP address and port number:

```
-----
Monitored Database Information
IMPORTANT: The agent user account specified below requires special MySQL privileges.
Visit the following URL for more information:
https://enterprise.mysql.com/docs/monitor/2.0/en/mem-install.html#mem-agent-rights
MySQL hostname or IP address [127.0.0.1]:

Validate MySQL hostname or IP address [Y/n]:

MySQL Port [3306]:
```

If you select Socket, then you will be asked to provide the path name to the MySQL socket. Typical values are `/tmp/mysql.sock`, `/var/lib/mysql.sock`, or `/var/run/mysql.sock`.

```
-----
Monitored Database Information
IMPORTANT: The agent user account specified below requires special MySQL privileges.
```

Visit the following URL for more information:  
<https://enterprise.mysql.com/docs/monitor/2.0/en/mem-install.html#mem-agent-rights>

MySQL Socket []:

## Note

The service agent always associates “localhost” with the TCP/IP address 127.0.0.1, not the MySQL socket. This is in contrast to the MySQL Command Line Tool, which connects via the MySQL socket by default on Unix, if the host-name “localhost” is specified.

If the MySQL server you wish to monitor has been started with the `--skip-networking` command option then you will not be able to connect to it via TCP/IP, as the server will not listen for TCP/IP connections. In this case the service agent will need to be configured to use the MySQL socket. This can be done during installation by selecting “socket” rather than “TCP/IP” and then specifying the MySQL socket name. This can also be configured after installation by editing the `agent-instance.ini` configuration file, for further information on this refer to [Section 15.3.3.6.2, “MySQL Server \(agent-instance.ini\) Configuration”](#).

If the MySQL server to be monitored has been started using the command option `--bind-address` then the server will only listen for connections on the IP address specified, that is, the IP address of the MySQL server. If the service agent has been started using TCP/IP networking and the default address of 127.0.0.1 it will not be able to connect to the server to be monitored. Also, if “localhost” is specified as the host name during agent configuration, a connection will not be established, as the server will be listening for connections on the address specified with the `--bind-address` option, not 127.0.0.1.

4. Specify the user credentials for the MySQL server that you want to monitor:

```
MySQL Username []: service_agent
MySQL Password :
Re-enter :
```

5. Select whether you want to enable Query Analyzer. If you disable the Query Analyzer during installation, you will need to manually edit the configuration file to re-enable the Query Analyzer functionality. If you enable Query Analysis (Proxy), you must specify the port on which the agent will listen for queries.

```
-----
Query Analyzer Configuration
MySQL Proxy enables query monitoring and analysis by listening on a specified port for client connections that are
Click here for more information.
[Y/n]:
Enable Proxy (recommended) [Y/n]:

Proxy Port [4040]:
Backend Host: 127.0.0.1 (cannot be changed)
Backend Port: 3306 (cannot be changed)
```

For more information on enabling Query Analyzer if you disabled it during installation, see [Section 15.10, “The Query Analyzer Page”](#).

6. Enter the details of the MySQL Enterprise Service Manager that you want to use with this agent. The configuration information required is available within the installation report generated when you installed MySQL Enterprise Service Manager

```
-----
MySQL Enterprise Monitor Options

Hostname or IP address []: 192.168.0.197
Tomcat Server Port [18080]:
Tomcat SSL Port [18443]:
```

The agent and MySQL Enterprise Service Manager support using SSL for communication. If you want to enable SSL communication between the agent and the MySQL Enterprise Service Manager, you must reply **Y** to the following question.

```
Use SSL? [y/N]:
Agent Username [agent]:
Agent Password :
Re-enter :
-----
```

7. Before installation starts, you will be provided with a summary of the installation settings that you have specified:

```
Here are the settings you specified:
Installation directory: /opt/mysql/enterprise/agent
Monitored MySQL Database:
-----
Hostname or IP address: 127.0.0.1
Port: 3306
MySQL username: mysql_user
MySQL password: password
Query Analyzer Configuration
-----
Proxy Enabled: yes
Proxy Port: 4040
MySQL Enterprise Manager:
-----
Hostname or IP address: 192.168.0.197
Tomcat Server Port: 18080
Tomcat SSL Port: 18443
Use SSL: 0
Agent username: agent
Press [Enter] to continue :
-----
Setup is now ready to begin installing MySQL Enterprise Monitor Agent on your computer.
Do you want to continue? [Y/n]: y
```

8. The installer will copy the necessary files and create the configuration file required to run the agent:

```
-----
Please wait while Setup installs MySQL Enterprise Monitor Agent on your computer.
Installing
0% _____ 50% _____ 100%
#####
-----
Info to start MySQL Agent
The MySQL agent was successfully installed. To start the MySQL Agent please
invoke:
/opt/mysql/enterprise/agent/etc/init.d/mysql-monitor-agent start
Press [Enter] to continue :
-----
Setup has finished installing MySQL Enterprise Monitor Agent on your computer.
```

9. Finally, you can read the supplied [README](#) file when prompted. The file is provided within the [share/doc/README\\_en.txt](#) file within the agent installation directory if you would like to read this file separately.

For information on starting the agent, see [Section 15.3.3.5.3, “Starting/Stopping the Agent on Unix”](#).

### 15.3.3.5. Starting/Stopping the MySQL Enterprise Monitor Agent

The MySQL Enterprise Monitor Agent can be started and stopped at any time. When not running, information about the current status of your server will not be available, and MySQL Enterprise Service Manager will provide a warning if an agent and the MySQL server that it monitors is unavailable.

**Warning**

If you are using Query Analyzer, then turning off the agent will prevent your applications from communicating with the MySQL server. See [Section 15.10, “The Query Analyzer Page”](#).

### 15.3.3.5.1. Starting/Stopping the Agent on Windows

You have the option of starting the Monitor Agent from the final installation screen. Otherwise you can do this by going to the [Start Menu](#) and under [Programs](#) find [MySQL](#) and then the [MySQL Enterprise Monitor Agent](#) entry. Simply select the [Start MySQL Enterprise Monitor Agent](#) option.

#### Note

On Windows Vista, starting the agent requires administrative privileges — you must be logged in as an administrator. To start or stop the agent right click the menu item and choose the [RUN AS ADMINISTRATOR](#) menu option. The same restriction applies to starting the agent from the command line. To open an administrator [cmd](#) window right-click the [cmd](#) icon and choose the [RUN AS ADMINISTRATOR](#) menu option.

#### Warning

To report its findings, the agent needs to be able to connect to the dashboard through the port specified during installation. The default value for this port is [18080](#); ensure that this port is not blocked. If you need help troubleshooting the agent installation see, [Section 15.3.3.7, “Troubleshooting the Agent”](#).

Alternately, you can start the agent from the command line by entering:

```
shell> sc start MySQLEnterpriseMonitorAgent
```

or:

```
shell> net start MySQLEnterpriseMonitorAgent
```

You can also start the agent by issuing the command, [agentctl.bat start](#). Stop the agent by passing the argument, [stop](#). This batch file is found in the [Agent](#) directory.

For confirmation that the service is running you can open the Microsoft Management Console Services window. To do this go to the Control Panel, find [Administrative Tools](#) and click on the link to [Services](#). Locate the service named [MySQL Enterprise Monitor Agent](#) and look under the [STATUS](#) column.

You may also start the agent from this window rather than from the [Start](#) menu or the command line. Simply right click [MySQL Enterprise Monitor Agent](#) and choose [Start](#) from the pop-up menu. Starting the agent from this window opens an error dialog box if the agent cannot connect to the MySQL server it is monitoring. No error is displayed if the agent is unable to connect to the MySQL Enterprise Service Manager.

The pop-up menu for starting the agent also offers the option of stopping the agent. To stop the agent from the command line you only need type:

```
shell> sc stop MySQLEnterpriseMonitorAgent
```

or:

```
shell> net stop MySQLEnterpriseMonitorAgent
```

#### Note

[MySQLEnterpriseMonitorAgent](#) is the default name of the Monitor Agent service. If you have added an additional agent as described in [Section 15.3.3.6.2, “MySQL Server \(agent-instance.ini\) Configuration”](#), replace [MySQLEnterpriseMonitorAgent](#) with the appropriate agent name.

### 15.3.3.5.2. Starting/Stopping the Agent on Mac OS X

The script to start the agent on Mac OS X is located in the [/Applications/mysql/enterprise/agent/etc/init.d](#) directory. To start the agent navigate to this directory and at the command line type:

```
shell> ./mysql-monitor-agent start
```

To stop the agent, use the [stop](#) command:

```
shell> ./mysql-monitor-agent stop
```

If the agent cannot be stopped because the `pid` file that contains the agent's process ID cannot be found, you can use `kill` to send a `TERM` signal to the running process:

```
shell> kill -TERM PID
```

If you are running more than one agent on a specific machine, you must also specify the path to the `ini` file when you are stopping the agent. Executing `mysql-monitor-agent stop` without an `ini` file will only stop the agent associated with the default `ini` file.

For more information about creating additional agents see, [Section 15.3.3.6.2, “MySQL Server \(agent-instance.ini\) Configuration”](#).

To verify that the agent is running use the following command:

```
shell> ./mysql-monitor-agent status
```

The resulting message indicates whether the agent is running or not. If the agent is not running, use the following command to view the last ten entries in the agent log file:

```
shell> tail /Applications/mysql/enterprise/agent/log/mysql-monitor-agent.log
```

For further information on troubleshooting the agent see [Section 15.3.3.7, “Troubleshooting the Agent”](#).

Installation creates the directory `/Applications/mysql/enterprise/agent` with the settings stored in the `mysql-monitor-agent.ini` file located directly below this directory in the `etc` directory. The `log` directory is also located immediately below the `agent` directory.

To see all the command-line options available when running the service agent, navigate to the `/Applications/mysql/enterprise/agent/etc/init.d` directory and execute `mysql-monitor-agent help`. You should see the message:

```
Usage: ./mysql-monitor-agent {start|stop|restart|status} [ini-file-name]
```

The `ini-file-name` option only needs to be used if the `ini` file is not installed to the default location or you have changed the name of the `ini` file. You will need to use this option if you are installing more than one agent on the same machine. Pass the full path to the `ini` file. For example, after navigating to the `/Applications/mysql/enterprise/agent/etc/init.d` directory, issue the command:

```
shell> ./mysql-monitor-agent start /Applications/mysql/enterprise/agent/etc/new-mysql-monitor-agent.ini
```

If you installed the agent as `root`, on reboot the `mysql-monitor-agent` daemon will start up automatically. If you installed the agent as an unprivileged user, you must manually start the agent on reboot or write a script to perform this task. Likewise, if you have added an additional agent as described in [Section 15.3.3.6.2, “MySQL Server \(agent-instance.ini\) Configuration”](#), and you wish to start this agent on reboot, create a system initialization script appropriate to your operating system. To determine whether the agent is running or not navigate to the `init.d` directory and issue the command `./mysql-monitor-agent status`.

### Warning

To report its findings, the agent needs to be able to connect to the dashboard through the port specified during installation. The default value for this port is `18080`; ensure that this port is not blocked. If you need help troubleshooting the agent installation see, [Section 15.3.3.7, “Troubleshooting the Agent”](#).

#### 15.3.3.5.3. Starting/Stopping the Agent on Unix

When installation is finished, you can start the service agent from the command line by typing:

```
shell> /opt/mysql/enterprise/agent/etc/init.d/mysql-monitor-agent start
```

For a non-root installation the command would be:

```
shell> /home/<user name>/mysql/enterprise/agent/etc/init.d/mysql-monitor-agent start
```

To stop the agent, use the `stop` command:

```
shell> ./mysql-monitor-agent stop
```

If the agent cannot be stopped because the `pid` file that contains the agent's process ID cannot be found, you can use `kill` to send a `TERM` signal to the running process:

```
shell> kill -TERM PID
```

If you are running more than one agent on a specific machine, you must also specify the path to the `ini` file when you are stopping the agent. Executing `mysql-monitor-agent stop` without an `ini` file will only stop the agent associated with the default `ini` file. Likewise, when checking the status of an agent specify its `ini` file.

For more information about creating additional agents see, [Section 15.3.3.6.2, “MySQL Server \(agent-instance.ini\) Configuration”](#).

To verify that the agent is running use the following command:

```
shell> ./mysql-monitor-agent status
```

The resulting message indicates whether the agent is running or not. If the agent is not running, use the following command to view the last ten entries in the agent log file:

```
shell> tail /opt/mysql/enterprise/agent/log/mysql-monitor-agent.log
```

For further information on troubleshooting the agent see [Section 15.3.3.7, “Troubleshooting the Agent”](#).

Installation creates the directory `/opt/mysql/enterprise/agent` with the settings stored in the `mysql-monitor-agent.ini` file located directly below this directory in the `etc` directory. The `log` directory is also located immediately below the `agent` directory.

To see all the command-line options available when running the service agent, navigate to the `/opt/mysql/enterprise/agent/etc/init.d` directory and execute `mysql-monitor-agent help`. You should see the message:

```
Usage: ./mysql-monitor-agent {start|stop|restart|status} [ini-file-name]
```

The `ini-file-name` option only needs to be used if the `ini` file is not installed to the default location or you have changed the name of the `ini` file. You will need to use this option if you are installing more than one agent on the same machine. Pass the full path to the `ini` file. For example, after navigating to the `/opt/mysql/enterprise/agent/etc/init.d` directory, issue the command:

```
shell> ./mysql-monitor-agent start /opt/mysql/enterprise/agent/etc/new-mysql-monitor-agent.ini
```

If you installed the agent as `root`, on reboot the `mysql-monitor-agent` daemon will start up automatically. If you installed the agent as an unprivileged user, you must manually start the agent on reboot or write a script to perform this task. Likewise, if you have added an additional agent as described in [Section 15.3.3.6.2, “MySQL Server \(agent-instance.ini\) Configuration”](#), and you wish to start this agent on reboot, create a system initialization script appropriate to your operating system. To determine whether the agent is running or not navigate to the `init.d` directory and issue the command `./mysql-monitor-agent status`.

### Warning

To report its findings, the agent needs to be able to connect to the dashboard through the port specified during installation. The default value for this port is `18080`; ensure that this port is not blocked. If you need help troubleshooting the agent installation see, [Section 15.3.3.7, “Troubleshooting the Agent”](#).

## 15.3.3.6. Advanced Agent Configuration

The MySQL Enterprise Monitor Agent is configured through files located within the `etc` directory within the directory where you installed the agent.

Configuration is stored in multiple files, according to a predetermined file and directory layout. The primary configuration file contains specific information about the agent and how the agent communicates with MySQL Enterprise Service Manager. The main configuration is located within the `mysql-monitor-agent.ini` file.

Additional configuration files contain information about the MySQL server that is being monitored. You can configure which directory is used for storing this information within the `mysql-monitor-agent.ini` file. The default location is the `etc/instances` directory within the MySQL Enterprise Monitor Agent directory.

The server you want to monitor should have a directory within the specified location, optionally using the name of the server you are monitoring, and within that directory, an `agent-instance.ini` file. This file contains the configuration information for

connecting to the MySQL server, including the host name, port, user credentials and display name.

You can see an example of the file layout of the `etc` directory:

```
./init.d
./init.d/mysql-monitor-agent
./instances
./instances/agent
./instances/agent/agent-instance.ini
./mysql-monitor-agent.ini
```

For more information on the configuration of the `mysql-monitor-agent.ini` file, see [Section 15.3.3.6.1, “MySQL Enterprise Monitor Agent \(`mysql-monitor-agent.ini`\) Configuration”](#). For details on the content of the individual MySQL instance configuration files, see [Section 15.3.3.6.2, “MySQL Server \(`agent-instance.ini`\) Configuration”](#).

### 15.3.3.6.1. MySQL Enterprise Monitor Agent (`mysql-monitor-agent.ini`) Configuration

The `mysql-monitor-agent.ini` files contains the base configuration information for the MySQL Enterprise Monitor Agent. The file sets the core information about the supported functionality for the entire agent.

You can see a sample of the configuration file below:

```
# WARNING - the UUID defined below must be unique for each agent.
#
# To use this .ini file as a template for configuring additional
# agents, do not simply copy and start a new agent without first
# modifying the UUID.
#
# Refer to the documentation for more detailed information and
# instructions.
#
# Version: 20080718_230416_r7011

[mysql-proxy]

plugins=proxy,agent
agent-mgmt-hostname = http://agent:password@monitor-server:18080/heartbeat
mysql-instance-dir= etc/instances
agent-item-files = share/mysql-proxy/items/quan.lua,share/mysql-proxy/items/items-mysql-monitor.xml
proxy-address=:4040
proxy-backend-addresses = 127.0.0.1:3306
proxy-lua-script = share/mysql-proxy/quan.lua

agent-uuid = 8770ead5-3632-4b29-a413-4a7c92437e26
log-file = mysql-monitor-agent.log
pid-file=/Applications/mysql/enterprise/agent/mysql-monitor-agent.pid
```

#### Note

Do not copy the agent configuration information from one machine to another without changing the `agent-uuid`. Each agent instance must have a unique agent id.

The main configuration information must be located within the `[mysql-proxy]` section of the configuration file. The main configurable parameters within this file are:

- `plugins` — configures the plugins to be used by the agent. When monitoring servers you must have the `agent` plugin configured. If you want to support Query Analyzer then you must also have the `proxy` module enabled. Plugins should be specified as a comma separated list of plugin names.

If you selected to support Query Analyzer during installation of the agent, the default value will be `proxy,agent`. If you disabled Query Analysis during installation, the default value will be `agent`.

- `log-level` — sets the logging level of the agent. The default level is `message`.

Valid values for `log-level` are as follows:

- `debug` — provides detailed information about what the agent is doing and the information being provided by the agent to the MySQL Enterprise Service Manager.
- `critical` — lists critical messages highlighting problems with the agent.
- `error` — lists error messages.
- `warning` — provides only warning messages generated by the agent.
- `message` — provides information about the agent and basic processing information.



- `info` — provides messages used for informational purposes.

### Warning

Be careful when setting the `log-level` to `debug`. Doing this will rapidly increase the size of your `mysql-monitor-agent.log` file. To avoid disk space problems, put the log files on a different drive from your MySQL server and the MySQL Enterprise Dashboard.

It is strongly recommended that you use a `log-level` of `critical` or `error` in a production server. Use the higher-levels to provide more detailed information only for debugging problems with your agent.

Under Windows, if you restart the agent from the command line after setting the `log-level` to `debug`, extensive debug information is displayed to the console as well as to the log file.

- `agent-mgmt-hostname` — sets the URL to use when reporting information. This value will be automatically set to your MySQL Enterprise Service Manager during installation.
  - `mysqld-instance-dir` — sets the directory where the configuration files that specify the MySQL servers to be monitored can be located.
  - `agent-item-files` — sets the information that is provided up to the MySQL Enterprise Service Manager when the agent is reporting status information. You should leave this item with the default setting of the `share/mysql-proxy/items/quant.lua` (which provides Query Analyzer data) and `share/mysql-proxy/items/items-mysql-monitor.xml` (which provides the core agent monitoring data).
  - `proxy-address` — sets the address and/or port number for the proxy to listen to for connections. The setting is used when employing Query Analysis as the address/port that you must configure your application to use in place of your normal MySQL server. By default this item is set during installation. The default value is 4040. If you want to support a different local host name/IP address and port, specify the host name and the port number, separated by a colon.
  - `proxy-backend-addresses` — sets the host name and port number to be used when communicating the backend MySQL server when employing query analyzer. This is the MySQL server where packets from the client are sent when communicating with the proxy on the host name/port set by the `proxy-address`.
  - `proxy-lua-script` — sets the Lua script to be used by the proxy when forwarding queries. To use Query Analyzer, this parameter should be set to `share/mysql-proxy/quant.lua`. This is the default value.
  - `agent-uuid` — sets the UUID (Universally Unique ID) of the agent. This value should be unique for all agents communicating with the same server, as the UUID is used to uniquely ID the agent within MySQL Enterprise Service Manager
- If you are setting up multiple hosts and copying the configuration between hosts, make sure that the `agent-uuid` is unique. You can have the agent create a new UUID by leaving this configuration property blank.
- `log-file` — sets the location of the log file used to record information about the agent when it is running. If you do not specify a full path name, then the log file location is considered to be relative to the installation directory of the agent.
  - `pid-file` — sets the location of the file used to record the Process ID of the agent. This is used by the script that shuts down the agent to identify the process to be shutdown. The default value is the `mysql-monitor-agent.pid` file within the base installation directory as created by the agent installer.

A number of optional parameters are also configurable within the `mysql-monitor-agent.ini` file:

- `backlog-threshold` — determines the amount of time that the agent will collect information after detecting that the service manager is down. The default value for this option is 600 seconds. In cases where there is a short network outage no information will be lost. If the outage is longer than the value of `backlog-threshold` older data is dropped as the new data is acquired.

A setting of 600 seconds means that excessive memory usage is avoided should there be a long outage. In most circumstances, there is no need to change this option. To set `backlog-threshold` to a value other than the default, add a line with the information specifying the number of seconds.

### Warning

Setting this option to a value higher than the default can exhaust memory.

## 15.3.3.6.2. MySQL Server (`agent-instance.ini`) Configuration

For the MySQL server that you want to monitor, you must create an `agent-instance.ini` within the directory specified by the `mysqld-instance-dir` configuration parameter within the main `mysql-monitor-agent.ini` file.

The `agent-instance.ini` file contains the host name and user credentials for connecting to the MySQL server that you want the agent to monitor. The format of the file is as follows:

```
# WARNING - the displayname defined below must be unique for each
# MySQL server being monitored.
#
# To use this .ini file as a template for configuring additional
# instances to monitor, do not simply copy and start a new agent
# without first modifying the displayname.
#
# Refer to the documentation for more detailed information and
# instructions.
#
# Version: 20080718_230416_r7011

[mysqld]
hostname = 127.0.0.1
port     = 3306
user     = root
password =
```

The individual configuration parameters can be defined as follows:

- `hostname` — the host name of the MySQL server that you want to monitor.
- `port` — the TCP/IP port of the MySQL server that you want to monitor.
- `user` — the user to use when connecting to the MySQL server that you want to monitor.
- `password` — the corresponding password to use when connecting to the MySQL server that you want to monitor.

It is also possible to configure the agent to use sockets. This can be done during installation by selecting “socket” rather than “TCP/IP” from the menu and then specifying the socket name. This can also be configured after installation by editing the `agent-instance.ini` configuration file, and adding the line:

```
socket = /full/path/to/mysql.sock
```

### 15.3.3.6.3. Monitoring Multiple MySQL Servers

You can monitor multiple MySQL servers (either on the same machine, or across different machines) using two different methods:

- By using a single agent instance to monitor multiple MySQL servers. You can use this method if you want to monitor multiple servers, but do not want or need to support Query Analysis on the additional servers.
- By using multiple copies of the MySQL Enterprise Monitor Agent to monitor each server individually. Using this method requires additional overhead to monitor each server, while also allowing you to supply Query Analysis data.

#### Using a Single Agent Instance

To use a single agent to monitor multiple instances, you can create additional directories and configuration files within the `instances` directory for the agent. For example, you can see the default structure of the agent configuration directory:

```
./init.d
./init.d/mysql-monitor-agent
./instances
./instances/agent
./instances/agent/agent-instance.ini
./mysql-monitor-agent.ini
```

Within the `instances` directory, you can add further directories, one for each monitored server. Each additional directory must have a suitable `agent-instance.ini` file containing the connection information for the new MySQL server instance. For example, the following structure demonstrates an agent monitoring four MySQL servers:

```
./init.d
./init.d/mysql-monitor-agent
./instances
./instances/agent
./instances/agent/agent-instance.ini
./instances/mysql2
./instances/mysql2/agent-instance.ini
./instances/mysql-rep
```

```
./instances/mysql-rep/agent-instance.ini
./instances/mysql-backup
./instances/mysql-backup/agent-instance.ini
./mysql-monitor-agent.ini
```

To add another MySQL monitored server, follow these steps:

1. Make sure that the MySQL instance that you want to monitor has a suitable user to use for connecting to the server. For more information, see [Section 15.3.3.1, “Creating a MySQL User Account for the Monitor Agent”](#).
2. Copy an existing configuration directory and configuration files to the new directory:

```
shell> cp -R etc/instances/agent etc/instances/mysql2
```

3. Edit the configuration file within the new directory, for example `mysql2/agent-instance.ini`, and set the `user`, `password` and either the `hostname` and `port`, or `socket` parameters.
4. Restart the agent:

```
shell> mysql-monitor-agent restart
```

### Using Multiple Agent Instances

To use multiple agents to monitor multiple MySQL servers you need to create a new configuration structure for both the agent and the MySQL server instances you need to monitor, including the binaries and configuration files, and then update the configuration to set the corresponding parameters to monitor the new server. Using this method allows you to enable query analysis by redirecting requests to the target server using the built-in proxy service within the agent.

For example, the directory structure below shows the configuration directory for two agents monitoring a single MySQL server each:

```
./init.d
./init.d/mysql-monitor-agent
./instances
./instances/agent
./instances/agent/agent-instance.ini
./instances-second/agent
./instances-second/agent/agent-instance.ini
./mysql-monitor-agent.ini
./mysql-second-agent.ini
```

The `mysql-monitor-agent.ini` file contains the configuration for the first agent, with the MySQL servers monitored defined within the `instances` directory. The `mysql-second-agent.ini` file contains the configuration information for the second agent, with the MySQL servers monitor defined within the `instances-second` directory.

To set up multiple agents:

1. Make sure that the MySQL instance that you want to monitor has a suitable user to use for connecting to the server. For more information, see [Section 15.3.3.1, “Creating a MySQL User Account for the Monitor Agent”](#).
2. You need to generate a new UUID for the new agent:

```
shell> mysql-monitor-agent --agent-generate-uuid
ee9296d7-f7cd-4fee-8b26-ead884ebf398
2009-03-05 11:49:37: (critical) shutting down normally
```

Keep a record of the UUID to update the configuration file.

Note, the agent should not be running when the UUID is generated.

3. Copy the main agent configuration file, `mysql-monitor-agent.ini`:

```
shell> cp mysql-monitor-agent.ini mysql-second-agent.ini
```

4. Edit the new configuration file, changing the following settings:

- Change the `mysql-d-instance-dir` to the new directory that will contain the individual MySQL server configuration files.

- Change the `proxy-address` to a different value than the first agent configuration.
  - Change the `proxy-backend-addresses` to specify the IP address and MySQL port number for the MySQL server.
  - Change the `agent-uuid` to the new value obtained in an earlier step.
  - Change the `log-file` parameter to specify a different file to use when logging errors and problems. You cannot log to the same file from two different agents.
  - Change the `pid-file` parameter to specify the file that will be used to store the process ID of the agent.
5. Copy an existing configuration directory and configuration files to the new directory:

```
shell> cp -R etc/instances etc/instances-second
```

6. Edit the configuration file, `instances/second/agent/agent-instance.ini` within the new directory, and set the `user`, `password` and either the `hostname` and `port`, or `socket` parameters.
7. With multiple instances, you must start each agent individually, specifying the location of the main configuration file. For example, to start the original (default) service:

```
shell> mysql-monitor-agent start /opt/mysql/monitor/agent/etc/mysql-monitor-agent.ini
```

To start the second instance:

```
shell> mysql-monitor-agent start /opt/mysql/monitor/agent/etc/mysql-second-agent.ini
```

#### 15.3.3.6.4. Configuring an Agent to Monitor a Remote MySQL Server

Typically, the agent runs on the same machine as the MySQL server it is monitoring. Fortunately, this is not a requirement. If you want to monitor a MySQL server running on an operating system for which there is no agent available, you can install the agent on a machine other than the one hosting the MySQL server.

The process for installing an agent to monitor a MySQL server on a remote machine is identical to the process described in [Section 15.3.3, “Monitor Agent Installation”](#). Follow the directions given there, being careful to specify the correct IP address or host name for the MySQL Enterprise Service Manager and likewise for the MySQL server — since the agent is not running on the same machine as the MySQL server, it cannot be the default, `localhost`.

Don't forget that the agent must be given rights to log in to the MySQL server from a host other than `localhost` and that the port used by the MySQL server, typically `3306` must be open for remote access. For more information about the database credentials required by agents see, [Section 15.3.3.1, “Creating a MySQL User Account for the Monitor Agent”](#).

The agent also needs to be able to log in to the MySQL Enterprise Service Manager, typically using port `18080`, so ensure that the appropriate port is open.

#### Note

Monitoring a MySQL server from a remote machine affects how information is displayed in the dashboard. The `OS` and `CPU` information applies to the machine on which the agent is running not the machine hosting the monitored server. For more information on this topic see [Section 15.5, “MySQL Enterprise Dashboard”](#).

If your subscription level entitles you to replication autodiscovery, do **not** use remote monitoring with replication slaves or masters. The agent must be installed on the same machine as the server you are monitoring in order for discovery to work properly. For more information, see [Section 15.11, “The Replication Page”](#).

#### 15.3.3.6.5. Monitoring Outside the Firewall with an SSH Tunnel

If you run an SSH server on the machine that hosts the MySQL Enterprise Service Manager and an SSH client on the machine that hosts the agent, you can create an SSH tunnel so that the agent can bypass your firewall. First, you need to make an adjustment to the `hostname` value specified in the `[mysql-proxy]` section of the `.ini` file. (For more information about the contents and location of the `.ini` file see [Section 15.3.3.6.1, “MySQL Enterprise Monitor Agent \(mysql-monitor-agent.ini\) Configuration”](#).) Stop the agent and change the `hostname` value as shown in the following:

```
hostname = http://agent_name:password@localhost:18080/heartbeat
```

Replace the `agent_name` and `password` with suitable values. Likewise replace port `18080` if you are not running the dashboard on this port. Use `localhost` for the host name, since the agent is connecting through an SSH tunnel.

Next, execute the following command on the machine where the agent is running:

```
shell> ssh -L 18080:Dashboard_Host:18080 -l user_name -N Dashboard_Host
```

When prompted, enter the password for `user_name`.

If you are not running the MySQL Enterprise Service Manager on port 18080, substitute the appropriate port number. Likewise, replace `Dashboard_Host` with the correct value. `user_name` represents a valid operating system user on the machine that hosts the MySQL Enterprise Service Manager.

Be sure to restart the agent so that the new value for the `hostname` takes effect. For instructions on restarting the agent see:

- Under Windows see, [Section 15.3.3.5.1, “Starting/Stopping the Agent on Windows”](#).
- Under Unix see, [Section 15.3.3.5.3, “Starting/Stopping the Agent on Unix”](#).
- Under Mac OS X see, [Section 15.3.3.5.2, “Starting/Stopping the Agent on Mac OS X”](#).

### 15.3.3.6.6. Generating a new UUID

In Unix go to the command line and type:

```
shell> /opt/mysql/enterprise/agent/bin/mysql-monitor-agent --agent-generate-uuid
```

In Mac OS X go to the command line and type:

```
shell> /Applications/mysql/enterprise/agent/bin/mysql-monitor-agent --agent-generate-uuid
```

This should display a line similar to the following:

```
ee9296d7-f7cd-4fee-8b26-ead884ebf398
```

Paste this line into the `[mysql-proxy]` section of the `ini` file for the `agent-uuid` parameter.

Ensure that the newly created file `mysql-service-agent-3307.ini`, is in the `C:\Program Files\MySQL\Enterprise\Agent` directory.

Navigate to this directory and execute `mysql-service-agent -uf mysql-service-agent-3307.ini`. Doing this generates a new UUID and inserts it into the configuration file.

### 15.3.3.7. Troubleshooting the Agent

The first step in troubleshooting the agent is finding out whether it is running or not. To do this see:

- Windows – [Section 15.3.3.5.1, “Starting/Stopping the Agent on Windows”](#)
- Unix – [Section 15.3.3.5.3, “Starting/Stopping the Agent on Unix”](#)
- Mac OS X – [Section 15.3.3.5.2, “Starting/Stopping the Agent on Mac OS X”](#)

If incorrect credentials are specified for the agent login to the MySQL server that it is monitoring, then the agent will not run on start-up. Log in to the monitored MySQL server and check the agent's credentials. Compare the values of the `Host`, `User`, and `Password` fields in the `mysql.user` table with the values shown in the `[mysqld]` section of the `etc/instances/mysql/agent-instance.ini`. If incorrect credentials are specified in the `ini` file, simply correct them and restart the agent. Remember, changes to the `ini` file do not take effect until the agent is restarted.

The agent will not start up if incorrect credentials are specified for the service manager login. Using incorrect credentials for logging in to the service manager creates an entry in the agent log file. For the location of this log file see [Agent Log and PID Files](#).

If the agent starts up but no server appears in the dashboard, check the `hostname` specified in the `[mysql-proxy]` portion of the `mysql-monitor-agent.ini` file. Incorrect credentials, IP address, or port will all cause the MySQL server to fail to appear in the dashboard. Also, ensure that the port specified in this file is not blocked on the machine hosting the MySQL Enterprise Service Manager.

An easy way to confirm that the agent can log in to the service manager is to type `http://Dashboard_Host:18080/`

`heartbeat` into the address bar of your web browser, substituting the appropriate host name and port. When the HTTP authentication dialog box opens, enter the agent user name and password. If you log in successfully, you should see the following message:

```
<exceptions>
<error>E1031: Agent payload parameter NULL.</error>
</exceptions>
```

### Note

Despite the fact that the preceding listing shows an error, you have logged in successfully. This error appears *because* you have logged in but with no “payload”.

If you can log in successfully in the way described above and the agent is running, then there are errors in the `mysql-monitor-agent.ini` file. Compare the host name, port, agent name, and password found in the `ini` file with the values you entered into the address bar of your web browser.

If HTTP authentication fails then you are using incorrect credentials for the agent. Attempting to log in to the service manager using incorrect credentials creates an entry in the agent log file. For the location of this log file see [Agent Log and PID Files](#).

If no HTTP authentication dialog box appears, and you are unable to connect at all, then you may have specified an incorrect host name or port. Confirm the values you entered against those described as the `Application hostname and port:` in the `configuration_report.txt` file. Failure to connect could also indicate that the port is blocked on the machine hosting the MySQL Enterprise Service Manager.

To check if a blocked port is the problem, temporarily bring down your firewall. If the agent is then able to connect, open up the port specified during installation and restart the agent. If necessary you can monitor outside the firewall using an SSH tunnel. For more information, see [Section 15.3.3.6.5, “Monitoring Outside the Firewall with an SSH Tunnel”](#).

You can also check the agent error log file to help determine any problems. An error such as the following might indicate a blocked port:

```
(critical) connection to merlin-server
'http://agent:test@172.11.1.1:18080/heartbeat' failed:
"connect() timed out!" error.
```

For the location of the agent error log file see, [Agent Log and PID Files](#).

Setting the `log-level` entry in your `ini` file is also a good debugging technique. For more information on this subject see, [Section 15.3.3.6.1, “MySQL Enterprise Monitor Agent \(mysql-monitor-agent.ini\) Configuration”](#).

Running the agent from the command line sometimes displays errors that fail to appear in the log file or on the screen when the agent is started from a menu option. To start the agent from the command line see the instructions given at the start of this section.

If you have more than one agent running on the same machine, the `UUID` must be unique and the `log-file` and `pid-file` values must be different. For more information, see [Section 15.3.3.6.2, “MySQL Server \(agent-instance.ini\) Configuration”](#).

If the agent is not running on the same machine that hosts the MySQL server it is monitoring, then you must ensure that the correct `host` is specified for the agent account. The correct port, typically 3306, must also be open for remote login. For more information about remote monitoring see, [Section 15.3.3.6.4, “Configuring an Agent to Monitor a Remote MySQL Server”](#).

## 15.3.4. Unattended Installation

It is possible to install the MySQL Enterprise Monitor without any direct user interaction. This is done by passing the command-line option `--mode unattended` to the installation file.

Using this mode and other command-line parameters means the user will not be prompted for input during installation. This is especially useful when doing multiple installations of the MySQL Enterprise Monitor.

However, rather than passing numerous parameters from the command line, it is usually more convenient to save your options in a text file and invoke the installer using the `optionfile` option. This is a more reusable and less error-prone solution.

Before attempting an unattended installation, it is recommended that you install the MySQL Enterprise Monitor interactively at least once. Failing this, as a minimum, read the regular installation instructions since some tasks still remain after an unattended installation; you must configure the MySQL Enterprise settings, import the advisors, and start up all the services/daemons.

### 15.3.4.1. Command-Line Options

To view the available options for the monitor installer or for the agent installer, at the command line type the executable file name along with the `help` option.

#### 15.3.4.1.1. MySQL Enterprise Service Manager Options

The following listing shows the command line options for the MySQL Enterprise Service Manager.

```
--help                Display the list of valid options
--version             Display product information
--optionfile <optionfile> Installation option file
                        Default:
--mode <mode>        Installation mode
                        (Windows)Default: win32
                        (Unix)Default: gtk
                        (Mac OS X)Default: osx
                        (Windows)Allowed: win32 unattended
                        (Unix)Allowed: gtk text xwindow unattended
                        (Mac OS X)Allowed: osx text unattended
```

### Note

The default modes are different for different operating systems. The values allowed also differ. There is no `text` installation mode under Windows.

```
--debugtrace <debugtrace> Debug filename
                        Default:
--installer-language <installer-language> Language selection
                        Default:
                        Allowed: en jp
--installdir <installdir> Installation directory
                        (Windows)Default:C:\Program »
                        Files\MySQL\Enterprise\Monitor
                        (Unix)Default:/opt/mysql/enterprise/monitor/
                        (Mac OS X)Default:/Applications/mysql/enterprise/monitor/
--tomcatport <tomcatport> Tomcat Server Port
                        Default: 18080
--tomcatshutdownport <tomcatshutdownport> Tomcat Shutdown Port
                        Default: 18005
--tomcatsslport <tomcatsslport> Tomcat SSL Port
                        Default: 18443
--usessl <usessl>      Should communication between the Dashboard »
                        and Service Manager be encrypted?
                        Default: 0
--adminuser <adminuser> Repository Username
                        Default: service_manager
--adminpassword <adminpassword> Password
                        Default:
```

### Warning

The repository user name and password are stored in unencrypted form in the `config.properties` file. To locate this file on your operating system see [The config.properties File](#).

```
--dbport <dbport>      Bundled MySQL Database Port
                        Default: 13306
```

The monitor installation options are the same for all operating systems except as noted in the preceding listing.

#### 15.3.4.1.2. MySQL Enterprise Monitor Agent Options

To view all the options available for an unattended *agent* installation, invoke the agent installer file passing in the `help` option. (Under Windows you must redirect the output to a file as shown in [Section 15.3.4.1, “Command-Line Options”](#)). You should see a listing similar to the following:

```
--help                Display the list of valid options
--version             Display product information
                        Default:
--optionfile <optionfile> Installation option file
                        Default:
--mode <mode>        Installation mode
```



```
(Windows)Default: win32
(Unix)Default: gtk
(Mac OS X)Default: osx
(Windows)Allowed: win32 unattended
(Unix)Allowed: gtk text xwindow unattended
(Mac OS X)Allowed: osx text unattended
```

## Note

The default modes are different for different operating systems. The values allowed also differ. There is no `text` installation mode under Windows.

```
--debugtrace <debugtrace>      Debug filename
                                Default:
--installer-language <installer-language> Language selection
                                Default:
                                Allowed: en jp
--installdir <installdir>       Installation directory
                                (Windows)Default: C:\Program Files\MySQL\Enterprise\Agent
                                (Unix)Default: /opt/mysql/enterprise/agent
                                (Mac OS X)Default: /Applications/mysql/enterprise/agent
--mysqlhost <mysqlhost>        MySQL hostname or IP address
                                Default: 127.0.0.1
--checkmysqlhost <checkmysqlhost> Validation of MySQL hostname or IP address
                                Default: yes
--mysqlport <mysqlport>        MySQL port on 127.0.0.1
                                Default: 3306
--mysqluser <mysqluser>        User name on 127.0.0.1:3306
                                Default:
--mysqlpassword <mysqlpassword> Password for mysqluser on 127.0.0.1:3306
                                Default:
--managerhost <managerhost>    Hostname or IP address
                                Default: 127.0.0.1
--tomcatport <tomcatport>      Port on 127.0.0.1
                                Default: 18080
--agentuser <agentuser>        Agent username on 127.0.0.1:18080
                                Default: agent
--agentpassword <agentpassword> Agent password for agent on 127.0.0.1:18080
                                Default:
--servername <servername>     Hostname to display
                                Default:
```

Again, the agent options are the same for all operating systems except as noted.

### 15.3.4.2. Unattended Windows Installation

For unattended installation on Windows, create an option file named `options.server.txt`. The following is an example of what the contents of an option file might be.

```
debugtrace=C:\Program Files\MySQL\Enterprise\install.debugtrace.log
mode=unattended
installdir=C:\Program Files\MySQL\Enterprise
tomcatport=8080
tomcatshutdownport=8005
tomcatsslport=8443
adminpassword=myadminpassword
dbport=3300
```

This file identifies a directory and file name for a log file, sets the `mode` to `unattended`, and uses the `installdir` option to specify an installation directory. The meaning of the other options is fairly self-evident.

## Note

Set the `installdir` and `debugtrace` options to values appropriate to your locale and operating system.

The only options that must be specified in an option file when installing the MySQL Enterprise Service Manager are `mode` (if not specified at the command line), `installdir`, and `adminpassword`.

Check the options in your option file closely before installation; no warnings will be issued if there are errors.



Ensure that the monitor installer file and the options file are in the same directory and, if you saved the options file as `options.server.txt`, you can invoke an unattended installation from the command line by typing:

```
C:\mysqlmonitor-version-windows-installer.exe --optionfile options.server.txt
```

You can install the MySQL Enterprise Monitor Agent in exactly the same fashion. Create an agent option file and call the agent installer using the `optionfile` option.

As a minimum for the agent installation, you must specify the `mode` (if not specified at the command line), `mysqluser`, `installdir`, `mysqlpassword`, `installdir`, `managerhost`, and `agentpassword` options. Create a file containing these values and use it with the `optionfile` option for unattended agent installation.

If you wish, you can create one script that calls both the Service Manager and the Monitor Agent programs passing appropriate `optionfile` options.

### 15.3.4.3. Unattended Unix and Mac OS X Installation

For unattended installation on Unix, create an option file named `options.server.txt`. The following is an example of what the contents of an option file might be for installation on Unix.

```
debugtrace=/opt/mysql/enterprise/install.debugtrace.monitor.log
mode=unattended
installdir=/opt/mysql/enterprise/monitor
tomcatport=8080
tomcatshutdownport=8005
tomcatsslport=8443
adminpassword=myadminpassword
dbport=3300
```

This file identifies a directory and file name for a log file, sets the `mode` to `unattended`, and uses the `installdir` option to specify an installation directory. The meaning of the other options is fairly self-evident.

#### Note

Set the `installdir` and `debugtrace` options to values appropriate to your locale and operating system.

The only options that must be specified in an option file when installing the MySQL Enterprise Service Manager are `mode` (if not specified at the command line), `installdir`, and `adminpassword`.

Check the options in your option file closely before installation; no warnings will be issued if there are errors.

Ensure that the monitor installer file and the options file are in the same directory and, if you saved the options file as `options.server.txt`, you can invoke an unattended installation from the command line by typing:

```
shell> mysqlmonitor-version-installer.bin --optionfile options.server.txt
```

You can install the MySQL Enterprise Monitor Agent in exactly the same fashion. Create an agent option file and call the agent installer using the `optionfile` option.

As a minimum for the agent installation, you must specify the `mode` (if not specified at the command line), `mysqluser`, `installdir`, `mysqlpassword`, and `agentpassword` options. Create a file containing these values and use it with the `optionfile` option for unattended agent installation.

If you wish, you can create one script that calls both the Service Manager and the Monitor Agent programs passing appropriate `optionfile` options.

#### Note

The Service Manager does not automatically start up on rebooting. For more information, see [Bug#31676](#).

The procedure for unattended agent installation under Mac OS X is identical to the procedure under Unix.

### 15.3.4.4. Starting the Services

For instructions on starting the services needed by the MySQL Enterprise Service Manager see, [Section 15.3.2.5, “Starting/Stopping the MySQL Enterprise Monitor Service on Windows”](#) for Windows and, [Section 15.3.2.6, “Starting/Stopping the MySQL Enterprise Monitor Service on Unix and Mac OS X”](#) for Unix and Mac OS X.

For instructions on starting the MySQL Enterprise Monitor Agent see:

- Windows – [Section 15.3.3.5.1, “Starting/Stopping the Agent on Windows”](#)
- Unix – [Section 15.3.3.5.3, “Starting/Stopping the Agent on Unix”](#)
- Mac OS X – [Section 15.3.3.5.2, “Starting/Stopping the Agent on Mac OS X”](#)

If you wish, you can script the startup of these services.

## 15.3.5. Post-Installation Considerations

Depending upon how you plan to use the MySQL Enterprise Monitor, there are some tasks you may want to perform after installation. Find some suggestions in the following list:

- **Email settings** — Test email notification by deliberately triggering an alert.
- **Auto Startup** — On Unix systems, the MySQL Enterprise Service Manager does not automatically restart when the system is rebooted. You may wish to create a system initialization script appropriate to your operating system.
- **Log files** — Check the log files for any irregularities. For the locations of the various log files see [Files Associated with The MySQL Enterprise Monitor](#).
- **Agent Log file rotation** — Implement log file rotation for the service agent.
- **Back up the repository** — For a back-up strategy suitable to your circumstances, see the [MySQL reference manual documentation](#).
- **Configuration backup** — Back up the `mysql-monitor-agent.ini` file and the associated `instances` directory and contents.

For more information about the `mysql-monitor-agent.ini` file see [Section 15.3.3.6, “Advanced Agent Configuration”](#).

- **Configuration file** — Store the `configuration_report.txt` in a safe place. There is no mechanism for retrieving the password stored in this file.
- **Repository credentials** — The repository user name and password are stored in unencrypted form in the `config.properties` file. Take care to protect this file.
- **Disk management** — Remove installation files, and monitor the space used by the repository. Ensure that you have adequate disk space by regularly purging data. For more information, see [??? \[1285\]](#)
- **Firewall changes** — You may want to limit or expand access to the MySQL Enterprise Service Manager.
- **Open ports** — As with firewall changes, you may want to limit or expand access to the MySQL Enterprise Service Manager. The dashboard uses non-standard ports, none of which are usually open by default.
- **Server upgrades** — See [Section 15.3.6.3.1, “Upgrading the Monitored MySQL Server”](#) for instructions on upgrading a server.
- **Repository access** — You may want to add other users.

## 15.3.6. Upgrading, Re-Installing or Changing Your Installation

You can upgrade

- For instructions on upgrading your existing installation, see [Section 15.3.6.1, “Upgrading MySQL Enterprise Monitor”](#).
- For more information on re-installing an existing installation, see [Section 15.3.6.2, “Reinstalling MySQL Enterprise Monitor”](#).
- To change an existing installation, such as changing the monitored server, see [Section 15.3.6.3, “Changing Your MySQL Enterprise Monitor Installation”](#).

### 15.3.6.1. Upgrading MySQL Enterprise Monitor

From time to time there may be updates to the MySQL Enterprise Service Manager or the MySQL Enterprise Monitor Agent. This section describes how to perform an update for either of these components.

You cannot use the update installers to change to a different operating system or chip architecture. For example, you cannot update a 32-bit Linux installation to a 64-bit version using an update installer — in cases such as this you must do a fresh installation.

The name of the update file varies but it shows the target operating system and the version the update applies to. If a specific component is being updated it may also appear in the file name. For example, a file named `mysqlenterprise-2.0.0-windows-update-installer.exe` would indicate a Windows update to MySQL Enterprise Service Manager version 2.0.0.

You may install an update in the same way that you initially installed the service manager or the agent; in `win32` or `unattended` mode on Windows in `gtk`, `text`, `xwindow`, or `unattended` mode on Unix and in `osx`, `text`, or `unattended` mode on OS X.

### Warning

Before updating the MySQL Enterprise Service Manager stop all agents that are reporting to that MySQL Enterprise Service Manager. If you are updating the MySQL Enterprise Monitor Agent you must also stop the MySQL Enterprise Service Manager. On a machine that runs more than one agent, the primary agent will restart when the update is complete. Any secondary agents must be restarted manually. To stop or start agents see:

- Windows – [Section 15.3.3.5.1, “Starting/Stopping the Agent on Windows”](#)
- Unix – [Section 15.3.3.5.3, “Starting/Stopping the Agent on Unix”](#)
- Mac OS X – [Section 15.3.3.5.2, “Starting/Stopping the Agent on Mac OS X”](#)

### Important

The upgrade installer will overwrite `items-mysql-monitor.xml`. On Windows this file is found in the `C:\Program Files\MySQL\Enterprise\Agent\share\mysql-monitor-agent` directory and on Unix in the `/opt/mysql/enterprise/agent/share/mysql-monitor-agent` directory. You should back this file up if you have made any changes to it.

### Warning

If you use the Upgrade installer to update MySQL Enterprise Service Manager and you have made any changes to the `my.cnf` within your MySQL Enterprise Service Manager installation, any changes will be lost. You should copy the existing `my.cnf` file before starting the upgrade installer.

Otherwise, updating is a fairly straightforward process. Run the installation file and choose the directory of your current installation and whether or not you wish to back up your current installation. The time required to complete the process varies depending upon the nature of the update.

If you chose to back up your current installation, a directory named `backup` will be created in the current installation directory. This directory will contain copies of the directory or directories that were replaced during the update. In cases where only specific files are replaced, the `backup` directory may contain only these files. If you are unhappy with the update simply overwrite the new files or directories with the originals found in the `backup` directory. Be sure to stop both the MySQL Enterprise Service Manager and MySQL Enterprise Monitor Agent before restoring the original files. You can delete or archive this directory when you are satisfied that the update was successful.

If you choose to back up your current installation, the installer checks that there is adequate disk space for your repository backup. If there is not enough space, you are given the option of choosing another location; you may also choose not to back up the repository.

To update your Advisors see, [Section 15.3.2.7.4, “Upgrading and Updating Advisors”](#).

## 15.3.6.1.1. Upgrading from MySQL Enterprise Monitor 1.3 to 2.0

To upgrade your existing installation from MySQL Enterprise Monitor 1.3 to MySQL Enterprise Monitor 2.0, you need to upgrade both your MySQL Enterprise Service Manager and your MySQL Enterprise Monitor Agent on each machine that you are monitoring.

To perform the update process you must use an `update` installer. This ensures that your current configuration information is migrated to the new version of MySQL Enterprise Service Manager.

Before you start the migration, shutdown your MySQL Enterprise Service Manager and MySQL Enterprise Monitor Agent on each monitored host. Then install the updated MySQL Enterprise Service Manager application to migrate the configuration and data of the main application and repository. Once the new MySQL Enterprise Service Manager is running, you can start to update and migrate each agent.

For more information on upgrading your MySQL Enterprise Service Manager, see [Section 15.3.6.1.1.1, “Upgrading to MySQL Enterprise Service Manager 2.0”](#). For more information on upgrading an MySQL Enterprise Monitor Agent, see [Section 15.3.6.1.1.2, “Upgrading to MySQL Enterprise Monitor Agent 2.0”](#).

### 15.3.6.1.1.1. Upgrading to MySQL Enterprise Service Manager 2.0

Upgrading MySQL Enterprise Service Manager requires you to use one of the *update* installers. The update installer performs a number of operations during installation:

- A new database, required to support 2.0 functionality, is created.
- Your core dashboard, user, and rule information is migrated from the old database to the new database.
- The core configuration parameters for the MySQL Enterprise Service Manager are migrated from MySQL Enterprise Monitor 1.3 are migrated to MySQL Enterprise Monitor 2.0.

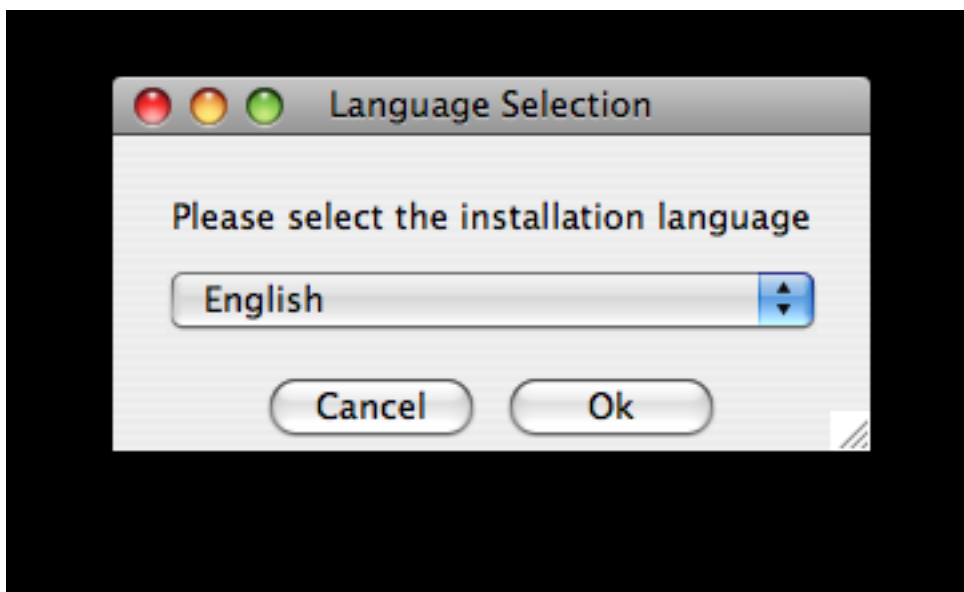
The installation of the new software using the update installer follows this basic sequence:

1. Request the installation language.
2. Confirm the location of the current MySQL Enterprise Service Manager installation.
3. Specify whether you want to keep a copy of the old server, application, and database files.
4. Configure the Tomcat server settings, including whether the new server should support SSL connections from agents.
5. If requested, the application and database information is backed up and upgraded, before the new application is installed.

The installation process is consistent for all platforms. A sample of the process for Max OS X has been provided below:

1. Double click on the update installer. The update installer will have `update` in the file name. For example, `mysqlmonit-or-2.0.0.7101-osx-update-installer.app`.
2. Confirm the language you want to use when installing the software.

**Figure 15.24. MySQL Enterprise Monitor: Server Update: Language Selection**

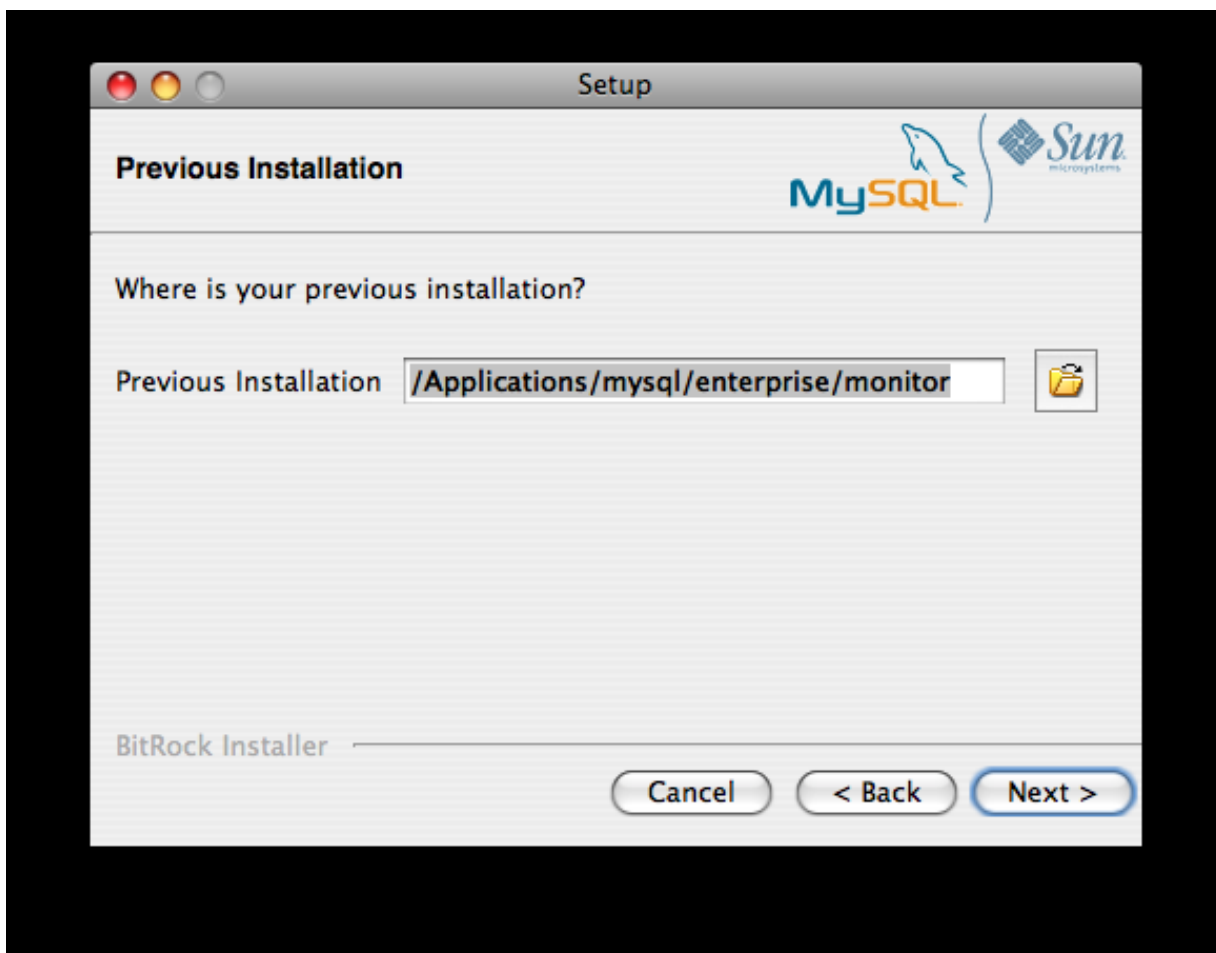


Click OK

3. You will be presented with an information screen showing the application you are installing. Click NEXT to continue.

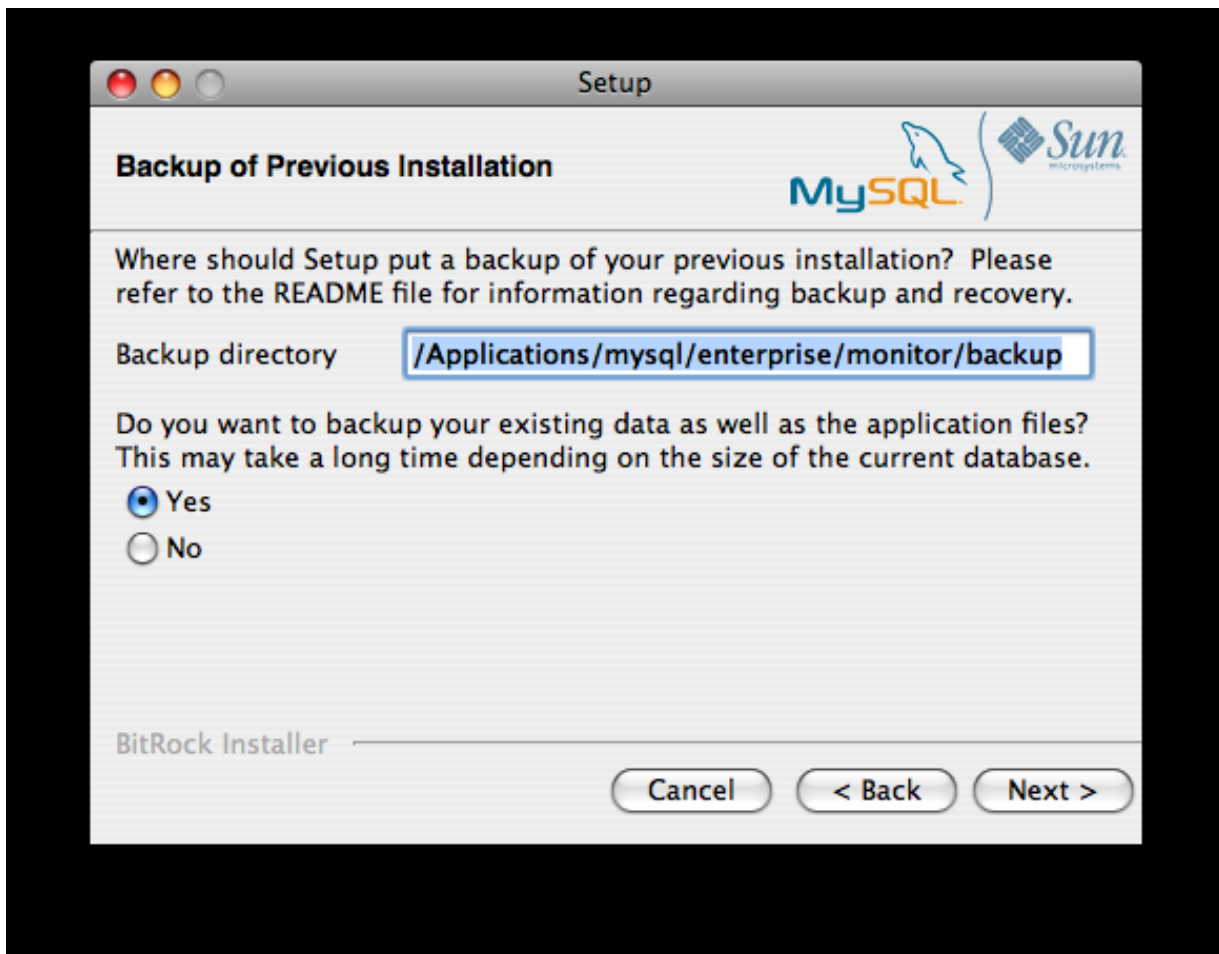
- Specify, or locate, the previous installation of MySQL Enterprise Service Manager. If you installed the server within the default location, the current version of the application should be located automatically.

**Figure 15.25. MySQL Enterprise Monitor: Server Update: Previous Installation**



- The installer can keep a backup copy of your existing application, including keeping a complete backup of the data stored within your MySQL Enterprise Monitor repository database.

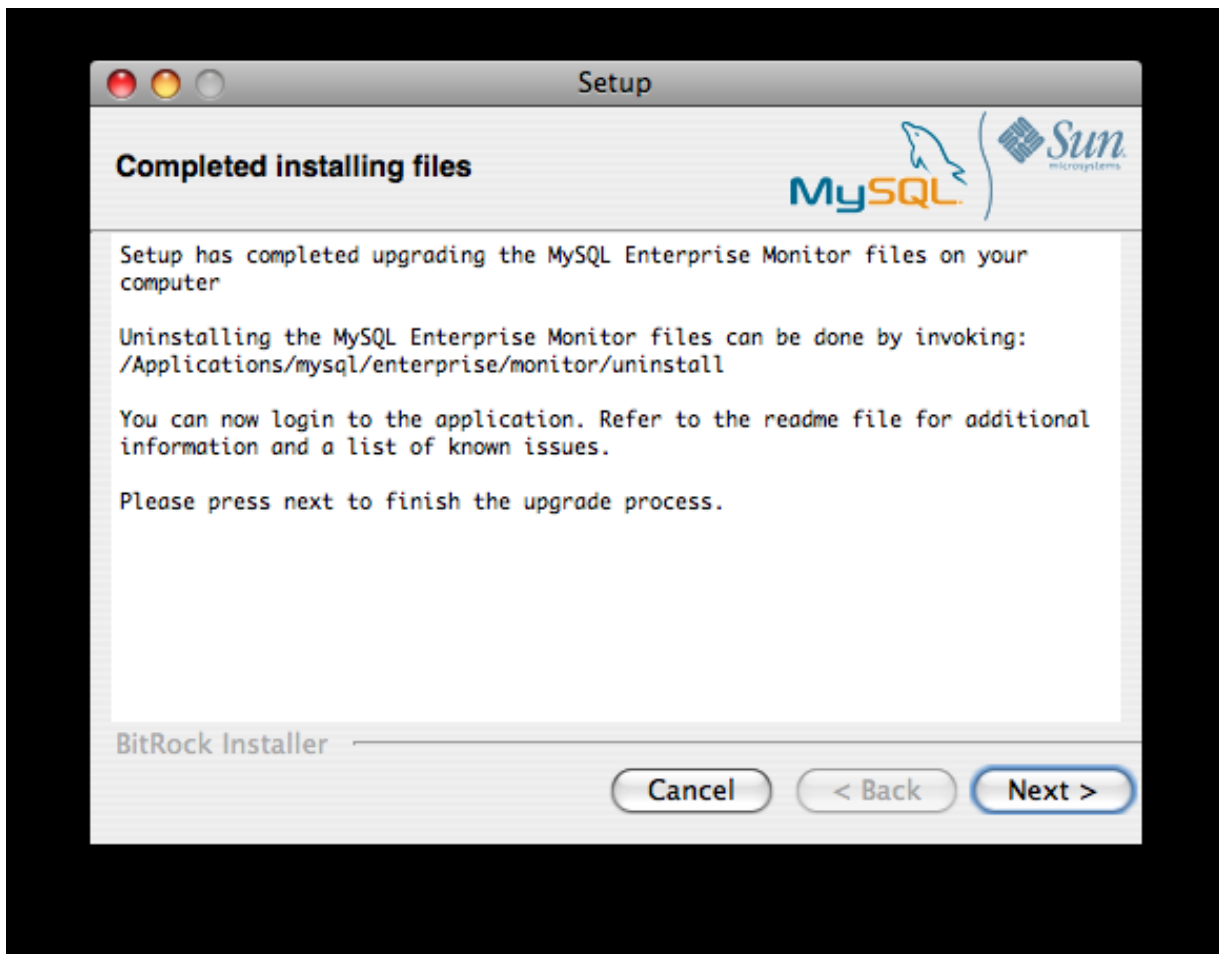
**Figure 15.26. MySQL Enterprise Monitor: Server Update: Backup of Previous Installation**



Specify the location of the backup (default is to use the `backup` directory within your installation directory). Note that backing up the database in addition to the main application will increase the installation time as the files have to be copied. The larger the size of your repository data, the longer the installation process will take.

6. Specify the Tomcat Server options. The Tomcat Server Port is the default port you will use to access the MySQL Enterprise Dashboard. If you want to support agents using SSL to communicate to MySQL Enterprise Service Manager, you must check the **IS SSL SUPPORT REQUIRED?**
7. Confirm that you want to continue the installation. Once installation has started, the backup of you existing application (and database) will start, although the process may take some time. Wait until the process completes.
8. Once the process has completed you will be provided with a notification of the installation process, including how to uninstall the application if you want to do so in the future. If any errors occurred, they will be reported here.

**Figure 15.27. MySQL Enterprise Monitor: Server Update: Completed installing files**



9. The installation has now completed. You can automatically start the MySQL Enterprise Service Manager and view the attached Readme file by ensuring the checkboxes on this page are selected.
10. You can now quit the installer.

Once the installation has completed, the first time you login to MySQL Enterprise Dashboard you will be asked to provide your login credentials, if they do not already exist in the server configuration, or to provide a copy of the Advisor jar suitable for your MySQL Enterprise Service Manager version.

**Figure 15.28. MySQL Enterprise Monitor: Server Update: Final Setup**

MySQL Enterprise Monitor has now been updated. You must update each of your agents to MySQL Enterprise Monitor Agent 2.0 to ensure that they are providing the correct information to MySQL Enterprise Service Manager

### 15.3.6.1.1.2. Upgrading to MySQL Enterprise Monitor Agent 2.0

To upgrade an agent you should use a [update](#) installer. This will migrate your configuration information, simplifying the upgrade process significantly.

#### Note

The agent log file, `mysql-service-agent.log`, if it exists, will be retained during the upgrade. A new log file, `mysql-monitor-agent.log` is used by MySQL Enterprise Monitor Agent 2.0.

The core sequence is the same on all platforms, the update process on Linux is shown below:

1. Start the update installer.

```
shell> ./mysqlmonitoragent-2.0.0.7101-linux-glibc2.3-x86-32bit-update-installer.bin
```

2. Set the language for the installation process.

```
Language Selection
Please select the installation language
[1] English
[2] Japanese
Please choose an option [1] :
```

3. Confirm or update the location of the installation directory of the previous version.

```
-----
Welcome to the setup wizard for the MySQL Enterprise Monitor Agent Update
-----
Please specify the directory that contains the previous installation of
the MySQL Enterprise Monitor Agent
Installation directory [/opt/mysql/enterprise/agent]:
```



- Specify whether you want to create a backup of the current application and configuration information, and if so, where the backup directory should be created.

```
-----
Current installation backup
Do you want to create a backup during the update process?
Backup the current installation [Y/n]: Y

Backup directory [/opt/mysql/enterprise/agent/patchbackup]:
```

- You will be asked whether you want to enable the Query Analyzer. The Query Analyzer enables you to monitor the execution statistics for individual queries executed through your MySQL servers. To enable, you must specify the proxy port, MySQL server and MySQL server port that you want to use. If you do not enable Query Analyzer now, you can enable it later. See [Section 15.10, “The Query Analyzer Page”](#).

```
-----
Query Analysis Configuration

MySQL Proxy enables query monitoring and analysis by listening on the port
specified below for client connections that are then passed through to a
backend MySQL database server. It is not needed for basic monitoring
functionality, but is required for query monitoring and analysis.

Visit the following URL for more information:
https://enterprise.mysql.com/docs/monitor/2.0/en/mem-query-analysis.html

Enable Proxy (recommended) [Y/n]:

Proxy Port [4040]:
Backend Host: 127.0.0.1 (cannot be changed)
Backend Port: 3306 (cannot be changed)
```

- You are now ready to complete the installation. Confirm that you want to continue.

```
-----
Setup is now ready to begin installing MySQL Enterprise Monitor Agent Update on your computer.
Do you want to continue? [Y/n]:

-----
Please wait while Setup installs MySQL Enterprise Monitor Agent Update on your computer.

Installing
0% _____ 50% _____ 100%
#####

-----
Setup has finished installing MySQL Enterprise Monitor Agent Update on your computer.
Restart MySQL Enterprise Monitor Agent now [Y/n]:
View Readme File [Y/n]: n
```

Before connecting your MySQL Enterprise Monitor Agent to your MySQL server you must update the grants for the MySQL Enterprise Monitor Agent. Connect to the MySQL server and run this statement to update the required grants:

```
GRANT CREATE, INSERT
ON mysql.*
TO 'mysqluser'@'localhost'
IDENTIFIED BY 'agent_password';
```

Replacing the `mysqluser` and `agent_password` parameters with the values used for connecting your agent to your MySQL server.

Once the update agent has communicated with the MySQL Enterprise Service Manager the core information about the agent and the MySQL server it is monitoring will be migrated to the new data format required by MySQL Enterprise Service Manager 2.0. To migrate the existing stored data, see [Section 15.4.2, “Migrating 1.3.x Historical Data to MySQL Enterprise Monitor 2.0”](#).

### 15.3.6.1.2. Unattended MySQL Enterprise Monitor Update

The options available when performing an unattended MySQL Enterprise Service Manager update are as follows:

```
--help                Display the list of valid options
--version             Display product information
--optionfile <optionfile>  Installation option file
                        Default:
--mode <mode>         Installation mode
                        (Windows)Default: win32
                        (Unix)Default: gtk
                        (Mac OS X)Default: osx
                        (Windows)Allowed: win32 unattended
                        (Unix)Allowed: gtk text xwindow unattended
                        (Mac OS X)Allowed: osx text unattended
--debugtrace <debugtrace>  Debug filename
                        Default:
--installer-language <installer-language> Language selection
                        Default:
                        Allowed: en jp
--installdir <installdir>  Previous Installation
                        Default:
--createDataBackup <createDataBackup>
                        Default: 1
--backupDir <backupDir>   Backup directory
                        Default:
```

The options for an unattended update of the agent differ only in that the `createDataBackup` option is replaced by `createBackup`.

If you did not install the MySQL Enterprise Service Manager to the default directory the `installdir` option must be specified. `mode` must also be specified when performing an unattended update. Otherwise, performing an unattended update is identical to the process described in [Section 15.3.4, “Unattended Installation”](#).

### 15.3.6.2. Reinstalling MySQL Enterprise Monitor

In some cases you may want to reinstall MySQL Enterprise Monitor rather than updating your current installation. To reinstall rather than update MySQL Enterprise Monitor follow these steps:

1. Stop all the Monitor Agents
2. Run the `uninstall` programs for both the MySQL Enterprise Service Manager and the MySQL Enterprise Monitor Agent
3. Begin the new installation

To stop the Monitor Agents see:

- Windows – [Section 15.3.3.5.1, “Starting/Stopping the Agent on Windows”](#)
- Unix – [Section 15.3.3.5.3, “Starting/Stopping the Agent on Unix”](#)
- Mac OS X – [Section 15.3.3.5.2, “Starting/Stopping the Agent on Mac OS X”](#)

Instructions for removing the MySQL Enterprise Service Manager and the MySQL Enterprise Monitor Agent are given in [Section 15.3.7, “Uninstalling the MySQL Enterprise Monitor”](#).

### 15.3.6.3. Changing Your MySQL Enterprise Monitor Installation

This section describes the best practices to employ when changing your MySQL Enterprise Monitor installation.

#### 15.3.6.3.1. Upgrading the Monitored MySQL Server

When upgrading a monitored MySQL server first stop the agent. To stop the agent see:

- Windows – [Section 15.3.3.5.1, “Starting/Stopping the Agent on Windows”](#)

- Unix – [Section 15.3.3.5.3, “Starting/Stopping the Agent on Unix”](#)
- Mac OS X – [Section 15.3.3.5.2, “Starting/Stopping the Agent on Mac OS X”](#)

Stop the MySQL server and perform the upgrade. For instructions on stopping and restarting the MySQL service under Windows see [Section 15.3.2.5, “Starting/Stopping the MySQL Enterprise Monitor Service on Windows”](#).

To stop and restart the MySQL daemon under Unix and Mac OS X, see, [Section 15.3.2.6, “Starting/Stopping the MySQL Enterprise Monitor Service on Unix and Mac OS X”](#).

Once the service/daemon is stopped you may upgrade your server. For instructions on upgrading your MySQL server see the reference manual pertaining to your server version. When the upgrade is complete restart the MySQL server.

#### Note

The agent's log file will show that the server was down.

### 15.3.6.3.2. Changing the Server That an Agent Monitors

You need not reinstall the MySQL Enterprise Monitor Agent in order to change the MySQL server that it monitors. It is possible to adapt an existing agent so that it monitors a different server.

To do this you must stop the service agent and then remove the server that it is monitoring. To stop the agent see:

- Windows – [Section 15.3.3.5.1, “Starting/Stopping the Agent on Windows”](#)
- Unix – [Section 15.3.3.5.3, “Starting/Stopping the Agent on Unix”](#)
- Mac OS X – [Section 15.3.3.5.2, “Starting/Stopping the Agent on Mac OS X”](#)

For instructions on removing a server see, [Section 15.6.3.3, “Removing a Server From the Dashboard”](#).

Once the agent is stopped and the server is removed from the Dashboard, changes may be made to the `mysql-monitor-agent.ini`, or the `agent-instance.ini` file within the agent `instances` directory. You can find the location of the directory by examining the content of the `mysql-monitor-agent.ini` and checking the value of the `mysqld-instance-dir` parameter.

If you want to make changes to the monitored MySQL server, edit the `agent-instance.ini` file. Change the `user`, `password`, `hostname`, and `port` values if required. For more information, see [Section 15.3.3.6.2, “MySQL Server \(agent-instance.ini\) Configuration”](#).

To change other settings, such as enabling proxy support (required for Query Analyzer), the management host, or the port number used by the agent, modify the `mysql-monitor-agent.ini` file. For more information, see [Section 15.3.3.6.1, “MySQL Enterprise Monitor Agent \(mysql-monitor-agent.ini\) Configuration”](#).

To restart the agent see:

- Windows – [Section 15.3.3.5.1, “Starting/Stopping the Agent on Windows”](#)
- Unix – [Section 15.3.3.5.3, “Starting/Stopping the Agent on Unix”](#)
- Mac OS X – [Section 15.3.3.5.2, “Starting/Stopping the Agent on Mac OS X”](#)

#### Note

If you are adapting an existing agent to monitor a remote server make sure that the agent has the credentials for remote access and that the port on the remote MySQL server instance is open. For more information, see [Section 15.3.3.6.4, “Configuring an Agent to Monitor a Remote MySQL Server”](#).

If you experience difficulties starting the agent, check [Section 15.3.3.7, “Troubleshooting the Agent”](#).

Log in to the Dashboard and you should find your new server in the `All Servers` group.

### 15.3.6.3.3. Temporarily Suspending the Agent

In some situations you may need to bring down a monitored server. When this is necessary, it is good practice to stop the agent first—doing so will avoid generating a “Server is unreachable” event.

For instance, suppose you need to stop the server in order to do a backup. The steps to follow are:

1. Stop the agent
2. Stop the service/daemon
3. Perform the backup
4. Restart the service/daemon
5. Restart the agent

To stop or start the agent see:

- Windows – see [Section 15.3.3.5.1, “Starting/Stopping the Agent on Windows”](#)
- Unix – see [Section 15.3.3.5.3, “Starting/Stopping the Agent on Unix”](#)
- Mac OS X – see [Section 15.3.3.5.2, “Starting/Stopping the Agent on Mac OS X”](#)

To stop the MySQL service/daemon see the MySQL reference manual for your server version. You can find the manual online at <http://dev.mysql.com/doc/refman>.

Follow these steps and there will be no “noise” associated with backing up your server. In contrast, if you leave the agent running while bringing down the server, you will generate a “Server is unreachable” event.

As an alternative to stopping the agent, you can change the logic associated with a rule. For instance, you could alter the threshold of the rule “Server is unreachable”:

```
%server.reachable% == THRESHOLD
```

to:

```
%server.reachable% == THRESHOLD && CURTIME() NOT BETWEEN '22:00:00' AND '23:00:00'
```

This would effectively blackout the rule between 10 and 11 pm, during which time you could perform a backup.

For more information about editing rules see [Section 15.7.3, “Editing Built-in Rules”](#). To blackout all events associated with a specific server or group of servers see [Section 15.7.6, “Advisor Blackout Periods”](#).

## 15.3.7. Uninstalling the MySQL Enterprise Monitor

Removal of the MySQL Enterprise Monitor requires removal of the MySQL Enterprise Service Manager and the MySQL Enterprise Monitor Agent Service. In some circumstances, when running multiple agents on one machine for instance, you may not want to remove the entire MySQL Enterprise Monitor Agent Service but only a single monitored server.

### 15.3.7.1. Removing the MySQL Enterprise Monitor: Windows

#### 15.3.7.1.1. Removing the MySQL Enterprise Service Manager

Remove the MySQL Enterprise Service Manager by going to the [Control Panel](#) and choosing [Add or Remove Programs](#). Find the entry for [MySQL Enterprise Monitoring and Advisory Service](#) and remove it. During the uninstall process you will be given the option of saving existing data and log files. Choose this option if you plan to reinstall the MySQL Enterprise Monitor.

If you are not saving existing data, after MySQL Enterprise Service Manager has been removed you may delete the [C:\Program Files\MySQL\Enterprise\Monitor](#) directory.

#### Warning

If you chose not to remove existing data and log files when uninstalling MySQL Enterprise Service Manager do **not** remove the [C:\Program Files\MySQL\Enterprise\Monitor](#) directory. Doing so will delete these files.

If you added the Tomcat/Apache web server to the list of Windows firewall exceptions, remove this service by opening the [Windows Firewall](#) from the [Control Panel](#). Choose the [Exceptions](#) tab and delete the [Tomcat/Apache](#) entry.

#### 15.3.7.1.1.1. Removing MySQL Enterprise Monitor Services Only

When the MySQL Enterprise Service Manager is installed, the Tomcat/Apache and MySQL server services are started. It is possible to remove these services without also removing your MySQL Enterprise Service Manager installation. (For more information about these services see, [Section 15.3.2.5, “Starting/Stopping the MySQL Enterprise Monitor Service on Windows”](#) or, [Section 15.3.2.6, “Starting/Stopping the MySQL Enterprise Monitor Service on Unix and Mac OS X”](#).)

Do this by finding the [MySQL Enterprise Monitor](#) menu option and choosing [Services](#) and then [Uninstall MySQL Enterprise Monitor Services](#). This will remove all the services associated with MySQL Enterprise Service Manager.

You can confirm that these services have been removed by checking services in the Microsoft Management Console Services window.

If you wish to reinstall these services you can do this by using the [Install MySQL Enterprise Monitor Services](#) menu option.

It is also possible to remove services using the `mysqlmonitorctl.bat` file found in the `C:\Program Files\MySQL\Enterprise\Monitor` directory. To see the available options, go to the command line and type: `mysqlnet-workctrl help`. This batch file is discussed in more detail in [Section 15.3.2.5, “Starting/Stopping the MySQL Enterprise Monitor Service on Windows”](#).

#### 15.3.7.1.2. Removing the Monitor Agent

To remove the Monitor Agent itself, open the [Control Panel](#) and choose [Add or Remove Programs](#). Find the entry for [MySQL Enterprise Monitor Agent](#) and remove it. This will execute the uninstall program located in the `C:\Program Files\MySQL\Enterprise\Agent` directory.

##### Warning

If you are running more than one agent on the same machine and wish to remove only one of the agents, do **not** remove the [MySQL Enterprise Monitor Agent](#) entry from the [Add or Remove Programs](#) menu. To remove a single agent see [Section 15.3.7.1.2.1, “Removing a Single Agent”](#).

After removing the Monitor Agent you may also need to remove the directories, `C:\Program Files\MySQL\Enterprise` and `C:\Program Files\MySQL\Enterprise\Agent`.

Removing the Monitor Agent in this fashion will remove the default service. However, if you are running additional Monitor Agents as described in [Section 15.3.3.6.2, “MySQL Server \(agent-instance.ini\) Configuration”](#), you will have to remove those agents manually. See the next section for instructions on doing this.

##### 15.3.7.1.2.1. Removing a Single Agent

If you are running more than one agent on the same machine and wish to remove only one of the agents, do **not** remove the [MySQL Enterprise Monitor Agent](#) entry from the [Add or Remove Programs](#) menu. To remove a single agent and leave other agents intact follow these steps:

1. Stop the agent
2. Confirm the location of the log files
3. Remove the agent as a service
4. Remove/Archive the associated files

It is best to stop the agent before removing it; for instructions on stopping an agent see, [Section 15.3.3.5.1, “Starting/Stopping the Agent on Windows”](#).

You can confirm the location of the agent log files by checking the `ini` file. For more information on this topic see [Section 15.3.3.6.1, “MySQL Enterprise Monitor Agent \(mysql-monitor-agent.ini\) Configuration”](#).

Go to the command line and remove the MySQL Enterprise Monitor Agent as a Windows service by typing:

```
shell> sc delete AgentName
```

You can confirm that the agent has been removed by checking the Microsoft Management Console Services window. There should

no longer be an entry for the removed agent.

You should also remove or archive any log or configuration files associated with this agent. If you have installed any additional agents, remove them in the same fashion.

## 15.3.7.2. Removing the MySQL Enterprise Monitor: Unix and Mac OS X

### 15.3.7.2.1. Removing the MySQL Enterprise Service Manager

To remove the MySQL Enterprise Service Manager, find the `uninstall` file in the `/opt/mysql/enterprise/monitor` directory.

Execute this file by typing:

```
shell> ./uninstall
```

During the uninstall process you will be given the option of saving existing data and log files. Choose this option if you plan to re-install the MySQL Enterprise Monitor.

If you are not saving existing data, after uninstalling the MySQL Enterprise Service Manager you may remove the `/opt/mysql/enterprise/monitor` directory.

#### **Warning**

If you chose not to remove existing data and log files when uninstalling the MySQL Enterprise Monitor do **not** remove the `/opt/mysql/enterprise/monitor` directory; doing so will delete these files.

On Red Hat Enterprise Linux 4 and Fedora Core 4, the uninstall script may not stop the Tomcat server. Do this manually if necessary. To do this see, [Section 15.3.2.6, “Starting/Stopping the MySQL Enterprise Monitor Service on Unix and Mac OS X”](#).

There may be other Java processes running on your system. Be careful not to accidentally stop them.

### 15.3.7.2.2. Removing the Monitor Agent

Prior to removal of the Monitor Agent Service you should stop any agents. Do this by changing to the `init.d` directory and issuing the command, `./mysql-monitor-agent stop`.

You will find the `uninstall` file in the `/opt/mysql/enterprise/agent` directory under Unix and in the `/Applications/mysql/enterprise/agent` directory on Mac OS X. Execute this file by navigating to this directory and typing:

```
shell> ./uninstall
```

After uninstalling the Monitor Agent you may remove the `/opt/mysql/enterprise/agent` directory. Under Mac OS X this directory is called `/Applications/mysql/enterprise/agent`.

Removing the Monitor Agent in this fashion will remove the default service, and all the configuration files for different instances.

#### 15.3.7.2.2.1. Removing a Single Agent

If you are running more than one agent on the same machine and wish to remove only one of the agents, do **not** run the uninstall program. To remove a single agent and leave other agents intact follow these steps:

1. Stop the agent
2. Confirm the location of the log files
3. Remove the agent as a service
4. Remove/Archive associated files

It is best to stop the agent before removing it; for instructions on stopping an agent see:

- Unix – [Section 15.3.3.5.3, “Starting/Stopping the Agent on Unix”](#)
- Mac OS X – [Section 15.3.3.5.2, “Starting/Stopping the Agent on Mac OS X”](#)

You can confirm the location of the agent log files by checking the `ini` file. For more information on this topic see [Section 15.3.3.6.1, “MySQL Enterprise Monitor Agent \(`mysql-monitor-agent.ini`\) Configuration”](#).

You may then remove the agent as a daemon by removing its entry in the `init.d` directory. You should also remove or archive any log or configuration files associated with this agent.

If you have installed any additional agents, remove them in the same fashion.

## 15.4. Deploying MySQL Enterprise Service Manager

### Note

MySQL Enterprise subscription, MySQL Enterprise Monitor, MySQL Replication Monitor, and MySQL Query Analyzer are only available to commercial customers. To learn more, see: <http://www.mysql.com/products/enterprise/features.html>.

This chapter provides some notes and guidance on deploying MySQL Enterprise Service Manager, including hardware and server requirements for the MySQL Enterprise Service Manager, and how to backup the monitoring data.

### 15.4.1. Backing up MySQL Enterprise Service Manager

If you want to backup the data stored within your MySQL Enterprise Service Manager, you can use any of the typical backup solutions, such as `mysqldump`, to save your data. All you need to backup the information is host name, user name and password details that were set during the installation of the MySQL Enterprise Service Manager

You can locate this information by examining the contents of the `configuration_report.txt` file that was generated when MySQL Enterprise Service Manager was installed. A sample of the file is provided below:

```
MySQL Enterprise Monitor (Version 2.0.0.7088 : 20081031_152749_r7088)
Here are the settings you specified:
Application hostname and port: http://127.0.0.1:18080
Tomcat Ports: 18080 - 18443 (SSL)
MySQL Port : 13306
Repository Credentials (bundled MySQL):
-----
service_manager/Password
Use the following command to login to the MySQL Enterprise Monitor database:
mysql -uservice_manager -pPassword -P13306 -h127.0.0.1
```

The last line provides the information about how to connect to the server using the standard `mysql` command line client.

All the MySQL Enterprise Monitor repository information, including your configuration, rule and historical data is stored within the `mem` database.

To backup this information using `mysqldump` you might use the following command:

```
shell> mysqldump --single-transaction >
-uservice_manager -pPassword -P13306 -h127.0.0.1 mem >mem.dump
```

The above command would create a file, `mem.dump`, containing all of the MySQL Enterprise Monitor data.

To ensure consistency in a recovery situation, you may also want to backup the agent configuration and metadata stored on each monitored MySQL server. To do this:

- Backup the configuration files of each agent. You should keep a copy of the `etc` directory for each agent. This directory contains the main configuration file, `mysql-monitor-agent.ini`, and the configuration information for each server being monitored, which is stored within the `etc/instances` directory.
- On each server being monitored, retain a copy of the `mysql.inventory` table, which contains the unique ID of the MySQL server.

### 15.4.2. Migrating 1.3.x Historical Data to MySQL Enterprise Monitor 2.0

You can migrate the data generated during a MySQL Enterprise Monitor 1.3.x installation using the Data Migration functionality of the **SERVER CONFIGURATION** panel.

To use the data migration feature, you must have installed MySQL Enterprise Service Manager using an *update* installer. The update installer performs the initial migration of your configuration, rules, schedule, and events data. The historical data is not migrated until you explicitly request the migration of information within the **MANAGE SERVERS** section of the **SETTINGS** panel.

Data migration works on a single server, allowing you to select on which servers you want to migrate information. The migration is subject to the following:

- You must elect to migrate the data from each server individually.
- Migration takes approximately 5-6 hours, for each month, for each server. Therefore, if you have six months of data on 10 servers it could take between 300 and 360 hours (15 days) to migrate all of your historical data one server at a time.
- To limit the data migration, set the **DATA PURGE BEHAVIOR** within the **SETTINGS** page. Only data more recent than the specified purge period will be migrated. Data older than the purge period will be ignored.
- To prevent performance issues, migrate only one or a small number of servers concurrently.
- You can start and stop the migration of the data at any time. As a general guide, you should avoid stopping the data migration process and allow it to complete unless:
  - Run out of disk space.
  - MySQL Enterprise Service Manager becomes too slow and unresponsive.
  - Migration never completes.

With the last item, where the migration never completes, occasionally there are some aspects of the data that cannot be migrated successfully. This will prevent the migration process completing, but does not affect the conversion of any data that could be migrated.

### Starting Historical Data Migration

To start data migration:

- Switch to the **MANAGE SERVERS** display of the **SETTINGS** panel within MySQL Enterprise Dashboard.
- Ensure that the data migration functionality has been enabled. The **START** and **STOP** buttons next to **HISTORICAL DATA MIGRATION** will be visible.

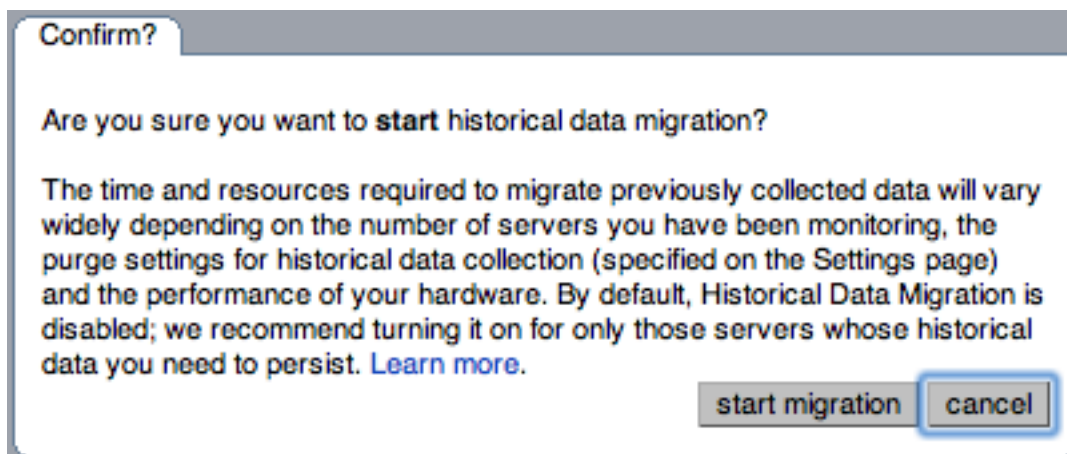
**Figure 15.29. MySQL Enterprise Monitor: Historical Data Migration Availability**

Server	Query Analyzer Enabled	Query Analyzer Examples	Query Analyzer Explains	MySQL	Up Since	Last MySQL	Agent	Last Agent	Migration Status
<input type="checkbox"/> All Servers (3)									
<input type="checkbox"/> bear:3306 (ungrouped)	On	Off	Off	5.0.60-log	Sep 13, 2008 6:37:12 PM	Nov 19, 2008 1:36:00 PM	2.0.0.7085	Nov 19, 2008 1:36:19 PM	N/A
<input type="checkbox"/> gentoo1.vmbear:3306 (ungrouped)	On	Off	Off	5.0.60-log	Nov 17, 2008 10:26:45 AM	Nov 19, 2008 2:12:00 PM	2.0.0.7101	Nov 19, 2008 1:36:19 PM	Not Migrated
<input type="checkbox"/> gentoo2.vmbear:6906 (ungrouped)	On	Off	Off	5.0.60-log	Stopped		2.0.0.7101	Nov 19, 2008 1:36:17 PM	Not Migrated

- Select the servers you want to migrate by using the checkbox next to each server name. You can select one or more servers to migrate. Servers that are suitable for migration will show their migration status within the **MIGRATION STATUS** column. If the server is not able to be migrated, **N/A** will be shown.
- Click **START** next to **HISTORICAL DATA MIGRATION**.
- You will be presented with a confirmation dialog box. To start the migration, click **START MIGRATION**. To cancel migration, click **CANCEL**.
- The servers that have been selected for migration will show **Queued for Migration** in the **MIGRATION STATUS** column.

**Figure 15.30. MySQL Enterprise Monitor: Confirming Historical Data Migration**





### Monitoring Historical Data Migration

You can check the migration status of any individual server by examining the **MIGRATION STATUS** column for each server. You can see an example of the migration status below.

**Figure 15.31. MySQL Enterprise Monitor: Historical Data Migration Progress**

Manage Groups & Servers									
Server	Query Analyzer			MySQL	Up Since	Last MySQL	Agent	Last Agent	Migration Status
	Enabled	Examples	Explains						
<input type="checkbox"/> All Servers (3)									
<input type="checkbox"/> bear:3306 (ungrouped)	On	Off	Off	5.0.60-log	Sep 13, 2008 6:37:12 PM	Nov 19, 2008 1:51:00 PM	2.0.0.7085	Nov 19, 2008 1:51:55 PM	N/A
<input type="checkbox"/> gentoo1.vmbear:3306 (ungrouped)	On	Off	Off	5.0.60-log	Nov 17, 2008 10:26:45 AM	Nov 19, 2008 2:27:00 PM	2.0.0.7101	Nov 19, 2008 1:51:55 PM	Migrating : 41 variables (50%) Start: Nov 19, 2008 1:51:28 PM
<input type="checkbox"/> gentoo2.vmbear:3306 (ungrouped)	On	Off	Off	5.0.60-log	Stopped		2.0.0.7101	Nov 19, 2008 1:51:54 PM	Migrating : 8 variables (9%) Start: Nov 19, 2008 1:51:27 PM

Note that the migration status is shown according to the state of migration at the time the page was loaded. The actual migration continues in the background, and the current state may not match the state of the migration at the time it is viewed.

Servers showing **Done** in the **MIGRATION STATUS** column have already completed their migration.

You can check the overall migration status by examining the **UPGRADE STATUS** display.

### Stopping Historical Data Migration

You can stop the migration process for any server that is still migrating data. The migration can be restarted at any time without causing any problems.

To stop the historical data migration:

1. Select the servers you want to stop migrating by using the checkbox next to each server name. You can select one or more servers to stop migrating.
2. Click **STOP** next to **HISTORICAL DATA MIGRATION**.

Confirmation that the migration has been stopped will be provided. If migration has already completed, you will be notified.

### Removing Old Data

Once data migration has been completed for all the servers you want to migrate, you may want to delete or remove access to the old data within your MySQL Enterprise Monitor repository. Data for MySQL Enterprise Monitor 1.3 was stored in a database called **merlin** within the MySQL repository. Data for MySQL Enterprise Monitor 2.0 is stored within a database called **mem**.

To create a backup of the old information, use `mysqldump`:

```
shell> mysqldump -uservice_manager -pPassword -P13306 -h127.0.0.1 merlin >data-1.3.sql
```

The above will create a file, `data-1.3.sql` containing all of the MySQL Enterprise Monitor 1.3 information.

If you remove access to the old data, then the data migration options for old servers will be removed from the **MANAGE SERVERS** panel within MySQL Enterprise Service Manager. To remove access, you need to **REVOKE** access to the `merlin` database:

```
mysql& REVOKE ALL on merlin.* FROM 'service_manager';
```

Note that revoking access to the old data will not reclaim any of the disk space used by the old data.

To delete the data from the database and free up the space being used by the historical information, **DROP** the `merlin` database:

```
mysql& DROP DATABASE merlin;
```

Once all the data has been migrated you can hide the migration user interface by clicking on the **HIDE MIGRATION INTERFACE** button.

### 15.4.3. Regular MySQL Enterprise Monitor Maintenance

MySQL Enterprise Monitor is generally self managing and does not need excessive maintenance. You should, however, be aware of certain maintenance tasks that you can automate or will need to manually perform to keep your MySQL Enterprise Monitor running efficiently.

- Make sure you have set the purge interval for your data to an appropriate value according to duration and history of data that you want to keep. For more information, see [??? \[1285\]](#)
- Check, and delete, the contents of the temporary directory with your MySQL Enterprise Service Manager installation directory.

### 15.4.4. Choosing Suitable MySQL Enterprise Service Manager Hardware Configurations

Running MySQL Enterprise Service Manager places a reasonable load on your system, and this load increases linearly as you add more agents monitoring more servers. Ideally, you should use a dedicated machine for MySQL Enterprise Service Manager, rather than running it alongside other applications and services.

#### Minimum System Requirements

- 2 or more CPU cores
- 2 or more GB of RAM
- Disk I/O subsystem applicable for a write-intensive database

#### Recommended System Requirements (if monitoring 100 or more MySQL servers)

- 4 or more CPU cores
- 8 or more GB of RAM
- Disk I/O subsystem applicable for a write-intensive database (RAID10, RAID 0+1)

## 15.5. MySQL Enterprise Dashboard

### Note

MySQL Enterprise subscription, MySQL Enterprise Monitor, MySQL Replication Monitor, and MySQL Query Analyzer are only available to commercial customers. To learn more, see: <http://www.mysql.com/products/enterprise/features.html>.

The purpose of the MySQL Enterprise Dashboard is to provide you with information about your MySQL servers. It provides a list of the latest MySQL Enterprise Advisor reports, server status information, MySQL Enterprise alerts, and updated views of monitored MySQL servers. The **Monitor** screen gives a quick overview of the status of your MySQL servers.

Open the Dashboard by typing the host name into the address bar of your web browser. If you are unsure of the host name check the [Application host name and port](#) in the [configuration\\_report.txt](#) file. The default value is `http://127.0.0.1:18080/Auth.action` but this login is only valid if you are logging in from the machine that hosts the dashboard. If you are logging in from a remote machine you will have to specify a value other than `127.0.0.1`. Likewise, choose a different port if you are not using the default. After logging in, select the [Monitor](#) tab.

The Monitoring page provides an instant health check for all of the MySQL servers across the enterprise.

From this page users can:

- View monitoring data and all critical MySQL Advisor Rule violations for all or selected servers.
- Close and annotate MySQL Advisor Rule violations.
- Quickly determine if there is a Monitor Agent that is not communicating with the Service Manager.
- Quickly determine if there is a server that is in trouble or completely down.
- View indicator value graphs for key MySQL and operating system (OS) level metrics. Graph presentation will default to a thumbnail view but will open into a larger image upon being clicked.

The monitored server or servers are displayed in a tab on the left known as the [Server Tree](#). You can navigate to a number pages that provide more detailed information. These pages include:

- [Monitor](#) — the overview page providing you with a quick summary of the servers, their status, events, availability and load. The remainder of this chapter details the contents of this page.
- [Advisors](#) — shows the various advisors configured in your installation and allows you to schedule their execution on different servers, apply and manage rules and manage the advisor installation itself. For more information, see [Section 15.7, “The Advisors Page”](#).
- [Events](#) — provides an interface into the event system that highlights specific issues and problems on your monitored servers. For more information on using Events, see [Section 15.8, “The Events Page”](#).
- [Query Analyzer](#) — interfaces to the query monitoring system that can be used to monitor and track the individual queries that are being executed on a system and help to highlight problem queries that may need optimization or that may be affecting server load. For more information, see [Section 15.10, “The Query Analyzer Page”](#).
- [Graphs](#) — enables you to view and configure a number of individual graphs covering a range of different statistics. For more details on how to view and use these graphs, see [Section 15.9, “The Graphs Page”](#).
- [Replication](#) — provides information on the status and structure of your servers that are using replication. This page is only available if you have a suitable subscription level. For more information, see [Section 15.11, “The Replication Page”](#).
- [Settings](#) — controls the settings for the server, including email configuration, passwords, and server and user management. For more information, see [Section 15.6, “The Settings Page”](#).

Graphs are shown in the center of the page beneath the tabs. If applicable, you'll also find a list of critical events.

On the right is the color-coded [Heat Chart](#), showing the advisors that are installed by default. The [Heat Chart](#) shows the most important advisors, allowing a quick overview of the state of your servers. You may open the [Heat Chart](#) in its own window by clicking the [Standalone Heat Chart](#) link. If applicable, you'll also find a list of critical events.

The [Show/Hide Legend](#) link toggles display of the key to the icons used in the [Heat Chart](#).

#### Note

Find colorblind-accessible icons in the [alternate](#) directory. On Linux this directory is immediately below the `/monitor/apache-tomcat/webapps/ROOT/web/resources/images/` directory. These images are stored in the same directory on Windows. To use them, backup the originals and then copy and paste the alternate set into the [images](#) directory.

If a specific server is selected in the [Server Tree](#) details about this server are shown beneath the legend in the [Meta Info](#) area. The information shown in this area is the host name, the MySQL version number, the number of scheduled rules, the operating system, and the CPU.

The [Meta Info](#) section also shows how long the agent has been running, when it last contacted the MySQL server it is monitor-

ing, and the last time the agent contacted the dashboard. Mouse over the date shown beside **UP SINCE** and a pop-up box displays the time that has elapsed since the server instance was last started. You can also mouse over the **LAST MYSQL CONTACT** and the **LAST AGENT CONTACT** dates.

### Note

In the case of remote monitoring, the agent runs on a different machine than the MySQL server that it is monitoring. The **Hostname**, **MySQL**, and **Rules** information applies to the system being monitored. The **OS** and **CPU** information applies to the machine on which the agent is running. For more information about remote monitoring see, [Section 15.3.3.6.4, “Configuring an Agent to Monitor a Remote MySQL Server”](#).

The top of the screen shows the refresh cycle and **Help** and **Log Out** links. Click the **Help** link to open the documentation in a separate browser window. Choose **Log Out** if you wish to leave the Dashboard or to log in as a different user. Different refresh rates are available from the drop-down listbox.

In the footer are external links to MySQL Enterprise and information about the current user. Users can remain connected to the Dashboard and update their subscription, use the Enterprise Knowledge Base, and contact technical support. Your subscription information is also displayed here, showing the number of days remaining and the number of licenses. The number of licenses indicates to the number of machines that may be monitored; any number of MySQL servers may be running on a specific machine.

The footer also contains a link to the **Settings** page. If your subscription is current it reads **SUBSCRIPTION IS UP-TO-DATE. MORE INFO.....** For more information about the **Settings** page see [Section 15.6.7, “The Product Information Screen”](#).

## 15.5.1. The Server Tree

The tab on the left displays the Server tree. By default the first group of servers is selected. This selection determines the information shown on the **Monitor** page.

If a server group is selected, the information presented on the **Monitor** page is aggregate information for this group; if only one server is selected the information applies to that server only.

Change your server selection and the information shown in the graphs and in the **Heat Chart** changes.

### Note

For more information about server groups see, [Section 15.6.3.2, “Grouping Servers”](#).

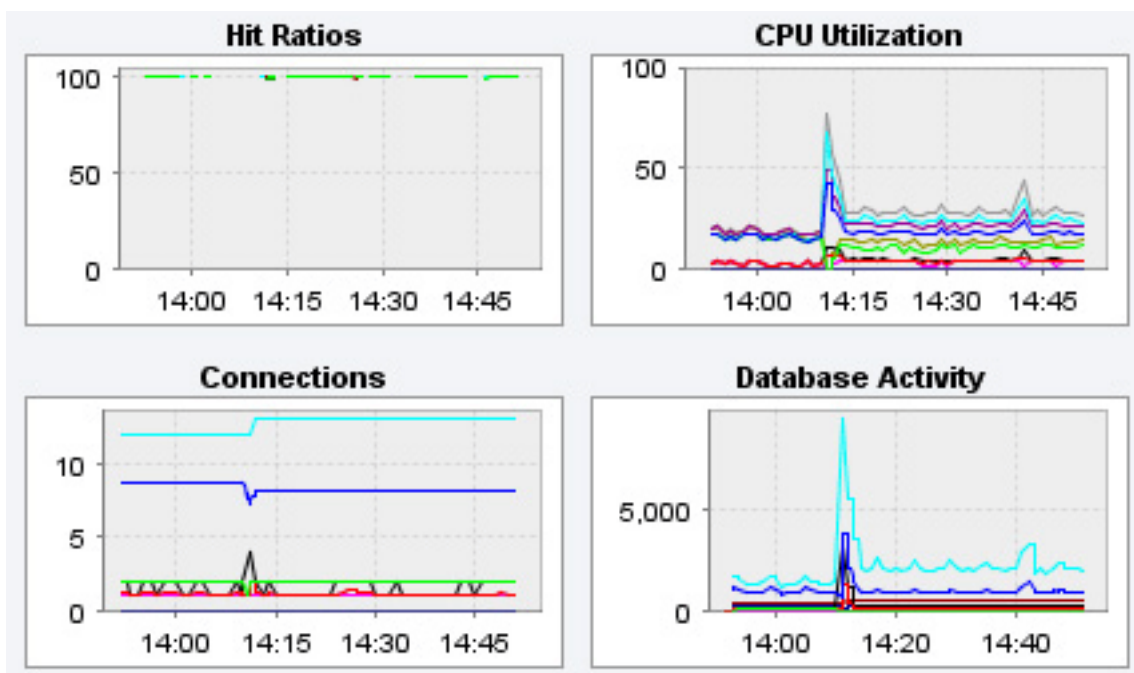
The individual server, or server group, selected in the Server Tree also determines what information appears when the **Advisors** tab or the **Events** tab is selected.

The Server Tree presents an easy way to navigate to different groups or to specific servers.

## 15.5.2. The Server Graphs and Critical Events

The center of the **Monitor** page gives a visual representation of the state of your servers.

**Figure 15.32. MySQL Enterprise Dashboard: The Graphs screen**



The graphs present information about the currently selected server or server group. The default graphs show the hit ratios, CPU utilization, connections, and database activity for a specific interval.

To set the interval click the [configure graphs](#) link immediately below the graphs. This opens a dialog box where you can choose the default interval for the x-axis of the graphs. Defining a shorter or longer interval gives you a shorter or longer term view of server activity. The thumbnail and full-size graph dimensions can also be adjusted from this dialog box. Save any changes that you have made and the values chosen will be the defaults whenever you log in.

You can also choose the default graphs shown on the [Monitor](#) page. To do this click the [edit favorites](#) link and choose the graphs you want from the drop-down list box. To choose contiguous graphs, hold down the **Shift** key and click on the desired graphs. For a non-contiguous selection, click the desired graphs while holding down the **Ctrl** key. The maximum number of graphs that can be displayed on the [Monitor](#) page is six. Save your changes and these will be the default graphs whenever you log in.

Color coding helps distinguish different aspects of each graph. With [Database Activity](#) for example, you can readily distinguish [SELECT](#) statements from database insertions.

Clicking a graph opens a detailed view with **GRAPH DISPLAY** and **CONFIGURE** tabs. Choose the [Configure](#) tab to temporarily change the way that a graph displays. Changes made from this tab only apply to the standalone graph while it is open. Persistent changes are made as described above.

Dismiss the enlarged graph by clicking the **HIDE** button.

[Critical](#) alerts appear on this page immediately below the graphs—quickly attracting your attention. For a description of all the different alarm levels see, [Section 15.5.3, “The Heat Chart”](#). This is the subject of discussion in [Section 15.8, “The Events Page”](#).

### 15.5.3. The Heat Chart

The [Heat Chart](#) is found on the right side of the [Monitor](#) page and shows the status of critical rules. Monitored servers are organized by groups. To view the status of a specific server, click the + button next to the appropriate server group.

Whenever a new agent contacts the Service Manager for the first time, all the rules in the Heat Chart Advisor are automatically activated. These Advisors monitor the status of the server and agent, critical operating system indicators, and important events related to your MySQL servers. An example follows.

**Figure 15.33. MySQL Enterprise Dashboard: The Heat Chart**

	Agent Status	Server Status	CPU Usage	IO Usage	RAM Usage	Lock Usage	My/SAM Usage	Temp Tables	Query Cache	Table Cache	Table to Disk	Critical Scans	Warnings	Info	
+ All Servers (11)	●	⊗	○	○	○	○	○	○	○	○	○	●	29	55	33
- Dev (3)	●	⊗	○	○	○	○	○	○	○	○	○	○	3	10	2
DEV1:3306	●	⊗	⊗	⊗	⊗	⊗	⊗	⊗	⊗	⊗	⊗	⊗	0	3	1
DEV2:3307	●	⊗	⊗	⊗	⊗	⊗	⊗	⊗	⊗	⊗	⊗	⊗	1	3	1
LOCALWS:3306	●	●	○	○	○	○	○	○	○	○	○	○	2	4	0
- Prod (4)	●	●	○	○	○	○	○	○	○	○	○	○	16	27	15
PROD1:3306	●	●	○	○	○	○	○	○	○	○	○	○	4	7	3
PROD2:3307	●	●	○	○	○	○	○	○	○	○	○	○	4	7	6
PRODWEB2:3306	●	●	○	○	○	○	○	○	○	○	○	○	4	6	3
PRODWEB:3306	●	●	○	○	○	○	○	○	○	○	○	○	4	7	3
- Web (4)	●	●	○	○	○	○	○	○	○	○	○	○	10	18	16
KYWEB1:3306	●	●	○	○	○	○	○	○	○	○	○	○	2	4	3
KYWEB2:3307	●	●	○	○	○	○	○	○	○	○	○	○	3	5	5
KYWEB3:3306	●	●	○	○	○	○	○	○	○	○	○	○	2	4	3
KYWEB4:3307	●	●	○	○	○	○	○	○	○	○	○	○	3	5	5

To interpret the Heat Chart see the following legend.

Figure 15.34. MySQL Enterprise Dashboard: The Heat Chart legend

Server & Agent Status	Monitored Events
● up	○ ok
● down	● info
⊗ unknown	● warning
	● critical
	⊗ unknown

The status `unknown` will typically apply when an agent is down and can no longer report the status of the server that it is monitoring. The status `unknown` may also apply if the data collection that should be collected is not available on the server being monitored.

You may open the Heat Chart in its own browser window by clicking the [Standalone Heat Chart](#) link immediately below the [Heat Chart](#) on the left. If you like, the refresh rate can be set to a different rate than the setting on the [Monitor](#) page.



In addition to showing the most important advisors, the [Heat Chart](#) also has columns that display the number of critical, warning, and informational alarms. Clicking the hyperlink in any one of these columns takes you to the [Event](#) screen, which gives more detailed information. For more information about events see, [Section 15.8, “The Events Page”](#).

When the Dashboard is first installed no notification groups are associated with the Advisors shown in the Heat Chart. For more information on this topic see, [Section 15.3.2.7.3, “Installing Advisors After Initial Log-in”](#) and, [Section 15.6.5, “Manage Notification Groups”](#).

## 15.6. The Settings Page

### Note

MySQL Enterprise subscription, MySQL Enterprise Monitor, MySQL Replication Monitor, and MySQL Query Analyzer are only available to commercial customers. To learn more, see: <http://www.mysql.com/products/enterprise/features.html>.

Upon initial installation you may have configured your MySQL Enterprise credentials and also outgoing email settings. This section explores the configuration settings in more detail, and also shows how to manage servers, users, notification groups, Simple Network Management Protocol (SNMP) traps, log files, and the product information screen.

Knowledge of server management is a prerequisite for properly configuring advisors — the subject of [Section 15.7, “The Advisors Page”](#).

To get to the [Settings](#) page open the Dashboard and choose the [Settings](#) tab.

### 15.6.1. Global Settings

The **GLOBAL SETTINGS** control the main configuration parameters for the entire MySQL Enterprise Monitor system, including your email notifications, data purge, and Enterprise website credentials.

**Figure 15.35. MySQL Enterprise Dashboard: Settings**

The screenshot shows the MySQL Enterprise Monitor interface with the following sections and settings:

- Outgoing Email Settings:**
  - Enable Email Notifications
  - From Address (ex. "MySQL Dashboard" <name@domain.com>): [text box]
  - SMTP Server: [text box]
  - SMTP Server Login: [text box]
  - Disable JavaMail TLS/SSL
  - Update Password On Save
  - SMTP Server Password: [text box] Confirm Password: [text box]
  - On Save, Send Test Email Message to (optional): [text box]
  - [save]
- Data Purge Behavior:**
  - Remove Historical Data Collection Older Than: never [dropdown]
  - Remove Service Manager Logs Older Than: never [dropdown]
  - Remove Query Analyzer Data Older Than: never [dropdown]
  - [save]
- Remote Server Inventory Schedule:**
  - Re-inventory Remote Servers Every: 12 hours [dropdown]
  - This will re-inventory all connected servers. The information collected may be used in custom data collection.
  - [save]
- MySQL Enterprise Credentials:**
  - These credentials are used to login to MySQL Enterprise at mysql.com to enable subscription updates.
  - Email Address (MySQL Enterprise Login): [text box]
  - Enterprise Password (MySQL Enterprise Password): [text box]
  - Confirm Password: [text box]
  - [save]
- MySQL Enterprise Product Key:**
  - In the event that this machine cannot connect to mysql.com to verify subscription information, you may manually import this information from a file provided by MySQL Enterprise. Subscription updates will require that you retrieve a new file from MySQL Enterprise.
  - MySQL Enterprise Product Key: Choose File [button] no file selected
  - [save]
- Server Locale:**
  - Locale: English (United States) [dropdown]
  - This locale overrides the operating system locale for use in notifications.
  - [save]

Footer: MySQL Enterprise © 2005-2008 MySQL AB, 2008 Sun Microsystems, Inc. All rights reserved. Enterprise Software | Update Service | Knowledge Base | Technical Support | About. Logged in as "admin" (Nov 19, 2008 3:38:40 PM). Monitoring 3 instances on 2 hosts (198 hosts remaining). Subscription is up-to-date. More info...

The **GLOBAL SETTINGS** page is divided into a number of different sections:

- **OUTGOING EMAIL SETTINGS**

Configures the settings for email notified by MySQL Enterprise Service Manager. You must configure the **FROM ADDRESS** **SMTP SERVER** settings. If your server requires authorization, complete the necessary server login details, and whether SSL is required.

You can test your configuration immediately by adding an email address to the **ON SAVE, SEND TEST EMAIL MESSAGE TO** box.

For more information about [Outgoing Email Settings](#) see, [Section 15.3.2.7.5, "Outgoing Email Settings"](#).

- **SNMP TRAPS**

The **SNMP Traps** section of the [Global Preferences](#) page allows you to enable Simple Network Management Protocol so that your Network Management System (NMS) can handle events created by the MySQL Enterprise Monitor. Configure this section to route alerts and notifications to standard SNMP-enabled nodes on your network.

In the **TARGET** text box enter the IP address or the host name of your NMS listener. The port number defaults to the well-known SNMP port, **162**. If you are not using this port, enter the port that your Network Management System is listening on.

Enter the appropriate community string in the **Community String** text box. The default value for this string is **public**.

To ensure that the target you have specified is valid, check the **On Save, Send Test Trap** check box. The remaining check boxes help you to configure how your NMS responds to MySQL Enterprise Monitor. Check the **UP/DOWN APPLICATION** check box to configure NMS for starting up or shutting down the MySQL Enterprise Monitor. For configuration of advisor events choose a level of severity and check the **ADVISOR EVENT WITH THE SEVERITY OF CRITICAL** check box. Finally,



choose the **APPLICATION ERROR** check box to configure NMS to support application error traps. Be sure to save your settings before exiting.

If you wish to enable SNMP traps globally, check the [Enable SNMP Notifications](#) checkbox. To enable SNMP traps only for specific rules run against specific servers or server groups leave this checkbox unchecked — enabling specific SNMP traps is done as rules are scheduled. For instructions on doing this see [Section 15.7.2, “Scheduling Rules”](#).

The Management Information Base (MIB) file associated with SNMP trapping is called `MONITOR.MIB`. For the location this file see [The Management Information Base \(MIB\) File](#).

- **SERVER LOCALE**

The [Server Locale](#) setting determines the language of notification for the following items:

- Email notifications
- SNMP traps
- The naming conventions for shared resources such as a replication group name prefix

The initial value in this drop down list box is the locale for the OS on which the Dashboard is running.

- **DATA PURGE BEHAVIOR**

The [Data Purge Behavior](#) section of the [Global Preferences](#) page lets you remove old log files and also old data from the repository. The default purge interval is `never`. If you wish to purge data, change this setting by choosing from the drop-down list. Choosing `52 weeks`, for example, will remove all data that is older than a year.

### Warning

Purging data will permanently remove information from the repository. Since events are derived from data contained in the repository, they will be purged along with the data.

Ensure that there is adequate disk space for the repository. If you are monitoring numerous servers and running many rules the size of the repository can increase rapidly. Choose purge behavior accordingly.

The default value for purging, `never`, is the safest option. However, please choose a purge setting that makes sense for your environment.

### Note

The purge process is started approximately once every minute. If you change the purge duration from a larger timespan to a smaller one, the data may start to be purged immediately.

You can configure the data purge behavior for a number of different systems individually:

- **Remove Historical Data Collection Older Than** configures the duration that the main data about your servers is retained. This includes all data collections, including CPU, memory and connections and activity statistics.
- **Remove Service Manager Logs Older Than** configures the duration that the main MySQL Enterprise Service Manager logs are retained.
- **Remove Query Analyzer Data Older Than** configures the duration that the query analyzer statistics and information about individual queries is retained.

### Note

Purging can be carried out manually by enabling the `innodb_file_per_table` for the repository database and then using an `OPTIMIZE TABLE` operation to reclaim space from deleted rows in the table.

- **REMOTE SERVER INVENTORY SCHEDULE**

MySQL Enterprise Monitor keeps track of all the databases and tables in a server, as well as the amount of RAM, disk space, and other items. A re-inventory updates this information in case you've added or dropped databases and tables. Depending upon the configuration of your system, this operation can tax resources. If you are monitoring many remote servers this is an operation you may want to perform in off-peak hours only.

- **MYSQL ENTERPRISE CREDENTIALS**

You can specify the credentials for logging into the MySQL Enterprise Website. These should match the user name and password that you have registered with MySQL for your enterprise subscription.

**Note**

Only administrators can change the [MySQL Enterprise Credentials](#) section or enter a product key; for other users, this section does not show up in the interface. For more information about different users and their rights see [Section 15.6.4, “Managing Users”](#). Specifying incorrect credentials results in the error message, “Your credentials do not appear to be valid.”

- **MYSQL ENTERPRISE PRODUCT KEY**

You may update your [MySQL Enterprise Product Key](#). If you do not have access to the Internet from the Dashboard, this provides an alternate way to update or activate the MySQL Enterprise Monitor.

To enter your product key first download it from the MySQL Enterprise website. Copy the key to a location accessible from the Dashboard. Use the BROWSE button to locate the key and then press the SAVE button.

If you wish to switch from using your MySQL Enterprise credentials to using a product key to update MySQL Enterprise Monitor, you must first clear your credentials. Do this by removing the email address from the **MYSQL ENTERPRISE CREDENTIALS** section and then clicking the SAVE button. You may then enter and save your MySQL Enterprise product key.

**Note**

Only administrators can change the [MySQL Enterprise Credentials](#) section or enter a product key; for other users, this section does not show up in the interface. For more information about different users and their rights see [Section 15.6.4, “Managing Users”](#). Specifying incorrect credentials results in the error message, “Your credentials do not appear to be valid.”

## 15.6.2. User Preferences

On this page users can change their passwords, user names, and locale information.

**Figure 15.36. MySQL Enterprise Dashboard: User Preferences**

The screenshot shows the 'User Preferences' section of the MySQL Enterprise Monitor dashboard. At the top, there are navigation tabs: Monitor, Advisors, Events, Graphs, Query Analyzer, Replication, Settings, and What's New?. Below these are sub-tabs: Global Settings, User Preferences (selected), Manage Servers, Manage Users, Manage Notification Groups, Logs, and Product Information. The main content area is titled 'User Preferences' and contains the following fields:

- User Name:** A text input field containing 'admin'.
- Role:** A dropdown menu with 'manager' selected.
- Password:** A text input field with the instruction '(Leave empty to keep password unchanged)'. It is currently empty.
- Confirm Password:** A text input field, currently empty.
- Timezone:** A dropdown menu showing '(GMT+00:00) Greenwich Mean Time - Europe/London'.
- Locale:** A dropdown menu showing 'English'.
- save:** A button at the bottom left of the form.

Change your password by entering a new value into the **PASSWORD** text box. To change your user name enter a new value into the **USERNAME** text box. Click the **SAVE USER PROPERTIES** button to commit this change.

You may also adjust your time zone and locale information from this page. The settings on this page apply only to the user who is currently logged in.

The MySQL Enterprise Service Manager determines the default value for the locale by looking at your browser settings. Changing this value, determines the language setting for any future logins to the Dashboard, overriding your browser settings.

**Note**

Be sure to set the correct time zone so that alerts are time stamped correctly.

This setting applies only to the specific user.

## 15.6.3. Manage Servers

To help with server management, the Service Manager supports the logical grouping of MySQL servers. This allows you to group servers in any fashion you choose. For example, you can manage servers according to purpose. You can group servers by whether the servers handle Internet or intranet data, by whether they power finance or HR applications, or, if you prefer, you may organize them by physical location rather than by functionality.

**Figure 15.37. MySQL Enterprise Dashboard: Manage Servers**

Server	Query Analyzer			MySQL	Up Since	Last MySQL	Agent	Last Agent	Migration Status
	Enabled	Examples	Explains						
<input type="checkbox"/> All Servers (3)									
<input type="checkbox"/> bear:3306 (ungrouped)	On	On	On	5.0.60-log	Sep 13, 2008 6:37:12 PM	Nov 19, 2008 4:07:00 PM	2.0.0.7085	Nov 19, 2008 4:07:13 PM	N/A
<input type="checkbox"/> gentoo1.vmbear:3306 (ungrouped)	On	Off	Off	5.0.60-log	Nov 17, 2008 10:26:45 AM	Nov 19, 2008 4:42:00 PM	2.0.0.7101	Nov 19, 2008 4:07:13 PM	Done
<input type="checkbox"/> gentoo2.vmbear:3306 (ungrouped)	On	Off	Off	5.0.60-log	Nov 17, 2008 9:04:53 AM	Nov 19, 2008 1:51:00 PM	2.0.0.7101	Nov 19, 2008 4:07:11 PM	Done

For a server to appear in the Dashboard there must be an agent monitoring it. If you wish to add a server to the Dashboard follow the procedure for installing an agent found at [Section 15.3.3, “Monitor Agent Installation”](#). Instructions for adding a remote server are found at [Section 15.3.3.6.4, “Configuring an Agent to Monitor a Remote MySQL Server”](#).

The **MANAGE SERVERS** panel also allows you control the Query Analyzer and Data Migration. For more information, see [Section 15.10.6, “Query Analyzer Settings”](#) and [Section 15.4.2, “Migrating 1.3.x Historical Data to MySQL Enterprise Monitor 2.0”](#).

### Note

The **All Servers** group is built in and every monitored server is a member of this group.

## 15.6.3.1. Renaming a Server

You can rename an existing server without losing the current historical data or configuration information. Renaming the server also allows you to modify the name of the server to be more descriptive according to the server’s role within your organization. For example, you may want to rename a server from the default host name to include the department and application for the MySQL server.

To rename a server, click the **RENAME** link next to the server. You will be prompted with information about the server, including the host name and registered IP addresses for the agent. Fill in the alternative name that you want to be displayed in the text box at the bottom of the window.

**Figure 15.38. MySQL Enterprise Dashboard: Server Renaming**

**Rename Server**

**Rename Server "bear:3306".**

**host**  
bear.mcslp.pri  
localhost

**ip**  
192.168.0.2  
127.0.0.1  
192.168.92.1  
172.16.217.1

**port**  
3306

**name**

save cancel

### 15.6.3.2. Grouping Servers

All monitored servers are automatically included in the top level server grouping, [All Servers](#). Other server groupings are replication groups or user-defined groups.

You can create a user-defined group by clicking on the [Manage Servers](#) link. Add a group name and then click the CREATE GROUP button. The new group will be displayed immediately.

Replication groups are automatically discovered by MySQL Enterprise Monitor and in this respect differ from user-defined groups. For more information about replication groups see [Section 15.11, "The Replication Page"](#). However, like user-defined groups you can edit the name of a replication group and add other servers to it.

To add to a group, select the [add to group](#) link. Choose the server or servers you wish to add and then complete the operation by choosing the ADD TO GROUP button. You can add a server to a group even if the agent is down.

To remove a server from a group expand the server group tree and click the [remove from group](#) link. To delete a server altogether see [Section 15.6.3.3, "Removing a Server From the Dashboard"](#).

#### Note

Slaves removed from a replication group will be rediscovered and re-added to that group.

There are three ways to modify an existing group; by renaming it, adding to it, or removing it. Select the [rename](#) link to change the name of a group and [add to group](#) to add additional servers. Deleting a group simply requires clicking the [remove all from group](#) link. This removes the server group but has no effect on individual servers.

### 15.6.3.3. Removing a Server From the Dashboard

If you no longer wish to monitor a MySQL server you can remove it from the Dashboard. There is no provision for deleting an active server from the Dashboard—to remove a server you must make it inactive by stopping the agent.

For instructions on stopping an agent see:

- Windows – [Section 15.3.3.5.1, "Starting/Stopping the Agent on Windows"](#)
- Unix – [Section 15.3.3.5.3, "Starting/Stopping the Agent on Unix"](#)
- Mac OS X – [Section 15.3.3.5.2, "Starting/Stopping the Agent on Mac OS X"](#)

Once the agent is stopped you may delete the monitored server. Deleting a server simply means that it will no longer show up in the Dashboard.

Remove a server by choosing the [Settings](#) tab and then the [Manage Servers](#) link. Find the server you wish to remove and delete it by clicking the [delete](#) link. Deleting a server from the [All Servers](#) group or from any other group will remove it from the Dashboard entirely.

### Note

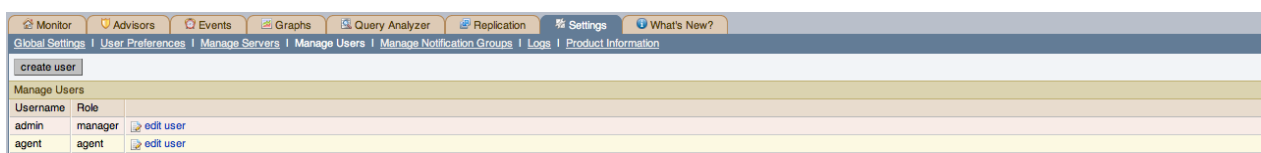
A [delete](#) link will not appear beside an active server. You must stop the agent before this link will appear.

You may remove a server from any group at any time. Removing the last server from a group also removes that group.

## 15.6.4. Managing Users

The **MANAGE SERVERS** panel allows to create, delete and manage individual users that have access to MySQL Enterprise Service Manager

**Figure 15.39. MySQL Enterprise Dashboard: Manage Users**



To log in to the Dashboard a user account is required. There are three types of users with varying privileges; Administrators, Database Administrators, and Agents. The [Administrator](#) can create additional users and differs from a [DBA](#) in this respect. For this reason the [Manage Users](#) does not display if a [DBA](#) user logs in. Additionally, only administrators can change the MySQL Enterprise Credentials section or enter a product key on the [Global Settings](#) page. These sections do not appear when [DBA](#) users log in. For more information on this subject see [Section 15.6.1, "Global Settings"](#). The [Agent](#) account simply allows the MySQL Enterprise Monitor Agent to communicate with the Dashboard. There is no need for more than one agent account but defining an account for each server that is monitored can be an advantage since this minimizes exposure should any one agent be compromised. You cannot log in to the Dashboard using the agent's credentials.

When the Dashboard is first launched there are two default users, [Administrator](#) and [Agent](#), both created during installation. Their default user names are respectively, [admin](#) and [agent](#). The Administrator defined during installation as having the root role is unique; this user cannot be deleted.

If you are logged in as an [Administrator](#), you can add a new user by choosing the [Manage Users](#) link from the [Settings](#) page. To create a user click the [CREATE USER](#) button, select a role for the user, and enter a user name and password.

When a new user first logs in, a dialog box opens requesting time zone and locale information. This information may be changed later from the [User Preferences](#) page. For more information, see [Section 15.6.2, "User Preferences"](#).

If you installed the Advisors through the Dashboard you should have already configured the settings for the root role user. (See [Section 15.6.1, "Global Settings"](#) and following for more information about this topic.)

### Warning

To receive MySQL Enterprise and Advisor updates configure the MySQL Enterprise settings for at least one user. The MySQL Enterprise settings were set up on the first login to the Dashboard. For information on changing these settings see, [Section 15.6.1, "Global Settings"](#).

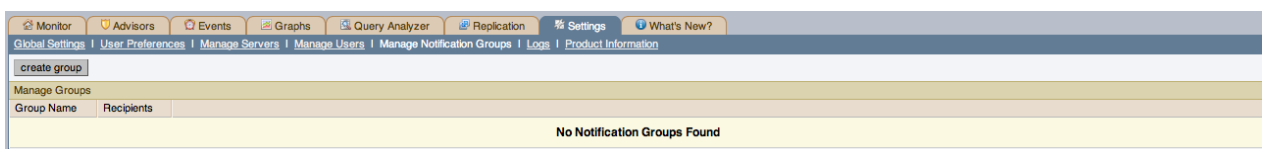
To edit an existing user's information, select the [Manage Users](#) link, then select the user you wish to edit. Make your desired changes in the fields provided and then save your changes.

To delete an existing user, merely select the [delete](#) link.

## 15.6.5. Manage Notification Groups

The **MANAGE NOTIFICATION GROUPS** panels allows you to create and manage the notification groups used when different notifications and warnings are distributed.

**Figure 15.40. MySQL Enterprise Dashboard: Manage Notification Groups**



Notification groups are collections of users who should be notified when advisor alerts occur. These users may have login credentials for the Dashboard but this is not a requirement.

You can create a group by clicking on the [create group](#) link. Specify a group name and add recipients. When adding a user an email address must be specified. If you are adding multiple users separate them with commas.

To modify an existing notification group, select the [edit](#) link next to the group name. Deleting a group simply requires clicking the [delete](#) link.

If a rule triggers an alarm, an email will be sent to the members of the notification group specified when the rule was scheduled. For more information about scheduling rules see [Section 15.7.2, “Scheduling Rules”](#).

### Note

You should ensure that there is a mail server available for sending out alerts and that there is an account configured for receiving any alerts that are created.

## 15.6.6. Logs

Use the [Logs](#) link to inspect the various log files associated with the MySQL Enterprise Service Manager. The following image is an example of this screen.

**Figure 15.41. MySQL Enterprise Dashboard: Logs**

Log Name	Threshold	Last Modified	Entries
All	N/A	Nov 19, 2008 4:07:37 PM	838
Advisors	Info	Nov 19, 2008 11:44:28 AM	338
Agent Monitoring	Info	N/A	0
Agent Tasks	Info	N/A	0
Data Collection	Info	N/A	0
Graphs	Info	Nov 19, 2008 11:44:12 AM	4
Groups	Info	N/A	0
Inventory	Info	Nov 19, 2008 11:44:24 AM	4
JDBC	Info	N/A	0
Misc	Info	Nov 19, 2008 11:44:29 AM	11
Migration	Info	Nov 19, 2008 1:52:09 PM	340
Notification	Info	N/A	0
Preferences	Info	N/A	0
Replication	Info	N/A	0
Security	Info	N/A	0
SQL	Info	N/A	0
Timing	Info	Nov 19, 2008 4:07:37 PM	140
Xwork	Warning	N/A	0
Apache	Warning	Nov 19, 2008 11:26:32 AM	1
Catalina	Warning	N/A	0
Hibernate	Warning	N/A	0
Freemarker	Warning	N/A	0
Spring	Warning	N/A	0
EH Cache	Warning	N/A	0

The various categories of logs are shown in alphabetical order. The most recent changes to each log are shown in the **LAST MODIFIED** column. The number of entries in any specific log is shown under the **ENTRIES** column.

To view detailed information click the [Log Name](#). This will open a separate browser window showing the date, time, alert type, and accompanying message.

On this screen you can filter log information in a couple of ways; by the message type and by time period .

To filter by message type select from the options in the **LEVEL** drop-down box. These are, in order of decreasing severity:

- All
- Error
- Warning

- Information
- Trace
- Debug

You can also adjust the number of items that appear on each page.

Press the [clear all logs](#) link to remove all log entries. To remove entries of a specific kind click the [clear logs](#) link associated with the specific log you would like to remove. A confirmation dialog box allows you to back out of this operation and avoid accidentally removing log information.

To clear log files of a specific age see the [Data Purge Behavior](#) section of the [Global Preferences](#) page. For more information on this topic see [??? \[1285\]](#).

Use the [edit log level](#) link to change the type of error logged. The value selected from the [Edit Log Level](#) dialog box determines what appears under the **THRESHOLD** column (second from the left in [??? \[1285\]](#)).

Selecting [Error](#) from the list box will create the least number of log entries and [Debug](#) the most. Choosing [None](#) turns off logging altogether.

It is also possible to download a compressed version of all the log files. For more information, see [Section 15.6.7, “The Product Information Screen”](#).

## 15.6.7. The Product Information Screen

Use the [Product Information](#) link to view detailed information about your subscription level and contract status.

The **CONTRACT STATUS** section displays the subscription level, expiration date, contract number, the number of servers supported, and your MySQL Enterprise user name. The **SUBSCRIPTION LEVEL** section gives more detailed information, including features and any restrictions that may apply. You may update your subscription at any time by clicking the UPDATE button.

### Note

The UPDATE button was added in version 1.3 of the MySQL Enterprise Monitor. If your version of MySQL Enterprise Monitor does not have an UPDATE button, saving your credentials again will download a new key. See [Section 15.6.1, “Global Settings”](#) for instructions on doing this. If you do not have Internet access from the Dashboard, you can install a new key manually. This process is described in [Section 15.6.1, “Global Settings”](#).

This page also contains Enterprise Dashboard Server information; the version number, uptime, and other information related to the memory used by the Java Virtual Machine.

The [Enterprise Dashboard Server information](#) section also contains the hyperlink, [Download diagnostic report](#). Click this link to download a compressed version of the MySQL Enterprise Service Manager log files. All the log files found on the [Logs](#) page (for more information about logs see [Section 15.6.6, “Logs”](#)) are contained in this file. It also contains the Java properties file, the monitored MySQL servers property file, information about the status of the JDBC connection and Java threads, and the [subscription.xml](#) file. This report is especially useful for debugging the MySQL Enterprise Service Manager and the MySQL Enterprise Monitor Agent.

### 15.6.7.1. Subscription Warning

The [Subscriptions Warning](#) section on the product information page displays any warnings relative to your subscription. For example, if your subscription has expired you may receive a message such as the following:

```
Your Subscription Needs to be Updated
* Your Platinum subscription expired 3 days ago on Feb 14, 2008 11:59:59 PM.
If the subscription information on this page is not current, you can
update it by going to the Enterprise Monitor Global Settings page and
providing MySQL Enterprise credentials or by importing a new product
key that you downloaded from http://www.mysql.com/enterprise/download.php.
To update or renew your subscription, please contact your MySQL
Account Representative at sales@mysql.com or visit
http://www.mysql.com/about/contact/renew.html. After the update or
renewal is complete you can then follow the above instructions for
updating your subscription.
```

Follow these instructions to update your subscription. If you see this message and your subscription has already been updated, simply click the UPDATE button in the **CONTRACT STATUS** section of this page. This should update your subscription and remove the warning.

### Note

After updating your subscription remember to also update your advisors. For instructions on doing this see [Section 15.7.1, “Installing and Updating Advisors”](#).

## 15.7. The Advisors Page

### Note

MySQL Enterprise subscription, MySQL Enterprise Monitor, MySQL Replication Monitor, and MySQL Query Analyzer are only available to commercial customers. To learn more, see: <http://www.mysql.com/products/enterprise/features.html>.

MySQL Enterprise Advisors are a series of scripts that gather information from your MySQL servers via the Service Manager and the Service Agents, analyze that information based on custom rules developed by MySQL AB, and then offer alerts and advice when necessary. As new rules are introduced, the MySQL Enterprise Advisors can be updated through the MySQL Enterprise website.

The MySQL Enterprise Advisors fall into the following categories:

- Administration
  - Better manage databases
  - Suggest improvements for smoother operation
- Heat Chart
  - Drive the status indicators in the Heat Chart
  - Identify up/down status and performance issues
- Performance
  - Identify potential performance bottlenecks
  - Make suggestions for improved database speed
- Replication
  - Identify replication bottlenecks
  - Improve replication design
- Schema
  - Identify schema changes
  - Find security loopholes
- Security
  - Protect MySQL servers
  - Find security loopholes

An advisor category provides a set of rules designed to enforce MySQL best practices for that specific category. Rules can be targeted to run at the individual server or group level and, upon rule violation, provide alerts and expert advice on how to address and correct a problem before it becomes a costly outage.

Individual rules are defined in the `items-mysql-monitor.xml` file. On Windows this file is found in the `C:\Program Files\MySQL\Enterprise\Agent\share\mysql-monitor-agent` directory and on Unix in the `/opt/mysql/enterprise/agent/share/mysql-monitor-agent` directory. Find below the rule for discovering a root account with no password.

```
<ITEM>
<NAME>no_root_password</NAME>
<FIELD>no_password</FIELD>
<SCOPE>table</SCOPE>
<CODE>
<![CDATA[SELECT COUNT(*) AS no_password FROM mysql.user WHERE user='root' AND password='']]>
</CODE>
<NAMESPACE>mysql</NAMESPACE>
```



```
<RETURNS>INTEGER</RETURNS>
<SOURCE>table</SOURCE>
<INSTANCE>mysql.user</INSTANCE>
</ITEM>
```

Your MySQL Enterprise subscription level determines which rules are available to you. Subscription levels are cumulative, meaning that higher MySQL Enterprise levels have access to all the rules of the lower levels.

When the Dashboard is first installed, the only rules that are scheduled are those that belong to the [Heat Chart](#) group.

Go to the Advisors screen by logging in to the Dashboard and choosing the [Advisors](#) tab.

## 15.7.1. Installing and Updating Advisors

Instructions for installing Advisors are given in [Section 15.3.2.7.3, “Installing Advisors After Initial Log-in”](#), and following. Principally, you need to configure your MySQL Enterprise login or enter your product key before you can update your Advisors.

If your MySQL Enterprise login is configured, you can download the latest Advisors by navigating to the [Advisors](#) page and finding the [Check for Updates](#) link. You can periodically update advisors in this way.

### Note

If you do not have Internet access and cannot use the online update option you can manually import advisors. This process is described in [Section 15.3.2.7.3, “Installing Advisors After Initial Log-in”](#).

## 15.7.2. Scheduling Rules

Once the MySQL Enterprise Advisors have been installed, you can configure which advisors you would like to run on a scheduled basis.

You can schedule rules by individual server or by group. This is done by first selecting the desired server or server group from the [Server](#) tree found on the left side of the screen. Next select the [Advisors](#) tab.

Opening the [Advisors](#) tab takes you to the [Current Schedule](#) page. If you have only just installed the MySQL Enterprise Monitor then you will only see the [Heat Chart](#) group of advisors. Clicking the + button will show all the rules in the Heat Chart group.

Clicking the + button beside any specific rule will show the servers that this rule is running on, its frequency, and its status. Initially, all the [Heat Chart](#) rules are enabled.

For a more complete description of a rule, click the rule's name. This opens a dialog box that gives detailed information about the rule.

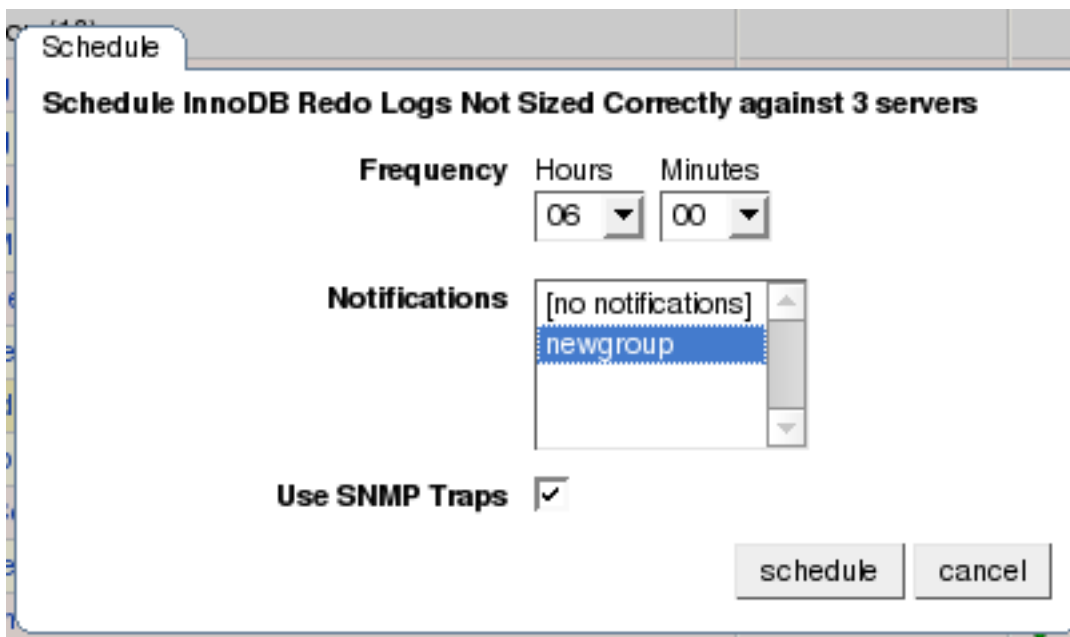
To view the advisors other than the Heat Chart group, select the [Add to Schedule](#) link. This will show all the advisors available for your subscription level.

Rules are grouped by functionality and displayed in alphabetic order. To expand a group click the + button to the left of the advisor name.

You may activate all the rules in a group by selecting the checkbox beside the group name. Once selected you may apply rules against a specific server or a group of servers. A message showing the group of servers or the specific server you have selected will display immediately below the SCHEDULE button. For example, if the [All Servers](#) group is selected in the server tree, then the message will read, “Schedule Advisors Against **All Servers**”.

To select a specific rule, expand the group tree by clicking the + button. Select the checkbox to the left of the rule you wish to schedule. Click SCHEDULE to display the following dialog box:

**Figure 15.42. MySQL Enterprise Dashboard: Scheduling Dialog**



The Schedule dialog box allows you to configure the following fields:

- **Frequency** – Dictates how often the rule will run. The default value for different rules varies but a rule can be set to run at any interval desired.

### Warning

Setting the frequency of a rule involves tradeoffs. Rule evaluation consumes system resources — CPU, memory, and disk space. While the amount consumed is small, if you run all the rules against dozens of servers on a very frequent basis, you may put a significant load on the Service Manager. So select an appropriate frequency. For example, unless you are stopping and restarting your servers frequently, rules that check server configuration variables probably don't need to run very often.

Another consideration is that certain status variables increase monotonically until a server is restarted. Examples of these are `Key_reads`, `Qcache_hits`, `Questions`, `Table_locks_waited`, and similar variables. The value returned by `SHOW STATUS` for these variables is the value since the server was started (or since the last `FLUSH STATUS` command), which is not very useful for performance tuning, especially if the server has been running for an extended period of time. For performance tuning it is much better to know the change in state (i.e. delta) of these values over the last 10 minutes, 1 hour, or whatever time frame is appropriate for your application. The frequency at which you schedule a rule is the time frame used to calculate the delta values of these variables, and it is the delta that is used in expression evaluation, not the absolute value. Consequently, select a frequency that is appropriate for the metrics being used in the expression.

- **Notifications** – A listbox of users and/or notification groups who will be emailed when an advisor reaches an alert level. Single or multiple selections are allowed. For instructions on setting up notification groups see, [Section 15.6.5, “Manage Notification Groups”](#).

Set the frequency, identify whomever you wish to notify, and click SCHEDULE to schedule the advisor. Upon completion, you should see the message, [Successfully scheduled](#).

If you haven't set up global SNMP traps and would like your Network Management System (NMS) to handle events related to a specific rule then check the [Use SNMP Traps](#) checkbox. For more information about Simple Network Management Protocol (SNMP) see [Simple Network Management Protocol \(SNMP\) Traps](#).

Scheduling rules using the checkbox and the SCHEDULE button is an effective way to schedule multiple rules. To schedule a single rule you may also use the [schedule](#) link.

When scheduling more than one rule, you have the option of selecting a checkbox to use the default frequency of each rule or you may choose a frequency that will apply to all selected rules. When customizing the frequency, take care that you choose a value that is appropriate to all the rules selected.

### Note

If the agent does not have the `SUPER` privilege and InnoDB-related rules are scheduled, a warning will appear in the `DataCollection` log. This also occurs if `mysqld` is started with the `skip-innodb` option. For more information about agent rights see [Section 15.3.3.1, “Creating a MySQL User Account for the Monitor Agent”](#).

### 15.7.2.1. Heat Chart Notifications

It is particularly important that `Notifications` be set for the `Heat Chart` group of rules. This is easily done from the `Current Schedule` page by clicking the + button beside a rule and then clicking a server.

Doing this opens a window with three tabs—`Overview`, `Settings`, and `Advanced`.

The `Overview` tab shows which advisor group a rule belongs to, a description of its purpose, and a link to the history of this alert.

In the `Settings` tab you can adjust the frequency of this rule and also specify a notification group. To select more than one contiguous group press the `Shift` key and click the desired groups. (Some web browsers may require that you drag your selection.) Non-contiguous selections are made by holding down the `Control` key and clicking the desired groups.

If you haven't set up global SNMP traps and would like your Network Management System (NMS) to handle events related to a specific rule then check the `Use SNMP Traps` checkbox. For more information about Simple Network Management Protocol (SNMP) see [??? \[1284\]](#).

The `Advanced` tab gives detailed information about how this rule is implemented.

### 15.7.3. Editing Built-in Rules

The frequency and thresholds defined for a rule are default recommendations. To edit these properties choose the `Create/Edit Rule` link.

The following image shows the screen used to edit rules:

**Figure 15.43. MySQL Enterprise Dashboard: Editing Rules**

Rule Name	Advisor	Version
Temporary Tables To Disk Ratio Excessive - copy	Heat Chart	1.0

**Expression**

```
(%Uptime% > 10800) && (((%Created_tmp_disk_tables% / (%Created_tmp_tables%)) * 100) > THRESHOLD)
```

**Thresholds**

Critical Alert

Warning Alert

Info Alert

**Variable Assignment**

Variable	Data Item	Instance	
%Uptime%	mysql:server:Uptime	local	delete
%Created_tmp_disk_table	mysql:server:Created_tmp_disk_tables	local	delete
%Created_tmp_tables%	mysql:server:Created_tmp_tables	local	delete
%tmp_table_size%	mysql:server:tmp_table_size	local	delete
%max_heap_table_size%	mysql:server:max_heap_table_size	local	delete

**Default Frequency**

Hours  Minutes

Beside the rule name is the [Advisor](#) drop-down list box, used for setting the advisor group. This list box shows existing groupings and any you may have added. The [Expression](#) text area shows the advisor rule, [Variable Assignment](#) the data item associated with variable(s) used in the rule and [Thresholds](#) determines when to trigger each alert type.

The three levels of [Thresholds](#) are [Info Alert](#), [Warning Alert](#), and [Critical Alert](#) indicating increasing levels of severity. Levels can be triggered by the expression result being equal to a certain value, greater than a certain value, or less than a certain value.

The data items that variables are associated with are operating system (OS) properties such as available RAM or MySQL characteristics such as the InnoDB buffer pool. To see all available data items drop down the [Data Item](#) list box. For a listing of these data items see [The Data Collection Items Used to Create Rules](#).

In [Figure 15.43, “MySQL Enterprise Dashboard: Editing Rules”](#) the drop-down [Data Item](#) list box within the [Variable Assignment](#) frame shows the various MySQL server status or operating system specific variables that may be used in expressions. The text boxes below [Thresholds](#) define the levels at which informational, warning, or critical alerts are issued.

To lower the threshold for an informational alert, simply increase the number given in the [Info Alert](#) text box.

When a data item can apply to multiple objects, you need to specify which instance to use for that item, hence the [Instance](#) text box. In almost all cases this should be set to `local`. The exceptions are as follows:

- For CPU-related items set **INSTANCE** to `cpu0`. Additional CPUs on a system are referred to as `cpu1`, `cpu2` and so on.
- There can be multiple disks mounted on a system. To refer to a specific drive set **INSTANCE** to the name of the mounted drive. On Windows this would be `C:`, `D:`, and so on. On Unix systems, use whatever is valid for the `df` command.
- For RAM-related items set **INSTANCE** to `mem`.

- Where there are table-specific variables, the database name and table name must be specified in the **INSTANCE** text box. This topic is discussed in detail in what follows.

**Note**

It is not possible to have a data item that is unrelated to an instance. This raises the error, `You must map "<variable>" to an instance`, and you will be unable to save the rule.

An agent can only collect data from one MySQL server, so the `instance` entry for a variable in a rule does not need to specify which MySQL server to use; no matter how many servers are being monitored there is always a one-to-one relationship between an agent and its monitored server.

However, on one server there may be multiple occurrences of a variable. For example, there are multiple possible occurrences of table-specific variables such as `Avg_row_length` because there can be multiple databases and tables defined in a MySQL server. In this case, the “instance” refers to the database and table that a data item should be associated with, specified in the form `tablename.tablename`. So, for example, if you want to reference the `Avg_row_length` of the `mysql` database `user` table in an expression, select the `mysql:tablestatus:Avg_row_length` from the **DATA ITEM** list box and specify `mysql.user` in the **INSTANCE** text box.

On the other hand, in the case of a global server variable, there is only one possible target. For example, there can only be one instance of `delay_key_write` because this variable is global and applies to the server as a whole. In this case specify `local` in the **INSTANCE** text box.

To save your changes click the **SAVE** button at the bottom of the page.

**Note**

You can change only the thresholds and the frequency of built-in rules. So that rules function properly when updated, other changes are prohibited.

Should you wish to make other changes to a built-in rule, copy it and modify it as desired.

You can edit a rule even if it is currently scheduled. Your changes will not be overwritten when new rules are imported using the [Check for Updates](#) link.

## 15.7.4. Creating Advisors and Rules

In addition to using and editing the advisors and rules provided by MySQL Enterprise, users can create their own advisors and rules to meet their own unique needs. To do this go to the [Advisors](#) page and choose the [Create/Edit Rule](#) link.

### 15.7.4.1. Creating Advisors

Similar existing rules are grouped together in advisor groups.

The built-in advisors are:

- Administration
- Heat Chart
- Performance
- Replication
- Schema
- Security

The ability to create your own advisor group allows you to create groupings suitable to your circumstances.

You can create your own grouping by simply clicking the **CREATE ADVISOR** button. Enter an appropriate name and click the **ADD** button. The newly created group will appear in the [Advisor](#) column.

The newly created advisor is added to the list box of advisors shown in [Figure 15.43, “MySQL Enterprise Dashboard: Editing Rules”](#). You can now use this category of advisors when you create a new rule.

### 15.7.4.2. Overview of Rule Creation

Rules are created using the same screen seen in [Figure 15.43, “MySQL Enterprise Dashboard: Editing Rules”](#). To begin creating a rule from scratch, click the CREATE RULE button. However, the simplest way to create a new rule is to copy an existing one. Unlike editing an existing rule, when you copy a rule, every element of that rule is editable.

You can change the rule name, the advisor group that a rule belongs to and you can set your own version number. In [Figure 15.43, “MySQL Enterprise Dashboard: Editing Rules”](#), you have already seen how the threshold and frequency of a rule may be altered.

Most importantly you can alter a rule's expression. Expressions are the core of a MySQL Enterprise Advisor and are used to define the scenario being monitored. An expression can be as simple as a single server parameter or can be quite complex, combining multiple parameters with various mathematical operations.

An expression has two main characteristics:

- An expression defines a situation where a best practice is not being followed
- The result of an expression must always be 1 or 0 (that is, true or false)

If an expression evaluates to true for a specific server, an alarm is raised, indicating that a best practice is not being followed. If an expression evaluates to false no alarm is raised because the best practice is indeed being followed.

For example, if having binary logging enabled is considered a best practice for a production server (which we believe it is), then this best practice is being violated if `log_bin` is `OFF`. Consequently, the expression for the “Binary Logging Not Enabled” rule is “`%log_bin% == OFF`”. If this evaluates to 1, an alarm is raised because the best practice is not being followed.

An expression is made up of one or more variables and zero or more mathematical operators. The MySQL Enterprise Monitor uses the MySQL database server's expression parser and evaluator. For a complete list of operators and functions see <http://dev.mysql.com/doc/refman/5.0/en/functions.html>. For a complete list of the built-in variables used when creating rules see <http://dev.mysql.com/doc/refman/5.0/en/mysqld-option-tables.html>.

Creating an expression is dependent on variables defined in the **VARIABLE ASSIGNMENT** frame. This frame links variables used in the expression field with data gathered from the target MySQL server instance—server status variables, operating system status information, and table information. Variable names are associated with elements in the **DATA ITEM** drop-down list. If you need to define more than one variable simply click the ADD ROW button. For a complete listing of the data collection items used in creating rules see [The Data Collection Items Used to Create Rules](#).

The remaining fields determine the information that displays in a notification email or the informational pop-up window associated with each advisor.

### Note

When saving a new rule ensure that you do not duplicate the name of an existing rule.

## 15.7.4.3. Variables

When an expression is evaluated variables get replaced by values. For example, part of the expression for the “MyISAM Key Cache Has Sub-Optimal Hit Rate” rule calculates the hit rate as follows:

```
100 - ((%Key_reads% / %Key_read_requests%)*100)
```

If the current value of `%Key_reads%` is 4522 and the current value of `%Key_read_requests%` is 125989, the hit ratio assesses to 96.4%:

```
100 - ((4522 / 125989) * 100)
```

By convention, the Advisors supplied by MySQL use ‘%’ as the delimiter, for example, `%Key_reads%`. This makes variables more readily identifiable.

In addition to being used in an expression, variables may also be used in the [Description](#), [Advice](#), [Action](#), and [Links](#) attributes of a rule. This allows you to report the current value of an expression.

For instance, you can add the message, “The current value of Key\_reads is `%Key_reads%`.” to the [Advice](#) text box. When this is displayed on the screen, the value of `%Key_reads%` is substituted into the text. Supposing `%Key_reads%` has a value of 4522, the message becomes “The current value of Key\_reads is 4522.”

## 15.7.4.4. Thresholds

Each expression has a threshold value that triggers an alert. The `THRESHOLD` keyword is used to associate that value with an alert level—either an [Info](#), [Warning](#), or [Critical](#) alert.

For example, the expression for the performance advisor, “Thread Cache Size May Not Be Optimal”, is:

```
100-((%Threads_created% / %Connections%) * 100) < THRESHOLD
```

The `THRESHOLD` is set at 95% for an Info level alert, 85% for a Warning alert, and 75% for a Critical alert; producing alerts of three different levels.

Expressions can be quite simple. The expression for “Binary Logging Not Enabled” (one of the Administration alerts) is:

```
%log_bin% == THRESHOLD
```

When the result is `OFF`, only one alert is triggered—a Warning level alert. In this situation you might think we could just use the expression `%log_bin% == "OFF"`. However, doing this would not test binary logging against a threshold so would not result in an alert.

When you create an expression, think carefully about the conditions under which it should be evaluated and the conditions under which it should not. For example, the expression for the “MyISAM Key Cache Has Sub-Optimal Hit Rate” rule is:

```
(%Uptime% > 10800) && (%Key_read_requests% > 10000) >
&& (100-((%Key_reads% / %Key_read_requests%) * 100) < THRESHOLD)
```

The essence of the rule is really: `(100-((%Key_reads% / %Key_read_requests%) * 100) < THRESHOLD)`. However, when a server is first starting up, it may take a while to reach a state that is representative of normal operations. For example, the key cache and the query cache may need some period of time before they have cached typical application data as opposed to start-up and initialization data. In this case, the first part of the expression, `(%Uptime% > 10800)`, holds off evaluating this expression until the system has been running for 10800 seconds (3 hours).

In addition, if some part of the system is not heavily used an alert may be triggered based on limited data. For example, if your application does not use the MyISAM storage engine, the “MyISAM Key Cache Has Sub-Optimal Hit Rate” rule may be triggered based on very limited use of other MyISAM tables such as the `mysql.user` table. For this reason, this advisor has a second part—`(%Key_read_requests% > 10000)`—meaning the rule won't be evaluated unless there is plenty of activity associated with the key cache.

In other circumstances, there may be periods of time during which you don't want a rule to be evaluated—a blackout period. For example, the expression for the “Slave Too Far Behind Master” rule is: `%Seconds_Behind_Master% > THRESHOLD`. However, suppose you run a backup process between 6 and 7 pm on a replication slave, and it's normal for that slave to get behind the master by an amount more than the `THRESHOLD` during that time. In that case you don't want to receive an alert because the rule violation is expected. You can achieve this by adding the following to the expression: `&& CURTIME() NOT BETWEEN '18:00:00' AND '19:00:00'` In essence, this means “don't trigger an alert between 18:00:00 and 19:00:00 (6 pm and 7 pm)”.

#### 15.7.4.5. Using Strings

String values may appear in the `Expression` or the `Thresholds` text boxes. In both cases, they must be enclosed within quotation marks. For example, the expression for the “Slave I/O Thread Not Running” rule is:

```
(%Slave_running% == "ON") && (%Slave_IO_Running% != THRESHOLD)
```

In similar fashion the `Critical Alerts` threshold text box is set to a value of `"Yes"`.

When the expression is evaluated, either `"OFF"` or `"ON"` will be substituted for `%Slave_running%`, and `"Yes"` or `"No"` for `%Slave_IO_Running%`, depending on the state of your system. If the slave is running but the I/O thread is not, the expression then becomes:

```
("ON" == "ON") && ("No" != "Yes")
```

Without quotation marks this expression would not evaluate to `TRUE` as it should.

#### Note

So that it is interpreted properly, the `==` operator is converted to `=` before being passed to the MySQL expression parser.

#### 15.7.4.6. Wiki Format

When editing or defining a rule, the text entered in the `Problem Description`, `Advice`, `Recommended Action`, and `Links and Further Reading` text boxes may be formatted in Wiki format. This allows you to format text and add hyperlinks when creating or editing your own rules.

Find a brief introduction to using Wiki formatting in the following table.

**Table 15.1. MySQL Enterprise Monitor: Wiki formatting**

Example	Description
<code>__bold__</code>	boldface text
<code>~~italic~~</code>	italicize text
<code>\\</code>	create a line break
<code>\\\</code>	create a double line break
<code>\\\\G</code>	create a backslash
<code>*item 1</code>	create a bulleted list item
<code>#item 1</code>	create a numbered list item
<code>\</code>	use the ‘\’ to escape special characters
<code>{moreInfo:name url}</code>	create a hyperlink

So the following Wiki text:

```
Replication is a __very nice feature__ of MySQL. Replication can be very
useful for solving problems in the following areas:
* Data Distribution
* Load Balancing
* Backup and Recovery
You can check replication status and start a slave using the following
commands: SHOW SLAVE STATUS \G; \G; \START SLAVE;
{moreInfo:MySQL Manual: Replication
FAQ|http://dev.mysql.com/doc/refman/5.0/en/replication-faq.html}
```

Would be translated into the following HTML markup:

```
Replication is a <b>very nice feature</b> of MySQL. Replication can be very
useful for solving problems in the following areas:
<ul>
<li>Data distribution</li>
<li>Load Balancing</li>
<li>Backup and recovery</li>
</ul>You can check replication status and start a slave with the following
commands: SHOW SLAVE STATUS \G;<br/>START SLAVE;
<a href=" ../mysql-monitor-2.0/http://dev.mysql.com/doc/refman/5.0/en/replication-faq.html"
target="_blank" >MySQL Manual: Replication FAQ</a>
```

To find out more about this format go to the [wikipedia.org](http://wikipedia.org) web site.

### 15.7.4.7. Creating a New Rule: An Example

This section documents the steps required to create a rule. Before attempting to create a rule, please review the preceding sections of this chapter.

This example creates a rule that checks the number of rows in a table. Having 50,000 rows in this table is deemed to warrant a critical alert. Lesser numbers are assigned to informational and warning level alerts.

Begin by navigating to the [Advisors](#) tab and clicking the [manage rules](#) link. Then choose the CREATE RULE button.

Create your custom rule by following these steps:

1. Using the [Rule Name](#) text box, give the rule an appropriate name. Something such as "Excessive number of records in [table\\_name](#) table", may be appropriate.
2. From the [Advisor](#) drop down list box choose an advisor group for your rule. The [Administration](#) group of rules might be suitable but if you wish, create your own group of advisors. For instructions on doing this see [Section 15.7.4.1, "Creating Advisors"](#).
3. Enter the following expression in the **EXPRESSION** text area: '%[table\\_name](#)\_num\_rows% > THRESHOLD'. Replace [table\\_name](#) with the name of the table you wish to monitor. Note that the variable %[table\\_name](#)\_num\_rows% has not yet been defined.
4. Set the Thresholds.



- a. Set the **Critical Alert** level to 50000.
  - b. Set the **Warning Alert** level to 10000.
  - c. Set the **Info Alert** level to 5000.
5. Define your variable in the **Variable Assignment** frame.
    - a. In the **Variable** text box enter `'%table_name_num_rows%`, the variable used in the **Expression** text box
    - b. In the **Data Item** drop down list box find and select the `mysql:table:numrows` entry. (For a description of all the data items available see [The Data Collection Items Used to Create Rules](#).)
    - c. In the **Instance** text box enter `database_name.table_name`.
  6. Add appropriate entries for the **Problem Description**, the **Advice**, and the **Links** text areas. If you wish, use Wiki markup for these text areas. See [Section 15.7.4.6, "Wiki Format"](#) for more information. Note that you can also reference the `'%table_name_num_rows%` variable in these text areas. For example, you can display the current number of rows with a message such as `'table_name currently has %table_name_num_rows% rows.'`
  7. Save the rule.

Once the rule is created it needs to be scheduled against the server that contains the database table you wish to monitor. For instructions on scheduling rules see [Section 15.7.2, "Scheduling Rules"](#).

### 15.7.4.8. Creating a Custom Data Collection Item

[Section 15.7.4.7, "Creating a New Rule: An Example"](#) shows how to create a custom rule and [The Data Collection Items Used to Create Rules](#) shows the data items that can be used in rule creation. However, in some circumstances you may want to create a rule that uses a custom data collection item.

This section describes how to create a custom data collection item. The steps are as follows:

1. Create an XML file to define how the data is collected.
2. Point the agent configuration file to this XML file.
3. Restart the agent.

#### 15.7.4.8.1. Creating and Using a Custom Data Item XML File

As an example, this section shows how to create a data item for monitoring the amount of free InnoDB tablespace. The format and content of the XML file that defines the data to be collected is as follows:

```
<?xml version="1.0" encoding="utf-8"?>
<classes>
  <class>
    <classname>innodb_min_free</classname>
    <namespace>mysql</namespace>
    <query><![CDATA[SELECT MIN(substring_index(substring_index(table_comment, " ", 3), " ", -1)/1024/1024)
      as Free FROM INFORMATION_SCHEMA.TABLES WHERE engine = 'InnoDB']]></query>
  </class>
</classes>
```

Save this file as:

- Windows – `C:\Program Files\MySQL\Enterprise\Agent\share\mysql-proxy\items\innodb_min_free.xml`
- Unix – `/opt/mysql/enterprise/agent/share/mysql-proxy/items/innodb_min_free.xml`
- Mac OS X – `/Applications/mysql/enterprise/agent/share/mysql-proxy/items/innodb_min_free.xml`

After saving this file, you must point your `mysql-monitor-agent.ini` file to it. (For the location of this file on your operating system see [Section 15.3.3.6.1, "MySQL Enterprise Monitor Agent \(mysql-monitor-agent.ini\) Configuration"](#).) Find the `[mysql-proxy]` section and add the file name `innodb_min_free.xml` to the `item-files` parameter using a semi-colon as a separator. For example:

```
[mysql-proxy]
...
item-files = items-mysql-monitor.xml,innodb_min_free.xml
...
```

For this change to take effect you must restart the agent. To do this see:

- Windows – [Section 15.3.3.5.1, “Starting/Stopping the Agent on Windows”](#)
- Unix – [Section 15.3.3.5.3, “Starting/Stopping the Agent on Unix”](#)
- Mac OS X – [Section 15.3.3.5.2, “Starting/Stopping the Agent on Mac OS X”](#)

Once the agent has restarted, you will find the new data item in the [Data Item](#) drop down list box on the [Rule Definition](#) page. Its fully qualified name is `mysql:table:innodb_min_free`.

## 15.7.5. Disabling and Uncheduling Rules

In some circumstances you may no longer wish to apply a rule against a specific server or group of servers and in other circumstances you may want to suspend a rule for a short length of time. With this in mind, it is possible to disable or unschedule a rule.

To disable or unschedule an advisor choose the [Current Schedule](#) screen of the [Advisors](#) tab.

Rules may be disabled or unscheduled using the buttons on the upper or lower left of the screen. You may also change a rule by clicking the [enabled](#) or [unschedule](#) hyperlink to the right of a rule. The buttons are particularly useful when you are altering more than one rule.

To no longer run a rule against a specific server, expand the advisor group and the specific rule by clicking the + button. You may then click the UNSCHEDULE button. When the dialog window opens, choose the UNSCHEDULE button and that rule will no longer be applied. If you wish to back out of the operation choose CANCEL. If, at a later date, you wish to institute this rule again, you may do so from the [Add to Schedule](#) page.

If you want to suspend a rule temporarily, use the DISABLE button and follow the same process you would for uncheduling. Once a rule is disabled the link under the status column changes to red and reads [disabled](#). When a rule is disabled, data is no longer collected for that rule. A disabled rule is easily re-enabled by clicking the [disabled](#) link or by using the ENABLE button.

Multiple rules may be altered for one or more servers by selecting the appropriate checkbox and then clicking the UNSCHEDULE, ENABLE, or DISABLE button.

### Note

Rules associated with the heat chart cannot be disabled or unscheduled as they are required by MySQL Enterprise Monitor.

## 15.7.6. Advisor Blackout Periods

Database servers require regular maintenance and during these periods you may wish to stop Monitor Agents from reporting their findings. During a blackout period rules are not evaluated and notifications are put on hold but Monitor Agents continue to collect data. In this respect blacked-out rules differ from disabled rules; data continues to be collected and stored in the repository.

Blackout periods are enabled by entering the following URL into the address bar of your browser, substituting the appropriate host name, port and server name:

```
http://localhost:18080/rest?command=blackout »
&server_name=SuSE:3306&blackout_state=true
```

If you are unsure of the host name and port to use, check the [configuration\\_report.txt](#) file. Be sure to specify the correct port for the Tomcat server. Specify the server you wish to blackout using the name that appears in the Server Tree, being sure to include a colon and port number as shown in the preceding example.

An HTTP authentication dialog box requesting your Dashboard user name and password will open. Specify the administrator's credentials. The default user name is `admin`; use the password you specified when you initially logged in to the Dashboard.

You can also blackout a server group by entering the following URL into the address bar of your browser, substituting the appropriate host name, and server group name:

```
http://localhost:18080/rest?command=blackout »
&group_name=Finance&blackout_state=true
```

When the HTTP authentication dialog box opens, enter the administrator's credentials.

You can confirm that a server is blacked out by looking at the server name in the Dashboard; the name of a blacked out server is greyed.

To reactivate the blacked-out server or server group, use the appropriate URL and query string, changing the `blackout_state=true` name/value pair to `blackout_state=false`. Again, this must be done by a user with administrative privileges.

### Note

Restarting MySQL Enterprise Monitor will **not** reactivate a blacked out server.

## 15.7.6.1. Scripting Blackouts

Rather than opening your web browser and blacking out a server by typing entries into the address bar, you can write a script to achieve the same effect. This section documents a sample blackout script that can be run from the command line.

Create the following file and save it as `blackout.pl`.

```
#!/usr/bin/perl
use LWP 5.64;
# USAGE: blackout.pl servicemanager:18080 admin password servername:3306 true
# $ARGV[0] = management server hostname:port
# $ARGV[1] = management server username
# $ARGV[2] = management server password
# $ARGV[3] = mysqld managed instance server name and port
# $ARGV[4] = blackout state (true/false)
my $browser = LWP::UserAgent->new;
$browser->credentials(
    $ARGV[0],
    '',
    $ARGV[1],
    $ARGV[2]
);
my $url = URI->new('http://'.$ARGV[0].'/rest');
$url->query_form( # And here the form data pairs:
    'command' => 'blackout',
    'server_name' => $ARGV[3],
    'blackout_state' => $ARGV[4]
);
my $response = $browser->post( $url );
if (!$response->is_success) {
    die $response->status_line . "\n";
}
```

### Note

Windows users can omit the shebang line.

On Unix systems use the `chmod +x blackout.pl` command to make the file executable.

At the command line enter `blackout.pl servicemanager:18080 admin password servername:3306 true`.

If you are unsure of the host name and port to use, check the `configuration_report.txt` file. Be sure to specify the correct port for the Tomcat server. Specify the server you wish to blackout using the name that appears in the Server Tree, being sure to include a colon and port number as shown in the preceding example. Make sure that the user you specify is a "manager". Specifying a user with "dba" rights only will not black out a server and no error will be displayed.

You can confirm that a server is blacked out by looking at the server name in the Dashboard; the name of a blacked out server is greyed. To end the blackout, run the same script, changing the final argument to `false`.

### Note

Restarting MySQL Enterprise Monitor will **not** reactivate a blacked out server.

## 15.8. The Events Page

### Note

MySQL Enterprise subscription, MySQL Enterprise Monitor, MySQL Replication Monitor, and MySQL Query Analyzer are only available to commercial customers. To learn more, see: <http://www.mysql.com/products/enterprise/features.html>.

Once an advisor has been scheduled, it will run at set intervals. If it finds nothing of interest no alerts or emails will be created.

When alerts are triggered, they appear on the [Events](#) screen. Alerts also appear on the [Monitor](#) screen in order of severity. The notification group or groups associated with a specific rule receive email notification when an alert is triggered. For more information about creating notification groups see [Section 15.6.5, “Manage Notification Groups”](#).

To view open events, click on the [Events](#) tab. The tree-view on the left determines which server or server group these events belong to. Open events are shown in tabular format.

**Figure 15.44. MySQL Enterprise Dashboard: Events screen**

Severity	From	To	Advisors	Rules
All			All Categories	All
Status	Limit			
All	20	filter	reset	

<input type="checkbox"/>	Severity	Server	Advisor	Rule	Time	Status	
<input type="checkbox"/>		susieQ:3306	Heat Chart	CPU I/O Usage Excessive	2/22/2007 12:51 PM	Open	close
<input type="checkbox"/>		susieQ:3306	Heat Chart	CPU Usage Excessive	2/22/2007 12:35 PM	Open	close
<input type="checkbox"/>		susieQ:3306	Heat Chart	RAM Usage Excessive	2/22/2007 11:35 AM	Open	close
<input type="checkbox"/>		susieQ:3306	Heat Chart	MySQL Agent Not Reachable	2/22/2007 7:01 AM	Open	close
<input type="checkbox"/>		susieQ:3306	Heat Chart	Table Scans Excessive	2/21/2007 8:24 PM	Open	close
<input type="checkbox"/>		susieQ:3306	Security	Users Can View All Databases On MySQL Server	2/21/2007 8:20 PM	Open	close
<input type="checkbox"/>		susieQ:3306	Security	Server Includes A Root User Account	2/21/2007 8:20 PM	Open	close
<input type="checkbox"/>		susieQ:3306	Security	Server Has Anonymous Accounts	2/21/2007 8:20 PM	Open	close

The event table has the following columns:

- **SEVERITY** – An icon indicating the severity of the alert
- **SERVER** – The name of the server the alert applies to
- **ADVISOR** – The category of the advisor
- **RULE** – A short description of the rule that has been violated
- **TIME** – The approximate time the event occurred
- **STATUS** – The status of the event
- **UNNAMED COLUMN** – Provides a link to the [Close](#) dialog box

By default, all events are shown but the list of events can be filtered using the form displayed above the event list. The options include filtering by:

- Severity
- Date
- Advisor group
- Specific rule
- Status

Choose the options you are interested in and click the **FILTER** button to refresh the display. You may limit the number of items that appear on a page by choosing a different value from the **LIMIT** drop down listbox.

The drop down list box showing severity has the options: [All](#), [Alerts](#), [Critical](#), [Warning](#), [Info](#), [Success](#), and [Unknown](#). Selecting the option [All](#) shows all alerts and also those rules that have run successfully. A successful rule is one that has not been violated and is indicated by a star icon. [Alerts](#) shows only those rules that have been violated.

Columns are sorted by clicking on the individual column headings. The alerts shown in [Figure 15.44, “MySQL Enterprise Dashboard: Events screen”](#), are sorted by decreasing severity. An octagonal red icon indicates a critical alert, a triangular yellow icon a

warning, and a conversation bubble an informational alert. A star beside an event indicates that the rule has run successfully and no alert created. A question mark icon indicates that the status of the rule is unknown.

The server shown in [Figure 15.44, “MySQL Enterprise Dashboard: Events screen”](#), is filtered for **All**. Typically, when filtering by severity you would choose **Alerts** and, if you see a **Critical**, **Warning**, or **Info** alert, use the **All** filter to see when the rule last ran successfully. This may assist in determining the cause of the alert.

Besides filtering for severity, you can also choose to filter for a specific time period using the **From** and **To** text boxes. You also have the choice of filtering by specific rules or categories of rules. The **Status** drop-down list box let's you choose **All**, **Open**, or **Closed** events. To avoid excessive scrolling, you can also limit the number of events that show on a specific page.

For more information about an alert, click on the rule name. A pop-up window will appear showing a description of the alert and the exact time of occurrence. This pop-up windows provides links to useful resources and advice for resolution. You can also view the exact expression that generated the event.

### 15.8.1. Closing an Event

After determining what action to take, events should be closed.

To resolve an individual alert click the **close** link in the **OPERATIONS/NOTES** column. Document the resolution using the **Notes** text area and choose the **CLOSE EVENT(S)** button.

To close a number of alerts simultaneously, select the checkbox beside the alerts you wish to close and then click the **CLOSE** button to the lower or upper left side of the screen.

Once an event has been closed it appears on the **Events** screen showing a **resolution notes** link. Click this link to review the notes. Events that have been closed are saved in the Repository. If you wish to view closed events filter the display by choosing **Closed** from the **STATUS** drop-down box.

## 15.9. The Graphs Page

### Note

MySQL Enterprise subscription, MySQL Enterprise Monitor, MySQL Replication Monitor, and MySQL Query Analyzer are only available to commercial customers. To learn more, see: <http://www.mysql.com/products/enterprise/features.html>.

Navigate to the **Graphs** page by choosing the **GRAPHS** tab.

By default four graphs are displayed on the **Monitor** page. These graphs present information about the currently selected server or server group, showing the hit ratios, CPU utilization, connections, and database activity. Color coding helps distinguish different aspects of each graph.

From the **Monitor** page you can make permanent or temporary changes to the way a graph is displayed. For example, you can choose to display the last hour's activity or you can choose to view a specific period of time.

Persistent changes to the way the graphs display are only made from the **Monitor** page. You can set the size of the thumbnails and the full-sized graphs and you can also set their refresh interval. For more information, see [Section 15.5.2, “The Server Graphs and Critical Events”](#). As with the **Monitor** page, the data shown in the graphs is determined by the server or group of servers selected in the server tree.

The **Graphs** page shows all the available graphs and provides the capability of adjusting the scale of the graphs, allowing a more or less detailed view as the situation requires. To ensure that you have the latest versions of the various graphs click on the **CHECK FOR UPDATES** link on the top left of this page.

### 15.9.1. Displaying Graphs

The total number of graphs varies depending upon your subscription level. The four graphs that appear by default on the **Monitor** page are:

- Hit Ratios
- Database Activity
- Connections
- CPU Utilization

When the [Graphs](#) page is first opened, no graphs are visible. To view a graph click the + button on the left or, to view all graphs, use the EXPAND ALL button.

The larger size of graphs is the primary reason for viewing graphs on the [Graphs](#) page rather than on the [Monitor](#) page. Additionally, you can only show a maximum of six graphs on the [Monitor](#) page; the remaining graphs can only be viewed from the [Graphs](#) page.

## 15.9.2. Setting an Interval

Change the interval for a graph by choosing values from the **HOURS** and **MINUTES** drop-down list boxes. If necessary adjust the width and height of the graph and then click the UPDATE button. The changes to the time span apply to all the graphs on the [Graphs](#) page but have *no* effect on the graphs on the [Monitor](#) page.

To change the graphs both here and on the [Monitor](#) page use the [configure graphs](#) link on the top right. This opens a dialog box for setting the default interval for the x-axis. Save any changes that you have made and the values chosen will be the defaults whenever you log in. You can also change the defaults from the [Monitor](#) page as described in [Section 15.5.2, “The Server Graphs and Critical Events”](#); defaults for other users will be unchanged.

Use the RESET button to restore the default value for the interval. Doing this will also reset the default size of the graphs.

## 15.9.3. Setting a Time Span

Setting a graph to display a time span gives you a historical perspective on server activity. You may want to know what was happening at a specific point in time or you may wish to look at an extended period in order to determine patterns or trends. Changing the time span gives you the flexibility to do this.

In the **TIME DISPLAY** drop-down list box select the [From/To](#) option. Choosing this option updates the display to include **TO** and **FROM** text boxes.

Set the date you wish to start viewing from by manually entering the date in year, month, and day format (2007-03-14). However, it is much easier to click the calendar icon and choose a date from the drop-down calendar. Enter a terminating date in the same way. If you wish, you may also choose the specific time of day by selecting the hour and minute.

If necessary adjust the width and height of the graph and then click the UPDATE button. The changes to the time span apply to all the graphs on the [Graphs](#) page but have *no* effect on the graphs on the [Monitor](#) page. You cannot change the time span of the graphs that appear on the [Monitor](#) page. Changes apply only to the current user; defaults for other users will be unchanged.

Use the RESET button to cancel your changes.

## 15.10. The Query Analyzer Page

### Note

MySQL Enterprise subscription, MySQL Enterprise Monitor, MySQL Replication Monitor, and MySQL Query Analyzer are only available to commercial customers. To learn more, see: <http://www.mysql.com/products/enterprise/features.html>.

Query Analyzer enables you to monitor the statements being executed on a monitored server and retrieve information about the query, number of executions and the execution times of each query. Queries are normalized, so that the unique data defined within each query has been removed. By removing the data specific elements of the queries, the generic queries can be counted and identified more easily.

### Important

After this release is pronounced Generally Available, the MySQL Agent will be ready for use in your production systems; however, we strongly recommend reading these guidelines before using/deploying MySQL Query Analyzer.

MySQL Query Analyzer is designed to gather query performance information from a variety of sources. In this initial release, Query Analyzer uses a new agent plug-in to proxy your queries and collect performance data that is then transmitted to the Enterprise Monitor. This is a new role for the Agent: it is no longer just monitoring, it is now *\*optionally\** between your MySQL client application and the mysql server.

Depending upon your system load, it is possible to overload the proxy or have the proxy/agent consume system resources needed by mysql itself. In particular, the memory needed by the MySQL Agent for basic monitoring is fairly small and consistent and depends on the number of rules you have enabled. However, when the Query Analyzer is enabled, the Agent can use significantly more memory to monitor and analyze whatever queries you direct through it. In this case, the amount of memory used depends on the number of unique normalized queries, example queries and example [EXPLAINs](#) being processed plus the network bandwidth required to send this query performance data to the



Service Manager. In general, the amount of memory used for the Query Analyzer is well-bounded, but under heavy load or, in some cases under older versions of linux, RAM usage by Query Analyzer may be too high for your environment and load.

Therefore we advise you to use this initial release of Query Analyzer extensively in development, test and stage environments under load for an extended period of time before considering usage in a production environment. For all deployments:

1. We recommend carefully monitoring the Agent's resource consumption using the new graph **MEMORY USAGE - AGENT** graphs available on the **GRAPH** tab. You can also add an SMTP or SNMP notification to the new Heat Chart rule **MYSQL AGENT MEMORY USAGE EXCESSIVE**.
2. If the amount of memory consumed is too high, consider sampling queries during non-peak hours or monitoring only a subset of queries on this system.

If you experience any problems with Query Analyzer, we're interested in working with you closely and quickly to resolve them. Please open a Support issue right away. We're already working hard on optimizing Agent/proxy RAM usage and are planning a series of rapid releases to quickly distribute these and other improvements to you.

Query Analyzer works by intercepting the SQL statements that your MySQL client application sends to the MySQL server. Instead of connecting direct to the MySQL Server, queries are routed through the MySQL Enterprise Monitor Agent, the agent/proxy forwards the queries on to the server and sends the replies back to the client application as normal. In addition to forwarding the queries, the agent/proxy will also normalize the queries and then supply the execution information about each query to the monitor. The forwarding functionality is provided by the same module that supports the MySQL Proxy application. For information on MySQL Proxy, see [Section 14.6, "MySQL Proxy"](#).

### Important

The MySQL Proxy component, and Query Analyzer, require that clients connecting through MySQL Enterprise Monitor Agent are using MySQL 5.0 or later. Clients that use the library provided with MySQL 4.1 or earlier will not work with MySQL Enterprise Monitor Agent.

Once your MySQL client application has been configured to communicate via the MySQL Enterprise Monitor Agent, queries will be monitored and the simplified queries, without the query specific data, will be sent to the MySQL Enterprise Monitor Agent.

There are a number of different ways that you can enable Query Analysis. For more information on the different options, see [Section 15.10.1, "Enabling Query Analyzer"](#).

To analyse the queries captured by the agent/proxy, change to the [Query Analyzer](#) page. You can see an example of the table on that page in the figure below.

**Figure 15.45. MySQL Enterprise Dashboard: Query Analyzer**

Query	Database	Exec Count	Exec Time (hh:mm:ss.ms)			Rows			Bytes			First Seen
			Total	r Max	Avg	Total	Max	Avg	Total	Max	Avg	
SELECT COUNT( message_i... process_type , fmtime (1)	intranet_mcslp	6	12.838	11.123	2.140	776	408	129	24.21 KB	12.8 KB	4.04 KB	10:35:01 AM
SELECT inhost , path , ...GROUP BY fmtime , path (1)	intranet_mcslp	2	0.906	0.686	0.453	4,038	2,526	2,019	230.89 KB	142.05 KB	115.44 KB	10:34:01 AM
SELECT process_mode , p...ess_mode , process_type (1)	intranet_mcslp	6	1.674	0.333	0.279	36	7	6	808 B	165 B	134.67 B	10:37:01 AM
SELECT media_photo . ph...RDER BY RAND( ) LIMIT ? (1)	intranet_mcslp	1	0.259	0.259	0.259	30	30	30	282 B	282 B	282 B	10:37:01 AM
SELECT process_mode , p...ess_mode , process_type (1)	intranet_mcslp	1	0.241	0.241	0.241	8	8	8	189 B	189 B	189 B	10:33:01 AM
SELECT data , COUNT( DI...P BY data ORDER BY data (1)	intranet_mcslp	1	0.217	0.217	0.217	195	195	195	3.06 KB	3.06 KB	3.06 KB	10:39:01 AM
SELECT DISTINCT( media... , photoid DESC LIMIT ? (1)	intranet_mcslp	25	1.781	0.209	0.071	250	10	10	2.44 KB	100 B	100 B	10:38:01 AM
SELECT DISTINCT( album ...RDER BY RAND( ) LIMIT ? (1)	intranet_mcslp	1	0.193	0.193	0.193	10	10	10	594 B	594 B	594 B	10:37:01 AM
INSERT INTO currencies ...ALUES ( ? , ? , ? , ? ) (1)	intranet_mcslp	5	0.109	0.105	0.022	5	1	1	0 B	0 B	0 B	10:31:01 AM
SELECT COUNT( DISTINCT(...oto_meta WHERE type = ? (1)	intranet_mcslp	1	0.095	0.095	0.095	1	1	1	8 B	8 B	8 B	10:37:01 AM
SELECT COUNT( videoid )... ) ) AND last_view > ? (1)	intranet_mcslp	5	0.100	0.091	0.020	5	1	1	35 B	7 B	7 B	10:37:01 AM
INSERT INTO stocks ( da...ALUES ( ? , ? , ? , ? ) (1)	intranet_mcslp	2	0.078	0.071	0.039	2	1	1	0 B	0 B	0 B	10:31:01 AM
SELECT * FROM statmon_m...e_disk WHERE statid = ? (1)	intranet_mcslp	92	3.202	0.066	0.035	345	9	4	15.25 KB	431 B	169.75 B	10:31:01 AM
SELECT SUM( data ) , CO... media_video . type = ? (1)	intranet_mcslp	2	0.082	0.064	0.041	2	1	1	33 B	17 B	16.5 B	10:37:01 AM
SELECT media_photo . ph...RDER BY RAND( ) LIMIT ? (1)	intranet_mcslp	24	0.231	0.061	0.010	1,206	150	50	10.91 KB	1.37 KB	465.58 B	10:38:01 AM
SELECT DISTINCT( machin...DATE( ) , logtime ) < ? (1)	intranet_mcslp	23	0.786	0.055	0.034	92	4	4	575 B	25 B	25 B	10:31:01 AM
INSERT INTO markets ( d...ALUES ( ? , ? , ? , ? ) (1)	intranet_mcslp	7	0.057	0.047	0.008	7	1	1	0 B	0 B	0 B	10:31:01 AM
SELECT DISTINCT( media...RDER BY RAND( ) LIMIT ? (1)	intranet_mcslp	1	0.042	0.042	0.042	60	60	60	2.29 KB	2.29 KB	2.29 KB	10:37:01 AM
SELECT COUNT( DISTINCT(...st ) ) FROM media_audio (1)	intranet_mcslp	1	0.033	0.033	0.033	1	1	1	9 B	9 B	9 B	10:37:01 AM
SELECT ( COUNT( DISTINC... * ? ) ) FROM media_audio (1)	intranet_mcslp	2	0.065	0.033	0.032	2	1	1	25 B	13 B	12.5 B	10:37:01 AM

The main Query Analyzer table provides the summary information for all of the queries executed via the agent/proxy. The table will track all the queries submitted to the server via the agent/proxy. The table will show a maximum of 20 rows, and you can page through the list of queries by using the page numbers, or the **NEXT**, **PREVIOUS**, **FIRST**, and **LAST** buttons. To filter the list of queries that are displayed, or to change the number of queries, see [Section 15.10.3, “Filtering Query Analyzer Data”](#).

Each row within the table provides the statistical information for one normalized query statement. If you have configured multiple agent/proxies to accept and forward queries to different servers, then you can expand the server view. The summary information displayed is different depending on whether you have selected a server group or an individual server.

If you have selected a server group, then the information displayed is aggregated from across the entire group. The same query executed on multiple servers will show average, total and minimum/maximum information for that query across all the servers. If you select an individual server, then only queries executed on that server are included within the table.

For each row, the following columns are populated according to the selected filtering options. For example, if the filter have been configured to show queries within the last 30 minutes (**INTERVAL**), then only queries executed during that time will be displayed, and the corresponding statistics, such as execution times, rows returned and bytes returned will be according to that 30 minute timespan.

- **QUERY** — the normalized version of the query. Normalization removes the query-specific data so that different queries with different data parameters are identified as the same basic query.

The information is shown as one query per row. Each query row is expandable, and can be expanded to show the execution times for individual servers for that query.

- **DATABASE** — the name of the database used in the query. The column may be blank if the database name has not been explicitly stated within the query.
- **EXEC COUNT** — the number of times that the query has been executed.
- **EXEC TIME** — the execution time for all the matching queries. This is the time, for every invocation of the corresponding query, as calculated by comparing the time when the query was submitted and when the results were returned by the server. Times are expressed in HH:MM::SS.MS (hours, minutes, seconds, and milliseconds).

The **EXECUTION** column is further subdivided into the following columns:

- **COUNT** — the total number of executions.
- **TOTAL** — the cumulative execution time for all the executions of this query.
- **MAX** — the maximum execution time for an execution of this query.
- **AVG** — the average execution time for the execution of this query.

When looking at the information provided in this query, you should consider comparing the average and maximum execution times to see if there was a problem on a specific server or during a specific time period when the query took place, as this may indicate an issue that needs to be investigated. For more information, see [Section 15.10.4, “Using Query Analyzer Data”](#).

- **ROWS** — the rows returned by the query. The column is sub-divided into the following columns:
  - **TOTAL** — the sum total number of rows returned by all executions of the query.
  - **MAX** — the maximum number of rows returned by a single execution of the query.
  - **AVG** — the average number of rows returned by all executions of the query.
- **BYTES** — the number of bytes returned by each query. The column is sub-divided into the following columns:
  - **TOTAL** — the sum total bytes returned by all executions of the query.
  - **MAX** — the maximum number of bytes returned by a single execution of the query.
  - **AVG** — the average number of bytes returned by all executions of the query.
- **FIRST SEEN** — the first time the query was seen within the given filter conditions.

You can sort the list of queries by clicking on the column name. The direction of the sort (highest to lowest, or lowest to highest) is indicated by a triangle next to the currently selected column. The default is to sort the list of queries by the Total Execution time.

### 15.10.1. Enabling Query Analyzer



There are three different ways of enabling query analyzer:

- Change your MySQL client application to talk to the Proxy port you configured during installation. This requires changing your MySQL client application code, and may require that you stop and restart your MySQL client application, but does not require any changes to your MySQL server. For more information, see [Section 15.10.1.1, “Enabling Query Analyzer by Changing the MySQL Client Application”](#).
- Change your MySQL server to listen on a different port, and configure the Agent/proxy to listen on the original MySQL server port. This does not require any changes to your MySQL client application, but will require shutting down and restarting your MySQL server, which may affect your cache and performance. For more information, see [Section 15.10.1.2, “Enabling Query Analyzer by Changing MySQL Server”](#).
- Use IP tables to redirect the network packets to the agent/proxy.

### Important

After this release is pronounced Generally Available, the MySQL Agent/proxy will be ready for use in your production systems; however, we strongly recommend reading these guidelines before using/deploying MySQL Query Analyzer.

MySQL Query Analyzer is designed to gather query performance information from a variety of sources. In this initial release, Query Analyzer uses a new agent plug-in to proxy your queries and collect performance data that is then transmitted to the Enterprise Monitor. This is a new role for the Agent: it is no longer just monitoring, it is now \*optionally\* between your MySQL client application and the mysql server.

Depending upon your system load, it is possible to overload the proxy or have the proxy/agent consume system resources needed by mysql itself. In particular, the memory needed by the MySQL Agent for basic monitoring is fairly small and consistent and depends on the number of rules you have enabled. However, when the Query Analyzer is enabled, the Agent can use significantly more memory to monitor and analyze whatever queries you direct through it. In this case, the amount of memory used depends on the number of unique normalized queries, example queries and example [EXPLAINs](#) being processed plus the network bandwidth required to send this query performance data to the Service Manager. In general, the amount of memory used for the Query Analyzer is well-bounded, but under heavy load or, in some cases under older versions of linux, RAM usage by Query Analyzer may be too high for your environment and load.

Therefore we advise you to use this initial release of Query Analyzer extensively in development, test and stage environments under load for an extended period of time before considering usage in a production environment. For all deployments:

1. We recommend carefully monitoring the Agent's resource consumption using the new graph **MEMORY USAGE - AGENT** graphs available on the **GRAPH** tab. You can also add an SMTP or SNMP notification to the new Heat Chart rule **MYSQL AGENT MEMORY USAGE EXCESSIVE**.
2. If the amount of memory consumed is too high, consider sampling queries during non-peak hours or monitoring only a subset of queries on this system.

If you experience any problems with Query Analyzer, we're interested in working with you closely and quickly to resolve them. Please open a Support issue right away. We're already working hard on optimizing Agent/proxy RAM usage and are planning a series of rapid releases to quickly distribute these and other improvements to you.

Note that you must have enabled Query Analyzer within the agent/proxy during installation. If you did not enable Query Analyzer during the installation of the agent/proxy, check the following elements within the main `mysql-monitor-agent.ini` configuration file:

- Add the `proxy` plugin to the `plugins` parameter:

```
plugins=proxy,agent
```

- Ensure that the `quan.lua` items file is enabled in the `agent-item-files` configuration property:

```
agent-item-files = share/mysql-proxy/items/quan.lua,share/mysql-proxy/items/items-mysql-monitor.xml
```

- Check and set the `proxy-address`, `proxy-backend-addresses`, and `proxy-lua-script` settings are configured:

```
proxy-address=:4040
proxy-backend-addresses = 127.0.0.1:3306
```

```
proxy-lua-script = share/mysql-proxy/luan.lua
```

For more information on these configuration options, see [Section 15.3.3.6.1, “MySQL Enterprise Monitor Agent \(mysql-monitor-agent.ini\) Configuration”](#).

### Note

The Query Analyzer functionality may show as being enabled on a server, even though the modules within MySQL Enterprise Monitor Agent may not have been enabled.

You may also need to make some additional changes to the security configuration on your server to ensure that queries are correctly reported to MySQL Enterprise Service Manager:

- You must ensure that each user configured within your MySQL client application that connects through the agent/proxy and is required to report query analyzer information is allowed to connect to the server from the host on which the agent/proxy is running. When the user connects to the agent/proxy, and the agent/proxy connects to the server the host of the agent/proxy will be used as the identifying client host name during the connection.

To update your user credentials, you need to use the [GRANT](#) statement. For example:

```
mysql> GRANT SELECT,UPDATE,INSERT on database.* to 'user'@'localhost' IDENTIFIED BY 'password';
```

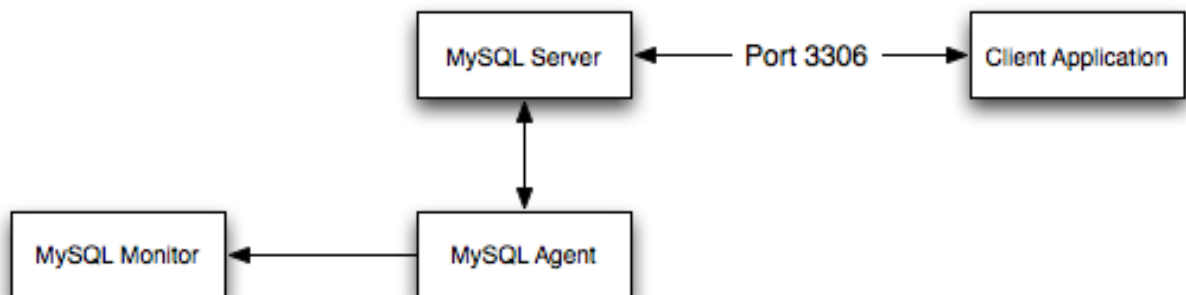
- The MySQL client application user must have [SELECT](#) privileges on the `mysql.inventory` table. This table contains the server UUID and is required to report the query analyzer data to the MySQL Enterprise Service Manager. To enable this, use the [GRANT](#) option:

```
mysql> GRANT SELECT on mysql.inventory to 'user'@'localhost' IDENTIFIED BY 'password';
```

### 15.10.1.1. Enabling Query Analyzer by Changing the MySQL Client Application

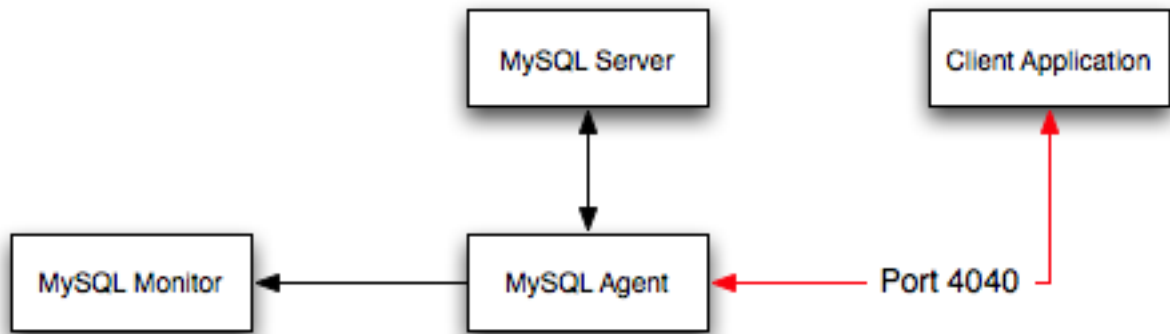
Generally, changing your MySQL client application is the easiest and recommended method. For example, given a typical structure like the one shown in the figure below, the client application would need to be modified so that it no longer communicated directly with the MySQL server, but to the agent/proxy.

**Figure 15.46. MySQL Enterprise Dashboard: Standard agent/monitor topology**



You can see an example of the structure when communicating via the agent/proxy below.

**Figure 15.47. MySQL Enterprise Dashboard: Query Analyzer agent/monitor topology**



To enable query analyzer within your MySQL client application:

1. Make sure that the MySQL Enterprise Service Manager and your MySQL Enterprise Monitor Agent are configured and running.
2. Confirm the configuration of your agent by examining the contents of the `etc/mysql-monitor-agent.ini` file within your installed Agent directory.

Queries will be sent to the host specified in the `proxy-backend-addresses` parameter, and the agent will listen for connections to be redirected to the server on the host name and port configured in the `proxy-address` parameter.

3. Now modify your MySQL client application to communicate with the address specified in the `proxy-address` parameter.

Alternatively, if you do not want to modify your application directly, you can use iptables or firewall rules to redirect queries from the original host/port combination to the agent's port.

Because connections to the MySQL server will be coming from the agent/proxy, not the original host, the user credentials used must be have a suitable `GRANT` statement for connections from `localhost`, or the host on which the agent/proxy is executing. The user name and password information will be passed on directly through the agent/proxy from the client to the server.

4. Confirm that your MySQL client application still operates normally. There should be no difference between communicating directly with the MySQL server and communicating via the agent/proxy.

### Note

If you are using the `mysql` client to connect to the agent/proxy and your backend servers, make sure that you are communicating with the proxy over the right port. By default, if you specify `localhost` as the host name, then `mysql` will connect using the local Unix domain socket, rather than the TCP/IP socket.

You can enforce `mysql` to use the right port either by explicitly requesting the protocol type, or by using the IP address rather than `localhost`. For example, both of these command lines will start the client using the right protocol:

```
shell> mysql --port=4040 --protocol=tcp
shell> mysql --port=4040 --host=127.0.0.1
```

### Note

It is recommended that you use one agent/proxy per MySQL server instance. The agent/proxy is not able to forward queries to multiple MySQL server backends.

## 15.10.1.2. Enabling Query Analyzer by Changing MySQL Server

When enabling Query Analyzer by changing the MySQL Server, you need to shutdown your server, edit the MySQL configuration file, and then restart MySQL. You will also need to change your Agent/proxy configuration so that the Agent/proxy is listening on the original MySQL TCP/IP port. To use this method:

1. Edit the `/etc/my.cnf` or other MySQL configuration file and change or add the `port` setting from it's current value (default 3306), to another value. For example:

```
port = 3307
```

2. Shutdown your MySQL Server.
3. Startup your MySQL Server and confirm that is running.
4. Edit your MySQL Enterprise Monitor Agent configuration so that the agent/proxy is listening for connections on the original MySQL port:

```
proxy-address=:3306  
proxy-backend-addresses = 127.0.0.1:3307
```

5. Stop and restart MySQL Enterprise Monitor Agent.

You should now be able to connect to your MySQL server through the MySQL Enterprise Monitor Agent by connecting on the original port:

```
shell> mysql --host=127.0.0.1
```

## 15.10.2. Getting Detailed Query Information

If you click on an individual query, a pop-up window will provide more detailed information about the individual query. You can see an example of this in the figure below. The available tabs within this window will depend on whether you have configured the more detailed query information. By default, you will always be provided the Summary Details page. If enabled, you may also view Example Details, which provide more detailed data about a specific query, including the data and parameters submitted. In addition, you may also enable Example Explain, which provides you with the ability to remotely execute an [EXPLAIN](#) statement with the specified query and view the resulting information.

- The **Canonical Query** tab:

**Figure 15.48. MySQL Enterprise Dashboard: Canonical Query Tab for a Query**

Canonical Query
Example Query
Explain Query
908 B
165 B
1

Overview of information collected and aggregated for queries of this form.

**Alias**  
None specified.

**Canonical Form**  
[truncated](#) | [full](#) | [formatted](#)

---

```

SELECT
  COUNT( message_id ) AS cnt,
  DATE_FORMAT(FROM_UNIXTIME(datetime), ?) AS
  fmtdate
, process_mode, process_type
FROM
  logs_amavis
WHERE
  datetime >= ? AND datetime <= ?
GROUP BY
  process_mode ASC, process_type ASC, fmtdate
ASC

```

---

**Execution Time Statistics**

Max Time	Min Time	Avg Time	Total Time	Standard Deviation
11.123	0.274	2.140	12.838	

**Row Statistics**

Max Rows	Min Rows	Avg Rows	Total Rows	Standard Deviation	Total Size	Max Size
408	37	129	776	82	24.21 KB	12.8 KB

**Number of Executions**  
6

**Time Span**  
From Oct 27, 2008 10:16:07 AM to Oct 27, 2008 10:46:07 AM.

[expand »](#)

In addition to the summary information given in the table, you will get detailed execution statistics, including the minimum time, maximum time, average time, total time and the standard deviation. The standard deviation will enable you to determine whether a particular invocation of a query is outside the normal distribution of times for the given query.

Row statistics provide more detailed contents on the maximum, minimum, average, total, and standard deviation for the number of rows returned by the query, and the total size and maximum size of the data returned. The time period for the total and average figures is shown under the Summary Time Span.

The detailed view for a query also provides three different views of the query. The [truncated](#) version is a shortened version of the query. The [full](#) version of the query is the entire query statement. Normalization removes the constants from the indi-

vidual queries so that queries following the same logical structure are identified as the same basic query.

To close the query detail window, click the HIDE button.

To simplify the identification of a given query, you can create a query alias. The alias will be used in place of the normalized query text within the Query Analyzer table. To create an alias for a query, click the CREATE ALIAS link against the query. The maximum length for a query alias is 255 characters.

- The **Example Query** tab:

**Figure 15.49. MySQL Enterprise Dashboard: Example Query Tab for a Query**

Canonical Query	Example Query	Explain Query	908 B	165 B	134.
<p>The query with the longest execution time during the Time Span (usually the slowest but not always).</p> <p><b>Sampled Query</b>  <a href="#">truncated</a>   <a href="#">full</a>   <a href="#">formatted</a></p> <hr/> <pre> SELECT   COUNT( message_id ) AS cnt,   date_format( from_unixtime( datetime ), "%Y-%m-%d" )   AS fmtdate , process_mode, process_type FROM   logs_amavis WHERE   datetime &gt;= 1224498843 and datetime &lt;= 1225080000 GROUP BY   process_mode ASC, process_type ASC, fmtdate ASC </pre> <hr/> <p><b>Execution Time</b> 11,122 ms</p> <p><b>Date</b> Oct 27, 2008 10:35:01 AM</p> <p><b>User</b> root</p> <p><b>Thread ID</b> 298107</p> <p><b>From Host</b> 192.168.0.2:22717</p> <p><b>To Host</b> 127.0.0.1:3306</p> <p><b>Comments</b></p> <p style="text-align: right;"><input type="button" value="hide"/></p> <p style="text-align: right;"><a href="#">expand »</a></p>					

The Example Details tab provides detailed information about the most expensive query executed, as determined by the execution time.

In addition to the full query, with data, that was executed, the tab shows the execution time, data, user, thread ID, client host and execution host for the given query.

- The **Explain Query** tab:

**Figure 15.50. MySQL Enterprise Dashboard: Explain Query Tab for a Query**

id	select_type	table	type	possible_keys	key	key_len	ref	rows	extra
1	SIMPLE	logs_amavis	index	null	mdatetimepmt	47	null	276087	Using where; Using index; Using temporary; Using filesort

The Example Explain tab enables you to view the output from running the query with the `EXPLAIN` prefix. For more information, see [Section 12.3.2, “EXPLAIN Syntax”](#).

### 15.10.3. Filtering Query Analyzer Data

You can filter the queries shown within the Query Analyzer table by using the form at the top of the table. The different fields of the form are used to specify the parameters for the filter process. Once you have specified a filter, all the queries and related statistics shown within the Query Analyzer table are displayed in relation to the filter settings. For example, by default, the filter settings show the queries for the last 30 minutes. All the statistics shown are relative to the last 30 minutes, including average, maximum and execution counts.

The filter fields are:

- **SEARCH TYPE** and **QUERY SEARCH** support text searching of the normalized query. For the search type you can specify either a basic text match, or a regular expression match. In addition to the basic text match, you can also search for a query that does not contain a particular string. For regular expression searches, you can specify whether the regular expression should match, or not match (negative regexp) the queries. Regular expressions are parsed using the standard MySQL `REGEXP ( )` function. For more information, see [Section 11.4.2, “Regular Expressions”](#).

#### Note

The search is performed against the canonical version of the query. You cannot search against specific text or values within the parameters of the query itself.

- **DATABASE** — limit the queries to those executed within a specific database. The database match is performed using the `LIKE` match from the MySQL database, hence you can use the `%` and `_` characters to multiple and single character matches. For more information, see [Section 3.3.4.7, “Pattern Matching”](#).
- The **TIME DISPLAY** menu selects whether the time selection for filtering should be based on the time **INTERVAL** (only queries recorded within the displayed time period are shown, using the **HOURS** and **MINUTES** popup), or whether the selection should be based on a time period (**FROM/TO**), where you can select the time range to be displayed.

Using the **INTERVAL** mode shows queries within the given time period from the point the graph was updated. For example, if you select 30 minutes, then the queries shown were captured within the last 30 minutes. If you updated the display at 14:00, then the queries displayed would have been captured between 13:30 and 14:00. Using interval mode limits the timespan for the filter selection to a maximum of 23 hours and 59 minutes.

Using the **FROM/TO** mode enables you to show queries between specific dates and times. Using this mode you can show only the queries received during a specific time span, and you can display the query history for a much longer time period, for as long as you have been recording query analysis information.

- The **VIEW** selection determines whether the information should be returned on a group basis, where an aggregate of the same query executed on all monitored servers is shown, or on a **SERVER** basis, where queries are summarized by individual server. If the latter option has been selected, the table includes an additional column showing the server.

- **QUERY TYPE** lets you select the type of query on which to filter queries. Selecting **ALL** will show all queries. Additional query types you can select include **SELECT**, **INSERT**, **UPDATE** and other main SQL query types.
- **LIMIT** specifies the number of queries to be displayed within each page.

When you have set your filter parameters, you can update the Query Analysis display by clicking the **FILTER** button. To reset the fields to the default settings click the **RESET** button.

## 15.10.4. Using Query Analyzer Data

The information provided by Query Analyzer can be complex to understand and resolve into simple targets and resolutions for your MySQL client application. The information can be used in different ways to find problems in your queries or your servers, or both. Provided below are some tips on how to get the best out of the Query Analysis interface, and how to identify different queries and problems based on the information shown by the Query Analyzer system.

First, consider the information provided by individual columns by your queries. In particular, the following columns can highlight specific problems with your queries or database server:

- **Execution Count** — High execution counts, especially for a query that you expect to be executed very rarely, may indicate that your MySQL client application is either running a simple query to frequently, or may be running a query multiple times that could otherwise be cached. You should pay particular attention to queries where the execution count increases significantly in a short period of time compared to the normal execution rate.

**How to find:** Use the sort feature to sort the queries by execution count.

- **New queries** — new queries appearing in the Query Analyzer tab, especially if they appear after other queries have been in the display for a number of hours or days may indicate a number of issues:
- **Execution times** — long execution times, and a long max execution time compared to the average execution time may indicate a problem with a specific query and specific parameters.

**How to find:** Use the sort feature to sort the queries by execution count.

You can also use the filtering and sort options to get specific information about potential problem queries.

## 15.10.5. Troubleshooting Query Analyzer

If you are having trouble with Query Analyzer, either because the information is not being shown or the full range of queries that you expect are not appearing in the Query Analyzer page then there are a number of systems you can check.

To confirm that your system is correctly configured for Query Analysis, check the following:

- Confirm that the agent is running by checking the Agent log and the status of the server within MySQL Enterprise Service Manager
- Check the configuration of the agent. You must confirm the following:

- The **plugins** parameter within the main configuration file, `mysql-monitor-agent.ini`, must contain the **proxy** plugin:

```
plugins=proxy,agent
```

- The **agent-item-files** parameter within the main configuration file, `mysql-monitor-agent.ini`, must specify the `share/mysql-proxy/items/quan.lua` script:

```
agent-item-files = share/mysql-proxy/items/quan.lua, »
                 share/mysql-proxy/items/items-mysql-monitor.xml
```

- The proxy configuration parameters must point to the MySQL server where you want your queries to be sent. For example, if you are running your agent on the same host as your MySQL server then you might have the following lines in your `mysql-monitor-agent.ini` file:

```
proxy-address=:4040
proxy-backend-addresses = 127.0.0.1:3306
proxy-lua-script         = share/mysql-proxy/quan.lua
```



The above configuration can mean:

- The agent/proxy will listen on the current machine, using port 4040 (`proxy-address`).
- The agent/proxy will send all queries received on to the host 127.0.0.1 on port 3306 (the standard MySQL port), as per the `proxy-backend-addresses` parameter.

You can see a sample complete configuration file (`mysql-monitor-agent.ini`), using the 127.0.0.1 as the MySQL backend server, and reporting to a MySQL Enterprise Service Manager called `monitor`:

```
[mysql-proxy]
plugins=proxy,agent
agent-mgmt-hostname = http://agent:password@monitor:18080/heartbeat
mysqld-instance-dir= etc/instances
agent-item-files = share/mysql-proxy/items/luan.lua,share/mysql-proxy/items/items-mysql-monitor.xml
proxy-address=:4040
proxy-backend-addresses = 127.0.0.1:3306
proxy-lua-script      = share/mysql-proxy/luan.lua
agent-uuid = a3113263-4993-4890-8235-cadef9617c4b
log-file = mysql-monitor-agent.log
pid-file=/opt/mysql/enterprise/agent/mysql-monitor-agent.pid
```

- Confirm that you can connect through the agent proxy to your backend MySQL server. You can do this by checking with the MySQL client. You must specify the same options as you would if you were connecting to the original server, including specifying the same user and password information:

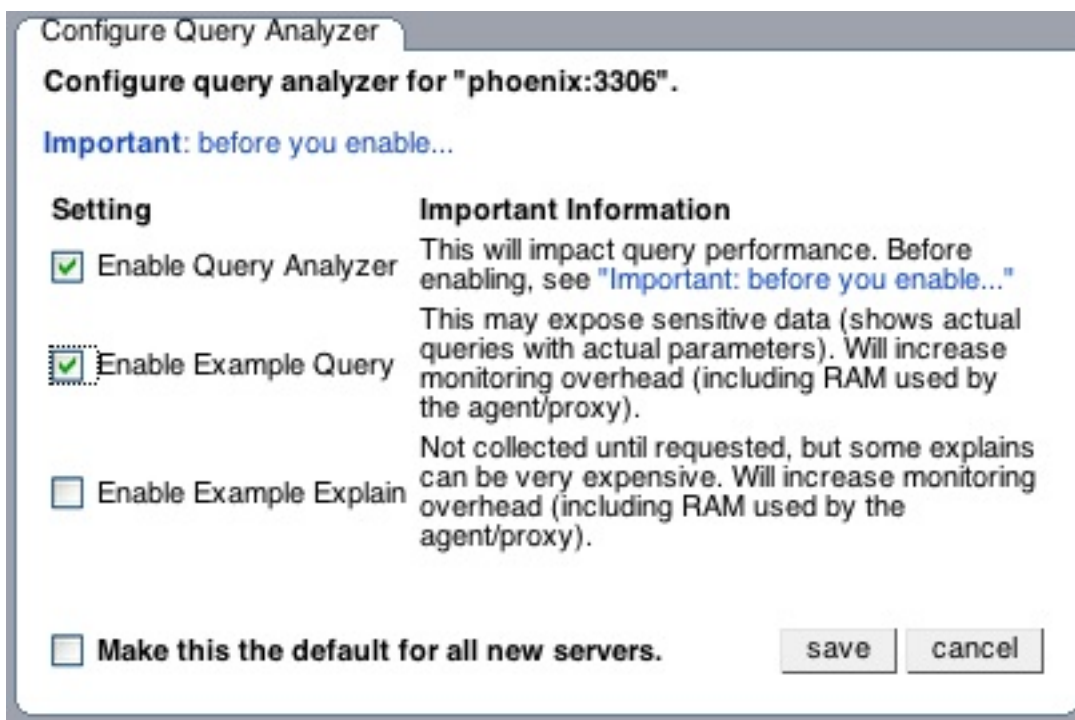
```
shell> mysql -h 127.0.0.1 --port 4040 --user=root -p
Enter password:
Welcome to the MySQL monitor.  Commands end with ; or \g.
Your MySQL connection id is 299239
Server version: 5.0.60-log Gentoo Linux mysql-5.0.60-r1
Type 'help;' or '\h' for help. Type '\c' to clear the buffer.
mysql>
```

- Check that your MySQL client application is configured to use the configured proxy port, instead of the real MySQL port when sending queries.
- Confirm that Query Analyzer enabled for your host. For more information, see [Section 15.10.6, “Query Analyzer Settings”](#).

## 15.10.6. Query Analyzer Settings

There are a number of settings related to the Query Analyzer data. You can configure the query analyzer operation by using the **CONFIGURE QUERY ANALYZER** link within the **QUERY ANALYZER** tab, or through the **CONFIGURE QUERY ANALYZER** button within the **MANAGE SERVERS** tab within the **SETTINGS** tab. Both methods provide you with the same dialog:

**Figure 15.51. MySQL Enterprise Dashboard: Query Analyzer Configuration**



Through either solution, the configuration options that you select are applied to the individual server or server group selected within the **SERVICES** navigation panel.

There are three configuration options available through either method:

- **ENABLE QUERY ANALYZER** configures whether query analyzer should be enabled for this server or server group. If selected, query analyzer will be enabled. To disable, delect the check box.

If Query Analyzer has been enabled, then you can additional configure the Example Query function by selecting the **ENABLE EXAMPLE QUERY** checkbox. Enabling this option provides an additional tab when you open the **CANONICAL QUERY** window when clicking on a query.

- **ENABLE EXAMPLE QUERY** allows the Query Analyzer to display more information about individual queries. When enabled, queries and their data items (rather than the canonical form shown by default) will be provided. Enabling this option may expose the full query statements and therefore may present a security issue.

With the **EXAMPLE QUERY** option enabled, an additional tab within the query summary details is made available. For more information, see [Section 15.10.2, "Getting Detailed Query Information"](#).

If you have enabled **EXAMPLE QUERY**, then you can additional enable **EXAMPLE EXPLAIN**, To enable this tab, select the **ENABLE EXAMPLE EXPLAIN** checkbox.

- **ENABLE EXAMPLE EXPLAIN** provides another tab when viewing a query where you can view the output from **EXPLAIN** output from MySQL for the selected query. This will show the full query and how the query was executed within the servers.

Enabling this option may add additional overhead to the execution of your server, as the server will run an **EXPLAIN** statement each time it identifies a long running query. For more information, [Section 15.12, "MySQL Enterprise Monitor Frequently Asked Questions"](#).

To enable or disable query analyzer for an individual server, go to the **SETTINGS** page and click on the **MANAGE SERVERS** link. To configure all the properties, click the **CONFIGURE QUERY ANALYZER** link next to server you want modify.

Alternatively, for each server, the **QUERY ANALYZER** column shows the current setting, On or Off, and whether the **EXAMPLE** and **EXPLAIN** functionality is enabled. To change any setting, click on the current status to toggle between the On/Off position.

To disable or enable Query Analyzer for the selected servers, use the **DISABLE QUERY ANALYZER** or [enable query analyzer](#) buttons within the **SETTINGS** page. You must have selected one or more servers from the list of available servers before selecting these buttons.

You can use the options that you have just selected as the default for all new servers that register with MySQL Enterprise Service

Manager by using select the **MAKE THIS THE DEFAULT FOR ALL NEW SERVERS** checkbox. By default, when a new server registers with MySQL Monitor, the server is automatically configured to supply Query Analysis data. This can have impact on the performance of your monitor and agent as it increases the amount of information supplied to the MySQL Monitor.

Configuration of Query Analyzer occurs through the **CONFIGURE DEFAULTS** button from within the **QUERY ANALYZER** page.

## 15.11. The Replication Page

### Note

MySQL Enterprise subscription, MySQL Enterprise Monitor, MySQL Replication Monitor, and MySQL Query Analyzer are only available to commercial customers. To learn more, see: <http://www.mysql.com/products/enterprise/features.html>.

Navigate to the [Replication](#) page by choosing the **REPLICATION** tab. This page provides a quick summary view of the state of your replication servers or, if you wish, you can drill down and determine specifics about any master or slave.

### Note

Servers, whether masters or slaves, must be monitored in order for them to appear on this page.

### Note

There will be no [Replication](#) page if your subscription level does not support this feature.

The [Replication](#) page groups all master servers with their slaves. Masters and their slaves are autodiscovered and a grouping is created. This grouping shows up on the replication page and also in the [Heat Chart](#) on the [Monitor](#) page. Scans run on a five minute interval, so depending upon the order of discovery, it can take as long as 2 polling intervals to create a complete group.

**Figure 15.52. MySQL Enterprise Dashboard: Replication groups**

Servers	Type	Slave IO	Slave SQL	Time Behind	Binlog
Replication 1 (5)	TREE	Running	Stopped		
local-tree-master:10001	master				master-bin.000035
local-tree-master-slave:10002	master/slave	Running	Running	00:00:00	master-slave-bin.000035
local-tree-slave3:10008	slave	Running	Running	00:00:00	
local-tree-slave2:10007	slave	Running	Running	00:00:00	
local-tree-slave:10003	slave	Running	Stopped		
Replication 4 (4)	MIXED	Running	Running		
ring1:10004	master/slave	Running	Running	00:00:00	master-bin.000030
ring2:10005	master/slave	Running	Running	00:00:00	master-bin.000030
ring2-slave:10009	slave	Running	Running	00:00:00	
ring3:10006	master/slave	Running	Running	00:00:00	master-bin.000030

Discovery events are logged to the [Replication](#) log. To view this log navigate to the [Settings](#) page and choose the **LOGS** link. View all replication-related events by clicking the **REPLICATION** link. This log can be a useful tool should you need to debug the replication topology discovery process.

### Warning

The agent must be installed on the same machine as the server you are monitoring in order for discovery to work properly. Do **not** use remote monitoring.

Replication groups can be managed from the [Manage Servers](#) page in the same way as other groups. However, any slaves removed from a server group will automatically be restored to that group. It is also possible to add non-slaves to a replication group-

ing. For more information about server groupings see [Section 15.6.3.2, “Grouping Servers”](#).

### 15.11.1. Replication Page Details

Choose a value from the **REFRESH** drop-down list box to set the rate at which information is updated. This refresh rate applies only to the information presented on this page: It is independent of the rate set for the [Monitor](#) page.

The following columns describe replication servers and their slaves:

- Servers – Displays the group name and any master servers and slaves
- Type – Indicates the topology of a server group or in the case of individual servers, whether a server is a master, a master/slave, or a slave
- Slave IO – Reports the status of the slave IO thread
- Slave SQL – Reports the status of the slave SQL thread
- Seconds Behind – The number of seconds the slave is behind the master. This column is blank if a server is a master.
- Binlog – The binlog file name
- Binlog Pos – The current position in the binlog file
- Master Binlog – The master binlog file name
- Master Binlog Pos – The current position in the master binlog file
- Last Error – The most recent error
- Unlabeled Column – Use the **RENAME GROUP** link on the server group line to edit the server group name

Levels of indentation in the [Servers](#) column show the relationship between master servers and their slaves. Most column headings are active links that allow you to change the order of display by clicking on the header. Sorting works differently for different column groupings. Click the [Seconds Behind](#) header to order servers by the number of seconds they are behind their master. However, in all cases, the server topology is respected. For example, in a [TREE](#) topology, ordering occurs within branches only.

If the agent is down, servers show in bold red in the [Servers](#) column. The [Slave IO](#) and the [Slave SQL](#) columns display **stopped** in red text if these threads are not running. If an agent is down, italics is used to display the last know status of the IO or SQL threads.

Clicking on a master server opens a dialog box that displays information about the server. The information shown includes:

- The number of slave servers
- The binlog file name
- The binlog position
- Which databases are replicated and which not

The dialog box also includes a link that allows the user to hide or show the slave servers.

Clicking on a slave server opens a dialog window showing extensive information about the slave.

## 15.12. MySQL Enterprise Monitor Frequently Asked Questions

### Note

MySQL Enterprise subscription, MySQL Enterprise Monitor, MySQL Replication Monitor, and MySQL Query Analyzer are only available to commercial customers. To learn more, see: <http://www.mysql.com/products/enterprise/features.html>.

FAQ Categories

- [General Usage](#)

- [MySQL Enterprise](#)
- [MySQL Monitor](#)
- [MySQL Query Analyzer](#)

## General Usage

### Questions

- **15.12.1:** While monitoring my network traffic I have noticed that the agents communicate information at irregular intervals to the MySQL Enterprise Service Manager. I cannot see anything in my configuration that would explain this behaviour. What is going on?
- **15.12.2:** How frequently is the data purge process executed?
- **15.12.3:** Does Query Analyzer work with all versions of MySQL and the MySQL Client Libraries?
- **15.12.4:** My MySQL Enterprise Service Manager is behind a firewall but it cannot communicate with the MySQL Enterprise website to register and download my license key and advisor bundle. I normally use a proxy service to access external websites. How do I configure the proxy settings for MySQL Enterprise Dashboard?
- **15.12.5:** What is the relationship between the advisor JAR file and the key?
- **15.12.6:** I have set the graphs to update every 5 minutes, and the page refresh to occur every minute. The page is refreshing correctly, but the graphs do not seem to update.
- **15.12.7:** Can the Trial-level key work with the Gold-level advisors JAR file?
- **15.12.8:** During query analysis, I am unable to obtain an [EXAMPLE](#) or [EXPLAIN](#) information when examining the detail of the analyzed query within the **QUERY ANALYZER** panel.
- **15.12.9:** Does the Gold-level key support Silver-level advisors?
- **15.12.10:** I have enabled [EXPLAIN](#) queries for Query Analyzer, but no queries with the [EXPLAIN](#) data are showing up in the display.
- **15.12.11:** Can I run MySQL Enterprise Service Manager on machine with other applications running?
- **15.12.12:** Why do some rules appear to have a **SEVERITY** of **UNKNOWN**?
- **15.12.13:** How do I change the name of a server?
- **15.12.14:** I have started a Data Migration of my old data for a server to MySQL Enterprise Service Manager 2.0, but I have noticed that the performance of the monitor server has degraded significantly. Can I stop the migration?

### Questions and Answers

**15.12.1: While monitoring my network traffic I have noticed that the agents communicate information at irregular intervals to the MySQL Enterprise Service Manager. I cannot see anything in my configuration that would explain this behaviour. What is going on?**

Each MySQL Enterprise Monitor Agent periodically sends information to the server about a range of different information, including the core rule and statistical data, Query Analyzer information and other data used to monitor the status of your MySQL server.

One element of this is called the MySQL Enterprise Monitor Agent Heartbeat, which is core information exchange that indicates that the monitored server is still up and running. The heartbeat information is vital because it tells the MySQL Enterprise Service Manager that the agent and server are still communicating. This information is sent regularly to the MySQL Enterprise Service Manager, but to prevent multiple agents from sending the information at the same time, and creating a large network load (or storm), the interval is randomized with each heartbeat. The randomization ensures that the information is still uploaded periodically, but without the potential to overload the network with this data.

**15.12.2: How frequently is the data purge process executed?**

A data purge process is started approximately once a minute. If you have changed the purge period then the data will start to be purged within the next minute.

**15.12.3: Does Query Analyzer work with all versions of MySQL and the MySQL Client Libraries?**

The MySQL Proxy component, and Query Analyzer, require that clients connecting through MySQL Enterprise Monitor Agent are using MySQL 5.0 or later. Clients that use the library provided with MySQL 4.1 or earlier will not work with MySQL Enterprise Monitor Agent.

**15.12.4: My MySQL Enterprise Service Manager is behind a firewall but it cannot communicate with the MySQL Enterprise website to register and download my license key and advisor bundle. I normally use a proxy service to access external websites. How do I configure the proxy settings for MySQL Enterprise Dashboard?**

To configure a proxy service, you need to edit the `apache-tomcat/conf/catalina.properties` file within the MySQL Enterprise Service Manager installation directory. To make the changes, the proxy configuration information to the end of the file by setting the `http.proxyHost` and `http.proxyPort` properties:

```
http.proxyHost=proxy.example.com
http.proxyPort=8080
```

You will need to restart the MySQL Enterprise Service Manager for the change to take effect:

```
shell> mysqlmonitorctl.sh restart
```

**15.12.5: What is the relationship between the advisor JAR file and the key?**

The JAR file contains graph and advisor definitions. The key file contains typical customer validation data such as contract information, number of servers covered, subscription level and dates.

**15.12.6: I have set the graphs to update every 5 minutes, and the page refresh to occur every minute. The page is refreshing correctly, but the graphs do not seem to update.**

The graph refresh and page refresh are two different parameters. The graphs will update according to their refresh period, regardless of the refresh period set for the main display page.

**15.12.7: Can the Trial-level key work with the Gold-level advisors JAR file?**

The Trial-level key can only be used with the Trial-level advisors JAR file.

**15.12.8: During query analysis, I am unable to obtain an `EXAMPLE` or `EXPLAIN` information when examining the detail of the analyzed query within the QUERY ANALYZER panel.**

You must explicitly enable the `EXAMPLE` and `EXPLAIN` query functionality. Make sure that you have enabled both panels. See [Section 15.10.6, “Query Analyzer Settings”](#).

**15.12.9: Does the Gold-level key support Silver-level advisors?**

The Gold-level advisor JAR file will contain Silver-level advisors plus Gold-level advisors. However, you cannot use the Gold-level key with the Silver-level advisors JAR file. The Gold-level key can only be used with the Gold-level advisors JAR file.

**15.12.10: I have enabled `EXPLAIN` queries for Query Analyzer, but no queries with the `EXPLAIN` data are showing up in the display.**

Query Analyzer only obtains `EXPLAIN` information when the MySQL Enterprise Monitor Agent identifies a long running query. If none of your queries exceed the defined threshold, then the `EXPLAIN` information is not obtain and provided to the Query Analyzer for display.

To change the query duration at which an `EXPLAIN` is triggered, you must edit the `share/mysql-proxy/quant.lua` file within the MySQL Enterprise Monitor Agent directory on each server. You need to change the value configured in the `auto_explain_min_exec_time_us`. The default is 500ms:

```
---
-- configuration
--
-- SET GLOBAL analyze_query.auto_filter = 0
if not proxy.global.config.quan then
  proxy.global.config.quan = {
    analyze_queries = true,    -- track all queries
    query_cutoff   = 160,    -- only show the first 160 chars of the query
    num_worst_queries = 5,
    auto_explain   = true,
    auto_explain_min_exec_time_us = 500 * 1000
  }
end
```

The value is expressed in microseconds, which is why the value must be multiplied by 1000. To reduce this value to 100ms you would modify the line:

```
auto_explain_min_exec_time_us = 100 * 1000
```

You do not need to restart MySQL Enterprise Monitor Agent for the changes to take effect.

#### **15.12.11: Can I run MySQL Enterprise Service Manager on machine with other applications running?**

You can, but ideally you should be running your MySQL Enterprise Service Manager on a dedicated machine, especially if you are monitoring a number of different agents. For more information, see [Section 15.4.4, “Choosing Suitable MySQL Enterprise Service Manager Hardware Configurations”](#).

#### **15.12.12: Why do some rules appear to have a SEVERITY of UNKNOWN?**

Due to timing issues, certain rules such as “32-Bit Binary Running on 64-Bit AMD Or Intel System” and “Key Buffer Size Greater Than 4 GB” do not evaluate correctly due to timing issues. This is a known issue and will be resolved in future versions of MySQL Enterprise Monitor.

#### **15.12.13: How do I change the name of a server?**

Go to the **MANAGE SERVERS** panel within **SETTINGS** and click **RENAME SERVER**.

#### **15.12.14: I have started a Data Migration of my old data for a server to MySQL Enterprise Service Manager 2.0, but I have noticed that the performance of the monitor server has degraded significantly. Can I stop the migration?**

You can stop the migration of your historical data at any time. Go to the **MANAGE SERVERS** display of the **SETTINGS** panel and click **STOP** next to each server that is being migrated. You can restart the migration at any point.

## **MySQL Enterprise**

### **Questions**

- [15.12.1](#): How should I decide between MySQL Enterprise Basic, Silver, Gold and Platinum?
- [15.12.2](#): What is MySQL Enterprise Server?
- [15.12.3](#): How do I get a 30-day trial on MySQL Enterprise?
- [15.12.4](#): Does MySQL Enterprise include Maintenance, Updates, and Upgrades?
- [15.12.5](#): What is a Technical Account Manager?
- [15.12.6](#): Are there any Webinars available?
- [15.12.7](#): What is the pricing of MySQL Enterprise?
- [15.12.8](#): Does MySQL Enterprise include Emergency Hot Fix Builds?
- [15.12.9](#): Are there any MySQL Enterprise White Papers available?
- [15.12.10](#): How do I buy MySQL Enterprise?
- [15.12.11](#): What is MySQL Enterprise?
- [15.12.12](#): Does MySQL provide IP (Intellectual Property) Indemnification?
- [15.12.13](#): Can I buy MySQL Enterprise subscriptions for multiple years?
- [15.12.14](#): What is MySQL Enterprise Unlimited?
- [15.12.15](#): What is MySQL Production Support?
- [15.12.16](#): Can I buy MySQL Enterprise subscriptions for only some of my production MySQL database servers?
- [15.12.17](#): Are there any Demo/Tutorials available for MySQL Enterprise?
- [15.12.18](#): Does MySQL Enterprise include 24x7 Technical Support?
- [15.12.19](#): What if I plan to add more MySQL servers to my MySQL Enterprise subscription?
- [15.12.20](#): What is the list of Supported Platforms?
- [15.12.21](#): Do all my MySQL Enterprise subscriptions need to be at the same tier?
- [15.12.22](#): What is MySQL Consultative Support?



## Questions and Answers

### 15.12.1: How should I decide between MySQL Enterprise Basic, Silver, Gold and Platinum?

MySQL Enterprise subscriptions are available in 4 tiers, providing you the flexibility of choosing the capabilities and SLA that best meet your requirements. [Learn More](#) If you have questions and what to discuss your specific requirements, please [Contact MySQL Sales](#)

### 15.12.2: What is MySQL Enterprise Server?

MySQL Enterprise Server software is the most reliable, secure and up-to-date version of MySQL for cost-effectively delivering E-commerce, Online Transaction Processing (OLTP), and multi-terabyte Data Warehousing applications. It is a fully integrated transaction-safe, ACID compliant database with full commit, rollback, crash recovery and row level locking capabilities. MySQL delivers the ease of use, scalability, and performance that has made it MySQL the world's most popular open source database. [Learn More](#)

### 15.12.3: How do I get a 30-day trial on MySQL Enterprise?

You can experience the MySQL Enterprise Monitor for 30 days by registering to receive an email with login instructions. [Learn More](#)

### 15.12.4: Does MySQL Enterprise include Maintenance, Updates, and Upgrades?

Yes. As long as you have a valid contract for MySQL Enterprise, you will receive all new MySQL Enterprise Server software releases including Software Maintenance, Updates, and Upgrades. The Software Update Service will automatically notify you of the new releases.

### 15.12.5: What is a Technical Account Manager?

MySQL Enterprise, at the Platinum tier, provides the option for a Technical Account Manager (TAM). The TAM is your advocate within MySQL, who proactively works to maximize your benefits from MySQL Support Services. [Learn More](#)

### 15.12.6: Are there any Webinars available?

Yes. MySQL provides regularly scheduled Live Webinars. [Learn More](#) MySQL also provides On-Demand Webinars to fit your schedule. These are recordings of previously held Live Webinars that you can replay at any time. [Learn More](#)

### 15.12.7: What is the pricing of MySQL Enterprise?

The pricing model for MySQL Enterprise is based on two key components: per server and per year. MySQL Enterprise does not have artificial restrictions based on CPUs, Memory, Machine Size, or Named Users. MySQL Enterprise is available in 4 tiers (Basic, Silver, Gold and Platinum). Choose the tier that best meets your requirements and budget. [Learn More](#)

### 15.12.8: Does MySQL Enterprise include Emergency Hot Fix Builds?

MySQL Enterprise, at the Gold and Platinum tiers, gives you the ability to request an Emergency Hot Fix Build to fix issues not already fixed in a MySQL Rapid Update or MySQL Quarterly Service Pack.

### 15.12.9: Are there any MySQL Enterprise White Papers available?

Yes. Detailed architecture, technology, and business white papers are available. [Learn More](#)

### 15.12.10: How do I buy MySQL Enterprise?

For pricing and to buy MySQL Enterprise, visit the [Online Shop](#) For volume discounts or for more information, please [Contact MySQL Sales](#)

### 15.12.11: What is MySQL Enterprise?

The MySQL Enterprise subscription is the most comprehensive offering of MySQL database software, services and production support to ensure your business achieves the highest levels of reliability, security and uptime.

MySQL Enterprise includes:

- MySQL Enterprise Server software, the most reliable, secure and up-to date version of the world's most popular open source database
- MySQL Enterprise Monitor that continuously monitors your database and proactively advises you on how to implement MySQL best practices



- MySQL 24x7 Production Support with fast response times to assist you in the development, deployment and management of MySQL applications

MySQL Enterprise is available in 4 tiers (Basic, Silver, Gold, Platinum). [Learn More](#)

#### **15.12.12: Does MySQL provide IP (Intellectual Property) Indemnification?**

MySQL Enterprise, at the Gold and Platinum tiers, has the option of IP Indemnification, for qualifying customers at no extra cost. This provides you with legal protection that you expect from enterprise software providers. [Learn More](#)

#### **15.12.13: Can I buy MySQL Enterprise subscriptions for multiple years?**

MySQL Enterprise subscriptions have duration of at least 1 year. Customers have the flexibility of choosing terms with multi-year durations. To purchase multi-year contracts, please [Contact MySQL Sales](#)

#### **15.12.14: What is MySQL Enterprise Unlimited?**

MySQL Enterprise Unlimited is a unique offering that allows you to deploy an unlimited number of MySQL Enterprise Servers for the price of a single CPU of Oracle Enterprise Edition. [Learn More](#)

#### **15.12.15: What is MySQL Production Support?**

Production Support consists of 4 components:

- Problem Resolution Support
- Consultative Support
- Knowledge Base
- Technical Account Manager (option)

MySQL Production Support gives you priority access with guaranteed response times to assist you with the development, deployment and management of your MySQL applications. [Learn More](#)

#### **15.12.16: Can I buy MySQL Enterprise subscriptions for only some of my production MySQL database servers?**

When you choose MySQL Enterprise subscriptions, they must cover all database servers that power that specific application. To negotiate volume discounts, please [Contact MySQL Sales](#)

#### **15.12.17: Are there any Demo/Tutorials available for MySQL Enterprise?**

Yes. Multiple self-running demos are available. [Learn More](#)

#### **15.12.18: Does MySQL Enterprise include 24x7 Technical Support?**

MySQL Enterprise, at the Gold and Platinum tiers, includes 24x7 phone and email access to the MySQL Support Team. [Learn More](#)

#### **15.12.19: What if I plan to add more MySQL servers to my MySQL Enterprise subscription?**

A great option is the MySQL Enterprise Unlimited offering that allows you cover an unlimited number of MySQL servers for a fixed, low price. [Learn More](#)

#### **15.12.20: What is the list of Supported Platforms?**

MySQL Enterprise provides broad coverage in its list of Supported Platforms. [Learn More](#)

#### **15.12.21: Do all my MySQL Enterprise subscriptions need to be at the same tier?**

MySQL Enterprise subscriptions must be at the same tier (Basic, Silver, Gold, Platinum) for all database servers that power that specific application.

#### **15.12.22: What is MySQL Consultative Support?**

MySQL Enterprise, at the Gold and Platinum tiers, includes Consultative Support. This is a proactive approach to support that is designed to help you avoid critical outages. MySQL Support Engineers advise you on how to properly design and tune your MySQL servers, schema, queries, and replication set-up to maximize performance and availability. Also, by taking the initiative to properly design and tune your MySQL database applications you can avoid having to purchase expensive hardware for your IT infrastructure. [Learn More](#)

## MySQL Monitor

### Questions

- [15.12.1](#): What is MySQL Enterprise Monitor?
- [15.12.2](#): What versions of MySQL are supported by the MySQL Enterprise Monitor?
- [15.12.3](#): What MySQL Enterprise subscription levels include the MySQL Enterprise Monitor?
- [15.12.4](#): What are the features and related benefits of the MySQL Enterprise Monitor?
- [15.12.5](#): What are the MySQL Enterprise Advisors and Advisor Rules?
- [15.12.6](#): How is the Enterprise Monitor web application architected?
- [15.12.7](#): What operating system platforms are supported by the MySQL Enterprise Monitor?
- [15.12.8](#): How do I get the MySQL Enterprise Monitor?
- [15.12.9](#): What makes MySQL Enterprise unique?
- [15.12.10](#): What are the long-term benefits of the MySQL Enterprise Monitor?
- [15.12.11](#): Which set of Enterprise Advisors, Advisor Rules and features are best for my use of MySQL?
- [15.12.12](#): How is the MySQL Enterprise Monitor installed and deployed?
- [15.12.13](#): What are the immediate benefits of implementing the MySQL Enterprise Monitor?
- [15.12.14](#): How are subscribers notified about the availability of new or updated MySQL Enterprise Monitor, MySQL Enterprise Advisors and Advisor Rules?
- [15.12.15](#): Which Advisors and features are included under different MySQL Enterprise subscription levels?

### Questions and Answers

#### **15.12.1: What is MySQL Enterprise Monitor?**

Included as part of a MySQL Enterprise subscription, the MySQL Enterprise Monitor is a distributed, web-based application that helps customers reduce downtime, tighten security and increase throughput of their MySQL servers by telling them about problems in their database applications before they occur. It is downloadable from the Enterprise Customer web site and is deployed within the safety of the customer datacenter. [Learn More](#)

#### **15.12.2: What versions of MySQL are supported by the MySQL Enterprise Monitor?**

The MySQL Enterprise Monitor can be used to monitor MySQL versions 4.0 – 5.x.

#### **15.12.3: What MySQL Enterprise subscription levels include the MySQL Enterprise Monitor?**

The Enterprise Monitor is available under MySQL Enterprise subscription levels Silver, Gold and Platinum. [Learn More](#)

#### **15.12.4: What are the features and related benefits of the MySQL Enterprise Monitor?**

The MySQL Enterprise Monitor is like having a "Virtual DBA Assistant" at your side to recommend best practices to eliminate security vulnerabilities, improve replication, and optimize performance. For the complete features and benefits, visit the [MySQL Enterprise Monitor Features and Benefits page](#).

#### **15.12.5: What are the MySQL Enterprise Advisors and Advisor Rules?**

The MySQL Enterprise Advisors are a set of best practice guidelines for the optimal use of MySQL. Advisors are spread across database specific disciplines and are comprised of a set of MySQL Advisor Rules that proactively monitor all MySQL servers and report on database application problems before they occur. Each Advisor Rule provides a detailed overview of the problem it is designed to identify, advices on how to correct the problem, specifies commands to implement the recommended fix and links to additional resources for additional research into the issue at hand. [Learn More](#)

#### **15.12.6: How is the Enterprise Monitor web application architected?**

The Enterprise Monitor web application is comprised of 3 components:

- **Service Agent:** A lightweight C program that is installed on each of the monitored MySQL servers. Its purpose is to collect MySQL SQL and operating system metrics that allow the DBA to monitor the overall health, availability and performance of the MySQL server. The Service Agent is the only component within the application that touches or connects to the MySQL Server. It reports the data it collects via XML over HTTP to the centralized Service Manager.
- **Service Manager:** The main server of the application. The Service Manager manages and stores the data collections that come in from each service agent. It analyzes these collections using MySQL provided best practice Advisor rules to determine the health, security, availability and performance of each of the monitored MySQL Servers. The Service Manager also provides the content for the Enterprise Dashboard which serves as the client user interface for the distributed web application.
- **Repository:** A MySQL database that is used to stored data collections and application-level configuration data.

#### **15.12.7: What operating system platforms are supported by the MySQL Enterprise Monitor?**

The Enterprise Monitor Service Manager is fully supported on most current versions of Linux, Windows XP and Server Editions, Solaris and Mac OSX. The Service Agent supports any platform supported by the MySQL Enterprise server. For the complete list of MySQL Enterprise supported operating systems and CPUs, visit the [Supported Platforms page](#).

#### **15.12.8: How do I get the MySQL Enterprise Monitor?**

The MySQL Enterprise Monitor is available for download to MySQL Enterprise customers at the Silver, Gold and Platinum subscription levels.

- To experience the MySQL Enterprise Monitor for 30 days, visit the [Trial Subscription page](#)
- To buy MySQL Enterprise, visit the [Online Shop](#)

#### **15.12.9: What makes MySQL Enterprise unique?**

Of the products on the market that monitor MySQL, SQL code and OS specific metrics, the MySQL Enterprise Monitor is the only solution that is built and supported by the engineers at MySQL. Unlike other solutions that report on raw MySQL and OS level metrics, the MySQL Enterprise Monitor is designed to optimize the use of MySQL by proactively monitoring MySQL instances and providing notifications and “MySQL DBA expertise in a box” advice on corrective measures DBAs can take before problems occur.

#### **15.12.10: What are the long-term benefits of the MySQL Enterprise Monitor?**

Over time, the task of managing even medium-scale MySQL server farms becomes exponentially more complicated, especially as the load of users, connections, application queries, and objects on each MySQL server increases. The Enterprise Monitor continually monitors the dynamic security, performance, replication and schema relevant metrics of all MySQL servers, so as the number of MySQL continues to grow, DBAs are kept up to date on potential problems and proactive measures that can be implemented to ensure each server continues to operate at the highest levels of security, performance and reliability.

#### **15.12.11: Which set of Enterprise Advisors, Advisor Rules and features are best for my use of MySQL?**

The Enterprise Monitor Advisors and Advisor Rules are available at 3 MySQL Enterprise subscription tiers: Choose MySQL Enterprise Silver if you need:

- Assurance you are running the most current, bug-free version of MySQL across all of your servers.
- Recoverability of your MySQL servers.
- The highest level of security for your MySQL servers.
- Monitoring of maximum or disallowed MySQL connections.
- Optimized startup configuration settings.

Choose MySQL Enterprise Gold, when you need everything in Silver, PLUS:

- Easy collection and detection of problematic SQL code running on your production or development systems.
- Insight and corrective advice on MySQL replication status, sync, and performance related issues.
- Auto detection and documenting of your Replication topologies.

- Advanced monitoring of your Replication and Scale-out environment.

Choose MySQL Enterprise Platinum, when you need everything in Gold, PLUS:

- Identification and advice on unplanned database and object level schema changes (Create, Alter, and Drop) across your MySQL servers.
- Proactive monitoring and advice on tuning the performance of your MySQL servers.

#### **15.12.12: How is the MySQL Enterprise Monitor installed and deployed?**

The Enterprise Monitor is powered by a distributed web application that is installed and deployed within the confines of the corporate firewall.

#### **15.12.13: What are the immediate benefits of implementing the MySQL Enterprise Monitor?**

Often MySQL installations are implemented with default settings that may not be best suited for specific applications or usage patterns. The MySQL Advisors go to work immediately in these environments to identify potential problems and proactively notify and advise DBAs on key MySQL settings that can be tuned to improve availability, tighten security, and increase the throughput of their existing MySQL servers

#### **15.12.14: How are subscribers notified about the availability of new or updated MySQL Enterprise Monitor, MySQL Enterprise Advisors and Advisor Rules?**

Customers will receive notifications of new and updated MySQL Enterprise Monitor and Advisors as they become available via the MySQL Enterprise Software Update Service. Notifications will be generated and sent based on the customer profile and the MySQL Enterprise subscription level.

#### **15.12.15: Which Advisors and features are included under different MySQL Enterprise subscription levels?**

For the complete list of the MySQL Enterprise Advisors that are available under each MySQL Enterprise subscription level, visit the [Features page](#).

### **MySQL Query Analyzer**

#### **Questions**

- [15.12.1](#): Can I leave the MySQL Query Analyzer enabled at all times?
- [15.12.2](#): What are the typical use cases of the MySQL Query Analyzer?
- [15.12.3](#): What is the MySQL Query Analyzer?
- [15.12.4](#): What are the main features and benefits of the MySQL Query Analyzer?
- [15.12.5](#): What makes the MySQL Query Analyzer unique?
- [15.12.6](#): How are subscribers notified about updates to the MySQL Query Analyzer application components?
- [15.12.7](#): How can I get the MySQL Query Analyzer?
- [15.12.8](#): How is the MySQL Query Analyzer installed and enabled?
- [15.12.9](#): What overhead can I expect when the MySQL Query Analyzer is installed and enabled?

#### **Questions and Answers**

##### **15.12.1: Can I leave the MySQL Query Analyzer enabled at all times?**

We have customers who have the Query Analyzer enabled and collecting queries on their development and QA servers so they can tune their code and monitor the fixes as part of the development process. For production systems, Query collection and analysis can easily be toggled on when a slowdown occurs. To avoid collection mode overhead many users are using simple scripts to enable the Query Analyzer to sample queries during non-peak hours, typically during 30 minute windows. They can then view the collected queries using the date/time or interval filter options.

##### **15.12.2: What are the typical use cases of the MySQL Query Analyzer?**

The typical use cases for developers, DBAs and system administrators are:

- Developers – Monitor and tune application queries during development before they are promoted to production.
- DBAs and System Administrators – Identify problem SQL code as it runs in production and advise development teams on how to tune. This use case benefits the most from regular sampling of queries as they are running, most often during non-peak hours.

### **15.12.3: What is the MySQL Query Analyzer?**

The MySQL Query Analyzer allows DBAs, developers and system administrators to improve application performance by collecting, monitoring, and analyzing queries as they run on their MySQL servers. [Learn More](#)

### **15.12.4: What are the main features and benefits of the MySQL Query Analyzer?**

For the complete features and benefits, visit the [MySQL Enterprise Monitor Features and Benefits page](#).

### **15.12.5: What makes the MySQL Query Analyzer unique?**

Other products (free, open source and commercial) that provide MySQL query monitoring are dependent on the MySQL Slow Query Log being enabled and available for sampling. While this provides some time savings over the DBA collecting and parsing the Log, the Slow Query Log comes with overhead and does not capture sub millisecond executions. The log data also grows very large very quickly.

The MySQL Query Analyzer collects queries and execution statistics with no dependence on the SQL Query Log, it captures all SQL statements sent to the MySQL server and provides an aggregated view into the most expensive queries in number of executions and total execution time. It is also fully supported as part of the MySQL Enterprise subscription.

### **15.12.6: How are subscribers notified about updates to the MySQL Query Analyzer application components?**

Customers will receive notifications of the MySQL Query Analyzer updates as they become available via the MySQL Enterprise Software Update and Alert Service. Notifications will be generated and sent based on the customer profile and the MySQL Enterprise subscription level.

### **15.12.7: How can I get the MySQL Query Analyzer?**

The MySQL Query Analyzer is available for download to MySQL Enterprise customers at the Gold and Platinum subscription levels.

- To experience the MySQL Enterprise Monitor for 30 days, visit the [Trial Subscription page](#)
- To buy MySQL Enterprise, visit the [Online Shop](#)

### **15.12.8: How is the MySQL Query Analyzer installed and enabled?**

The Query Analyzer feature is installed with the Service Agent. It is enabled during agent installation and can be toggled between collection and pass-thru modes from the Query Analysis page of the Enterprise Monitor.

### **15.12.9: What overhead can I expect when the MySQL Query Analyzer is installed and enabled?**

The average overhead when in active collection mode is in the 15-20% range. In pass-thru mode the overhead is minimal, weighing in at 1-5% on most MySQL systems of average load.

---

# Chapter 16. Replication

Replication enables data from one MySQL database server (called the master) to be replicated to one or more MySQL database servers (slaves). Replication is asynchronous - your replication slaves do not need to be connected permanently to receive updates from the master, which means that updates can occur over long-distance connections and even temporary solutions such as a dial-up service. Depending on the configuration, you can replicate all databases, selected databases, or even selected tables within a database.

The target uses for replication in MySQL include:

- Scale-out solutions - spreading the load among multiple slaves to improve performance. In this environment, all writes and updates must take place on the master server. Reads, however, may take place on one or more slaves. This model can improve the performance of writes (since the master is dedicated to updates), while dramatically increasing read speed across an increasing number of slaves.
- Data security - because data is replicated to the slave, and the slave can pause the replication process, it is possible to run backup services on the slave without corrupting the corresponding master data.
- Analytics - live data can be created on the master, while the analysis of the information can take place on the slave without affecting the performance of the master.
- Long-distance data distribution - if a branch office would like to work with a copy of your main data, you can use replication to create a local copy of the data for their use without requiring permanent access to the master.

Replication in MySQL features support for one-way, asynchronous replication, in which one server acts as the master, while one or more other servers act as slaves. This is in contrast to the *synchronous* replication which is a characteristic of MySQL Cluster (see [MySQL Cluster NDB 6.X/7.X](#)).

There are a number of solutions available for setting up replication between two servers, but the best method to use depends on the presence of data and the engine types you are using. For more information on the available options, see [Section 16.1.1, “How to Set Up Replication”](#).

There are two core types of replication format, Statement Based Replication (SBR), which replicates entire SQL statements, and Row Based Replication (RBR), which replicates only the changed rows. You may also use a third variety, Mixed Based Replication (MBR), which is the default mode within MySQL 5.1.12 and later. For more information on the different replication formats, see [Section 16.1.2, “Replication Formats”](#).

Replication is controlled through a number of different options and variables. These control the core operation of the replication, timeouts and the databases and filters that can be applied on databases and tables. For more information on the available options, see [Section 16.1.3, “Replication and Binary Logging Options and Variables”](#).

You can use replication to solve a number of different problems, including problems with performance, supporting the backup of different databases and for use as part of a larger solution to alleviate system failures. For information on how to address these issues, see [Section 16.2, “Replication Solutions”](#).

For notes and tips on how different data types and statements are treated during replication, including details of replication features, version compatibility, upgrades, and problems and their resolution, including an FAQ, see [Section 16.3, “Replication Notes and Tips”](#).

Detailed information on the implementation of replication, how replication works, the process and contents of the binary log, background threads and the rules used to decide how statements are recorded and replication, see [Section 16.4, “Replication Implementation”](#).

## MySQL Enterprise

The MySQL Enterprise Monitor provides numerous advisors that provide immediate feedback about replication-related problems. For more information, see <http://www.mysql.com/products/enterprise/advisors.html>.

## 16.1. Replication Configuration

Replication between servers in MySQL works through the use of the binary logging mechanism. The MySQL instance operating as the master (the source of the database changes) writes updates and changes as “events” to the binary log. The information in the binary log is stored in different logging formats according to the database changes being recorded. Slaves are configured to read the binary log from the master and to execute the events in the binary log on the slave’s local database.

The master is “dumb” in this scenario. Once binary logging has been enabled, all statements are recorded in the binary log. Each slave will receive a copy of the entire contents of the binary log. It is the responsibility of the slave to decide which statements in the binary log should be executed; you cannot configure the master to log only certain events. If you do not specify otherwise, all

events in the master binary log are executed on the slave. If required, you can configure the slave to process only events that apply to particular databases or tables.

Each slave keeps a record of the binary log file and position within the log file that it has read and processed from the master. This means that multiple slaves can be connected to the master and executing different parts of the same binary log. Because the slaves control this process, individual slaves can be connected and disconnected from the server without affecting the master's operation. Also, because each slave remembers the position within the binary log, it is possible for slaves to be disconnected, reconnect and then “catch up” by continuing from the recorded position.

Both the master and each slave must be configured with a unique ID (using the `server-id` option). In addition, the slave must be configured with information about the master host name, log file name and position within that file. These details can be controlled from within a MySQL session using the `CHANGE MASTER TO` statement. The details are stored within the `master.info` file.

In this section the setup and configuration required for a replication environment is described, including step-by-step instructions for creating a new replication environment. The major components of this section are:

- For a guide to setting up two or more servers for replication see [Section 16.1.1, “How to Set Up Replication”](#). This section deals with the setup of the systems and provides methods for copying data between the master and slaves.
- Events in the binary log are recorded using a number of formats. These are referred to as statement-based replication (SBR) or row-based replication (RBR). A third type, mixed-format replication (MIXED), uses SBR or RBR replication automatically to take advantage of the benefits of both SBR and RBR formats when appropriate. The different formats are discussed in [Section 16.1.2, “Replication Formats”](#).
- Detailed information on the different configuration options and variables that apply to replication is provided in [Section 16.1.3, “Replication and Binary Logging Options and Variables”](#).
- Once started, the replication process should require little administration or monitoring. However, for advice on common tasks that you may want to execute, see [Section 16.1.4, “Common Replication Administration Tasks”](#).

## 16.1.1. How to Set Up Replication

This section describes how to set up complete replication of a MySQL server. There are a number of different methods for setting up replication, and the exact method that you use will depend on how you are setting up replication, and whether you already have data within your master database.

There are some generic tasks which may be required for all replication setups:

- You may want to create a separate user that will be used by your slaves to authenticate with the master to read the binary log for replication. The step is optional. See [Section 16.1.1.1, “Creating a User for Replication”](#).
- You must configure the master to support the binary log and configure a unique ID. See [Section 16.1.1.2, “Setting the Replication Master Configuration”](#).
- You must configure a unique ID for each slave that you want to connect to the master. See [Section 16.1.1.3, “Setting the Replication Slave Configuration”](#).
- Before starting a data snapshot or the replication process, you should record the position of the binary log on the master. You will need this information when configuring the slave so that the slave knows where within the binary log to start executing events. See [Section 16.1.1.4, “Obtaining the Master Replication Information”](#).
- If you already have data on your master and you want to synchronize your slave with this base data, then you will need to create a data snapshot of your database. You can create a snapshot using `mysqldump` (see [Section 16.1.1.5, “Creating a Data Snapshot Using `mysqldump`”](#)) or by copying the data files directly (see [Section 16.1.1.6, “Creating a Data Snapshot Using Raw Data Files”](#)).
- You will need to configure the slave with the master settings, such as the host name, login credentials and binary log name and positions. See [Section 16.1.1.10, “Setting the Master Configuration on the Slave”](#).

Once you have configured the basic options, you will need to follow the instructions for your replication setup. A number of alternatives are provided:

- If you are establishing a new MySQL master and one or more slaves, then you need only set up the configuration, as you have no data to exchange. For guidance on setting up replication in this situation, see [Section 16.1.1.7, “Setting Up Replication with New Master and Slaves”](#).



- If you are already running a MySQL server, and therefore already have data that will need to be transferred to your slaves before replication starts, have not previously configured the binary log and are able to shut down your MySQL server for a short period during the process, see [Section 16.1.1.8, “Setting Up Replication with Existing Data”](#).
- If you are setting up additional slaves to an existing replication environment then you can set up the slaves without affecting the master. See [Section 16.1.1.9, “Introducing Additional Slaves to an Existing Replication Environment”](#).

If you want to administer a MySQL replication setup, we suggest that you read this entire chapter through and try all statements mentioned in [Section 12.6.1, “SQL Statements for Controlling Master Servers”](#), and [Section 12.6.2, “SQL Statements for Controlling Slave Servers”](#). You should also familiarize yourself with the replication startup options described in [Section 16.1.3, “Replication and Binary Logging Options and Variables”](#).

### Note

Note that certain steps within the setup process require the `SUPER` privilege. If you do not have this privilege then enabling replication may not be possible.

#### 16.1.1.1. Creating a User for Replication

Each slave must connect to the master using a standard MySQL user name and password, so there must be a user account on the master that the slave can use to connect. Any account can be used for this operation, providing it has been granted the `REPLICATION SLAVE` privilege.

You do not need to create a specific user for replication. However, you should be aware that the user name and password will be stored in plain text within the `master.info` file. Therefore, you may want to create a user that only has privileges for the replication process.

To create a user or grant an existing user the privileges required for replication, use the `GRANT` statement. If you create a user solely for the purposes of replication then that user needs only the `REPLICATION SLAVE` privilege. For example, to create a user, `repl`, that can connect for replication from any host within the `mydomain.com` domain, issue this statement on the master:

```
mysql> GRANT REPLICATION SLAVE ON *.*
-> TO 'repl'@'%mydomain.com' IDENTIFIED BY 'slavepass';
```

See [Section 12.5.1.3, “GRANT Syntax”](#), for more information on the `GRANT` statement.

You may wish to create a different user for each slave, or use the same user for each slave that needs to connect. As long as each user that you want to use for the replication process has the `REPLICATION SLAVE` privilege you can create as many users as you require.

#### 16.1.1.2. Setting the Replication Master Configuration

For replication to work you *must* enable binary logging on the master. If binary logging is not enabled, replication will not be possible as it is the binary log that is used to exchange data between the master and slaves.

Each server within a replication group must be configured with a unique `server-id` value. The server ID is used to identify individual servers within the group, and must be positive integer between 1 and  $(2^{32})-1$ . How you organize and select the numbers is entirely up to you.

To configure the binary log and server ID options, you will need to shut down your MySQL server and edit the configuration of the `my.cnf` or `my.ini` file.

You will need to add the following options to the configuration file within the `[mysqld]` section. If these options already exist, but are commented out, uncomment the options and alter them according to your needs. For example, to enable binary logging, using a log file name prefix of `mysql-bin`, and setting a server ID of 1:

```
[mysqld]
log-bin=mysql-bin
server-id=1
```

### Note

For the greatest possible durability and consistency in a replication setup using `InnoDB` with transactions, you should use `innodb_flush_log_at_trx_commit=1` and `sync_binlog=1` in the master `my.cnf` file.

### Note

Ensure that the `skip-networking` option has not been enabled on your replication master. If networking has been disabled, then your slave will not be able to communicate with the master and replication will fail.



### 16.1.1.3. Setting the Replication Slave Configuration

The only option you must configure on the slave is to set the unique server ID. If this option is not already set, or the current value conflicts with the value that you have chosen for the master server, then you should shut down your slave server, and edit the configuration to specify the server ID. For example:

```
[mysqld]
server-id=2
```

If you are setting up multiple slaves, each one must have a unique `server-id` value that differs from that of the master and from each of the other slaves. Think of `server-id` values as something similar to IP addresses: These IDs uniquely identify each server instance in the community of replication partners.

If you do not specify a `server-id` value, it defaults to 0.

#### Note

If you omit `server-id` (or set it explicitly to 0), a master refuses connections from all slaves, and a slave refuses to connect to a master. Thus, omitting `server-id` is good only for backup with a binary log.

You do not have to enable binary logging on the slave for replication to be enabled. However, if you enable binary logging on the slave then you can use the binary log for data backups and crash recovery on the slave, and also use the slave as part of a more complex replication topology (for example, where the slave acts as a master to other slaves).

### 16.1.1.4. Obtaining the Master Replication Information

To configure replication on the slave you must determine the master's current point within the master binary log. You will need this information so that when the slave starts the replication process, it is able to start processing events from the binary log at the correct point.

If you have existing data on your master that you want to synchronize on your slaves before starting the replication process, then you must stop processing statements on the master, obtain the current position, and then dump the data, before allowing the master to continue executing statements. If you do not stop the execution of statements, the data dump and the master status information that you use will not match and you will end up with inconsistent or corrupted databases on the slaves.

To get the master status information, follow these steps:

1. Start the command-line client and flush all tables and block write statements by executing the `FLUSH TABLES WITH READ LOCK` statement:

```
mysql> FLUSH TABLES WITH READ LOCK;
```

For `InnoDB` tables, note that `FLUSH TABLES WITH READ LOCK` also blocks `COMMIT` operations.

#### Warning

Leave the client from which you issued the `FLUSH TABLES` statement running so that the read lock remains in effect. If you exit the client, the lock is released.

2. Use the `SHOW MASTER STATUS` statement to determine the current binary log file name and offset on the master:

```
mysql > SHOW MASTER STATUS;
+-----+-----+-----+-----+
| File           | Position | Binlog_Do_DB | Binlog_Ignore_DB |
+-----+-----+-----+-----+
| mysql-bin.003 | 73       | test         | manual,mysql      |
+-----+-----+-----+-----+
```

The `File` column shows the name of the log file and `Position` shows the offset within the file. In this example, the binary log file is `mysql-bin.003` and the offset is 73. Record these values. You need them later when you are setting up the slave. They represent the replication coordinates at which the slave should begin processing new updates from the master.

If the master has been running previously without binary logging enabled, the log name and position values displayed by `SHOW MASTER STATUS` or `mysqldump --master-data` will be empty. In that case, the values that you need to use later when specifying the slave's log file and position are the empty string ( ' ' ) and 4.

You now have the information you need to enable the slave to start reading from the binary log in the correct place to start replication.

If you have existing data that needs to be synchronized with the slave before you start replication, leave the client running so that the lock remains in place and then proceed to [Section 16.1.1.5, “Creating a Data Snapshot Using `mysqldump`”](#), or [Section 16.1.1.6, “Creating a Data Snapshot Using Raw Data Files”](#).

If you are setting up a brand new master and slave replication group, then you can exit the client and release the locks.

### 16.1.1.5. Creating a Data Snapshot Using `mysqldump`

One way to create a snapshot of the data in an existing master database is to use the `mysqldump` tool. Once the data dump has been completed, you then import this data into the slave before starting the replication process.

To obtain a snapshot of the data using `mysqldump`:

- If you haven't already locked the tables on the server to prevent statements that update data from executing:

Start the command-line client and flush all tables and block write statements by executing the `FLUSH TABLES WITH READ LOCK` statement:

```
mysql> FLUSH TABLES WITH READ LOCK;
```

Remember to use `SHOW MASTER STATUS` and record the binary log details for use when starting up the slave. The point in time of your snapshot and the binary log position must match. See [Section 16.1.1.4, “Obtaining the Master Replication Information”](#).

- In another session, use `mysqldump` to create a dump either of all the databases you want to replicate, or of selected individual databases. For example:

```
shell> mysqldump --all-databases --lock-all-tables >dbdump.db
```

- An alternative to using a bare dump, is to use the `--master-data` option, which automatically appends the `CHANGE MASTER TO` statement required on the slave to start the replication process.

```
shell> mysqldump --all-databases --master-data >dbdump.db
```

- In the client where you acquired the read lock, release the lock:

```
mysql> UNLOCK TABLES;
```

When choosing databases to include in the dump, remember that you will need to filter out databases on each slave that you do not want to include in the replication process.

You will need either to copy the dump file to the slave, or to use the file from the master when connecting remotely to the slave to import the data.

### 16.1.1.6. Creating a Data Snapshot Using Raw Data Files

If your database is particularly large, copying the raw data files may be more efficient than using `mysqldump` and importing the file on each slave.

However, using this method with tables in storage engines with complex caching or logging algorithms may not give you a perfect “in time” snapshot as cache information and logging updates may not have been applied, even if you have acquired a global read lock. How the storage engine responds to this depends on its crash recovery abilities.

In addition, this method does not work reliably if the master and slave have different values for `ft_stopword_file`, `ft_min_word_len`, or `ft_max_word_len` and you are copying tables having fulltext indexes.

If you are using `InnoDB` tables, you should use the `InnoDB Hot Backup` tool to obtain a consistent snapshot. This tool records the log name and offset corresponding to the snapshot to be later used on the slave. `Hot Backup` is a non-free (commercial) tool that is not included in the standard MySQL distribution. See the `InnoDB Hot Backup` home page at <http://www.innodb.com/hot-backup> for detailed information.

Otherwise, you can obtain a reliable binary snapshot of `InnoDB` tables only after shutting down the MySQL Server.

To create a raw data snapshot of `MyISAM` tables you can use standard copy tools such as `cp` or `copy`, a remote copy tool such as `scp` or `rsync`, an archiving tool such as `zip` or `tar`, or a file system snapshot tool such as `dump`, providing that your MySQL data files exist on a single file system. If you are replicating only certain databases then make sure you copy only those files that related to those tables. (For `InnoDB`, all tables in all databases are stored in a single file unless you have the `in-`

`nodb_file_per_table` option enabled.)

You may want to specifically exclude the following files from your archive:

- Files relating to the `mysql` database.
- The `master.info` file.
- The master's binary log files.
- Any relay log files.

To get the most consistent results with a raw data snapshot you should shut down the server during the process, as below:

1. Acquire a read lock and get the master's status. See [Section 16.1.1.4, “Obtaining the Master Replication Information”](#).
2. In a separate session, shut down the MySQL server:

```
shell> mysqladmin shutdown
```

3. Make a copy of the MySQL data files. Examples are shown below for common ways to do this - you need to choose only one of them:

```
shell> tar cf /tmp/db.tar ./data
shell> zip -r /tmp/db.zip ./data
shell> rsync --recursive ./data /tmp/dbdata
```

4. Start up the MySQL instance on the master.

If you are not using `InnoDB` tables, you can get a snapshot of the system from a master without shutting down the server as described in the following steps:

1. Acquire a read lock and get the master's status. See [Section 16.1.1.4, “Obtaining the Master Replication Information”](#).
2. Take a copy of the MySQL data files. Examples are shown below for common solutions - you need to choose only one of these solutions:

```
shell> tar cf /tmp/db.tar ./data
shell> zip -r /tmp/db.zip ./data
shell> rsync --recursive ./data /tmp/dbdata
```

3. In the client where you acquired the read lock, release the lock:

```
mysql> UNLOCK TABLES;
```

Once you have created the archive or copy of the database, you will need to copy the files to each slave before starting the slave replication process.

### 16.1.1.7. Setting Up Replication with New Master and Slaves

Setting up replication with a new master and slaves (that is, with no existing data) is the easiest and most straightforward method for setting up replication.

You can also use this method if you are setting up new servers but have an existing dump of the databases from a different server that you want to load into your replication configuration. By loading the data into a new master, the data will be automatically replicated to the slaves.

To set up replication between a new master and slave:

1. Configure the MySQL master with the necessary configuration properties. See [Section 16.1.1.2, “Setting the Replication Master Configuration”](#).
2. Start up the MySQL master.
3. Set up a user. See [Section 16.1.1.1, “Creating a User for Replication”](#).

4. Obtain the master status information. See [Section 16.1.1.4, “Obtaining the Master Replication Information”](#).
5. On the master, release the read lock:

```
mysql> UNLOCK TABLES;
```

6. On the slave, edit the MySQL configuration. See [Section 16.1.1.3, “Setting the Replication Slave Configuration”](#).
7. Start up the MySQL slave.
8. Execute the `CHANGE MASTER TO` statement to set the master replication server configuration.

Perform the slave setup steps on each slave.

Because there is no data to load or exchange on a new server configuration you do not need to copy or import any information.

If you are setting up a new replication environment using the data from a different existing database server, you will now need to run the dump file generated from that server on the new master. The database updates will automatically be propagated to the slaves:

```
shell> mysql -h master < fulldb.dump
```

### 16.1.1.8. Setting Up Replication with Existing Data

When setting up replication with existing data, you will need to decide how best to get the data from the master to the slave before starting the replication service.

The basic process for setting up replication with existing data is as follows:

1. If you have not already configured the `server-id` and binary logging, you will need to shut down your master to configure these options. See [Section 16.1.1.2, “Setting the Replication Master Configuration”](#).

If you have to shut down your master server, this is a good opportunity to take a snapshot of its databases. You should obtain the master status (see [Section 16.1.1.4, “Obtaining the Master Replication Information”](#)) before taking down the master, updating the configuration and taking a snapshot. For information on how to create a snapshot using raw data files, see [Section 16.1.1.6, “Creating a Data Snapshot Using Raw Data Files”](#).

2. If your server is already correctly configured, obtain the master status (see [Section 16.1.1.4, “Obtaining the Master Replication Information”](#)) and then use `mysqldump` to take a snapshot (see [Section 16.1.1.5, “Creating a Data Snapshot Using `mysqldump`”](#)) or take a raw snapshot of the live server using the guide in [Section 16.1.1.6, “Creating a Data Snapshot Using Raw Data Files”](#).
3. With the MySQL master running, create a user to be used by the slave when connecting to the master during replication. See [Section 16.1.1.1, “Creating a User for Replication”](#).
4. Update the configuration of the slave. See [Section 16.1.1.3, “Setting the Replication Slave Configuration”](#).
5. The next step depends on how you created the snapshot of data on the master.

If you used `mysqldump`:

- a. Start the slave, skipping replication by using the `--skip-slave` option.
- b. Import the dump file:

```
shell> mysql < fulldb.dump
```

If you created a snapshot using the raw data files:

- a. Extract the data files into your slave data directory. For example:

```
shell> tar xvf dbdump.tar
```

You may need to set permissions and ownership on the files to match the configuration of your slave.

- b. Start the slave, skipping replication by using the `--skip-slave` option.

- Configure the slave with the master status information. This will tell the slave the binary log file and position within the file where replication needs to start, and configure the login credentials and host name of the master. For more information on the statement required, see [Section 16.1.1.10, “Setting the Master Configuration on the Slave”](#).
- Start the slave threads:

```
mysql> START SLAVE;
```

After you have performed this procedure, the slave should connect to the master and catch up on any updates that have occurred since the snapshot was taken.

If you have forgotten to set the `server-id` option for the master, slaves cannot connect to it.

If you have forgotten to set the `server-id` option for the slave, you get the following error in the slave's error log:

```
Warning: You should set server-id to a non-0 value if master_host
is set; we will force server id to 2, but this MySQL server will
not act as a slave.
```

You also find error messages in the slave's error log if it is not able to replicate for any other reason.

Once a slave is replicating, you can find in its data directory one file named `master.info` and another named `relay-log.info`. The slave uses these two files to keep track of how much of the master's binary log it has processed. Do *not* remove or edit these files unless you know exactly what you are doing and fully understand the implications. Even in that case, it is preferred that you use the `CHANGE MASTER TO` statement to change replication parameters. The slave will use the values specified in the statement to update the status files automatically.

### Note

The content of `master.info` overrides some of the server options specified on the command line or in `my.cnf`. See [Section 16.1.3, “Replication and Binary Logging Options and Variables”](#), for more details.

Once you have a snapshot of the master, you can use it to set up other slaves by following the slave portion of the procedure just described. You do not need to take another snapshot of the master; you can use the same one for each slave.

## 16.1.1.9. Introducing Additional Slaves to an Existing Replication Environment

If you want to add another slave to the existing replication configuration then you can do so without stopping the master. Instead, you duplicate the settings on the slaves by making a copy of one of the slaves.

To duplicate the slave:

- Shut down the existing slave:

```
shell> mysqladmin shutdown
```

- Copy the data directory from the existing slave to the new slave. You can do this by creating an archive using `tar` or `Win-Zip`, or by performing a direct copy using a tool such as `cp` or `rsync`. Ensure that you also copy the log files and relay log files.

### Note

A common problem that is encountered when adding new replication slaves is that the new slave fails with a series of warning and error messages like these:

```
071118 16:44:10 [Warning] Neither --relay-log nor --relay-log-index were used; so
replication may break when this MySQL server acts as a slave and has his hostname
changed!! Please use '--relay-log=new_slave_hostname-relay-bin' to avoid this problem.
071118 16:44:10 [ERROR] FAILED TO OPEN THE RELAY LOG './OLD_SLAVE_HOSTNAME-RELAY-BIN.003525'
(RELAY_LOG_POS 22940879)
071118 16:44:10 [ERROR] COULD NOT FIND TARGET LOG DURING RELAY LOG INITIALIZATION
071118 16:44:10 [ERROR] FAILED TO INITIALIZE THE MASTER INFO STRUCTURE
```

This is due to the fact that, if the `--relay-log` option is not specified, the relay log files contain the host name as part of their file names. (This is also true of the relay log index file if the `--relay-log-index` option is not used. See [Section 16.1.3, “Replication and Binary Logging Options and Variables”](#), for more information about these options.)

To avoid this problem, use the same value for `--relay-log` on the new slave that was used on the existing slave. (If this option was not set explicitly on the existing slave, use `existing_slave_hostname-relay-bin`.) If

this is not feasible, then copy the existing slave's relay log index file to the new slave and set the `-relay-log-index` option on the new slave to match what was used on the existing slave. (If this option was not set explicitly on the existing slave, use `existing_slave_hostname-relay-bin.index`.) Alternatively — if you have already tried to start the new slave (after following the remaining steps in this section) and have encountered errors like those described previously — then perform the following steps:

- a. If you have not already done so, issue a `STOP SLAVE` on the new slave.  
If you have already started the existing slave again, issue a `STOP SLAVE` on the existing slave as well.
  - b. Copy the contents of the existing slave's relay log index file into the new slave's relay log index file, making sure to overwrite any content already in the file.
  - c. Proceed with the remaining steps in this section.
3. Copy the `master.info` and `relay-log.info` files from the existing slave to the new slave. These files hold the current log positions.
  4. Start the existing slave.
  5. On the new slave, edit the configuration and give the new slave a new unique `server-id`.
  6. Start the new slave; the `master.info` file options will be used to start the replication process.

### 16.1.1.10. Setting the Master Configuration on the Slave

To set up the slave to communicate with the master for replication, you must tell the slave the necessary connection information. To do this, execute the following statement on the slave, replacing the option values with the actual values relevant to your system:

```
mysql> CHANGE MASTER TO
->     MASTER_HOST='master_host_name',
->     MASTER_USER='replication_user_name',
->     MASTER_PASSWORD='replication_password',
->     MASTER_LOG_FILE='recorded_log_file_name',
->     MASTER_LOG_POS=recorded_log_position;
```

#### Note

Replication cannot use Unix socket files. You must be able to connect to the master MySQL server using TCP/IP.

The following table shows the maximum allowable length for the string-valued options.

Option	Maximum Length
<code>MASTER_HOST</code>	60
<code>MASTER_USER</code>	16
<code>MASTER_PASSWORD</code>	32
<code>MASTER_LOG_FILE</code>	255

### 16.1.2. Replication Formats

Replication works because events written to the binary log are read from the master and then processed on the slave. The events are recorded within the binary log in different formats according to the type of event being recorded. The different replication formats used correspond to the binary logging format used when the events were recorded in the master's binary log. The correlation between binary logging formats and the terms used during replication are:

- Replication capabilities in MySQL originally were based on propagation of SQL statements from master to slave. This is called *statement-based replication* (often abbreviated as *SBR*), which corresponds to the standard statement-based binary logging format. In MySQL 5.1.4 and earlier, binary logging and replication used this format exclusively.
- Row-based binary logging logs changes in individual table rows. When used with MySQL replication, this is known as *row-based replication* (often abbreviated as *RBR*). In row-based replication, the master writes messages known as *events* to the binary log that indicate how individual table rows are changed.
- As of MySQL 5.1.8, the binary logging format can be changed in real time according to the event being logged using *mixed-format logging*.

When the mixed format is in effect, statement-based logging is used by default, but automatically switches to row-based logging in particular cases as described below. Replication using the mixed format is often referred to as *mixed-based replication* or *mixed-format replication*. For more information, see [Section 5.2.4.3, “Mixed Binary Logging Format”](#).

From MySQL 5.1.12 to MySQL 5.1.28 (inclusive), the mixed format is the default for MySQL replication. Beginning with MySQL 5.1.29, statement-based format is the default.

### Note

**MySQL Cluster.** The default binary logging format in all MySQL Cluster NDB 6.1, 6.2, 6.3, and later 6.x releases is `ROW`. MySQL Cluster Replication always uses row-based replication, and the `NDBCLUSTER` storage engine is incompatible with statement-based replication. Using `NDBCLUSTER` sets row-based logging format automatically.

See [MySQL Cluster Replication — Assumptions and General Requirements](#), for more information.

Starting with MySQL 5.1.20, when using `MIXED` format, the binary logging format is determined in part by the storage engine being used and the statement being executed. For more information on mixed-format logging and the rules governing the support of different logging formats, see [Section 5.2.4.3, “Mixed Binary Logging Format”](#).

The logging format in a running MySQL server is controlled by setting the `binlog_format` server system variable. This variable can be set with session or global scope. The rules governing when and how the new setting takes effect are the same as for other MySQL server system variables — setting the variable for the current session lasts only until the end of that session, and the change is not visible to other sessions; setting the variable globally requires a restart of the server in order to take effect. For more information, see [Section 12.5.4, “SET Syntax”](#).

You must have the `SUPER` privilege to set the binary logging format on the global level. Starting with MySQL 5.1.29, you must also have the `SUPER` privilege to set the binary logging format for the current session. ([Bug#39106](#))

The statement-based and row-based replication formats have different issues and limitations. For a comparison of their relative advantages and disadvantages, see [Section 16.1.2.1, “Comparison of Statement-Based and Row-Based Replication”](#).

With statement-based replication, you may encounter issues with replicating stored routines or triggers. You can avoid these issues by using row-based replication instead. For more information, see [Section 18.6, “Binary Logging of Stored Programs”](#).

If you build MySQL from source, row-based replication is available by default unless you invoke `configure` with the `--without-row-based-replication` option.

For MySQL 5.1.20 and later (and MySQL 5.0.46 for backward compatibility), the following session variables are written to the binary log and honored by the replication slave when parsing the binary log:

- `sql_mode`
- `foreign_key_checks`
- `unique_checks`
- `character_set_client`
- `collation_connection`
- `collation_database`
- `collation_server`
- `sql_auto_is_null`

### Important

Even though session variables relating to character sets and collations are written to the binary log, replication between different character sets is not supported.

## 16.1.2.1. Comparison of Statement-Based and Row-Based Replication

Each binary logging format has advantages and disadvantages. For most users, the mixed replication format should provide the best combination of data integrity and performance. If, however, you want to take advantage of the features specific to the statement-based or row-based replication format when performing certain tasks, then you can use the information in this section, which provides a summary of their relative advantages and disadvantages, to determine which is best for your needs.



**Advantages of statement-based replication:**

- Proven technology that has existed in MySQL since 3.23.
- Less data written to log files. When updates or deletes affect many rows, this results in *much* less storage space required for log files. This also means that taking and restoring from backups can be accomplished more quickly.
- Log files contain all statements that made any changes, so they can be used to audit the database.
- Tables replicated using statement-based replication are not required to have explicit primary keys.

**Disadvantages of statement-based replication:**

- **Statements which are unsafe for SBR.** Not all statements which modify data (such as `INSERT DELETE`, `UPDATE`, and `REPLACE` statements) can be replicated using statement-based replication. Any non-deterministic behavior is difficult to replicate when using statement-based replication. Examples of such DML (Data Modification Language) statements include the following:
  - A statement that depends on a UDF or stored program that is non-deterministic, since the value returned by such a UDF or stored program or depends on factors other than the parameters supplied to it. (Row-based replication, however, simply replicates the value returned by the UDF or stored program, so its effect on table rows and data is the same on both the master and slave.) See [Section 16.3.1.7, “Replication of Invoked Features”](#), for more information.
  - `DELETE` and `UPDATE` statements that use a `LIMIT` clause without an `ORDER BY` are also non-deterministic. See [Section 16.3.1.11, “Replication and LIMIT”](#).
  - Statements using any of the following functions cannot be replicated properly using statement-based replication:
    - `LOAD_FILE()`
    - `UUID()`, `UUID_SHORT()`
    - `USER()`
    - `FOUND_ROWS()`
    - `SYSDATE()` (unless the server is started with the `--sysdate-is-now` option)

However, all other functions are replicated correctly using statement-based replication, including `RAND()`, `NOW()`, `LOAD DATA INFILE`, and so forth.

For more information, see [Section 16.3.1.10, “Replication and System Functions”](#).

When using statement-based replication, statements that cannot be replicated correctly using statement-based mode are logged with a warning like the one shown here:

```
090213 16:58:54 [Warning] Statement is not safe to log in statement format.
```

A similar warning is also issued to the client in such cases.

- `INSERT ... SELECT` requires a greater number of row-level locks than with row-based replication.
- `UPDATE` statements that require a table scan (because no index is used in the `WHERE` clause) must lock a greater number of rows than with row-based replication.
- For InnoDB: An `INSERT` statement that uses `AUTO_INCREMENT` blocks other non-conflicting `INSERT` statements.
- For complex statements, the statement must be evaluated and executed on the slave before the rows are updated or inserted. With row-based replication, the slave only has to run the statement to apply the differences, not the full statement.
- Stored functions execute with the same `NOW()` value as the calling statement. However, this is not true of stored procedures.
- Deterministic UDFs must be applied on the slaves.
- If there is an error in evaluation on the slave, particularly when executing complex statements, then using statement-based replication may slowly increase the margin of error across the affected rows over time. See [Section 16.3.1.20, “Slave Errors during Replication”](#).



- Tables must be (nearly) identical on master and slave. See [Section 16.3.1.4, “Replication with Differing Tables on Master and Slave”](#), for more information.

**Advantages of row-based replication:**

- All changes can be replicated. This is the safest form of replication.

For MySQL versions earlier than 5.1.14, DDL (Data Definition Language) statements such as `CREATE TABLE` are replicated using statement-based replication, while DML statements, as well as `GRANT` and `REVOKE` statements, are replicated using row-based-replication.

In MySQL 5.1.14 and later, the `mysql` database is not replicated. The `mysql` database is instead seen as a node-specific database. Row-based replication is not supported on tables in this database. Instead, statements that would normally update this information — such as `GRANT`, `REVOKE` and the manipulation of triggers, stored routines (including stored procedures), and views — are all replicated to slaves using statement-based replication.

For statements like `CREATE . . . SELECT`, a `CREATE` statement is generated from the table definition and replicated using the statement-based format, while the row insertions are replicated using the row-based format.

- The technology is the same as in most other database management systems; knowledge about other systems transfers to MySQL.
- Fewer locks are needed (and thus higher concurrency) on the master for the following types of statements:
  - `INSERT . . . SELECT`
  - `INSERT` statements with `AUTO_INCREMENT`
  - `UPDATE` or `DELETE` statements with `WHERE` clauses that don't use keys or don't change most of the examined rows.
- Fewer locks are required on the slave for any `INSERT`, `UPDATE`, or `DELETE` statement.

**Disadvantages of row-based replication:**

- RBR tends to generate more data that must be logged. This is because, when using row-based replication to replicate a DML statement (such as an `UPDATE` or `DELETE` statement), each changed row must be written to the binary log. (When using statement-based replication, only the statement is written to the binary log.) This means that, if the statement changes many rows, row-based replication may write significantly more data to the binary log; this is true even for statements that are rolled back. This also means that taking and restoring from backup can require more time. In addition, the binary log is locked for a longer time to write the data, which may cause concurrency problems.
- All tables replicated using row-based replication must have explicit primary keys.
- Deterministic UDFs that generate large `BLOB` values take longer to replicate with row-based replication than with statement-based replication. This is because, when using row-based replication, the `BLOB` column data is itself logged, rather than the statement generating the data.
- You cannot examine the logs to see what statements were executed, nor can you see on the slave what statements were received from the master and executed.

However, beginning with MySQL 5.1.29, you can see what data was changed using `mysqlbinlog` with the options `--base64-output=DECODE-ROWS` and `--verbose`.

- When performing a bulk operation that includes non-transactional storage engines, changes are applied as the statement executes. With row-based replication logging, this means that the binary log is written while the statement is running. On the master, this does not cause problems with concurrency, because tables are locked until the bulk operation terminates. On the slave server, however, tables are not locked while the slave applies changes, because the slave does not know that those changes are part of a bulk operation.

In such cases, if you retrieve data from a table on the master (for example, using `SELECT * FROM table_name`), the server waits for the bulk operation to complete before executing the `SELECT` statement, because the table is read-locked. On the slave, the server does not wait (because there is no lock). This means that, until the bulk operation on the slave has completed, you obtain different results for the same `SELECT` query on the master and on the slave.

This behavior is expected to change in a future MySQL release; however, until it changes, you may prefer to use statement-based replication when your application requires concurrent large bulk inserts and selects.

## 16.1.2.2. Usage of Row-based Logging and Row-Based Replication

Using row-based logging or replication, rather than statement-based logging or replication, can result in major changes in the replication environment and in the behavior of applications. This section describes a number of issues known to exist when using row-based logging or row-based replication, and discusses some best practices for taking advantage of row-based logging (RBL) and row-based replication (RBR).

For additional information, see [Section 16.1.2.1, “Comparison of Statement-Based and Row-Based Replication”](#), and [Section 16.1.2, “Replication Formats”](#).

- **RBR and primary keys.** Currently, row-based replication may fail if any table to be replicated does not have an explicit primary key. This is a known issue which we are working to fix in a future MySQL release.

### Note

Beginning with MySQL 5.1.7, it is possible to replicate `NDBCLUSTER` tables without explicit primary keys. However, in the event that a MySQL Cluster data node fails, MySQL Cluster Replication can also fail for tables without explicit primary keys. For this reason, it is highly recommended that all `NDBCLUSTER` tables being replicated have explicit primary keys. For more information, see [Known Issues in MySQL Cluster Replication](#).

- **RBL, RBR, and temporary tables.** As noted elsewhere in this chapter (see [Section 16.3.1.22, “Replication and Temporary Tables”](#)), temporary tables are not replicated when using the row-based format. However, you can use the mixed format; when mixed format is in effect, “safe” statements involving temporary tables are logged using the statement-based format. For more information, see [Section 16.1.2.1, “Comparison of Statement-Based and Row-Based Replication”](#).

### Note

There is actually no need to replicate temporary tables when using RBR. In addition, since temporary tables can be read only from the thread which created them, there is seldom if ever any benefit obtained from replicating them, even when using statement-based mode.

- **RBL and the `BLACKHOLE` storage engine.** Prior to MySQL 5.1.29, `DELETE` and `UPDATE` statements did not work with RBL and `BLACKHOLE` tables. ([Bug#38360](#))
- **RBL and synchronization of non-transactional tables.** When using row-based replication of a `MyISAM` or other non-transactional table, changed rows are written to the transaction cache. Often, when many rows are affected, the set of changes are split into several events; when the statement commits, all of these events are written to the binary log. When executing on the slave, a table lock is taken on all tables involved, then the rows are applied in batch mode. (This may or may not be effective, depending on the engine used for the slave’s copy of the table).
- **Latency and binary log size.** Because RBL writes changes for each row to the binary log, the size of the binary log can grow quite rapidly. When used in a replication environment, this can significantly increase the time required for making the changes on the slave that match those on the master. You should be aware of the potential for this delay in your applications.
- **Reading the binary log.** With the `--base64-output=DECODE-ROWS` and `--verbose` options, `mysqlbinlog` is able to format the contents of the binary log in a manner that is easily human-readable, in case you want to read or recover from a replication or database failure using the contents of the binary log. For more information, see [Section 4.6.7.2, “mysqlbinlog Row Event Display”](#). Before MySQL 5.1.28, this was not possible ([Bug#31455](#)).
- **Binary log execution errors and `slave_exec_mode`.** If you use `slave_exec_mode=IDEMPOTENT`, a failure to apply changes from RBL because the original row cannot be found does not trigger an error, and does not cause replication to fail. This means that it is possible that updates are not applied on the slave, so that the master and slave are no longer synchronized. Latency issues and use of non-transactional tables when using `slave_exec_mode=IDEMPOTENT` and RBR can cause the master and slave to diverge even further. For more information about `slave_exec_mode`, see [Section 5.1.3, “Server System Variables”](#).

### Note

`slave_exec_mode=IDEMPOTENT` is generally useful only for circular replication or multi-master replication with MySQL Cluster (see [MySQL Cluster Replication](#)). For other scenarios, the default value (`slave_exec_mode=STRICT`) is normally sufficient.

- **Lack of binary log checksums.** No checksums are used for RBL. This means that network, disk, and other errors may not be identified when processing the binary log. To ensure that data is transmitted without network corruption, you may want to consider using SSL, which adds another layer of checksumming, for replication connections. See [Section 5.5.7, “Using SSL for Secure Connections”](#), for more information about setting up MySQL with SSL.
- **Filtering based on server ID not supported.** A common practice is to filter out changes on some slaves by using a `WHERE` clause that includes the relation `@server_id <> server-id` clause with `UPDATE` and `DELETE` statements, a simple ex-

ample of such a clause being `WHERE @server_id <> 1`. However, this does not work correctly with row-based logging. If you must use the `server_id` system variable for statement filtering, then you must also use `--binlog_format=STATEMENT`.

- **Database-level replication options.** The effects of the options `--replicate-do-db`, `--replicate-ignore-db`, and `--replicate-rewrite-db` differ considerably depending on whether row-based or statement-based logging is in use. Because of this, we recommend that you avoid the database-level options and use the table-level options such as `--replicate-do-table` and `--replicate-ignore-table` instead. For more information about these options and the impact that your choice of replication format has on how they operate, see [Section 16.1.3, “Replication and Binary Logging Options and Variables”](#).

### 16.1.3. Replication and Binary Logging Options and Variables

The next few sections contain information about `mysqld` options and server variables that are used in replication and for controlling the binary log. Options and variables for use on replication masters and replication slaves are covered separately, as are options and variables relating to binary logging. A set of quick-reference tables providing basic information about these options and variables is also included (in the next section following this one).

Of particular importance is the `--server-id` option.

<b>Command Line Format</b>	<code>--server-id=#</code>	
<b>Config File Format</b>	<code>server-id</code>	
<b>Option Sets Variable</b>	Yes, <code>server_id</code>	
<b>Variable Name</b>	<code>server_id</code>	
<b>Variable Scope</b>	Global	
<b>Dynamic Variable</b>	Yes	
<b>Value Set</b>	<b>Type</b>	<code>numeric</code>
	<b>Default</b>	<code>0</code>
	<b>Range</b>	<code>0-4294967295</code>

This option is common to both master and slave replication servers, and is used in replication to enable master and slave servers to identify themselves uniquely. For additional information, see [Section 16.1.3.2, “Replication Master Options and Variables”](#), and [Section 16.1.3.3, “Replication Slave Options and Variables”](#).

On the master and each slave, you *must* use the `--server-id` option to establish a unique replication ID in the range from 1 to  $2^{32} - 1$ ; by “unique”, we mean that each ID must be different from every other ID in use by any other replication master or slave. Example: `server-id=3`.

If you omit `--server-id`, it assumes the default value 0, in which case a master refuses connections from all slaves, and a slave refuses to connect to a master. See [Section 16.1.1.3, “Setting the Replication Slave Configuration”](#), for more information.

#### 16.1.3.1. Replication and Binary Logging Option and Variable Reference

The following tables list basic information about the MySQL command-line options and system variables applicable to replication and the binary log.

**Table 16.1. `mysqld` Replication Option/Variable Summary**

Name	Cmd-Line	Option file	System Var	Status Var	Var Scope	Dynamic
<a href="#">abort-slave-event-count</a>	Yes	Yes				
<a href="#">Com_change_master</a>				Yes	Both	No
<a href="#">Com_show_master_status</a>				Yes	Both	No
<a href="#">Com_show_new_master</a>				Yes	Both	No
<a href="#">Com_show_slave_hosts</a>				Yes	Both	No
<a href="#">Com_show_slave_status</a>				Yes	Both	No
<a href="#">Com_slave_start</a>				Yes	Both	No
<a href="#">Com_slave_stop</a>				Yes	Both	No
<a href="#">disconnect-slave-event-count</a>	Yes	Yes				

Name	Cmd-Line	Option file	System Var	Status Var	Var Scope	Dynamic
<a href="#">have_row_based_replication</a>			Yes		Global	No
<a href="#">init_slave</a>	Yes	Yes	Yes		Global	Yes
<a href="#">log_slave_updates</a>	Yes	Yes			Global	No
- <i>Variable:</i> <a href="#">log_slave_updates</a>			Yes		Global	No
<a href="#">master_bind</a>	Yes	Yes	Yes			No
<a href="#">master_connect_retry</a>	Yes	Yes				
<a href="#">master_host</a>	Yes	Yes				
<a href="#">master_info_file</a>	Yes	Yes				
<a href="#">master_password</a>	Yes	Yes				
<a href="#">master_port</a>	Yes	Yes				
<a href="#">master_retry_count</a>	Yes	Yes				
<a href="#">master_ssl</a>	Yes	Yes				
<a href="#">master_ssl_ca</a>	Yes	Yes				
<a href="#">master_ssl_capath</a>	Yes	Yes				
<a href="#">master_ssl_cert</a>	Yes	Yes				
<a href="#">master_ssl_cipher</a>	Yes	Yes				
<a href="#">master_ssl_key</a>	Yes	Yes				
<a href="#">master_user</a>	Yes	Yes				
<a href="#">relay_log</a>	Yes	Yes				
<a href="#">relay_log_index</a>	Yes	Yes				
- <i>Variable:</i> <a href="#">relay_log_index</a>						
<a href="#">relay_log_purge</a>	Yes	Yes	Yes		Global	Yes
<a href="#">replicate_do_db</a>	Yes	Yes				
<a href="#">replicate_do_table</a>	Yes	Yes				
<a href="#">replicate_ignore_db</a>	Yes	Yes				
<a href="#">replicate_ignore_table</a>	Yes	Yes				
<a href="#">replicate_rewrite_db</a>	Yes	Yes				
<a href="#">replicate_same_server_id</a>	Yes	Yes				
<a href="#">replicate_wild_do_table</a>	Yes	Yes				
<a href="#">replicate_wild_ignore_table</a>	Yes	Yes				
<a href="#">report_host</a>	Yes	Yes			Global	No
- <i>Variable:</i> <a href="#">report_host</a>			Yes		Global	No
<a href="#">report_password</a>	Yes	Yes			Global	No
- <i>Variable:</i> <a href="#">report_password</a>			Yes		Global	No
<a href="#">report_port</a>	Yes	Yes			Global	No
- <i>Variable:</i> <a href="#">report_port</a>			Yes		Global	No
<a href="#">report_user</a>	Yes	Yes			Global	No
- <i>Variable:</i> <a href="#">report_user</a>			Yes		Global	No
<a href="#">rpl_recovery_rank</a>			Yes		Global	Yes
<a href="#">Rpl_status</a>				Yes	Global	No
<a href="#">show_slave_auth_info</a>	Yes	Yes				
<a href="#">skip_slave_start</a>	Yes	Yes				
<a href="#">slave_compressed_protocol</a>	Yes	Yes	Yes		Global	Yes
<a href="#">slave_exec_mode</a>			Yes		Global	Yes
<a href="#">Slave_heartbeat_period</a>				Yes	Global	No
<a href="#">slave_load_tmpdir</a>	Yes	Yes			Global	No
- <i>Variable:</i> <a href="#">slave_load_tmpdir</a>			Yes		Global	No

Name	Cmd-Line	Option file	System Var	Status Var	Var Scope	Dynamic
<a href="#">slave-net-timeout</a>	Yes	Yes			Global	Yes
- Variable: <code>slave_net_timeout</code>			Yes		Global	Yes
<a href="#">Slave_open_temp_tables</a>				Yes	Global	No
<a href="#">Slave_received_heartbeats</a>				Yes	Global	No
<a href="#">Slave_retried_transactions</a>				Yes	Global	No
<a href="#">Slave_running</a>				Yes	Global	No
<a href="#">slave-skip-errors</a>	Yes	Yes			Global	No
- Variable: <code>slave_skip_errors</code>			Yes		Global	No
<a href="#">slave_transaction_retries</a>	Yes	Yes	Yes		Global	Yes
<a href="#">sql_slave_skip_counter</a>			Yes		Global	Yes

Section 16.1.3.2, “Replication Master Options and Variables”, provides more detailed information about options and variables relating to replication master servers. For more information about options and variables relating to replication slaves Section 16.1.3.3, “Replication Slave Options and Variables”.

**Table 16.2. `mysqld` Binary Logging Option/Variable Summary**

Name	Cmd-Line	Option file	System Var	Status Var	Var Scope	Dynamic
<a href="#">Binlog_cache_disk_use</a>				Yes	Global	No
<a href="#">binlog_cache_size</a>	Yes	Yes	Yes		Global	Yes
<a href="#">Binlog_cache_use</a>				Yes	Global	No
<a href="#">binlog-do-db</a>	Yes	Yes				
<a href="#">binlog-format</a>	Yes	Yes			Both	Yes
- Variable: <code>binlog_format</code>			Yes		Both	Yes
<a href="#">binlog-ignore-db</a>	Yes	Yes				
<a href="#">binlog-row-event-max-size</a>	Yes	Yes				
<a href="#">Com_show_binlog_events</a>				Yes	Both	No
<a href="#">Com_show_binlogs</a>				Yes	Both	No
<a href="#">max_binlog_cache_size</a>	Yes	Yes	Yes		Global	Yes
<a href="#">max-binlog-dump-events</a>	Yes	Yes				
<a href="#">max_binlog_size</a>	Yes	Yes	Yes		Global	Yes
<a href="#">sporadic-binlog-dump-fail</a>	Yes	Yes				

Section 16.1.3.4, “Binary Log Options and Variables”, provides more detailed information about options and variables relating to binary logging. For additional general information about the binary log, see Section 5.2.4, “The Binary Log”.

For a table showing *all* command-line options, system and status variables used with `mysqld`, see Section 5.1.1, “Server Option and Variable Reference”.

### 16.1.3.2. Replication Master Options and Variables

This section describes the server options and system variables that you can use on replication master servers. You can specify the options either on the [command line](#) or in an [option file](#). You can specify system variable values using [SET](#).

On the master and each slave, you must use the `server-id` option to establish a unique replication ID. For each server, you should pick a unique positive integer in the range from 1 to  $2^{32} - 1$ , and each ID must be different from every other ID in use by any other replication master or slave. Example: `server-id=3`.

For options used on the master for controlling binary logging, see Section 16.1.3.4, “Binary Log Options and Variables”.

- `auto_increment_increment`

Command Line Format	
	<code>--auto_increment_increment[=#]</code>

<b>Config File Format</b>	<code>auto_increment_increment</code>	
<b>Option Sets Variable</b>	Yes, <code>auto_increment_increment</code>	
<b>Variable Name</b>	<code>auto_increment_increment</code>	
<b>Variable Scope</b>	Both	
<b>Dynamic Variable</b>	Yes	
<b>Value Set</b>	<b>Type</b>	numeric
	<b>Default</b>	1
	<b>Range</b>	1-65535

`auto_increment_increment` and `auto_increment_offset` are intended for use with master-to-master replication, and can be used to control the operation of `AUTO_INCREMENT` columns. Both variables have global and session values, and each can assume an integer value between 1 and 65,535 inclusive. Setting the value of either of these two variables to 0 causes its value to be set to 1 instead. Attempting to set the value of either of these two variables to an integer greater than 65,535 or less than 0 causes its value to be set to 65,535 instead. Attempting to set the value of `auto_increment_increment` or `auto_increment_offset` to a non-integer value gives rise to an error, and the actual value of the variable remains unchanged.

### Note

`auto_increment_increment` is supported for use with NDB tables beginning with MySQL 5.1.20, MySQL Cluster NDB 6.2.5, and MySQL Cluster NDB 6.3.2. Previously, setting it when using MySQL Cluster tables or MySQL Cluster Replication produced unpredictable results.

These two variables affect `AUTO_INCREMENT` column behavior as follows:

- `auto_increment_increment` controls the interval between successive column values. For example:

```
mysql> SHOW VARIABLES LIKE 'auto_inc%';
+-----+-----+
| Variable_name | Value |
+-----+-----+
| auto_increment_increment | 1 |
| auto_increment_offset | 1 |
+-----+-----+
2 rows in set (0.00 sec)

mysql> CREATE TABLE autoinc1
-> (col INT NOT NULL AUTO INCREMENT PRIMARY KEY);
Query OK, 0 rows affected (0.04 sec)

mysql> SET @@auto_increment_increment=10;
Query OK, 0 rows affected (0.00 sec)

mysql> SHOW VARIABLES LIKE 'auto_inc%';
+-----+-----+
| Variable_name | Value |
+-----+-----+
| auto_increment_increment | 10 |
| auto_increment_offset | 1 |
+-----+-----+
2 rows in set (0.01 sec)

mysql> INSERT INTO autoinc1 VALUES (NULL), (NULL), (NULL), (NULL);
Query OK, 4 rows affected (0.00 sec)
Records: 4 Duplicates: 0 Warnings: 0

mysql> SELECT col FROM autoinc1;
+----+
| col |
+----+
| 1 |
| 11 |
| 21 |
| 31 |
+----+
4 rows in set (0.00 sec)
```

(Note how `SHOW VARIABLES` is used here to obtain the current values for these variables.)

- `auto_increment_offset` determines the starting point for the `AUTO_INCREMENT` column value. Consider the following, assuming that these statements are executed during the same session as the example given in the description for `auto_increment_increment`:

```
mysql> SET @@auto_increment_offset=5;
Query OK, 0 rows affected (0.00 sec)
```

```
mysql> SHOW VARIABLES LIKE 'auto_inc%';
+-----+-----+
| Variable_name | Value |
+-----+-----+
| auto_increment_increment | 10 |
| auto_increment_offset | 5 |
+-----+-----+
2 rows in set (0.00 sec)

mysql> CREATE TABLE autoinc2
-> (col INT NOT NULL AUTO_INCREMENT PRIMARY KEY);
Query OK, 0 rows affected (0.06 sec)

mysql> INSERT INTO autoinc2 VALUES (NULL), (NULL), (NULL), (NULL);
Query OK, 4 rows affected (0.00 sec)
Records: 4 Duplicates: 0 Warnings: 0

mysql> SELECT col FROM autoinc2;
+-----+
| col |
+-----+
| 5 |
| 15 |
| 25 |
| 35 |
+-----+
4 rows in set (0.02 sec)
```

If the value of `auto_increment_offset` is greater than that of `auto_increment_increment`, the value of `auto_increment_offset` is ignored.

Should one or both of these variables be changed and then new rows inserted into a table containing an `AUTO_INCREMENT` column, the results may seem counterintuitive because the series of `AUTO_INCREMENT` values is calculated without regard to any values already present in the column, and the next value inserted is the least value in the series that is greater than the maximum existing value in the `AUTO_INCREMENT` column. In other words, the series is calculated like so:

$$\text{auto\_increment\_offset} + N \times \text{auto\_increment\_increment}$$

where  $N$  is a positive integer value in the series [1, 2, 3, ...]. For example:

```
mysql> SHOW VARIABLES LIKE 'auto_inc%';
+-----+-----+
| Variable_name | Value |
+-----+-----+
| auto_increment_increment | 10 |
| auto_increment_offset | 5 |
+-----+-----+
2 rows in set (0.00 sec)

mysql> SELECT col FROM autoinc1;
+-----+
| col |
+-----+
| 1 |
| 11 |
| 21 |
| 31 |
+-----+
4 rows in set (0.00 sec)

mysql> INSERT INTO autoinc1 VALUES (NULL), (NULL), (NULL), (NULL);
Query OK, 4 rows affected (0.00 sec)
Records: 4 Duplicates: 0 Warnings: 0

mysql> SELECT col FROM autoinc1;
+-----+
| col |
+-----+
| 1 |
| 11 |
| 21 |
| 31 |
| 35 |
| 45 |
| 55 |
| 65 |
+-----+
8 rows in set (0.00 sec)
```

The values shown for `auto_increment_increment` and `auto_increment_offset` generate the series  $5 + N \times 10$ , that is, [5, 15, 25, 35, 45, ...]. The greatest value present in the `col` column prior to the `INSERT` is 31, and the next available value in the `AUTO_INCREMENT` series is 35, so the inserted values for `col` begin at that point and the results are as shown for the `SELECT` query.

It is not possible to confine the effects of these two variables to a single table, and thus they do not take the place of the se-

quences offered by some other database management systems; these variables control the behavior of all `AUTO_INCREMENT` columns in *all* tables on the MySQL server. If the global value of either variable is set, its effects persist until the global value is changed or overridden by setting the session value, or until `mysqld` is restarted. If the local value is set, the new value affects `AUTO_INCREMENT` columns for all tables into which new rows are inserted by the current user for the duration of the session, unless the values are changed during that session.

The default value of `auto_increment_increment` is 1. See [Section 16.3.1.1, “Replication and AUTO\\_INCREMENT”](#).

- `auto_increment_offset`

<b>Command Line Format</b>	<code>--auto_increment_offset[=#]</code>	
<b>Config File Format</b>	<code>auto_increment_offset</code>	
<b>Option Sets Variable</b>	Yes, <code>auto_increment_offset</code>	
<b>Variable Name</b>	<code>auto_increment_offset</code>	
<b>Variable Scope</b>	Both	
<b>Dynamic Variable</b>	Yes	
<b>Value Set</b>	<b>Type</b>	numeric
	<b>Default</b>	1
	<b>Range</b>	1-65535

This variable has a default value of 1. For particulars, see the description for `auto_increment_increment`.

#### Note

`auto_increment_offset` is supported for use with NDB tables beginning with MySQL 5.1.20, MySQL Cluster NDB 6.2.5, and MySQL Cluster NDB 6.3.2. Previously, setting it when using MySQL Cluster tables or MySQL Cluster Replication produced unpredictable results.

### 16.1.3.3. Replication Slave Options and Variables

This section describes the server options and system variables that you can use on slave replication servers. You can specify the options either on the [command line](#) or in an [option file](#). Many of the options can be reset while the server is running by using the [CHANGE MASTER TO](#) statement. You can specify system variable values using [SET](#).

**Server ID.** On the master and each slave, you must use the `server-id` option to establish a unique replication ID. For each server, you should pick a unique positive integer in the range from 1 to  $2^{32} - 1$ , and each ID must be different from every other ID. Example: `server-id=3`.

#### Important

Certain options are handled in a special way in order to ensure that the active replication configuration is not inadvertently altered or affected:

- In MySQL 5.1.16 and earlier, these options are ignored if the `master.info` file exists (i.e. when the MySQL server has already previously been configured for replication). If the file exists and these options are present in the `my.cnf` or as options on the command line to `mysqld`, they are silently ignored and the information in `master.info` used instead.
- **Options deprecated.** *Beginning with MySQL 5.1.17, these options are deprecated. As of MySQL 6.0, they have been removed.* In MySQL 5.1.17 and later versions of MySQL 5.1, these options have no effect when `mysqld` is started and an appropriate warning is written to the error log. To set the replication parameters associated with these you must use the `CHANGE MASTER TO ...` statement (see [Section 12.6.2.1, “CHANGE MASTER TO Syntax”](#)).

The options affected are shown in this list:

- `--master-host`
- `--master-user`



- `--master-password`
- `--master-port`
- `--master-connect-retry`
- `--master-ssl`
- `--master-ssl-ca`
- `--master-ssl-capath`
- `--master-ssl-cert`
- `--master-ssl-cipher`
- `--master-ssl-key`

The `master.info` file format in MySQL 5.1 includes values corresponding to the SSL options. In addition, the file format includes as its first line the number of lines in the file. (See [Section 16.4.2, “Replication Relay and Status Files”](#).) If you upgrade an older server (before MySQL 4.1.1) to a newer version, the new server upgrades the `master.info` file to the new format automatically when it starts. However, if you downgrade a newer server to an older version, you should remove the first line manually before starting the older server for the first time.

If no `master.info` file exists when the slave server starts, it uses the values for those options that are specified in option files or on the command line. This occurs when you start the server as a replication slave for the very first time, or when you have run `RESET SLAVE` and then have shut down and restarted the slave.

If the `master.info` file exists when the slave server starts, the server uses its contents and ignores any options that correspond to the values listed in the file. Thus, if you start the slave server with different values of the startup options that correspond to values in the `master.info` file, the different values have no effect, because the server continues to use the `master.info` file. To use different values, you must either restart after removing the `master.info` file or (preferably) use the `CHANGE MASTER TO` statement to reset the values while the slave is running.

Suppose that you specify this option in your `my.cnf` file:

```
[mysqld]
master-host=some_host
```

The first time you start the server as a replication slave, it reads and uses that option from the `my.cnf` file. The server then records the value in the `master.info` file. The next time you start the server, it reads the master host value from the `master.info` file only and ignores the value in the option file. If you modify the `my.cnf` file to specify a different master host of `some_other_host`, the change still has no effect. You should use `CHANGE MASTER TO` instead.

This example shows a more extensive use of startup options to configure a pre-5.1.17 slave server:

```
[mysqld]
server-id=2
master-host=db-master.mycompany.com
master-port=3306
master-user=pertinax
master-password=freitag
master-connect-retry=60
report-host=db-slave.mycompany.com
```

### Note

Because the server gives an existing `master.info` file precedence over the startup options just described, you might prefer not to use startup options for these values at all, and instead to specify them by using the `CHANGE MASTER TO` statement. Beginning with MySQL 5.1.17, you *must* use `CHANGE MASTER TO` to set the values corresponding to the deprecated options listed earlier in this section.

**Startup options for replication slaves.** The following list describes startup options for controlling replication slaves. Many of these options can be reset while the server is running by using the `CHANGE MASTER TO` statement. Others, such as the `-replicate-*` options, can be set only when the slave server starts. Replication-related system variables are discussed later in this section.

- `--log-slave-updates`

Normally, a slave does not log to its own binary log any updates that are received from a master server. This option tells the

slave to log the updates performed by its SQL thread to its own binary log. For this option to have any effect, the slave must also be started with the `--log-bin` option to enable binary logging. `--log-slave-updates` is used when you want to chain replication servers. For example, you might want to set up replication servers using this arrangement:

```
A -> B -> C
```

Here, **A** serves as the master for the slave **B**, and **B** serves as the master for the slave **C**. For this to work, **B** must be both a master *and* a slave. You must start both **A** and **B** with `--log-bin` to enable binary logging, and **B** with the `--log-slave-updates` option so that updates received from **A** are logged by **B** to its binary log.

When using MySQL Cluster Replication prior to MySQL Cluster NDB 6.2.16 and MySQL Cluster NDB 6.3.13, records for “empty” epochs — that is, epochs in which no changes to `NDBCLUSTER` data or tables took place — were inserted into the `ndb_apply_status` and `ndb_binlog_index` tables on the slave even when `--log-slave-updates` was disabled ([Bug#37472](#)). Beginning with MySQL Cluster NDB 6.3.21 and MySQL Cluster NDB 6.4.1, it is possible to re-enable the older behavior by using the `--ndb-log-empty-epochs` option.

- `--log-slow-slave-statements`

<b>Version Introduced</b>	5.1.21	
<b>Command Line Format</b>	<code>--log-slow-slave-statements</code>	
<b>Config File Format</b>	<code>log-slow-slave-statements</code>	
<b>Value Set</b>	<b>Type</b>	boolean
	<b>Default</b>	off

When the slow query log is enabled, this option enables logging for queries that have taken more than `long_query_time` seconds to execute on the slave.

This option was added in MySQL 5.1.21.

- `--log-warnings[=level]`

This option causes a server to print more messages to the error log about what it is doing. With respect to replication, the server generates warnings that it succeeded in reconnecting after a network/connection failure, and informs you as to how each slave thread started. This option is enabled by default; to disable it, use `--skip-log-warnings`. Aborted connections are not logged to the error log unless the value is greater than 1.

Note that the effects of this option are not limited to replication. It produces warnings across a spectrum of server activities.

- `--master-connect-retry=seconds`

The number of seconds that the slave thread sleeps before trying to reconnect to the master in case the master goes down or the connection is lost. The value in the `master.info` file takes precedence if it can be read. If not set, the default is 60. Connection retries are not invoked until the slave times out reading data from the master according to the value of `--slave-net-timeout`. The number of reconnection attempts is limited by the `--master-retry-count` option.

This option is deprecated as of MySQL 5.1.17, and removed as of MySQL 6.0.

- `--master-host=host_name`

The host name or IP number of the master replication server. The value in `master.info` takes precedence if it can be read. If no master host is specified, the slave thread does not start.

This option is deprecated as of MySQL 5.1.17, and removed as of MySQL 6.0.

- `--master-info-file=file_name`

The name to use for the file in which the slave records information about the master. The default name is `master.info` in the data directory.

- `--master-password=password`

The password of the account that the slave thread uses for authentication when it connects to the master. The value in the `master.info` file takes precedence if it can be read. If not set, an empty password is assumed.

This option is deprecated as of MySQL 5.1.17, and removed as of MySQL 6.0.

- `--master-port=port_number`

The TCP/IP port number that the master is listening on. The value in the `master.info` file takes precedence if it can be read. If not set, the compiled-in setting is assumed (normally 3306).

This option is deprecated as of MySQL 5.1.17, and removed as of MySQL 6.0.

- `--master-retry-count=count`

The number of times that the slave tries to connect to the master before giving up. Reconnects are attempted at intervals set by `--master-connect-retry` and reconnects are triggered when data reads by the slave time out according to the `--slave-net-timeout` option. The default value is 86400.

You can also set the retry count by using the `MASTER_CONNECT_RETRY` option for the `CHANGE MASTER TO` statement.

- `--master-ssl, --master-ssl-ca=file_name, --master-ssl-capath=directory_name, --master-ssl-cert=file_name, --master-ssl-cipher=cipher_list, --master-ssl-key=file_name`

These options are used for setting up a secure replication connection to the master server using SSL. Their meanings are the same as the corresponding `--ssl, --ssl-ca, --ssl-capath, --ssl-cert, --ssl-cipher, --ssl-key` options that are described in [Section 5.5.7.3, “SSL Command Options”](#). The values in the `master.info` file take precedence if they can be read.

These options are deprecated as of MySQL 5.1.17, and removed as of MySQL 6.0.

- `--master-user=user_name`

The user name of the account that the slave thread uses for authentication when it connects to the master. This account must have the `REPLICATION SLAVE` privilege. The value in the `master.info` file takes precedence if it can be read. If the master user name is not set, the name `test` is assumed.

This option is deprecated as of MySQL 5.1.17, and removed as of MySQL 6.0.

- `--max-relay-log-size=size`

The size at which the server rotates relay log files automatically. For more information, see [Section 16.4.2, “Replication Relay and Status Files”](#). The default size is 1GB.

- `--read-only`

Cause the slave to allow no updates except from slave threads or from users having the `SUPER` privilege. On a slave server, this can be useful to ensure that the slave accepts updates only from its master server and not from clients. This variable does not apply to `TEMPORARY` tables.

- `--relay-log=file_name`

The basename for the relay log. The default basename is `host_name-relay-bin`. The server creates relay log files in sequence by adding a numeric suffix to the basename.

Due to the manner in which MySQL parses server options, if you specify this option, you must supply a value; *the default base-name is used only if the option is not actually specified*. If you use the `--relay-log` option without specifying a value, unexpected behavior is likely to result; this behavior depends on the other options used, the order in which they are specified, and whether they are specified on the command line or in an option file. For more information about how MySQL handles server options, see [Section 4.2.3, “Specifying Program Options”](#).

If you specify this option, the value specified is also used as the basename for the relay log index file. You can override this behavior by specifying a different relay log index file basename using the `--relay-log-index` option.

You may find the `--relay-log` option useful in performing the following tasks:

- Creating relay logs whose names are independent of host names.
- If you need to put the relay logs in some area other than the data directory, because your relay logs tend to be very large and you do not want to decrease `max_relay_log_size`.
- To increase speed by using load-balancing between disks.
- `--relay-log-index=file_name`

The name to use for the relay log index file. The default name is `host_name-relay-bin.index` in the data directory, where `host_name` is the name of the slave server.

Due to the manner in which MySQL parses server options, if you specify this option, you must supply a value; *the default base-name is used only if the option is not actually specified*. If you use the `--relay-log-index` option without specifying a value, unexpected behavior is likely to result; this behavior depends on the other options used, the order in which they are specified, and whether they are specified on the command line or in an option file. For more information about how MySQL handles server options, see [Section 4.2.3, “Specifying Program Options”](#).

If you specify this option, the value specified is also used as the basename for the relay logs. You can override this behavior by specifying a different relay log file basename using the `--relay-log` option.

- `--relay-log-info-file=file_name`

The name to use for the file in which the slave records information about the relay logs. The default name is `relay-log.info` in the data directory.

- `--relay-log-purge={0|1}`

Disable or enable automatic purging of relay logs as soon as they are no longer needed. The default value is 1 (enabled). This is a global variable that can be changed dynamically with `SET GLOBAL relay_log_purge = N`.

- `--relay-log-space-limit=size`

This option places an upper limit on the total size in bytes of all relay logs on the slave. A value of 0 means “no limit.” This is useful for a slave server host that has limited disk space. When the limit is reached, the I/O thread stops reading binary log events from the master server until the SQL thread has caught up and deleted some unused relay logs. Note that this limit is not absolute: There are cases where the SQL thread needs more events before it can delete relay logs. In that case, the I/O thread exceeds the limit until it becomes possible for the SQL thread to delete some relay logs, because not doing so would cause a deadlock. You should not set `--relay-log-space-limit` to less than twice the value of `--max-relay-log-size` (or `--max-binlog-size` if `--max-relay-log-size` is 0). In that case, there is a chance that the I/O thread waits for free space because `--relay-log-space-limit` is exceeded, but the SQL thread has no relay log to purge and is unable to satisfy the I/O thread. This forces the I/O thread to ignore `--relay-log-space-limit` temporarily.

- `--replicate-do-db=db_name`

The effects of this option depend on whether statement-based or row-based replication is in use.

**Statement-based replication.** Tell the slave to restrict replication to statements where the default database (that is, the one selected by `USE`) is `db_name`. To specify more than one database, use this option multiple times, once for each database; however, doing so does *not* replicate cross-database statements such as `UPDATE some_db.some_table SET foo='bar'` while a different database (or no database) is selected.

### Warning

To specify multiple databases you *must* use multiple instances of this option. Because database names can contain commas, if you supply a comma separated list then the list will be treated as the name of a single database.

An example of what does not work as you might expect when using statement-based replication: If the slave is started with `--replicate-do-db=sales` and you issue the following statements on the master, the `UPDATE` statement is *not* replicated:

```
USE prices;
UPDATE sales.january SET amount=amount+1000;
```

The main reason for this “check just the default database” behavior is that it is difficult from the statement alone to know whether it should be replicated (for example, if you are using multiple-table `DELETE` statements or multiple-table `UPDATE` statements that act across multiple databases). It is also faster to check only the default database rather than all databases if there is no need.

**Row-based replication.** Tells the slave to restrict replication to database `db_name`. Only tables belonging to `db_name` are changed; the current database has no effect on this. For example, suppose that the slave is started with `--replicate-do-db=sales` and row-based replication is in effect, and then the following statements are run on the master:

```
USE prices;
UPDATE sales.february SET amount=amount+100;
```

The `february` table in the `sales` database on the slave is changed in accordance with the `UPDATE` statement; this occurs whether or not the `USE` statement was issued. However, issuing the following statements on the master has no effect on the slave when using row-based replication and `--replicate-do-db=sales`:

```
USE prices;
UPDATE prices.march SET amount=amount-25;
```

Even if the statement `USE prices` were changed to `USE sales`, the `UPDATE` statement's effects would still not be replicated.

Another important difference in how `--replicate-do-db` is handled in statement-based replication as opposed to row-based replication occurs with regard to statements that refer to multiple databases. Suppose the slave is started with `--replicate-do-db=db1`, and the following statements are executed on the master:

```
USE db1;
UPDATE db1.table1 SET col1 = 10, db2.table2 SET col2 = 20;
```

If you are using statement-based replication, then both tables are updated on the slave. However, when using row-based replication, only `table1` is affected on the slave; since `table2` is in a different database, `table2` on the slave is not changed by the `UPDATE`. Now suppose that, instead of the `USE db1` statement, a `USE db4` statement had been used:

```
USE db4;
UPDATE db1.table1 SET col1 = 10, db2.table2 SET col2 = 20;
```

In this case, the `UPDATE` statement would have no effect on the slave when using statement-based replication. However, if you are using row-based replication, the `UPDATE` would change `table1` on the slave, but not `table2` — in other words, only tables in the database named by `--replicate-do-db` are changed, and the choice of current database has no effect on this behavior.

If you need cross-database updates to work, use `--replicate-wild-do-table=db_name.%` instead. See [Section 16.4.3, “How Servers Evaluate Replication Rules”](#).

### Note

This option effects replication in the same manner that `--binlog-do-db` affects binary logging, and the affects of the replication format on how `--replicate-do-db` affects replication behavior are the same as those of the logging format on the behavior of `--binlog-do-db`.

- `--replicate-ignore-db=db_name`

As with `--replicate-do-db`, the effects of this option depend on whether statement-based or row-based replication is in use.

**Statement-based replication.** Tells the slave to not replicate any statement where the default database (that is, the one selected by `USE`) is `db_name`.

**Row-based replication.** Tells the slave not to update any tables in the database `db_name`. The current database has no effect.

When using statement-based replication, the following example does not work as you might expect. Suppose that the slave is started with `--replicate-ignore-db=sales` and you issue the following statements on the master:

```
USE prices;
UPDATE sales.january SET amount=amount+1000;
```

The `UPDATE` statement *is* replicated in such a case because `--replicate-ignore-db` applies only to the default database (determined by the `USE` statement). Because the `sales` database was specified explicitly in the statement, the statement has not been filtered. However, when using row-based replication, the `UPDATE` statement's effects are *not* propagated to the slave, and the slave's copy of the `sales.january` table is unchanged; in this instance, `--replicate-ignore-db=sales` causes *all* changes made to tables in the master's copy of the `sales` database to be ignored by the slave.

To specify more than one database to ignore, use this option multiple times, once for each database. Because database names can contain commas, if you supply a comma separated list then the list will be treated as the name of a single database.

You should not use this option if you are using cross-database updates and you do not want these updates to be replicated. See [Section 16.4.3, “How Servers Evaluate Replication Rules”](#).

If you need cross-database updates to work, use `--replicate-wild-ignore-table=db_name.%` instead. See [Section 16.4.3, “How Servers Evaluate Replication Rules”](#).

### Note

This option effects replication in the same manner that `--binlog-ignore-db` affects binary logging, and the affects of the replication format on how `--replicate-ignore-db` affects replication behavior are the same as those of the logging format on the behavior of `--binlog-ignore-db`.

- `--replicate-do-table=db_name.tbl_name`

Tells the slave thread to restrict replication to the specified table. To specify more than one table, use this option multiple times, once for each table. This works for cross-database updates, in contrast to `--replicate-do-db`. See [Section 16.4.3, “How Servers Evaluate Replication Rules”](#).

- `--replicate-ignore-table=db_name.tbl_name`

Tells the slave thread to not replicate any statement that updates the specified table, even if any other tables might be updated by the same statement. To specify more than one table to ignore, use this option multiple times, once for each table. This works for cross-database updates, in contrast to `--replicate-ignore-db`. See [Section 16.4.3, “How Servers Evaluate Replication Rules”](#).

- `--replicate-rewrite-db=from_name->to_name`

Tells the slave to translate the default database (that is, the one selected by `USE`) to `to_name` if it was `from_name` on the master. Only statements involving tables are affected (not statements such as `CREATE DATABASE`, `DROP DATABASE`, and `ALTER DATABASE`), and only if `from_name` is the default database on the master. This does not work for cross-database updates. To specify multiple rewrites, use this option multiple times. The server uses the first one with a `from_name` value that matches. The database name translation is done *before* the `--replicate-*` rules are tested.

If you use this option on the command line and the “>” character is special to your command interpreter, quote the option value. For example:

```
shell> mysqld --replicate-rewrite-db="olddb->newdb"
```

- `--replicate-same-server-id`

To be used on slave servers. Usually you should use the default setting of 0, to prevent infinite loops caused by circular replication. If set to 1, the slave does not skip events having its own server ID. Normally, this is useful only in rare configurations. Cannot be set to 1 if `--log-slave-updates` is used. By default, the slave I/O thread does not write binary log events to the relay log if they have the slave’s server ID (this optimization helps save disk usage). If you want to use `--replicate-same-server-id`, be sure to start the slave with this option before you make the slave read its own events that you want the slave SQL thread to execute.

- `--replicate-wild-do-table=db_name.tbl_name`

Tells the slave thread to restrict replication to statements where any of the updated tables match the specified database and table name patterns. Patterns can contain the “%” and “\_” wildcard characters, which have the same meaning as for the `LIKE` pattern-matching operator. To specify more than one table, use this option multiple times, once for each table. This works for cross-database updates. See [Section 16.4.3, “How Servers Evaluate Replication Rules”](#).

Example: `--replicate-wild-do-table=foo%.bar%` replicates only updates that use a table where the database name starts with `foo` and the table name starts with `bar`.

If the table name pattern is `%`, it matches any table name and the option also applies to database-level statements (`CREATE DATABASE`, `DROP DATABASE`, and `ALTER DATABASE`). For example, if you use `--replicate-wild-do-table=foo%.%`, database-level statements are replicated if the database name matches the pattern `foo%`.

To include literal wildcard characters in the database or table name patterns, escape them with a backslash. For example, to replicate all tables of a database that is named `my_own%db`, but not replicate tables from the `mylownAABCdb` database, you should escape the “\_” and “%” characters like this: `--replicate-wild-do-table=my\_own\%db`. If you’re using the option on the command line, you might need to double the backslashes or quote the option value, depending on your command interpreter. For example, with the `bash` shell, you would need to type `--replicate-wild-do-table=my\\_own\\%db`.

- `--replicate-wild-ignore-table=db_name.tbl_name`

Tells the slave thread not to replicate a statement where any table matches the given wildcard pattern. To specify more than one table to ignore, use this option multiple times, once for each table. This works for cross-database updates. See [Section 16.4.3, “How Servers Evaluate Replication Rules”](#).

Example: `--replicate-wild-ignore-table=foo%.bar%` does not replicate updates that use a table where the database name starts with `foo` and the table name starts with `bar`.

For information about how matching works, see the description of the `--replicate-wild-do-table` option. The rules for including literal wildcard characters in the option value are the same as for `--replicate-wild-ignore-table` as well.

- `--report-host=host_name`

The host name or IP number of the slave to be reported to the master during slave registration. This value appears in the output of `SHOW SLAVE HOSTS` on the master server. Leave the value unset if you do not want the slave to register itself with the master. Note that it is not sufficient for the master to simply read the IP number of the slave from the TCP/IP socket after the slave connects. Due to NAT and other routing issues, that IP may not be valid for connecting to the slave from the master or other hosts.



- `--report-password=password`

The account password of the slave to be reported to the master during slave registration. This value appears in the output of `SHOW SLAVE HOSTS` on the master server if the `--show-slave-auth-info` option is given.

- `--report-port=slave_port_num`

The TCP/IP port number for connecting to the slave, to be reported to the master during slave registration. Set this only if the slave is listening on a non-default port or if you have a special tunnel from the master or other clients to the slave. If you are not sure, do not use this option.

- `--report-user=user_name`

The account user name of the slave to be reported to the master during slave registration. This value appears in the output of `SHOW SLAVE HOSTS` on the master server if the `--show-slave-auth-info` option is given.

- `--show-slave-auth-info`

Display slave user names and passwords in the output of `SHOW SLAVE HOSTS` on the master server for slaves started with the `--report-user` and `--report-password` options.

- `--skip-slave-start`

Tells the slave server not to start the slave threads when the server starts. To start the threads later, use a `START SLAVE` statement.

- `--slave_compressed_protocol={0|1}`

If this option is set to 1, use compression for the slave/master protocol if both the slave and the master support it. The default is 0 (no compression).

- `--slave-load-tmpdir=file_name`

The name of the directory where the slave creates temporary files. This option is by default equal to the value of the `tmpdir` system variable. When the slave SQL thread replicates a `LOAD DATA INFILE` statement, it extracts the file to be loaded from the relay log into temporary files, and then loads these into the table. If the file loaded on the master is huge, the temporary files on the slave are huge, too. Therefore, it might be advisable to use this option to tell the slave to put temporary files in a directory located in some file system that has a lot of available space. In that case, the relay logs are huge as well, so you might also want to use the `--relay-log` option to place the relay logs in that file system.

The directory specified by this option should be located in a disk-based file system (not a memory-based file system) because the temporary files used to replicate `LOAD DATA INFILE` must survive machine restarts. The directory also should not be one that is cleared by the operating system during the system startup process.

- `--slave-net-timeout=seconds`

The number of seconds to wait for more data from the master before the slave considers the connection broken, aborts the read, and tries to reconnect. The first retry occurs immediately after the timeout. The interval between retries is controlled by the `MASTER_CONNECT_RETRY` option for the `CHANGE MASTER TO` statement or `--master-connect-retry` option, and the number of reconnection attempts is limited by the `--master-retry-count` option. The default is 3600 seconds (one hour).

- `--slave-skip-errors=[err_code1,err_code2,...|all]`

Normally, replication stops when an error occurs on the slave. This gives you the opportunity to resolve the inconsistency in the data manually. This option tells the slave SQL thread to continue replication when a statement returns any of the errors listed in the option value.

Do not use this option unless you fully understand why you are getting errors. If there are no bugs in your replication setup and client programs, and no bugs in MySQL itself, an error that stops replication should never occur. Indiscriminate use of this option results in slaves becoming hopelessly out of synchrony with the master, with you having no idea why this has occurred.

### Note

Prior to MySQL 5.1.35, this option had no effect with row-based logging. ([Bug#39393](#))

For error codes, you should use the numbers provided by the error message in your slave error log and in the output of `SHOW SLAVE STATUS`. [Appendix B, Errors, Error Codes, and Common Problems](#), lists server error codes.

You can also (but should not) use the very non-recommended value of `all` to cause the slave to ignore all error messages and keeps going regardless of what happens. Needless to say, if you use `all`, there are no guarantees regarding the integrity of your

data. Please do not complain (or file bug reports) in this case if the slave's data is not anywhere close to what it is on the master. *You have been warned.*

Examples:

```
--slave-skip-errors=1062,1053
--slave-skip-errors=all
```

- `sql_slave_skip_counter`

<b>Variable Name</b>	<code>sql_slave_skip_counter</code>	
<b>Variable Scope</b>	Global	
<b>Dynamic Variable</b>	Yes	
<b>Value Set</b>	<b>Type</b>	numeric

The number of events from the master that a slave server should skip.

### Important

If skipping the number of events specified by setting this variable would cause the slave to begin in the middle of an event group, the slave continues to skip until it finds the beginning of the next event group and begins from that point. See [Section 12.6.2.6, “SET GLOBAL SQL\\_SLAVE\\_SKIP\\_COUNTER Syntax”](#), for more information.

- `--abort-slave-event-count`

<b>Command Line Format</b>	<code>--abort-slave-event-count=#</code>	
<b>Config File Format</b>	<code>abort-slave-event-count</code>	
<b>Value Set</b>	<b>Type</b>	numeric
	<b>Default</b>	0
	<b>Min Value</b>	0

When this option is set to some positive integer *value* other than 0 (the default) it affects replication behavior as follows: After the slave SQL thread has started, *value* log events are allowed to be executed; after that, the slave SQL thread does not receive any more events, just as if the network connection from the master were cut. The slave thread continues to run, and the output from `SHOW SLAVE STATUS` displays `Yes` in both the `Slave_IO_Running` and the `Slave_SQL_Running` columns, but no further events are read from the relay log.

This option is used internally by the MySQL test suite for replication testing and debugging. It is not intended for use in a production setting.

- `--disconnect-slave-event-count`

<b>Command Line Format</b>	<code>--disconnect-slave-event-count=#</code>	
<b>Config File Format</b>	<code>disconnect-slave-event-count</code>	
<b>Value Set</b>	<b>Type</b>	numeric
	<b>Default</b>	0

This option is used internally by the MySQL test suite for replication testing and debugging.

**System variables used on replication slaves.** The following system variables are used for controlling replication slave servers. Those that can be set are specified using `SET`. Server options used with replication slaves are listed earlier in this section.

- `init_slave`

<b>Command Line Format</b>	<code>--init-slave=name</code>	
<b>Config File Format</b>	<code>init_slave</code>	
<b>Option Sets Variable</b>	Yes, <code>init_slave</code>	



<b>Variable Name</b>	<code>init_slave</code>	
<b>Variable Scope</b>	Global	
<b>Dynamic Variable</b>	Yes	
<b>Value Set</b>	<b>Type</b>	<code>string</code>

This variable is similar to `init_connect`, but is a string to be executed by a slave server each time the SQL thread starts. The format of the string is the same as for the `init_connect` variable.

### Note

The SQL thread sends an acknowledgement to the client before `init_slave` is executed. Therefore, it is not guaranteed that `init_slave` has been executed when `START SLAVE` returns. See [Section 12.6.2.7, “START SLAVE Syntax”](#), for more information.

- `rpl_recovery_rank`  
This variable is unused.
- `slave_compressed_protocol`

<b>Command Line Format</b>	<code>--slave_compressed_protocol</code>	
<b>Config File Format</b>	<code>slave_compressed_protocol</code>	
<b>Option Sets Variable</b>	Yes, <code>slave_compressed_protocol</code>	
<b>Variable Name</b>	<code>slave_compressed_protocol</code>	
<b>Variable Scope</b>	Global	
<b>Dynamic Variable</b>	Yes	
<b>Value Set</b>	<b>Type</b>	<code>boolean</code>
	<b>Default</b>	<code>FALSE</code>

Whether to use compression of the slave/master protocol if both the slave and the master support it.

- `slave_exec_mode`

<b>Version Introduced</b>	5.1.24	
<b>Variable Name</b>	<code>slave_exec_mode</code>	
<b>Variable Scope</b>	Global	
<b>Dynamic Variable</b>	Yes	
<b>Value Set</b>	<b>Type</b>	<code>enumeration</code>
	<b>Default</b>	<code>STRICT</code>
	<b>Valid Values</b>	<code>IDEMPOTENT, STRICT</code>

Controls whether `IDEMPOTENT` or `STRICT` mode is used in replication conflict resolution and error checking. `IDEMPOTENT` mode causes suppression of duplicate-key and no-key-found errors. Beginning with MySQL 5.1.23-ndb-6.2.14 and MySQL 5.1.24, this mode should be employed in multi-master replication, circular replication, and some other special replication scenarios. `STRICT` mode is the default, and is suitable for most other cases.

- `slave_load_tmpdir`

<b>Command Line Format</b>	<code>--slave-load-tmpdir=name</code>	
<b>Config File Format</b>	<code>slave-load-tmpdir</code>	
<b>Option Sets Variable</b>	Yes, <code>slave_load_tmpdir</code>	
<b>Variable Name</b>	<code>slave_load_tmpdir</code>	
<b>Variable Scope</b>	Global	
<b>Dynamic Variable</b>	No	

<b>Value Set</b>	<b>Type</b>	filename
	<b>Default</b>	/tmp

The name of the directory where the slave creates temporary files for replicating `LOAD DATA INFILE` statements.

- `slave_net_timeout`

<b>Command Line Format</b>	<code>--slave-net-timeout=#</code>	
<b>Config File Format</b>	<code>slave-net-timeout</code>	
<b>Option Sets Variable</b>	Yes, <code>slave_net_timeout</code>	
<b>Variable Name</b>	<code>slave_net_timeout</code>	
<b>Variable Scope</b>	Global	
<b>Dynamic Variable</b>	Yes	
<b>Value Set</b>	<b>Type</b>	numeric
	<b>Default</b>	3600
	<b>Min Value</b>	1

The number of seconds to wait for more data from a master/slave connection before aborting the read. This timeout applies only to TCP/IP connections, not to connections made via Unix socket files, named pipes, or shared memory.

- `slave_skip_errors`

<b>Command Line Format</b>	<code>--slave-skip-errors=name</code>	
<b>Config File Format</b>	<code>slave-skip-errors</code>	
<b>Option Sets Variable</b>	Yes, <code>slave_skip_errors</code>	
<b>Variable Name</b>	<code>slave_skip_errors</code>	
<b>Variable Scope</b>	Global	
<b>Dynamic Variable</b>	No	

Normally, replication stops when an error occurs on the slave. This gives you the opportunity to resolve the inconsistency in the data manually. This variable tells the slave SQL thread to continue replication when a statement returns any of the errors listed in the variable value.

- `sql_slave_skip_counter`

<b>Variable Name</b>	<code>sql_slave_skip_counter</code>	
<b>Variable Scope</b>	Global	
<b>Dynamic Variable</b>	Yes	
<b>Value Set</b>	<b>Type</b>	numeric

The number of events from the master that a slave server should skip.

### Important

If skipping the number of events specified by setting this variable would cause the slave to begin in the middle of an event group, the slave continues to skip until it finds the beginning of the next event group and begins from that point. See [Section 12.6.2.6, “SET GLOBAL SQL\\_SLAVE\\_SKIP\\_COUNTER Syntax”](#), for more information.

- `slave_transaction_retries`

<b>Command Line Format</b>	<code>--slave_transaction_retries=#</code>	
<b>Config File Format</b>	<code>slave_transaction_retries</code>	
<b>Option Sets Variable</b>	Yes, <code>slave_transaction_retries</code>	
<b>Variable Name</b>	<code>slave_transaction_retries</code>	

<b>Variable Scope</b>	Global	
<b>Dynamic Variable</b>	Yes	
<b>Value Set</b>	<b>Platform Bit Size</b>	32
	<b>Type</b>	numeric
	<b>Default</b>	10
	<b>Range</b>	0-4294967295
<b>Value Set</b>	<b>Platform Bit Size</b>	64
	<b>Type</b>	numeric
	<b>Default</b>	10
	<b>Range</b>	0-18446744073709547520

If a replication slave SQL thread fails to execute a transaction because of an InnoDB deadlock or because the transaction's execution time exceeded InnoDB's `innodb_lock_wait_timeout` or NDBCLUSTER's `TransactionDeadlockDetectionTimeout` or `TransactionInactiveTimeout`, it automatically retries `slave_transaction_retries` times before stopping with an error. The default value is 10.

#### 16.1.3.4. Binary Log Options and Variables

You can use the `mysqld` options and system variables that are described in this section to affect the operation of the binary log as well as to control which statements are written to the binary log. For additional information about the binary log, see [Section 5.2.4, “The Binary Log”](#). For additional information about using MySQL server options and system variables, see [Section 5.1.2, “Server Command Options”](#), and [Section 5.1.3, “Server System Variables”](#).

**Startup options used with binary logging.** The following list describes startup options for enabling and configuring the binary log. Many of these options can be reset while the server is running by using the `CHANGE MASTER TO` statement. Others, can be set only when the slave server starts. System variables used with binary logging are discussed later in this section.

- `--binlog-row-event-max-size=N`

<b>Version Introduced</b>	5.1.5	
<b>Command Line Format</b>	<code>--binlog-row-event-max-size=#</code>	
<b>Config File Format</b>	<code>binlog-row-event-max-size</code>	
<b>Value Set</b>	<b>Platform Bit Size</b>	32
	<b>Type</b>	numeric
	<b>Default</b>	1024
	<b>Range</b>	256-4294967295
<b>Value Set</b>	<b>Platform Bit Size</b>	64
	<b>Type</b>	numeric
	<b>Default</b>	1024
	<b>Range</b>	256-18446744073709547520

Specify the maximum size of a row-based binary log event, in bytes. Rows are grouped into events smaller than this size if possible. The value should be a multiple of 256. The default is 1024. See [Section 16.1.2, “Replication Formats”](#). This option was added in MySQL 5.1.5.

- `--log-bin[=base_name]`

<b>Command Line Format</b>	<code>--log-bin</code>
<b>Config File Format</b>	<code>log-bin</code>
<b>Variable Name</b>	<code>log_bin</code>
<b>Variable Scope</b>	Global
<b>Dynamic Variable</b>	No

Value Set	Type	filename
	Default	OFF

Enable binary logging. The server logs all statements that change data to the binary log, which is used for backup and replication. See [Section 5.2.4, “The Binary Log”](#).

The option value, if given, is the basename for the log sequence. The server creates binary log files in sequence by adding a numeric suffix to the basename. It is recommended that you specify a basename (see [Section B.1.8.2, “Additional Known Issues”](#), for the reason). Otherwise, MySQL uses `host_name-bin` as the basename.

- `--log-bin-index[=file_name]`

Command Line Format	<code>--log-bin-index=name</code>	
Config File Format	<code>log-bin-index</code>	
Value Set	Type	filename
	Default	OFF

The index file for binary log file names. See [Section 5.2.4, “The Binary Log”](#). If you omit the file name, and if you didn't specify one with `--log-bin`, MySQL uses `host_name-bin.index` as the file name.

- **Statement selection options.** The options in the following list affect which statements are written to the binary log, and thus sent by a replication master server to its slaves.
  - `--binlog-do-db=db_name`

This option affects binary logging in the same manner that `--replicate-do-db` affects replication.

The effects of this option depend on whether the statement-based or row-based logging format is in use, in the same way that the effects of `--replicate-do-db` depend on whether statement-based or row-based replication is in use.

**Statement-based logging.** Only those statements where the default database (that is, the one selected by `USE`) is `db_name` are written to the binary log. To specify more than one database, use this option multiple times, once for each database; however, doing so does *not* cause cross-database statements such as `UPDATE some_db.some_table SET foo='bar'` to be logged while a different database (or no database) is selected.

## Warning

To specify multiple databases you *must* use multiple instances of this option. Because database names can contain commas, if you supply a comma separated list then the list will be treated as the name of a single database.

An example of what does not work as you might expect when using statement-based logging: If the server is started with `--binlog-do-db=sales` and you issue the following statements, the `UPDATE` statement is *not* logged:

```
USE prices;
UPDATE sales.january SET amount=amount+1000;
```

The main reason for this “just check the default database” behavior is that it is difficult from the statement alone to know whether it should be replicated (for example, if you are using multiple-table `DELETE` statements or multiple-table `UPDATE` statements that act across multiple databases). It is also faster to check only the default database rather than all databases if there is no need.

**Row-based logging.** Logging is restricted to database `db_name`. Only changes to tables belonging to `db_name` are logged; the current database has no effect on this. For example, suppose that the server is started with `--replicate-do-db=sales` and row-based logging is in effect, and then the following statements are executed:

```
USE prices;
UPDATE sales.february SET amount=amount+100;
```

The `february` table in the `sales` database is changed in accordance with the `UPDATE` statement; this occurs whether or not the `USE` statement was issued. However, the following statements are not logged when using the row-based logging format and `--binlog-do-db=sales`:

```
USE prices;
UPDATE prices.march SET amount=amount-25;
```

Even if the statement `USE prices` were changed to `USE sales`, the `UPDATE` statement's effects would still not be written to the binary log.

Another important difference in how `--binlog-do-db` is handled when using the statement-based logging format as opposed to the row-based format occurs with regard to statements that refer to multiple databases. Suppose the server is started with `--binlog-do-db=db1`, and the following statements are executed:

```
USE db1;
UPDATE db1.table1 SET col1 = 10, db2.table2 SET col2 = 20;
```

If you are using statement-based logging, then the updates to both tables are written to the binary log. However, when using the row-based format, only the changes to `table1` logged; since `table2` is in a different database, it is not changed by the `UPDATE`. Now suppose that, instead of the `USE db1` statement, a `USE db4` statement had been used:

```
USE db4;
UPDATE db1.table1 SET col1 = 10, db2.table2 SET col2 = 20;
```

In this case, the `UPDATE` statement would not be written to the binary log when using statement-based logging. However, if using row-based logging, the `UPDATE` would change `table1`, but not `table2` — in other words, only tables in the database named by `--binlog-do-db` are changed, and the choice of current database has no effect on this behavior.

- `--binlog-ignore-db=db_name`

This option affects binary logging in the same manner that `--replicate-ignore-db` affects replication.

The effects of this option depend on whether the statement-based or row-based logging format is in use, in the same way that the effects of `--replicate-ignore-db` depend on whether statement-based or row-based replication is in use.

**Statement-based logging.** Tells the server to not log any statement where the default database (that is, the one selected by `USE`) is `db_name`.

**Row-based format.** Tells the server not to log updates to any tables in the database `db_name`. The current database has no effect.

When using statement-based logging, the following example does not work as you might expect. Suppose that the server is started with `--binlog-ignore-db=sales` and you issue the following statements:

```
USE prices;
UPDATE sales.january SET amount=amount+1000;
```

The `UPDATE` statement *is* logged in such a case because `--binlog-ignore-db` applies only to the default database (determined by the `USE` statement). Because the `sales` database was specified explicitly in the statement, the statement has not been filtered. However, when using row-based logging, the `UPDATE` statement's effects are *not* written to the binary log, which means that no changes to the `sales.january` table are logged; in this instance, `--binlog-ignore-db=sales` causes *all* changes made to tables in the master's copy of the `sales` database to be ignored for purposes of binary logging.

To specify more than one database to ignore, use this option multiple times, once for each database. Because database names can contain commas, if you supply a comma separated list then the list will be treated as the name of a single database.

You should not use this option if you are using cross-database updates and you do not want these updates to be logged.

Additional server options that can be used to control logging also affect the binary log. For more information about these, see [Section 5.1.2, “Server Command Options”](#). For more information about how the options in the previous list are applied, see [Section 5.2.4, “The Binary Log”](#).

There are also options for slave servers that control which statements received from the master should be executed or ignored. For details, see [Section 16.1.3.3, “Replication Slave Options and Variables”](#).

- `--log-bin-trust-function-creators[={0|1}]`

<b>Command Line Format</b>	<code>--log-bin-trust-function-creators</code>	
<b>Config File Format</b>	<code>log-bin-trust-function-creators</code>	
<b>Option Sets Variable</b>	Yes, <code>log_bin_trust_function_creators</code>	
<b>Variable Name</b>	<code>log_bin_trust_function_creators</code>	
<b>Variable Scope</b>	Global	
<b>Dynamic Variable</b>	Yes	
<b>Value Set</b>	<b>Type</b>	<code>boolean</code>
	<b>Default</b>	<code>FALSE</code>

With no argument or an argument of 1, this option sets the `log_bin_trust_function_creators` system variable to 1. With an argument of 0, this option sets the system variable to 0. `log_bin_trust_function_creators` affects how MySQL enforces restrictions on stored function and trigger creation. See [Section 18.6, “Binary Logging of Stored Programs”](#).

**Note**

Previously, this option was known as `--log-bin-trust-routine-creators`, which is now deprecated.

**Testing and debugging options.** The following binary log options are used in replication testing and debugging. They are not intended for use in normal operations.

- `--max-binlog-dump-events`

<b>Command Line Format</b>	<code>--max-binlog-dump-events=#</code>	
<b>Config File Format</b>	<code>max-binlog-dump-events</code>	
<b>Value Set</b>	<b>Type</b>	numeric
	<b>Default</b>	0

This option is used internally by the MySQL test suite for replication testing and debugging.

- `--sporadic-binlog-dump-fail`

<b>Command Line Format</b>	<code>--sporadic-binlog-dump-fail</code>	
<b>Config File Format</b>	<code>sporadic-binlog-dump-fail</code>	
<b>Value Set</b>	<b>Type</b>	boolean
	<b>Default</b>	FALSE

This option is used internally by the MySQL test suite for replication testing and debugging.

**System variables used with the binary log.** The following system variables are used for controlling replication slave servers. Those that can be set are specified using `SET`. Server options used with replication slaves are listed earlier in this section.

- `binlog_cache_size`

<b>Command Line Format</b>	<code>--binlog_cache_size=#</code>	
<b>Config File Format</b>	<code>binlog_cache_size</code>	
<b>Option Sets Variable</b>	Yes, <code>binlog_cache_size</code>	
<b>Variable Name</b>	<code>binlog_cache_size</code>	
<b>Variable Scope</b>	Global	
<b>Dynamic Variable</b>	Yes	
<b>Value Set</b>	<b>Platform Bit Size</b>	32
	<b>Type</b>	numeric
	<b>Default</b>	32768
	<b>Range</b>	4096-4294967295
<b>Value Set</b>	<b>Platform Bit Size</b>	64
	<b>Type</b>	numeric
	<b>Default</b>	32768
	<b>Range</b>	4096-18446744073709547520

The size of the cache to hold the SQL statements for the binary log during a transaction. A binary log cache is allocated for each client if the server supports any transactional storage engines and if the server has the binary log enabled (`--log-bin`

option). If you often use large, multiple-statement transactions, you can increase this cache size to get more performance. The `Binlog_cache_use` and `Binlog_cache_disk_use` status variables can be useful for tuning the size of this variable. See Section 5.2.4, “The Binary Log”.

### MySQL Enterprise

For recommendations on the optimum setting for `binlog_cache_size` subscribe to the MySQL Enterprise Monitor. For more information, see <http://www.mysql.com/products/enterprise/advisors.html>.

- `binlog_format`

<b>Version Introduced</b>	5.1.5	
<b>Command Line Format</b>	<code>--binlog-format</code>	
<b>Config File Format</b>	<code>binlog-format</code>	
<b>Option Sets Variable</b>	Yes, <code>binlog_format</code>	
<b>Variable Name</b>	<code>binlog_format</code>	
<b>Variable Scope</b>	Both	
<b>Dynamic Variable</b>	Yes	
<b>Value Set (<math>\geq 5.1.5</math>, <math>\leq 5.1.7</math>)</b>	<b>Type</b>	enumeration
	<b>Default</b>	STATEMENT
	<b>Valid Values</b>	ROW, STATEMENT
<b>Value Set (<math>\geq 5.1.8</math>, <math>\leq 5.1.11</math>)</b>	<b>Type</b>	enumeration
	<b>Default</b>	STATEMENT
	<b>Valid Values</b>	ROW, STATEMENT, MIXED
<b>Value Set (<math>\geq 5.1.12</math>, <math>\leq 5.1.28</math>)</b>	<b>Type</b>	enumeration
	<b>Default</b>	MIXED
	<b>Valid Values</b>	ROW, STATEMENT, MIXED
<b>Value Set (<math>\geq 5.1.29</math>)</b>	<b>Type</b>	enumeration
	<b>Default</b>	STATEMENT
	<b>Valid Values</b>	ROW, STATEMENT, MIXED

This variable sets the binary logging format, and can be any one of `STATEMENT`, `ROW`, or `MIXED`. `binlog_format` is set by the `--binlog-format` option at startup, or by the `binlog_format` variable at runtime.

You must have the `SUPER` privilege to set this variable, which (unlike with most system variables) is true as of MySQL 5.1.29 even for the session value. See Section 16.1.2, “Replication Formats”.

The startup variable was added in MySQL 5.1.5, and the runtime variable in MySQL 5.1.8. `MIXED` was added in MySQL 5.1.8.

The rules governing when changing this variable takes effect and how long the effect lasts are the same as for other MySQL server system variables. See Section 12.5.4, “SET Syntax”, for more information.

`STATEMENT` was used by default prior to MySQL 5.1.12; in MySQL 5.1.12, the default was changed to `MIXED`. In MySQL 5.1.29, the default was changed back to `STATEMENT`.

When `MIXED` is specified, statement-based replication is used, except for cases where only row-based replication is guaranteed to lead to proper results. For example, this happens when statements contain user-defined functions (UDF) or the `UUID()` function. An exception to this rule is that `MIXED` always uses statement-based replication for stored functions and triggers.

As with other global variables, to set `binlog_format` globally, you must have the `SUPER` privilege. Starting with MySQL 5.1.29, you must also have the `SUPER` privilege to set `binlog_format` on the session level. (Bug#39106)

There are exceptions when you cannot switch the replication format at runtime:

- From within a stored function or a trigger.
  - If the `NDBCLUSTER` storage engine is enabled.
  - If the session is currently in row-based replication mode and has open temporary tables.
- Trying to switch the format in those cases results in an error.

Before MySQL 5.1.8, switching to row-based replication format would implicitly set `--log-bin-trust-function-creators=1` and `--innodb_locks_unsafe_for_binlog`. MySQL 5.1.8 and later no longer implicitly set these options when row-based replication is used.

The binlog format affects the behavior of the following server options:

- `--replicate-do-db`
- `--replicate-ignore-db`
- `--binlog-do-db`
- `--binlog-ignore-db`

These effects are discussed in detail in the descriptions of the individual options.

- `max_binlog_cache_size`

<b>Command Line Format</b>	<code>--max_binlog_cache_size=#</code>	
<b>Config File Format</b>	<code>max_binlog_cache_size</code>	
<b>Option Sets Variable</b>	Yes, <code>max_binlog_cache_size</code>	
<b>Variable Name</b>	<code>max_binlog_cache_size</code>	
<b>Variable Scope</b>	Global	
<b>Dynamic Variable</b>	Yes	
<b>Value Set</b>	<b>Platform Bit Size</b>	32
	<b>Type</b>	numeric
	<b>Default</b>	4294967295
	<b>Range</b>	4096-4294967295
<b>Value Set</b>	<b>Platform Bit Size</b>	64
	<b>Type</b>	numeric
	<b>Default</b>	18446744073709547520
	<b>Range</b>	4096-18446744073709547520

If a multiple-statement transaction requires more than this many bytes of memory, the server generates a `MULTI-STATEMENT TRANSACTION REQUIRED MORE THAN 'MAX_BINLOG_CACHE_SIZE' BYTES OF STORAGE` error. The minimum value is 4096; the maximum and default values are 4GB on 32-bit platforms and 16 PB (petabytes) on 64-bit platforms.

- `max_binlog_size`

<b>Command Line Format</b>	<code>--max_binlog_size=#</code>	
<b>Config File Format</b>	<code>max_binlog_size</code>	
<b>Option Sets Variable</b>	Yes, <code>max_binlog_size</code>	
<b>Variable Name</b>	<code>max_binlog_size</code>	
<b>Variable Scope</b>	Global	
<b>Dynamic Variable</b>	Yes	
<b>Value Set</b>	<b>Type</b>	numeric
	<b>Default</b>	1073741824
	<b>Min Value</b>	4096

If a write to the binary log causes the current log file size to exceed the value of this variable, the server rotates the binary logs (closes the current file and opens the next one). You cannot set this variable to more than 1GB or to less than 4096 bytes. The default value is 1GB.

A transaction is written in one chunk to the binary log, so it is never split between several binary logs. Therefore, if you have big transactions, you might see binary logs larger than `max_binlog_size`.



If `max_relay_log_size` is 0, the value of `max_binlog_size` applies to relay logs as well.

- `sync_binlog`

<b>Command Line Format</b>	<code>--sync-binlog=#</code>	
<b>Config File Format</b>	<code>sync-binlog</code>	
<b>Option Sets Variable</b>	Yes, <code>sync_binlog</code>	
<b>Variable Name</b>	<code>sync_binlog</code>	
<b>Variable Scope</b>	Global	
<b>Dynamic Variable</b>	Yes	
<b>Value Set</b>	<b>Platform Bit Size</b>	32
	<b>Type</b>	numeric
	<b>Default</b>	0
	<b>Range</b>	0-4294967295
<b>Value Set</b>	<b>Platform Bit Size</b>	64
	<b>Type</b>	numeric
	<b>Default</b>	0
	<b>Range</b>	0-18446744073709547520

If the value of this variable is greater than 0, the MySQL server synchronizes its binary log to disk (using `fdatasync()`) after every `sync_binlog` writes to the binary log. There is one write to the binary log per statement if autocommit is enabled, and one write per transaction otherwise. The default value of `sync_binlog` is 0, which does no synchronizing to disk — in this case, the server relies on the operating system to flush the binary log's contents from time to time as for any other file. A value of 1 is the safest choice, because in the event of a crash you lose at most one statement or transaction from the binary log. However, it is also the slowest choice (unless the disk has a battery-backed cache, which makes synchronization very fast).

## 16.1.4. Common Replication Administration Tasks

Once replication has been started it should execute without requiring much regular administration. Depending on your replication environment, you will want to check the replication status of each slave either periodically, daily, or even more frequently.

### MySQL Enterprise

For regular reports regarding the status of your slaves, subscribe to the MySQL Enterprise Monitor. For more information, see <http://www.mysql.com/products/enterprise/advisors.html>.

### 16.1.4.1. Checking Replication Status

The most common task when managing a replication process is to ensure that replication is taking place and that there have been no errors between the slave and the master.

The primary statement for this is `SHOW SLAVE STATUS` which you must execute on each slave:

```
mysql> SHOW SLAVE STATUS\G
***** 1. row *****
      Slave_IO_State: Waiting for master to send event
        Master_Host: master1
        Master_User: root
        Master_Port: 3306
        Connect_Retry: 60
        Master_Log_File: mysql-bin.000004
        Read_Master_Log_Pos: 931
        Relay_Log_File: slave1-relay-bin.000056
        Relay_Log_Pos: 950
        Relay_Master_Log_File: mysql-bin.000004
        Slave_IO_Running: Yes
        Slave_SQL_Running: Yes
        Replicate_Do_DB:
        Replicate_Ignore_DB:
        Replicate_Do_Table:
        Replicate_Ignore_Table:
        Replicate_Wild_Do_Table:
        Replicate_Wild_Ignore_Table:
          Last_Errno: 0
          Last_Error:
        Skip_Counter: 0
        Exec_Master_Log_Pos: 931
```

```

Relay_Log_Space: 1365
Until_Condition: None
Until_Log_File:
Until_Log_Pos: 0
Master_SSL_Allowed: No
Master_SSL_CA_File:
Master_SSL_CA_Path:
Master_SSL_Cert:
Master_SSL_Cipher:
Master_SSL_Key:
Seconds_Behind_Master: 0
1 row in set (0.01 sec)

```

The key fields from the status report to examine are:

- `Slave_IO_State` — indicates the current status of the slave. See [Section 7.5.6.5, “Replication Slave I/O Thread States”](#), and [Section 7.5.6.6, “Replication Slave SQL Thread States”](#), for more information.
- `Slave_IO_Running` — shows whether the IO thread for the reading the master's binary log is running.
- `Slave_SQL_Running` — shows whether the SQL thread for the executing events in the relay log is running.
- `Last_Error` — shows the last error registered when processing the relay log. Ideally this should be blank, indicating no errors.
- `Seconds_Behind_Master` — shows the number of seconds that the slave SQL thread is behind processing the master binary log. A high number (or an increasing one) can indicate that the slave is unable to cope with the large number of statements from the master.

A value of 0 for `Seconds_Behind_Master` can usually be interpreted as meaning that the slave has caught up with the master, but there are some cases where this is not strictly true. For example, this can occur if the network connection between master and slave is broken but the slave I/O thread has not yet noticed this — that is, `slave_net_timeout` has not yet elapsed.

It is also possible that transient values for `Seconds_Behind_Master` may not reflect the situation accurately. When the slave SQL thread has caught up on I/O, `Seconds_Behind_Master` displays 0; but when the slave I/O thread is still queuing up a new event, `Seconds_Behind_Master` may show a large value until the SQL thread finishes executing the new event. This is especially likely when the events have old timestamps; in such cases, if you execute `SHOW SLAVE STATUS` several times in a relatively short period, you may see this value change back and forth repeatedly between 0 and a relatively large value.

On the master, you can check the status of slaves by examining the list of running processes. Slaves execute the `Binlog Dump` command:

```

mysql> SHOW PROCESSLIST \G;
***** 4. row *****
  Id: 10
  User: root
  Host: slave1:58371
  db: NULL
  Command: Binlog Dump
  Time: 777
  State: Has sent all binlog to slave; waiting for binlog to be updated
  Info: NULL

```

Because it is the slave that drives the core of the replication process, very little information is available in this report.

If you have used the `--report-host` option, then the `SHOW SLAVE HOSTS` statement will show basic information about connected slaves:

```

mysql> SHOW SLAVE HOSTS;
+-----+-----+-----+-----+-----+
| Server_id | Host | Port | Rpl_recovery_rank | Master_id |
+-----+-----+-----+-----+-----+
|          10 | slave1 | 3306 |          0 |          1 |
+-----+-----+-----+-----+-----+
1 row in set (0.00 sec)

```

The output includes the ID of the slave server, the value of the `--report-host` option, the connecting port, master ID and the priority of the slave for receiving binary log updates.

### 16.1.4.2. Pausing Replication on the Slave

You can stop and start the replication of statements on the slave using the `STOP SLAVE` and `START SLAVE` statements.

To stop execution of the binary log from the master, use `STOP SLAVE`:

```
mysql> STOP SLAVE;
```

When execution is stopped, the slave does not read the binary log from the master (the `IO_THREAD`) and stops processing events from the relay log that have not yet been executed (the `SQL_THREAD`). You can pause either the IO or SQL threads individually by specifying the thread type. For example:

```
mysql> STOP SLAVE IO_THREAD;
```

Stopping the SQL thread can be useful if you want to perform a backup or other task on a slave that only processes events from the master. The IO thread will continue to be read from the master, but not executed, which will make it easier for the slave to catch up when you start slave operations again.

Stopping the IO thread will allow the statements in the relay log to be executed up until the point where the relay log has ceased to receive new events. Using this option can be useful when you want to pause execution to allow the slave to catch up with events from the master, when you want to perform administration on the slave but also ensure you have the latest updates to a specific point. This method can also be used to pause execution on the slave while you conduct administration on the master while ensuring that there is not a massive backlog of events to be executed when replication is started again.

To start execution again, use the `START SLAVE` statement:

```
mysql> START SLAVE;
```

If necessary, you can start either the `IO_THREAD` or `SQL_THREAD` threads individually.

## 16.2. Replication Solutions

Replication can be used in many different environments for a range of purposes. In this section you will find general notes and advice on using replication for specific solution types.

For information on using replication in a backup environment, including notes on the setup, backup procedure, and files to back up, see [Section 16.2.1, “Using Replication for Backups”](#).

For advice and tips on using different storage engines on the master and slaves, see [Section 16.2.2, “Using Replication with Different Master and Slave Storage Engines”](#).

Using replication as a scale-out solution requires some changes in the logic and operation of applications that use the solution. See [Section 16.2.3, “Using Replication for Scale-Out”](#).

For performance or data distribution reasons you may want to replicate different databases to different replication slaves. See [Section 16.2.4, “Replicating Different Databases to Different Slaves”](#).

As the number of replication slaves increases, the load on the master can increase (because of the need to replicate the binary log to each slave) and lead to a reduction in performance of the master. For tips on improving your replication performance, including using a single secondary server as a replication master, see [Section 16.2.5, “Improving Replication Performance”](#).

For guidance on switching masters, or converting slaves into masters as part of an emergency failover solution, see [Section 16.2.6, “Switching Masters During Failover”](#).

To secure your replication communication you can encrypt the communication channel by using SSL to exchange data. Step-by-step instructions can be found in [Section 16.2.7, “Setting Up Replication Using SSL”](#).

### 16.2.1. Using Replication for Backups

You can use replication as a backup solution by replicating data from the master to a slave, and then backing up the data slave. Because the slave can be paused and shut down without affecting the running operation of the master you can produce an effective snapshot of 'live' data that would otherwise require a shutdown of the master database.

How you back up the database will depend on the size of the database and whether you are backing up only the data, or the data and the replication slave state so that you can rebuild the slave in the event of failure. There are therefore two choices:

If you are using replication as a solution to enable you to back up the data on the master, and the size of your database is not too large, then the `mysqldump` tool may be suitable. See [Section 16.2.1.1, “Backing Up a Slave Using `mysqldump`”](#).

For larger databases, where `mysqldump` would be impractical or inefficient, you can back up the raw data files instead. Using the raw data files option also means that you can back up the binary and relay logs that will enable you to recreate the slave in the event of a slave failure. For more information, see [Section 16.2.1.2, “Backing Up Raw Data from a Slave”](#).

Another backup strategy, which can be used for either master or slave servers, is to put the server in a read-only state. The backup is performed against the read-only server, which then is changed back to its usual read/write operational status. See [Section 16.2.1.3, “Backing Up a Master or Slave by Making It Read Only”](#).

### 16.2.1.1. Backing Up a Slave Using `mysqldump`

Using `mysqldump` to create a copy of the database enables you to capture all of the data in the database in a format that allows the information to be imported into another instance of MySQL. Because the format of the information is SQL statements the file can easily be distributed and applied to running servers in the event that you need access to the data in an emergency. However, if the size of your data set is very large then `mysqldump` may be impractical.

When using `mysqldump` you should stop the slave before starting the dump process to ensure that the dump contains a consistent set of data:

1. Stop the slave from processing requests. You can either stop the slave completely using `mysqladmin`:

```
shell> mysqladmin stop-slave
```

Alternatively, you can stop processing the relay log files by stopping the replication SQL thread. Using this method will allow the binary log data to be transferred. Within busy replication environments this may speed up the catch-up process when you start the slave processing again:

```
shell> mysql -e 'STOP SLAVE SQL_THREAD;'
```

2. Run `mysqldump` to dump your databases. You may either select databases to be dumped, or dump all databases. For more information, see [Section 4.5.4, “mysqldump — A Database Backup Program”](#). For example, to dump all databases:

```
shell> mysqldump --all-databases >fulldb.dump
```

3. Once the dump has completed, start slave operations again:

```
shell> mysqladmin start-slave
```

In the preceding example you may want to add login credentials (user name, password) to the commands, and bundle the process up into a script that you can run automatically each day.

If you use this approach, make sure you monitor the slave replication process to ensure that the time taken to run the backup in this way is not affecting the slave's ability to keep up with events from the master. See [Section 16.1.4.1, “Checking Replication Status”](#). If the slave is unable to keep up you may want to add another server and distribute the backup process. For an example of how to configure this scenario, see [Section 16.2.4, “Replicating Different Databases to Different Slaves”](#).

### 16.2.1.2. Backing Up Raw Data from a Slave

To guarantee the integrity of the files that are copied, backing up the raw data files on your MySQL replication slave should take place while your slave server is shut down. If the MySQL server is still running then background tasks, particularly with storage engines with background processes such as InnoDB, may still be updating the database files. With InnoDB, these problems should be resolved during crash recovery, but since the slave server can be shut down during the backup process without affecting the execution of the master it makes sense to take advantage of this facility.

To shut down the server and back up the files:

1. Shut down the slave MySQL server:

```
shell> mysqladmin shutdown
```

2. Copy the data files. You can use any suitable copying or archive utility, including `cp`, `tar` or `WinZip`:

```
shell> tar cf /tmp/dbbackup.tar ./data
```

3. Start up the `mysqld` process again:

```
shell> mysqld_safe &
```

Under Windows:

```
C:\> "C:\Program Files\MySQL\MySQL Server 5.1\bin\mysqld"
```

Normally you should back up the entire data folder for the slave MySQL server. If you want to be able to restore the data and operate as a slave (for example, in the event of failure of the slave), then when you back up the slave's data, you should back up the slave status files, `master.info` and `relay-log.info`, along with the relay log files. These files are needed to resume replication after you restore the slave's data.

If you lose the relay logs but still have the `relay-log.info` file, you can check it to determine how far the SQL thread has executed in the master binary logs. Then you can use `CHANGE MASTER TO` with the `MASTER_LOG_FILE` and `MASTER_LOG_POS` options to tell the slave to re-read the binary logs from that point. Of course, this requires that the binary logs still exist on the master server.

If your slave is subject to replicating `LOAD DATA INFILE` statements, you should also back up any `SQL_LOAD-*` files that exist in the directory that the slave uses for this purpose. The slave needs these files to resume replication of any interrupted `LOAD DATA INFILE` operations. The directory location is specified using the `--slave-load-tmpdir` option. If this option is not specified, the directory location is the value of the `tmpdir` system variable.

### 16.2.1.3. Backing Up a Master or Slave by Making It Read Only

It is possible to back up either master or slave servers in a replication setup by acquiring a global read lock and manipulating the `read_only` system variable to change the read-only state of the server to be backed up:

1. Make the server read-only, so that it processes only retrievals and blocks updates
2. Perform the backup
3. Change the server back to its normal read/write state

The following instructions describe how to do this for a master server and for a slave server.

These instructions require MySQL 5.1.15 or higher. For earlier versions, setting `read_only` did not block while table locks or outstanding transactions were pending, so that some data changes could still occur during the backup.

#### Note

The instructions in this section place the server to be backed up in a state that is safe for backup methods that get the data from the server, such as `mysqldump` (see [Section 4.5.4, “mysqldump — A Database Backup Program”](#)). You should not attempt to use these instructions to make a binary backup by copying files directly because the server may still have modified data cached in memory and not flushed to disk.

For both scenarios discussed here, suppose that you have the following replication setup:

- A master server M1
- A slave server S1 that has M1 as its master
- A client C1 connected to M1
- A client C2 connected to S1

#### Scenario 1: Backup with a Read-Only Master

Put the master M1 in a read-only state by executing these statements on it:

```
FLUSH TABLES WITH READ LOCK;
SET GLOBAL read_only = ON;
```

While M1 is in a read-only state, the following properties are true:

- Requests for updates sent by C1 to M1 will fail because the server is in read-only mode
- Requests for retrievals sent by C1 to M1 will succeed
- Making a backup on M1 is safe

- Making a backup on S1 is not safe: this server is still running, and might be processing the binary log or update requests coming from client C2 (S1 might not be in a read-only state)

While M1 is read only, perform the backup. For example, you can use `mysqldump`.

After the backup on M1 has been done, restore M1 to its normal operational state by executing these statements:

```
SET GLOBAL read_only = OFF;  
UNLOCK TABLES;
```

Although performing the backup on M1 is safe (as far as the backup is concerned), it is not optimal because clients of M1 are blocked from executing updates.

This strategy also applies to backing up a single server in a non-replication setting.

### Scenario 2: Backup with a Read-Only Slave

Put the slave S1 in a read-only state by executing these statements on it:

```
FLUSH TABLES WITH READ LOCK;  
SET GLOBAL read_only = ON;
```

While S1 is in a read-only state, the following properties are true:

- The master M1 will continue to operate
- Making a backup on the master is not safe
- The slave S1 is stopped
- Making a backup on the slave S1 is safe

These properties provide the basis for a popular backup scenario: Having one slave busy performing a backup for a while is not a problem because it does not affect the entire network, and the system is still running during the backup. (For example, clients can still perform updates on the master server.)

While S1 is read only, perform the backup.

After the backup on S1 has been done, restore S1 to its normal operational state by executing these statements:

```
SET GLOBAL read_only = OFF;  
UNLOCK TABLES;
```

After the slave is restored to normal operation, it again synchronizes to the master by catching up with any outstanding updates in the binary log from the master.

In either scenario, the statements to acquire the global read lock and manipulate the `read_only` variable are performed on the server to be backed up and do not propagate to any slaves of that server.

## 16.2.2. Using Replication with Different Master and Slave Storage Engines

The replication process does not care if the source table on the master and the replicated table on the slave use different engine types. In fact, the system variables `storage_engine` and `table_type` are not replicated.

This provides a number of advantages in the replication process in that you can take advantage of different engine types for different replication scenarios. For example, in a typical scaleout scenario (see [Section 16.2.3, “Using Replication for Scale-Out”](#)), you want to use `InnoDB` tables on the master to take advantage of the transactional functionality, but use `MyISAM` on the slaves where transaction support is not required because the data is only read. When using replication in a data logging environment you may want to use the `Archive` storage engine on the slave.

Setting up different engines on the master and slave depends on how you set up the initial replication process:

- If you used `mysqldump` to create the database snapshot on your master then you could edit the dump text to change the engine type used on each table.

Another alternative for `mysqldump` is to disable engine types that you do not want to use on the slave before using the dump

to build the data on the slave. For example, you can add the `--skip-innodb` option on your slave to disable the `InnoDB` engine. If a specific engine does not exist, MySQL will use the default engine type, usually `MyISAM`. If you want to disable further engines in this way, you may want to consider building a special binary to be used on the slave that only supports the engines you want.

- If you are using raw data files for the population of the slave, you will be unable to change the initial table format. Instead, use `ALTER TABLE` to change the table types after the slave has been started.
- For new master/slave replication setups where there are currently no tables on the master, avoid specifying the engine type when creating new tables.

If you are already running a replication solution and want to convert your existing tables to another engine type, follow these steps:

1. Stop the slave from running replication updates:

```
mysql> STOP SLAVE;
```

This will enable you to change engine types without interruptions.

2. Execute an `ALTER TABLE ... Engine='enginetype'` for each table where you want to change the engine type.
3. Start the slave replication process again:

```
mysql> START SLAVE;
```

Although the `storage_engine` and `table_type` variables are not replicated, be aware that `CREATE TABLE` and `ALTER TABLE` statements that include the engine specification will be correctly replicated to the slave. For example, if you have a CSV table and you execute:

```
mysql> ALTER TABLE csvtable Engine='MyISAM';
```

The above statement will be replicated to the slave and the engine type on the slave will be converted to `MyISAM`, even if you have previously changed the table type on the slave to an engine other than CSV. If you want to retain engine differences on the master and slave, you should be careful to use the `storage_engine` variable on the master when creating a new table. For example, instead of:

```
mysql> CREATE TABLE tablea (columna int) Engine=MyISAM;
```

Use this format:

```
mysql> SET storage_engine=MyISAM;
mysql> CREATE TABLE tablea (columna int);
```

When replicated, the `storage_engine` variable will be ignored, and the `CREATE TABLE` statement will be executed with the slave's default engine type.

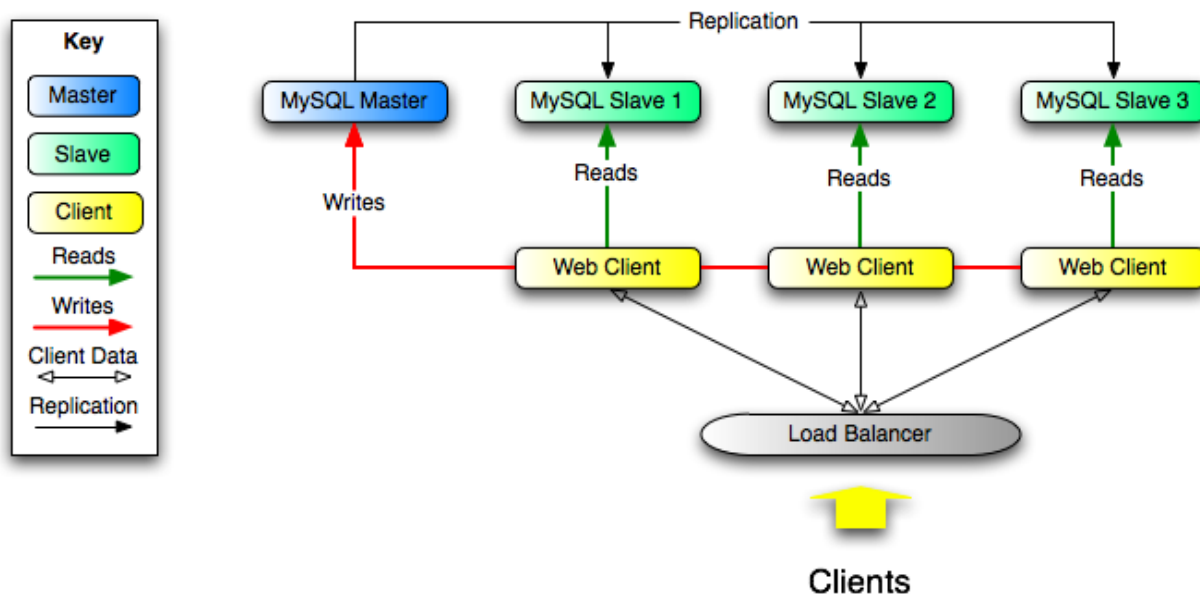
### 16.2.3. Using Replication for Scale-Out

You can use replication as a scale-out solution, i.e. where you want to split up the load of database queries across multiple database servers, within some reasonable limitations.

Because replication works from the distribution of one master to one or more slaves, using replication for scaleout works best in an environment where you have a high number of reads and low number of writes/updates. Most websites fit into this category, where users are browsing the website, reading articles, posts, or viewing products. Updates only occur during session management, or when making a purchase or adding a comment/message to a forum.

Replication in this situation enables you to distribute the reads over the replication slaves, while still allowing your web servers to communicate with the replication master when a write is required. You can see a sample replication layout for this scenario in [Figure 16.1, "Using replication to improve the performance during scaleout"](#).

**Figure 16.1. Using replication to improve the performance during scaleout**



If the part of your code that is responsible for database access has been properly abstracted/modularized, converting it to run with a replicated setup should be very smooth and easy. Change the implementation of your database access to send all writes to the master, and to send reads to either the master or a slave. If your code does not have this level of abstraction, setting up a replicated system gives you the opportunity and motivation to clean it up. Start by creating a wrapper library or module that implements the following functions:

- `safe_writer_connect()`
- `safe_reader_connect()`
- `safe_reader_statement()`
- `safe_writer_statement()`

`safe_` in each function name means that the function takes care of handling all error conditions. You can use different names for the functions. The important thing is to have a unified interface for connecting for reads, connecting for writes, doing a read, and doing a write.

Then convert your client code to use the wrapper library. This may be a painful and scary process at first, but it pays off in the long run. All applications that use the approach just described are able to take advantage of a master/slave configuration, even one involving multiple slaves. The code is much easier to maintain, and adding troubleshooting options is trivial. You need modify only one or two functions; for example, to log how long each statement took, or which statement among those issued gave you an error.

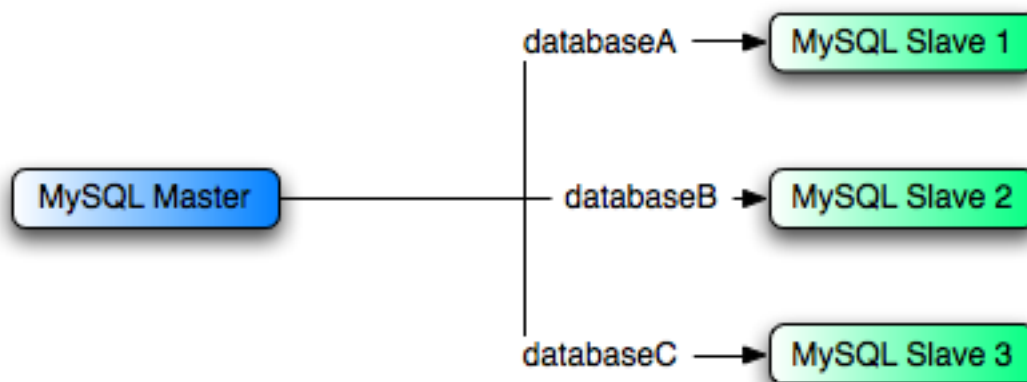
If you have written a lot of code, you may want to automate the conversion task by using the `replace` utility that comes with standard MySQL distributions, or write your own conversion script. Ideally, your code uses consistent programming style conventions. If not, then you are probably better off rewriting it anyway, or at least going through and manually regularizing it to use a consistent style.

#### 16.2.4. Replicating Different Databases to Different Slaves

There may be situations where you have a single master and want to replicate different databases to different slaves. For example, you may want to distribute different sales data to different departments to help spread the load during data analysis. A sample of this layout is shown in [Figure 16.2, “Using replication to replicate databases to separate replication slaves”](#).

**Figure 16.2. Using replication to replicate databases to separate replication slaves**





You can achieve this separation by configuring the master and slaves as normal, and then limiting the binary log statements that each slave processes by using the `--replicate-wild-do-table` configuration option on each slave.

### Important

You should *not* use `--replicate-do-db` for this purpose when using statement-based replication, since statement-based replication causes this option's affects to vary according to the database that is currently selected. This applies to mixed-format replication as well, since this allows some updates to be replicated using the statement-based format.

However, it should be to use `--replicate-do-db` for this purpose if you are using row-based replication only, since in this case the currently-selected database has no effect on the option's operation.

For example, to support the separation as shown in [Figure 16.2, “Using replication to replicate databases to separate replication slaves”](#), you should configure each replication slave as follows, before executing `START SLAVE`:

- Replication slave 1 should use `--replicate-wild-do-table=databaseA.%`.
- Replication slave 2 should use `--replicate-wild-do-table=databaseB.%`.
- Replication slave 3 should use `--replicate-wild-do-table=databaseC.%`.

If you have data that needs to be synchronized to the slaves before replication starts, you have a number of choices:

- Synchronize all the data to each slave, and delete the databases, tables, or both that you do not want to keep.
- Use `mysqldump` to create a separate dump file for each database and load the appropriate dump file on each slave.
- Use a raw data file dump and include only the specific files and databases that you need for each slave.

### Note

This does not work with InnoDB databases unless you use `innodb_file_per_table`.

Each slave in this configuration receives the entire binary log from the master, but executes only those events from the binary log that apply to the databases and tables included by the `--replicate-wild-do-table` option in effect on that slave.

## 16.2.5. Improving Replication Performance

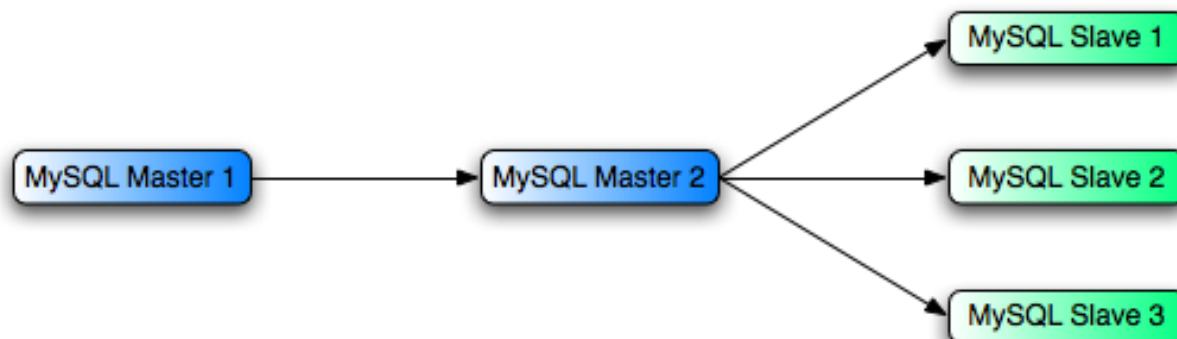
As the number of slaves connecting to a master increases, the load, although minimal, also increases, as each slave uses up a client connection to the master. Also, as each slave must receive a full copy of the master binary log, the network load on the master may also increase and start to create a bottleneck.

If you are using a large number of slaves connected to one master, and that master is also busy processing requests (for example, as part of a scaleout solution), then you may want to improve the performance of the replication process.

One way to improve the performance of the replication process is to create a deeper replication structure that enables the master to

replicate to only one slave, and for the remaining slaves to connect to this primary slave for their individual replication requirements. A sample of this structure is shown in [Figure 16.3, “Using an additional replication host to improve performance”](#).

**Figure 16.3. Using an additional replication host to improve performance**



For this to work, you must configure the MySQL instances as follows:

- Master 1 is the primary master where all changes and updates are written to the database. Binary logging should be enabled on this machine.
- Master 2 is the slave to the Master 1 that provides the replication functionality to the remainder of the slaves in the replication structure. Master 2 is the only machine allowed to connect to Master 1. Master 2 also has binary logging enabled, and the `--log-slave-updates` option so that replication instructions from Master 1 are also written to Master 2's binary log so that they can then be replicated to the true slaves.
- Slave 1, Slave 2, and Slave 3 act as slaves to Master 2, and replicate the information from Master 2, which is really the data logged on Master 1.

The above solution reduces the client load and the network interface load on the primary master, which should improve the overall performance of the primary master when used as a direct database solution.

If your slaves are having trouble keeping up with the replication process on the master then there are a number of options available:

- If possible, you should put the relay logs and the data files on different physical drives. To do this, use the `--relay-log` option to specify the location of the relay log.
- If the slaves are significantly slower than the master, then you may want to divide up the responsibility for replicating different databases to different slaves. See [Section 16.2.4, “Replicating Different Databases to Different Slaves”](#).
- If your master makes use of transactions and you are not concerned about transaction support on your slaves, then use `MyISAM` or another non-transactional engine. See [Section 16.2.2, “Using Replication with Different Master and Slave Storage Engines”](#).
- If your slaves are not acting as masters, and you have a potential solution in place to ensure that you can bring up a master in the event of failure, then you can switch off `--log-slave-updates`. This prevents 'dumb' slaves from also logging events they have executed into their own binary log.

## 16.2.6. Switching Masters During Failover

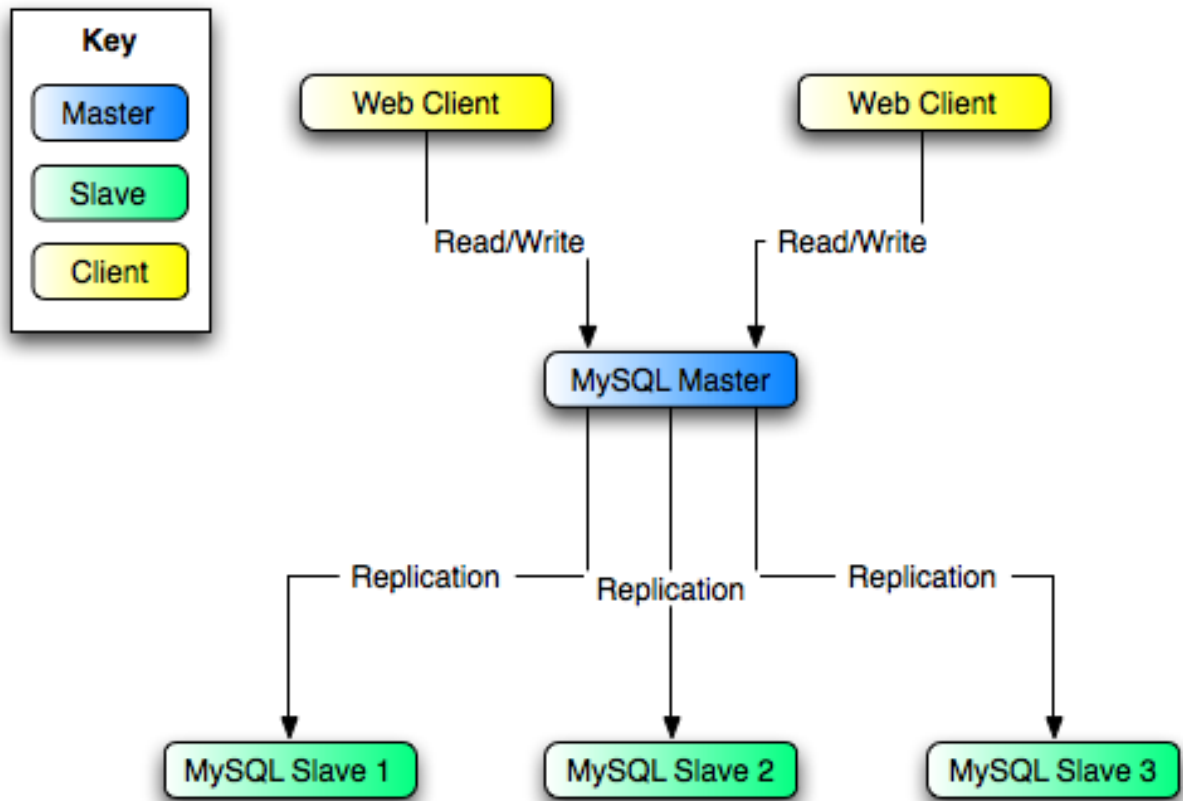
There is currently no official solution for providing failover between master and slaves in the event of a failure. With the currently available features, you would have to set up a master and a slave (or several slaves), and to write a script that monitors the master to check whether it is up. Then instruct your applications and the slaves to change master in case of failure.

Remember that you can tell a slave to change its master at any time, using the `CHANGE MASTER TO` statement. The slave will not check whether the databases on the master are compatible with the slave, it will just start executing events from the specified log and position on the new master. In a failover situation all the servers in the group are probably executing the same events from the same binary log, so changing the source of the events should not affect the database structure or integrity providing you are careful.

Run your slaves with the `--log-bin` option and without `--log-slave-updates`. In this way, the slave is ready to become a

master as soon as you issue `STOP SLAVE; RESET MASTER`, and `CHANGE MASTER TO` statement on the other slaves. For example, assume that you have the structure shown in Figure 16.4, “Redundancy using replication, initial structure”.

**Figure 16.4. Redundancy using replication, initial structure**



In this diagram, the `MySQL Master` holds the master database, the `MySQL Slave` computers are replication slaves, and the `Web Client` machines are issuing database reads and writes. Web clients that issue only reads (and would normally be connected to the slaves) are not shown, as they do not need to switch to a new server in the event of failure. For a more detailed example of a read/write scaleout replication structure, see Section 16.2.3, “Using Replication for Scale-Out”.

Each `MySQL Slave` (`Slave 1`, `Slave 2`, and `Slave 3`) are slaves running with `--log-bin` and without `--log-slave-updates`. Because updates received by a slave from the master are not logged in the binary log unless `--log-slave-updates` is specified, the binary log on each slave is empty initially. If for some reason `MySQL Master` becomes unavailable, you can pick one of the slaves to become the new master. For example, if you pick `Slave 1`, all `Web Clients` should be redirected to `Slave 1`, which will log updates to its binary log. `Slave 2` and `Slave 3` should then replicate from `Slave 1`.

The reason for running the slave without `--log-slave-updates` is to prevent slaves from receiving updates twice in case you cause one of the slaves to become the new master. Suppose that `Slave 1` has `--log-slave-updates` enabled. Then it will write updates that it receives from `Master` to its own binary log. When `Slave 2` changes from `Master` to `Slave 1` as its master, it may receive updates from `Slave 1` that it has already received from `Master`.

Make sure that all slaves have processed any statements in their relay log. On each slave, issue `STOP SLAVE IO_THREAD`, then check the output of `SHOW PROCESSLIST` until you see `Has read all relay log`. When this is true for all slaves, they can be reconfigured to the new setup. On the slave `Slave 1` being promoted to become the master, issue `STOP SLAVE` and `RESET MASTER`.

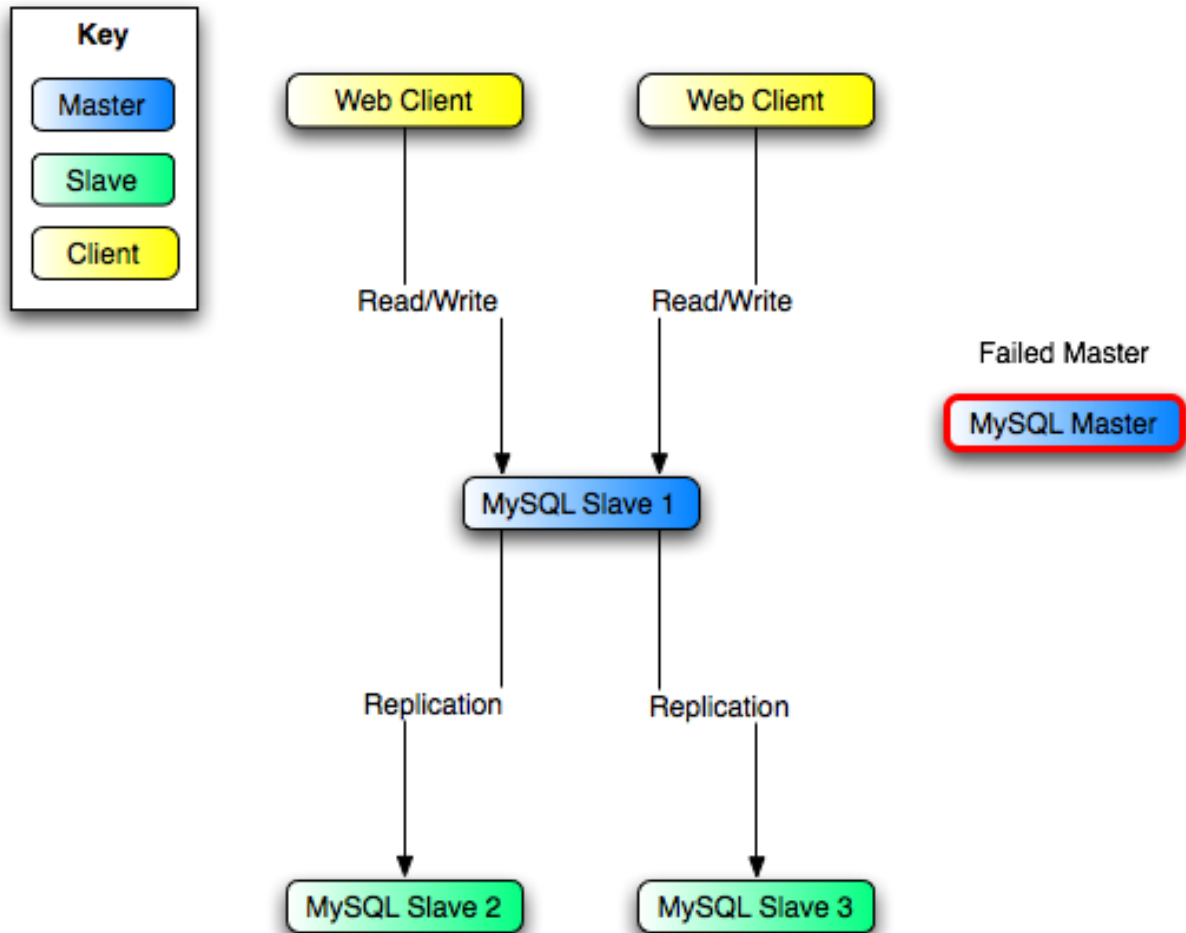
On the other slaves `Slave 2` and `Slave 3`, use `STOP SLAVE` and `CHANGE MASTER TO MASTER_HOST='Slave1'` (where `'Slave1'` represents the real host name of `Slave 1`). To use `CHANGE MASTER TO`, add all information about how to connect to `Slave 1` from `Slave 2` or `Slave 3` (`user`, `password`, `port`). In `CHANGE MASTER TO`, there is no need to specify the name of `Slave 1`'s binary log or binary log position to read from: We know it is the first binary log and position 4, which are the defaults for `CHANGE MASTER TO`. Finally, use `START SLAVE` on `Slave 2` and `Slave 3`.

Once the new replication is in place, you will then need to instruct each `Web Client` to direct their statements to `Slave 1`.

From that point on, all updates statements sent by `Web Client` to `Slave 1` are written to the binary log of `Slave 1`, which then contains every update statement sent to `Slave 1` since `Master` died.

The resulting server structure is shown in Figure 16.5, “Redundancy using replication, after master failure”.

**Figure 16.5. Redundancy using replication, after master failure**



When `Master` is up again, you must issue on it the same `CHANGE MASTER TO` as that issued on `Slave 2` and `Slave 3`, so that `Master` becomes a slave of `S1` and picks up each `Web Client` writes that it missed while it was down.

To make `Master` a master again (because it is the most powerful machine, for example), use the preceding procedure as if `Slave 1` was unavailable and `Master` was to be the new master. During this procedure, do not forget to run `RESET MASTER` on `Master` before making `Slave 1`, `Slave 2`, and `Slave 3` slaves of `Master`. Otherwise, they may pick up old `Web Client` writes from before the point at which `Master` became unavailable.

Note that there is no synchronization between the different slaves to a master. Some slaves might be ahead of others. This means that the concept outlined in the previous example might not work. In practice, however, the relay logs of different slaves will most likely not be far behind the master, so it would work, anyway (but there is no guarantee).

A good way to keep your applications informed as to the location of the master is by having a dynamic DNS entry for the master. With `bind` you can use `nsupdate` to dynamically update your DNS.

## 16.2.7. Setting Up Replication Using SSL

Setting up replication using an SSL connection is similar to setting up a server and client using SSL. You will need to obtain (or create) a suitable security certificate that you can use on the master, and a similar certificate (from the same certificate authority) on each slave.

To use SSL for encrypting the transfer of the binary log required during replication you must first set up the master to support SSL

network connections. If the master does not support SSL connections (because it has not been compiled or configured for SSL), then replication through an SSL connection will not be possible.

For more information on setting up a server and client for SSL connectivity, see [Section 5.5.7.2, “Using SSL Connections”](#).

To enable SSL on the master you will need to create or obtain suitable certificates and then add the following configuration options to the master's configuration within the `mysqld` section:

```
ssl-ca=cacert.pem
ssl-cert=server-cert.pem
ssl-key=server-key.pem
```

### Note

You should use full path to specify the location of your certificate files.

The options are as follows:

- `ssl-ca` identifies the Certificate Authority (CA) certificate.
- `ssl-cert` identifies the server public key. This can be sent to the client and authenticated against the CA certificate that it has.
- `ssl-key` identifies the server private key.

On the slave, you have two options available for setting the SSL information. You can either add the slaves certificates to the `client` section of the slave configuration file, or you can explicitly specify the SSL information using the `CHANGE MASTER TO` statement.

Using the former option, add the following lines to the `client` section of the slave configuration file:

```
[client]
ssl-ca=cacert.pem
ssl-cert=server-cert.pem
ssl-key=server-key.pem
```

Restart the slave server, using the `--skip-slave` to prevent the slave from connecting to the master. Use `CHANGE MASTER TO` to specify the master configuration, using the `master_ssl` option to enable SSL connectivity:

```
mysql> CHANGE MASTER TO \
  MASTER_HOST='master_hostname', \
  MASTER_USER='replicate', \
  MASTER_PASSWORD='password', \
  MASTER_SSL=1;
```

To specify the SSL certificate options during the `CHANGE MASTER TO` command, append the SSL options:

```
CHANGE MASTER TO \
  MASTER_HOST='master_hostname', \
  MASTER_USER='replicate', \
  MASTER_PASSWORD='password', \
  MASTER_SSL=1, \
  MASTER_SSL_CA = 'ca_file_name', \
  MASTER_SSL_CAPATH = 'ca_directory_name', \
  MASTER_SSL_CERT = 'cert_file_name', \
  MASTER_SSL_KEY = 'key_file_name';
```

Once the master information has been updated, start the slave replication process:

```
mysql> START SLAVE;
```

You can use the `SHOW SLAVE STATUS` to confirm that SSL connection has been completed.

For more information on the `CHANGE MASTER TO` syntax, see [Section 12.6.2.1, “CHANGE MASTER TO Syntax”](#).

If you want to enforce SSL connections to be used during replication, then create a user with the `REPLICATION SLAVE` privilege and use the `REQUIRE SSL` option for that user. For example:

```
mysql> GRANT REPLICATION SLAVE ON *.*
-> TO 'repl'@'%'.mydomain.com IDENTIFIED BY 'slavepass' REQUIRE SSL;
```

## 16.3. Replication Notes and Tips

### 16.3.1. Replication Features and Issues

The following sections provide information about what is supported and what is not in MySQL replication, and about specific issues and situations that may occur when replicating certain statements.

Statement-based replication depends on compatibility at the SQL level between the master and slave. In others, successful SBR requires that any SQL features used be supported by both the master and the slave servers. For example, if you use a feature on the master server that is available only in MySQL 5.1 (or later), you cannot replicate to a slave that uses MySQL 5.0 (or earlier).

Such incompatibilities also can occur within a release series when using pre-production releases of MySQL. For example, the `SLEEP()` function is available beginning with MySQL 5.0.12. If you use this function on the master, you cannot replicate to a slave that uses MySQL 5.0.11 or earlier.

For this reason, we recommend that you use Generally Available (GA) releases of MySQL for statement-based replication in a production setting, since we do not introduce new SQL statements or change their behavior within a given release series once that series reaches GA release status.

If you are planning to use statement-based replication between MySQL 5.1 and a previous MySQL release series, it is also a good idea to consult the edition of the *MySQL Reference Manual* corresponding to the earlier release series for information regarding the replication characteristics of that series.

With MySQL's classic statement-based replication, there may be issues with replicating stored routines or triggers. You can avoid these issues by using MySQL's row-based replication instead. For a detailed list of issues, see [Section 18.6, “Binary Logging of Stored Programs”](#). For more information about row-based replication and row-based logging, see [Section 16.1.2, “Replication Formats”](#), and [Section 5.2.4.1, “Binary Logging Formats”](#).

For additional information specific to replication and InnoDB, see [Section 13.6.4.5, “InnoDB and MySQL Replication”](#). For information relating to replication with MySQL Cluster, see [MySQL Cluster Replication](#).

#### 16.3.1.1. Replication and `AUTO_INCREMENT`

Statement-based replication of `AUTO_INCREMENT`, `LAST_INSERT_ID()`, and `TIMESTAMP` values is done correctly, subject to the following exceptions:

- A stored procedure that uses `LAST_INSERT_ID()` does not replicate properly using statement-based binary logging. This limitation is lifted in MySQL 5.1.12.
- Prior to MySQL 5.1.12, when a stored routine or trigger caused an `INSERT` into an `AUTO_INCREMENT` column, the generated `AUTO_INCREMENT` value was not written into the binary log, so a different value could in some cases be inserted on the slave.
- An insert into an `AUTO_INCREMENT` column caused by a stored routine or trigger running on a master that uses MySQL 5.0.60 or earlier does not replicate correctly to a slave running MySQL 5.1.12 through 5.1.23 (inclusive). ([Bug#33029](#))
- Table-level `AUTO_INCREMENT` option values were not replicated correctly prior to MySQL 5.1.31. ([Bug#41986](#))
- Adding an `AUTO_INCREMENT` column to a table with `ALTER TABLE` might not produce the same ordering of the rows on the slave and the master. This occurs because the order in which the rows are numbered depends on the specific storage engine used for the table and the order in which the rows were inserted. If it is important to have the same order on the master and slave, the rows must be ordered before assigning an `AUTO_INCREMENT` number. Assuming that you want to add an `AUTO_INCREMENT` column to the table `t1`, the following statements produce a new table `t2` identical to `t1` but with an `AUTO_INCREMENT` column:

```
CREATE TABLE t2 LIKE t1;
ALTER TABLE t2 ADD id INT AUTO_INCREMENT PRIMARY KEY;
INSERT INTO t2 SELECT * FROM t1 ORDER BY col1, col2;
```

This assumes that the table `t1` has columns `col1` and `col2`.

#### Important

To guarantee the same ordering on both master and slave, *all* columns of `t1` must be referenced in the `ORDER BY` clause.

The instructions just given are subject to the limitations of `CREATE TABLE ... LIKE`: Foreign key definitions are ignored, as are the `DATA DIRECTORY` and `INDEX DIRECTORY` table options. If a table definition includes any of those characteristics, create `t2` using a `CREATE TABLE` statement that is identical to the one used to create `t1`, but with the addition of the `AUTO_INCREMENT` column.

Regardless of the method used to create and populate the copy having the `AUTO_INCREMENT` column, the final step is to drop the original table and then rename the copy:

```
DROP t1;
ALTER TABLE t2 RENAME t1;
```

See also [Section B.1.7.1, “Problems with ALTER TABLE”](#).

### 16.3.1.2. Replication and Character Sets

The following applies to replication between MySQL servers that use different character sets:

1. If the master uses MySQL 4.1, you must *always* use the same *global* character set and collation on the master and the slave, regardless of the MySQL version running on the slave. (These are controlled by the `--character-set-server` and `--collation-server` options.) Otherwise, you may get duplicate-key errors on the slave, because a key that is unique in the master character set might not be unique in the slave character set. Note that this is not a cause for concern when master and slave are both MySQL 5.0 or later.
2. If the master is older than MySQL 4.1.3, the character set of any client should never be made different from its global value because this character set change is not known to the slave. In other words, clients should not use `SET NAMES`, `SET CHARACTER SET`, and so forth. If both the master and the slave are 4.1.3 or newer, clients can freely set session values for character set variables because these settings are written to the binary log and so are known to the slave. That is, clients can use `SET NAMES` or `SET CHARACTER SET` or can set variables such as `collation_client` or `collation_server`. However, clients are prevented from changing the *global* value of these variables; as stated previously, the master and slave must always have identical global character set values. This is true whether you are using statement-based or row-based replication.
3. If you have databases on the master with character sets that differ from the global `character_set_server` value, you should design your `CREATE TABLE` statements so that tables in those databases do not implicitly rely on the database default character set. A good workaround is to state the character set and collation explicitly in `CREATE TABLE` statements.

### 16.3.1.3. Replication of CREATE TABLE ... SELECT Statements

This section discusses the rules that are applied when a `CREATE TABLE ... SELECT` statement is replicated.

#### Note

`CREATE TABLE ... SELECT` always performs an implicit commit ([Section 12.4.3, “Statements That Cause an Implicit Commit”](#)).

**Statement succeeds.** If the `CREATE TABLE ... SELECT` statement succeeds on the master, then it is replicated as follows:

- **STATEMENT or MIXED format.** The `CREATE TABLE ... SELECT` statement is itself replicated.
- **ROW format.** The statement is replicated as a `CREATE TABLE` statement followed by a series of `binwrite` events (that is, binary inserts).

**Statement fails.** The failure of a `CREATE TABLE ... SELECT` is handled according to the following criteria:

- **No IF NOT EXISTS option.** If the `CREATE TABLE ... SELECT` does not contain an `IF NOT EXISTS` option, then the statement has no effect. However, the implicit commit caused by the statement is logged. This is true regardless of the replication format, storage engine used, and the reason for which the statement failed.
- **Statement uses IF NOT EXISTS.** If the `CREATE TABLE ... SELECT` statement includes the `IF NOT EXISTS` option and fails, the failure is handled according to the replication format. If the row-based format is in use, the action taken depends additionally on whether or not the table to be created uses a transactional or non-transactional storage engine, and on the reason for the failure:
  - **STATEMENT or MIXED format.** When using statement-based or mixed-format replication, the `CREATE TABLE IF NOT EXISTS ... SELECT` is logged with an error.
  - **ROW format.** When row-based replication is used, failure of a `CREATE TABLE ... SELECT` that includes `IF NOT EXISTS` is handled differently depending on the reason for the failure, as shown in the following diagram:



Transactional Table?	Reason for Failure		
	CREATE Succeeded; SELECT or Inserts Failed	CREATE Failed (Table Already Exists)	CREATE Failed (Other Reason)
YES	<ol style="list-style-type: none"> <li>1. Table is dropped</li> <li>2. Implicit commit is logged</li> </ol>	<ol style="list-style-type: none"> <li>1. CREATE TABLE statement is not logged</li> <li>2. Applied rows are logged</li> <li>3. Implicit commit is logged</li> </ol>	Only implicit commit is logged
NO	<ol style="list-style-type: none"> <li>1. CREATE TABLE statement is logged</li> <li>2. Applied rows are logged</li> <li>3. Implicit commit is logged</li> </ol>		

### 16.3.1.4. Replication with Differing Tables on Master and Slave

Starting with MySQL 5.1.21, source and target tables for replication do not have to be identical. A table on the master can have more or fewer columns than the slave's copy of the table. In addition — subject to certain conditions — corresponding table columns on the master and the slave can use different data types.

In all cases where the source and target tables do not have identical definitions, the following must be true in order for replication to work:

- You must be using row-based replication. (Using `MIXED` for the binary logging format does not work.)
- The database and table names must be the same on both the master and the slave.

Additional conditions are discussed (and examples provided) in the following two sections.

#### 16.3.1.4.1. Replication with More Columns on Master or Slave

Starting with MySQL 5.1.21, you can replicate a table from the master to the slave such that the master's copy of the table and the slave's copy of the table do not have the same number of columns, subject to the following conditions:

- Each “extra” column in the version of the table having more columns must have a default value.

#### Note

A column's default value is determined by a number of factors, including its type, whether it is defined with a `DEFAULT` option, whether it is declared as `NULL`, and the server SQL mode in effect at the time of its creation; see [Section 10.1.4, “Data Type Default Values”](#), for more information.

- Matching columns must be defined in the same order on both the master and the slave.
- Any additional columns must be defined following the matching columns.

In addition, when the slave's copy of the table has more columns than the master's copy, then each matching column must use the same data type.

**Examples.** The following examples illustrate some valid and invalid table definitions:

- **More columns on the master.** The following table definitions are valid:

```
master> CREATE TABLE t1 (c1 INT, c2 INT, c3 INT);
slave> CREATE TABLE t1 (c1 INT, c2 INT);
```

The following table definitions would raise Error 1532 (`ER_BINLOG_ROW_RBR_TO_SBR`) because the definitions of the columns common to both versions of the table are in a different order on the slave than they are on the master:



```
master> CREATE TABLE t1 (c1 INT, c2 INT, c3 INT);
slave> CREATE TABLE t1 (c2 INT, c1 INT);
```

The following table definitions would also raise Error 1532, because the definition of the extra column on the master appears before the definitions of the columns common to both versions of the table:

```
master> CREATE TABLE t1 (c3 INT, c1 INT, c2 INT);
slave> CREATE TABLE t1 (c1 INT, c2 INT);
```

- **More columns on the slave.** The following definitions replicate correctly:

```
master> CREATE TABLE t1 (c1 INT, c2 INT);
slave> CREATE TABLE t1 (c1 INT, c2 INT, c3 INT);
```

The following definitions raise Error 1532 because the columns common to both versions of the table are not defined in the same order on both the master and the slave:

```
master> CREATE TABLE t1 (c1 INT, c2 INT);
slave> CREATE TABLE t1 (c2 INT, c1 INT, c3 INT);
```

The following table definitions also raise Error 1532 because the definition for the extra column in the slave's version of the table appears before the definitions for the columns which are common to both versions of the table:

```
master> CREATE TABLE t1 (c1 INT, c2 INT);
slave> CREATE TABLE t1 (c3 INT, c1 INT, c2 INT);
```

The following table definitions fail, because the slave's version of the table has additional columns compared to the master's version, and the two versions of the table define column `c2` as a different data type.

```
master> CREATE TABLE t1 (c1 INT, c2 BIGINT);
slave> CREATE TABLE t1 (c1 INT, c2 INT, c3 INT);
```

#### 16.3.1.4.2. Replication of Columns Having Different Data Types

Corresponding columns on the master's and the slave's copies of the same table ideally should have the same data type. However, beginning with MySQL 5.1.21, this is not always strictly enforced, as long as certain conditions are met. These conditions are listed here:

- The slave's copy of the table cannot contain more columns than the master's copy.
- For columns holding numeric data types, the sizes may differ, as long as the size of the slave's version of the column is equal or greater to the size of the master's version of the column. This is sometimes referred to as *attribute promotion*, because the data type of the master's version of the column is promoted to a type that is the same size or larger on the slave.

Data type conversions currently supported by attribute promotion are shown in the following table, in which *X* and *N* both represent positive integers.

Original Data Type	Promoted Data Type(s)
CHAR( <i>X</i> )	CHAR( <i>X+N</i> )
VARCHAR( <i>X</i> )	VARCHAR( <i>X+N</i> )
CHAR( <i>X</i> )	VARCHAR( <i>X+N</i> )
BINARY( <i>X</i> )	BINARY( <i>X+N</i> )
VARBINARY( <i>X</i> )	VARBINARY( <i>X+N</i> )
BINARY( <i>X</i> )	VARBINARY( <i>X+N</i> )
BIT( <i>X</i> )	BIT( <i>X+N</i> )
TINYINT	SMALLINT, MEDIUMINT, INT, or BIGINT
SMALLINT	MEDIUMINT, INT, or BIGINT
MEDIUMINT	INT or BIGINT
INT	BIGINT

Unsigned integer columns can be promoted to larger unsigned types; for example, a column declared as `TINYINT UNSIGNED` can be restored to a column declared as `SMALLINT UNSIGNED`, `MEDIUMINT UNSIGNED`, `INT UNSIGNED`, or `BIGINT UNSIGNED`. You cannot promote a signed column to an unsigned type, or an unsigned column to a signed type.

For columns holding numeric data types the sizes may differ, as long as the size of the slave's version of the column is equal or greater to the size of the master's version of the column. For example, the following table definitions are allowed:

```
master> CREATE TABLE t1 (c1 TINYINT, c2 INT);
slave> CREATE TABLE t1 (c1 INT, c2 INT);
```

The slave's versions of both columns `c1` and `c2` are the same size as or larger than the master's versions of these columns. However, the following definitions would fail:

```
master> CREATE TABLE t1 (c1 INT, c2 FLOAT(8,3));
slave> CREATE TABLE t1 (c1 INT, c2 FLOAT(7,3));
```

In this case, Error 1532 would be raised because the master's copy of column `c2` is larger than its counterpart on the slave — that is, the master's copy of `c2` on the master can hold more digits than the slave's copy of the column.

- There is no conversion between integer (`TINYINT`, `SMALLINT`, `MEDIUMINT`, and so on) and non-integer (`FLOAT`, `DOUBLE`, `DECIMAL`, and so on) numeric data types, and so the following definitions would fail with Error 1532:

```
master> CREATE TABLE t1 (c1 INT, c2 FLOAT(8,3));
slave> CREATE TABLE t1 (c1 INT, c2 BIGINT);
```

A column using a non-integer numeric data type must always have the same definition on both the master and the slave.

- For columns storing `CHAR` and `BINARY` data, the size of the slave's copy of the column must be equal to or greater than the size of the master's copy. For example, the following table definitions would replicate successfully:

```
master> CREATE TABLE t1 (c1 INT, c2 CHAR(30));
slave> CREATE TABLE t1 (c1 INT, c2 CHAR(50));
```

If the size of the master's version of the column is greater than that of the slave's version of the column, replication fails with Error 1532.

- The replication process can convert freely between `BINARY`, `VARBINARY`, `CHAR` and `VARCHAR` columns, as long as the slave's version of the column is the same size as or larger than the master's version. For example, the following table definitions can be used successfully:

```
master> CREATE TABLE t1 (c1 INT, c2 VARBINARY(30));
slave> CREATE TABLE t1 (c1 INT, c2 CHAR(30));
```

### Note

Since replication is currently not supported between different character sets, it is sufficient when comparing sizes of columns containing character data to count the number of characters rather than the number of bytes.

- Attribute promotion can be used with both statement-based and row-based replication, and is not dependent on the storage engine used by either the master or the slave.

## 16.3.1.5. Replication and `DIRECTORY` Table Options

If a `DATA DIRECTORY` or `INDEX DIRECTORY` table option is used in a `CREATE TABLE` statement on the master server, the table option is also used on the slave. This can cause problems if no corresponding directory exists in the slave host file system or if it exists but is not accessible to the slave server. This can be overridden by using the `NO_DIR_IN_CREATE` server SQL mode on the slave, which causes the slave to ignore the `DATA DIRECTORY` and `INDEX DIRECTORY` table options when replicating `CREATE TABLE` statements. The result is that `MyISAM` data and index files are created in the table's database directory.

For more information, see [Section 5.1.7, “Server SQL Modes”](#).

## 16.3.1.6. Replication of `DROP ... IF EXISTS` Statements

The statements `DROP DATABASE IF EXISTS`, `DROP TABLE IF EXISTS`, and `DROP VIEW IF EXISTS` are always replicated, even if the database, table, or view to be dropped does not exist on the master. This is to ensure that the object to be dropped no longer exists on either the master or the slave, once the slave has caught up with the master.

Beginning with MySQL 5.1.33, the statements `DROP PROCEDURE IF EXISTS` and `DROP FUNCTION IF EXISTS` are also replicated, even if the procedure or function to be dropped does not exist on the master. ([Bug#13684](#))

## 16.3.1.7. Replication of Invoked Features

Replication of invoked features such as scheduled events, user-defined functions (UDFs), stored routines (including both stored procedures and stored functions), and triggers was re-implemented in MySQL 5.1.18 to provide the following characteristics:

- The effects of the feature are always replicated.
- The following statements are replicated using statement-based replication:
  - `CREATE EVENT`
  - `ALTER EVENT`
  - `DROP EVENT`
  - `CREATE PROCEDURE`
  - `DROP PROCEDURE`
  - `CREATE FUNCTION`
  - `DROP FUNCTION`
  - `CREATE TRIGGER`
  - `DROP TRIGGER`

However, the *effects* of features created, modified, or dropped using these statements are replicated using row-based replication.

### Note

Attempting to replicate invoked features using statement-based replication produces the warning `STATEMENT MAY NOT BE SAFE TO LOG IN STATEMENT FORMAT`. (Prior to MySQL 5.1.36, this was `STATEMENT IS NOT SAFE TO LOG IN STATEMENT FORMAT` — see [Bug#42415](#).) For example, trying to replicate a UDF with statement-based replication generates this warning because it currently cannot be determined by the MySQL server whether the UDF is deterministic. If you are absolutely certain that the invoked feature's effects are deterministic, you can safely disregard such warnings.

In a future MySQL release, we may implement ways for users to indicate that such features are deterministic, so that they can be recognized by the server as “safe” for statement-based replication. ([Bug#34597](#))

- In the case of `CREATE EVENT` and `ALTER EVENT`:
  - The status of the event is set to `SLAVESIDE_DISABLED` on the slave regardless of the state specified (this does not apply to `DROP EVENT`).
  - The master on which the event was created is identified on the slave by its server ID. The `ORIGINATOR` column in `INFORMATION_SCHEMA.EVENTS` and the `originator` column in `mysql.event` were added to these tables in MySQL 5.1.18 to store this information. (See [Section 19.20](#), “The `INFORMATION_SCHEMA.EVENTS` Table”, and [Section 12.5.5.19](#), “`SHOW EVENTS` Syntax”.)
- The feature implementation resides on the slave in a renewable state so that if the master fails, the slave can be used as the master without loss of event processing.

To determine whether there are any scheduled events on a MySQL server that were created on a different server (that was acting as a replication master), use `SHOW EVENTS`, like this:

```
SHOW EVENTS
WHERE STATUS = 'SLAVESIDE_DISABLED';
```

Alternatively, you might wish to query the `INFORMATION_SCHEMA.EVENTS` table as shown here:

```
SELECT EVENT_SCHEMA, EVENT_NAME, ORIGINATOR
FROM INFORMATION_SCHEMA.EVENTS
WHERE STATUS = 'SLAVESIDE_DISABLED';
```

When promoting a replication slave having such events to a replication master, use the following query to enable the events:

```
UPDATE mysql.event
SET STATUS = 'ENABLED'
WHERE STATUS = 'SLAVESIDE_DISABLED';
```

If more than one master was involved in creating events on this slave, and you wish to enable events that were created only on a given master having the server ID `master_id`, use the following query instead:

```
UPDATE mysql.event
SET STATUS = 'ENABLED'
WHERE ORIGINATOR = master_id
```

```
AND STATUS = 'SLAVESIDE_DISABLED';
```

### Important

Before executing either of the previous two `UPDATE` statements, you should disable the Event Scheduler on the slave (using `SET GLOBAL EVENT_SCHEDULER = OFF;`), run the `UPDATE`, restart the server, then re-enable the Event Scheduler afterwards (using `SET GLOBAL EVENT_SCHEDULER = ON;`).

If you later demote the new master back to being a replication slave, you must disable manually all events enabled by the `UPDATE` statement. You can do this by storing in a separate table the event names from the `SELECT` statement shown previously, or using an `UPDATE` statement to rename the events with a common prefix to identify them, as shown in this example:

```
UPDATE mysql.event
SET name = CONCAT('replicated_', name)
WHERE status = 'SLAVESIDE_DISABLED';
```

When demoting this server back to being a replication slave, you can then rename and disable the events like this:

```
UPDATE mysql.event
SET name = REPLACE(name, 'replicated_', ''),
status = 'SLAVESIDE_DISABLED'
WHERE INSTR(name, 'replicated_') = 1;
```

### 16.3.1.8. Replication with Floating-Point Values

With statement-based replication, values are converted from decimal to binary. Because conversions between decimal and binary representations of them may be approximate, comparisons involving floating-point values are inexact. This is true for operations that use floating-point values explicitly, or that use values that are converted to floating-point implicitly. Comparisons of floating-point values might yield different results on master and slave servers due to differences in computer architecture, the compiler used to build MySQL, and so forth. See [Section 11.2.2, “Type Conversion in Expression Evaluation”](#), and [Section B.1.5.8, “Problems with Floating-Point Comparisons”](#).

### 16.3.1.9. Replication and `FLUSH`

Some forms of the `FLUSH` statement are not logged because they could cause problems if replicated to a slave: `FLUSH LOGS`, `FLUSH MASTER`, `FLUSH SLAVE`, and `FLUSH TABLES WITH READ LOCK`. For a syntax example, see [Section 12.5.6.3, “FLUSH Syntax”](#). The `FLUSH TABLES`, `ANALYZE TABLE`, `OPTIMIZE TABLE`, and `REPAIR TABLE` statements are written to the binary log and thus replicated to slaves. This is not normally a problem because these statements do not modify table data.

However, this behavior can cause difficulties under certain circumstances. If you replicate the privilege tables in the `mysql` database and update those tables directly without using `GRANT`, you must issue a `FLUSH PRIVILEGES` on the slaves to put the new privileges into effect. In addition, if you use `FLUSH TABLES` when renaming a `MyISAM` table that is part of a `MERGE` table, you must issue `FLUSH TABLES` manually on the slaves. These statements are written to the binary log unless you specify `NO_WRITE_TO_BINLOG` or its alias `LOCAL`.

### 16.3.1.10. Replication and System Functions

Certain functions do not replicate well under some conditions:

- The `USER()`, `CURRENT_USER()`, `UUID()`, `VERSION()`, and `LOAD_FILE()` functions are replicated without change and thus do not work reliably on the slave unless row-based replication is enabled. This is also true for `CURRENT_USER`. (See [Section 16.1.2, “Replication Formats”](#).)

For early implementations of mixed-format logging, stored functions, triggers, and views that use these functions in their body do not replicate reliably in mixed-format logging mode because the logging did not switch from statement-based to row-based format. For example, `INSERT INTO t SELECT FROM v`, where `v` is a view that selects `UUID()` could cause problems. This limitation is lifted in MySQL 5.1.12.

Beginning with MySQL 5.1.23, `USER()`, `CURRENT_USER()`, and `CURRENT_USER` are automatically replicated using row-based replication when using `MIXED` mode, and generate a warning in `STATEMENT` mode. ([Bug#28086](#))

- For `NOW()`, the binary log includes the timestamp and replicates correctly.

Unlike `NOW()`, the `SYSDATE()` function is not replication-safe because it is not affected by `SET TIMESTAMP` statements in the binary log and is non-deterministic if statement-based logging is used. This is not a problem if row-based logging is used. Another option is to start the server with the `--sysdate-is-now` option to cause `SYSDATE()` to be an alias for `NOW()`.

- *The following restriction applies to statement-based replication only, not to row-based replication.* The `GET_LOCK()`, `RELEASE_LOCK()`, `IS_FREE_LOCK()`, and `IS_USED_LOCK()` functions that handle user-level locks are replicated without

the slave knowing the concurrency context on master. Therefore, these functions should not be used to insert into a master's table because the content on the slave would differ. (For example, do not issue a statement such as `INSERT INTO mytable VALUES (GET_LOCK(...))`.)

As a workaround for the preceding limitations when statement-based replication is in effect, you can use the strategy of saving the problematic function result in a user variable and referring to the variable in a later statement. For example, the following single-row `INSERT` is problematic due to the reference to the `UUID()` function:

```
INSERT INTO t VALUES(UUID());
```

To work around the problem, do this instead:

```
SET @my_uuid = UUID();
INSERT INTO t VALUES(@my_uuid);
```

That sequence of statements replicates because the value of `@my_uuid` is stored in the binary log as a user-variable event prior to the `INSERT` statement and is available for use in the `INSERT`.

The same idea applies to multiple-row inserts, but is more cumbersome to use. For a two-row insert, you can do this:

```
SET @my_uuid1 = UUID(); @my_uuid2 = UUID();
INSERT INTO t VALUES(@my_uuid1),(@my_uuid2);
```

However, if the number of rows is large or unknown, the workaround is difficult or impracticable. For example, you cannot convert the following statement to one in which a given individual user variable is associated with each row:

```
INSERT INTO t2 SELECT UUID(), * FROM t1;
```

Within a stored function, `RAND()` replicates correctly as long as it is invoked only once during the execution of the function. (You can consider the function execution timestamp and random number seed as implicit inputs that are identical on the master and slave.)

The `FOUND_ROWS()` and `ROW_COUNT()` functions are not replicated reliably using statement-based replication. A workaround is to store the result of the function call in a user variable, and then use that in the `INSERT` statement. For example, if you wish to store the result in a table named `mytable`, you might normally do so like this:

```
SELECT SQL_CALC_FOUND_ROWS FROM mytable LIMIT 1;
INSERT INTO mytable VALUES( FOUND_ROWS() );
```

However, if you are replicating `mytable`, then you should use `SELECT INTO`, and then store the variable in the table, like this:

```
SELECT SQL_CALC_FOUND_ROWS INTO @found_rows FROM mytable LIMIT 1;
INSERT INTO mytable VALUES(@found_rows);
```

In this way, the user variable is replicated as part of the context, and applied on the slave correctly.

Beginning with MySQL 5.1.23, these functions are automatically replicated using row-based replication when using `MIXED` mode, and generate a warning in `STATEMENT` mode. ([Bug#12092](#), [Bug#30244](#))

### 16.3.1.11. Replication and `LIMIT`

Statement-based replication of `LIMIT` clauses in `DELETE`, `UPDATE`, and `INSERT ... SELECT` statements is unsafe since the order of the rows affected is not defined. (Such statements can be replicated correctly when using `STATEMENT` mode only if they also contain an `ORDER BY` clause.) Beginning with MySQL 5.1.24, when such a statement is encountered:

- When using `STATEMENT` mode, a warning that the statement is not safe for statement-based replication is now issued. Currently, when using `STATEMENT` mode, warnings are issued for DML statements containing `LIMIT` even when they also have an `ORDER BY` clause (and so are made deterministic). This is a known issue which we are working to resolve in a future MySQL release. ([Bug#42851](#))
- When using `MIXED` mode, the statement is now automatically replicated using row-based mode.

### 16.3.1.12. Replication and `LOAD DATA`

The `LOAD DATA` statement is not replicated correctly to a slave running MySQL 5.1 or later from a master running MySQL 4.0 or earlier.

When using statement-based replication, the `LOAD DATA INFILE` statement's `CONCURRENT` option is not replicated; that is, `LOAD DATA CONCURRENT INFILE` is replicated as `LOAD DATA INFILE`, and `LOAD DATA CONCURRENT LOCAL INFILE` is replicated as `LOAD DATA LOCAL INFILE`. The `CONCURRENT` option *is* replicated when using row-based replication. (Bug#34628)

### 16.3.1.13. Replication and the Slow Query Log

Replication slaves do not write replicated queries to the slow query log, even if the same queries were written to the slow query log on the master.

This is a known issue which we intend to fix in a future version of MySQL. (Bug#23300)

### 16.3.1.14. Replication During a Master Crash

A crash on the master side can result in the master's binary log having a final position less than the most recent position read by the slave, due to the master's binary log file not being flushed. This can cause the slave not to be able to replicate when the master comes back up. Setting `sync_binlog=1` in the master `my.cnf` file helps to minimize this problem because it causes the master to flush its binary log more frequently.

### 16.3.1.15. Replication During a Master Shutdown

It is safe to shut down a master server and restart it later. When a slave loses its connection to the master, the slave tries to reconnect immediately and retries periodically if that fails. The default is to retry every 60 seconds. This may be changed with the `CHANGE MASTER TO` statement or `--master-connect-retry` option. A slave also is able to deal with network connectivity outages. However, the slave notices the network outage only after receiving no data from the master for `slave_net_timeout` seconds. If your outages are short, you may want to decrease `slave_net_timeout`. See Section 5.1.3, “Server System Variables”.

### 16.3.1.16. Replication with MEMORY Tables

When a server shuts down and restarts, its `MEMORY` tables become empty. The master replicates this effect to slaves as follows: The first time that the master uses each `MEMORY` table after startup, it logs an event that notifies the slaves that the table needs to be emptied by writing a `DELETE` statement for that table to the binary log. See Section 13.8, “The MEMORY (HEAP) Storage Engine”, for more information about `MEMORY` tables.

### 16.3.1.17. Replication of the System `mysql` Database

**MySQL 5.1.14 and later.** Data modification statements made to tables in the `mysql` database are replicated according to the value of `binlog_format`; if this value is `MIXED`, then these statements are replicated using the row-based format. However, statements that would normally update this information indirectly — such as `GRANT`, `REVOKE`, and statements manipulating triggers, stored routines, and views — are replicated to slaves using statement-based replication.

**MySQL 5.1.13 and earlier.** User privileges are replicated only if the `mysql` database is replicated. That is, the `GRANT`, `REVOKE`, `SET PASSWORD`, `CREATE USER`, and `DROP USER` statements take effect on the slave only if the replication setup includes the `mysql` database.

### 16.3.1.18. Replication and the Query Optimizer

It is possible for the data on the master and slave to become different if a statement is designed in such a way that the data modification is non-deterministic; that is, left up to the query optimizer. (This is in general not a good practice, even outside of replication.) Examples of non-deterministic statements include `DELETE` or `UPDATE` statements that use `LIMIT` with no `ORDER BY` clause; see Section 16.3.1.11, “Replication and `LIMIT`”, for a detailed discussion of these.

### 16.3.1.19. Replication and Reserved Words

You can encounter problems when you are attempting to replicate from an older master to a newer slave and you make use of identifiers on the master that are reserved words in the newer MySQL version running on the slave. An example of this is using a table column named `current_user` on a 4.0 master that is replicating to a 4.1 or higher slave, because `CURRENT_USER` is a reserved word beginning in MySQL 4.1. Replication can fail in such cases with Error 1064 `YOU HAVE AN ERROR IN YOUR SQL SYNTAX . . .`, even if a database or table named using the reserved word or a table having a column named using the reserved word is excluded from replication. This is due to the fact that each SQL statement must be parsed by the slave prior to execution, so that the slave knows which database object or objects would be effected by the statement; only after the statement is parsed can the slave apply any filtering rules defined by `--replicate-do-db`, `--replicate-do-table`, `--replicate-ignore-db`, and `--replicate-ignore-table`.

To work around the problem of database, table, or column names on the master which would be regarded as reserved words by the slave, do one of the following:



- Use one or more `ALTER TABLE` statements on the master to change the names of any database objects where these names would be considered reserved words on the slave, and change any SQL statements that use the old names to use the new names instead.
- In any SQL statements using these database object names, set the names off using backtick characters (```).

For listings of reserved words by MySQL version, see [Reserved Words](#), in the *MySQL Server Version Reference*.

### 16.3.1.20. Slave Errors during Replication

If a statement on a slave produces an error, the slave SQL thread terminates, and the slave writes a message to its error log. You should then connect to the slave manually and determine the cause of the problem. (`SHOW SLAVE STATUS` is useful for this.) Then fix the problem (for example, you might need to create a non-existent table) and run `START SLAVE`.

### 16.3.1.21. Replication during a Slave Shutdown

Shutting down the slave (cleanly) is also safe because it keeps track of where it left off. Unclean shutdowns might produce problems, especially if the disk cache was not flushed to disk before the system went down. Your system fault tolerance is greatly increased if you have a good uninterruptible power supply. Unclean shutdowns of the master may cause inconsistencies between the content of tables and the binary log in master.

### 16.3.1.22. Replication and Temporary Tables

This item does not apply when row-based replication is in use because in that case temporary tables are not replicated (see [Section 16.1.2, “Replication Formats”](#)).

**Safe shutdown of slaves when using temporary tables.** Temporary tables are replicated except in the case where you shut down the slave server (not just the slave threads) and you have replicated temporary tables that are used in updates that have not yet been executed on the slave. If you shut down the slave server, the temporary tables needed by those updates are no longer available when the slave is restarted. To avoid this problem, do not shut down the slave while it has temporary tables open. Instead, use the following procedure:

1. Issue a `STOP SLAVE SQL_THREAD` statement.
2. Use `SHOW STATUS` to check the value of the `Slave_open_temp_tables` variable.
3. If the value is 0, issue a `mysqladmin shutdown` command to stop the slave.
4. If the value is not 0, restart the slave SQL thread with `START SLAVE SQL_THREAD`.
5. Repeat the procedure later until the `Slave_open_temp_tables` variable is 0 and you can stop the slave.

**Temporary tables and replication options.** By default, all temporary tables are replicated; this happens whether or not there are any matching `--replicate-do-db`, `--replicate-do-table`, or `--replicate-wild-do-table` options in effect. However, the `--replicate-ignore-table` and `--replicate-wild-ignore-table` options are honored for temporary tables.

A recommended practice when using statement-based or mixed-format replication is to designate a prefix for exclusive use in naming temporary tables that you do not want replicated, then employ a matching `--replicate-wild-ignore-table` option. For example, you might give all such tables names beginning with `norep_` (such as `norep_tablea`, `norep_tableb`, and so on), then use `--replicate-wild-ignore-table=norep_` to prevent the replication of these tables.

### 16.3.1.23. Replication Retries and Timeouts

The global system variable `slave_transaction_retries` affects replication as follows: If the replication slave SQL thread fails to execute a transaction because of an InnoDB deadlock or because it exceeded the InnoDB `innodb_lock_wait_timeout` value, or the `NDBCLUSTER TransactionDeadlockDetectionTimeout` or `TransactionInactiveTimeout` value, the transaction is automatically retried `slave_transaction_retries` times before stopping with an error. The default value is 10. The total retry count can be seen in the output of `SHOW STATUS`; see [Section 5.1.6, “Server Status Variables”](#).

### 16.3.1.24. Replication and Time Zones

If the master uses MySQL 4.1, the same system time zone should be set for both master and slave. Otherwise some statements will not be replicated properly, such as statements that use the `NOW()` or `FROM_UNIXTIME()` functions. You can set the time zone in which MySQL server runs by using the `--timezone=timezone_name` option of the `mysqld_safe` script or by setting the `TZ` environment variable. Both master and slave should also have the same default connection time zone setting; that is, the -

`-default-time-zone` parameter should have the same value for both master and slave. Note that this is not necessary when the master is MySQL 5.0 or later.

`CONVERT_TZ(..., ..., @@session.time_zone)` is properly replicated only if both master and slave are running MySQL 5.0.4 or newer.

### 16.3.1.25. Replication and Transactions

It is possible to replicate transactional tables on the master using non-transactional tables on the slave. For example, you can replicate an `InnoDB` master table as a `MyISAM` slave table. However, if you do this, there are problems if the slave is stopped in the middle of a `BEGIN/COMMIT` block because the slave restarts at the beginning of the `BEGIN` block.

**Mixing transactional and non-transactional statements within the same transaction.** The semantics of mixing non-transactional and transactional tables in a transaction in the first statement of a transaction changed in MySQL 5.1.31. Previously, if the first statement in a transaction contained non-transactional changes, the statement was written directly to the binary log, in an attempt to mimic the non-transactional behavior of the statement. Beginning with MySQL 5.1.31, any statement appearing after a `BEGIN` is always considered part of the transaction and cached. This means that non-transactional changes do not propagate to the slave until the transaction is committed and thus written to the binary log. In addition (also beginning with MySQL 5.1.31), if `AUTOMCOMMIT` is set to 0, any statement appearing immediately following a `COMMIT` is handled in the same way.

Previously, a statement was considered non-transactional if it changed a non-transactional table. This behavior had the following subtle but non-trivial consequences:

- A statement containing only non-transactional changes was written immediately to the binary log (sometime referred to as “write-ahead”).
- A statement containing only transactional changes was always cached while waiting for the transaction to be committed.
- A statement containing a mix of transactional and non-transactional changes (that is, a statement updating both transactional and non-transactional tables) could lead to mismatched tables on the master and the slave.

In situations where transactions mix updates to transactional and non-transactional tables, the order of statements in the binary log is correct, and all needed statements are written to the binary log even in case of a `ROLLBACK`. However, when a second connection updates the non-transactional table before the first connection's transaction is complete, statements can be logged out of order, because the second connection's update is written immediately after it is performed, regardless of the state of the transaction being performed by the first connection.

Due to the non-transactional nature of `MyISAM` tables, it is possible to have a statement that only partially updates a table and returns an error code. This can happen, for example, on a multiple-row insert that has one row violating a key constraint, or if a long update statement is killed after updating some of the rows. If that happens on the master, the slave thread exits and waits for the database administrator to decide what to do about it unless the error code is legitimate and execution of the statement results in the same error code on the slave. If this error code validation behavior is not desirable, some or all errors can be masked out (ignored) with the `--slave-skip-errors` option.

#### Caution

You should avoid transactions that update both transactional and non-transactional tables in a replication environment.

When the storage engine type of the slave is non-transactional, transactions on the master that mix updates of transactional and non-transactional tables should be avoided because they can cause inconsistency of the data between the master's transactional table and the slave's non-transactional table. That is, such transactions can lead to master storage engine-specific behavior with the possible effect of replication going out of synchrony. MySQL does not issue a warning about this currently, so extra care should be taken when replicating transactional tables from the master to non-transactional ones on the slaves.

### 16.3.1.26. Replication and Triggers

Triggers are not executed on the slave under row-based replication. However, they are executed on the slave under statement-based replication. Instead, when using row-based replication, the changes caused by executing the trigger on the master are applied on the slave.

This behavior is by design. The reason for this is that, if both the master and the slave applied the changes from the master and, in addition, the trigger causing these changes were applied on the slave, the changes would in effect be applied twice on the slave, leading to different data on the master and the slave.

If you wish for triggers to execute on both the master and the slave — perhaps because you have different triggers on the master and slave — then you must use statement-based replication. However, it is not necessary to use statement-based replication exclusively if you want to enable slave-side triggers; it is sufficient in such cases to switch to statement-based replication only for those statements where you want this effect, and to use row-based replication the rest of the time.



Before MySQL 5.1.31, a trigger that was defined on a transactional table but that updated a non-transactional tables could cause updates on the transactional table to be replicated before they were actually committed on the master, and not be rolled back correctly on the slave if they were rolled back on the master. (Bug#40116) See also [Section 16.3.1.25, “Replication and Transactions”](#).

### 16.3.1.27. Replication and TRUNCATE

`TRUNCATE` is normally regarded as a DML statement, and so would be expected to be logged and replicated using row-based format when the binary logging mode is `ROW` or `MIXED`. However this caused issues when logging or replicating, in `STATEMENT` or `MIXED` mode, tables that used transactional storage engines such as `InnoDB` when the transaction isolation level was `READ COMMITTED` or `READ UNCOMMITTED`, which precludes statement-based logging.

Beginning with MySQL 5.1.32, `TRUNCATE` is treated for purposes of logging and replication as DDL rather than DML so that it can be logged and replicated as a statement. However, the effects of the statement as applicable to `InnoDB` and other transactional tables on replication slaves still follow the rules described in [Section 12.2.10, “TRUNCATE Syntax”](#) governing such tables. (Bug#36763)

### 16.3.1.28. Replication and Variables

The `foreign_key_checks`, `unique_checks`, and `sql_auto_is_null` variables are all replicated.

`sql_mode` is also replicated except for the `NO_DIR_IN_CREATE` mode. However, when `mysqlbinlog` parses a `SET @@sql_mode = value` statement, the full `value`, including `NO_DIR_IN_CREATE`, is passed to the receiving server.

The `storage_engine` system variable is not replicated, which is a good thing for replication between different storage engines.

Session variables are not replicated properly when used in statements that update tables. For example, `SET MAX_JOIN_SIZE=1000` followed by `INSERT INTO mytable VALUES(@@MAX_JOIN_SIZE)` will not insert the same data on the master and the slave. This does not apply to the common sequence of `SET TIME_ZONE=...` followed by `INSERT INTO mytable VALUES(CONVERT_TZ(..., ..., @@time_zone))`.

Replication of session variables is not a problem when row-based replication is being used. See [Section 16.1.2, “Replication Formats”](#).

### 16.3.1.29. Replication and Views

Views are always replicated to slaves. Views are filtered by their own name, not by the tables they refer to. This means that a view can be replicated to the slave even if the view contains a table that would normally be filtered out by `replication-ignore-table` rules. Care should therefore be taken to ensure that views do not replicate table data that would normally be filtered for security reasons.

## 16.3.2. Replication Compatibility Between MySQL Versions

MySQL supports replication from one major version to the next higher major version. For example, you can replicate from a master running MySQL 4.1 to a slave running MySQL 5.0, from a master running MySQL 5.0 to a slave running MySQL 5.1, and so on.

In some cases, it is also possible to replicate between a master and a slave that is more than one major version newer than the master. However, there are known issues with trying to replicate from a master running MySQL 4.1 or earlier to a slave running MySQL 5.1 or later. To work around such problems, you can insert a MySQL server running an intermediate version between the two; for example, rather than replicating directly from a MySQL 4.1 master to a MySQL 5.1 slave, it is possible to replicate from a MySQL 4.1 server to a MySQL 5.0 server, and then from the MySQL 5.0 server to a MySQL 5.1 server.

#### Important

We strongly recommend using the most recent release available within a given MySQL major version because replication (and other) capabilities are continually being improved. We also recommend upgrading masters and slaves that use alpha or beta releases of a major version of MySQL to GA (production) releases when these become available for that major version.

Replication from newer masters to older slaves may be possible, but is generally not supported. This is due to a number of factors:

- **Binary log format changes.** The binary log format can change between major releases. While we attempt to maintain backward compatibility, this is not always possible. For example, the binary log format implemented in MySQL 5.0 changed considerably from that used in previous versions, especially with regard to handling of character sets, `LOAD DATA INFILE`, and time zones. This means that replication from a MySQL 5.0 (or later) master to a MySQL 4.1 (or earlier) slave is generally not supported.

This also has significant implications for upgrading replication servers; see [Section 16.3.3, “Upgrading a Replication Setup”](#),

for more information.

- **Use of row-based replication.** You cannot replicate using row-based replication from a MySQL 5.1.5 or later master to a slave running an earlier version of MySQL, since MySQL versions prior to 5.1.5 do not support RBR.

For more information about row-based replication, see [Section 16.1.2, “Replication Formats”](#).

- **SQL incompatibilities.** You cannot replicate from a newer master to an older slave using statement-based replication if the statements to be replicated use SQL features available on the master but not on the slave.

However, if both the master and the slave support row-based replication, and there are no data definition statements to be replicated that depend on SQL features found on the master but not on the slave, then you can use row-based replication to replicate the effects of data modification statements even if the DDL run on the master is not supported on the slave.

For more information on potential replication issues, see [Section 16.3.1, “Replication Features and Issues”](#).

### 16.3.3. Upgrading a Replication Setup

When you upgrade servers that participate in a replication setup, the procedure for upgrading depends on the current server versions and the version to which you are upgrading.

This section applies to upgrading replication from older versions of MySQL to MySQL 5.1. A 4.0 server should be 4.0.3 or newer.

When you upgrade a master to 5.1 from an earlier MySQL release series, you should first ensure that all the slaves of this master are using the same 5.1.x release. If this is not the case, you should first upgrade the slaves. To upgrade each slave, shut it down, upgrade it to the appropriate 5.1.x version, restart it, and restart replication. The 5.1 slave is able to read the old relay logs written prior to the upgrade and to execute the statements they contain. Relay logs created by the slave after the upgrade are in 5.1 format.

After the slaves have been upgraded, shut down the master, upgrade it to the same 5.1.x release as the slaves, and restart it. The 5.1 master is able to read the old binary logs written prior to the upgrade and to send them to the 5.1 slaves. The slaves recognize the old format and handle it properly. Binary logs created by the master following the upgrade are in 5.1 format. These too are recognized by the 5.1 slaves.

In other words, there are no measures to take when upgrading to MySQL 5.1, except that the slaves must be MySQL 5.1 before you can upgrade the master to 5.1. Note that downgrading from 5.1 to older versions does not work so simply: You must ensure that any 5.1 binary logs or relay logs have been fully processed, so that you can remove them before proceeding with the downgrade.

Downgrading a replication setup to a previous version cannot be done once you have switched from statement-based to row-based replication, and after the first row-based statement has been written to the binlog. See [Section 16.1.2, “Replication Formats”](#).

### 16.3.4. Replication FAQ

#### Questions

- [16.3.4.1](#): Does the slave need to be connected to the master all the time?
- [16.3.4.2](#): Do I have to enable networking on my master to enable replication?
- [16.3.4.3](#): How do I know how late a slave is compared to the master? In other words, how do I know the date of the last statement replicated by the slave?
- [16.3.4.4](#): How do I force the master to block updates until the slave catches up?
- [16.3.4.5](#): What issues should I be aware of when setting up two-way replication?
- [16.3.4.6](#): How can I use replication to improve performance of my system?
- [16.3.4.7](#): What should I do to prepare client code in my own applications to use performance-enhancing replication?
- [16.3.4.8](#): When and how much can MySQL replication improve the performance of my system?
- [16.3.4.9](#): How can I use replication to provide redundancy or high availability?
- [16.3.4.10](#): How do I tell whether a master server is using statement-based or row-based binary logging format?
- [16.3.4.11](#): How do I tell a slave to use row-based replication?
- [16.3.4.12](#): How do I prevent `GRANT` and `REVOKE` statements from replicating to slave machines?

- [16.3.4.13](#): Does replication work on mixed operating systems (for example, the master runs on Linux while slaves run on Mac OS X and Windows)?
- [16.3.4.14](#): Does replication work on mixed hardware architectures (for example, the master runs on a 64-bit machine while slaves run on 32-bit machines)?

## Questions and Answers

### 16.3.4.1: Does the slave need to be connected to the master all the time?

No, it does not. The slave can go down or stay disconnected for hours or even days, and then reconnect and catch up on updates. For example, you can set up a master/slave relationship over a dial-up link where the link is up only sporadically and for short periods of time. The implication of this is that, at any given time, the slave is not guaranteed to be in sync with the master unless you take some special measures.

To ensure that this is the case, you must not remove binary logs from the master, where the information has not been replicated to the slaves. Asynchronous replication can only work if the slave is able to read the binary log from the last point in the binary logs where it had read the replication statements.

### 16.3.4.2: Do I have to enable networking on my master to enable replication?

Networking must be enabled on the master. If networking is not enabled, then the slave is unable to connect to the master and transfer the binary log. Check that the `skip-networking` option has not been enabled in your configuration file.

### 16.3.4.3: How do I know how late a slave is compared to the master? In other words, how do I know the date of the last statement replicated by the slave?

You can read the `Seconds_Behind_Master` column in `SHOW SLAVE STATUS`. See [Section 16.4.1, “Replication Implementation Details”](#).

When the slave SQL thread executes an event read from the master, it modifies its own time to the event timestamp. (This is why `TIMESTAMP` is well replicated.) In the `Time` column in the output of `SHOW PROCESSLIST`, the number of seconds displayed for the slave SQL thread is the number of seconds between the timestamp of the last replicated event and the real time of the slave machine. You can use this to determine the date of the last replicated event. Note that if your slave has been disconnected from the master for one hour, and then reconnects, you may immediately see `Time` values like 3600 for the slave SQL thread in `SHOW PROCESSLIST`. This is because the slave is executing statements that are one hour old.

### 16.3.4.4: How do I force the master to block updates until the slave catches up?

Use the following procedure:

1. On the master, execute these statements:

```
mysql> FLUSH TABLES WITH READ LOCK;
mysql> SHOW MASTER STATUS;
```

Record the replication coordinates (the log file name and offset) from the output of the `SHOW` statement.

2. On the slave, issue the following statement, where the arguments to the `MASTER_POS_WAIT()` function are the replication coordinate values obtained in the previous step:

```
mysql> SELECT MASTER_POS_WAIT('log_name', log_offset);
```

The `SELECT` statement blocks until the slave reaches the specified log file and offset. At that point, the slave is in synchrony with the master and the statement returns.

3. On the master, issue the following statement to allow the master to begin processing updates again:

```
mysql> UNLOCK TABLES;
```

### 16.3.4.5: What issues should I be aware of when setting up two-way replication?

MySQL replication currently does not support any locking protocol between master and slave to guarantee the atomicity of a distributed (cross-server) update. In other words, it is possible for client A to make an update to co-master 1, and in the meantime, before it propagates to co-master 2, client B could make an update to co-master 2 that makes the update of client A work differently than it did on co-master 1. Thus, when the update of client A makes it to co-master 2, it produces tables that are different from what you have on co-master 1, even after all the updates from co-master 2 have also propagated. This means that you should not chain

two servers together in a two-way replication relationship unless you are sure that your updates can safely happen in any order, or unless you take care of mis-ordered updates somehow in the client code.

You should also realize that two-way replication actually does not improve performance very much (if at all) as far as updates are concerned. Each server must do the same number of updates, just as you would have a single server do. The only difference is that there is a little less lock contention, because the updates originating on another server are serialized in one slave thread. Even this benefit might be offset by network delays.

#### 16.3.4.6: How can I use replication to improve performance of my system?

You should set up one server as the master and direct all writes to it. Then configure as many slaves as you have the budget and rackspace for, and distribute the reads among the master and the slaves. You can also start the slaves with the `--skip-innodb`, `--low-priority-updates`, and `--delay-key-write=ALL` options to get speed improvements on the slave end. In this case, the slave uses non-transactional `MyISAM` tables instead of `InnoDB` tables to get more speed by eliminating transactional overhead.

#### 16.3.4.7: What should I do to prepare client code in my own applications to use performance-enhancing replication?

See the guide to using replication as a scale-out solution, [Section 16.2.3, “Using Replication for Scale-Out”](#).

#### 16.3.4.8: When and how much can MySQL replication improve the performance of my system?

MySQL replication is most beneficial for a system that processes frequent reads and infrequent writes. In theory, by using a single-master/multiple-slave setup, you can scale the system by adding more slaves until you either run out of network bandwidth, or your update load grows to the point that the master cannot handle it.

To determine how many slaves you can use before the added benefits begin to level out, and how much you can improve performance of your site, you need to know your query patterns, and to determine empirically by benchmarking the relationship between the throughput for reads (reads per second, or `reads`) and for writes (`writes`) on a typical master and a typical slave. The example here shows a rather simplified calculation of what you can get with replication for a hypothetical system.

Let's say that system load consists of 10% writes and 90% reads, and we have determined by benchmarking that `reads` is  $1200 - 2 \times \text{writes}$ . In other words, the system can do 1,200 reads per second with no writes, the average write is twice as slow as the average read, and the relationship is linear. Let us suppose that the master and each slave have the same capacity, and that we have one master and  $N$  slaves. Then we have for each server (master or slave):

$$\text{reads} = 1200 - 2 \times \text{writes}$$

$$\text{reads} = 9 \times \text{writes} / (N + 1) \text{ (reads are split, but writes go to all servers)}$$

$$9 \times \text{writes} / (N + 1) + 2 \times \text{writes} = 1200$$

$$\text{writes} = 1200 / (2 + 9/(N+1))$$

The last equation indicates the maximum number of writes for  $N$  slaves, given a maximum possible read rate of 1,200 per minute and a ratio of nine reads per write.

This analysis yields the following conclusions:

- If  $N = 0$  (which means we have no replication), our system can handle about  $1200/11 = 109$  writes per second.
- If  $N = 1$ , we get up to 184 writes per second.
- If  $N = 8$ , we get up to 400 writes per second.
- If  $N = 17$ , we get up to 480 writes per second.
- Eventually, as  $N$  approaches infinity (and our budget negative infinity), we can get very close to 600 writes per second, increasing system throughput about 5.5 times. However, with only eight servers, we increase it nearly four times.

Note that these computations assume infinite network bandwidth and neglect several other factors that could be significant on your system. In many cases, you may not be able to perform a computation similar to the one just shown that accurately predicts what will happen on your system if you add  $N$  replication slaves. However, answering the following questions should help you decide whether and by how much replication will improve the performance of your system:

- What is the read/write ratio on your system?
- How much more write load can one server handle if you reduce the reads?

- For how many slaves do you have bandwidth available on your network?

#### 16.3.4.9: How can I use replication to provide redundancy or high availability?

How you implement redundancy is entirely dependent on your application and circumstances. High-availability solutions (with automatic failover) require active monitoring and either custom scripts or third party tools to provide the failover support from the original MySQL server to the slave.

To handle the process manually, you should be able to switch from a failed master to a pre-configured slave by altering your application to talk to the new server or by adjusting the DNS for the MySQL server from the failed server to the new server.

For more information and some example solutions, see [Section 16.2.6, “Switching Masters During Failover”](#).

#### 16.3.4.10: How do I tell whether a master server is using statement-based or row-based binary logging format?

Check the value of the `binlog_format` system variable:

```
mysql> SHOW VARIABLES LIKE 'binlog_format';
```

The value shown is one of `STATEMENT`, `ROW`, or `MIXED`. When `MIXED` mode is in use, row-based replication is preferred but replication switches automatically to statement-based format under certain conditions; see [Section 5.2.4.3, “Mixed Binary Logging Format”](#), for information about when this may occur.

#### 16.3.4.11: How do I tell a slave to use row-based replication?

Slaves automatically know which format to use.

#### 16.3.4.12: How do I prevent `GRANT` and `REVOKE` statements from replicating to slave machines?

Start the server with the `--replicate-wild-ignore-table=mysql.%` option.

#### 16.3.4.13: Does replication work on mixed operating systems (for example, the master runs on Linux while slaves run on Mac OS X and Windows)?

Yes.

#### 16.3.4.14: Does replication work on mixed hardware architectures (for example, the master runs on a 64-bit machine while slaves run on 32-bit machines)?

Yes.

## 16.3.5. Troubleshooting Replication

If you have followed the instructions, and your replication setup is not working, the first thing to do is *check the error log for messages*. Many users have lost time by not doing this soon enough after encountering problems.

If you cannot tell from the error log what the problem was, try the following techniques:

- Verify that the master has binary logging enabled by issuing a `SHOW MASTER STATUS` statement. If logging is enabled, `Position` is nonzero. If binary logging is not enabled, verify that you are running the master with the `--log-bin` and `--server-id` options.
- Verify that the slave is running. Use `SHOW SLAVE STATUS` to check whether the `Slave_IO_Running` and `Slave_SQL_Running` values are both `Yes`. If not, verify the options that were used when starting the slave server. For example, `--skip-slave-start` prevents the slave threads from starting until you issue a `START SLAVE` statement.
- If the slave is running, check whether it established a connection to the master. Use `SHOW PROCESSLIST`, find the I/O and SQL threads and check their `State` column to see what they display. See [Section 16.4.1, “Replication Implementation Details”](#). If the I/O thread state says `Connecting to master`, check the following:
  - Verify the privileges for the user being used for replication on the master.
  - Check that the host name of the master is correct and that you are using the correct port to connect to the master. The port used for replication is the same as used for client network communication (the default is `3306`). For the host name, ensure that the name resolves to the correct IP address.
  - Check that networking on the master has not been disabled. Look for the `skip-networking` option in the configuration file. It should either be commented out or deleted entirely.

- If the master has a firewall or IP filtering configuration, ensure that the network port being used for MySQL is not being filtered.
- Check that you can reach the master by using `ping` or `traceroute/tracert` to reach the host.
- If the slave was running previously but has stopped, the reason usually is that some statement that succeeded on the master failed on the slave. This should never happen if you have taken a proper snapshot of the master, and never modified the data on the slave outside of the slave thread. If the slave stops unexpectedly, it is a bug or you have encountered one of the known replication limitations described in [Section 16.3.1, “Replication Features and Issues”](#). If it is a bug, see [Section 16.3.6, “How to Report Replication Bugs or Problems”](#), for instructions on how to report it.
- If a statement that succeeded on the master refuses to run on the slave, try the following procedure if it is not feasible to do a full database resynchronization by deleting the slave's databases and copying a new snapshot from the master:
  1. Determine whether the affected table on the slave is different from the master table. Try to understand how this happened. Then make the slave's table identical to the master's and run `START SLAVE`.
  2. If the preceding step does not work or does not apply, try to understand whether it would be safe to make the update manually (if needed) and then ignore the next statement from the master.
  3. If you decide that you can skip the next statement from the master, issue the following statements:

```
mysql> SET GLOBAL SQL_SLAVE_SKIP_COUNTER = N;
mysql> START SLAVE;
```

The value of *N* should be 1 if the next statement from the master does not use `AUTO_INCREMENT` or `LAST_INSERT_ID()`. Otherwise, the value should be 2. The reason for using a value of 2 for statements that use `AUTO_INCREMENT` or `LAST_INSERT_ID()` is that they take two events in the binary log of the master.

See also [Section 12.6.2.6, “SET GLOBAL SQL\\_SLAVE\\_SKIP\\_COUNTER Syntax”](#).

4. If you are sure that the slave started out perfectly synchronized with the master, and that no one has updated the tables involved outside of the slave thread, then presumably the discrepancy is the result of a bug. If you are running the most recent version of MySQL, please report the problem. If you are running an older version, try upgrading to the latest production release to determine whether the problem persists.

## 16.3.6. How to Report Replication Bugs or Problems

When you have determined that there is no user error involved, and replication still either does not work at all or is unstable, it is time to send us a bug report. We need to obtain as much information as possible from you to be able to track down the bug. Please spend some time and effort in preparing a good bug report.

If you have a repeatable test case that demonstrates the bug, please enter it into our bugs database using the instructions given in [Section 1.6, “How to Report Bugs or Problems”](#). If you have a “phantom” problem (one that you cannot duplicate at will), use the following procedure:

1. Verify that no user error is involved. For example, if you update the slave outside of the slave thread, the data goes out of synchrony, and you can have unique key violations on updates. In this case, the slave thread stops and waits for you to clean up the tables manually to bring them into synchrony. *This is not a replication problem. It is a problem of outside interference causing replication to fail.*
2. Run the slave with the `--log-slave-updates` and `--log-bin` options. These options cause the slave to log the updates that it receives from the master into its own binary logs.
3. Save all evidence before resetting the replication state. If we have no information or only sketchy information, it becomes difficult or impossible for us to track down the problem. The evidence you should collect is:
  - All binary logs from the master
  - All binary logs from the slave
  - The output of `SHOW MASTER STATUS` from the master at the time you discovered the problem
  - The output of `SHOW SLAVE STATUS` from the slave at the time you discovered the problem
  - Error logs from the master and the slave



- Use `mysqlbinlog` to examine the binary logs. The following should be helpful to find the problem statement. `log_pos` and `log_file` are the `Master_Log_File` and `Read_Master_Log_Pos` values from `SHOW SLAVE STATUS`.

```
shell> mysqlbinlog --start-position=log_pos log_file | head
```

After you have collected the evidence for the problem, try to isolate it as a separate test case first. Then enter the problem with as much information as possible into our bugs database using the instructions at [Section 1.6, “How to Report Bugs or Problems”](#).

## 16.4. Replication Implementation

The basic mechanics of replication is based on the master server keeping track of all changes to your databases (updates, deletes, and so on) in its binary logs. The binary log serves as a written record of each to the database from the moment the database was started. The binary log contains records of all the statements which edit or modify either the database structure or the data that the structure contains. Typically `SELECT` statements are not recorded, as they do not modify the database data or structure.

Each slave that connects to the master receives a copy of the binary log, and executes the events within the binary log. This has the effect of repeating the original statements and changes just as they were made on the master. Tables are created or their structure modified, and data is inserted, deleted and updated according to the statements that were originally executed on the master.

Because each slave is independent, the replaying of the statements in the masters binary log can occur on each slave that is connected to the master. In addition, because each slave only receives a copy of the binary log by requesting it from the master (it pulls the data from the master, rather than the master pushing the data to the slave), the slave is able to read and update the copy of the database at its own pace and rate and can start and stop the replication process at will without affecting the master or the slaves ability to update to the latest database status.

For more information on the specifics of the replication implementation, see [Section 16.4.1, “Replication Implementation Details”](#).

Slaves and masters report their status in respect of the replication process regularly so that you can monitor the situation. For information on slave states, see [Section 7.5.6.5, “Replication Slave I/O Thread States”](#), and [Section 7.5.6.6, “Replication Slave SQL Thread States”](#). For master states, see [Section 7.5.6.4, “Replication Master Thread States”](#).

The master binary log is written to a local relay log on the slave before it is processed. The slave also records information about the current position with the master's binary log and the local relayed log. See [Section 16.4.2, “Replication Relay and Status Files”](#).

Databases and tables are updated on the slave according to a set of rules that are applied according to the various configuration options and variables that control statement evaluation. For details on how these rules are applied, see [Section 16.4.3, “How Servers Evaluate Replication Rules”](#).

### 16.4.1. Replication Implementation Details

MySQL replication capabilities are implemented using three threads (one on the master server and two on the slave):

- Slave I/O thread.** When a `START SLAVE` statement is issued on a slave server, the slave creates an *I/O thread*, which connects to the master and asks it to send the updates recorded in its binary logs.

The slave I/O thread reads the updates that the master's `Binlog Dump` thread sends (see next item) and copies them to local files — known as *relay logs* - in the slave's data directory.

The state of this thread is shown as `Slave_IO_running` in the output of `SHOW SLAVE STATUS` or as `Slave_running` in the output of `SHOW STATUS`.

- Binlog dump thread.** The master creates a thread to send the binary log contents to the slave. This thread can be identified in the output of `SHOW PROCESSLIST` on the master as the `Binlog Dump` thread.

The binlog dump thread acquires a lock on the master's binary log for reading each event that is to be sent to the slave. As soon as the event has been read, the lock is released, even before the event is sent to the slave.

- Slave SQL thread.** The slave creates this thread to read the relay logs that were written by the slave I/O thread. The *slave SQL thread* is also used to execute the updates contained in the relay logs.

#### MySQL Enterprise

For constant monitoring of the status of slaves subscribe to the MySQL Enterprise Monitor. For more information, see <http://www.mysql.com/products/enterprise/advisors.html>.

In the preceding description, there are three threads per master/slave connection. A master that has multiple slaves creates one binlog dump thread for each currently-connected slave, and each slave has its own I/O and SQL threads.

The slave uses two threads so that reading updates from the master and executing them can be separated into two independent tasks. Thus, the task of reading statements is not slowed down if statement execution is slow. For example, if the slave server has not been running for a while, its I/O thread can quickly fetch all the binary log contents from the master when the slave starts, even if the SQL thread lags far behind. If the slave stops before the SQL thread has executed all the fetched statements, the I/O thread has at least fetched everything so that a safe copy of the statements is stored locally in the slave's relay logs, ready for execution the next time that the slave starts. This enables the master server to purge its binary logs sooner because it no longer needs to wait for the slave to fetch their contents.

The `SHOW PROCESSLIST` statement provides information that tells you what is happening on the master and on the slave regarding replication. See [Section 7.5.6, “Examining Thread Information”](#), for descriptions of all replicated-related states.

The following example illustrates how the three threads show up in the output from `SHOW PROCESSLIST`.

On the master server, the output from `SHOW PROCESSLIST` looks like this:

```
mysql> SHOW PROCESSLIST\G
***** 1. row *****
  Id: 2
  User: root
  Host: localhost:32931
  db: NULL
Command: Binlog Dump
  Time: 94
  State: Has sent all binlog to slave; waiting for binlog to
        be updated
  Info: NULL
```

Here, thread 2 is a `Binlog Dump` replication thread for a connected slave. The `State` information indicates that all outstanding updates have been sent to the slave and that the master is waiting for more updates to occur. If you see no `Binlog Dump` threads on a master server, this means that replication is not running — that is, that no slaves are currently connected.

On the slave server, the output from `SHOW PROCESSLIST` looks like this:

```
mysql> SHOW PROCESSLIST\G
***** 1. row *****
  Id: 10
  User: system user
  Host:
  db: NULL
Command: Connect
  Time: 11
  State: Waiting for master to send event
  Info: NULL
***** 2. row *****
  Id: 11
  User: system user
  Host:
  db: NULL
Command: Connect
  Time: 11
  State: Has read all relay log; waiting for the slave I/O
        thread to update it
  Info: NULL
```

This information indicates that thread 10 is the I/O thread that is communicating with the master server, and thread 11 is the SQL thread that is processing the updates stored in the relay logs. At the time that the `SHOW PROCESSLIST` was run, both threads were idle, waiting for further updates.

The value in the `Time` column can show how late the slave is compared to the master. See [Section 16.3.4, “Replication FAQ”](#). The amount of time that the slave lags behind the master that is required before the master determines that the slave is no longer connected — as with any other client connection — is dependent on the values of `net_write_timeout` and `net_retry_count`; for more information about these, see [Section 5.1.3, “Server System Variables”](#).

## 16.4.2. Replication Relay and Status Files

During replication the MySQL server creates a number of files that are used to hold the relayed binary log from the master, and record information about the current status and location within the relayed log. There are three file types used in the process:

- The *relay log* consists of the events read from the binary log of the master. Events in this binary log are executed on the slave as part of the replication thread.
- The *master.info* file contains the status and current configuration information for the slave's connectivity to the master. The file holds information on the master host name, login credentials, and the current position within the master's binary log.
- The *relay-log.info* file holds the status information about the execution point within the slave's relay log files.



The relationship between the three files and the replication process is as follows. The `master.info` file retains the point within the master binary log that has been read from the master. These read events are written to the relay log. The `relay-log.info` file records the position within the relay log of the statements that have been executed.

### 16.4.2.1. The Slave Relay Log

By default, relay log file names have the form `host_name-relay-bin.nnnnnn`, where `host_name` is the name of the slave server host and `nnnnnn` is a sequence number. Successive relay log files are created using successive sequence numbers, beginning with `000001`. The slave uses an index file to track the relay log files currently in use. The default relay log index file name is `host_name-relay-bin.index`. By default, the slave server creates relay log files in its data directory.

The default file names for relay logs and relay log index files can be overridden with, respectively, the `--relay-log` and `--relay-log-index` server options (see [Section 16.1.3, “Replication and Binary Logging Options and Variables”](#)). For this reason, changing a replication slave's host name can cause replication to fail with the errors `FAILED TO OPEN THE RELAY LOG` and `COULD NOT FIND TARGET LOG DURING RELAY LOG INITIALIZATION`. This is a known issue which we intend to fix in a future MySQL release (see [Bug#2122](#)). If you anticipate that a slave's host name may change in the future (for example, if networking is set up on the slave such that its host name can be modified via DHCP), then you can use these options to prevent this problem from occurring. However, if you encounter this issue, one way to work around it is to stop the slave server, prepend the contents of the old relay log index file to the new one, then restart the slave. On a Unix system, this can be done as shown here, where `new_host_name` is the new host name and `old_host_name` is the old one:

```
shell> cat new_host_name-relay-bin.index >> old_host_name-relay-bin.index
shell> mv old_host_name-relay-bin.index new_host_name-relay-bin.index
```

Relay logs have the same format as binary logs and can be read using `mysqlbinlog`. The SQL thread automatically deletes each relay log file as soon as it has executed all events in the file and no longer needs it. There is no explicit mechanism for deleting relay logs because the SQL thread takes care of doing so. However, `FLUSH LOGS` rotates relay logs, which influences when the SQL thread deletes them.

A slave server creates a new relay log file under the following conditions:

- Each time the I/O thread starts.
- When the logs are flushed; for example, with `FLUSH LOGS` or `mysqladmin flush-logs`.
- When the size of the current relay log file becomes too large. The meaning of “too large” is determined as follows:
  - If the value of `max_relay_log_size` is greater than 0, that is the maximum relay log file size.
  - If the value of `max_relay_log_size` is 0, `max_binlog_size` determines the maximum relay log file size.

### 16.4.2.2. The Slave Status Files

A slave replication server creates two small files in the data directory. These *status files* are named `master.info` and `relay-log.info` by default. Their names can be changed by using the `--master-info-file` and `--relay-log-info-file` options. See [Section 16.1.3, “Replication and Binary Logging Options and Variables”](#).

The two status files contain information like that shown in the output of the `SHOW SLAVE STATUS` statement, which is discussed in [Section 12.6.2, “SQL Statements for Controlling Slave Servers”](#). Because the status files are stored on disk, they survive a slave server's shutdown. The next time the slave starts up, it reads the two files to determine how far it has proceeded in reading binary logs from the master and in processing its own relay logs.

The I/O thread updates the `master.info` file. The following table shows the correspondence between the lines in the file and the columns displayed by `SHOW SLAVE STATUS`.

Line	Status Column	Description
1		Number of lines in the file
2	<code>Master_Log_File</code>	The name of the master binary log currently being read from the master.
3	<code>Read_Master_Log_Pos</code>	The current position within the master binary log that have been read from the master.
4	<code>Master_Host</code>	The host name of the master.
5	<code>Master_User</code>	The user name used to connect to the master.
6	Password (not shown by <code>SHOW SLAVE</code> )	The password used to connect to the master.

	STATUS)	
7	<code>Master_Port</code>	The network port used to connect to the master.
8	<code>Connect_Retry</code>	The period (in seconds) that the slave will wait before trying to reconnect to the master.
9	<code>Master_SSL_Allowed</code>	Indicates whether the server supports SSL connections.
10	<code>Master_SSL_CA_File</code>	The file used for the Certificate Authority (CA) certificate.
11	<code>Master_SSL_CA_Path</code>	The path to the Certificate Authority (CA) certificates.
12	<code>Master_SSL_Cert</code>	The name of the SSL certificate file.
13	<code>Master_SSL_Cipher</code>	The name of the cipher in use for the SSL connection.
14	<code>Master_SSL_Key</code>	The name of the SSL key file.
15	<code>Master_SSL_Verify_Server_Cert</code>	Whether to verify the server certificate.

`Master_SSL_Verify_Server_Cert` is present in `master.info` as of MySQL 5.1.18. It is used as described for the `--ssl-verify-server-cert` option in [Section 5.5.7.3, “SSL Command Options”](#).

The SQL thread updates the `relay-log.info` file. The following table shows the correspondence between the lines in the file and the columns displayed by `SHOW SLAVE STATUS`.

Line	Status Column	Description
1	<code>Relay_Log_File</code>	The name of the current relay log file.
2	<code>Relay_Log_Pos</code>	The current position within the relay log file. Events up to this position have been executed on the slave database.
3	<code>Relay_Master_Log_File</code>	The name of the master binary log file from which the events in the relay log file were read.
4	<code>Exec_Master_Log_Pos</code>	The equivalent position within the master's binary log file of events that have already been executed.

The contents of the `relay-log.info` file and the states shown by the `SHOW SLAVE STATES` command may not match if the `relay-log.info` file has not been flushed to disk. Ideally, you should only view `relay-log.info` on a slave that is offline (i.e. `mysqld` is not running). For a running system, `SHOW SLAVE STATUS` should be used.

### 16.4.3. How Servers Evaluate Replication Rules

If a master server does not write a statement to its binary log, the statement is not replicated. If the server does log the statement, the statement is sent to all slaves and each slave determines whether to execute it or ignore it.

On the master you can control which databases write events to the binary log using the `--binlog-do-db` and `--binlog-ignore-db` options to control binary logging. For a description of the rules that servers use in evaluating these options, see [Section 5.2.4, “The Binary Log”](#). You should not use these options to control the databases and tables that are replicated, instead, use filtering on the slave to control the events that are executed on the slave.

On the slave side, decisions about whether to execute or ignore statements received from the master are made according to the `--replicate-*` options that the slave was started with. (See [Section 16.1.3, “Replication and Binary Logging Options and Variables”](#).) The slave evaluates these options using the following procedure, which first checks the database-level options and then the table-level options.

In the simplest case, when there are no `--replicate-*` options, the procedure yields the result that the slave executes all statements that it receives from the master. Otherwise, the result depends on the particular options given. In general, to make it easier to determine what effect an option set will have, it is recommended that you avoid mixing “do” and “ignore” options, or wildcard and non-wildcard options.

#### Stage 1. Check the database options.

At this stage, the slave checks whether there are any `--replicate-do-db` or `--replicate-ignore-db` options that specify database-specific conditions:

- *No*: Permit the statement and proceed to the table-checking stage.
- *Yes*: Test the options using the same rules as for the `--binlog-do-db` and `--binlog-ignore-db` options to determine whether to permit or ignore the statement. What is the result of the test?

- *Permit*: Do not execute the statement immediately. Defer the decision and proceed to the table-checking stage.
- *Ignore*: Ignore the statement and exit.

This stage can permit a statement for further option-checking, or cause it to be ignored. However, statements that are permitted at this stage are not actually executed yet. Instead, they pass to the following stage that checks the table options.

## Stage 2. Check the table options.

First, as a preliminary condition, the slave checks whether statement-based replication is enabled. If so and the statement occurs within a stored function, execute the statement and exit. (If row-based replication is enabled, the slave does not know whether a statement occurred within a stored function on the master, so this condition does not apply.)

Next, the slave checks for table options and evaluates them. If the server reaches this point, it executes all statements if there are no table options. If there are “do” table options, the statement must match one of them if it is to be executed; otherwise, it is ignored. If there are any “ignore” options, all statements are executed except those that match any “ignore” option. The following steps describe how this evaluation occurs in more detail.

### 1. Are there any `--replicate-*-table` options?

- *No*: There are no table restrictions, so all statements match. Execute the statement and exit.
- *Yes*: There are table restrictions. Evaluate the tables to be updated against them. There might be multiple tables to update, so loop through the following steps for each table looking for a matching option. In this case, the behavior depends on whether statement-based replication or row-based replication is enabled:
  - *Statement-based replication*: Proceed to the next step and begin evaluating the table options in the order shown (first the non-wild options, and then the wild options). Only tables that are to be updated are compared to the options. For example, if the statement is `INSERT INTO sales SELECT * FROM prices`, only `sales` is compared to the options). If several tables are to be updated (multiple-table statement), the first table that matches “do” or “ignore” wins. That is, the server checks the first table against the options. If no decision could be made, it checks the second table against the options, and so on.
  - *Row-based replication*: All table row changes are filtered individually. For multiple-table updates, each table is filtered separately according to the options. Some updates may be executed and some not, depending on the options and the changes to be made. Row-based replication correctly handles cases that would not replicate correctly with statement-based replication, as in this example which assumes that tables in the `foo` database should be replicated:

```
mysql> USE bar;
mysql> INSERT INTO foo.sometable VALUES (1);
```

### 2. Are there any `--replicate-do-table` options?

- *No*: Proceed to the next step.
- *Yes*: Does the table match any of them?
  - *No*: Proceed to the next step.
  - *Yes*: Execute the statement and exit.

### 3. Are there any `--replicate-ignore-table` options?

- *No*: Proceed to the next step.
- *Yes*: Does the table match any of them?
  - *No*: Proceed to the next step.
  - *Yes*: Ignore the statement and exit.

### 4. Are there any `--replicate-wild-do-table` options?

- *No*: Proceed to the next step.
- *Yes*: Does the table match any of them?
  - *No*: Proceed to the next step.

- *Yes*: Execute the statement and exit.
5. Are there any `--replicate-wild-ignore-table` options?
- *No*: Proceed to the next step.
  - *Yes*: Does the table match any of them?
    - *No*: Proceed to the next step.
    - *Yes*: Ignore the statement and exit.
6. No `--replicate-*-table` option was matched. Is there another table to test against these options?
- *No*: We have now tested all tables to be updated and could not match any option. Are there `--replicate-do-table` or `--replicate-wild-do-table` options?
    - *No*: There were no “do” table options, so no explicit “do” match is required. Execute the statement and exit.
    - *Yes*: There were “do” table options, so the statement is executed only with an explicit match to one of them. Ignore the statement and exit.
  - *Yes*: Loop.

Examples:

- No `--replicate-*` options at all  
The slave executes all statements that it receives from the master.
- `--replicate-*-db` options, but no table options  
The slave permits or ignores statements using the database options. Then it executes all statements permitted by those options because there are no table restrictions.
- `--replicate-*-table` options, but no database options  
All statements are permitted at the database-checking stage because there are no database conditions. The slave executes or ignores statements based on the table options.
- A mix of database and table options  
The slave permits or ignores statements using the database options. Then it evaluates all statements permitted by those options according to the table options. In some cases, this process can yield what might seem a counterintuitive result. Consider the following set of options:

```
[mysqld]
replicate-do-db      = db1
replicate-do-table  = db2.mytbl2
```

Suppose that `db1` is the default database and the slave receives this statement:

```
INSERT INTO mytbl1 VALUES(1,2,3);
```

The database is `db1`, which matches the `--replicate-do-db` option at the database-checking stage. The algorithm then proceeds to the table-checking stage. If there were no table options, the statement would be executed. However, because the options include a “do” table option, the statement must match if it is to be executed. The statement does not match, so it is ignored. (The same would happen for any table in `db1`.)

# Chapter 17. Partitioning

This chapter discusses MySQL's implementation of *user-defined partitioning*. You can determine whether your MySQL Server supports partitioning by means of a `SHOW VARIABLES` command such as this one:

```
mysql> SHOW VARIABLES LIKE '%partition%';
+-----+-----+
| Variable_name | Value |
+-----+-----+
| have_partitioning | YES |
+-----+-----+
1 row in set (0.00 sec)
```

## Note

Prior to MySQL 5.1.6, this variable was named `have_partition_engine`. (Bug#16718)

You can also check the output of the `SHOW PLUGINS` statement, as shown here:

```
mysql> SHOW PLUGINS;
+-----+-----+-----+-----+-----+
| Name      | Status | Type          | Library | License |
+-----+-----+-----+-----+-----+
| binlog    | ACTIVE | STORAGE ENGINE | NULL    | GPL     |
| partition | ACTIVE | STORAGE ENGINE | NULL   | GPL   |
| ARCHIVE   | ACTIVE | STORAGE ENGINE | NULL    | GPL     |
| BLACKHOLE | ACTIVE | STORAGE ENGINE | NULL    | GPL     |
| CSV       | ACTIVE | STORAGE ENGINE | NULL    | GPL     |
| FEDERATED | DISABLED | STORAGE ENGINE | NULL    | GPL     |
| MEMORY    | ACTIVE | STORAGE ENGINE | NULL    | GPL     |
| InnoDB    | ACTIVE | STORAGE ENGINE | NULL    | GPL     |
| MRG_MYISAM | ACTIVE | STORAGE ENGINE | NULL    | GPL     |
| MyISAM    | ACTIVE | STORAGE ENGINE | NULL    | GPL     |
| ndbcluster | DISABLED | STORAGE ENGINE | NULL    | GPL     |
+-----+-----+-----+-----+-----+
11 rows in set (0.00 sec)
```

If you do not see the `have_partitioning` variable with the value `YES` listed in the output of an appropriate `SHOW VARIABLES` statement, or if you do not see the `partition` plugin listed with the value `ACTIVE` for the `Status` column in the output of `SHOW PLUGINS` (show in bold text in the example just given), then your version of MySQL does not support partitioning.

MySQL Community binaries provided by Sun Microsystems include partitioning support. For information about partitioning support offered in commercial MySQL Server binaries, see *MySQL Enterprise Server 5.1*, on the MySQL website.

If you are compiling MySQL 5.1 from source, the build must be configured using `--with-partition` to enable partitioning.

If your MySQL binary is built with partitioning support, nothing further needs to be done in order to enable it (for example, no special entries are required in your `my.cnf` file).

An introduction to partitioning and partitioning concepts may be found in [Section 17.1, "Overview of Partitioning in MySQL"](#).

MySQL supports several types of partitioning, which are discussed in [Section 17.2, "Partition Types"](#), as well as subpartitioning, which is described in [Section 17.2.5, "Subpartitioning"](#).

Methods of adding, removing, and altering partitions in existing partitioned tables are covered in [Section 17.3, "Partition Management"](#).

Table maintenance commands for use with partitioned tables are discussed in [Section 17.3.3, "Maintenance of Partitions"](#).

Beginning with MySQL 5.1.6, the `PARTITIONS` table in the `INFORMATION_SCHEMA` database provides information about partitions and partitioned tables. See [Section 19.19, "The INFORMATION\\_SCHEMA PARTITIONS Table"](#), for more information; for some examples of queries against this table, see [Section 17.2.6, "How MySQL Partitioning Handles NULL"](#).

## Important

Partitioned tables created with MySQL versions prior to 5.1.6 cannot be read by a 5.1.6 or later MySQL Server. In addition, the `INFORMATION_SCHEMA.TABLES` table cannot be used if such tables are present on a 5.1.6 server. Beginning with MySQL 5.1.7, a suitable warning message is generated instead, to alert the user that incompatible partitioned tables have been found by the server.

If you are using partitioned tables which were created in MySQL 5.1.5 or earlier, be sure to see [Section C.2.32, "Changes in MySQL 5.1.6 \(01 February 2006\)"](#) for more information and suggested workarounds *before* upgrading to MySQL 5.1.6 or later.

The partitioning implementation in MySQL 5.1 is still undergoing development. For known issues with MySQL partitioning, see [Section 17.5, “Restrictions and Limitations on Partitioning”](#), where we have noted these.

You may also find the following resources to be useful when working with partitioned tables.

**Additional Resources.** Other sources of information about user-defined partitioning in MySQL include the following:

- [MySQL Partitioning Forum](#)

This is the official discussion forum for those interested in or experimenting with MySQL Partitioning technology. It features announcements and updates from MySQL developers and others. It is monitored by members of the Partitioning Development and Documentation Teams.

- [Mikael Ronström's Blog](#)

MySQL Partitioning Architect and Lead Developer Mikael Ronström frequently posts articles here concerning his work with MySQL Partitioning and MySQL Cluster.

- [PlanetMySQL](#)

A MySQL news site featuring MySQL-related blogs, which should be of interest to anyone using my MySQL. We encourage you to check here for links to blogs kept by those working with MySQL Partitioning, or to have your own blog added to those covered.

MySQL 5.1 binaries are available from <http://dev.mysql.com/downloads/mysql/5.1.html>. However, for the latest partitioning bug-fixes and feature additions, you can obtain the source from our Bazaar repository. To enable partitioning, you need to compile the server using the `--with-partition` option. For more information about building MySQL, see [Section 2.10, “MySQL Installation Using a Source Distribution”](#). If you have problems compiling a partitioning-enabled MySQL 5.1 build, check the [MySQL Partitioning Forum](#) and ask for assistance there if you do not find a solution to your problem already posted.

## 17.1. Overview of Partitioning in MySQL

This section provides a conceptual overview of partitioning in MySQL 5.1.

For information on partitioning restrictions and feature limitations, see [Section 17.5, “Restrictions and Limitations on Partitioning”](#).

The SQL standard does not provide much in the way of guidance regarding the physical aspects of data storage. The SQL language itself is intended to work independently of any data structures or media underlying the schemas, tables, rows, or columns with which it works. Nonetheless, most advanced database management systems have evolved some means of determining the physical location to be used for storing specific pieces of data in terms of the file system, hardware or even both. In MySQL, the [InnoDB](#) storage engine has long supported the notion of a tablespace, and the MySQL Server, even prior to the introduction of partitioning, could be configured to employ different physical directories for storing different databases (see [Section 7.6.1, “Using Symbolic Links”](#), for an explanation of how this is done).

*Partitioning* takes this notion a step further, by allowing you to distribute portions of individual tables across a file system according to rules which you can set largely as needed. In effect, different portions of a table are stored as separate tables in different locations. The user-selected rule by which the division of data is accomplished is known as a *partitioning function*, which in MySQL can be the modulus, simple matching against a set of ranges or value lists, an internal hashing function, or a linear hashing function. The function is selected according to the partitioning type specified by the user, and takes as its parameter the value of a user-supplied expression. This expression can be either an integer column value, or a function acting on one or more column values and returning an integer. The value of this expression is passed to the partitioning function, which returns an integer value representing the number of the partition in which that particular record should be stored. This function must be non-constant and non-random. It may not contain any queries, but may use an SQL expression that is valid in MySQL, as long as that expression returns either `NULL` or an integer *intval* such that

```
-MAXVALUE <= intval <= MAXVALUE
```

(`MAXVALUE` is used to represent the least upper bound for the type of integer in question. `-MAXVALUE` represents the greatest lower bound.) There are some additional restrictions on partitioning functions; see [Section 17.5, “Restrictions and Limitations on Partitioning”](#), for more information about these.

Examples of partitioning functions can be found in the discussions of partitioning types later in this chapter (see [Section 17.2, “Partition Types”](#)), as well as in the partitioning syntax descriptions given in [Section 12.1.17, “CREATE TABLE Syntax”](#).

This is known as *horizontal partitioning* — that is, different rows of a table may be assigned to different physical partitions. MySQL 5.1 does not support *vertical partitioning*, in which different columns of a table are assigned to different physical partitions. There are not at this time any plans to introduce vertical partitioning into MySQL 5.1.

For information about determining whether your MySQL Server binary supports user-defined partitioning, see [Chapter 17, Parti-](#)

tioning.

For creating partitioned tables, you can use most storage engines that are supported by your MySQL server; the MySQL partitioning engine runs in a separate layer and can interact with any of these. In MySQL 5.1, all partitions of the same partitioned table must use the same storage engine; for example, you cannot use [MyISAM](#) for one partition and [InnoDB](#) for another. However, there is nothing preventing you from using different storage engines for different partitioned tables on the same MySQL server or even in the same database.

### Note

MySQL partitioning cannot be used with the [MERGE](#) or [CSV](#) storage engines. Beginning with MySQL 5.1.15, [FEDERATED](#) tables also cannot be partitioned ([Bug#22451](#)). Prior to MySQL 5.1.6, it was also not feasible to create a partitioned table using the [BLACKHOLE](#) storage engine ([Bug#14524](#)).

Partitioning by [KEY](#) or [LINEAR KEY](#) is possible with [NDBCLUSTER](#), but other types of user-defined partitioning are not supported for tables using this storage engine. In addition, an [NDBCLUSTER](#) table that employs user-defined partitioning must have an explicit primary key, and any columns referenced in the table's partitioning expression must be part of the primary key. However, if no columns are listed in the [PARTITION BY KEY](#) or [PARTITION BY LINEAR KEY](#) clause of the [CREATE TABLE](#) or [ALTER TABLE](#) statement used to create or modify a user-partitioned [NDBCLUSTER](#) table, then the table is not required to have an explicit primary key.

For more information, see [Section 17.5.2, “Partitioning Limitations Relating to Storage Engines”](#), and [Non-Compliance with SQL Syntax in MySQL Cluster](#).

To employ a particular storage engine for a partitioned table, it is necessary only to use the [\[STORAGE\] ENGINE](#) option just as you would for a non-partitioned table. However, you should keep in mind that [\[STORAGE\] ENGINE](#) (and other table options) need to be listed *before* any partitioning options are used in a [CREATE TABLE](#) statement. This example shows how to create a table that is partitioned by hash into 6 partitions and which uses the [InnoDB](#) storage engine:

```
CREATE TABLE ti (id INT, amount DECIMAL(7,2), tr_date DATE)
ENGINE=INNODB
PARTITION BY HASH( MONTH(tr_date) )
PARTITIONS 6;
```

### Note

Each [PARTITION](#) clause can include a [\[STORAGE\] ENGINE](#) option, but in MySQL 5.1 this has no effect.

### Important

Partitioning applies to all data and indexes of a table; you cannot partition only the data and not the indexes, or *vice versa*, nor can you partition only a portion of the table.

Data and indexes for each partition can be assigned to a specific directory using the [DATA DIRECTORY](#) and [INDEX DIRECTORY](#) options for the [PARTITION](#) clause of the [CREATE TABLE](#) statement used to create the partitioned table.

### Note

Prior to MySQL 5.1.18, these options were permitted even when the [NO\\_DIR\\_IN\\_CREATE](#) server SQL mode was in effect. ([Bug#24633](#))

The [DATA DIRECTORY](#) and [INDEX DIRECTORY](#) options have no effect when defining partitions for tables using the [InnoDB](#) storage engine.

[DATA DIRECTORY](#) and [INDEX DIRECTORY](#) are not supported for individual partitions or subpartitions on Windows. Beginning with MySQL 5.1.24, these options are ignored on Windows, except that a warning is generated. ([Bug#30459](#))

In addition, [MAX\\_ROWS](#) and [MIN\\_ROWS](#) can be used to determine the maximum and minimum numbers of rows, respectively, that can be stored in each partition. See [Section 17.3, “Partition Management”](#), for more information on these options.

Some of the advantages of partitioning include:

- Being able to store more data in one table than can be held on a single disk or file system partition.
- Data that loses its usefulness can often be easily removed from the table by dropping the partition containing only that data. Conversely, the process of adding new data can in some cases be greatly facilitated by adding a new partition specifically for that data.
- Some queries can be greatly optimized in virtue of the fact that data satisfying a given [WHERE](#) clause can be stored only on one or more partitions, thereby excluding any remaining partitions from the search. Because partitions can be altered after a parti-



tioned table has been created, you can reorganize your data to enhance frequent queries that may not have been so when the partitioning scheme was first set up. This capability, sometimes referred to as *partition pruning*, was implemented in MySQL 5.1.6. For more information, see [Section 17.4, “Partition Pruning”](#).

Other benefits usually associated with partitioning include those in the following list. These features are not currently implemented in MySQL Partitioning, but are high on our list of priorities.

- Queries involving aggregate functions such as `SUM()` and `COUNT()` can easily be parallelized. A simple example of such a query might be `SELECT salesperson_id, COUNT(orders) as order_total FROM sales GROUP BY salesperson_id;` By “parallelized,” we mean that the query can be run simultaneously on each partition, and the final result obtained merely by summing the results obtained for all partitions.
- Achieving greater query throughput in virtue of spreading data seeks over multiple disks.

Be sure to check this section and chapter frequently for updates as Partitioning development continues.

## 17.2. Partition Types

This section discusses the types of partitioning which are available in MySQL 5.1. These include:

- **RANGE partitioning:** Assigns rows to partitions based on column values falling within a given range. See [Section 17.2.1, “RANGE Partitioning”](#).
- **LIST partitioning:** Similar to partitioning by range, except that the partition is selected based on columns matching one of a set of discrete values. See [Section 17.2.2, “LIST Partitioning”](#).
- **HASH partitioning:** A partition is selected based on the value returned by a user-defined expression that operates on column values in rows to be inserted into the table. The function may consist of any expression valid in MySQL that yields a non-negative integer value. See [Section 17.2.3, “HASH Partitioning”](#).
- **KEY partitioning:** Similar to partitioning by hash, except that only one or more columns to be evaluated are supplied, and the MySQL server provides its own hashing function. These columns can contain other than integer values, since the hashing function supplied by MySQL guarantees an integer result regardless of the column data type. See [Section 17.2.4, “KEY Partitioning”](#).

A very common use of database partitioning is to segregate data by date. Some database systems support explicit date partitioning, which MySQL does not implement in 5.1. However, it is not difficult in MySQL to create partitioning schemes based on `DATE`, `TIME`, or `DATETIME` columns, or based on expressions making use of such columns.

When partitioning by `KEY` or `LINEAR KEY`, you can use a `DATE`, `TIME`, or `DATETIME` column as the partitioning column without performing any modification of the column value. For example, this table creation statement is perfectly valid in MySQL:

```
CREATE TABLE members (
  firstname VARCHAR(25) NOT NULL,
  lastname VARCHAR(25) NOT NULL,
  username VARCHAR(16) NOT NULL,
  email VARCHAR(35),
  joined DATE NOT NULL
)
PARTITION BY KEY(joined)
PARTITIONS 6;
```

MySQL's other partitioning types, however, require a partitioning expression that yields an integer value or `NULL`. If you wish to use date-based partitioning by `RANGE`, `LIST`, `HASH`, or `LINEAR HASH`, you can simply employ a function that operates on a `DATE`, `TIME`, or `DATETIME` column and returns such a value, as shown here:

```
CREATE TABLE members (
  firstname VARCHAR(25) NOT NULL,
  lastname VARCHAR(25) NOT NULL,
  username VARCHAR(16) NOT NULL,
  email VARCHAR(35),
  joined DATE NOT NULL
)
PARTITION BY RANGE( YEAR(joined) ) (
  PARTITION p0 VALUES LESS THAN (1960),
  PARTITION p1 VALUES LESS THAN (1970),
  PARTITION p2 VALUES LESS THAN (1980),
  PARTITION p3 VALUES LESS THAN (1990),
  PARTITION p4 VALUES LESS THAN MAXVALUE
);
```



Additional examples of partitioning using dates may be found here:

- [Section 17.2.1, “RANGE Partitioning”](#)
- [Section 17.2.3, “HASH Partitioning”](#)
- [Section 17.2.3.1, “LINEAR HASH Partitioning”](#)

For more complex examples of date-based partitioning, see:

- [Section 17.4, “Partition Pruning”](#)
- [Section 17.2.5, “Subpartitioning”](#)

MySQL partitioning is optimized for use with the `TO_DAYS()` and `YEAR()` functions. However, you can use other date and time functions that return an integer or `NULL`, such as `WEEKDAY()`, `DAYOFYEAR()`, or `MONTH()`. See [Section 11.6, “Date and Time Functions”](#), for more information about such functions.

It is important to remember — regardless of the type of partitioning that you use — that partitions are always numbered automatically and in sequence when created, starting with 0. When a new row is inserted into a partitioned table, it is these partition numbers that are used in identifying the correct partition. For example, if your table uses 4 partitions, these partitions are numbered 0, 1, 2, and 3. For the `RANGE` and `LIST` partitioning types, it is necessary to ensure that there is a partition defined for each partition number. For `HASH` partitioning, the user function employed must return an integer value greater than 0. For `KEY` partitioning, this issue is taken care of automatically by the hashing function which the MySQL server employs internally.

Names of partitions generally follow the rules governing other MySQL identifiers, such as those for tables and databases. However, you should note that partition names are not case-sensitive. For example, the following `CREATE TABLE` statement fails as shown:

```
mysql> CREATE TABLE t2 (val INT)
-> PARTITION BY LIST(val)(
->     PARTITION mypart VALUES IN (1,3,5),
->     PARTITION MyPart VALUES IN (2,4,6)
-> );
ERROR 1488 (HY000): Duplicate partition name mypart
```

Failure occurs because MySQL sees no difference between the partition names `mypart` and `MyPart`.

When you specify the number of partitions for the table, this must be expressed as a positive, nonzero integer literal with no leading zeroes, and may not be an expression such as `0.8E+01` or `6-2`, even if it evaluates to an integer value. (Beginning with MySQL 5.1.12, decimal fractions are no longer truncated, but instead are disallowed entirely.)

In the sections that follow, we do not necessarily provide all possible forms for the syntax that can be used for creating each partition type; this information may be found in [Section 12.1.17, “CREATE TABLE Syntax”](#).

## 17.2.1. RANGE Partitioning

A table that is partitioned by range is partitioned in such a way that each partition contains rows for which the partitioning expression value lies within a given range. Ranges should be contiguous but not overlapping, and are defined using the `VALUES LESS THAN` operator. For the next few examples, suppose that you are creating a table such as the following to hold personnel records for a chain of 20 video stores, numbered 1 through 20:

```
CREATE TABLE employees (
  id INT NOT NULL,
  fname VARCHAR(30),
  lname VARCHAR(30),
  hired DATE NOT NULL DEFAULT '1970-01-01',
  separated DATE NOT NULL DEFAULT '9999-12-31',
  job_code INT NOT NULL,
  store_id INT NOT NULL
);
```

This table can be partitioned by range in a number of ways, depending on your needs. One way would be to use the `store_id` column. For instance, you might decide to partition the table 4 ways by adding a `PARTITION BY RANGE` clause as shown here:

```
CREATE TABLE employees (
  id INT NOT NULL,
  fname VARCHAR(30),
  lname VARCHAR(30),
  hired DATE NOT NULL DEFAULT '1970-01-01',
  separated DATE NOT NULL DEFAULT '9999-12-31',
  job_code INT NOT NULL,
  store_id INT NOT NULL
```

```

)
PARTITION BY RANGE (store_id) (
  PARTITION p0 VALUES LESS THAN (6),
  PARTITION p1 VALUES LESS THAN (11),
  PARTITION p2 VALUES LESS THAN (16),
  PARTITION p3 VALUES LESS THAN (21)
);

```

In this partitioning scheme, all rows corresponding to employees working at stores 1 through 5 are stored in partition `p0`, to those employed at stores 6 through 10 are stored in partition `p1`, and so on. Note that each partition is defined in order, from lowest to highest. This is a requirement of the `PARTITION BY RANGE` syntax; you can think of it as being analogous to a series of `if ... elseif ...` statements in C or Java in this regard.

It is easy to determine that a new row containing the data (72, 'Michael', 'Widenius', '1998-06-25', NULL, 13) is inserted into partition `p2`, but what happens when your chain adds a 21<sup>st</sup> store? Under this scheme, there is no rule that covers a row whose `store_id` is greater than 20, so an error results because the server does not know where to place it. You can keep this from occurring by using a “catchall” `VALUES LESS THAN` clause in the `CREATE TABLE` statement that provides for all values greater than highest value explicitly named:

```

CREATE TABLE employees (
  id INT NOT NULL,
  fname VARCHAR(30),
  lname VARCHAR(30),
  hired DATE NOT NULL DEFAULT '1970-01-01',
  separated DATE NOT NULL DEFAULT '9999-12-31',
  job_code INT NOT NULL,
  store_id INT NOT NULL
)
PARTITION BY RANGE (store_id) (
  PARTITION p0 VALUES LESS THAN (6),
  PARTITION p1 VALUES LESS THAN (11),
  PARTITION p2 VALUES LESS THAN (16),
  PARTITION p3 VALUES LESS THAN MAXVALUE
);

```

### Note

Another way to avoid an error when no matching value is found is to use the `IGNORE` keyword as part of the `INSERT` statement. For an example, see [Section 17.2.2, “LIST Partitioning”](#). Also see [Section 12.2.5, “INSERT Syntax”](#), for general information about `IGNORE`.

`MAXVALUE` represents an integer value that is always greater than the largest possible integer value (in mathematical language, it serves as a *least upper bound*). Now, any rows whose `store_id` column value is greater than or equal to 16 (the highest value defined) are stored in partition `p3`. At some point in the future — when the number of stores has increased to 25, 30, or more — you can use an `ALTER TABLE` statement to add new partitions for stores 21-25, 26-30, and so on (see [Section 17.3, “Partition Management”](#), for details of how to do this).

In much the same fashion, you could partition the table based on employee job codes — that is, based on ranges of `job_code` column values. For example — assuming that two-digit job codes are used for regular (in-store) workers, three-digit codes are used for office and support personnel, and four-digit codes are used for management positions — you could create the partitioned table using the following:

```

CREATE TABLE employees (
  id INT NOT NULL,
  fname VARCHAR(30),
  lname VARCHAR(30),
  hired DATE NOT NULL DEFAULT '1970-01-01',
  separated DATE NOT NULL DEFAULT '9999-12-31',
  job_code INT NOT NULL,
  store_id INT NOT NULL
)
PARTITION BY RANGE (job_code) (
  PARTITION p0 VALUES LESS THAN (100),
  PARTITION p1 VALUES LESS THAN (1000),
  PARTITION p2 VALUES LESS THAN (10000)
);

```

In this instance, all rows relating to in-store workers would be stored in partition `p0`, those relating to office and support staff in `p1`, and those relating to managers in partition `p2`.

It is also possible to use an expression in `VALUES LESS THAN` clauses. However, MySQL must be able to evaluate the expression's return value as part of a `LESS THAN (<)` comparison.

Rather than splitting up the table data according to store number, you can use an expression based on one of the two `DATE` columns instead. For example, let us suppose that you wish to partition based on the year that each employee left the company; that is, the value of `YEAR(separated)`. An example of a `CREATE TABLE` statement that implements such a partitioning scheme is shown here:

```
CREATE TABLE employees (
  id INT NOT NULL,
  fname VARCHAR(30),
  lname VARCHAR(30),
  hired DATE NOT NULL DEFAULT '1970-01-01',
  separated DATE NOT NULL DEFAULT '9999-12-31',
  job_code INT,
  store_id INT
)
PARTITION BY RANGE ( YEAR(separated) ) (
  PARTITION p0 VALUES LESS THAN (1991),
  PARTITION p1 VALUES LESS THAN (1996),
  PARTITION p2 VALUES LESS THAN (2001),
  PARTITION p3 VALUES LESS THAN MAXVALUE
);
```

In this scheme, for all employees who left before 1991, the rows are stored in partition `p0`; for those who left in the years 1991 through 1995, in `p1`; for those who left in the years 1996 through 2000, in `p2`; and for any workers who left after the year 2000, in `p3`.

Range partitioning is particularly useful when:

- You want or need to delete “old” data. If you are using the partitioning scheme shown immediately above, you can simply use `ALTER TABLE employees DROP PARTITION p0;` to delete all rows relating to employees who stopped working for the firm prior to 1991. (See [Section 12.1.7, “ALTER TABLE Syntax”](#), and [Section 17.3, “Partition Management”](#), for more information.) For a table with a great many rows, this can be much more efficient than running a `DELETE` query such as `DELETE FROM employees WHERE YEAR(separated) <= 1990;`.
- You want to use a column containing date or time values, or containing values arising from some other series.
- You frequently run queries that depend directly on the column used for partitioning the table. For example, when executing a query such as `EXPLAIN PARTITIONS SELECT COUNT(*) FROM employees WHERE separated BETWEEN '2000-01-01' AND '2000-12-31' GROUP BY store_id;` MySQL can quickly determine that only partition `p2` needs to be scanned because the remaining partitions cannot contain any records satisfying the `WHERE` clause. See [Section 17.4, “Partition Pruning”](#), for more information about how this is accomplished.

## 17.2.2. LIST Partitioning

List partitioning in MySQL is similar to range partitioning in many ways. As in partitioning by [RANGE](#), each partition must be explicitly defined. The chief difference is that, in list partitioning, each partition is defined and selected based on the membership of a column value in one of a set of value lists, rather than in one of a set of contiguous ranges of values. This is done by using `PARTITION BY LIST(expr)` where `expr` is a column value or an expression based on a column value and returning an integer value, and then defining each partition by means of a `VALUES IN (value_list)`, where `value_list` is a comma-separated list of integers.

### Note

In MySQL 5.1, it is possible to match against only a list of integers (and possibly `NULL` — see [Section 17.2.6, “How MySQL Partitioning Handles NULL”](#)) when partitioning by `LIST`.

Unlike the case with partitions defined by range, list partitions do not need to be declared in any particular order. For more detailed syntactical information, see [Section 12.1.17, “CREATE TABLE Syntax”](#).

For the examples that follow, we assume that the basic definition of the table to be partitioned is provided by the `CREATE TABLE` statement shown here:

```
CREATE TABLE employees (
  id INT NOT NULL,
  fname VARCHAR(30),
  lname VARCHAR(30),
  hired DATE NOT NULL DEFAULT '1970-01-01',
  separated DATE NOT NULL DEFAULT '9999-12-31',
  job_code INT,
  store_id INT
);
```

(This is the same table used as a basis for the examples in [Section 17.2.1, “RANGE Partitioning”](#).)

Suppose that there are 20 video stores distributed among 4 franchises as shown in the following table.

Region	Store ID Numbers
North	3, 5, 6, 9, 17

East	1, 2, 10, 11, 19, 20
West	4, 12, 13, 14, 18
Central	7, 8, 15, 16

To partition this table in such a way that rows for stores belonging to the same region are stored in the same partition, you could use the `CREATE TABLE` statement shown here:

```
CREATE TABLE employees (
  id INT NOT NULL,
  fname VARCHAR(30),
  lname VARCHAR(30),
  hired DATE NOT NULL DEFAULT '1970-01-01',
  separated DATE NOT NULL DEFAULT '9999-12-31',
  job_code INT,
  store_id INT
)
PARTITION BY LIST(store_id) (
  PARTITION pNorth VALUES IN (3,5,6,9,17),
  PARTITION pEast VALUES IN (1,2,10,11,19,20),
  PARTITION pWest VALUES IN (4,12,13,14,18),
  PARTITION pCentral VALUES IN (7,8,15,16)
);
```

This makes it easy to add or drop employee records relating to specific regions to or from the table. For instance, suppose that all stores in the West region are sold to another company. All rows relating to employees working at stores in that region can be deleted with the query `ALTER TABLE employees DROP PARTITION pWest;`, which can be executed much more efficiently than the equivalent `DELETE` statement `DELETE FROM employees WHERE store_id IN (4,12,13,14,18);`

As with `RANGE` partitioning, it is possible to combine `LIST` partitioning with partitioning by hash or key to produce a composite partitioning (subpartitioning). See [Section 17.2.5, “Subpartitioning”](#).

Unlike the case with `RANGE` partitioning, there is no “catch-all” such as `MAXVALUE`; all expected values for the partitioning expression should be covered in `PARTITION ... VALUES IN (...)` clauses. An `INSERT` statement containing an unmatched partitioning column value fails with an error, as shown in this example:

```
mysql> CREATE TABLE h2 (
->   c1 INT,
->   c2 INT
-> )
-> PARTITION BY LIST(c1) (
->   PARTITION p0 VALUES IN (1, 4, 7),
->   PARTITION p1 VALUES IN (2, 5, 8)
-> );
Query OK, 0 rows affected (0.11 sec)

mysql> INSERT INTO h2 VALUES (3, 5);
ERROR 1525 (HY000): TABLE HAS NO PARTITION FOR VALUE 3
```

When inserting multiple rows using a single `INSERT` statement, any rows coming before the row containing the unmatched value are inserted, but any coming after it are not:

```
mysql> SELECT * FROM h2;
Empty set (0.00 sec)

mysql> INSERT INTO h2 VALUES (4, 7), (3, 5), (6, 0);
ERROR 1525 (HY000): TABLE HAS NO PARTITION FOR VALUE 3
mysql> SELECT * FROM h2;
+-----+-----+
| c1   | c2   |
+-----+-----+
| 4   | 7   |
+-----+-----+
1 row in set (0.00 sec)
```

You can cause this type of error to be ignored by using the `IGNORE` key word. If you do so, rows containing unmatched partitioning column values are not inserted, but any rows with matching values *are* inserted, and no errors are reported:

```
mysql> TRUNCATE h2;
Query OK, 1 row affected (0.00 sec)

mysql> SELECT * FROM h2;
Empty set (0.00 sec)

mysql> INSERT IGNORE INTO h2 VALUES (2, 5), (6, 10), (7, 5), (3, 1), (1, 9);
Query OK, 3 rows affected (0.00 sec)
Records: 5 Duplicates: 2 Warnings: 0

mysql> SELECT * FROM h2;
+-----+-----+
| c1   | c2   |
+-----+-----+
| 7   | 5   |
| 1   | 9   |
+-----+-----+
```

```
| 2 | 5 |
+---+---+
3 rows in set (0.00 sec)
```

### 17.2.3. HASH Partitioning

Partitioning by `HASH` is used primarily to ensure an even distribution of data among a predetermined number of partitions. With range or list partitioning, you must specify explicitly into which partition a given column value or set of column values is to be stored; with hash partitioning, MySQL takes care of this for you, and you need only specify a column value or expression based on a column value to be hashed and the number of partitions into which the partitioned table is to be divided.

To partition a table using `HASH` partitioning, it is necessary to append to the `CREATE TABLE` statement a `PARTITION BY HASH (expr)` clause, where `expr` is an expression that returns an integer. This can simply be the name of a column whose type is one of MySQL's integer types. In addition, you will most likely want to follow this with a `PARTITIONS num` clause, where `num` is a positive integer representing the number of partitions into which the table is to be divided.

For example, the following statement creates a table that uses hashing on the `store_id` column and is divided into 4 partitions:

```
CREATE TABLE employees (
  id INT NOT NULL,
  fname VARCHAR(30),
  lname VARCHAR(30),
  hired DATE NOT NULL DEFAULT '1970-01-01',
  separated DATE NOT NULL DEFAULT '9999-12-31',
  job_code INT,
  store_id INT
)
PARTITION BY HASH(store_id)
PARTITIONS 4;
```

If you do not include a `PARTITIONS` clause, the number of partitions defaults to 1.

Using the `PARTITIONS` keyword without a number following it results in a syntax error.

You can also use an SQL expression that returns an integer for `expr`. For instance, you might want to partition based on the year in which an employee was hired. This can be done as shown here:

```
CREATE TABLE employees (
  id INT NOT NULL,
  fname VARCHAR(30),
  lname VARCHAR(30),
  hired DATE NOT NULL DEFAULT '1970-01-01',
  separated DATE NOT NULL DEFAULT '9999-12-31',
  job_code INT,
  store_id INT
)
PARTITION BY HASH( YEAR(hired) )
PARTITIONS 4;
```

`expr` must return a non-constant, non-random integer value (in other words, it should be varying but deterministic), and must not contain any prohibited constructs as described in [Section 17.5, “Restrictions and Limitations on Partitioning”](#). You should also keep in mind that this expression is evaluated each time a row is inserted or updated (or possibly deleted); this means that very complex expressions may give rise to performance issues, particularly when performing operations (such as batch inserts) that affect a great many rows at one time.

The most efficient hashing function is one which operates upon a single table column and whose value increases or decreases consistently with the column value, as this allows for “pruning” on ranges of partitions. That is, the more closely that the expression varies with the value of the column on which it is based, the more efficiently MySQL can use the expression for hash partitioning.

For example, where `date_col` is a column of type `DATE`, then the expression `TO_DAYS(date_col)` is said to vary directly with the value of `date_col`, because for every change in the value of `date_col`, the value of the expression changes in a consistent manner. The variance of the expression `YEAR(date_col)` with respect to `date_col` is not quite as direct as that of `TO_DAYS(date_col)`, because not every possible change in `date_col` produces an equivalent change in `YEAR(date_col)`. Even so, `YEAR(date_col)` is a good candidate for a hashing function, because it varies directly with a portion of `date_col` and there is no possible change in `date_col` that produces a disproportionate change in `YEAR(date_col)`.

By way of contrast, suppose that you have a column named `int_col` whose type is `INT`. Now consider the expression `POW(5-int_col,3) + 6`. This would be a poor choice for a hashing function because a change in the value of `int_col` is not guaranteed to produce a proportional change in the value of the expression. Changing the value of `int_col` by a given amount can produce by widely different changes in the value of the expression. For example, changing `int_col` from 5 to 6 produces a change of `-1` in the value of the expression, but changing the value of `int_col` from 6 to 7 produces a change of `-7` in the expression value.

In other words, the more closely the graph of the column value *versus* the value of the expression follows a straight line as traced

by the equation  $y=nx$  where  $n$  is some nonzero constant, the better the expression is suited to hashing. This has to do with the fact that the more nonlinear an expression is, the more uneven the distribution of data among the partitions it tends to produce.

In theory, pruning is also possible for expressions involving more than one column value, but determining which of such expressions are suitable can be quite difficult and time-consuming. For this reason, the use of hashing expressions involving multiple columns is not particularly recommended.

When `PARTITION BY HASH` is used, MySQL determines which partition of  $num$  partitions to use based on the modulus of the result of the user function. In other words, for an expression  $expr$ , the partition in which the record is stored is partition number  $N$ , where  $N = \text{MOD}(expr, num)$ . For example, suppose table `t1` is defined as follows, so that it has 4 partitions:

```
CREATE TABLE t1 (col1 INT, col2 CHAR(5), col3 DATE)
PARTITION BY HASH( YEAR(col3) )
PARTITIONS 4;
```

If you insert a record into `t1` whose `col3` value is `'2005-09-15'`, then the partition in which it is stored is determined as follows:

```
MOD(YEAR('2005-09-01'),4)
= MOD(2005,4)
= 1
```

MySQL 5.1 also supports a variant of `HASH` partitioning known as *linear hashing* which employs a more complex algorithm for determining the placement of new rows inserted into the partitioned table. See [Section 17.2.3.1, “LINEAR HASH Partitioning”](#), for a description of this algorithm.

The user function is evaluated each time a record is inserted or updated. It may also — depending on the circumstances — be evaluated when records are deleted.

### Note

If a table to be partitioned has a `UNIQUE` key, then any columns supplied as arguments to the `HASH` user function or to the `KEY`'s `column_list` must be part of that key.

## 17.2.3.1. LINEAR HASH Partitioning

MySQL also supports linear hashing, which differs from regular hashing in that linear hashing utilizes a linear powers-of-two algorithm whereas regular hashing employs the modulus of the hashing function's value.

Syntactically, the only difference between linear-hash partitioning and regular hashing is the addition of the `LINEAR` keyword in the `PARTITION BY` clause, as shown here:

```
CREATE TABLE employees (
  id INT NOT NULL,
  fname VARCHAR(30),
  lname VARCHAR(30),
  hired DATE NOT NULL DEFAULT '1970-01-01',
  separated DATE NOT NULL DEFAULT '9999-12-31',
  job_code INT,
  store_id INT
)
PARTITION BY LINEAR HASH( YEAR(hired) )
PARTITIONS 4;
```

Given an expression  $expr$ , the partition in which the record is stored when linear hashing is used is partition number  $N$  from among  $num$  partitions, where  $N$  is derived according to the following algorithm:

1. Find the next power of 2 greater than  $num$ . We call this value  $V$ ; it can be calculated as:

```
V = POWER(2, CEILING(LOG(2, num)))
```

(For example, suppose that  $num$  is 13. Then  $\text{LOG}(2, 13)$  is 3.7004397181411.  $\text{CEILING}(3.7004397181411)$  is 4, and  $V = \text{POWER}(2, 4)$ , which is 16.)

2. Set  $N = F(\text{column\_list}) \& (V - 1)$ .
3. While  $N \geq num$ :
  - Set  $V = \text{CEIL}(V / 2)$
  - Set  $N = N \& (V - 1)$

For example, suppose that the table `t1`, using linear hash partitioning and having 6 partitions, is created using this statement:

```
CREATE TABLE t1 (col1 INT, col2 CHAR(5), col3 DATE)
PARTITION BY LINEAR HASH( YEAR(col3) )
PARTITIONS 6;
```

Now assume that you want to insert two records into `t1` having the `col3` column values `'2003-04-14'` and `'1998-10-19'`. The partition number for the first of these is determined as follows:

```
V = POWER(2, CEILING( LOG(2,6) )) = 8
N = YEAR('2003-04-14') & (8 - 1)
  = 2003 & 7
  = 3
(3 >= 6 is FALSE: record stored in partition #3)
```

The number of the partition where the second record is stored is calculated as shown here:

```
V = 8
N = YEAR('1998-10-19') & (8-1)
  = 1998 & 7
  = 6
(6 >= 6 is TRUE: additional step required)
N = 6 & CEILING(8 / 2)
  = 6 & 3
  = 2
(2 >= 6 is FALSE: record stored in partition #2)
```

The advantage in partitioning by linear hash is that the adding, dropping, merging, and splitting of partitions is made much faster, which can be beneficial when dealing with tables containing extremely large amounts (terabytes) of data. The disadvantage is that data is less likely to be evenly distributed between partitions as compared with the distribution obtained using regular hash partitioning.

## 17.2.4. KEY Partitioning

Partitioning by key is similar to partitioning by hash, except that where hash partitioning employs a user-defined expression, the hashing function for key partitioning is supplied by the MySQL server. MySQL Cluster uses `MD5()` for this purpose; for tables using other storage engines, the server employs its own internal hashing function which is based on the same algorithm as `PASS-WORD()`.

The syntax rules for `CREATE TABLE ... PARTITION BY KEY` are similar to those for creating a table that is partitioned by hash. The major differences are that:

- `KEY` is used rather than `HASH`.
- `KEY` takes only a list of one or more column names. Beginning with MySQL 5.1.5, the column or columns used as the partitioning key must comprise part or all of the table's primary key, if the table has one.

Beginning with MySQL 5.1.6, `KEY` takes a list of zero or more column names. Where no column name is specified as the partitioning key, the table's primary key is used, if there is one. For example, the following `CREATE TABLE` statement is valid in MySQL 5.1.6 or later:

```
CREATE TABLE k1 (
  id INT NOT NULL PRIMARY KEY,
  name VARCHAR(20)
)
PARTITION BY KEY()
PARTITIONS 2;
```

If there is no primary key but there is a unique key, then the unique key is used for the partitioning key:

```
CREATE TABLE k1 (
  id INT NOT NULL,
  name VARCHAR(20),
  UNIQUE KEY (id)
)
PARTITION BY KEY()
PARTITIONS 2;
```

However, if the unique key column were not defined as `NOT NULL`, then the previous statement would fail.

In both of these cases, the partitioning key is the `id` column, even though it is not shown in the output of `SHOW CREATE TABLE` or in the `PARTITION_EXPRESSION` column of the `INFORMATION_SCHEMA.PARTITIONS` table.



Unlike the case with other partitioning types, columns used for partitioning by [KEY](#) are not restricted to integer or [NULL](#) values. For example, the following [CREATE TABLE](#) statement is valid:

```
CREATE TABLE tml (
  s1 CHAR(32) PRIMARY KEY
)
PARTITION BY KEY(s1)
PARTITIONS 10;
```

The preceding statement would *not* be valid, were a different partitioning type to be specified.

### Note

In this case, simply using [PARTITION BY KEY\(\)](#) would also be valid and have the same effect as [PARTITION BY KEY\(s1\)](#), since [s1](#) is the table's primary key.

For additional information about this issue, see [Section 17.5, “Restrictions and Limitations on Partitioning”](#).

### Note

Also beginning with MySQL 5.1.6, tables using the [NDBCLUSTER](#) storage engine are implicitly partitioned by [KEY](#), again using the table's primary key as the partitioning key. In the event that the MySQL Cluster table has no explicit primary key, the “hidden” primary key generated by the [NDBCLUSTER](#) storage engine for each MySQL Cluster table is used as the partitioning key.

Beginning with MySQL Cluster NDB 6.2.18, MySQL Cluster NDB 6.3.25, and MySQL Cluster NDB 7.0.6, if you define an explicit partitioning scheme for an [NDBCLUSTER](#) table, the table must have an explicit primary key, and any columns used in the partitioning expression must be part of this key. However, if the table uses an “empty” partitioning expression — that is, [PARTITION BY KEY\(\)](#) with no column references — then no explicit primary key is required.

### Important

For a key-partitioned table using any MySQL storage engine other than [NDBCLUSTER](#), you cannot execute an [ALTER TABLE DROP PRIMARY KEY](#), as doing so generates the error `ERROR 1466 (HY000): FIELD IN LIST OF FIELDS FOR PARTITION FUNCTION NOT FOUND IN TABLE`. This is not an issue for MySQL Cluster tables which are partitioned by [KEY](#); in such cases, the table is reorganized using the “hidden” primary key as the table's new partitioning key. See [MySQL Cluster NDB 6.X/7.X](#).

It is also possible to partition a table by linear key. Here is a simple example:

```
CREATE TABLE tk (
  col1 INT NOT NULL,
  col2 CHAR(5),
  col3 DATE
)
PARTITION BY LINEAR KEY (col1)
PARTITIONS 3;
```

Using [LINEAR](#) has the same effect on [KEY](#) partitioning as it does on [HASH](#) partitioning, with the partition number being derived using a powers-of-two algorithm rather than modulo arithmetic. See [Section 17.2.3.1, “LINEAR HASH Partitioning”](#), for a description of this algorithm and its implications.

## 17.2.5. Subpartitioning

Subpartitioning — also known as *composite partitioning* — is the further division of each partition in a partitioned table. For example, consider the following [CREATE TABLE](#) statement:

```
CREATE TABLE ts (id INT, purchased DATE)
PARTITION BY RANGE( YEAR(purchased) )
SUBPARTITION BY HASH( TO_DAYS(purchased) )
SUBPARTITIONS 2 (
  PARTITION p0 VALUES LESS THAN (1990),
  PARTITION p1 VALUES LESS THAN (2000),
  PARTITION p2 VALUES LESS THAN MAXVALUE
);
```

Table `ts` has 3 [RANGE](#) partitions. Each of these partitions — `p0`, `p1`, and `p2` — is further divided into 2 subpartitions. In effect, the entire table is divided into  $3 * 2 = 6$  partitions. However, due to the action of the [PARTITION BY RANGE](#) clause, the first 2 of these store only those records with a value less than 1990 in the `purchased` column.



In MySQL 5.1, it is possible to subpartition tables that are partitioned by [RANGE](#) or [LIST](#). Subpartitions may use either [HASH](#) or [KEY](#) partitioning. This is also known as *composite partitioning*.

It is also possible to define subpartitions explicitly using [SUBPARTITION](#) clauses to specify options for individual subpartitions. For example, a more verbose fashion of creating the same table `ts` as shown in the previous example would be:

```
CREATE TABLE ts (id INT, purchased DATE)
PARTITION BY RANGE( YEAR(purchased) )
SUBPARTITION BY HASH( TO_DAYS(purchased) ) (
  PARTITION p0 VALUES LESS THAN (1990) (
    SUBPARTITION s0,
    SUBPARTITION s1
  ),
  PARTITION p1 VALUES LESS THAN (2000) (
    SUBPARTITION s2,
    SUBPARTITION s3
  ),
  PARTITION p2 VALUES LESS THAN MAXVALUE (
    SUBPARTITION s4,
    SUBPARTITION s5
  )
);
```

Some syntactical items of note:

- Each partition must have the same number of subpartitions.
- If you explicitly define any subpartitions using [SUBPARTITION](#) on any partition of a partitioned table, you must define them all. In other words, the following statement will fail:

```
CREATE TABLE ts (id INT, purchased DATE)
PARTITION BY RANGE( YEAR(purchased) )
SUBPARTITION BY HASH( TO_DAYS(purchased) ) (
  PARTITION p0 VALUES LESS THAN (1990) (
    SUBPARTITION s0,
    SUBPARTITION s1
  ),
  PARTITION p1 VALUES LESS THAN (2000),
  PARTITION p2 VALUES LESS THAN MAXVALUE (
    SUBPARTITION s2,
    SUBPARTITION s3
  )
);
```

This statement would still fail even if it included a [SUBPARTITIONS 2](#) clause.

- Each [SUBPARTITION](#) clause must include (at a minimum) a name for the subpartition. Otherwise, you may set any desired option for the subpartition or allow it to assume its default setting for that option.
- In MySQL 5.1.7 and earlier, names of subpartitions were required to be unique within each partition, but did not have to be unique within the table as a whole. Beginning with MySQL 5.1.8, subpartition names must be unique across the entire table. For example, the following [CREATE TABLE](#) statement is valid in MySQL 5.1.8 and later:

```
CREATE TABLE ts (id INT, purchased DATE)
PARTITION BY RANGE( YEAR(purchased) )
SUBPARTITION BY HASH( TO_DAYS(purchased) ) (
  PARTITION p0 VALUES LESS THAN (1990) (
    SUBPARTITION s0,
    SUBPARTITION s1
  ),
  PARTITION p1 VALUES LESS THAN (2000) (
    SUBPARTITION s2,
    SUBPARTITION s3
  ),
  PARTITION p2 VALUES LESS THAN MAXVALUE (
    SUBPARTITION s4,
    SUBPARTITION s5
  )
);
```

(The previous statement is also valid for versions of MySQL prior to 5.1.8.)

Subpartitions can be used with especially large tables to distribute data and indexes across many disks. Suppose that you have 6 disks mounted as `/disk0`, `/disk1`, `/disk2`, and so on. Now consider the following example:

```
CREATE TABLE ts (id INT, purchased DATE)
PARTITION BY RANGE( YEAR(purchased) )
SUBPARTITION BY HASH( TO_DAYS(purchased) ) (
  PARTITION p0 VALUES LESS THAN (1990) (
    SUBPARTITION s0
    DATA DIRECTORY = '/disk0/data'
    INDEX DIRECTORY = '/disk0/idx',
```

```

        SUBPARTITION s1
          DATA DIRECTORY = '/disk1/data'
          INDEX DIRECTORY = '/disk1/idx'
      ),
      PARTITION p1 VALUES LESS THAN (2000) (
        SUBPARTITION s2
          DATA DIRECTORY = '/disk2/data'
          INDEX DIRECTORY = '/disk2/idx',
        SUBPARTITION s3
          DATA DIRECTORY = '/disk3/data'
          INDEX DIRECTORY = '/disk3/idx'
      ),
      PARTITION p2 VALUES LESS THAN MAXVALUE (
        SUBPARTITION s4
          DATA DIRECTORY = '/disk4/data'
          INDEX DIRECTORY = '/disk4/idx',
        SUBPARTITION s5
          DATA DIRECTORY = '/disk5/data'
          INDEX DIRECTORY = '/disk5/idx'
      )
  );

```

In this case, a separate disk is used for the data and for the indexes of each `RANGE`. Many other variations are possible; another example might be:

```

CREATE TABLE ts (id INT, purchased DATE)
PARTITION BY RANGE(YEAR(purchased))
SUBPARTITION BY HASH( TO_DAYS(purchased) ) (
  PARTITION p0 VALUES LESS THAN (1990) (
    SUBPARTITION s0a
      DATA DIRECTORY = '/disk0'
      INDEX DIRECTORY = '/disk1',
    SUBPARTITION s0b
      DATA DIRECTORY = '/disk2'
      INDEX DIRECTORY = '/disk3'
  ),
  PARTITION p1 VALUES LESS THAN (2000) (
    SUBPARTITION s1a
      DATA DIRECTORY = '/disk4/data'
      INDEX DIRECTORY = '/disk4/idx',
    SUBPARTITION s1b
      DATA DIRECTORY = '/disk5/data'
      INDEX DIRECTORY = '/disk5/idx'
  ),
  PARTITION p2 VALUES LESS THAN MAXVALUE (
    SUBPARTITION s2a,
    SUBPARTITION s2b
  )
);

```

Here, the storage is as follows:

- Rows with `purchased` dates from before 1990 take up a vast amount of space, so are split up 4 ways, with a separate disk dedicated to the data and to the indexes for each of the two subpartitions (`s0a` and `s0b`) making up partition `p0`. In other words:
  - The data for subpartition `s0a` is stored on `/disk0`.
  - The indexes for subpartition `s0a` are stored on `/disk1`.
  - The data for subpartition `s0b` is stored on `/disk2`.
  - The indexes for subpartition `s0b` are stored on `/disk3`.
- Rows containing dates ranging from 1990 to 1999 (partition `p1`) do not require as much room as those from before 1990. These are split between 2 disks (`/disk4` and `/disk5`) rather than 4 disks as with the legacy records stored in `p0`:
  - Data and indexes belonging to `p1`'s first subpartition (`s1a`) are stored on `/disk4` — the data in `/disk4/data`, and the indexes in `/disk4/idx`.
  - Data and indexes belonging to `p1`'s second subpartition (`s1b`) are stored on `/disk5` — the data in `/disk5/data`, and the indexes in `/disk5/idx`.
- Rows reflecting dates from the year 2000 to the present (partition `p2`) do not take up as much space as required by either of the two previous ranges. Currently, it is sufficient to store all of these in the default location.

In future, when the number of purchases for the decade beginning with the year 2000 grows to a point where the default location no longer provides sufficient space, the corresponding rows can be moved using an `ALTER TABLE ... REORGANIZE PARTITION` statement. See [Section 17.3, “Partition Management”](#), for an explanation of how this can be done.

Beginning with MySQL 5.1.18, the `DATA DIRECTORY` and `INDEX DIRECTORY` options are disallowed when the `NO_DIR_IN_CREATE` server SQL mode is in effect. This is true for partitions and subpartitions.

## 17.2.6. How MySQL Partitioning Handles `NULL`

Partitioning in MySQL does nothing to disallow `NULL` as the value of a partitioning expression, whether it is a column value or the value of a user-supplied expression. Even though it is permitted to use `NULL` as the value of an expression that must otherwise yield an integer, it is important to keep in mind that `NULL` is not a number. Beginning with MySQL 5.1.8, the partitioning implementation treats `NULL` as being less than any non-`NULL` value, just as `ORDER BY` does.

This means that treatment of `NULL` varies between partitioning of different types, and may produce behavior which you do not expect if you are not prepared for it. This being the case, we discuss in this section how each MySQL partitioning type handles `NULL` values when determining the partition in which a row should be stored, and provide examples for each.

**Handling of `NULL` with `RANGE` partitioning.** If you insert a row into a table partitioned by `RANGE` such that the column value used to determine the partition is `NULL`, the row is inserted into the lowest partition. For example, consider these two tables in a database named `p`, created as follows:

```
mysql> CREATE TABLE t1 (
->   c1 INT,
->   c2 VARCHAR(20)
-> )
-> PARTITION BY RANGE(c1) (
->   PARTITION p0 VALUES LESS THAN (0),
->   PARTITION p1 VALUES LESS THAN (10),
->   PARTITION p2 VALUES LESS THAN MAXVALUE
-> );
Query OK, 0 rows affected (0.09 sec)

mysql> CREATE TABLE t2 (
->   c1 INT,
->   c2 VARCHAR(20)
-> )
-> PARTITION BY RANGE(c1) (
->   PARTITION p0 VALUES LESS THAN (-5),
->   PARTITION p1 VALUES LESS THAN (0),
->   PARTITION p2 VALUES LESS THAN (10),
->   PARTITION p3 VALUES LESS THAN MAXVALUE
-> );
Query OK, 0 rows affected (0.09 sec)
```

You can see the partitions created by these two `CREATE TABLE` statements using the following query against the `PARTITIONS` table in the `INFORMATION_SCHEMA` database:

```
mysql> SELECT TABLE_NAME, PARTITION_NAME, TABLE_ROWS, AVG_ROW_LENGTH, DATA_LENGTH
> FROM INFORMATION_SCHEMA.PARTITIONS
> WHERE TABLE_SCHEMA = 'p' AND TABLE_NAME LIKE 't_';
+-----+-----+-----+-----+-----+
| TABLE_NAME | PARTITION_NAME | TABLE_ROWS | AVG_ROW_LENGTH | DATA_LENGTH |
+-----+-----+-----+-----+-----+
| t1          | p0              | 0           | 0              | 0            |
| t1          | p1              | 0           | 0              | 0            |
| t1          | p2              | 0           | 0              | 0            |
| t2          | p0              | 0           | 0              | 0            |
| t2          | p1              | 0           | 0              | 0            |
| t2          | p2              | 0           | 0              | 0            |
| t2          | p3              | 0           | 0              | 0            |
+-----+-----+-----+-----+-----+
7 rows in set (0.00 sec)
```

(For more information about this table, see [Section 19.19, “The `INFORMATION\_SCHEMA PARTITIONS` Table”](#).) Now let us populate each of these tables with a single row containing a `NULL` in the column used as the partitioning key, and verify that the rows were inserted using a pair of `SELECT` statements:

```
mysql> INSERT INTO t1 VALUES (NULL, 'mothra');
Query OK, 1 row affected (0.00 sec)

mysql> INSERT INTO t2 VALUES (NULL, 'mothra');
Query OK, 1 row affected (0.00 sec)

mysql> SELECT * FROM t1;
+----+-----+
| id | name  |
+----+-----+
| NULL | mothra |
+----+-----+
1 row in set (0.00 sec)

mysql> SELECT * FROM t2;
+----+-----+
| id | name  |
+----+-----+
| NULL | mothra |
+----+-----+
1 row in set (0.00 sec)
```

You can see which partitions are used to store the inserted rows by rerunning the previous query against `INFORMATION_SCHEMA.PARTITIONS` and inspecting the output:

```
mysql> SELECT TABLE_NAME, PARTITION_NAME, TABLE_ROWS, AVG_ROW_LENGTH, DATA_LENGTH
> FROM INFORMATION_SCHEMA.PARTITIONS
> WHERE TABLE_SCHEMA = 'p' AND TABLE_NAME LIKE 't_';
```

TABLE_NAME	PARTITION_NAME	TABLE_ROWS	AVG_ROW_LENGTH	DATA_LENGTH
t1	p0	1	20	20
t1	p1	0	0	0
t1	p2	0	0	0
t2	p0	1	20	20
t2	p1	0	0	0
t2	p2	0	0	0
t2	p3	0	0	0

7 rows in set (0.01 sec)

You can also demonstrate that these rows were stored in the lowest partition of each table by dropping these partitions, and then rerunning the `SELECT` statements:

```
mysql> ALTER TABLE t1 DROP PARTITION p0;
Query OK, 0 rows affected (0.16 sec)

mysql> ALTER TABLE t2 DROP PARTITION p0;
Query OK, 0 rows affected (0.16 sec)

mysql> SELECT * FROM t1;
Empty set (0.00 sec)

mysql> SELECT * FROM t2;
Empty set (0.00 sec)
```

(For more information on `ALTER TABLE ... DROP PARTITION`, see [Section 12.1.7, “ALTER TABLE Syntax”](#).)

### Important

Prior to MySQL 5.1.8, `RANGE` partitioning treated a partitioning expression value of `NULL` as 0 with respect to determining placement. (The only way to circumvent this behavior was to design tables so as not to allow nulls, usually by declaring columns `NOT NULL`.) If you have a `RANGE` partitioning scheme that depends on this earlier behavior, you must re-implement it when upgrading to MySQL 5.1.8 or later. ([Bug#15447](#))

`NULL` is also treated in this way for partitioning expressions that use SQL functions. Suppose that we define a table using a `CREATE TABLE` statement such as this one:

```
CREATE TABLE tndate (
  id INT,
  dt DATE
)
PARTITION BY RANGE( YEAR(dt) ) (
  PARTITION p0 VALUES LESS THAN (1990),
  PARTITION p1 VALUES LESS THAN (2000),
  PARTITION p2 VALUES LESS THAN MAXVALUE
);
```

As with other MySQL functions, `YEAR(NULL)` returns `NULL`. A row with a `dt` column value of `NULL` is treated as though the partitioning expression evaluated to a value less than any other value, and so is inserted into partition `p0`.

**Handling of `NULL` with `LIST` partitioning.** A table that is partitioned by `LIST` admits `NULL` values if and only if one of its partitions is defined using that value-list that contains `NULL`. The converse of this is that a table partitioned by `LIST` which does not explicitly use `NULL` in a value list rejects rows resulting in a `NULL` value for the partitioning expression, as shown in this example:

```
mysql> CREATE TABLE ts1 (
->   c1 INT,
->   c2 VARCHAR(20)
-> )
-> PARTITION BY LIST(c1) (
->   PARTITION p0 VALUES IN (0, 3, 6),
->   PARTITION p1 VALUES IN (1, 4, 7),
->   PARTITION p2 VALUES IN (2, 5, 8)
-> );
Query OK, 0 rows affected (0.01 sec)

mysql> INSERT INTO ts1 VALUES (9, 'mothra');
ERROR 1504 (HY000): TABLE HAS NO PARTITION FOR VALUE 9

mysql> INSERT INTO ts1 VALUES (NULL, 'mothra');
ERROR 1504 (HY000): TABLE HAS NO PARTITION FOR VALUE NULL
```

Only rows having a `c1` value between 0 and 8 inclusive can be inserted into `ts1`. `NULL` falls outside this range, just like the number 9. We can create tables `ts2` and `ts3` having value lists containing `NULL`, as shown here:

```
mysql> CREATE TABLE ts2 (
->   c1 INT,
->   c2 VARCHAR(20)
-> )
-> PARTITION BY LIST(c1) (
```

```

-> PARTITION p0 VALUES IN (0, 3, 6),
-> PARTITION p1 VALUES IN (1, 4, 7),
-> PARTITION p2 VALUES IN (2, 5, 8),
-> PARTITION p3 VALUES IN (NULL)
-> );
Query OK, 0 rows affected (0.01 sec)

mysql> CREATE TABLE ts3 (
->   c1 INT,
->   c2 VARCHAR(20)
-> )
-> PARTITION BY LIST(c1) (
->   PARTITION p0 VALUES IN (0, 3, 6),
->   PARTITION p1 VALUES IN (1, 4, 7, NULL),
->   PARTITION p2 VALUES IN (2, 5, 8)
-> );
Query OK, 0 rows affected (0.01 sec)

```

When defining value lists for partitioning, you can (and should) treat `NULL` just as you would any other value. For example, both `VALUES IN (NULL)` and `VALUES IN (1, 4, 7, NULL)` are valid, as are `VALUES IN (1, NULL, 4, 7)`, `VALUES IN (NULL, 1, 4, 7)`, and so on. You can insert a row having `NULL` for column `c1` into each of the tables `ts2` and `ts3`:

```

mysql> INSERT INTO ts2 VALUES (NULL, 'mothra');
Query OK, 1 row affected (0.00 sec)

mysql> INSERT INTO ts3 VALUES (NULL, 'mothra');
Query OK, 1 row affected (0.00 sec)

```

By issuing the appropriate query against `INFORMATION_SCHEMA.PARTITIONS`, you can determine which partitions were used to store the rows just inserted (we assume, as in the previous examples, that the partitioned tables were created in the `p` database):

```

mysql> SELECT TABLE_NAME, PARTITION_NAME, TABLE_ROWS, AVG_ROW_LENGTH, DATA_LENGTH
> FROM INFORMATION_SCHEMA.PARTITIONS
> WHERE TABLE_SCHEMA = 'p' AND TABLE_NAME LIKE 'ts_';

```

TABLE_NAME	PARTITION_NAME	TABLE_ROWS	AVG_ROW_LENGTH	DATA_LENGTH
ts2	p0	0	0	0
ts2	p1	0	0	0
ts2	p2	0	0	0
ts2	p3	1	20	20
ts3	p0	0	0	0
ts3	p1	1	20	20
ts3	p2	0	0	0

7 rows in set (0.01 sec)

As shown earlier in this section, you can also verify which partitions were used for storing the rows by deleting these partitions and then performing a `SELECT`.

**Handling of `NULL` with `HASH` and `KEY` partitioning.** `NULL` is handled somewhat differently for tables partitioned by `HASH` or `KEY`. In these cases, any partition expression that yields a `NULL` value is treated as though its return value were zero. We can verify this behavior by examining the effects on the file system of creating a table partitioned by `HASH` and populating it with a record containing appropriate values. Suppose that you have a table `th` (also in the `p` database) created using the following statement:

```

mysql> CREATE TABLE th (
->   c1 INT,
->   c2 VARCHAR(20)
-> )
-> PARTITION BY HASH(c1)
-> PARTITIONS 2;
Query OK, 0 rows affected (0.00 sec)

```

The partitions belonging to this table can be viewed like this:

```

mysql> SELECT TABLE_NAME, PARTITION_NAME, TABLE_ROWS, AVG_ROW_LENGTH, DATA_LENGTH
> FROM INFORMATION_SCHEMA.PARTITIONS
> WHERE TABLE_SCHEMA = 'p' AND TABLE_NAME = 'th';

```

TABLE_NAME	PARTITION_NAME	TABLE_ROWS	AVG_ROW_LENGTH	DATA_LENGTH
th	p0	0	0	0
th	p1	0	0	0

2 rows in set (0.00 sec)

Note that `TABLE_ROWS` for each partition is 0. Now insert two rows into `th` whose `c1` column values are `NULL` and 0, and verify that these rows were inserted:

```

mysql> INSERT INTO th VALUES (NULL, 'mothra'), (0, 'gigan');
Query OK, 1 row affected (0.00 sec)

mysql> SELECT * FROM th;

```

c1	c2
NULL	mothra
0	gigan

```
+-----+-----+
2 rows in set (0.01 sec)
```

Recall that for any integer  $N$ , the value of `NULL MOD N` is always `NULL`. For tables that are partitioned by `HASH` or `KEY`, this result is treated for determining the correct partition as 0. Checking the `INFORMATION_SCHEMA.PARTITIONS` table once again, we can see that both rows were inserted into partition `p0`:

```
mysql> SELECT TABLE_NAME, PARTITION_NAME, TABLE_ROWS, AVG_ROW_LENGTH, DATA_LENGTH
> FROM INFORMATION_SCHEMA.PARTITIONS
> WHERE TABLE_SCHEMA = 'p' AND TABLE_NAME = 'th';
```

TABLE_NAME	PARTITION_NAME	TABLE_ROWS	AVG_ROW_LENGTH	DATA_LENGTH
th	p0	2	20	20
th	p1	0	0	0

```
2 rows in set (0.00 sec)
```

If you repeat this example using `PARTITION BY KEY` in place of `PARTITION BY HASH` in the definition of the table, you can verify easily that `NULL` is also treated like 0 for this type of partitioning as well.

## 17.3. Partition Management

MySQL 5.1 provides a number of ways to modify partitioned tables. It is possible to add, drop, redefine, merge, or split existing partitions. All of these actions can be carried out using the partitioning extensions to the `ALTER TABLE` command (see [Section 12.1.7, “ALTER TABLE Syntax”](#), for syntax definitions). There are also ways to obtain information about partitioned tables and partitions. We discuss these topics in the sections that follow.

- For information about partition management in tables partitioned by `RANGE` or `LIST`, see [Section 17.3.1, “Management of RANGE and LIST Partitions”](#).
- For a discussion of managing `HASH` and `KEY` partitions, see [Section 17.3.2, “Management of HASH and KEY Partitions”](#).
- See [Section 17.3.4, “Obtaining Information About Partitions”](#), for a discussion of mechanisms provided in MySQL 5.1 for obtaining information about partitioned tables and partitions.
- For a discussion of performing maintenance operations on partitions, see [Section 17.3.3, “Maintenance of Partitions”](#).

### Note

In MySQL 5.1, all partitions of a partitioned table must have the same number of subpartitions, and it is not possible to change the subpartitioning once the table has been created.

The statement `ALTER TABLE ... PARTITION BY ...` is available and is functional beginning with MySQL 5.1.6; previously in MySQL 5.1, this was accepted as valid syntax, but the statement did nothing.

To change a table's partitioning scheme, it is necessary only to use the `ALTER TABLE` command with a `partition_options` clause. This clause has the same syntax as that as used with `CREATE TABLE` for creating a partitioned table, and always begins with the keywords `PARTITION BY`. For example, suppose that you have a table partitioned by range using the following `CREATE TABLE` statement:

```
CREATE TABLE trb3 (id INT, name VARCHAR(50), purchased DATE)
PARTITION BY RANGE( YEAR(purchased) ) (
PARTITION p0 VALUES LESS THAN (1990),
PARTITION p1 VALUES LESS THAN (1995),
PARTITION p2 VALUES LESS THAN (2000),
PARTITION p3 VALUES LESS THAN (2005)
);
```

To repartition this table so that it is partitioned by key into two partitions using the `id` column value as the basis for the key, you can use this statement:

```
ALTER TABLE trb3 PARTITION BY KEY(id) PARTITIONS 2;
```

This has the same effect on the structure of the table as dropping the table and re-creating it using `CREATE TABLE trb3 PARTITION BY KEY(id) PARTITIONS 2;`.

In MySQL 5.1.7 and earlier MySQL 5.1 releases, `ALTER TABLE ... ENGINE = ...` removed all partitioning from the affected table. Beginning with MySQL 5.1.8, this statement changes only the storage engine used by the table, and leaves the table's partitioning scheme intact. As of MySQL 5.1.8, use `ALTER TABLE ... REMOVE PARTITIONING` to remove a table's partitioning. See [Section 12.1.7, “ALTER TABLE Syntax”](#).

### Important

Only a single `PARTITION BY`, `ADD PARTITION`, `DROP PARTITION`, `REORGANIZE PARTITION`, or `COALESCE PARTITION` clause can be used in a given `ALTER TABLE` statement. If you (for example) wish to drop a partition and reorganize a table's remaining partitions, you must do so in two separate `ALTER TABLE` statements (one using `DROP PARTITION` and then a second one using `REORGANIZE PARTITIONS`).

### 17.3.1. Management of `RANGE` and `LIST` Partitions

Range and list partitions are very similar with regard to how the adding and dropping of partitions are handled. For this reason we discuss the management of both sorts of partitioning in this section. For information about working with tables that are partitioned by hash or key, see [Section 17.3.2, “Management of `HASH` and `KEY` Partitions”](#). Dropping a `RANGE` or `LIST` partition is more straightforward than adding one, so we discuss this first.

Dropping a partition from a table that is partitioned by either `RANGE` or by `LIST` can be accomplished using the `ALTER TABLE` statement with a `DROP PARTITION` clause. Here is a very basic example, which supposes that you have already created a table which is partitioned by range and then populated with 10 records using the following `CREATE TABLE` and `INSERT` statements:

```
mysql> CREATE TABLE tr (id INT, name VARCHAR(50), purchased DATE)
-> PARTITION BY RANGE( YEAR(purchased) ) (
-> PARTITION p0 VALUES LESS THAN (1990),
-> PARTITION p1 VALUES LESS THAN (1995),
-> PARTITION p2 VALUES LESS THAN (2000),
-> PARTITION p3 VALUES LESS THAN (2005)
-> );
Query OK, 0 rows affected (0.01 sec)

mysql> INSERT INTO tr VALUES
-> (1, 'desk organiser', '2003-10-15'),
-> (2, 'CD player', '1993-11-05'),
-> (3, 'TV set', '1996-03-10'),
-> (4, 'bookcase', '1982-01-10'),
-> (5, 'exercise bike', '2004-05-09'),
-> (6, 'sofa', '1987-06-05'),
-> (7, 'popcorn maker', '2001-11-22'),
-> (8, 'aquarium', '1992-08-04'),
-> (9, 'study desk', '1984-09-16'),
-> (10, 'lava lamp', '1998-12-25');
Query OK, 10 rows affected (0.01 sec)
```

You can see which items should have been inserted into partition `p2` as shown here:

```
mysql> SELECT * FROM tr
-> WHERE purchased BETWEEN '1995-01-01' AND '1999-12-31';
+-----+-----+-----+
| id | name | purchased |
+-----+-----+-----+
| 3 | TV set | 1996-03-10 |
| 10 | lava lamp | 1998-12-25 |
+-----+-----+-----+
2 rows in set (0.00 sec)
```

To drop the partition named `p2`, execute the following command:

```
mysql> ALTER TABLE tr DROP PARTITION p2;
Query OK, 0 rows affected (0.03 sec)
```

#### Note

The `NDBCLUSTER` storage engine does not support `ALTER TABLE ... DROP PARTITION`. It does, however, support the other partitioning-related extensions to `ALTER TABLE` that are described in this chapter.

It is very important to remember that, *when you drop a partition, you also delete all the data that was stored in that partition*. You can see that this is the case by re-running the previous `SELECT` query:

```
mysql> SELECT * FROM tr WHERE purchased
-> BETWEEN '1995-01-01' AND '1999-12-31';
Empty set (0.00 sec)
```

Because of this, the requirement was added in MySQL 5.1.10 that you have the `DROP` privilege for a table before you can execute `ALTER TABLE ... DROP PARTITION` on that table.

If you wish to drop all data from all partitions while preserving the table definition and its partitioning scheme, use the `TRUNCATE TABLE` command. (See [Section 12.2.10, “`TRUNCATE` Syntax”](#).)

If you intend to change the partitioning of a table *without* losing data, use `ALTER TABLE ... REORGANIZE PARTITION` instead. See below or in [Section 12.1.7, “`ALTER TABLE` Syntax”](#), for information about `REORGANIZE PARTITION`.

If you now execute a `SHOW CREATE TABLE` command, you can see how the partitioning makeup of the table has been changed:



```
mysql> SHOW CREATE TABLE tr\G
***** 1. row *****
Table: tr
Create Table: CREATE TABLE `tr` (
  `id` int(11) default NULL,
  `name` varchar(50) default NULL,
  `purchased` date default NULL
) ENGINE=MyISAM DEFAULT CHARSET=latin1
PARTITION BY RANGE ( YEAR(purchased) ) (
  PARTITION p0 VALUES LESS THAN (1990) ENGINE = MyISAM,
  PARTITION p1 VALUES LESS THAN (1995) ENGINE = MyISAM,
  PARTITION p3 VALUES LESS THAN (2005) ENGINE = MyISAM
)
1 row in set (0.01 sec)
```

When you insert new rows into the changed table with `purchased` column values between `'1995-01-01'` and `'2004-12-31'` inclusive, those rows will be stored in partition `p3`. You can verify this as follows:

```
mysql> INSERT INTO tr VALUES (11, 'pencil holder', '1995-07-12');
Query OK, 1 row affected (0.00 sec)

mysql> SELECT * FROM tr WHERE purchased
-> BETWEEN '1995-01-01' AND '2004-12-31';
+-----+-----+-----+
| id | name | purchased |
+-----+-----+-----+
| 11 | pencil holder | 1995-07-12 |
| 1 | desk organiser | 2003-10-15 |
| 5 | exercise bike | 2004-05-09 |
| 7 | popcorn maker | 2001-11-22 |
+-----+-----+-----+
4 rows in set (0.00 sec)

mysql> ALTER TABLE tr DROP PARTITION p3;
Query OK, 0 rows affected (0.03 sec)

mysql> SELECT * FROM tr WHERE purchased
-> BETWEEN '1995-01-01' AND '2004-12-31';
Empty set (0.00 sec)
```

Note that the number of rows dropped from the table as a result of `ALTER TABLE ... DROP PARTITION` is not reported by the server as it would be by the equivalent `DELETE` query.

Dropping `LIST` partitions uses exactly the same `ALTER TABLE ... DROP PARTITION` syntax as used for dropping `RANGE` partitions. However, there is one important difference in the effect this has on your use of the table afterward: You can no longer insert into the table any rows having any of the values that were included in the value list defining the deleted partition. (See [Section 17.2.2, "LIST Partitioning"](#), for an example.)

To add a new range or list partition to a previously partitioned table, use the `ALTER TABLE ... ADD PARTITION` statement. For tables which are partitioned by `RANGE`, this can be used to add a new range to the end of the list of existing partitions. For example, suppose that you have a partitioned table containing membership data for your organisation, which is defined as follows:

```
CREATE TABLE members (
  id INT,
  fname VARCHAR(25),
  lname VARCHAR(25),
  dob DATE
)
PARTITION BY RANGE( YEAR(dob) ) (
  PARTITION p0 VALUES LESS THAN (1970),
  PARTITION p1 VALUES LESS THAN (1980),
  PARTITION p2 VALUES LESS THAN (1990)
);
```

Suppose further that the minimum age for members is 16. As the calendar approaches the end of 2005, you realize that you will soon be admitting members who were born in 1990 (and later in years to come). You can modify the `members` table to accommodate new members born in the years 1990-1999 as shown here:

```
ALTER TABLE ADD PARTITION (PARTITION p3 VALUES LESS THAN (2000));
```

### Important

With tables that are partitioned by range, you can use `ADD PARTITION` to add new partitions to the high end of the partitions list only. Trying to add a new partition in this manner between or before existing partitions will result in an error as shown here:

```
mysql> ALTER TABLE members
> ADD PARTITION (
> PARTITION p3 VALUES LESS THAN (1960));
ERROR 1463 (HY000): VALUES LESS THAN value must be strictly »
increasing for each partition
```



In a similar fashion, you can add new partitions to a table that is partitioned by `LIST`. For example, given a table defined like so:

```
CREATE TABLE tt (
  id INT,
  data INT
)
PARTITION BY LIST(data) (
  PARTITION p0 VALUES IN (5, 10, 15),
  PARTITION p1 VALUES IN (6, 12, 18)
);
```

You can add a new partition in which to store rows having the `data` column values 7, 14, and 21 as shown:

```
ALTER TABLE tt ADD PARTITION (PARTITION p2 VALUES IN (7, 14, 21));
```

Note that you *cannot* add a new `LIST` partition encompassing any values that are already included in the value list of an existing partition. If you attempt to do so, an error will result:

```
mysql> ALTER TABLE tt ADD PARTITION
> (PARTITION np VALUES IN (4, 8, 12));
ERROR 1465 (HY000): Multiple definition of same constant »
in list partitioning
```

Because any rows with the `data` column value 12 have already been assigned to partition `p1`, you cannot create a new partition on table `tt` that includes 12 in its value list. To accomplish this, you could drop `p1`, and add `np` and then a new `p1` with a modified definition. However, as discussed earlier, this would result in the loss of all data stored in `p1` — and it is often the case that this is not what you really want to do. Another solution might appear to be to make a copy of the table with the new partitioning and to copy the data into it using `CREATE TABLE ... SELECT ...`, then drop the old table and rename the new one, but this could be very time-consuming when dealing with a large amounts of data. This also might not be feasible in situations where high availability is a requirement.

Beginning with MySQL 5.1.6, you can add multiple partitions in a single `ALTER TABLE ... ADD PARTITION` statement as shown here:

```
CREATE TABLE employees (
  id INT NOT NULL,
  fname VARCHAR(50) NOT NULL,
  lname VARCHAR(50) NOT NULL,
  hired DATE NOT NULL
)
PARTITION BY RANGE( YEAR(hired) ) (
  PARTITION p1 VALUES LESS THAN (1991),
  PARTITION p2 VALUES LESS THAN (1996),
  PARTITION p3 VALUES LESS THAN (2001),
  PARTITION p4 VALUES LESS THAN (2005)
);

ALTER TABLE employees ADD PARTITION (
  PARTITION p5 VALUES LESS THAN (2010),
  PARTITION p6 VALUES LESS THAN MAXVALUE
);
```

Fortunately, MySQL's partitioning implementation provides ways to redefine partitions without losing data. Let us look first at a couple of simple examples involving `RANGE` partitioning. Recall the `members` table which is now defined as shown here:

```
mysql> SHOW CREATE TABLE members\G
***** 1. row *****
Table: members
Create Table: CREATE TABLE `members` (
  `id` int(11) default NULL,
  `fname` varchar(25) default NULL,
  `lname` varchar(25) default NULL,
  `dob` date default NULL
) ENGINE=MyISAM DEFAULT CHARSET=latin1
PARTITION BY RANGE ( YEAR(dob) ) (
  PARTITION p0 VALUES LESS THAN (1970) ENGINE = MyISAM,
  PARTITION p1 VALUES LESS THAN (1980) ENGINE = MyISAM,
  PARTITION p2 VALUES LESS THAN (1990) ENGINE = MyISAM,
  PARTITION p3 VALUES LESS THAN (2000) ENGINE = MyISAM
)
```

Suppose that you would like to move all rows representing members born before 1960 into a separate partition. As we have already seen, this cannot be done using `ALTER TABLE ... ADD PARTITION`. However, you can use another partition-related extension to `ALTER TABLE` in order to accomplish this:

```
ALTER TABLE members REORGANIZE PARTITION p0 INTO (
  PARTITION s0 VALUES LESS THAN (1960),
  PARTITION s1 VALUES LESS THAN (1970)
);
```

In effect, this command splits partition `p0` into two new partitions `s0` and `s1`. It also moves the data that was stored in `p0` into the new partitions according to the rules embodied in the two `PARTITION ... VALUES ...` clauses, so that `s0` contains only those records for which `YEAR(dob)` is less than 1960 and `s1` contains those rows in which `YEAR(dob)` is greater than or equal to 1960 but less than 1970.

A `REORGANIZE PARTITION` clause may also be used for merging adjacent partitions. You can return the `members` table to its previous partitioning as shown here:

```
ALTER TABLE members REORGANIZE PARTITION s0,s1 INTO (
    PARTITION p0 VALUES LESS THAN (1970)
);
```

No data is lost in splitting or merging partitions using `REORGANIZE PARTITION`. In executing the above statement, MySQL moves all of the records that were stored in partitions `s0` and `s1` into partition `p0`.

The general syntax for `REORGANIZE PARTITION` is:

```
ALTER TABLE tbl_name
    REORGANIZE PARTITION partition_list
    INTO (partition_definitions);
```

Here, `tbl_name` is the name of the partitioned table, and `partition_list` is a comma-separated list of names of one or more existing partitions to be changed. `partition_definitions` is a comma-separated list of new partition definitions, which follow the same rules as for the `partition_definitions` list used in `CREATE TABLE` (see [Section 12.1.17, “CREATE TABLE Syntax”](#)). It should be noted that you are not limited to merging several partitions into one, or to splitting one partition into many, when using `REORGANIZE PARTITION`. For example, you can reorganize all four partitions of the `members` table into two, as follows:

```
ALTER TABLE members REORGANIZE PARTITION p0,p1,p2,p3 INTO (
    PARTITION m0 VALUES LESS THAN (1980),
    PARTITION m1 VALUES LESS THAN (2000)
);
```

You can also use `REORGANIZE PARTITION` with tables that are partitioned by `LIST`. Let us return to the problem of adding a new partition to the list-partitioned `tt` table and failing because the new partition had a value that was already present in the value-list of one of the existing partitions. We can handle this by adding a partition that contains only non-conflicting values, and then reorganizing the new partition and the existing one so that the value which was stored in the existing one is now moved to the new one:

```
ALTER TABLE tt ADD PARTITION (PARTITION np VALUES IN (4, 8));
ALTER TABLE tt REORGANIZE PARTITION p1,np INTO (
    PARTITION p1 VALUES IN (6, 18),
    PARTITION np VALUES in (4, 8, 12)
);
```

Here are some key points to keep in mind when using `ALTER TABLE ... REORGANIZE PARTITION` to repartition tables that are partitioned by `RANGE` or `LIST`:

- The `PARTITION` clauses used to determine the new partitioning scheme are subject to the same rules as those used with a `CREATE TABLE` statement.

Most importantly, you should remember that the new partitioning scheme cannot have any overlapping ranges (applies to tables partitioned by `RANGE`) or sets of values (when reorganizing tables partitioned by `LIST`).

### Note

Prior to MySQL 5.1.4, you could not reuse the names of existing partitions in the `INTO` clause, even when those partitions were being dropped or redefined. See [Section C.2.34, “Changes in MySQL 5.1.4 \(21 December 2005\)”](#), for more information.

- The combination of partitions in the `partition_definitions` list should account for the same range or set of values overall as the combined partitions named in the `partition_list`.

For instance, in the `members` table used as an example in this section, partitions `p1` and `p2` together cover the years 1980 through 1999. Therefore, any reorganization of these two partitions should cover the same range of years overall.

- For tables partitioned by `RANGE`, you can reorganize only adjacent partitions; you cannot skip over range partitions.

For instance, you could not reorganize the `members` table used as an example in this section using a statement beginning with `ALTER TABLE members REORGANIZE PARTITION p0,p2 INTO ...` because `p0` covers the years prior to 1970 and `p2` the years from 1990 through 1999 inclusive, and thus the two are not adjacent partitions.

- You cannot use `REORGANIZE PARTITION` to change the table's partitioning type; that is, you cannot (for example) change `RANGE` partitions to `HASH` partitions or *vice versa*. You also cannot use this command to change the partitioning expression or column. To accomplish either of these tasks without dropping and re-creating the table, you can use `ALTER TABLE ... PARTITION BY ...`. For example:

```
ALTER TABLE members
PARTITION BY HASH( YEAR(dob) )
PARTITIONS 8;
```

## 17.3.2. Management of `HASH` and `KEY` Partitions

Tables which are partitioned by hash or by key are very similar to one another with regard to making changes in a partitioning setup, and both differ in a number of ways from tables which have been partitioned by range or list. For that reason, this section addresses the modification of tables partitioned by hash or by key only. For a discussion of adding and dropping of partitions of tables that are partitioned by range or list, see [Section 17.3.1, “Management of `RANGE` and `LIST` Partitions”](#).

You cannot drop partitions from tables that are partitioned by `HASH` or `KEY` in the same way that you can from tables that are partitioned by `RANGE` or `LIST`. However, you can merge `HASH` or `KEY` partitions using the `ALTER TABLE ... COALESCE PARTITION` command. For example, suppose that you have a table containing data about clients, which is divided into twelve partitions. The `clients` table is defined as shown here:

```
CREATE TABLE clients (
  id INT,
  fname VARCHAR(30),
  lname VARCHAR(30),
  signed DATE
)
PARTITION BY HASH( MONTH(signed) )
PARTITIONS 12;
```

To reduce the number of partitions from twelve to eight, execute the following `ALTER TABLE` command:

```
mysql> ALTER TABLE clients COALESCE PARTITION 4;
Query OK, 0 rows affected (0.02 sec)
```

`COALESCE` works equally well with tables that are partitioned by `HASH`, `KEY`, `LINEAR HASH`, or `LINEAR KEY`. Here is an example similar to the previous one, differing only in that the table is partitioned by `LINEAR KEY`:

```
mysql> CREATE TABLE clients_lk (
->   id INT,
->   fname VARCHAR(30),
->   lname VARCHAR(30),
->   signed DATE
-> )
-> PARTITION BY LINEAR KEY(signed)
-> PARTITIONS 12;
Query OK, 0 rows affected (0.03 sec)

mysql> ALTER TABLE clients_lk COALESCE PARTITION 4;
Query OK, 0 rows affected (0.06 sec)
Records: 0 Duplicates: 0 Warnings: 0
```

Note that the number following `COALESCE PARTITION` is the number of partitions to merge into the remainder — in other words, it is the number of partitions to remove from the table.

If you attempt to remove more partitions than the table has, the result is an error like the one shown:

```
mysql> ALTER TABLE clients COALESCE PARTITION 18;
ERROR 1478 (HY000): Cannot remove all partitions, use DROP TABLE instead
```

To increase the number of partitions for the `clients` table from 12 to 18, use `ALTER TABLE ... ADD PARTITION` as shown here:

```
ALTER TABLE clients ADD PARTITION PARTITIONS 6;
```

## 17.3.3. Maintenance of Partitions

A number of table and partition maintenance tasks can be carried out using SQL statements intended for such purposes on partitioned tables in MySQL 5.1.

Table maintenance of partitioned tables can be accomplished using the statements `CHECK TABLE`, `OPTIMIZE TABLE`, `ANALYZE TABLE`, and `REPAIR TABLE`, which are supported for partitioned tables as of MySQL 5.1.27.

Also beginning with MySQL 5.1.27, you can use a number of extensions to `ALTER TABLE` for performing operations of this type on one or more partitions directly, as described in the following list:

- **Rebuilding partitions.** Rebuilds the partition; this has the same effect as dropping all records stored in the partition, then reinserting them. This can be useful for purposes of defragmentation.

Example:

```
ALTER TABLE t1 REBUILD PARTITION p0, p1;
```

- **Optimizing partitions.** If you have deleted a large number of rows from a partition or if you have made many changes to a partitioned table with variable-length rows (that is, having `VARCHAR`, `BLOB`, or `TEXT` columns), you can use `ALTER TABLE ... OPTIMIZE PARTITION` to reclaim any unused space and to defragment the partition data file.

Example:

```
ALTER TABLE t1 OPTIMIZE PARTITION p0, p1;
```

Using `OPTIMIZE PARTITION` on a given partition is equivalent to running `CHECK PARTITION`, `ANALYZE PARTITION`, and `REPAIR PARTITION` on that partition.

- **Analyzing partitions.** This reads and stores the key distributions for partitions.

Example:

```
ALTER TABLE t1 ANALYZE PARTITION p3;
```

- **Repairing partitions.** This repairs corrupted partitions.

Example:

```
ALTER TABLE t1 REPAIR PARTITION p0,p1;
```

- **Checking partitions.** You can check partitions for errors in much the same way that you can use `CHECK TABLE` with non-partitioned tables.

Example:

```
ALTER TABLE trb3 CHECK PARTITION p1;
```

This command will tell you if the data or indexes in partition `p1` of table `t1` are corrupted. If this is the case, use `ALTER TABLE ... REPAIR PARTITION` to repair the partition.

### Note

The statements `ALTER TABLE ... ANALYZE PARTITION`, `ALTER TABLE ... CHECK PARTITION`, `ALTER TABLE ... OPTIMIZE PARTITION`, and `ALTER TABLE ... REPAIR PARTITION` were originally introduced in MySQL 5.1.5, but did not work properly and were disabled in MySQL 5.1.24. They were re-introduced in MySQL 5.1.27. ([Bug#20129](#)) The use of these partitioning-specific `ALTER TABLE` statements with tables which are not partitioned is not supported; beginning with MySQL 5.1.31, it is expressly disallowed. ([Bug#39434](#))

`ALTER TABLE ... REBUILD PARTITION` was also introduced in MySQL 5.1.5.

## 17.3.4. Obtaining Information About Partitions

This section discusses obtaining information about existing partitions, which can be done in a number of ways. These include:

- Using the `SHOW CREATE TABLE` statement to view the partitioning clauses used in creating a partitioned table.
- Using the `SHOW TABLE STATUS` statement to determine whether a table is partitioned.
- Querying the `INFORMATION_SCHEMA.PARTITIONS` table.
- Using the statement `EXPLAIN PARTITIONS SELECT` to see which partitions are used by a given `SELECT`.

As discussed elsewhere in this chapter, `SHOW CREATE TABLE` includes in its output the `PARTITION BY` clause used to create a partitioned table. For example:

```
mysql> SHOW CREATE TABLE trb3\G
***** 1. row *****
      Table: trb3
Create Table: CREATE TABLE `trb3` (
  `id` int(11) default NULL,
  `name` varchar(50) default NULL,
  `purchased` date default NULL
) ENGINE=MyISAM DEFAULT CHARSET=latin1
PARTITION BY RANGE (YEAR(purchased)) (
  PARTITION p0 VALUES LESS THAN (1990) ENGINE = MyISAM,
  PARTITION p1 VALUES LESS THAN (1995) ENGINE = MyISAM,
  PARTITION p2 VALUES LESS THAN (2000) ENGINE = MyISAM,
  PARTITION p3 VALUES LESS THAN (2005) ENGINE = MyISAM
)
1 row in set (0.00 sec)
```

### Note

In early MySQL 5.1 releases, the `PARTITIONS` clause was not shown for tables partitioned by `HASH` or `KEY`. This issue was fixed in MySQL 5.1.6.

`SHOW TABLE STATUS` works with partitioned tables. Beginning with MySQL 5.1.9, its output is the same as that for non-partitioned tables, except that the `Create_options` column contains the string `partitioned`. In MySQL 5.1.8 and earlier, the `Engine` column always contained the value `PARTITION`; beginning with MySQL 5.1.9, this column contains the name of the storage engine used by all partitions of the table. (See [Section 12.5.5.38, “SHOW TABLE STATUS Syntax”](#), for more information about this statement.)

You can also obtain information about partitions from `INFORMATION_SCHEMA`, which contains a `PARTITIONS` table. See [Section 19.19, “The INFORMATION\\_SCHEMA PARTITIONS Table”](#).

Beginning with MySQL 5.1.5, it is possible to determine which partitions of a partitioned table are involved in a given `SELECT` query using `EXPLAIN PARTITIONS`. The `PARTITIONS` keyword adds a `partitions` column to the output of `EXPLAIN` listing the partitions from which records would be matched by the query.

Suppose that you have a table `trb1` defined and populated as follows:

```
CREATE TABLE trb1 (id INT, name VARCHAR(50), purchased DATE)
PARTITION BY RANGE(id)
(
  PARTITION p0 VALUES LESS THAN (3),
  PARTITION p1 VALUES LESS THAN (7),
  PARTITION p2 VALUES LESS THAN (9),
  PARTITION p3 VALUES LESS THAN (11)
);

INSERT INTO trb1 VALUES
(1, 'desk organiser', '2003-10-15'),
(2, 'CD player', '1993-11-05'),
(3, 'TV set', '1996-03-10'),
(4, 'bookcase', '1982-01-10'),
(5, 'exercise bike', '2004-05-09'),
(6, 'sofa', '1987-06-05'),
(7, 'popcorn maker', '2001-11-22'),
(8, 'aquarium', '1992-08-04'),
(9, 'study desk', '1984-09-16'),
(10, 'lava lamp', '1998-12-25');
```

You can see which partitions are used in a query such as `SELECT * FROM trb1;`, as shown here:

```
mysql> EXPLAIN PARTITIONS SELECT * FROM trb1\G
***** 1. row *****
      id: 1
select_type: SIMPLE
      table: trb1
  partitions: p0,p1,p2,p3
         type: ALL
possible_keys: NULL
          key: NULL
       key_len: NULL
          ref: NULL
         rows: 10
      Extra: Using filesort
```

In this case, all four partitions are searched. However, when a limiting condition making use of the partitioning key is added to the query, you can see that only those partitions containing matching values are scanned, as shown here:

```
mysql> EXPLAIN PARTITIONS SELECT * FROM trb1 WHERE id < 5\G
***** 1. row *****
      id: 1
select_type: SIMPLE
```

```

table: trb1
partitions: p0,p1
type: ALL
possible_keys: NULL
key: NULL
key_len: NULL
ref: NULL
rows: 10
Extra: Using where

```

`EXPLAIN PARTITIONS` provides information about keys used and possible keys, just as with the standard `EXPLAIN SELECT` statement:

```

mysql> ALTER TABLE trb1 ADD PRIMARY KEY (id);
Query OK, 10 rows affected (0.03 sec)
Records: 10 Duplicates: 0 Warnings: 0

mysql> EXPLAIN PARTITIONS SELECT * FROM trb1 WHERE id < 5\G
***** 1. row *****
   id: 1
select_type: SIMPLE
  table: trb1
partitions: p0,p1
   type: range
possible_keys: PRIMARY
   key: PRIMARY
  key_len: 4
   ref: NULL
  rows: 7
  Extra: Using where

```

You should take note of the following restrictions and limitations on `EXPLAIN PARTITIONS`:

- You cannot use the `PARTITIONS` and `EXTENDED` keywords together in the same `EXPLAIN . . . SELECT` statement. Attempting to do so produces a syntax error.
- If `EXPLAIN PARTITIONS` is used to examine a query against a non-partitioned table, no error is produced, but the value of the `partitions` column is always `NULL`.

As of MySQL 5.1.28, the `rows` column of `EXPLAIN PARTITIONS` output always displays the total number of records in the table. Previously, this was the number of matching rows. ([Bug#35745](#))

See also [Section 12.3.2, “EXPLAIN Syntax”](#).

## 17.4. Partition Pruning

This section discusses an optimization known as *partition pruning*, which was implemented for partitioned tables in MySQL 5.1.6. The core concept behind partition pruning is relatively simple, and can be described as “Do not scan partitions where there can be no matching values”. For example, suppose you have a partitioned table `t1` defined by this statement:

```

CREATE TABLE t1 (
  fname VARCHAR(50) NOT NULL,
  lname VARCHAR(50) NOT NULL,
  region_code TINYINT UNSIGNED NOT NULL,
  dob DATE NOT NULL
)
PARTITION BY RANGE( region_code ) (
  PARTITION p0 VALUES LESS THAN (64),
  PARTITION p1 VALUES LESS THAN (128),
  PARTITION p2 VALUES LESS THAN (192),
  PARTITION p3 VALUES LESS THAN MAXVALUE
);

```

Consider the case where you wish to obtain results from a query such as this one:

```

SELECT fname, lname, region_code, dob
FROM t1
WHERE region_code > 125 AND region_code < 130;

```

It is easy to see that none of the rows which ought to be returned will be in either of the partitions `p0` or `p3`; that is, we need to search only in partitions `p1` and `p2` to find matching rows. By doing so, it is possible to expend much more time and effort in finding matching rows than it is to scan all partitions in the table. This “cutting away” of unneeded partitions is known as *pruning*. When the optimizer can make use of partition pruning in performing a query, execution of the query can be an order of magnitude faster than the same query against a non-partitioned table containing the same column definitions and data.

The query optimizer can perform pruning whenever a `WHERE` condition can be reduced to either one of the following:

- `partition_column = constant`
- `partition_column IN (constant1, constant2, ..., constantN)`

In the first case, the optimizer simply evaluates the partitioning expression for the value given, determines which partition contains that value, and scans only this partition. In many cases, the equals sign can be replaced with another arithmetic comparison, including `<`, `>`, `<=`, `>=`, and `<>`. Some queries using `BETWEEN` in the `WHERE` clause can also take advantage of partition pruning. See the examples later in this section.

In the second case, the optimizer evaluates the partitioning expression for each value in the list, creates a list of matching partitions, and then scans only the partitions in this partition list.

Pruning can also be applied to short ranges, which the optimizer can convert into equivalent lists of values. For instance, in the previous example, the `WHERE` clause can be converted to `WHERE region_code IN (125, 126, 127, 128, 129, 130)`. Then the optimizer can determine that the first three values in the list are found in partition `p1`, the remaining three values in partition `p2`, and that the other partitions contain no relevant values and so do not need to be searched for matching rows.

This type of optimization can be applied whenever the partitioning expression consists of an equality or a range which can be reduced to a set of equalities, or when the partitioning expression represents an increasing or decreasing relationship. Pruning can also be applied for tables partitioned on a `DATE` or `DATETIME` column when the partitioning expression uses the `YEAR()` or `TO_DAYS()` function.

### Note

We plan to add pruning support in a future MySQL release for additional functions that act on a `DATE` or `DATETIME` value, return an integer, and are increasing or decreasing.

For example, suppose that table `t2`, defined as shown here, is partitioned on a `DATE` column:

```
CREATE TABLE t2 (
  fname VARCHAR(50) NOT NULL,
  lname VARCHAR(50) NOT NULL,
  region_code TINYINT UNSIGNED NOT NULL,
  dob DATE NOT NULL
)
PARTITION BY RANGE( YEAR(dob) ) (
  PARTITION d0 VALUES LESS THAN (1970),
  PARTITION d1 VALUES LESS THAN (1975),
  PARTITION d2 VALUES LESS THAN (1980),
  PARTITION d3 VALUES LESS THAN (1985),
  PARTITION d4 VALUES LESS THAN (1990),
  PARTITION d5 VALUES LESS THAN (2000),
  PARTITION d6 VALUES LESS THAN (2005),
  PARTITION d7 VALUES LESS THAN MAXVALUE
);
```

The following queries on `t2` can make use of partition pruning:

```
SELECT * FROM t2 WHERE dob = '1982-06-23';
SELECT * FROM t2 WHERE dob BETWEEN '1991-02-15' AND '1997-04-25';
SELECT * FROM t2 WHERE dob >= '1984-06-21' AND dob <= '1999-06-21'
```

In the case of the last query, the optimizer can also act as follows:

1. Find the partition containing the low end of the range.  
`YEAR('1984-06-21')` yields the value `1984`, which is found in partition `d3`.
2. Find the partition containing the high end of the range.  
`YEAR('1999-06-21')` evaluates to `1999`, which is found in partition `d5`.
3. Scan only these two partitions and any partitions that may lie between them.

In this case, this means that only partitions `d3`, `d4`, and `d5` are scanned. The remaining partitions may be safely ignored (and are ignored).

### Important

Invalid `DATE` and `DATETIME` values referenced in the `WHERE` clause of a query on a partitioned table are treated as `NULL`. This means that a query such as `SELECT * FROM partitioned_table WHERE date_column <`

■ '2008-12-00' does not return any values (see [Bug#40972](#)).

So far, we have looked only at examples using [RANGE](#) partitioning, but pruning can be applied with other partitioning types as well.

Consider a table that is partitioned by [LIST](#), where the partitioning expression is increasing or decreasing, such as the table `t3` shown here. (In this example, we assume for the sake of brevity that the `region_code` column is limited to values between 1 and 10 inclusive.)

```
CREATE TABLE t3 (
  fname VARCHAR(50) NOT NULL,
  lname VARCHAR(50) NOT NULL,
  region_code TINYINT UNSIGNED NOT NULL,
  dob DATE NOT NULL
)
PARTITION BY LIST(region_code) (
  PARTITION r0 VALUES IN (1, 3),
  PARTITION r1 VALUES IN (2, 5, 8),
  PARTITION r2 VALUES IN (4, 9),
  PARTITION r3 VALUES IN (6, 7, 10)
);
```

For a query such as `SELECT * FROM t3 WHERE region_code BETWEEN 1 AND 3`, the optimizer determines in which partitions the values 1, 2, and 3 are found (`r0` and `r1`) and skips the remaining ones (`r2` and `r3`).

For tables that are partitioned by [HASH](#) or [KEY](#), partition pruning is also possible in cases in which the `WHERE` clause uses a simple `=` relation against a column used in the partitioning expression. Consider a table created like this:

```
CREATE TABLE t4 (
  fname VARCHAR(50) NOT NULL,
  lname VARCHAR(50) NOT NULL,
  region_code TINYINT UNSIGNED NOT NULL,
  dob DATE NOT NULL
)
PARTITION BY KEY(region_code)
PARTITIONS 8;
```

Any query such as this one can be pruned:

```
SELECT * FROM t4 WHERE region_code = 7;
```

Pruning can also be employed for short ranges, because the optimizer can turn such conditions into `IN` relations. For example, using the same table `t4` as defined previously, queries such as these can be pruned:

```
SELECT * FROM t4 WHERE region_code > 2 AND region_code < 6;
SELECT * FROM t4 WHERE region_code BETWEEN 3 AND 5;
```

In both these cases, the `WHERE` clause is transformed by the optimizer into `WHERE region_code IN (3, 4, 5)`.

### Important

This optimization is used only if the range size is smaller than the number of partitions. Consider this query:

```
SELECT * FROM t4 WHERE region_code BETWEEN 4 AND 8;
```

The range in the `WHERE` clause covers 5 values (4, 5, 6, 7, 8), but `t4` has only 4 partitions. This means that the previous query cannot be pruned.

Pruning can be used only on integer columns of tables partitioned by [HASH](#) or [KEY](#). For example, this query on table `t4` cannot use pruning because `dob` is a `DATE` column:

```
SELECT * FROM t4 WHERE dob >= '2001-04-14' AND dob <= '2005-10-15';
```

However, if the table stores year values in an `INT` column, then a query having `WHERE year_col >= 2001 AND year_col <= 2005` can be pruned.

## 17.5. Restrictions and Limitations on Partitioning

This section discusses current restrictions and limitations on MySQL partitioning support, as listed here:

- **Prohibited constructs.** Beginning with MySQL 5.1.12, the following constructs are not permitted in partitioning expressions:
  - Stored functions, stored procedures, UDFs, or plugins.



- Declared variables or user variables.

For a list of SQL functions which are permitted in partitioning expressions, see [Section 17.5.3, “Partitioning Limitations Relating to Functions”](#).

- **Arithmetic and logical operators.** Use of the arithmetic operators `+`, `-`, and `*` is permitted in partitioning expressions. However, the result must be an integer value or `NULL` (except in the case of `[LINEAR] KEY` partitioning, as discussed elsewhere in this chapter — see [Section 17.2, “Partition Types”](#), for more information).

Beginning with MySQL 5.1.23, the `DIV` operator is also supported, and the `/` operator is disallowed. ([Bug#30188](#), [Bug#33182](#))

Beginning with MySQL 5.1.12, the bit operators `|`, `&`, `^`, `<<`, `>>`, and `~` are not permitted in partitioning expressions.

- **Server SQL mode.** Tables employing user-defined partitioning do not preserve the SQL mode in effect at the time that they were created. As discussed in [Section 5.1.7, “Server SQL Modes”](#), the results of many MySQL functions and operators may change according to the server SQL mode. Therefore, a change in the SQL mode at any time after the creation of partitioned tables may lead to major changes in the behavior of such tables, and could easily lead to corruption or loss of data. For these reasons, *it is strongly recommended that you never change the server SQL mode after creating partitioned tables.*

**Examples.** The following examples illustrate some changes in behavior of partitioned tables due to a change in the server SQL mode:

1. **Error handling.** Suppose you create a partitioned table whose partitioning expression is one such as `column DIV 0` or `column MOD 0`, as shown here:

```
mysql> CREATE TABLE tn (c1 INT)
->     PARTITION BY LIST(1 DIV c1) (
->     PARTITION p0 VALUES IN (NULL),
->     PARTITION p1 VALUES IN (1)
-> );
Query OK, 0 rows affected (0.05 sec)
```

The default behavior for MySQL is to return `NULL` for the result of a division by zero, without producing any errors:

```
mysql> SELECT @@SQL_MODE;
+-----+
| @@SQL_MODE |
+-----+
|             |
+-----+
1 row in set (0.00 sec)

mysql> INSERT INTO tn VALUES (NULL), (0), (1);
Query OK, 3 rows affected (0.00 sec)
Records: 3 Duplicates: 0 Warnings: 0
```

However, changing the server SQL mode to treat division by zero as an error and to enforce strict error handling causes the same `INSERT` statement to fail, as shown here:

```
mysql> SET SQL_MODE='STRICT_ALL_TABLES,ERROR_FOR_DIVISION_BY_ZERO';
Query OK, 0 rows affected (0.00 sec)

mysql> INSERT INTO tn VALUES (NULL), (0), (1);
ERROR 1365 (22012): DIVISION BY 0
```

2. **Table accessibility.** Sometimes a change in the server SQL mode can make partitioned tables unusable. The following `CREATE TABLE` statement can be executed successfully only if the `NO_UNSIGNED_SUBTRACTION` mode is in effect:

```
mysql> SELECT @@SQL_MODE;
+-----+
| @@SQL_MODE |
+-----+
|             |
+-----+
1 row in set (0.00 sec)

mysql> CREATE TABLE tu (c1 BIGINT UNSIGNED)
->     PARTITION BY RANGE(c1 - 10) (
->     PARTITION p0 VALUES LESS THAN (-5),
->     PARTITION p1 VALUES LESS THAN (0),
->     PARTITION p2 VALUES LESS THAN (5),
->     PARTITION p3 VALUES LESS THAN (10),
->     PARTITION p4 VALUES LESS THAN (MAXVALUE)
-> );
ERROR 1563 (HY000): PARTITION CONSTANT IS OUT OF PARTITION FUNCTION DOMAIN

mysql> SET SQL_MODE='NO_UNSIGNED_SUBTRACTION';
Query OK, 0 rows affected (0.00 sec)

mysql> SELECT @@SQL_MODE;
+-----+
| @@SQL_MODE |
+-----+
```

```

| NO_UNSIGNED_SUBTRACTION |
+-----+
1 row in set (0.00 sec)

mysql> CREATE TABLE tu (c1 BIGINT UNSIGNED)
-> PARTITION BY RANGE(c1 - 10) (
-> PARTITION p0 VALUES LESS THAN (-5),
-> PARTITION p1 VALUES LESS THAN (0),
-> PARTITION p2 VALUES LESS THAN (5),
-> PARTITION p3 VALUES LESS THAN (10),
-> PARTITION p4 VALUES LESS THAN (MAXVALUE)
-> );
Query OK, 0 rows affected (0.05 sec)

```

If you remove the `NO_UNSIGNED_SUBTRACTION` server SQL mode after creating `tu`, you may no longer be able to access this table:

```

mysql> SET SQL_MODE='';
Query OK, 0 rows affected (0.00 sec)

mysql> SELECT * FROM tu;
ERROR 1563 (HY000): PARTITION CONSTANT IS OUT OF PARTITION FUNCTION DOMAIN
mysql> INSERT INTO tu VALUES (20);
ERROR 1563 (HY000): PARTITION CONSTANT IS OUT OF PARTITION FUNCTION DOMAIN

```

- **Performance considerations.**

- **File system operations.** Partitioning and repartitioning operations (such as `ALTER TABLE` with `PARTITION BY ...`, `REORGANIZE PARTITIONS`, or `REMOVE PARTITIONING`) depend on file system operations for their implementation. This means that the speed of these operations is affected by such factors as file system type and characteristics, disk speed, swap space, file handling efficiency of the operating system, and MySQL server options and variables that relate to file handling. In particular, you should make sure that `large_files_support` is enabled and that `open_files_limit` is set properly. For partitioned tables using the `MyISAM` storage engine, increasing `myisam_max_sort_file_size` may improve performance; partitioning and repartitioning operations involving `InnoDB` tables may be made more efficient by enabling `innodb_file_per_table`.
- **Table locks.** The process executing a partitioning operation on a table takes a write lock on the table. Reads from such tables are relatively unaffected; pending `INSERT` and `UPDATE` operations are performed as soon as the partitioning operation has completed.
- **Storage engine.** Partitioning operations, queries, and update operations generally tend to be faster with `MyISAM` tables than with `InnoDB` or `NDB` tables.
- **Use of indexes and partition pruning.** As with non-partitioned tables, proper use of indexes can speed up queries on partitioned tables significantly. In addition, designing partitioned tables and queries on these tables to take advantage of *partition pruning* can improve performance dramatically. See [Section 17.4, “Partition Pruning”](#), for more information.
- **Performance with `LOAD DATA`.** Prior to MySQL 5.1.23, `LOAD DATA` performed very poorly when importing into partitioned tables. The statement now uses buffering to improve performance; however, the buffer uses 130 KB memory per partition to achieve this. ([Bug#26527](#))

- **Maximum number of partitions.** The maximum number of partitions possible for a given table is 1024. This includes subpartitions.

If, when creating tables with a very large number of partitions (but which is less than the maximum stated previously), you encounter an error message such as `GOT ERROR 24 FROM STORAGE ENGINE`, this means that you may need to increase the value of the `open_files_limit` system variable. See [Section B.1.2.18, “‘FILE’ NOT FOUND and Similar Errors”](#).

- **Foreign keys not supported.** Partitioned tables do not support foreign keys. This means that:
  1. Definitions of tables employing user-defined partitioning may not contain foreign key references to other tables.
  2. No table definition may contain a foreign key reference to a partitioned table. The scope of these restrictions includes tables that use the `InnoDB` storage engine.
- **`ALTER TABLE ... ORDER BY`.** An `ALTER TABLE ... ORDER BY column` statement run against a partitioned table causes ordering of rows only within each partition.
- **FULLTEXT indexes.** Partitioned tables do not support `FULLTEXT` indexes. This includes partitioned tables employing the `MyISAM` storage engine.
- **Spatial columns.** Columns with spatial data types such as `POINT` or `GEOMETRY` cannot be used in partitioned tables.
- **Temporary tables.** As of MySQL 5.1.8, temporary tables cannot be partitioned. ([Bug#17497](#))

- **Log tables.** Beginning with MySQL 5.1.20, it is no longer possible to partition the log tables; beginning with that version, an `ALTER TABLE ... PARTITION BY ...` statement on such a table fails with an error. (Bug#27816)
- **Data type of partitioning key.** A partitioning key must be either an integer column or an expression that resolves to an integer. The column or expression value may also be `NULL`. (See Section 17.2.6, “How MySQL Partitioning Handles `NULL`”.)

The lone exception to this restriction occurs when partitioning by `[LINEAR] KEY`, where it is possible to use columns of other types as partitioning keys, because MySQL's internal key-hashing functions produce the correct data type from these types. For example, the following `CREATE TABLE` statement is valid:

```
CREATE TABLE tkc (c1 CHAR)
PARTITION BY KEY(c1)
PARTITIONS 4;
```

This exception does *not* apply to `BLOB` or `TEXT` column types.

- **Subqueries.** A partitioning key may not be a subquery, even if that subquery resolves to an integer value or `NULL`.
- **Subpartitions.** Subpartitions are limited to `HASH` or `KEY` partitioning. `HASH` and `KEY` partitions cannot be subpartitioned.
- **Key caches not supported.** Key caches are not supported for partitioned tables. The `CACHE INDEX INTO CACHE` statements, when you attempt to use them on tables having user-defined partitioning, fail with the errors `THE STORAGE ENGINE FOR THE TABLE DOESN'T SUPPORT ASSIGN_TO_KEYCACHE` and `THE STORAGE ENGINE FOR THE TABLE DOESN'T SUPPORT PRELOAD_KEYS`, respectively.
- **DELAYED option not supported.** Use of `INSERT DELAYED` to insert rows into a partitioned table is not supported. Beginning with MySQL 5.1.23, attempting to do so fails with an error. (Bug#31210)
- **DATA DIRECTORY and INDEX DIRECTORY options.** `DATA DIRECTORY` and `INDEX DIRECTORY` are subject to the following restrictions when used with partitioned tables:
  - Beginning with MySQL 5.1.23, table-level `DATA DIRECTORY` and `INDEX DIRECTORY` options are ignored. (Bug#32091)
  - On Windows, the `DATA DIRECTORY` and `INDEX DIRECTORY` options are not supported for individual partitions or subpartitions (Bug#30459).
- **Repairing and rebuilding partitioned tables.** The statements `CHECK TABLE`, `OPTIMIZE TABLE`, `ANALYZE TABLE`, and `REPAIR TABLE` are supported for partitioned tables beginning with MySQL 5.1.27. (See Bug#20129.) `mysqlcheck` and `myisamchk` are not supported with partitioned tables.

In addition, you can use `ALTER TABLE ... REBUILD PARTITION` to rebuild one or more partitions of a partitioned table; `ALTER TABLE ... REORGANIZE PARTITION` also causes partitions to be rebuilt. Both of these statements were added in MySQL 5.1.5. See Section 12.1.7, “`ALTER TABLE Syntax`”, for more information about these two statements.

## 17.5.1. Partitioning Keys, Primary Keys, and Unique Keys

This section discusses the relationship of partitioning keys with primary keys and unique keys. The rule governing this relationship can be expressed as follows: All columns used in the partitioning expression for a partitioned table must be part of every unique key that the table may have.

In other words, *every unique key on the table must use every column in the table's partitioning expression*. (This also includes the table's primary key, since it is by definition a unique key. This particular case is discussed later in this section.) For example, each of the following table creation statements is invalid:

```
CREATE TABLE t1 (
  col1 INT NOT NULL,
  col2 DATE NOT NULL,
  col3 INT NOT NULL,
  col4 INT NOT NULL,
  UNIQUE KEY (col1, col2)
)
PARTITION BY HASH(col3)
PARTITIONS 4;

CREATE TABLE t2 (
  col1 INT NOT NULL,
  col2 DATE NOT NULL,
  col3 INT NOT NULL,
  col4 INT NOT NULL,
  UNIQUE KEY (col1),
  UNIQUE KEY (col3)
)
PARTITION BY HASH(col1 + col3)
PARTITIONS 4;
```

In each case, the proposed table would have at least one unique key that does not include all columns used in the partitioning expression.

Each of the following statements is valid, and represents one way in which the corresponding invalid table creation statement could be made to work:

```
CREATE TABLE t1 (
  col1 INT NOT NULL,
  col2 DATE NOT NULL,
  col3 INT NOT NULL,
  col4 INT NOT NULL,
  UNIQUE KEY (col1, col2, col3)
)
PARTITION BY HASH(col3)
PARTITIONS 4;

CREATE TABLE t2 (
  col1 INT NOT NULL,
  col2 DATE NOT NULL,
  col3 INT NOT NULL,
  col4 INT NOT NULL,
  UNIQUE KEY (col1, col3)
)
PARTITION BY HASH(col1 + col3)
PARTITIONS 4;
```

This example shows the error produced in such cases:

```
mysql> CREATE TABLE t3 (
->   col1 INT NOT NULL,
->   col2 DATE NOT NULL,
->   col3 INT NOT NULL,
->   col4 INT NOT NULL,
->   UNIQUE KEY (col1, col2),
->   UNIQUE KEY (col3)
-> )
-> PARTITION BY HASH(col1 + col3)
-> PARTITIONS 4;
ERROR 1491 (HY000): A PRIMARY KEY MUST INCLUDE ALL COLUMNS IN THE TABLE'S PARTITIONING FUNCTION
```

The `CREATE` statement fails because both `col1` and `col3` are included in the proposed partitioning key, but neither of these columns is part of both of unique keys on the table. This shows one possible fix for the invalid table definition;

```
mysql> CREATE TABLE t3 (
->   col1 INT NOT NULL,
->   col2 DATE NOT NULL,
->   col3 INT NOT NULL,
->   col4 INT NOT NULL,
->   UNIQUE KEY (col1, col2, col3),
->   UNIQUE KEY (col3)
-> )
-> PARTITION BY HASH(col3)
-> PARTITIONS 4;
Query OK, 0 rows affected (0.05 sec)
```

In this case, the proposed partitioning key `col3` is part of both unique keys, and the table creation statement succeeds.

Since every primary key is by definition a unique key, this restriction also includes the table's primary key, if it has one. For example, the next two statements are invalid:

```
CREATE TABLE t4 (
  col1 INT NOT NULL,
  col2 DATE NOT NULL,
  col3 INT NOT NULL,
  col4 INT NOT NULL,
  PRIMARY KEY(col1, col2)
)
PARTITION BY HASH(col3)
PARTITIONS 4;

CREATE TABLE t5 (
  col1 INT NOT NULL,
  col2 DATE NOT NULL,
  col3 INT NOT NULL,
  col4 INT NOT NULL,
  PRIMARY KEY(col1, col3),
  UNIQUE KEY(col2)
)
PARTITION BY HASH( YEAR(col2) )
PARTITIONS 4;
```

In both cases, the primary key does not include all columns referenced in the partitioning expression. However, both of the next two statements are valid:

```
CREATE TABLE t6 (
```

```

    col1 INT NOT NULL,
    col2 DATE NOT NULL,
    col3 INT NOT NULL,
    col4 INT NOT NULL,
    PRIMARY KEY(col1, col2)
)
PARTITION BY HASH(col1 + YEAR(col2))
PARTITIONS 4;

CREATE TABLE t7 (
    col1 INT NOT NULL,
    col2 DATE NOT NULL,
    col3 INT NOT NULL,
    col4 INT NOT NULL,
    PRIMARY KEY(col1, col2, col4),
    UNIQUE KEY(col2, col1)
)
PARTITION BY HASH(col1 + YEAR(col2))
PARTITIONS 4;

```

If a table has no unique keys — this includes having no primary key — then this restriction does not apply, and you may use any column or columns in the partitioning expression as long as the column type is compatible with the partitioning type.

For the same reason, you cannot later add a unique key to a partitioned table unless the key includes all columns used by the table's partitioning expression. Consider given the partitioned table defined as shown here:

```

mysql> CREATE TABLE t_no_pk (c1 INT, c2 INT)
->     PARTITION BY RANGE(c1) (
->         PARTITION p0 VALUES LESS THAN (10),
->         PARTITION p1 VALUES LESS THAN (20),
->         PARTITION p2 VALUES LESS THAN (30),
->         PARTITION p3 VALUES LESS THAN (40)
->     );
Query OK, 0 rows affected (0.12 sec)

```

It is possible to add a primary key to `t_no_pk` using either of these `ALTER TABLE` statements:

```

# possible PK
mysql> ALTER TABLE t_no_pk ADD PRIMARY KEY(c1);
Query OK, 0 rows affected (0.13 sec)
Records: 0 Duplicates: 0 Warnings: 0

# drop this PK
mysql> ALTER TABLE t_no_pk DROP PRIMARY KEY;
Query OK, 0 rows affected (0.10 sec)
Records: 0 Duplicates: 0 Warnings: 0

# use another possible PK
mysql> ALTER TABLE t_no_pk ADD PRIMARY KEY(c1, c2);
Query OK, 0 rows affected (0.12 sec)
Records: 0 Duplicates: 0 Warnings: 0

# drop this PK
mysql> ALTER TABLE t_no_pk DROP PRIMARY KEY;
Query OK, 0 rows affected (0.09 sec)
Records: 0 Duplicates: 0 Warnings: 0

```

However, the next statement fails, because `c1` is part of the partitioning key, but is not part of the proposed primary key:

```

# fails with error 1503
mysql> ALTER TABLE t_no_pk ADD PRIMARY KEY(c2);
ERROR 1503 (HY000): A PRIMARY KEY MUST INCLUDE ALL COLUMNS IN THE TABLE'S PARTITIONING FUNCTION

```

Since `t_no_pk` has only `c1` in its partitioning expression, attempting to adding a unique key on `c2` alone fails. However, you can add a unique key that uses both `c1` and `c2`.

These rules also apply to existing non-partitioned tables that you wish to partition using `ALTER TABLE ... PARTITION BY`. Consider a table `np_pk` defined as shown here:

```

mysql> CREATE TABLE np_pk (
->     id INT NOT NULL AUTO_INCREMENT,
->     name VARCHAR(50),
->     added DATE,
->     PRIMARY KEY (id)
-> );
Query OK, 0 rows affected (0.08 sec)

```

The following `ALTER TABLE` statements fails with an error, because the `added` column is not part of any unique key in the table:

```

mysql> ALTER TABLE np_pk
->     PARTITION BY HASH( TO_DAYS(added) )
->     PARTITIONS 4;
ERROR 1503 (HY000): A PRIMARY KEY MUST INCLUDE ALL COLUMNS IN THE TABLE'S PARTITIONING FUNCTION

```

However, this statement using the `id` column for the partitioning column is valid, as shown here:

```
mysql> ALTER TABLE np_pk
-> PARTITION BY HASH(id)
-> PARTITIONS 4;
Query OK, 0 rows affected (0.11 sec)
Records: 0 Duplicates: 0 Warnings: 0
```

In the case of `np_pk`, the only column that may be used as part of a partitioning expression is `id`; if you wish to partition this table using any other column or columns in the partitioning expression, you must first modify the table, either by adding the desired column or columns to the primary key, or by dropping the primary key altogether.

We are working to remove this limitation in a future MySQL release series.

## 17.5.2. Partitioning Limitations Relating to Storage Engines

The following limitations apply to the use of storage engines with user-defined partitioning of tables.

**MERGE storage engine.** User-defined partitioning and the `MERGE` storage engine are not compatible. Tables using the `MERGE` storage engine cannot be partitioned. Partitioned tables cannot be merged.

**FEDERATED storage engine.** Partitioning of `FEDERATED` tables is not supported. Beginning with MySQL 5.1.15, it is not possible to create partitioned `FEDERATED` tables at all. We are working to remove this limitation in a future MySQL release.

**CSV storage engine.** Partitioned tables using the `CSV` storage engine are not supported. Starting with MySQL 5.1.12, it is not possible to create partitioned `CSV` tables at all.

**BLACKHOLE storage engine.** Prior to MySQL 5.1.6, tables using the `BLACKHOLE` storage engine also could not be partitioned.

**NDBCLUSTER storage engine (MySQL Cluster).** Partitioning by `KEY` (or `LINEAR KEY`) is the only type of partitioning supported for the `NDBCLUSTER` storage engine. Beginning with MySQL 5.1.12, it is not possible to create a MySQL Cluster table using any partitioning type other than `[LINEAR] KEY`, and attempting to do so fails with an error.

In addition, the maximum number of partitions that can be defined for an `NDBCLUSTER` table is 8 times the number of node groups in the cluster. (See [MySQL Cluster Nodes, Node Groups, Replicas, and Partitions](#), for more information about node groups in MySQL Cluster.)

Beginning with MySQL Cluster NDB 6.2.18, MySQL Cluster NDB 6.3.25, and MySQL Cluster NDB 7.0.6, `CREATE TABLE` and `ALTER TABLE` statements that would cause a user-partitioned `NDBCLUSTER` table not to meet either or both of the following two requirements are disallowed, and fail with an error ([Bug#40709](#)):

1. The table must have an explicit primary key.
2. All columns listed in the table's partitioning expression must be part of the primary key.

**Exception.** If a user-partitioned `NDBCLUSTER` table is created using an empty column-list (that is, using `PARTITION BY KEY()` or `PARTITION BY LINEAR KEY()`), then no explicit primary key is required.

**Upgrading partitioned tables.** When performing an upgrade, tables which are partitioned by `KEY` and which use any storage engine other than `NDBCLUSTER` must be dumped and reloaded.

**Same storage engine for all partitions.** All partitions of a partitioned table must use the same storage engine and it must be the same storage engine used by the table as a whole. In addition, if one does not specify an engine on the table level, then one must do either of the following when creating or altering a partitioned table:

- Do *not* specify any engine for *any* partition or subpartition
- Specify the engine for *all* partitions or subpartitions

We are working to remove this limitation in a future MySQL release.

## 17.5.3. Partitioning Limitations Relating to Functions

This section discusses limitations in MySQL Partitioning relating specifically to functions used in partitioning expressions.

Beginning with MySQL 5.1.12, only the following MySQL functions are supported in partitioning expressions:

- `ABS()`
- `CEILING()` (see *CEILING()* and *FLOOR()*, immediately following this list)
- `DAY()`
- `DAYOFMONTH()`
- `DAYOFWEEK()`
- `DAYOFYEAR()`
- `DATEDIFF()`
- `EXTRACT()`
- `FLOOR()` (see *CEILING()* and *FLOOR()*, immediately following this list)
- `HOUR()`
- `MICROSECOND()`
- `MINUTE()`
- `MOD()`
- `MONTH()`
- `QUARTER()`
- `SECOND()`
- `TIME_TO_SEC()`
- `TO_DAYS()`
- `WEEKDAY()`
- `YEAR()`
- `YEARWEEK()`

**Note**

**CEILING()** and **FLOOR()**. Each of these functions returns an integer only if it is passed an integer argument. This means, for example, that the following `CREATE TABLE` statement fails with an error, as shown here:

```
mysql> CREATE TABLE t (c FLOAT) PARTITION BY LIST( FLOOR(c) )(
->     PARTITION p0 VALUES IN (1,3,5),
->     PARTITION p1 VALUES IN (2,4,6)
-> );
ERROR 1490 (HY000): THE PARTITION FUNCTION RETURNS THE WRONG TYPE
```

See [Section 11.5.2, “Mathematical Functions”](#), for more information about the return types of these functions.

---

# Chapter 18. Stored Programs and Views

This chapter discusses stored programs and views, which are database objects defined in terms of SQL code that is stored on the server for later invocation.

Stored programs include these objects:

- Stored routines, that is, stored procedures and functions. A stored function is used much like a built-in function. you invoke it in an expression and it returns a value during expression evaluation. A stored procedure is invoked using the `CALL` statement. A procedure does not have a return value but can modify its parameters for later inspection by the caller. It can also generate result sets to be returned to the client program.
- Triggers. A trigger is a named database object that is associated with a table and that is activated when a particular event occurs for the table, such as an insert or update.
- Events. An event is a task that runs according to schedule.

Views are stored queries that when invoked produce a result set. A view acts as a virtual table.

This chapter describes how to use each type of stored program and views. Additional information about SQL syntax for statements related to these objects is available in the following locations:

- For each object type, there are `CREATE`, `ALTER`, and `DROP` statements that control which objects exist and how they are defined. See [Section 12.1, “Data Definition Statements”](#).
- The `CALL` statement is used to invoke stored procedures. See [Section 12.2.1, “CALL Syntax”](#).
- Stored program definitions contain a body that may use compound statements, loops, conditionals, and declared variables. See [Section 12.8, “MySQL Compound-Statement Syntax”](#).

## 18.1. Defining Stored Programs

Each stored program contains a body that consists of an SQL statement. This statement may be a compound statement made up of several statements separated by semicolon (`;`) characters. For example, the following stored procedure has a body made up of a `BEGIN ... END` block that contains a `SET` statement and a `REPEAT` loop that itself contains another `SET` statement:

```
CREATE PROCEDURE dorepeat(p1 INT)
BEGIN
  SET @x = 0;
  REPEAT SET @x = @x + 1; UNTIL @x > p1 END REPEAT;
END
```

If you use the `mysql` client program to define a stored program that contains the semicolon characters within its definition, a problem arises. By default, `mysql` itself recognizes semicolon as a statement delimiter, so you must redefine the delimiter temporarily to cause `mysql` to pass the entire stored program definition to the server.

To redefine the `mysql` delimiter, use the `delimiter` command. The following example shows how to do this for the `dorepeat()` procedure just shown. The delimiter is changed to `//` to enable the entire definition to be passed to the server as a single statement, and then restored to `;` before invoking the procedure. This allows the `;` delimiter used in the procedure body to be passed through to the server rather than being interpreted by `mysql` itself.

```
mysql> delimiter //
mysql> CREATE PROCEDURE dorepeat(p1 INT)
-> BEGIN
->   SET @x = 0;
->   REPEAT SET @x = @x + 1; UNTIL @x > p1 END REPEAT;
-> END
-> //
Query OK, 0 rows affected (0.00 sec)

mysql> delimiter ;
mysql> CALL dorepeat(1000);
Query OK, 0 rows affected (0.00 sec)

mysql> SELECT @x;
+-----+
| @x    |
+-----+
| 1001  |
+-----+
```



```
1 row in set (0.00 sec)
```

You can redefine the delimiter to a string other than `//`, and the delimiter can consist of a single character or multiple characters. You should avoid the use of the backslash (“\”) character because that is the escape character for MySQL.

The following is an example of a function that takes a parameter, performs an operation using an SQL function, and returns the result. In this case, it is unnecessary to use `delimiter` because the function definition contains no internal `;` statement delimiters:

```
mysql> CREATE FUNCTION hello (s CHAR(20))
mysql> RETURNS CHAR(50) DETERMINISTIC
-> RETURN CONCAT('Hello, ',s,'!');
Query OK, 0 rows affected (0.00 sec)

mysql> SELECT hello('world');
+-----+
| hello('world') |
+-----+
| Hello, world!  |
+-----+
1 row in set (0.00 sec)
```

## 18.2. Using Stored Routines (Procedures and Functions)

Stored routines (procedures and functions) are supported in MySQL 5.1. A stored routine is a set of SQL statements that can be stored in the server. Once this has been done, clients don't need to keep reissuing the individual statements but can refer to the stored routine instead.

Stored routines require the `proc` table in the `mysql` database. This table is created during the MySQL 5.1 installation procedure. If you are upgrading to MySQL 5.1 from an earlier version, be sure to update your grant tables to make sure that the `proc` table exists. See [Section 4.4.8, “mysql\\_upgrade — Check Tables for MySQL Upgrade”](#).

### MySQL Enterprise

For expert advice on using stored procedures and functions subscribe to the MySQL Enterprise Monitor. For more information, see <http://www.mysql.com/products/enterprise/advisors.html>.

Stored routines can be particularly useful in certain situations:

- When multiple client applications are written in different languages or work on different platforms, but need to perform the same database operations.
- When security is paramount. Banks, for example, use stored procedures and functions for all common operations. This provides a consistent and secure environment, and routines can ensure that each operation is properly logged. In such a setup, applications and users would have no access to the database tables directly, but can only execute specific stored routines.

Stored routines can provide improved performance because less information needs to be sent between the server and the client. The tradeoff is that this does increase the load on the database server because more of the work is done on the server side and less is done on the client (application) side. Consider this if many client machines (such as Web servers) are serviced by only one or a few database servers.

Stored routines also allow you to have libraries of functions in the database server. This is a feature shared by modern application languages that allow such design internally (for example, by using classes). Using these client application language features is beneficial for the programmer even outside the scope of database use.

MySQL follows the SQL:2003 syntax for stored routines, which is also used by IBM's DB2.

The MySQL implementation of stored routines is still in progress. All syntax described here is supported and any limitations and extensions are documented where appropriate.

### Additional resources

- You may find the [Stored Procedures User Forum](#) of use when working with stored procedures and functions.
- For answers to some commonly asked questions regarding stored routines in MySQL, see [Section A.4, “MySQL 5.1 FAQ — Stored Procedures and Functions”](#).
- There are some restrictions on the use of stored routines. See [Section D.1, “Restrictions on Stored Routines, Triggers, and Events”](#).
- Binary logging for stored routines takes place as described in [Section 18.6, “Binary Logging of Stored Programs”](#).

## 18.2.1. Stored Routine Syntax

A stored routine is either a procedure or a function. Stored routines are created with the `CREATE PROCEDURE` and `CREATE FUNCTION` statements (see Section 12.1.15, “`CREATE PROCEDURE` and `CREATE FUNCTION` Syntax”). A procedure is invoked using a `CALL` statement (see Section 12.2.1, “`CALL` Syntax”), and can only pass back values using output variables. A function can be called from inside a statement just like any other function (that is, by invoking the function’s name), and can return a scalar value. The body of a stored routine can use compound statements (see Section 12.8, “`MySQL Compound-Statement Syntax`”).

Stored routines can be dropped with the `DROP PROCEDURE` and `DROP FUNCTION` statements (see Section 12.1.26, “`DROP PROCEDURE` and `DROP FUNCTION` Syntax”), and altered with the `ALTER PROCEDURE` and `ALTER FUNCTION` statements (see Section 12.1.5, “`ALTER PROCEDURE` Syntax”).

A stored procedure or function is associated with a particular database. This has several implications:

- When the routine is invoked, an implicit `USE db_name` is performed (and undone when the routine terminates). `USE` statements within stored routines are disallowed.
- You can qualify routine names with the database name. This can be used to refer to a routine that is not in the current database. For example, to invoke a stored procedure `p` or function `f` that is associated with the `test` database, you can say `CALL test.p()` or `test.f()`.
- When a database is dropped, all stored routines associated with it are dropped as well.

Stored functions cannot be recursive.

Recursion in stored procedures is allowed but disabled by default. To enable recursion, set the `max_sp_recursion_depth` server system variable to a value greater than zero. Stored procedure recursion increases the demand on thread stack space. If you increase the value of `max_sp_recursion_depth`, it may be necessary to increase thread stack size by increasing the value of `thread_stack` at server startup. See Section 5.1.3, “`Server System Variables`”, for more information.

MySQL supports the very useful extension that allows the use of regular `SELECT` statements (that is, without using cursors or local variables) inside a stored procedure. The result set of such a query is simply sent directly to the client. Multiple `SELECT` statements generate multiple result sets, so the client must use a MySQL client library that supports multiple result sets. This means the client must use a client library from a version of MySQL at least as recent as 4.1. The client should also specify the `CLIENT_MULTI_RESULTS` option when it connects. For C programs, this can be done with the `mysql_real_connect()` C API function. See Section 20.10.3.52, “`mysql_real_connect()`”, and Section 20.10.12, “`C API Support for Multiple Statement Execution`”.

### MySQL Enterprise

MySQL Enterprise subscribers will find numerous articles about stored routines in the MySQL Enterprise Knowledge Base. Access to this collection of articles is one of the advantages of subscribing to MySQL Enterprise. For more information, see <http://www.mysql.com/products/enterprise/advisors.html>.

## 18.2.2. Stored Routines and MySQL Privileges

The MySQL grant system takes stored routines into account as follows:

- The `CREATE ROUTINE` privilege is needed to create stored routines.
- The `ALTER ROUTINE` privilege is needed to alter or drop stored routines. This privilege is granted automatically to the creator of a routine if necessary, and dropped when the routine creator drops the routine.
- The `EXECUTE` privilege is required to execute stored routines. However, this privilege is granted automatically to the creator of a routine if necessary (and dropped when the creator drops the routine). Also, the default `SQL SECURITY` characteristic for a routine is `DEFINER`, which enables users who have access to the database with which the routine is associated to execute the routine.
- If the `automatic_sp_privileges` system variable is 0, the `EXECUTE` and `ALTER ROUTINE` privileges are not automatically granted and dropped.

The server manipulates the `mysql.proc` table in response to statements that create, alter, or drop stored routines. It is not supported that the server will notice manual manipulation of this table.

## 18.2.3. Stored Routine Metadata

Metadata about stored routines can be obtained as follows:

- Query the `ROUTINES` table of the `INFORMATION_SCHEMA` database. See [Section 19.14, “The INFORMATION\\_SCHEMA ROUTINES Table”](#).
- Use the `SHOW CREATE PROCEDURE` and `SHOW CREATE FUNCTION` statements to see routine definitions. See [Section 12.5.5.11, “SHOW CREATE PROCEDURE Syntax”](#).
- Use the `SHOW PROCEDURE STATUS` and `SHOW FUNCTION STATUS` statements to see routine characteristics. See [Section 12.5.5.30, “SHOW PROCEDURE STATUS Syntax”](#).
- `INFORMATION_SCHEMA` does not have a `PARAMETERS` table until MySQL 6.0, so applications that need to acquire routine parameter information at runtime must use workarounds such as parsing the output of `SHOW CREATE` statements or the `param_list` column of the `mysql.proc` table. `param_list` contents can be processed from within a stored routine, unlike the output from `SHOW`.

### 18.2.4. Stored Procedures, Functions, Triggers, and `LAST_INSERT_ID()`

Within the body of a stored routine (procedure or function) or a trigger, the value of `LAST_INSERT_ID()` changes the same way as for statements executed outside the body of these kinds of objects (see [Section 11.11.3, “Information Functions”](#)). The effect of a stored routine or trigger upon the value of `LAST_INSERT_ID()` that is seen by following statements depends on the kind of routine:

- If a stored procedure executes statements that change the value of `LAST_INSERT_ID()`, the changed value is seen by statements that follow the procedure call.
- For stored functions and triggers that change the value, the value is restored when the function or trigger ends, so following statements do not see a changed value.

## 18.3. Using Triggers

A trigger is a named database object that is associated with a table, and that activates when a particular event occurs for the table. Some uses for triggers are to perform checks of values to be inserted into a table or to perform calculations on values involved in an update.

A trigger is defined to activate when an `INSERT`, `DELETE`, or `UPDATE` statement executes for the associated table. A trigger can be set to activate either before or after the triggering statement. For example, you can have a trigger activate before each row that is inserted into a table or after each row that is updated.

### Important

MySQL triggers are activated by SQL statements *only*. They are not activated by changes in tables made by APIs that do not transmit SQL statements to the MySQL Server; in particular, they are not activated by updates made using the `NDB` API.

To use triggers if you have upgraded to MySQL 5.1 from an older release that did not support triggers, you should upgrade your grant tables so that they contain the trigger-related privileges. See [Section 4.4.8, “mysql\\_upgrade — Check Tables for MySQL Upgrade”](#).

The following discussion describes the syntax for creating and dropping triggers, and shows some examples of how to use them.

#### Additional resources

- You may find the [Triggers User Forum](#) of use when working with views.
- For answers to some commonly asked questions regarding triggers in MySQL, see [Section A.5, “MySQL 5.1 FAQ — Triggers”](#).
- There are some restrictions on the use of triggers; see [Section D.1, “Restrictions on Stored Routines, Triggers, and Events”](#).
- Binary logging for triggers takes place as described in [Section 18.6, “Binary Logging of Stored Programs”](#).

### 18.3.1. Trigger Syntax

To create a trigger or drop a trigger, use the `CREATE TRIGGER` or `DROP TRIGGER` statement. The syntax for these statements is described in [Section 12.1.19, “CREATE TRIGGER Syntax”](#), and [Section 12.1.30, “DROP TRIGGER Syntax”](#).

Here is a simple example that associates a trigger with a table for `INSERT` statements. The trigger acts as an accumulator, summing the values inserted into one of the columns of the table.

```
mysql> CREATE TABLE account (acct_num INT, amount DECIMAL(10,2));
Query OK, 0 rows affected (0.03 sec)

mysql> CREATE TRIGGER ins_sum BEFORE INSERT ON account
-> FOR EACH ROW SET @sum = @sum + NEW.amount;
Query OK, 0 rows affected (0.06 sec)
```

The `CREATE TRIGGER` statement creates a trigger named `ins_sum` that is associated with the `account` table. It also includes clauses that specify the trigger activation time, the triggering event, and what to do with the trigger activates:

- The keyword `BEFORE` indicates the trigger action time. In this case, the trigger should activate before each row inserted into the table. The other allowable keyword here is `AFTER`.
- The keyword `INSERT` indicates the event that activates the trigger. In the example, `INSERT` statements cause trigger activation. You can also create triggers for `DELETE` and `UPDATE` statements.
- The statement following `FOR EACH ROW` defines the statement to execute each time the trigger activates, which occurs once for each row affected by the triggering statement. In the example, the triggered statement is a simple `SET` that accumulates the values inserted into the `amount` column. The statement refers to the column as `NEW.amount` which means “the value of the `amount` column to be inserted into the new row.”

To use the trigger, set the accumulator variable to zero, execute an `INSERT` statement, and then see what value the variable has afterward:

```
mysql> SET @sum = 0;
mysql> INSERT INTO account VALUES(137,14.98),(141,1937.50),(97,-100.00);
mysql> SELECT @sum AS 'Total amount inserted';
+-----+
| Total amount inserted |
+-----+
| 1852.48                |
+-----+
```

In this case, the value of `@sum` after the `INSERT` statement has executed is  $14.98 + 1937.50 - 100$ , or `1852.48`.

To destroy the trigger, use a `DROP TRIGGER` statement. You must specify the schema name if the trigger is not in the default schema:

```
mysql> DROP TRIGGER test.ins_sum;
```

Triggers for a table are also dropped if you drop the table.

Trigger names exist in the schema namespace, meaning that all triggers must have unique names within a schema. Triggers in different schemas can have the same name.

In addition to the requirement that trigger names be unique for a schema, there are other limitations on the types of triggers you can create. In particular, you cannot have two triggers for a table that have the same activation time and activation event. For example, you cannot define two `BEFORE INSERT` triggers or two `AFTER UPDATE` triggers for a table. This should rarely be a significant limitation, because it is possible to define a trigger that executes multiple statements by using the `BEGIN . . . END` compound statement construct after `FOR EACH ROW`. (An example appears later in this section.)

The `OLD` and `NEW` keywords enable you to access columns in the rows affected by a trigger. (`OLD` and `NEW` are not case sensitive.) In an `INSERT` trigger, only `NEW.col_name` can be used; there is no old row. In a `DELETE` trigger, only `OLD.col_name` can be used; there is no new row. In an `UPDATE` trigger, you can use `OLD.col_name` to refer to the columns of a row before it is updated and `NEW.col_name` to refer to the columns of the row after it is updated.

A column named with `OLD` is read only. You can refer to it (if you have the `SELECT` privilege), but not modify it. A column named with `NEW` can be referred to if you have the `SELECT` privilege for it. In a `BEFORE` trigger, you can also change its value with `SET NEW.col_name = value` if you have the `UPDATE` privilege for it. This means you can use a trigger to modify the values to be inserted into a new row or that are used to update a row.

In a `BEFORE` trigger, the `NEW` value for an `AUTO_INCREMENT` column is 0, not the automatically generated sequence number that will be generated when the new record actually is inserted.

`OLD` and `NEW` are MySQL extensions to triggers.

By using the `BEGIN . . . END` construct, you can define a trigger that executes multiple statements. Within the `BEGIN` block, you also can use other syntax that is allowed within stored routines such as conditionals and loops. However, just as for stored

routines, if you use the `mysql` program to define a trigger that executes multiple statements, it is necessary to redefine the `mysql` statement delimiter so that you can use the `;` statement delimiter within the trigger definition. The following example illustrates these points. It defines an `UPDATE` trigger that checks the new value to be used for updating each row, and modifies the value to be within the range from 0 to 100. This must be a `BEFORE` trigger because the value needs to be checked before it is used to update the row:

```
mysql> delimiter //
mysql> CREATE TRIGGER upd_check BEFORE UPDATE ON account
-> FOR EACH ROW
-> BEGIN
->     IF NEW.amount < 0 THEN
->         SET NEW.amount = 0;
->     ELSEIF NEW.amount > 100 THEN
->         SET NEW.amount = 100;
->     END IF;
-> END; //
mysql> delimiter ;
```

It can be easier to define a stored procedure separately and then invoke it from the trigger using a simple `CALL` statement. This is also advantageous if you want to invoke the same routine from within several triggers.

There are some limitations on what can appear in statements that a trigger executes when activated:

- The trigger cannot use the `CALL` statement to invoke stored procedures that return data to the client or that use dynamic SQL. (Stored procedures are allowed to return data to the trigger through `OUT` or `INOUT` parameters.)
- The trigger cannot use statements that explicitly or implicitly begin or end a transaction such as `START TRANSACTION`, `COMMIT`, or `ROLLBACK`.

MySQL handles errors during trigger execution as follows:

- If a `BEFORE` trigger fails, the operation on the corresponding row is not performed.
- A `BEFORE` trigger is activated by the *attempt* to insert or modify the row, regardless of whether the attempt subsequently succeeds.
- An `AFTER` trigger is executed only if the `BEFORE` trigger (if any) and the row operation both execute successfully.
- An error during either a `BEFORE` or `AFTER` trigger results in failure of the entire statement that caused trigger invocation.
- For transactional tables, failure of a statement should cause rollback of all changes performed by the statement. Failure of a trigger causes the statement to fail, so trigger failure also causes rollback. For non-transactional tables, such rollback cannot be done, so although the statement fails, any changes performed prior to the point of the error remain in effect.

## 18.3.2. Trigger Metadata

Metadata about triggers can be obtained as follows:

- Query the `TRIGGERS` table of the `INFORMATION_SCHEMA` database. See [Section 19.16, “The INFORMATION\\_SCHEMA TRIGGERS Table”](#).
- Use the `SHOW TRIGGERS` statement. See [Section 12.5.5.40, “SHOW TRIGGERS Syntax”](#).

## 18.4. Using the Event Scheduler

The *MySQL Event Scheduler* manages the scheduling and execution of events: Tasks that run according to schedule. Event support was added in MySQL 5.1.6. The following discussion covers the Event Scheduler and is divided into the following sections:

- [Section 18.4.1, “Event Scheduler Overview”](#), provides an introduction to and conceptual overview of MySQL Events.
- [Section 18.4.3, “Event Syntax”](#), discusses the SQL statements for creating, altering, and dropping MySQL Events.
- [Section 18.4.4, “Event Metadata”](#), shows how to obtain information about events and how this information is stored by the MySQL Server.
- [Section 18.4.6, “The Event Scheduler and MySQL Privileges”](#), discusses the privileges required to work with events and the

ramifications that events have with regard to privileges when executing.

Stored routines require the `event` table in the `mysql` database. This table is created during the MySQL 5.1 installation procedure. If you are upgrading to MySQL 5.1 from an earlier version, be sure to update your grant tables to make sure that the `event` table exists. See [Section 4.4.8, “mysql\\_upgrade — Check Tables for MySQL Upgrade”](#).

#### Additional resources

- You may find the [MySQL Event Scheduler User Forum](#) of use when working with scheduled events.
- There are some restrictions on the use of events; see [Section D.1, “Restrictions on Stored Routines, Triggers, and Events”](#).
- Binary logging for events takes place as described in [Section 18.6, “Binary Logging of Stored Programs”](#).

## 18.4.1. Event Scheduler Overview

MySQL Events are tasks that run according to a schedule. Therefore, we sometimes refer to them as *scheduled* events. When you create an event, you are creating a named database object containing one or more SQL statements to be executed at one or more regular intervals, beginning and ending at a specific date and time. Conceptually, this is similar to the idea of the Unix `crontab` (also known as a “cron job”) or the Windows Task Scheduler.

Scheduled tasks of this type are also sometimes known as “temporal triggers”, implying that these are objects that are triggered by the passage of time. While this is essentially correct, we prefer to use the term *events* in order to avoid confusion with triggers of the type discussed in [Section 18.3, “Using Triggers”](#). Events should more specifically not be confused with “temporary triggers”. Whereas a trigger is a database object whose statements are executed in response to a specific type of event that occurs on a given table, a (scheduled) event is an object whose statements are executed in response to the passage of a specified time interval.

While there is no provision in the SQL Standard for event scheduling, there are precedents in other database systems, and you may notice some similarities between these implementations and that found in the MySQL Server.

MySQL Events have the following major features and properties:

- In MySQL 5.1.12 and later, an event is uniquely identified by its name and the schema to which it is assigned. (Previously, an event was also unique to its definer.)
- An event performs a specific action according to a schedule. This action consists of an SQL statement, which can be a compound statement in a `BEGIN . . . END` block if desired (see [Section 12.8, “MySQL Compound-Statement Syntax”](#)). An event's timing can be either *one-time* or *recurrent*. A one-time event executes one time only. A recurrent event repeats its action at a regular interval, and the schedule for a recurring event can be assigned a specific start day and time, end day and time, both, or neither. (By default, a recurring event's schedule begins as soon as it is created, and continues indefinitely, until it is disabled or dropped.)

If a repeating event does not terminate within its scheduling interval, the result may be multiple instances of the event executing simultaneously. If this is undesirable, you should institute a mechanism to prevent simultaneous instances. For example, you could use the `GET_LOCK( )` function, or row or table locking.

- Users can create, modify, and drop scheduled events using SQL statements intended for these purposes. Syntactically invalid event creation and modification statements fail with an appropriate error message. *A user may include statements in an event's action which require privileges that the user does not actually have.* The event creation or modification statement succeeds but the event's action fails. See [Section 18.4.6, “The Event Scheduler and MySQL Privileges”](#) for details.
- Many of the properties of an event can be set or modified using SQL statements. These properties include the event's name, timing, persistence (that is, whether it is preserved following the expiration of its schedule), status (enabled or disabled), action to be performed, and the schema to which it is assigned. See [Section 12.1.2, “ALTER EVENT Syntax”](#).

The default definer of an event is the user who created the event, unless the event has been altered, in which case the definer is the user who issued the last `ALTER EVENT` statement affecting that event. An event can be modified by any user having the `EVENT` privilege on the database for which the event is defined. (Prior to MySQL 5.1.12, only an event's definer, or a user having privileges on the `mysql.event` table, could modify a given event.) See [Section 18.4.6, “The Event Scheduler and MySQL Privileges”](#).

- An event's action statement may include most SQL statements permitted within stored routines. For restrictions, see [Section D.1, “Restrictions on Stored Routines, Triggers, and Events”](#).

## 18.4.2. Event Scheduler Configuration



Events are executed by a special *event scheduler thread*; when we refer to the Event Scheduler, we actually refer to this thread. When running, the event scheduler thread and its current state can be seen by users having the `PROCESS` privilege in the output of `SHOW PROCESSLIST`, as shown in the discussion that follows.

The global `event_scheduler` system variable determines whether the Event Scheduler is enabled and running on the server. Beginning with MySQL 5.1.12, it has one of these 3 values, which affect event scheduling as described here:

- **OFF**: The Event Scheduler is stopped. The event scheduler thread does not run, is not shown in the output of `SHOW PROCESSLIST`, and no scheduled events are executed. **OFF** is the default value for `event_scheduler`.

When the Event Scheduler is stopped (`event_scheduler` is **OFF**), it can be started by setting the value of `event_scheduler` to **ON**. (See next item.)

- **ON**: The Event Scheduler is started; the event scheduler thread runs and executes all scheduled events.

When the Event Scheduler is **ON**, the event scheduler thread is listed in the output of `SHOW PROCESSLIST` as a daemon process, and its state is represented as shown here:

```
mysql> SHOW PROCESSLIST\G
***** 1. row *****
  Id: 1
  User: root
  Host: localhost
  db: NULL
  Command: Query
  Time: 0
  State: NULL
  Info: show processlist
***** 2. row *****
  Id: 2
  User: event_scheduler
  Host: localhost
  db: NULL
  Command: Daemon
  Time: 3
  State: Waiting for next activation
  Info: NULL
2 rows in set (0.00 sec)
```

Event scheduling can be stopped by setting the value of `event_scheduler` to **OFF**.

- **DISABLED**: This value renders the Event Scheduler non-operational. When the Event Scheduler is **DISABLED**, the event scheduler thread does not run (and so does not appear in the output of `SHOW PROCESSLIST`). In addition, the Event Scheduler state cannot be changed at runtime.

If the Event Scheduler status has not been set to **DISABLED**, `event_scheduler` can be toggled between **ON** and **OFF** (using `SET`). It is also possible to use `0` for **OFF**, and `1` for **ON** when setting this variable. Thus, any of the following 4 statements can be used in the `mysql` client to turn on the Event Scheduler:

```
SET GLOBAL event_scheduler = ON;
SET @@global.event_scheduler = ON;
SET GLOBAL event_scheduler = 1;
SET @@global.event_scheduler = 1;
```

Similarly, any of these 4 statements can be used to turn off the Event Scheduler:

```
SET GLOBAL event_scheduler = OFF;
SET @@global.event_scheduler = OFF;
SET GLOBAL event_scheduler = 0;
SET @@global.event_scheduler = 0;
```

Although **ON** and **OFF** have numeric equivalents, the value displayed for `event_scheduler` by `SELECT` or `SHOW VARIABLES` is always one of **OFF**, **ON**, or **DISABLED**. *DISABLED has no numeric equivalent*. For this reason, **ON** and **OFF** are usually preferred over `1` and `0` when setting this variable.

Note that attempting to set `event_scheduler` without specifying it as a global variable causes an error:

```
mysql< SET @@event_scheduler = OFF;
ERROR 1229 (HY000): VARIABLE 'EVENT_SCHEDULER' IS A GLOBAL
VARIABLE AND SHOULD BE SET WITH SET GLOBAL
```

## Important

It is possible to set the Event Scheduler to **DISABLED** only at server startup. If `event_scheduler` is **ON** or **OFF**,

you cannot set it to `DISABLED` at runtime. Also, if the Event Scheduler is set to `DISABLED` at startup, you cannot change the value of `event_scheduler` at runtime.

To disable the event scheduler, use one of the following two methods:

- As a command-line option when starting the server:

```
--event-scheduler=DISABLED
```

- In the server configuration file (`my.cnf`, or `my.ini` on Windows systems), include the line where it will be read by the server (for example, in a `[mysqld]` section):

```
event_scheduler=DISABLED
```

To enable the Event Scheduler, restart the server without the `--event-scheduler=DISABLED` command-line option, or after removing or commenting out the line containing `event_scheduler=DISABLED` in the server configuration file, as appropriate. Alternatively, you can use `ON` (or `1`) or `OFF` (or `0`) in place of the `DISABLED` value when starting the server.

### Note

You can issue event-manipulation statements when `event_scheduler` is set to `DISABLED`. No warnings or errors are generated in such cases (provided that the statements are themselves valid). However, scheduled events cannot execute until this variable is set to `ON` (or `1`). Once this has been done, the event scheduler thread executes all events whose scheduling conditions are satisfied.

In MySQL 5.1.11, `event_scheduler` behaved as follows: this variable could take one of the values `0` (or `OFF`), `1` (or `ON`), or `2`. Setting it to `0` turned event scheduling off, so that the event scheduler thread did not run; the `event_scheduler` variable could not be set to this value while the server was running. Setting it to `1` so that the event scheduler thread ran and executed scheduled events. In this state, the event scheduler thread appeared to be sleeping when viewed with `SHOW PROCESSLIST`. When `event_scheduler` was set to `2` (which was the default value), the Event Scheduler was considered to be “suspended”; the event scheduler thread ran and could be seen in the output of `SHOW PROCESSLIST` (where `Suspended` was displayed in the `State` column), but did not execute any scheduled events. The value of `event_scheduler` could be changed only between `1` (or `ON`) and `2` while the server was running. Setting it to `0` (or `OFF`) required a server restart, as did changing its value from `0` (or `OFF`) to `1` (or `ON`) or `2`.

Prior to MySQL 5.1.11, `event_scheduler` could take one of only the 2 values `0|OFF` or `1|ON`, and the default value was `0|OFF`. It was also possible to start and stop the event scheduler thread while the MySQL server was running.

For more information concerning the reasons for these changes in behaviour, see [Bug#17619](#).

Beginning with MySQL 5.1.17, starting the MySQL server with the `--skip-grant-tables` option causes `event_scheduler` to be set to `DISABLED`, overriding any other value set either on the command line or in the `my.cnf` or `my.ini` file ([Bug#26807](#)).

For SQL statements used to create, alter, and drop events, see [Section 18.4.3, “Event Syntax”](#).

MySQL 5.1.6 and later provides an `EVENTS` table in the `INFORMATION_SCHEMA` database. This table can be queried to obtain information about scheduled events which have been defined on the server. See [Section 18.4.4, “Event Metadata”](#), and [Section 19.20, “The INFORMATION\\_SCHEMA EVENTS Table”](#), for more information.

For information regarding event scheduling and the MySQL privilege system, see [Section 18.4.6, “The Event Scheduler and MySQL Privileges”](#).

## 18.4.3. Event Syntax

MySQL 5.1.6 and later provides several SQL statements for working with scheduled events:

- New events are defined using the `CREATE EVENT` statement. See [Section 12.1.11, “CREATE EVENT Syntax”](#).
- The definition of an existing event can be changed by means of the `ALTER EVENT` statement. See [Section 12.1.2, “ALTER EVENT Syntax”](#).
- When a scheduled event is no longer wanted or needed, it can be deleted from the server by its definer using the `DROP EVENT` statement. See [Section 12.1.22, “DROP EVENT Syntax”](#). Whether an event persists past the end of its schedule also depends on its `ON COMPLETION` clause, if it has one. See [Section 12.1.11, “CREATE EVENT Syntax”](#).

An event can be dropped by any user having the `EVENT` privilege for the database on which the event is defined. Prior to



MySQL 5.1.12, a user other than the definer required privileges on the `mysql.event` table. See [Section 18.4.6, “The Event Scheduler and MySQL Privileges”](#).

## 18.4.4. Event Metadata

Metadata about events can be obtained as follows:

- Query the `EVENTS` table of the `INFORMATION_SCHEMA` database. See [Section 19.20, “The INFORMATION\\_SCHEMA EVENTS Table”](#).
- Use the `SHOW CREATE EVENT` statement. See [Section 12.5.5.9, “SHOW CREATE EVENT Syntax”](#).
- Use the `SHOW EVENTS` statement. See [Section 12.5.5.19, “SHOW EVENTS Syntax”](#).

## 18.4.5. Event Scheduler Status

The Event Scheduler writes information about event execution that terminates with an error or warning to the MySQL Server's error log. See [Section 18.4.6, “The Event Scheduler and MySQL Privileges”](#) for an example. (Before MySQL 5.1.31, the Event Scheduler also logged messages when events started execution and terminated successfully.)

Information about the state of the Event Scheduler for debugging and troubleshooting purposes can be obtained as follows:

- In debugging builds of MySQL 5.1.11, you can use the `SHOW SCHEDULER STATUS` statement; see [Section 12.5.5.34, “SHOW SCHEDULER STATUS Syntax”](#). This statement was removed in MySQL 5.1.12. We intend to implement an SQL statement providing similar functionality in a future MySQL release.
- Beginning with MySQL 5.1.12, event scheduler status information can be obtained by running `mysqladmin debug` (see [Section 4.5.2, “mysqladmin — Client for Administering a MySQL Server”](#)); after running this command, the server's error log contains output relating to the Event Scheduler, similar to what is shown here:

```
Events status:
LLA = Last Locked At   LUA = Last Unlocked At
WOC = Waiting On Condition  DL = Data Locked

Event scheduler status:
State      : INITIALIZED
Thread id  : 0
LLA       : init_scheduler:313
LUA       : init_scheduler:318
WOC       : NO
Workers   : 0
Executed   : 0
Data locked: NO

Event queue status:
Element count : 1
Data locked   : NO
Attempting lock : NO
LLA          : init_queue:148
LUA          : init_queue:168
WOC          : NO
Next activation : 0000-00-00 00:00:00
```

For `SELECT ... INTO var_list` statements, if the query returns no rows, a warning with error code 1329 occurs (`No data`), and the variable values remain unchanged. If the query returns multiple rows, error 1172 occurs (`Result consisted of more than one row`). In the context of such statements that occur as part of events executed by the Event Scheduler, diagnostics messages (not only errors, but also warnings) are written to the error log, and, on Windows, to the application event log. For frequently executed events, it is possible for this to result in many logged messages. For either condition, you can avoid this problem by declaring a condition handler; see [Section 12.8.4.2, “DECLARE for Handlers”](#). For statements that may retrieve multiple rows, another strategy is to use `LIMIT 1` to limit the result set to a single row.

## 18.4.6. The Event Scheduler and MySQL Privileges

To enable or disable the execution of scheduled events, it is necessary to set the value of the global `event_scheduler` system variable. This requires the `SUPER` privilege.

MySQL 5.1.6 introduces a privilege governing the creation, modification, and deletion of events, the `EVENT` privilege. This privilege can be bestowed using `GRANT`. For example, this `GRANT` statement confers the `EVENT` privilege for the schema named `myschema` on the user `jon@ghidora`:

```
GRANT EVENT ON myschema.* TO jon@ghidora;
```

(We assume that this user account already exists, and that we wish for it to remain unchanged otherwise.)

To grant this same user the `EVENT` privilege on all schemas, use the following statement:

```
GRANT EVENT ON *.* TO jon@ghidora;
```

The `EVENT` privilege has global or schema-level scope. Therefore, trying to grant it on a single table results in an error as shown:

```
mysql> GRANT EVENT ON myschema.mytable TO jon@ghidora;
ERROR 1144 (42000): ILLEGAL GRANT/REVOKE COMMAND; PLEASE
CONSULT THE MANUAL TO SEE WHICH PRIVILEGES CAN BE USED
```

It is important to understand that an event is executed with the privileges of its definer, and that it cannot perform any actions for which its definer does not have the requisite privileges. For example, suppose that `jon@ghidora` has the `EVENT` privilege for `myschema`. Suppose also that this user has the `SELECT` privilege for `myschema`, but no other privileges for this schema. It is possible for `jon@ghidora` to create a new event such as this one:

```
CREATE EVENT e_store_ts
ON SCHEDULE
EVERY 10 SECOND
DO
INSERT INTO myschema.mytable VALUES (UNIX_TIMESTAMP());
```

The user waits for a minute or so, and then performs a `SELECT * FROM mytable;` query, expecting to see several new rows in the table. Instead, the table is empty. Since the user does not have the `INSERT` privilege for the table in question, the event has no effect.

If you inspect the MySQL error log (`hostname.err`), you can see that the event is executing, but the action it is attempting to perform fails, as indicated by `RetCode=0`:

```
060209 22:39:44 [Note] EVEX EXECUTING event newdb.e [EXPR:10]
060209 22:39:44 [Note] EVEX EXECUTED event newdb.e [EXPR:10]. RetCode=0
060209 22:39:54 [Note] EVEX EXECUTING event newdb.e [EXPR:10]
060209 22:39:54 [Note] EVEX EXECUTED event newdb.e [EXPR:10]. RetCode=0
060209 22:40:04 [Note] EVEX EXECUTING event newdb.e [EXPR:10]
060209 22:40:04 [Note] EVEX EXECUTED event newdb.e [EXPR:10]. RetCode=0
```

Since this user very likely does not have access to the error log, it is possible to verify whether the event's action statement is valid by executing it directly:

```
mysql> INSERT INTO myschema.mytable VALUES (UNIX_TIMESTAMP());
ERROR 1142 (42000): INSERT COMMAND DENIED TO USER
'JON'@'GHIDORA' FOR TABLE 'MYTABLE'
```

Inspection of the `INFORMATION_SCHEMA.EVENTS` table shows that `e_store_ts` exists and is enabled, but its `LAST_EXECUTED` column is `NULL`:

```
mysql> SELECT * FROM INFORMATION_SCHEMA.EVENTS
> WHERE EVENT_NAME='e_store_ts'
> AND EVENT_SCHEMA='myschema'\G
***** 1. row *****
EVENT_CATALOG: NULL
EVENT_SCHEMA: myschema
EVENT_NAME: e_store_ts
DEFINER: jon@ghidora
EVENT_BODY: SQL
EVENT_DEFINITION: INSERT INTO myschema.mytable VALUES (UNIX_TIMESTAMP())
EVENT_TYPE: RECURRING
EXECUTE_AT: NULL
INTERVAL_VALUE: 5
INTERVAL_FIELD: SECOND
SQL_MODE: NULL
STARTS: 0000-00-00 00:00:00
ENDS: 0000-00-00 00:00:00
STATUS: ENABLED
ON_COMPLETION: NOT PRESERVE
CREATED: 2006-02-09 22:36:06
LAST ALTERED: 2006-02-09 22:36:06
LAST_EXECUTED: NULL
EVENT_COMMENT:
1 row in set (0.00 sec)
```

## Note

Prior to MySQL 5.1.12, there was no `EVENT_DEFINITION` column, and `EVENT_BODY` contained the SQL state-

ment or statements to be executed. See [Section 19.20, “The INFORMATION\\_SCHEMA EVENTS Table”](#), for more information.

To rescind the `EVENT` privilege, use the `REVOKE` statement. In this example, the `EVENT` privilege on the schema `myschema` is removed from the `jon@ghidora` user account:

```
REVOKE EVENT ON myschema.* FROM jon@ghidora;
```

### Important

Revoking the `EVENT` privilege from a user does not delete or disable any events that may have been created by that user.

An event is not migrated or dropped as a result of renaming or dropping the user who created it.

For example, suppose that the user `jon@ghidora` has been granted the `EVENT` and `INSERT` privileges on the `myschema` schema. This user then creates the following event:

```
CREATE EVENT e_insert
ON SCHEDULE
EVERY 7 SECOND
DO
INSERT INTO myschema.mytable;
```

After this event has been created, `root` revokes the `EVENT` privilege for `jon@ghidora`. However, `e_insert` continues to execute, inserting a new row into `mytable` each seven seconds. The same would be true if `root` had issued either of these statements:

- `DROP USER jon@ghidora;`
- `RENAME USER jon@ghidora TO someotherguy@ghidora;`

You can verify that this is true by examining the `mysql.event` table (discussed later in this section) or the `INFORMATION_SCHEMA.EVENTS` table (see [Section 19.20, “The INFORMATION\\_SCHEMA EVENTS Table”](#)) before and after issuing a `DROP USER` or `RENAME USER` statement.

Event definitions are stored in the `mysql.event` table, which was added in MySQL 5.1.6. To drop an event created by another user account, the MySQL `root` user (or another user with the necessary privileges) can delete rows from this table. For example, to remove the event `e_insert` shown previously, `root` can use the following statement:

```
DELETE FROM mysql.event
WHERE db = 'myschema'
AND definer = 'jon@ghidora'
AND name = 'e_insert';
```

It is very important to match the event name, database schema name, and user account when deleting rows from the `mysql.event` table. This is because the same user can create different events of the same name in different schemas.

### Note

The namespace for scheduled events changed in MySQL 5.1.12. Prior to that MySQL version, different users could create different events having the same name in the same database; in MySQL 5.1.12 and later, that is no longer the case. When upgrading to MySQL 5.1.12 or later from MySQL 5.1.11 or earlier, it is extremely important to make sure that no events in the same database share the same name, *prior to performing the upgrade*.

Users' `EVENT` privileges are stored in the `Event_priv` columns of the `mysql.user` and `mysql.db` tables. In both cases, this column holds one of the values 'Y' or 'N'. 'N' is the default. `mysql.user.Event_priv` is set to 'Y' for a given user only if that user has the global `EVENT` privilege (that is, if the privilege was bestowed using `GRANT EVENT ON *.*`). For a schema-level `EVENT` privilege, `GRANT` creates a row in `mysql.db` and sets that row's `Db` column to the name of the schema, the `User` column to the name of the user, and the `Event_priv` column to 'Y'. There should never be any need to manipulate these tables directly, since the `GRANT EVENT` and `REVOKE EVENT` statements perform the required operations on them.

MySQL 5.1.6 introduces five status variables providing counts of event-related operations (but *not* of statements executed by events; see [Section D.1, “Restrictions on Stored Routines, Triggers, and Events”](#)). These are:

- `Com_create_event`: The number of `CREATE EVENT` statements executed since the last server restart.
- `Com_alter_event`: The number of `ALTER EVENT` statements executed since the last server restart.

- `Com_drop_event`: The number of `DROP EVENT` statements executed since the last server restart.
- `Com_show_create_event`: The number of `SHOW CREATE EVENT` statements executed since the last server restart.
- `Com_show_events`: The number of `SHOW EVENTS` statements executed since the last server restart.

You can view current values for all of these at one time by running the statement `SHOW STATUS LIKE '%event%'`;

## 18.5. Using Views

Views (including updatable views) are available in MySQL Server 5.1. Views are stored queries that when invoked produce a result set. A view acts as a virtual table.

To use views if you have upgraded to MySQL 5.1 from an older release that did not support views, you should upgrade your grant tables so that they contain the view-related privileges. See [Section 4.4.8, “mysql\\_upgrade — Check Tables for MySQL Upgrade”](#).

The following discussion describes the syntax for creating and dropping views, and shows some examples of how to use them.

### Additional resources

- You may find the [Views User Forum](#) of use when working with views.
- For answers to some commonly asked questions regarding views in MySQL, see [Section A.6, “MySQL 5.1 FAQ — Views”](#).
- There are some restrictions on the use of views; see [Section D.4, “Restrictions on Views”](#).

### 18.5.1. View Syntax

The `CREATE VIEW` statement creates a new view (see [Section 12.1.20, “CREATE VIEW Syntax”](#)). To alter the definition of a view or drop a view, use `ALTER VIEW` (see [Section 12.1.9, “ALTER VIEW Syntax”](#)), or `DROP VIEW` (see [Section 12.1.31, “DROP VIEW Syntax”](#)).

A view can be created from many kinds of `SELECT` statements. It can refer to base tables or other views. It can use joins, `UNION`, and subqueries. The `SELECT` need not even refer to any tables. The following example defines a view that selects two columns from another table, as well as an expression calculated from those columns:

```
mysql> CREATE TABLE t (qty INT, price INT);
mysql> INSERT INTO t VALUES(3, 50), (5, 60);
mysql> CREATE VIEW v AS SELECT qty, price, qty*price AS value FROM t;
mysql> SELECT * FROM v;
+----+-----+-----+
| qty | price | value |
+----+-----+-----+
|  3  |   50  |   150 |
|  5  |   60  |   300 |
+----+-----+-----+
mysql> SELECT * FROM v WHERE qty = 5;
+----+-----+-----+
| qty | price | value |
+----+-----+-----+
|  5  |   60  |   300 |
+----+-----+-----+
```

### 18.5.2. View Processing Algorithms

The optional `ALGORITHM` clause for `CREATE VIEW` or `ALTER VIEW` is a MySQL extension to standard SQL. It affects how MySQL processes the view. `ALGORITHM` takes three values: `MERGE`, `TEMPTABLE`, or `UNDEFINED`. The default algorithm is `UNDEFINED` if no `ALGORITHM` clause is present.

For `MERGE`, the text of a statement that refers to the view and the view definition are merged such that parts of the view definition replace corresponding parts of the statement.

For `TEMPTABLE`, the results from the view are retrieved into a temporary table, which then is used to execute the statement.

For `UNDEFINED`, MySQL chooses which algorithm to use. It prefers `MERGE` over `TEMPTABLE` if possible, because `MERGE` is usually more efficient and because a view cannot be updatable if a temporary table is used.

A reason to choose `TEMPTABLE` explicitly is that locks can be released on underlying tables after the temporary table has been created and before it is used to finish processing the statement. This might result in quicker lock release than the `MERGE` algorithm so

that other clients that use the view are not blocked as long.

A view algorithm can be `UNDEFINED` for three reasons:

- No `ALGORITHM` clause is present in the `CREATE VIEW` statement.
- The `CREATE VIEW` statement has an explicit `ALGORITHM = UNDEFINED` clause.
- `ALGORITHM = MERGE` is specified for a view that can be processed only with a temporary table. In this case, MySQL generates a warning and sets the algorithm to `UNDEFINED`.

As mentioned earlier, `MERGE` is handled by merging corresponding parts of a view definition into the statement that refers to the view. The following examples briefly illustrate how the `MERGE` algorithm works. The examples assume that there is a view `v_merge` that has this definition:

```
CREATE ALGORITHM = MERGE VIEW v_merge (vc1, vc2) AS
SELECT c1, c2 FROM t WHERE c3 > 100;
```

Example 1: Suppose that we issue this statement:

```
SELECT * FROM v_merge;
```

MySQL handles the statement as follows:

- `v_merge` becomes `t`
- `*` becomes `vc1, vc2`, which corresponds to `c1, c2`
- The view `WHERE` clause is added

The resulting statement to be executed becomes:

```
SELECT c1, c2 FROM t WHERE c3 > 100;
```

Example 2: Suppose that we issue this statement:

```
SELECT * FROM v_merge WHERE vc1 < 100;
```

This statement is handled similarly to the previous one, except that `vc1 < 100` becomes `c1 < 100` and the view `WHERE` clause is added to the statement `WHERE` clause using an `AND` connective (and parentheses are added to make sure the parts of the clause are executed with correct precedence). The resulting statement to be executed becomes:

```
SELECT c1, c2 FROM t WHERE (c3 > 100) AND (c1 < 100);
```

Effectively, the statement to be executed has a `WHERE` clause of this form:

```
WHERE (select WHERE) AND (view WHERE)
```

If the `MERGE` algorithm cannot be used, a temporary table must be used instead. `MERGE` cannot be used if the view contains any of the following constructs:

- Aggregate functions (`SUM()`, `MIN()`, `MAX()`, `COUNT()`, and so forth)
- `DISTINCT`
- `GROUP BY`
- `HAVING`
- `LIMIT`
- `UNION` or `UNION ALL`
- Subquery in the select list

- Refers only to literal values (in this case, there is no underlying table)

### 18.5.3. Updatable and Insertable Views

Some views are updatable. That is, you can use them in statements such as `UPDATE`, `DELETE`, or `INSERT` to update the contents of the underlying table. For a view to be updatable, there must be a one-to-one relationship between the rows in the view and the rows in the underlying table. There are also certain other constructs that make a view non-updatable. To be more specific, a view is not updatable if it contains any of the following:

- Aggregate functions (`SUM()`, `MIN()`, `MAX()`, `COUNT()`, and so forth)
- `DISTINCT`
- `GROUP BY`
- `HAVING`
- `UNION` or `UNION ALL`
- Subquery in the select list
- Certain joins (see additional join discussion later in this section)
- Non-updatable view in the `FROM` clause
- A subquery in the `WHERE` clause that refers to a table in the `FROM` clause
- Refers only to literal values (in this case, there is no underlying table to update)
- Uses `ALGORITHM = TEMPTABLE` (use of a temporary table always makes a view non-updatable)
- Multiple references to any column of a base table.

With respect to insertability (being updatable with `INSERT` statements), an updatable view is insertable if it also satisfies these additional requirements for the view columns:

- There must be no duplicate view column names.
- The view must contain all columns in the base table that do not have a default value.
- The view columns must be simple column references and not derived columns. A derived column is one that is not a simple column reference but is derived from an expression. These are examples of derived columns:

```
3.14159
col1 + 3
UPPER(col2)
col3 / col4
(subquery)
```

A view that has a mix of simple column references and derived columns is not insertable, but it can be updatable if you update only those columns that are not derived. Consider this view:

```
CREATE VIEW v AS SELECT col1, 1 AS col2 FROM t;
```

This view is not insertable because `col2` is derived from an expression. But it is updatable if the update does not try to update `col2`. This update is allowable:

```
UPDATE v SET col1 = 0;
```

This update is not allowable because it attempts to update a derived column:

```
UPDATE v SET col2 = 0;
```

It is sometimes possible for a multiple-table view to be updatable, assuming that it can be processed with the `MERGE` algorithm. For this to work, the view must use an inner join (not an outer join or a `UNION`). Also, only a single table in the view definition can be

updated, so the `SET` clause must name only columns from one of the tables in the view. Views that use `UNION ALL` are disallowed even though they might be theoretically updatable, because the implementation uses temporary tables to process them.

For a multiple-table updatable view, `INSERT` can work if it inserts into a single table. `DELETE` is not supported.

`INSERT DELAYED` is not supported for views.

If a table contains an `AUTO_INCREMENT` column, inserting into an insertable view on the table that does not include the `AUTO_INCREMENT` column does not change the value of `LAST_INSERT_ID()`, because the side effects of inserting default values into columns not part of the view should not be visible.

The `WITH CHECK OPTION` clause can be given for an updatable view to prevent inserts or updates to rows except those for which the `WHERE` clause in the `select_statement` is true.

In a `WITH CHECK OPTION` clause for an updatable view, the `LOCAL` and `CASCADED` keywords determine the scope of check testing when the view is defined in terms of another view. The `LOCAL` keyword restricts the `CHECK OPTION` only to the view being defined. `CASCADED` causes the checks for underlying views to be evaluated as well. When neither keyword is given, the default is `CASCADED`. Consider the definitions for the following table and set of views:

```
mysql> CREATE TABLE t1 (a INT);
mysql> CREATE VIEW v1 AS SELECT * FROM t1 WHERE a < 2
-> WITH CHECK OPTION;
mysql> CREATE VIEW v2 AS SELECT * FROM v1 WHERE a > 0
-> WITH LOCAL CHECK OPTION;
mysql> CREATE VIEW v3 AS SELECT * FROM v1 WHERE a > 0
-> WITH CASCADED CHECK OPTION;
```

Here the `v2` and `v3` views are defined in terms of another view, `v1`. `v2` has a `LOCAL` check option, so inserts are tested only against the `v2` check. `v3` has a `CASCADED` check option, so inserts are tested not only against its own check, but against those of underlying views. The following statements illustrate these differences:

```
mysql> INSERT INTO v2 VALUES (2);
Query OK, 1 row affected (0.00 sec)
mysql> INSERT INTO v3 VALUES (2);
ERROR 1369 (HY000): CHECK OPTION failed 'test.v3'
```

MySQL sets a flag, called the view updatability flag, at `CREATE VIEW` time. The flag is set to `YES` (true) if `UPDATE` and `DELETE` (and similar operations) are legal for the view. Otherwise, the flag is set to `NO` (false). The `IS_UPDATABLE` column in the `INFORMATION_SCHEMA.VIEWS` table displays the status of this flag. It means that the server always knows whether a view is updatable. If the view is not updatable, statements such `UPDATE`, `DELETE`, and `INSERT` are illegal and will be rejected. (Note that even if a view is updatable, it might not be possible to insert into it, as described elsewhere in this section.)

The updatability of views may be affected by the value of the `updatable_views_with_limit` system variable. See [Section 5.1.3, “Server System Variables”](#).

## 18.5.4. View Metadata

Metadata about views can be obtained as follows:

- Query the `VIEWS` table of the `INFORMATION_SCHEMA` database. See [Section 19.15, “The INFORMATION\\_SCHEMA VIEWS Table”](#).
- Use the `SHOW CREATE VIEW` statement. See [Section 12.5.5.14, “SHOW CREATE VIEW Syntax”](#).

## 18.6. Binary Logging of Stored Programs

The binary log contains information about SQL statements that modify database contents. This information is stored in the form of “events” that describe the modifications. The binary log has two important purposes:

- For replication, the binary log is used on master replication servers as a record of the statements to be sent to slave servers. The master server sends the events contained in its binary log to its slaves, which execute those events to make the same data changes that were made on the master. See [Section 16.4, “Replication Implementation”](#).
- Certain data recovery operations require use of the binary log. After a backup file has been restored, the events in the binary log that were recorded after the backup was made are re-executed. These events bring databases up to date from the point of the backup. See [Section 6.2.2, “Using Backups for Recovery”](#).

However, there are certain binary logging issues that apply with respect to stored programs (stored procedures and functions, trig-

gers, and events), if logging occurs at the statement level:

- In some cases, it is possible that a statement will affect different sets of rows on a master and a slave.
- Replicated statements executed on a slave are processed by the slave SQL thread, which has full privileges. It is possible for a procedure to follow different execution paths on master and slave servers, so a user can write a routine containing a dangerous statement that will execute only on the slave where it is processed by a thread that has full privileges.
- If a stored program that modifies data is non-deterministic, it is not repeatable. This can result in different data on a master and slave, or cause restored data to differ from the original data.

This section describes how MySQL 5.1 handles binary logging for stored programs. It states the current conditions that the implementation places on the use of stored programs, and what you can do to avoid problems. It also provides additional information about the reasons for these conditions.

In general, the issues described here result when binary logging occurs at the SQL statement level. If you use row-based binary logging, the log contains changes made to individual rows as a result of executing SQL statements. When routines or triggers execute, row changes are logged, not the statements that make the changes. For stored procedures, this means that the `CALL` statement is not logged. For stored functions, row changes made within the function are logged, not the function invocation. For triggers, row changes made by the trigger are logged. On the slave side, only the row changes are seen, not the stored program invocation. For general information about row-based logging, see [Section 16.1.2, “Replication Formats”](#).

Unless noted otherwise, the remarks here assume that you have enabled binary logging by starting the server with the `--log-bin` option. (See [Section 5.2.4, “The Binary Log”](#).) If the binary log is not enabled, replication is not possible, nor is the binary log available for data recovery.

The current conditions on the use of stored functions in MySQL 5.1 can be summarized as follows. These conditions do not apply to stored procedures or Event Scheduler events and they do not apply unless binary logging is enabled.

- To create or alter a stored function, you must have the `SUPER` privilege, in addition to the `CREATE ROUTINE` or `ALTER ROUTINE` privilege that is normally required.
- When you create a stored function, you must declare either that it is deterministic or that it does not modify data. Otherwise, it may be unsafe for data recovery or replication.

By default, for a `CREATE FUNCTION` statement to be accepted, at least one of `DETERMINISTIC`, `NO SQL`, or `READS SQL DATA` must be specified explicitly. Otherwise an error occurs:

```
ERROR 1418 (HY000): This function has none of DETERMINISTIC, NO SQL,
or READS SQL DATA in its declaration and binary logging is enabled
(you *might* want to use the less safe log_bin_trust_function_creators
variable)
```

This function is deterministic (and does not modify data), so it is safe:

```
CREATE FUNCTION f1(i INT)
RETURNS INT
DETERMINISTIC
READS SQL DATA
BEGIN
    RETURN i;
END;
```

This function uses `UUID()`, which is not deterministic, so the function also is not deterministic and is not safe:

```
CREATE FUNCTION f2()
RETURNS CHAR(36) CHARACTER SET utf8
BEGIN
    RETURN UUID();
END;
```

This function modifies data, so it may not be safe:

```
CREATE FUNCTION f3(p_id INT)
RETURNS INT
BEGIN
    UPDATE t SET modtime = NOW() WHERE id = p_id;
    RETURN ROW_COUNT();
END;
```

Assessment of the nature of a function is based on the “honesty” of the creator: MySQL does not check that a function declared



`DETERMINISTIC` is free of statements that produce non-deterministic results.

- Although it is possible to create a deterministic stored function without specifying `DETERMINISTIC`, you cannot as of MySQL 5.1.15 execute this function using statement-based binary logging. To execute such a function, you must use row-based or mixed binary logging. Alternatively, if you explicitly specify `DETERMINISTIC` in the function definition, you can use any kind of logging, including statement-based logging.
- To relax the preceding conditions on function creation (that you must have the `SUPER` privilege and that a function must be declared deterministic or to not modify data), set the global `log_bin_trust_function_creators` system variable to 1. By default, this variable has a value of 0, but you can change it like this:

```
mysql> SET GLOBAL log_bin_trust_function_creators = 1;
```

You can also set this variable by using the `--log-bin-trust-function-creators=1` option when starting the server.

If binary logging is not enabled, `log_bin_trust_function_creators` does not apply and `SUPER` is not required for function creation.

- For information about built-in functions that may be unsafe for replication (and thus cause stored functions that use them to be unsafe as well), see [Section 16.3.1, “Replication Features and Issues”](#).

Triggers are similar to stored functions, so the preceding remarks regarding functions also apply to triggers with the following exception: `CREATE TRIGGER` does not have an optional `DETERMINISTIC` characteristic, so triggers are assumed to be always deterministic. However, this assumption might in some cases be invalid. For example, the `UUID()` function is non-deterministic (and does not replicate). You should be careful about using such functions in triggers.

Triggers can update tables, so error messages similar to those for stored functions occur with `CREATE TRIGGER` if you do not have the required privileges. On the slave side, the slave uses the trigger `DEFINER` attribute to determine which user is considered to be the creator of the trigger.

The rest of this section provides additional detail about the logging implementation and its implications. You need not read it unless you are interested in the background on the rationale for the current logging-related conditions on stored routine use. This discussion applies only for statement-based logging, and not for row-based logging, with the exception of the first item: `CREATE` and `DROP` statements are logged as statements regardless of the logging mode.

- The server writes `CREATE EVENT`, `CREATE PROCEDURE`, `CREATE FUNCTION`, `ALTER EVENT`, `ALTER PROCEDURE`, `ALTER FUNCTION`, `DROP EVENT`, `DROP PROCEDURE`, and `DROP FUNCTION` statements to the binary log.
- A stored function invocation is logged as a `SELECT` statement if the function changes data and occurs within a statement that would not otherwise be logged. This prevents non-replication of data changes that result from use of stored functions in non-logged statements. For example, `SELECT` statements are not written to the binary log, but a `SELECT` might invoke a stored function that makes changes. To handle this, a `SELECT func_name()` statement is written to the binary log when the given function makes a change. Suppose that the following statements are executed on the master:

```
CREATE FUNCTION f1(a INT) RETURNS INT
BEGIN
  IF (a < 3) THEN
    INSERT INTO t2 VALUES (a);
  END IF;
  RETURN 0;
END;

CREATE TABLE t1 (a INT);
INSERT INTO t1 VALUES (1),(2),(3);

SELECT f1(a) FROM t1;
```

When the `SELECT` statement executes, the function `f1()` is invoked three times. Two of those invocations insert a row, and MySQL logs a `SELECT` statement for each of them. That is, MySQL writes the following statements to the binary log:

```
SELECT f1(1);
SELECT f1(2);
```

The server also logs a `SELECT` statement for a stored function invocation when the function invokes a stored procedure that causes an error. In this case, the server writes the `SELECT` statement to the log along with the expected error code. On the slave, if the same error occurs, that is the expected result and replication continues. Otherwise, replication stops.

Note: Before MySQL 5.1.7, you will see these `SELECT func_name()` statements logged as `DO func_name()`. The change to `SELECT` was made because use of `DO` was found to yield insufficient control over error code checking.

- Logging stored function invocations rather than the statements executed by a function has a security implication for replication,

which arises from two factors:

- It is possible for a function to follow different execution paths on master and slave servers.
- Statements executed on a slave are processed by the slave SQL thread which has full privileges.

The implication is that although a user must have the `CREATE ROUTINE` privilege to create a function, the user can write a function containing a dangerous statement that will execute only on the slave where it is processed by a thread that has full privileges. For example, if the master and slave servers have server ID values of 1 and 2, respectively, a user on the master server could create and invoke an unsafe function `unsafe_func()` as follows:

```
mysql> delimiter //
mysql> CREATE FUNCTION unsafe_func () RETURNS INT
-> BEGIN
-> IF @@server_id=2 THEN dangerous_statement; END IF;
-> RETURN 1;
-> END;
-> //
mysql> delimiter ;
mysql> INSERT INTO t VALUES(unsafe_func());
```

The `CREATE FUNCTION` and `INSERT` statements are written to the binary log, so the slave will execute them. Because the slave SQL thread has full privileges, it will execute the dangerous statement. Thus, the function invocation has different effects on the master and slave and is not replication-safe.

To guard against this danger for servers that have binary logging enabled, stored function creators must have the `SUPER` privilege, in addition to the usual `CREATE ROUTINE` privilege that is required. Similarly, to use `ALTER FUNCTION`, you must have the `SUPER` privilege in addition to the `ALTER ROUTINE` privilege. Without the `SUPER` privilege, an error will occur:

```
ERROR 1419 (HY000): You do not have the SUPER privilege and
binary logging is enabled (you *might* want to use the less safe
log_bin_trust_function_creators variable)
```

If you do not want to require function creators to have the `SUPER` privilege (for example, if all users with the `CREATE ROUTINE` privilege on your system are experienced application developers), set the global `log_bin_trust_function_creators` system variable to 1. You can also set this variable by using the `--log-bin-trust-function-creators=1` option when starting the server. If binary logging is not enabled, `log_bin_trust_function_creators` does not apply and `SUPER` is not required for function creation.

- If a function that performs updates is non-deterministic, it is not repeatable. This can have two undesirable effects:
  - It will make a slave different from the master.
  - Restored data will be different from the original data.

To deal with these problems, MySQL enforces the following requirement: On a master server, creation and alteration of a function is refused unless you declare the function to be deterministic or to not modify data. Two sets of function characteristics apply here:

- The `DETERMINISTIC` and `NOT DETERMINISTIC` characteristics indicate whether a function always produces the same result for given inputs. The default is `NOT DETERMINISTIC` if neither characteristic is given. To declare that a function is deterministic, you must specify `DETERMINISTIC` explicitly.
- The `CONTAINS SQL`, `NO SQL`, `READS SQL DATA`, and `MODIFIES SQL DATA` characteristics provide information about whether the function reads or writes data. Either `NO SQL` or `READS SQL DATA` indicates that a function does not change data, but you must specify one of these explicitly because the default is `CONTAINS SQL` if no characteristic is given.

By default, for a `CREATE FUNCTION` statement to be accepted, at least one of `DETERMINISTIC`, `NO SQL`, or `READS SQL DATA` must be specified explicitly. Otherwise an error occurs:

```
ERROR 1418 (HY000): This function has none of DETERMINISTIC, NO SQL,
or READS SQL DATA in its declaration and binary logging is enabled
(you *might* want to use the less safe log_bin_trust_function_creators
variable)
```

If you set `log_bin_trust_function_creators` to 1, the requirement that functions be deterministic or not modify data is dropped.

- Stored procedure calls are logged at the statement level rather than at the `CALL` level. That is, the server does not log the `CALL` statement, it logs those statements within the procedure that actually execute. As a result, the same changes that occur on the master will be observed on slave servers. This prevents problems that could result from a procedure having different execution paths on different machines.

In general, statements executed within a stored procedure are written to the binary log using the same rules that would apply were the statements to be executed in standalone fashion. Some special care is taken when logging procedure statements because statement execution within procedures is not quite the same as in non-procedure context:

- A statement to be logged might contain references to local procedure variables. These variables do not exist outside of stored procedure context, so a statement that refers to such a variable cannot be logged literally. Instead, each reference to a local variable is replaced by this construct for logging purposes:

```
NAME_CONST(var_name, var_value)
```

*var\_name* is the local variable name, and *var\_value* is a constant indicating the value that the variable has at the time the statement is logged. `NAME_CONST()` has a value of *var\_value*, and a “name” of *var\_name*. Thus, if you invoke this function directly, you get a result like this:

```
mysql> SELECT NAME_CONST('myname', 14);
+-----+
| myname |
+-----+
|      14 |
+-----+
```

`NAME_CONST()` allows a logged standalone statement to be executed on a slave with the same effect as the original statement that was executed on the master within a stored procedure.

The use of `NAME_CONST()` can result in a problem for `CREATE TABLE ... SELECT` statements when the source column expressions refer to local variables. Converting these references to `NAME_CONST()` expressions can result in column names that are different on the master and slave servers, or names that are too long to be legal column identifiers. A workaround is to supply aliases for columns that refer to local variables. Consider this statement when `myvar` has a value of 1:

```
CREATE TABLE t1 SELECT myvar;
```

That will be rewritten as follows:

```
CREATE TABLE t1 SELECT NAME_CONST(myvar, 1);
```

To ensure that the master and slave tables have the same column names, write the statement like this:

```
CREATE TABLE t1 SELECT myvar AS myvar;
```

The rewritten statement becomes:

```
CREATE TABLE t1 SELECT NAME_CONST(myvar, 1) AS myvar;
```

- A statement to be logged might contain references to user-defined variables. To handle this, MySQL writes a `SET` statement to the binary log to make sure that the variable exists on the slave with the same value as on the master. For example, if a statement refers to a variable `@my_var`, that statement will be preceded in the binary log by the following statement, where *value* is the value of `@my_var` on the master:

```
SET @my_var = value;
```

- Procedure calls can occur within a committed or rolled-back transaction. Transactional context is accounted for so that the transactional aspects of procedure execution are replicated correctly. That is, the server logs those statements within the procedure that actually execute and modify data, and also logs `BEGIN`, `COMMIT`, and `ROLLBACK` statements as necessary. For example, if a procedure updates only transactional tables and is executed within a transaction that is rolled back, those updates are not logged. If the procedure occurs within a committed transaction, `BEGIN` and `COMMIT` statements are logged with the updates. For a procedure that executes within a rolled-back transaction, its statements are logged using the same rules that would apply if the statements were executed in standalone fashion:
  - Updates to transactional tables are not logged.
  - Updates to non-transactional tables are logged because rollback does not cancel them.
  - Updates to a mix of transactional and non-transactional tables are logged surrounded by `BEGIN` and `ROLLBACK` so that slaves will make the same changes and rollbacks as on the master.
- A stored procedure call is *not* written to the binary log at the statement level if the procedure is invoked from within a stored function. In that case, the only thing logged is the statement that invokes the function (if it occurs within a statement that is

logged) or a `DO` statement (if it occurs within a statement that is not logged). For this reason, care should be exercised in the use of stored functions that invoke a procedure, even if the procedure is otherwise safe in itself.

# Chapter 19. INFORMATION\_SCHEMA Tables

`INFORMATION_SCHEMA` provides access to database metadata.

*Metadata* is data about the data, such as the name of a database or table, the data type of a column, or access privileges. Other terms that sometimes are used for this information are *data dictionary* and *system catalog*.

`INFORMATION_SCHEMA` is the information database, the place that stores information about all the other databases that the MySQL server maintains. Inside `INFORMATION_SCHEMA` there are several read-only tables. They are actually views, not base tables, so there are no files associated with them.

In effect, we have a database named `INFORMATION_SCHEMA`, although the server does not create a database directory with that name. It is possible to select `INFORMATION_SCHEMA` as the default database with a `USE` statement, but it is possible only to read the contents of tables. You cannot insert into them, update them, or delete from them.

Here is an example of a statement that retrieves information from `INFORMATION_SCHEMA`:

```
mysql> SELECT table_name, table_type, engine
-> FROM information_schema.tables
-> WHERE table_schema = 'db5'
-> ORDER BY table_name DESC;
```

table_name	table_type	engine
v56	VIEW	NULL
v3	VIEW	NULL
v2	VIEW	NULL
v	VIEW	NULL
tables	BASE TABLE	MyISAM
t7	BASE TABLE	MyISAM
t3	BASE TABLE	MyISAM
t2	BASE TABLE	MyISAM
t	BASE TABLE	MyISAM
pk	BASE TABLE	InnoDB
loop	BASE TABLE	MyISAM
kurs	BASE TABLE	MyISAM
k	BASE TABLE	MyISAM
into	BASE TABLE	MyISAM
goto	BASE TABLE	MyISAM
fk2	BASE TABLE	InnoDB
fk	BASE TABLE	InnoDB

17 rows in set (0.01 sec)

Explanation: The statement requests a list of all the tables in database `db5`, in reverse alphabetical order, showing just three pieces of information: the name of the table, its type, and its storage engine.

Each MySQL user has the right to access these tables, but can see only the rows in the tables that correspond to objects for which the user has the proper access privileges. In some cases (for example, the `ROUTINE_DEFINITION` column in the `INFORMATION_SCHEMA.ROUTINES` table), users who have insufficient privileges will see `NULL`.

The `SELECT . . . FROM INFORMATION_SCHEMA` statement is intended as a more consistent way to provide access to the information provided by the various `SHOW` statements that MySQL supports (`SHOW DATABASES`, `SHOW TABLES`, and so forth). Using `SELECT` has these advantages, compared to `SHOW`:

- It conforms to Codd's rules. That is, all access is done on tables.
- Nobody needs to learn a new statement syntax. Because they already know how `SELECT` works, they only need to learn the object names.
- The implementor need not worry about adding keywords.
- There are millions of possible output variations, instead of just one. This provides more flexibility for applications that have varying requirements about what metadata they need.
- Migration is easier because every other DBMS does it this way.

However, because `SHOW` is popular with MySQL employees and users, and because it might be confusing were it to disappear, the advantages of conventional syntax are not a sufficient reason to eliminate `SHOW`. In fact, along with the implementation of `INFORMATION_SCHEMA`, there are enhancements to `SHOW` as well. These are described in [Section 19.28, "Extensions to SHOW Statements"](#).

There is no difference between the privileges required for `SHOW` statements and those required to select information from `INFORMATION_SCHEMA`. In either case, you have to have some privilege on an object in order to see information about it.

The implementation for the `INFORMATION_SCHEMA` table structures in MySQL follows the ANSI/ISO SQL:2003 standard Part 11 *Schemata*. Our intent is approximate compliance with SQL:2003 core feature F021 *Basic information schema*.

Users of SQL Server 2000 (which also follows the standard) may notice a strong similarity. However, MySQL has omitted many columns that are not relevant for our implementation, and added columns that are MySQL-specific. One such column is the `ENGINE` column in the `INFORMATION_SCHEMA.TABLES` table.

Although other DBMSs use a variety of names, like `syscat` or `system`, the standard name is `INFORMATION_SCHEMA`.

The following sections describe each of the tables and columns that are in `INFORMATION_SCHEMA`. For each column, there are three pieces of information:

- “`INFORMATION_SCHEMA Name`” indicates the name for the column in the `INFORMATION_SCHEMA` table. This corresponds to the standard SQL name unless the “Remarks” field says “MySQL extension.”
- “`SHOW Name`” indicates the equivalent field name in the closest `SHOW` statement, if there is one.
- “Remarks” provides additional information where applicable. If this field is `NULL`, it means that the value of the column is always `NULL`. If this field says “MySQL extension,” the column is a MySQL extension to standard SQL.

To avoid using any name that is reserved in the standard or in DB2, SQL Server, or Oracle, we changed the names of some columns marked “MySQL extension”. (For example, we changed `COLLATION` to `TABLE_COLLATION` in the `TABLES` table.) See the list of reserved words near the end of this article: [http://web.archive.org/web/20070409075643rn\\_1/www.dbazine.com/db2/db2-disarticles/gulutzan5](http://web.archive.org/web/20070409075643rn_1/www.dbazine.com/db2/db2-disarticles/gulutzan5).

The definition for character columns (for example, `TABLES.TABLE_NAME`) is generally `VARCHAR(N) CHARACTER SET utf8` where `N` is at least 64. MySQL uses the default collation for this character set (`utf8_general_ci`) for all searches, sorts, comparisons, and other string operations on such columns. If the default collation is not correct for your needs, you can force a suitable collation with a `COLLATE` clause (Section 9.1.6.1, “Using `COLLATE` in SQL Statements”).

Each section indicates what `SHOW` statement is equivalent to a `SELECT` that retrieves information from `INFORMATION_SCHEMA`, if there is such a statement. For `SHOW` statements that display information for the current database if you omit a `FROM db_name` clause, you can often select information for the current database by adding an `AND TABLE_SCHEMA = CURRENT_SCHEMA()` condition to the `WHERE` clause of a query that retrieves information from an `INFORMATION_SCHEMA` table.

### Note

At present, there are some missing columns and some columns out of order. We are working on this and updating the documentation as changes are made.

For answers to questions that are often asked concerning the `INFORMATION_SCHEMA` database, see Section A.7, “MySQL 5.0 FAQ — `INFORMATION_SCHEMA`”.

## 19.1. The `INFORMATION_SCHEMA SCHEMATA` Table

A schema is a database, so the `SCHEMATA` table provides information about databases.

<code>INFORMATION_SCHEMA Name</code>	<code>SHOW Name</code>	Remarks
<code>CATALOG_NAME</code>		<code>NULL</code>
<code>SCHEMA_NAME</code>		Database
<code>DEFAULT_CHARACTER_SET_NAME</code>		
<code>DEFAULT_COLLATION_NAME</code>		
<code>SQL_PATH</code>		<code>NULL</code>

The following statements are equivalent:

```
SELECT SCHEMA_NAME AS `Database`
FROM INFORMATION_SCHEMA.SCHEMATA
[WHERE SCHEMA_NAME LIKE 'wild']

SHOW DATABASES
[LIKE 'wild']
```

## 19.2. The `INFORMATION_SCHEMA TABLES` Table

The `TABLES` table provides information about tables in databases.

INFORMATION_SCHEMA Name	SHOW Name	Remarks
<code>TABLE_CATALOG</code>		<code>NULL</code>
<code>TABLE_SCHEMA</code>	<code>Table_...</code>	
<code>TABLE_NAME</code>	<code>Table_...</code>	
<code>TABLE_TYPE</code>		
<code>ENGINE</code>	<code>Engine</code>	MySQL extension
<code>VERSION</code>	<code>Version</code>	The version number of the table's <code>.frm</code> file, MySQL extension
<code>ROW_FORMAT</code>	<code>Row_format</code>	MySQL extension
<code>TABLE_ROWS</code>	<code>Rows</code>	MySQL extension
<code>AVG_ROW_LENGTH</code>	<code>Avg_row_length</code>	MySQL extension
<code>DATA_LENGTH</code>	<code>Data_length</code>	MySQL extension
<code>MAX_DATA_LENGTH</code>	<code>Max_data_length</code>	MySQL extension
<code>INDEX_LENGTH</code>	<code>Index_length</code>	MySQL extension
<code>DATA_FREE</code>	<code>Data_free</code>	MySQL extension
<code>AUTO_INCREMENT</code>	<code>Auto_increment</code>	MySQL extension
<code>CREATE_TIME</code>	<code>Create_time</code>	MySQL extension
<code>UPDATE_TIME</code>	<code>Update_time</code>	MySQL extension
<code>CHECK_TIME</code>	<code>Check_time</code>	MySQL extension
<code>TABLE_COLLATION</code>	<code>Collation</code>	MySQL extension
<code>CHECKSUM</code>	<code>Checksum</code>	MySQL extension
<code>CREATE_OPTIONS</code>	<code>Create_options</code>	MySQL extension
<code>TABLE_COMMENT</code>	<code>Comment</code>	MySQL extension

#### Notes:

- `TABLE_SCHEMA` and `TABLE_NAME` are a single field in a `SHOW` display, for example `Table_in_db1`.
- `TABLE_TYPE` should be `BASE TABLE` or `VIEW`. Currently, the `TABLES` table does not list `TEMPORARY` tables.
- For partitioned tables, beginning with MySQL 5.1.9, the `ENGINE` column shows the name of the storage engine used by all partitions. (Previously, this column showed `PARTITION` for such tables.)
- The `TABLE_ROWS` column is `NULL` if the table is in the `INFORMATION_SCHEMA` database.

For `InnoDB` tables, the row count is only a rough estimate used in SQL optimization. (This is also true if the `InnoDB` table is partitioned.)

- For tables using the `NDBCLUSTER` storage engine, beginning with MySQL 5.1.12, the `DATA_LENGTH` column reflects the true amount of storage for variable-width columns. (See [Bug#18413](#).)

#### Note

Because MySQL Cluster allocates storage for variable-width columns in 10-page extents of 32 kilobytes each, space usage for such columns is reported in increments of 320 KB.

- Beginning with MySQL 5.1.28, the `DATA_FREE` column shows the free space in bytes for `InnoDB` tables.
- We have nothing for the table's default character set. `TABLE_COLLATION` is close, because collation names begin with a character set name.
- Beginning with MySQL 5.1.9, the `CREATE_OPTIONS` column shows `partitioned` if the table is partitioned.

The following statements are equivalent:

```
SELECT table_name FROM INFORMATION_SCHEMA.TABLES
WHERE table_schema = 'db_name'
```

```
[AND table_name LIKE 'wild']
SHOW TABLES
FROM db_name
[LIKE 'wild']
```

## 19.3. The INFORMATION\_SCHEMA COLUMNS Table

The `COLUMNS` table provides information about columns in tables.

INFORMATION_SCHEMA Name	SHOW Name	Remarks
TABLE_CATALOG		NULL
TABLE_SCHEMA		
TABLE_NAME		
COLUMN_NAME	Field	
ORDINAL_POSITION		see notes
COLUMN_DEFAULT	Default	
IS_NULLABLE	Null	
DATA_TYPE	Type	
CHARACTER_MAXIMUM_LENGTH	Type	
CHARACTER_OCTET_LENGTH		
NUMERIC_PRECISION	Type	
NUMERIC_SCALE	Type	
CHARACTER_SET_NAME		
COLLATION_NAME	Collation	
COLUMN_TYPE	Type	MySQL extension
COLUMN_KEY	Key	MySQL extension
EXTRA	Extra	MySQL extension
PRIVILEGES	Privileges	MySQL extension
COLUMN_COMMENT	Comment	MySQL extension

### Notes:

- In `SHOW`, the `Type` display includes values from several different `COLUMNS` columns.
- `ORDINAL_POSITION` is necessary because you might want to say `ORDER BY ORDINAL_POSITION`. Unlike `SHOW, SELECT` does not have automatic ordering.
- `CHARACTER_OCTET_LENGTH` should be the same as `CHARACTER_MAXIMUM_LENGTH`, except for multi-byte character sets.
- `CHARACTER_SET_NAME` can be derived from `Collation`. For example, if you say `SHOW FULL COLUMNS FROM t`, and you see in the `Collation` column a value of `latin1_swedish_ci`, the character set is what is before the first underscore: `latin1`.

The following statements are nearly equivalent:

```
SELECT COLUMN_NAME, DATA_TYPE, IS_NULLABLE, COLUMN_DEFAULT
FROM INFORMATION_SCHEMA.COLUMNS
WHERE table_name = 'tbl_name'
[AND table_schema = 'db_name']
[AND column_name LIKE 'wild']

SHOW COLUMNS
FROM tbl_name
[FROM db_name]
[LIKE 'wild']
```

## 19.4. The INFORMATION\_SCHEMA STATISTICS Table

The `STATISTICS` table provides information about table indexes.



INFORMATION_SCHEMA Name	SHOW Name	Remarks
TABLE_CATALOG		NULL
TABLE_SCHEMA		= Database
TABLE_NAME	Table	
NON_UNIQUE	Non_unique	
INDEX_SCHEMA		= Database
INDEX_NAME	Key_name	
SEQ_IN_INDEX	Seq_in_index	
COLUMN_NAME	Column_name	
COLLATION	Collation	
CARDINALITY	Cardinality	
SUB_PART	Sub_part	MySQL extension
PACKED	Packed	MySQL extension
NULLABLE	Null	MySQL extension
INDEX_TYPE	Index_type	MySQL extension
COMMENT	Comment	MySQL extension

**Notes:**

- There is no standard table for indexes. The preceding list is similar to what SQL Server 2000 returns for `sp_statistics`, except that we replaced the name `QUALIFIER` with `CATALOG` and we replaced the name `OWNER` with `SCHEMA`.

Clearly, the preceding table and the output from `SHOW INDEX` are derived from the same parent. So the correlation is already close.

The following statements are equivalent:

```
SELECT * FROM INFORMATION_SCHEMA.STATISTICS
  WHERE table_name = 'tbl_name'
  AND table_schema = 'db_name'

SHOW INDEX
  FROM tbl_name
  FROM db_name
```

## 19.5. The INFORMATION\_SCHEMA USER\_PRIVILEGES Table

The `USER_PRIVILEGES` table provides information about global privileges. This information comes from the `mysql.user` grant table.

INFORMATION_SCHEMA Name	SHOW Name	Remarks
GRANTEE		'user_name'@'host_name' value, MySQL extension
TABLE_CATALOG		NULL, MySQL extension
PRIVILEGE_TYPE		MySQL extension
IS_GRANTABLE		MySQL extension

**Notes:**

- This is a non-standard table. It takes its values from the `mysql.user` table.

## 19.6. The INFORMATION\_SCHEMA SCHEMA\_PRIVILEGES Table

The `SCHEMA_PRIVILEGES` table provides information about schema (database) privileges. This information comes from the `mysql.db` grant table.

INFORMATION_SCHEMA Name	SHOW Name	Remarks
GRANTEE		'user_name'@'host_name' value, MySQL extension
TABLE_CATALOG		NULL, MySQL extension
TABLE_SCHEMA		MySQL extension
PRIVILEGE_TYPE		MySQL extension
IS_GRANTABLE		MySQL extension

**Notes:**

- This is a non-standard table. It takes its values from the `mysql.db` table.

## 19.7. The INFORMATION\_SCHEMA TABLE\_PRIVILEGES Table

The `TABLE_PRIVILEGES` table provides information about table privileges. This information comes from the `mysql.tables_priv` grant table.

INFORMATION_SCHEMA Name	SHOW Name	Remarks
GRANTEE		'user_name'@'host_name' value
TABLE_CATALOG		NULL
TABLE_SCHEMA		
TABLE_NAME		
PRIVILEGE_TYPE		
IS_GRANTABLE		

**Notes:**

- `PRIVILEGE_TYPE` can contain one (and only one) of these values: `SELECT`, `INSERT`, `UPDATE`, `REFERENCES`, `ALTER`, `INDEX`, `DROP`, `CREATE VIEW`.

The following statements are *not* equivalent:

```
SELECT ... FROM INFORMATION_SCHEMA.TABLE_PRIVILEGES
SHOW GRANTS ...
```

## 19.8. The INFORMATION\_SCHEMA COLUMN\_PRIVILEGES Table

The `COLUMN_PRIVILEGES` table provides information about column privileges. This information comes from the `mysql.columns_priv` grant table.

INFORMATION_SCHEMA Name	SHOW Name	Remarks
GRANTEE		'user_name'@'host_name' value
TABLE_CATALOG		NULL
TABLE_SCHEMA		
TABLE_NAME		
COLUMN_NAME		
PRIVILEGE_TYPE		
IS_GRANTABLE		

**Notes:**

- In the output from `SHOW FULL COLUMNS`, the privileges are all in one field and in lowercase, for example, `select, insert, update, references`. In `COLUMN_PRIVILEGES`, there is one privilege per row, in uppercase.
- `PRIVILEGE_TYPE` can contain one (and only one) of these values: `SELECT, INSERT, UPDATE, REFERENCES`.
- If the user has `GRANT OPTION` privilege, `IS_GRANTABLE` should be `YES`. Otherwise, `IS_GRANTABLE` should be `NO`. The output does not list `GRANT OPTION` as a separate privilege.

The following statements are *not* equivalent:

```
SELECT ... FROM INFORMATION_SCHEMA.COLUMN_PRIVILEGES
SHOW GRANTS ...
```

## 19.9. The INFORMATION\_SCHEMA CHARACTER\_SETS Table

The `CHARACTER_SETS` table provides information about available character sets.

INFORMATION_SCHEMA Name	SHOW Name	Remarks
<code>CHARACTER_SET_NAME</code>	<code>Charset</code>	
<code>DEFAULT_COLLATE_NAME</code>	<code>Default collation</code>	
<code>DESCRIPTION</code>	<code>Description</code>	MySQL extension
<code>MAXLEN</code>	<code>Maxlen</code>	MySQL extension

The following statements are equivalent:

```
SELECT * FROM INFORMATION_SCHEMA.CHARACTER_SETS
  [WHERE name LIKE 'wild']
SHOW CHARACTER SET
  [LIKE 'wild']
```

## 19.10. The INFORMATION\_SCHEMA COLLATIONS Table

The `COLLATIONS` table provides information about collations for each character set.

INFORMATION_SCHEMA Name	SHOW Name	Remarks
<code>COLLATION_NAME</code>	<code>Collation</code>	
<code>CHARACTER_SET_NAME</code>	<code>Charset</code>	MySQL extension
<code>ID</code>	<code>Id</code>	MySQL extension
<code>IS_DEFAULT</code>	<code>Default</code>	MySQL extension
<code>IS_COMPILED</code>	<code>Compiled</code>	MySQL extension
<code>SORTLEN</code>	<code>Sortlen</code>	MySQL extension

The following statements are equivalent:

```
SELECT COLLATION_NAME FROM INFORMATION_SCHEMA.COLLATIONS
  [WHERE collation_name LIKE 'wild']
SHOW COLLATION
  [LIKE 'wild']
```

## 19.11. The INFORMATION\_SCHEMA COLLATION\_CHARACTER\_SET\_APPLICABILITY Table

The `COLLATION_CHARACTER_SET_APPLICABILITY` table indicates what character set is applicable for what collation. The columns are equivalent to the first two display fields that we get from `SHOW COLLATION`.

INFORMATION_SCHEMA Name	SHOW Name	Remarks
<code>COLLATION_NAME</code>	<code>Collation</code>	

CHARACTER_SET_NAME	Charset	
--------------------	---------	--

## 19.12. The INFORMATION\_SCHEMA TABLE\_CONSTRAINTS Table

The `TABLE_CONSTRAINTS` table describes which tables have constraints.

INFORMATION_SCHEMA Name	SHOW Name	Remarks
CONSTRAINT_CATALOG		NULL
CONSTRAINT_SCHEMA		
CONSTRAINT_NAME		
TABLE_SCHEMA		
TABLE_NAME		
CONSTRAINT_TYPE		

### Notes:

- The `CONSTRAINT_TYPE` value can be `UNIQUE`, `PRIMARY KEY`, or `FOREIGN KEY`.
- The `UNIQUE` and `PRIMARY KEY` information is about the same as what you get from the `Key_name` field in the output from `SHOW INDEX` when the `Non_unique` field is 0.
- The `CONSTRAINT_TYPE` column can contain one of these values: `UNIQUE`, `PRIMARY KEY`, `FOREIGN KEY`, `CHECK`. This is a `CHAR` (not `ENUM`) column. The `CHECK` value is not available until we support `CHECK`.

## 19.13. The INFORMATION\_SCHEMA KEY\_COLUMN\_USAGE Table

The `KEY_COLUMN_USAGE` table describes which key columns have constraints.

INFORMATION_SCHEMA Name	SHOW Name	Remarks
CONSTRAINT_CATALOG		NULL
CONSTRAINT_SCHEMA		
CONSTRAINT_NAME		
TABLE_CATALOG		
TABLE_SCHEMA		
TABLE_NAME		
COLUMN_NAME		
ORDINAL_POSITION		
POSITION_IN_UNIQUE_CONSTRAINT		
REFERENCED_TABLE_SCHEMA		
REFERENCED_TABLE_NAME		
REFERENCED_COLUMN_NAME		

### Notes:

- If the constraint is a foreign key, then this is the column of the foreign key, not the column that the foreign key references.
- The value of `ORDINAL_POSITION` is the column's position within the constraint, not the column's position within the table. Column positions are numbered beginning with 1.
- The value of `POSITION_IN_UNIQUE_CONSTRAINT` is `NULL` for unique and primary-key constraints. For foreign-key constraints, it is the ordinal position in key of the table that is being referenced.

For example, suppose that there are two tables name `t1` and `t3` that have the following definitions:

```
CREATE TABLE t1
```

```
(
  s1 INT,
  s2 INT,
  s3 INT,
  PRIMARY KEY(s3)
) ENGINE=InnoDB;

CREATE TABLE t3
(
  s1 INT,
  s2 INT,
  s3 INT,
  KEY(s1),
  CONSTRAINT CO FOREIGN KEY (s2) REFERENCES t1(s3)
) ENGINE=InnoDB;
```

For those two tables, the `KEY_COLUMN_USAGE` table has two rows:

- One row with `CONSTRAINT_NAME = 'PRIMARY'`, `TABLE_NAME = 't1'`, `COLUMN_NAME = 's3'`, `ORDINAL_POSITION = 1`, `POSITION_IN_UNIQUE_CONSTRAINT = NULL`.
- One row with `CONSTRAINT_NAME = 'CO'`, `TABLE_NAME = 't3'`, `COLUMN_NAME = 's2'`, `ORDINAL_POSITION = 1`, `POSITION_IN_UNIQUE_CONSTRAINT = 1`.

## 19.14. The INFORMATION\_SCHEMA ROUTINES Table

The `ROUTINES` table provides information about stored routines (both procedures and functions). The `ROUTINES` table does not include user-defined functions (UDFs) at this time.

The column named “`mysql.proc name`” indicates the `mysql.proc` table column that corresponds to the `INFORMATION_SCHEMA.ROUTINES` table column, if any.

INFORMATION_SCHEMA Name	mysql.proc Name	Remarks
SPECIFIC_NAME	specific_name	
ROUTINE_CATALOG		NULL
ROUTINE_SCHEMA	db	
ROUTINE_NAME	name	
ROUTINE_TYPE	type	{PROCEDURE   FUNCTION}
DTD_IDENTIFIER		data type descriptor
ROUTINE_BODY		SQL
ROUTINE_DEFINITION	body	
EXTERNAL_NAME		NULL
EXTERNAL_LANGUAGE	language	NULL
PARAMETER_STYLE		SQL
IS_DETERMINISTIC	is_deterministic	
SQL_DATA_ACCESS	sql_data_access	
SQL_PATH		NULL
SECURITY_TYPE	security_type	
CREATED	created	
LAST_ALTERED	modified	
SQL_MODE	sql_mode	MySQL extension
ROUTINE_COMMENT	comment	MySQL extension
DEFINER	definer	MySQL extension
CHARACTER_SET_CLIENT		MySQL extension
COLLATION_CONNECTION		MySQL extension
DATABASE_COLLATION		MySQL extension

Notes:

- MySQL calculates `EXTERNAL_LANGUAGE` thus:
  - If `mysql.proc.language='SQL'`, `EXTERNAL_LANGUAGE` is `NULL`
  - Otherwise, `EXTERNAL_LANGUAGE` is what is in `mysql.proc.language`. However, we do not have external languages yet, so it is always `NULL`.
- `CHARACTER_SET_CLIENT` is the session value of the `character_set_client` system variable when the routine was created. `COLLATION_CONNECTION` is the session value of the `collation_connection` system variable when the routine was created. `DATABASE_COLLATION` is the collation of the database with which the routine is associated. These columns were added in MySQL 5.1.21.

## 19.15. The INFORMATION\_SCHEMA VIEWS Table

The `VIEWS` table provides information about views in databases. You must have the `SHOW VIEW` privilege to access this table.

INFORMATION_SCHEMA Name	SHOW Name	Remarks
<code>TABLE_CATALOG</code>		<code>NULL</code>
<code>TABLE_SCHEMA</code>		
<code>TABLE_NAME</code>		
<code>VIEW_DEFINITION</code>		
<code>CHECK_OPTION</code>		
<code>IS_UPDATABLE</code>		
<code>DEFINER</code>		
<code>SECURITY_TYPE</code>		
<code>CHARACTER_SET_CLIENT</code>		MySQL extension
<code>COLLATION_CONNECTION</code>		MySQL extension

### Notes:

- The `VIEW_DEFINITION` column has most of what you see in the `Create Table` field that `SHOW CREATE VIEW` produces. Skip the words before `SELECT` and skip the words `WITH CHECK OPTION`. Suppose that the original statement was:

```
CREATE VIEW v AS
SELECT s2,s1 FROM t
WHERE s1 > 5
ORDER BY s1
WITH CHECK OPTION;
```

Then the view definition looks like this:

```
SELECT s2,s1 FROM t WHERE s1 > 5 ORDER BY s1
```

- The `CHECK_OPTION` column has a value of `NONE`, `CASCADE`, or `LOCAL`.
- MySQL sets a flag, called the view updatability flag, at `CREATE VIEW` time. The flag is set to `YES` (true) if `UPDATE` and `DELETE` (and similar operations) are legal for the view. Otherwise, the flag is set to `NO` (false). The `IS_UPDATABLE` column in the `VIEWS` table displays the status of this flag. It means that the server always knows whether a view is updatable. If the view is not updatable, statements such `UPDATE`, `DELETE`, and `INSERT` are illegal and will be rejected. (Note that even if a view is updatable, it might not be possible to insert into it; for details, refer to [Section 12.1.20](#), “`CREATE VIEW Syntax`”.)
- The `DEFINER` column indicates who defined the view. `SECURITY_TYPE` has a value of `DEFINER` or `INVOKER`.
- `CHARACTER_SET_CLIENT` is the session value of the `character_set_client` system variable when the view was created. `COLLATION_CONNECTION` is the session value of the `collation_connection` system variable when the view was created. These columns were added in MySQL 5.1.21.

MySQL lets you use different `sql_mode` settings to tell the server the type of SQL syntax to support. For example, you might use the `ANSI SQL` mode to ensure MySQL correctly interprets the standard SQL concatenation operator, the double bar (`||`), in your queries. If you then create a view that concatenates items, you might worry that changing the `sql_mode` setting to a value different from `ANSI` could cause the view to become invalid. But this is not the case. No matter how you write out a view definition,

MySQL always stores it the same way, in a canonical form. Here is an example that shows how the server changes a double bar concatenation operator to a `CONCAT()` function:

```
mysql> SET sql_mode = 'ANSI';
Query OK, 0 rows affected (0.00 sec)

mysql> CREATE VIEW test.v AS SELECT 'a' || 'b' as coll;
Query OK, 0 rows affected (0.00 sec)

mysql> SELECT VIEW_DEFINITION FROM INFORMATION_SCHEMA.VIEWS
-> WHERE TABLE_SCHEMA = 'test' AND TABLE_NAME = 'v';
+-----+
| VIEW_DEFINITION |
+-----+
| select concat('a','b') AS `coll` |
+-----+
1 row in set (0.00 sec)
```

The advantage of storing a view definition in canonical form is that changes made later to the value of `sql_mode` will not affect the results from the view. However an additional consequence is that comments prior to `SELECT` are stripped from the definition by the server.

## 19.16. The INFORMATION\_SCHEMA TRIGGERS Table

The `TRIGGERS` table provides information about triggers. You must have the `TRIGGER` privilege to access this table (prior to MySQL 5.1.22, you must have the `SUPER` privilege).

INFORMATION_SCHEMA Name	SHOW Name	Remarks
TRIGGER_CATALOG		NULL
TRIGGER_SCHEMA		
TRIGGER_NAME	Trigger	
EVENT_MANIPULATION	Event	
EVENT_OBJECT_CATALOG		NULL
EVENT_OBJECT_SCHEMA		
EVENT_OBJECT_TABLE	Table	
ACTION_ORDER		0
ACTION_CONDITION		NULL
ACTION_STATEMENT	Statement	
ACTION_ORIENTATION		ROW
ACTION_TIMING	Timing	
ACTION_REFERENCE_OLD_TABLE		NULL
ACTION_REFERENCE_NEW_TABLE		NULL
ACTION_REFERENCE_OLD_ROW		OLD
ACTION_REFERENCE_NEW_ROW		NEW
CREATED		NULL (0)
SQL_MODE		MySQL extension
DEFINER		MySQL extension
CHARACTER_SET_CLIENT		MySQL extension
COLLATION_CONNECTION		MySQL extension
DATABASE_COLLATION		MySQL extension

**Notes:**

- The `TRIGGER_SCHEMA` and `TRIGGER_NAME` columns contain the name of the database in which the trigger occurs and the trigger name, respectively.
- The `EVENT_MANIPULATION` column contains one of the values `'INSERT'`, `'DELETE'`, or `'UPDATE'`.
- As noted in Section 18.3, “Using Triggers”, every trigger is associated with exactly one table. The `EVENT_OBJECT_SCHEMA` and `EVENT_OBJECT_TABLE` columns contain the database in which this table occurs, and the table's name.

- The `ACTION_ORDER` statement contains the ordinal position of the trigger's action within the list of all similar triggers on the same table. Currently, this value is always 0, because it is not possible to have more than one trigger with the same `EVENT_MANIPULATION` and `ACTION_TIMING` on the same table.
- The `ACTION_STATEMENT` column contains the statement to be executed when the trigger is invoked. This is the same as the text displayed in the `Statement` column of the output from `SHOW TRIGGERS`. Note that this text uses UTF-8 encoding.
- The `ACTION_ORIENTATION` column always contains the value 'ROW'.
- The `ACTION_TIMING` column contains one of the two values 'BEFORE' or 'AFTER'.
- The columns `ACTION_REFERENCE_OLD_ROW` and `ACTION_REFERENCE_NEW_ROW` contain the old and new column identifiers, respectively. This means that `ACTION_REFERENCE_OLD_ROW` always contains the value 'OLD' and `ACTION_REFERENCE_NEW_ROW` always contains the value 'NEW'.
- The `SQL_MODE` column shows the server SQL mode that was in effect at the time when the trigger was created (and thus which remains in effect for this trigger whenever it is invoked, *regardless of the current server SQL mode*). The possible range of values for this column is the same as that of the `sql_mode` system variable. See [Section 5.1.7, “Server SQL Modes”](#).
- The `DEFINER` column was added in MySQL 5.1.2. `DEFINER` indicates who defined the trigger.
- `CHARACTER_SET_CLIENT` is the session value of the `character_set_client` system variable when the trigger was created. `COLLATION_CONNECTION` is the session value of the `collation_connection` system variable when the trigger was created. `DATABASE_COLLATION` is the collation of the database with which the trigger is associated. These columns were added in MySQL 5.1.21.
- The following columns currently always contain NULL: `TRIGGER_CATALOG`, `EVENT_OBJECT_CATALOG`, `ACTION_CONDITION`, `ACTION_REFERENCE_OLD_TABLE`, `ACTION_REFERENCE_NEW_TABLE`, and `CREATED`.

Example, using the `ins_sum` trigger defined in [Section 18.3, “Using Triggers”](#):

```
mysql> SELECT * FROM INFORMATION_SCHEMA.TRIGGERS\G
***** 1. row *****
      TRIGGER_CATALOG: NULL
      TRIGGER_SCHEMA: test
      TRIGGER_NAME:   ins_sum
      EVENT_MANIPULATION: INSERT
      EVENT_OBJECT_CATALOG: NULL
      EVENT_OBJECT_SCHEMA: test
      EVENT_OBJECT_TABLE: account
      ACTION_ORDER: 0
      ACTION_CONDITION: NULL
      ACTION_STATEMENT: SET @sum = @sum + NEW.amount
      ACTION_ORIENTATION: ROW
      ACTION_TIMING: BEFORE
      ACTION_REFERENCE_OLD_TABLE: NULL
      ACTION_REFERENCE_NEW_TABLE: NULL
      ACTION_REFERENCE_OLD_ROW: OLD
      ACTION_REFERENCE_NEW_ROW: NEW
      CREATED: NULL
      SQL_MODE:
      DEFINER: me@localhost
```

See also [Section 12.5.5.40, “SHOW TRIGGERS Syntax”](#).

## 19.17. The INFORMATION\_SCHEMA PLUGINS Table

The `PLUGINS` table provides information about server plugins.

INFORMATION_SCHEMA Name	SHOW Name	Remarks
<code>PLUGIN_NAME</code>	Name	MySQL extension
<code>PLUGIN_VERSION</code>		MySQL extension
<code>PLUGIN_STATUS</code>	Status	MySQL extension
<code>PLUGIN_TYPE</code>	Type	MySQL extension
<code>PLUGIN_TYPE_VERSION</code>		MySQL extension
<code>PLUGIN_LIBRARY</code>	Library	MySQL extension
<code>PLUGIN_LIBRARY_VERSION</code>		MySQL extension
<code>PLUGIN_AUTHOR</code>		MySQL extension
<code>PLUGIN_DESCRIPTION</code>		MySQL extension



PLUGIN_LICENSE		MySQL extension
----------------	--	-----------------

**Notes:**

- The `PLUGINS` table is a non-standard table. It was added in MySQL 5.1.5.
- The `PLUGIN_LICENSE` column was added in MySQL 5.1.12.

See also [Section 12.5.5.27, “SHOW PLUGINS Syntax”](#).

## 19.18. The INFORMATION\_SCHEMA ENGINES Table

The `PLUGINS` table provides information about storage engines.

INFORMATION_SCHEMA Name	SHOW Name	Remarks
ENGINE	Engine	MySQL extension
SUPPORT	Support	MySQL extension
COMMENT	Comment	MySQL extension
TRANSACTIONS	Transactions	MySQL extension
XA	XA	MySQL extension
SAVEPOINTS	Savepoints	MySQL extension

**Notes:**

- The `ENGINES` table is a non-standard table. It was added in MySQL 5.1.5.

See also [Section 12.5.5.17, “SHOW ENGINES Syntax”](#).

## 19.19. The INFORMATION\_SCHEMA PARTITIONS Table

The `PARTITIONS` table provides information about table partitions. See [Chapter 17, Partitioning](#), for more information about partitioning tables.

INFORMATION_SCHEMA Name	SHOW Name	Remarks
TABLE_CATALOG		MySQL extension
TABLE_SCHEMA		MySQL extension
TABLE_NAME		MySQL extension
PARTITION_NAME		MySQL extension
SUBPARTITION_NAME		MySQL extension
PARTITION_ORDINAL_POSITION		MySQL extension
SUBPARTITION_ORDINAL_POSITION		MySQL extension
PARTITION_METHOD		MySQL extension
SUBPARTITION_METHOD		MySQL extension
PARTITION_EXPRESSION		MySQL extension
SUBPARTITION_EXPRESSION		MySQL extension
PARTITION_DESCRIPTION		MySQL extension
TABLE_ROWS		MySQL extension
AVG_ROW_LENGTH		MySQL extension
DATA_LENGTH		MySQL extension
MAX_DATA_LENGTH		MySQL extension
INDEX_LENGTH		MySQL extension
DATA_FREE		MySQL extension

CREATE_TIME		MySQL extension
UPDATE_TIME		MySQL extension
CHECK_TIME		MySQL extension
CHECKSUM		MySQL extension
PARTITION_COMMENT		MySQL extension
NODEGROUP		MySQL extension
TABLESPACE_NAME		MySQL extension

**Notes:**

- The `PARTITIONS` table is a non-standard table. It was added in MySQL 5.1.6.  
Each record in this table corresponds to an individual partition or subpartition of a partitioned table.
- `TABLE_CATALOG`: This column is always `NULL`.
- `TABLE_SCHEMA`: This column contains the name of the database to which the table belongs.
- `TABLE_NAME`: This column contains the name of the table containing the partition.
- `PARTITION_NAME`: The name of the partition.
- `SUBPARTITION_NAME`: If the `PARTITIONS` table record represents a subpartition, then this column contains the name of subpartition; otherwise it is `NULL`.
- `PARTITION_ORDINAL_POSITION`: All partitions are indexed in the same order as they are defined, with `1` being the number assigned to the first partition. The indexing can change as partitions are added, dropped, and reorganized; the number shown in this column reflects the current order, taking into account any indexing changes.
- `SUBPARTITION_ORDINAL_POSITION`: Subpartitions within a given partition are also indexed and reindexed in the same manner as partitions are indexed within a table.
- `PARTITION_METHOD`: One of the values `RANGE`, `LIST`, `HASH`, `LINEAR HASH`, `KEY`, or `LINEAR KEY`; that is, one of the available partitioning types as discussed in [Section 17.2, “Partition Types”](#).
- `SUBPARTITION_METHOD`: One of the values `HASH`, `LINEAR HASH`, `KEY`, or `LINEAR KEY`; that is, one of the available subpartitioning types as discussed in [Section 17.2.5, “Subpartitioning”](#).
- `PARTITION_EXPRESSION`: This is the expression for the partitioning function used in the `CREATE TABLE` or `ALTER TABLE` statement that created the table's current partitioning scheme.

For example, consider a partitioned table created in the `test` database using this statement:

```
CREATE TABLE tp (
  c1 INT,
  c2 INT,
  c3 VARCHAR(25)
)
PARTITION BY HASH(c1 + c2)
PARTITIONS 4;
```

The `PARTITION_EXPRESSION` column in a `PARTITIONS` table record for a partition from this table displays `c1 + c2`, as shown here:

```
mysql> SELECT DISTINCT PARTITION_EXPRESSION
> FROM INFORMATION_SCHEMA.PARTITIONS
> WHERE TABLE_NAME='tp' AND TABLE_SCHEMA='test';
+-----+
| PARTITION_EXPRESSION |
+-----+
| c1 + c2              |
+-----+
1 row in set (0.09 sec)
```

- `SUBPARTITION_EXPRESSION`: This works in the same fashion for the subpartitioning expression that defines the subpartitioning for a table as `PARTITION_EXPRESSION` does for the partitioning expression used to define a table's partitioning.

If the table has no subpartitions, then this column is `NULL`.

- **PARTITION\_DESCRIPTION**: This column is used for RANGE and LIST partitions. For a RANGE partition, it contains the value set in the partition's VALUES LESS THAN clause, which can be either an integer or MAXVALUE. For a LIST partition, this column contains the values defined in the partition's VALUES IN clause, which is a comma-separated list of integer values.

For partitions whose PARTITION\_METHOD is other than RANGE or LIST, this column is always NULL.

- **TABLE\_ROWS**: The number of table rows in the partition.

For partitioned InnoDB tables, the row count given in the TABLE\_ROWS column is only an estimated value used in SQL optimization, and may not always be exact.

- **AVG\_ROW\_LENGTH**: The average length of the rows stored in this partition or subpartition, in bytes.

This is the same as DATA\_LENGTH divided by TABLE\_ROWS.

- **DATA\_LENGTH**: The total length of all rows stored in this partition or subpartition, in bytes — that is, the total number of bytes stored in the partition or subpartition.
- **MAX\_DATA\_LENGTH**: The maximum number of bytes that can be stored in this partition or subpartition.
- **INDEX\_LENGTH**: The length of the index file for this partition or subpartition, in bytes.
- **DATA\_FREE**: The number of bytes allocated to the partition or subpartition but not used.
- **CREATE\_TIME**: The time of the partition's or subpartition's creation.
- **UPDATE\_TIME**: The time that the partition or subpartition was last modified.
- **CHECK\_TIME**: The last time that the table to which this partition or subpartition belongs was checked.

**Note**

Some storage engines do not update this time; for tables using these storage engines, this value is always NULL.

- **CHECKSUM**: The checksum value, if any; otherwise, this column is NULL.
- **PARTITION\_COMMENT**: This column contains the text of any comment made for the partition.

The default value for this column is an empty string.

- **NODEGROUP**: This is the nodegroup to which the partition belongs. This is relevant only to MySQL Cluster tables; otherwise the value of this column is always 0.
- **TABLESPACE\_NAME**: This column contains the name of tablespace to which the partition belongs. In MySQL 5.1, the value of this column is always DEFAULT.

**Important**

If any partitioned tables created in a MySQL version prior to MySQL 5.1.6 are present following an upgrade to MySQL 5.1.6 or later, it is not possible to SELECT from, SHOW, or DESCRIBE the PARTITIONS table. See Section C.2.32, “Changes in MySQL 5.1.6 (01 February 2006)” before upgrading from MySQL 5.1.5 or earlier to MySQL 5.1.6 or later.

- A non-partitioned table has one record in INFORMATION\_SCHEMA.PARTITIONS; however, the values of the PARTITION\_NAME, SUBPARTITION\_NAME, PARTITION\_ORDINAL\_POSITION, SUBPARTITION\_ORDINAL\_POSITION, PARTITION\_METHOD, SUBPARTITION\_METHOD, PARTITION\_EXPRESSION, SUBPARTITION\_EXPRESSION, and PARTITION\_DESCRIPTION columns are all NULL. (The PARTITION\_COMMENT column in this case is blank.)

In MySQL 5.1, there is also only one record in the PARTITIONS table for a table using the NDBCLUSTER storage engine. The same columns are also NULL (or empty) as for a non-partitioned table.

## 19.20. The INFORMATION\_SCHEMA EVENTS Table

The EVENTS table provides information about scheduled events, which are discussed in Section 18.4, “Using the Event Scheduler”.

INFORMATION_SCHEMA Name	SHOW Name	Remarks
-------------------------	-----------	---------

EVENT_CATALOG		NULL, MySQL extension
EVENT_SCHEMA	Db	MySQL extension
EVENT_NAME	Name	MySQL extension
DEFINER	Definer	MySQL extension
TIME_ZONE	Time zone	MySQL extension
EVENT_BODY		MySQL extension
EVENT_DEFINITION		MySQL extension
EVENT_TYPE	Type	MySQL extension
EXECUTE_AT	Execute at	MySQL extension
INTERVAL_VALUE	Interval value	MySQL extension
INTERVAL_FIELD	Interval field	MySQL extension
SQL_MODE		MySQL extension
STARTS	Starts	MySQL extension
ENDS	Ends	MySQL extension
STATUS	Status	MySQL extension
ON_COMPLETION		MySQL extension
CREATED		MySQL extension
LAST_ALTERED		MySQL extension
LAST_EXECUTED		MySQL extension
EVENT_COMMENT		MySQL extension
ORIGINATOR	Originator	MySQL extension
CHARACTER_SET_CLIENT		MySQL extension
COLLATION_CONNECTION		MySQL extension
DATABASE_COLLATION		MySQL extension

**Notes:**

- The `EVENTS` table is a non-standard table. It was added in MySQL 5.1.6.
- `EVENT_CATALOG`: The value of this column is always `NULL`.
- `EVENT_SCHEMA`: The name of the schema (database) to which this event belongs.
- `EVENT_NAME`: The name of the event.
- `DEFINER`: The user who created the event. Always displayed in '`user_name`'@'`host_name`' format.
- `TIME_ZONE`: The time zone in effect when schedule for the event was last modified. If the event's schedule has not been modified since the event was created, then this is the time zone that was in effect at the event's creation. The default value is `SYS-TEM`.

This column was added in MySQL 5.1.17. See [Section C.2.21, “Changes in MySQL 5.1.17 \(04 April 2007\)”](#), for important information if you are using the Event Scheduler and are upgrading from MySQL 5.1.16 (or earlier) to MySQL 5.1.17 (or later).

- `EVENT_BODY`: The language used for the statements in the event's `DO` clause; in MySQL 5.1, this is always `SQL`.

This column was added in MySQL 5.1.12. It is not to be confused with the column of the same name (now named `EVENT_DEFINITION`) that existed in earlier MySQL versions.

- `EVENT_DEFINITION`: The text of the SQL statement making up the event's `DO` clause; in other words, the statement executed by this event.

**Note**

Prior to MySQL 5.1.12, this column was named `EVENT_BODY`.

- `EVENT_TYPE`: One of the two values `ONE TIME` or `RECURRING`.

- **EXECUTE\_AT:** For a one-time event, this is the `DATETIME` value specified in the `AT` clause of the `CREATE EVENT` statement used to create the event, or of the last `ALTER EVENT` statement that modified the event. The value shown in this column reflects the addition or subtraction of any `INTERVAL` value included in the event's `AT` clause. For example, if an event is created using `ON SCHEDULE AT CURRENT_TIMESTAMP + '1:6' DAY_HOUR`, and the event was created at 2006-02-09 14:05:30, the value shown in this column would be `'2006-02-10 20:05:30'`.

If the event's timing is determined by an `EVERY` clause instead of an `AT` clause (that is, if the event is recurring), the value of this column is `NULL`.

- **INTERVAL\_VALUE:** For recurring events, this column contains the numeric portion of the event's `EVERY` clause.

For a one-time event (that is, an event whose timing is determined by an `AT` clause), this column's value is `NULL`.

- **INTERVAL\_FIELD:** For recurring events, this column contains the units portion of the `EVERY` clause governing the timing of the event. Thus, this column contains a value such as `'YEAR'`, `'QUARTER'`, `'DAY'`, and so on.

### Note

In early MySQL 5.1 releases, this value was prefixed with `'INTERVAL_'`, and was displayed as `'INTERVAL_YEAR'`, `'INTERVAL_QUARTER'`, `'INTERVAL_DAY'`, and so on.

For a one-time event (that is, an event whose timing is determined by an `AT` clause), this column's value is `NULL`.

- **SQL\_MODE:** The SQL mode in effect at the time the event was created or altered.
- **STARTS:** For a recurring event whose definition includes a `STARTS` clause, this column contains the corresponding `DATE-TIME` value. As with the `EXECUTE_AT` column, this value resolves any expressions used.

If there is no `STARTS` clause affecting the timing of the event, this column is empty. (Prior to MySQL 5.1.8, it contained `NULL` in such cases.)

- **ENDS:** For a recurring event whose definition includes a `ENDS` clause, this column contains the corresponding `DATETIME` value. As with the `EXECUTE_AT` column (see previous example), this value resolves any expressions used.

If there is no `ENDS` clause affecting the timing of the event, this column contains `NULL`.

- **STATUS:** One of the three values `ENABLED`, `DISABLED`, or `SLAVESIDE_DISABLED`.

`SLAVESIDE_DISABLED` was added to the list of possible values for this column in MySQL 5.1.18. This value indicates that the creation of the event occurred on another MySQL server acting as a replication master and was replicated to the current MySQL server which is acting as a slave, but the event is not presently being executed on the slave. See [Section 16.3.1.7, “Replication of Invoked Features”](#), for more information.

- **ON\_COMPLETION:** One of the two values `PRESERVE` or `NOT PRESERVE`.
- **CREATED:** The date and time when the event was created. This is a `DATETIME` value.
- **LAST\_ALTERED:** The date and time when the event was last modified. This is a `DATETIME` value. If the event has not been modified since its creation, this column holds the same value as the `CREATED` column.
- **LAST\_EXECUTED:** The date and time when the event last executed. A `DATETIME` value. If the event has never executed, this column's value is `NULL`.

Before MySQL 5.1.23, `LAST_EXECUTED` indicates when event finished executing. As of 5.1.23, `LAST_EXECUTED` instead indicates when the event started. As a result, the `ENDS` column is never less than `LAST_EXECUTED`.

- **EVENT\_COMMENT:** The text of a comment, if the event has one. If there is no comment, the value of this column is an empty string.
- **ORIGINATOR:** The server ID of the MySQL server on which the event was created; used in replication. The default value is 0. This column was added in MySQL 5.1.18.
- **CHARACTER\_SET\_CLIENT** is the session value of the `character_set_client` system variable when the event was created. **COLLATION\_CONNECTION** is the session value of the `collation_connection` system variable when the event was created. **DATABASE\_COLLATION** is the collation of the database with which the event is associated. These columns were added in MySQL 5.1.21.

**Example:** Suppose the user `jon@ghidora` creates an event named `e_daily`, and then modifies it a few minutes later using an `ALTER EVENT` statement, as shown here:

```
DELIMITER |
```

```

CREATE EVENT e_daily
ON SCHEDULE
EVERY 1 DAY
COMMENT 'Saves total number of sessions then clears the table each day'
DO
BEGIN
INSERT INTO site_activity.totals (time, total)
SELECT CURRENT_TIMESTAMP, COUNT(*)
FROM site_activity.sessions;
DELETE FROM site_activity.sessions;
END |
DELIMITER ;

ALTER EVENT e_daily
ENABLED;

```

(Note that comments can span multiple lines.)

This user can then run the following `SELECT` statement, and obtain the output shown:

```

mysql> SELECT * FROM INFORMATION_SCHEMA.EVENTS
> WHERE EVENT_NAME = 'e_daily'
> AND EVENT_SCHEMA = 'myschema'\G
***** 1. row *****
EVENT_CATALOG: NULL
EVENT_SCHEMA: test
EVENT_NAME: e_daily
DEFINER: paul@localhost
TIME_ZONE: SYSTEM
EVENT_BODY: SQL
EVENT_DEFINITION: BEGIN
INSERT INTO site_activity.totals (time, total)
SELECT CURRENT_TIMESTAMP, COUNT(*)
FROM site_activity.sessions;
DELETE FROM site_activity.sessions;
END
EVENT_TYPE: RECURRING
EXECUTE_AT: NULL
INTERVAL_VALUE: 1
INTERVAL_FIELD: DAY
SQL_MODE:
STARTS: 2008-09-03 12:13:39
ENDS: NULL
STATUS: ENABLED
ON_COMPLETION: NOT PRESERVE
CREATED: 2008-09-03 12:13:39
LAST_ALTERED: 2008-09-03 12:13:39
LAST_EXECUTED: NULL
EVENT_COMMENT: Saves total number of sessions then clears the
table each day
ORIGINATOR: 1
CHARACTER_SET_CLIENT: latin1
COLLATION_CONNECTION: latin1_swedish_ci
DATABASE_COLLATION: latin1_swedish_ci

```

Prior to MySQL 5.1.17, the times displayed in the `STARTS`, `ENDS`, and `LAST_EXECUTED` columns were given in terms of Universal Time (GMT or UTC), regardless of the server's time zone setting ([Bug#16420](#)). Beginning with MySQL 5.1.17, these times are all given in terms of local time as determined by the MySQL server's `time_zone` setting. (The same was true of the `starts`, `ends`, and `last_executed` columns of the `mysql.event` table as well as the `Starts` and `Ends` columns in the output of `SHOW [FULL] EVENTS`.)

The `CREATED` and `LAST_ALTERED` columns use the server time zone (as do the `created` and `last_altered` columns of the `mysql.event` table).

See also [Section 12.5.5.19](#), “`SHOW EVENTS Syntax`”.

## 19.21. The INFORMATION\_SCHEMA FILES Table

The `FILES` table provides information about the files in which MySQL NDB Disk Data tables are stored.

INFORMATION_SCHEMA Name	SHOW Name	Remarks
<code>FILE_ID</code>		MySQL extension
<code>FILE_NAME</code>		MySQL extension
<code>FILE_TYPE</code>		MySQL extension
<code>TABLESPACE_NAME</code>		MySQL extension
<code>TABLE_CATALOG</code>		MySQL extension
<code>TABLE_SCHEMA</code>		MySQL extension

TABLE_NAME		MySQL extension
LOGFILE_GROUP_NAME		MySQL extension
LOGFILE_GROUP_NUMBER		MySQL extension
ENGINE		MySQL extension
FULLTEXT_KEYS		MySQL extension
DELETED_ROWS		MySQL extension
UPDATE_COUNT		MySQL extension
FREE_EXTENTS		MySQL extension
TOTAL_EXTENTS		MySQL extension
EXTENT_SIZE		MySQL extension
INITIAL_SIZE		MySQL extension
MAXIMUM_SIZE		MySQL extension
AUTOEXTEND_SIZE		MySQL extension
CREATION_TIME		MySQL extension
LAST_UPDATE_TIME		MySQL extension
LAST_ACCESS_TIME		MySQL extension
RECOVER_TIME		MySQL extension
TRANSACTION_COUNTER		MySQL extension
VERSION		MySQL extension
ROW_FORMAT		MySQL extension
TABLE_ROWS		MySQL extension
AVG_ROW_LENGTH		MySQL extension
DATA_LENGTH		MySQL extension
MAX_DATA_LENGTH		MySQL extension
INDEX_LENGTH		MySQL extension
DATA_FREE		MySQL extension
CREATE_TIME		MySQL extension
UPDATE_TIME		MySQL extension
CHECK_TIME		MySQL extension
CHECKSUM		MySQL extension
STATUS		MySQL extension
EXTRA		MySQL extension

**Notes:**

- `FILE_ID` column values are auto-generated.
- `FILE_NAME` is the name of an `UNDO` log file created by `CREATE LOGFILE GROUP` or `ALTER LOGFILE GROUP`, or of a data file created by `CREATE TABLESPACE` or `ALTER TABLESPACE`.
- `FILE_TYPE` is one of the values `UNDOFILE` or `DATAFILE`.
- `TABLESPACE_NAME` is the name of the tablespace with which the file is associated.
- Currently, the value of the `TABLESPACE_CATALOG` column is always `NULL`.
- `TABLE_NAME` is the name of the Disk Data table with which the file is associated, if any.
- The `LOGFILE_GROUP_NAME` column gives the name of the log file group to which the log file or data file belongs.
- For an `UNDO` log file, the `LOGFILE_GROUP_NUMBER` contains the auto-generated ID number of the log file group to which the log file belongs.
- For a MySQL Cluster Disk Data log file or data file, the value of the `ENGINE` column is always `NDB` or `NDBCLUSTER`.

- For a MySQL Cluster Disk Data log file or data file, the value of the `FULLTEXT_KEYS` column is always empty.
- The `FREE_EXTENTS` column displays the number of extents which have not yet been used by the file. The `TOTAL_EXTENTS` column show the total number of extents allocated to the file.

The difference between these two columns is the number of extents currently in use by the file:

```
SELECT TOTAL_EXTENTS - FREE_EXTENTS AS extents_used
FROM INFORMATION_SCHEMA.FILES
WHERE FILE_NAME = 'myfile.dat';
```

You can approximate the amount of disk space in use by the file by multiplying this difference by the value of the `EXTENT_SIZE` column, which gives the size of an extent for the file in bytes:

```
SELECT (TOTAL_EXTENTS - FREE_EXTENTS) * EXTENT_SIZE AS bytes_used
FROM INFORMATION_SCHEMA.FILES
WHERE FILE_NAME = 'myfile.dat';
```

Similarly, you can estimate the amount of space that remains available in a given file by multiplying `FREE_EXTENTS` by `EXTENT_SIZE`:

```
SELECT FREE_EXTENTS * EXTENT_SIZE AS bytes_free
FROM INFORMATION_SCHEMA.FILES
WHERE FILE_NAME = 'myfile.dat';
```

### Important

The byte values produced by the preceding queries are approximations only, and their precision is inversely proportional to the value of `EXTENT_SIZE`. That is, the larger `EXTENT_SIZE` becomes, the less accurate the approximations are.

It is also important to remember that once an extent is used, it cannot be freed again without dropping the data file of which it is a part. This means that deletes from a Disk Data table do *not* release disk space.

The extent size can be set in a `CREATE TABLESPACE` statement. See [Section 12.1.18, “CREATE TABLESPACE Syntax”](#), for more information.

- The `INITIAL_SIZE` column shows the size in bytes of the file. This is the same value that was used in the `INITIAL_SIZE` clause of the `CREATE LOGFILE GROUP`, `ALTER LOGFILE GROUP`, `CREATE TABLESPACE`, or `ALTER TABLESPACE` statement used to create the file.

For MySQL Cluster Disk Data files, the value of the `MAXIMUM_SIZE` column is always the same as `INITIAL_SIZE`, and the `AUTOEXTEND_SIZE` column is always empty.

- The `CREATION_TIME` column shows the date and time when the file was created. The `LAST_UPDATE_TIME` column displays the date and time when the file was last modified. The `LAST_ACCESSED` column provides the date and time when the file was last accessed by the server.

Currently, the values of these columns are as reported by the operating system, and are not supplied by the NDB storage engine. Where no value is provided by the operating system, these columns display `0000-00-00 00:00:00`.

- For MySQL Cluster Disk Data files, the value of the `RECOVER_TIME` and `TRANSACTION_COUNTER` columns is always 0.
- For MySQL Cluster Disk Data files, the following columns are always `NULL`:
  - `VERSION`
  - `ROW_FORMAT`
  - `TABLE_ROWS`
  - `AVG_ROW_LENGTH`
  - `DATA_LENGTH`
  - `MAX_DATA_LENGTH`
  - `INDEX_LENGTH`
  - `DATA_FREE`
  - `CREATE_TIME`



- `UPDATE_TIME`
- `CHECK_TIME`
- `CHECKSUM`
- For MySQL Cluster Disk Data files, the value of the `STATUS` column is always `NORMAL`.
- For MySQL Cluster Disk Data files, the `EXTRA` column shows which data node the file belongs to, as each data node has its own copy of the file. For example, suppose you use this statement on a MySQL Cluster with four data nodes:

```
CREATE LOGFILE GROUP mygroup
  ADD UNDOFILE 'new_undo.dat'
  INITIAL_SIZE 2G
  ENGINE NDB;
```

After running the `CREATE LOGFILE GROUP` statement successfully, you should see a result similar to the one shown here for this query against the `FILES` table:

```
mysql> SELECT LOGFILE_GROUP_NAME, FILE_TYPE, EXTRA
-> FROM INFORMATION_SCHEMA.FILES
-> WHERE FILE_NAME = 'new_undo.dat';
```

LOGFILE_GROUP_NAME	FILE_TYPE	EXTRA
mygroup	UNDO FILE	CLUSTER_NODE=3
mygroup	UNDO FILE	CLUSTER_NODE=4
mygroup	UNDO FILE	CLUSTER_NODE=5
mygroup	UNDO FILE	CLUSTER_NODE=6

4 rows in set (0.01 sec)

- The `FILES` table is a non-standard table. It was added in MySQL 5.1.6.
- Beginning with MySQL 5.1.14, an additional row is present in the `FILES` table following the creation of a logfile group. This row has `NULL` for the value of the `FILE_NAME` column. For this row, the value of the `FILE_ID` column is always `0`, that of the `FILE_TYPE` column is always `UNDO FILE`, and that of the `STATUS` column is always `NORMAL`. Currently, the value of the `ENGINE` column is always `NDBCLUSTER`.

The `FREE_EXTENTS` column in this row shows the total number of free extents available to all undo files belonging to a given log file group whose name and number are shown in the `LOGFILE_GROUP_NAME` and `LOGFILE_GROUP_NUMBER` columns, respectively.

Suppose there are no existing log file groups on your MySQL Cluster, and you create one using the following statement:

```
mysql> CREATE LOGFILE GROUP lg1
-> ADD UNDOFILE 'undofile.dat'
-> INITIAL_SIZE = 16M
-> UNDO_BUFFER_SIZE = 1M
-> ENGINE = NDB;
```

Query OK, 0 rows affected (3.81 sec)

You can now see this `NULL` row when you query the `FILES` table:

```
mysql> SELECT DISTINCT
-> FILE_NAME AS File,
-> FREE_EXTENTS AS Free,
-> TOTAL_EXTENTS AS Total,
-> EXTENT_SIZE AS Size,
-> INITIAL_SIZE AS Initial
-> FROM INFORMATION_SCHEMA.FILES;
```

File	Free	Total	Size	Initial
undofile.dat	NULL	4194304	4	16777216
NULL	4184068	NULL	4	NULL

2 rows in set (0.01 sec)

The total number of free extents available for undo logging is always somewhat less than the sum of the `TOTAL_EXTENTS` column values for all undo files in the log file group due to overhead required for maintaining the undo files. This can be seen by adding a second undo file to the log file group, then repeating the previous query against the `FILES` table:

```
mysql> ALTER LOGFILE GROUP lg1
-> ADD UNDOFILE 'undofile02.dat'
-> INITIAL_SIZE = 4M
-> ENGINE = NDB;
```

Query OK, 0 rows affected (1.02 sec)

```
mysql> SELECT DISTINCT
-> FILE_NAME AS File,
-> FREE_EXTENTS AS Free,
-> TOTAL_EXTENTS AS Total,
-> EXTENT_SIZE AS Size,
-> INITIAL_SIZE AS Initial
-> FROM INFORMATION_SCHEMA.FILES;
+-----+-----+-----+-----+-----+
| File          | Free  | Total | Size | Initial |
+-----+-----+-----+-----+-----+
| undofile.dat  | NULL  | 4194304 | 4    | 16777216 |
| undofile02.dat | NULL  | 1048576 | 4    | 4194304  |
| NULL         | 5223944 | NULL  | 4    | NULL     |
+-----+-----+-----+-----+-----+
3 rows in set (0.01 sec)
```

The amount of free space in bytes which is available for undo logging by Disk Data tables using this log file group can be approximated by multiplying the number of free extents by the initial size:

```
mysql> SELECT
-> FREE_EXTENTS AS 'Free Extents',
-> FREE_EXTENTS * EXTENT_SIZE AS 'Free Bytes'
-> FROM INFORMATION_SCHEMA.FILES
-> WHERE LOGFILE_GROUP_NAME = 'lg1'
-> AND FILE_NAME IS NULL;
+-----+-----+
| Free Extents | Free Bytes |
+-----+-----+
| 5223944     | 20895776  |
+-----+-----+
1 row in set (0.02 sec)
```

If you create a MySQL Cluster Disk Data table and then insert some rows into it, you can see approximately how much space remains for undo logging afterwards, for example:

```
mysql> CREATE TABLESPACE ts1
-> ADD DATAFILE 'data1.dat'
-> USE LOGFILE GROUP lg1
-> INITIAL_SIZE 512M
-> ENGINE = NDB;
Query OK, 0 rows affected (8.71 sec)

mysql> CREATE TABLE dd (
-> c1 INT NOT NULL PRIMARY KEY,
-> c2 INT,
-> c3 DATE
-> )
-> TABLESPACE ts1 STORAGE DISK
-> ENGINE = NDB;
Query OK, 0 rows affected (2.11 sec)

mysql> INSERT INTO dd VALUES
-> (NULL, 1234567890, '2007-02-02'),
-> (NULL, 1126789005, '2007-02-03'),
-> (NULL, 1357924680, '2007-02-04'),
-> (NULL, 1642097531, '2007-02-05');
Query OK, 4 rows affected (0.01 sec)

mysql> SELECT
-> FREE_EXTENTS AS 'Free Extents',
-> FREE_EXTENTS * EXTENT_SIZE AS 'Free Bytes'
-> FROM INFORMATION_SCHEMA.FILES
-> WHERE LOGFILE_GROUP_NAME = 'lg1'
-> AND FILE_NAME IS NULL;
+-----+-----+
| Free Extents | Free Bytes |
+-----+-----+
| 5207565     | 20830260  |
+-----+-----+
1 row in set (0.01 sec)
```

- There are no `SHOW` commands associated with the `FILES` table.
- For additional information, and examples of creating and dropping MySQL Cluster Disk Data objects, see [MySQL Cluster Disk Data Tables](#).

## 19.22. The INFORMATION\_SCHEMA PROCESSLIST Table

The `PROCESSLIST` table provides information about which threads are running.

INFORMATION_SCHEMA Name	SHOW Name	Remarks
ID	Id	MySQL extension

USER	User	MySQL extension
HOST	Host	MySQL extension
DB	db	MySQL extension
COMMAND	Command	MySQL extension
TIME	Time	MySQL extension
STATE	State	MySQL extension
INFO	Info	MySQL extension

For an extensive description of the table columns, see [Section 12.5.5.31, “SHOW PROCESSLIST Syntax”](#).

**Notes:**

- The `PROCESSLIST` table is a non-standard table. It was added in MySQL 5.1.7.
- Like the output from the corresponding `SHOW` statement, the `PROCESSLIST` table will only show information about your own threads, unless you have the `PROCESS` privilege, in which case you will see information about other threads, too. As an anonymous user, you cannot see any rows at all.
- If an SQL statement refers to `INFORMATION_SCHEMA.PROCESSLIST`, then MySQL will populate the entire table once, when statement execution begins, so there is read consistency during the statement. There is no read consistency for a multi-statement transaction, though.

The following statements are equivalent:

```
SELECT * FROM INFORMATION_SCHEMA.PROCESSLIST
SHOW FULL PROCESSLIST
```

## 19.23. The INFORMATION\_SCHEMA REFERENTIAL\_CONSTRAINTS Table

The `REFERENTIAL_CONSTRAINTS` table provides information about foreign keys.

INFORMATION_SCHEMA Name	SHOW Name	Remarks
CONSTRAINT_CATALOG		NULL
CONSTRAINT_SCHEMA		
CONSTRAINT_NAME		
UNIQUE_CONSTRAINT_CATALOG		NULL
UNIQUE_CONSTRAINT_SCHEMA		
UNIQUE_CONSTRAINT_NAME		
MATCH_OPTION		
UPDATE_RULE		
DELETE_RULE		
TABLE_NAME		
REFERENCED_TABLE_NAME		

**Notes:**

- The `REFERENTIAL_CONSTRAINTS` table was added in MySQL 5.1.10. The `REFERENCED_TABLE_NAME` column was added in MySQL 5.1.16.
- `TABLE_NAME` has the same value as `TABLE_NAME` in `INFORMATION_SCHEMA.TABLE_CONSTRAINTS`.
- `CONSTRAINT_SCHEMA` and `CONSTRAINT_NAME` identify the foreign key.
- `UNIQUE_CONSTRAINT_SCHEMA`, `UNIQUE_CONSTRAINT_NAME`, and `REFERENCED_TABLE_NAME` identify the refer-

enced key. (Note: Before MySQL 5.1.16, `UNIQUE_CONSTRAINT_NAME` incorrectly named the referenced table, not the constraint.)

- The only valid value at this time for `MATCH_OPTION` is `NONE`.
- The possible values for `UPDATE_RULE` or `DELETE_RULE` are `CASCADE`, `SET NULL`, `SET DEFAULT`, `RESTRICT`, `NO ACTION`.

## 19.24. The INFORMATION\_SCHEMA GLOBAL\_STATUS and SESSION\_STATUS Tables

The `GLOBAL_STATUS` and `SESSION_STATUS` tables provide information about server status variables. Their contents correspond to the information produced by the `SHOW GLOBAL STATUS` and `SHOW SESSION STATUS` statements (see [Section 12.5.5.37](#), “`SHOW STATUS Syntax`”).

INFORMATION_SCHEMA Name	SHOW Name	Remarks
VARIABLE_NAME	Variable_name	
VARIABLE_VALUE	Value	

### Notes:

- The `GLOBAL_STATUS` and `SESSION_STATUS` tables were added in MySQL 5.1.12.
- Beginning with MySQL 5.1.19, the `VARIABLE_VALUE` column for each of these tables is defined as `VARCHAR(20480)`. Previously, this column had the data type `DECIMAL(22,7)`, but was changed to avoid loss of data when working with status variables whose values were strings ([Bug#26994](#)).

## 19.25. The INFORMATION\_SCHEMA GLOBAL\_VARIABLES and SESSION\_VARIABLES Tables

The `GLOBAL_VARIABLES` and `SESSION_VARIABLES` tables provide information about server status variables. Their contents correspond to the information produced by the `SHOW GLOBAL VARIABLES` and `SHOW SESSION VARIABLES` statements (see [Section 12.5.5.41](#), “`SHOW VARIABLES Syntax`”).

INFORMATION_SCHEMA Name	SHOW Name	Remarks
VARIABLE_NAME	Variable_name	
VARIABLE_VALUE	Value	

### Notes:

- The `GLOBAL_VARIABLES` and `SESSION_VARIABLES` tables were added in MySQL 5.1.12.
- Beginning with MySQL 5.1.19, the `VARIABLE_VALUE` column for each of these tables is defined as `VARCHAR(20480)`. Previously, this column had the data type `LONGTEXT`; this was changed in order to make these tables consistent with the `GLOBAL_STATUS` and `SESSION_STATUS` tables, whose definitions had been changed in that version (see [Section 19.24](#), “[The INFORMATION\\_SCHEMA GLOBAL\\_STATUS and SESSION\\_STATUS Tables](#)”).

## 19.26. The INFORMATION\_SCHEMA PROFILING Table

The `PROFILING` table provides statement profiling information. Its contents correspond to the information produced by the `SHOW PROFILES` and `SHOW PROFILE` statements (see [Section 12.5.5.33](#), “`SHOW PROFILES Syntax`”). The table is empty unless the `profiling` session variable is set to 1.

INFORMATION_SCHEMA Name	SHOW Name	Remarks
QUERY_ID	Query_ID	
SEQ		

STATE	Status	
DURATION	Duration	
CPU_USER	CPU_user	
CPU_SYSTEM	CPU_system	
CONTEXT_VOLUNTARY	Context_voluntary	
CONTEXT_INVOLUNTARY	Context_involuntary	
BLOCK_OPS_IN	Block_ops_in	
BLOCK_OPS_OUT	Block_ops_out	
MESSAGES_SENT	Messages_sent	
MESSAGES_RECEIVED	Messages_received	
PAGE_FAULTS_MAJOR	Page_faults_major	
PAGE_FAULTS_MINOR	Page_faults_minor	
SWAPS	Swaps	
SOURCE_FUNCTION	Source_function	
SOURCE_FILE	Source_file	
SOURCE_LINE	Source_line	

**Notes:**

- The `PROFILING` table was added in MySQL 5.1.24.
- `QUERY_ID` is a numeric statement identifier.
- `SEQ` is a sequence number indicating the display order for rows with the same `QUERY_ID` value.
- `STATE` is the profiling state to which the row measurements apply.
- `DURATION` indicates how long statement execution remained in the given state, in seconds.
- `CPU_USER` and `CPU_SYSTEM` indicate user and system CPU use, in seconds.
- `CONTEXT_VOLUNTARY` and `CONTEXT_INVOLUNTARY` indicate how many voluntary and involuntary context switches occurred.
- `BLOCK_OPS_IN` and `BLOCK_OPS_OUT` indicate the number of block input and output operations.
- `MESSAGES_SENT` and `MESSAGES_RECEIVED` indicate the number of communication messages sent and received.
- `PAGE_FAULTS_MAJOR` and `PAGE_FAULTS_MINOR` indicate the number of major and minor page faults.
- `SWAPS` indicates how many swaps occurred.
- `SOURCE_FUNCTION`, `SOURCE_FILE`, and `SOURCE_LINE` provide information indicating where in the source code the profiled state executes.

## 19.27. Other INFORMATION\_SCHEMA Tables

We intend to implement additional `INFORMATION_SCHEMA` tables. In particular, we acknowledge the need for the `PARAMETERS` table. (`PARAMETERS` is implemented in MySQL 6.0.)

## 19.28. Extensions to SHOW Statements

Some extensions to `SHOW` statements accompany the implementation of `INFORMATION_SCHEMA`:

- `SHOW` can be used to get information about the structure of `INFORMATION_SCHEMA` itself.
- Several `SHOW` statements accept a `WHERE` clause that provides more flexibility in specifying which rows to display.

`INFORMATION_SCHEMA` is an information database, so its name is included in the output from `SHOW DATABASES`. Similarly, `SHOW TABLES` can be used with `INFORMATION_SCHEMA` to obtain a list of its tables:

```
mysql> SHOW TABLES FROM INFORMATION_SCHEMA;
+-----+
| Tables_in_INFORMATION_SCHEMA |
+-----+
| CHARACTER_SETS                |
| COLLATIONS                    |
| COLLATION_CHARACTER_SET_APPLICABILITY |
| COLUMNS                      |
| COLUMN_PRIVILEGES            |
| ENGINES                      |
| EVENTS                       |
| FILES                        |
| GLOBAL_STATUS                |
| GLOBAL_VARIABLES             |
| KEY_COLUMN_USAGE             |
| PARTITIONS                   |
| PLUGINS                      |
| PROCESSLIST                  |
| REFERENTIAL_CONSTRAINTS     |
| ROUTINES                     |
| SCHEMATA                     |
| SCHEMA_PRIVILEGES            |
| SESSION_STATUS               |
| SESSION_VARIABLES           |
| STATISTICS                   |
| TABLES                      |
| TABLE_CONSTRAINTS          |
| TABLE_PRIVILEGES           |
| TRIGGERS                     |
| USER_PRIVILEGES              |
| VIEWS                        |
+-----+
27 rows in set (0.00 sec)
```

`SHOW COLUMNS` and `DESCRIBE` can display information about the columns in individual `INFORMATION_SCHEMA` tables.

`SHOW` statements that accept a `LIKE` clause to limit the rows displayed also allow a `WHERE` clause that enables specification of more general conditions that selected rows must satisfy:

```
SHOW CHARACTER SET
SHOW COLLATION
SHOW COLUMNS
SHOW DATABASES
SHOW FUNCTION STATUS
SHOW INDEX
SHOW OPEN TABLES
SHOW PROCEDURE STATUS
SHOW STATUS
SHOW TABLE STATUS
SHOW TABLES
SHOW TRIGGERS
SHOW VARIABLES
```

The `WHERE` clause, if present, is evaluated against the column names displayed by the `SHOW` statement. For example, the `SHOW CHARACTER SET` statement produces these output columns:

```
mysql> SHOW CHARACTER SET;
+-----+-----+-----+-----+
| Charset | Description | Default collation | Maxlen |
+-----+-----+-----+-----+
| big5    | Big5 Traditional Chinese | big5_chinese_ci | 2 |
| dec8    | DEC West European | dec8_swedish_ci | 1 |
| cp850   | DOS West European | cp850_general_ci | 1 |
| hp8     | HP West European | hp8_english_ci | 1 |
| koi8r   | KOI8-R Relcom Russian | koi8r_general_ci | 1 |
| latin1  | cp1252 West European | latin1_swedish_ci | 1 |
| latin2  | ISO 8859-2 Central European | latin2_general_ci | 1 |
| ...     | ... | ... | ... |
```

To use a `WHERE` clause with `SHOW CHARACTER SET`, you would refer to those column names. As an example, the following statement displays information about character sets for which the default collation contains the string `'japanese'`:

```
mysql> SHOW CHARACTER SET WHERE `Default collation` LIKE '%japanese%';
+-----+-----+-----+-----+
| Charset | Description | Default collation | Maxlen |
+-----+-----+-----+-----+
| ujis    | EUC-JP Japanese | ujis_japanese_ci | 3 |
| sjis    | Shift-JIS Japanese | sjis_japanese_ci | 2 |
| cp932   | SJIS for Windows Japanese | cp932_japanese_ci | 2 |
| eucjpms | UJIS for Windows Japanese | eucjpms_japanese_ci | 3 |
+-----+-----+-----+-----+
```

This statement displays the multi-byte character sets:

```
mysql> SHOW CHARACTER SET WHERE Maxlen > 1;
```

Charset	Description	Default collation	Maxlen
big5	Big5 Traditional Chinese	big5_chinese_ci	2
ujis	EUC-JP Japanese	ujis_japanese_ci	3
sjis	Shift-JIS Japanese	sjis_japanese_ci	2
euckr	EUC-KR Korean	euckr_korean_ci	2
gb2312	GB2312 Simplified Chinese	gb2312_chinese_ci	2
gbk	GBK Simplified Chinese	gbk_chinese_ci	2
utf8	UTF-8 Unicode	utf8_general_ci	3
ucs2	UCS-2 Unicode	ucs2_general_ci	2
cp932	SJIS for Windows Japanese	cp932_japanese_ci	2
eucjpms	UJIS for Windows Japanese	eucjpms_japanese_ci	3

---

## Chapter 20. Connectors and APIs

MySQL Connectors provide connectivity to the MySQL server for client programs. APIs provide low-level access to the MySQL protocol and MySQL resources. Both Connectors and the APIs enable you to connect and execute MySQL statements from another language or environment, including Java (JDBC), ODBC, Perl, Python, PHP, Ruby, and native C and embedded MySQL instances.

### Note

Connector version numbers do not correlate with MySQL Server version numbers. See also [Table 20.2, “MySQL Connector versions and MySQL Server versions”](#).

A number of connectors are developed by MySQL:

- Connector/ODBC provides driver support for connecting to a MySQL server using the Open Database Connectivity (ODBC) API. Support is available for ODBC connectivity from Windows, Unix and Mac OS X platforms.
- Connector/NET enables developers to create .NET applications that use data stored in a MySQL database. Connector/NET implements a fully-functional ADO.NET interface and provides support for use with ADO.NET aware tools. Applications that want to use Connector/NET can be written in any of the supported .NET languages.

The MySQL Visual Studio Plugin works with Connector/NET and Visual Studio 2005. The plugin is a MySQL DDEX Provider, which means that you can use the schema and data manipulation tools within Visual Studio to create and edit objects within a MySQL database.

- Connector/J provides driver support for connecting to MySQL from a Java application using the standard Java Database Connectivity (JDBC) API.
- Connector/MXJ is a tool that enables easy deployment and management of MySQL server and database through your Java application.
- Connector/C++ is a tool that enables easy deployment and management of MySQL server and database through your C++ application.
- Connector/C is a stand-alone replacement for the MySQL Client Library ([libmysql](#)).
- Connector/OpenOffice.org is a tool that enables OpenOffice.org applications to connect to MySQL server.

There are two direct access methods for using MySQL natively within a C application:

- The C API provides low-level access to the MySQL protocol through the [libmysql](#) client library; this is the primary method used to connect to an instance of the MySQL server, and is used both by MySQL command line clients and many of the APIs also detailed in this section. MySQL Connector/C can now also be used for this purpose.
- [libmysqld](#) is an embedded MySQL server library that enables you to embed an instance of the MySQL server into your C applications.

If you need to access MySQL from a C application, or build an interface to MySQL for a language not supported by the Connectors or APIs in this chapter, the C API is where you would start. A number of programmers utilities are available to help with the process, and also covered in this section.

The remaining APIs provide an interface to MySQL from specific application languages. These solutions are not developed or supported by MySQL. Basic information on their usage and abilities is provided here for reference purposes only.

All the language APIs are developed using one of two methods, using [libmysql](#) or by building a *native driver*. The two solutions offer different benefits:

- Using [libmysql](#) offers complete compatibility with MySQL as it uses the same libraries as the MySQL client applications. However, the feature set is limited to the implementation and interfaces exposed through [libmysql](#) and the performance may be lower as data is copied between the native language, and the MySQL API components. MySQL Connector/C is a possible alternative to using [libmysql](#).
- *Native drivers* are an implementation of the MySQL network protocol entirely within the host language or environment. Native drivers are fast, as there is less copying of data between components, and they can offer advanced functionality not available through the standard MySQL API. Native drivers are also easier to build and deploy, as you do not need a copy of the MySQL client libraries to build the native driver components.



A list of many of the libraries and interfaces available for MySQL are shown in the table. See Table 20.1, “MySQL APIs and Interfaces”.

**Table 20.1. MySQL APIs and Interfaces**

Environment	API	Type	Notes
Ada	MySQL Bindings for GNU Ada	<code>libmysql</code>	See <a href="#">MySQL Bindings for GNU Ada</a>
C	Connector/C	Replacement for <code>libmysql</code>	See <a href="#">Section 20.7, “MySQL Connector/C”</a> .
C++	Connector/C++	<code>libmysql</code>	See <a href="#">Section 20.6, “MySQL Connector/C++”</a> .
	MySQL++	<code>libmysql</code>	See <a href="#">Section 20.13, “MySQL C++ API”</a> .
	MySQL wrapped	<code>libmysql</code>	See <a href="#">MySQL wrapped</a> .
Cocoa	MySQL-Cocoa	<code>libmysql</code>	Compatible with the Objective-C Cocoa environment. See <a href="http://mysql-cocoa.sourceforge.net/">http://mysql-cocoa.sourceforge.net/</a>
D	MySQL for D	<code>libmysql</code>	See <a href="#">MySQL for D</a> .
Eiffel	Eiffel MySQL	<code>libmysql</code>	See <a href="#">Section 20.17, “MySQL Eiffel Wrapper”</a> .
Erlang	<code>erlang-mysql-driver</code>	<code>libmysql</code>	See <a href="#">erlang-mysql-driver</a> .
Haskell	Haskell MySQL Bindings	Native Driver	See <a href="#">Brian O’Sullivan’s pure Haskell MySQL bindings</a> .
	<code>hsqldb-mysql</code>	<code>libmysql</code>	See <a href="#">MySQL driver for Haskell</a> .
Java/JDBC	Connector/J	Native Driver	See <a href="#">Section 20.4, “MySQL Connector/J”</a> .
Kaya	MyDB	<code>libmysql</code>	See <a href="#">MyDB</a> .
Lua	LuaSQL	<code>libmysql</code>	See <a href="#">LuaSQL</a> .
.NET/Mono	Connector/NET	Native Driver	See <a href="#">Section 20.2, “MySQL Connector/NET”</a> .
Objective Caml	MySQL Bindings for Objective Caml	<code>libmysql</code>	See <a href="#">MySQL Bindings for Objective Caml</a> .
Octave	Database bindings for GNU Octave	<code>libmysql</code>	See <a href="#">Database bindings for GNU Octave</a> .
ODBC	Connector/ODBC	<code>libmysql</code>	See <a href="#">Section 20.1, “MySQL Connector/ODBC”</a> .
OpenOffice	MySQL Connector/OpenOffice.org	<code>libmysql</code>	Direct connectivity, without using JDBC/ODBC. See <a href="#">Section 20.8, “MySQL Connector/OpenOffice.org”</a> .
Perl	<code>DBI/DBD::mysql</code>	<code>libmysql</code>	See <a href="#">Section 20.12, “MySQL Perl API”</a> .
	<code>Net::MySQL</code>	Native Driver	See <a href="#">Net::MySQL</a> at CPAN
PHP	<code>mysql</code> , <code>ext/mysql</code> interface (deprecated)	<code>libmysql</code>	See <a href="#">Section 20.11.1, “MySQL”</a> .
	<code>mysqli</code> , <code>ext/mysqli</code> interface	<code>libmysql</code>	See <a href="#">Section 20.11.2, “MySQL Improved Extension (mysqli)”</a> .
	<code>PDO_MYSQL</code>	<code>libmysql</code>	See <a href="#">Section 20.11.3, “MySQL Functions (PDO_MYSQL)”</a> .
	<code>PDO mysqlnd</code>	Native Driver	See <a href="#">PHP PDO mysqlnd</a> .
Python	MySQLdb	<code>libmysql</code>	See <a href="#">Section 20.14, “MySQL Python API”</a> .
Ruby	MySQL/Ruby	<code>libmysql</code>	Uses <code>libmysql</code> . See <a href="#">Section 20.15.1, “The MySQL/Ruby API”</a> .
	Ruby/MySQL	Native Driver	See <a href="#">Section 20.15.2, “The Ruby/MySQL API”</a> .
Scheme	<code>Myscsh</code>	<code>libmysql</code>	See <a href="#">Myscsh</a> .
SPL	<code>sql_mysql</code>	<code>libmysql</code>	See <a href="#">sql_mysql</a> for SPL.
Tcl	MySQLtcl	<code>libmysql</code>	See <a href="#">Section 20.16, “MySQL Tcl API”</a> .

**Table 20.2. MySQL Connector versions and MySQL Server versions**

Connector	Connector version	MySQL Server version
Connector/C++	1.0.5 (Beta)	5.1, 5.4, 6.0

Connector	Connector version	MySQL Server version
Connector/OpenOffice.org	1.0 (Alpha)	5.0, 5.1, 5.4, 6.0
Connector/J	5.1	4.1, 5.0, 5.1, 5.4, 6.0
Connector/NET	1.0	4.0, 5.0
Connector/NET	5.2	4.0, 4.1, 5.0, 5.1, 5.4, 6.0
Connector/NET	5.3	4.1, 5.0, 5.1, 5.4, 6.0
Connector/ODBC	3.51 (Unicode not supported)	4.1, 5.0, 5.1, 5.4, 6.0
Connector/ODBC	5.1	4.1, 5.0, 5.1, 5.4, 6.0

## 20.1. MySQL Connector/ODBC

The MySQL Connector/ODBC is the name for the family of MySQL ODBC drivers (previously called MyODBC drivers) that provide access to a MySQL database using the industry standard Open Database Connectivity (ODBC) API. This reference covers Connector/ODBC 3.51 and Connector/ODBC 5.1. Both releases provide an ODBC compliant interface to MySQL Server.

MySQL Connector/ODBC provides both driver-manager based and native interfaces to the MySQL database, which full support for MySQL functionality, including stored procedures, transactions and, with Connector/ODBC 5.1, full Unicode compliance.

For more information on the ODBC API standard and how to use it, refer to <http://support.microsoft.com/kb/110093>.

The application development part of this reference assumes a good working knowledge of C, general DBMS knowledge, and finally, but not least, familiarity with MySQL. For more information about MySQL functionality and its syntax, refer to <http://dev.mysql.com/doc/>.

Typically, you need to install Connector/ODBC only on Windows machines. For Unix and Mac OS X you can use the native MySQL network or named pipe to communicate with your MySQL database. You may need Connector/ODBC for Unix or Mac OS X if you have an application that requires an ODBC interface to communicate with the database. Applications that require ODBC to communicate with MySQL include ColdFusion, Microsoft Office, and Filemaker Pro.

### Key topics:

- For help installing Connector/ODBC see [Section 20.1.3, “Connector/ODBC Installation”](#).
- For information on the configuration options, see [Section 20.1.4.2, “Connector/ODBC Connection Parameters”](#).
- For more information on connecting to a MySQL database from a Windows host using Connector/ODBC see [Section 20.1.5.2, “Step-by-step Guide to Connecting to a MySQL Database through Connector/ODBC”](#).
- If you want to use Microsoft Access as an interface to a MySQL database using Connector/ODBC see [Section 20.1.5.4, “Using Connector/ODBC with Microsoft Access”](#).
- General tips on using Connector/ODBC, including obtaining the last auto-increment ID see [Section 20.1.7.1, “Connector/ODBC General Functionality”](#).
- For tips and common questions on using Connector/ODBC with specific application see [Section 20.1.7.2, “Connector/ODBC Application Specific Tips”](#).
- For a general list of Frequently Asked Questions see [Section 20.1.7.3, “Connector/ODBC Errors and Resolutions \(FAQ\)”](#).
- Additional support when using Connector/ODBC is available, see [Section 20.1.8, “Connector/ODBC Support”](#).

### MySQL Enterprise

MySQL Enterprise subscribers will find more information about MySQL and ODBC in the Knowledge Base articles about [ODBC](#). Access to the MySQL Knowledge Base collection of articles is one of the advantages of subscribing to MySQL Enterprise. For more information, see <http://www.mysql.com/products/enterprise/advisors.html>.

### 20.1.1. Connector/ODBC Versions

There are currently two version of Connector/ODBC available:

- Connector/ODBC 5.1, currently in GA status, is a partial rewrite of the of the 3.51 code base and is designed to work with all versions of MySQL from 4.1. Connector/ODBC 5.1 will be a complete implementation of the ODBC Core interface, plus more

Level 1 and Level 2 functionality of the ODBC specification than that currently supported by Connector/ODBC 3.51. See [Section 20.1.2.1, “Connector/ODBC Roadmap”](#).

Connector/ODBC 5.1 also includes the following changes and improvements over the 3.51 release:

- Improved support on Windows 64-bit platforms.
- Full Unicode support at the driver level. This includes support for the `SQL_WCHAR` datatype, and support for Unicode login, password and DSN configurations. For more information, see [Microsoft Knowledgebase Article #716246](#).
- Support for the `SQL_NUMERIC_STRUCT` datatype, which provides easier access to the precise definition of numeric values. For more information, see [Microsoft Knowledgebase Article #714556](#)
- Native Windows setup library. This replaces the Qt library based interface for configuring DSN information within the ODBC Data Sources application.
- Support for the ODBC descriptor, which improves the handling and metadata of columns and parameter data. For more information, see [Microsoft Knowledgebase Article #716339](#).
- Connector/ODBC 3.51 is the current release of the 32-bit ODBC driver, also known as the MySQL ODBC 3.51 driver. Connector/ODBC 3.51 has support for ODBC 3.5x specification level 1 (complete core API + level 2 features) in order to continue to provide all functionality of ODBC for accessing MySQL.

The manual for versions of Connector/ODBC older than 3.51 can be located in the corresponding binary or source distribution. Please note that versions of Connector/ODBC earlier than the 3.51 revision were not fully compliant with the ODBC specification.

**Note**

Development on Connector/ODBC 5.0 was stopped due to development issues. Connector/ODBC 5.1 is now the current development release.

**Note**

From this section onward, the primary focus of this guide is the Connector/ODBC 3.51 and Connector/ODBC 5.1 drivers.

**Note**

Version numbers for MySQL products are formatted as X.X.X. However, Windows tools (Control Panel, properties display) may show the version numbers as XX.XX.XX. For example, the official MySQL formatted version number 5.0.9 may be displayed by Windows tools as 5.00.09. The two versions are the same; only the number display format is different.

## 20.1.2. Connector/ODBC Introduction

ODBC (Open Database Connectivity) provides a way for client programs to access a wide range of databases or data sources. ODBC is a standardized API that allows connections to SQL database servers. It was developed according to the specifications of the SQL Access Group and defines a set of function calls, error codes, and data types that can be used to develop database-independent applications. ODBC usually is used when database independence or simultaneous access to different data sources is required.

For more information about ODBC, refer to <http://support.microsoft.com/kb/110093>.

### 20.1.2.1. Connector/ODBC Roadmap

Connector/ODBC 5.1 is currently in development and will be a complete implementation of the ODBC Core interface, plus more Level 1 and Level 2 functionality of the ODBC specification than that currently supported by Connector/ODBC 3.51.

The following functionality was added or changed as part of 5.1:

- Add support for `SQL_NUMERIC_STRUCT`: [MSDN Article 714556](#).
- Replace installer library with new implementation (from v5 tree).
- Implement native Windows setup library.
- Implement `SQLCancel()` ([Bug#15601](#)): [MSDN Article 714112](#).

The following functionality will be added in a version after 5.1:

- Implement native Mac OS X setup library.
- Replace OPTIONS flags with individual DSN settings (but support OPTIONS for backwards-compatibility).
- Fix support for SQLBIGINT ([Bug#28887](#)): [MSDN Article 714121](#).
- Make diagnostics support standards-compliant: [MSDN Article 711021](#).
- Add support for SQL\_ATTR\_METADATA\_ID: [MSDN Article 716447](#).
- Implement SQLBrowseConnect(): [MSDN Article 714565](#), [MSDN Article 712446](#).
- Implement arrays of parameters: [MSDN Article 711818](#).

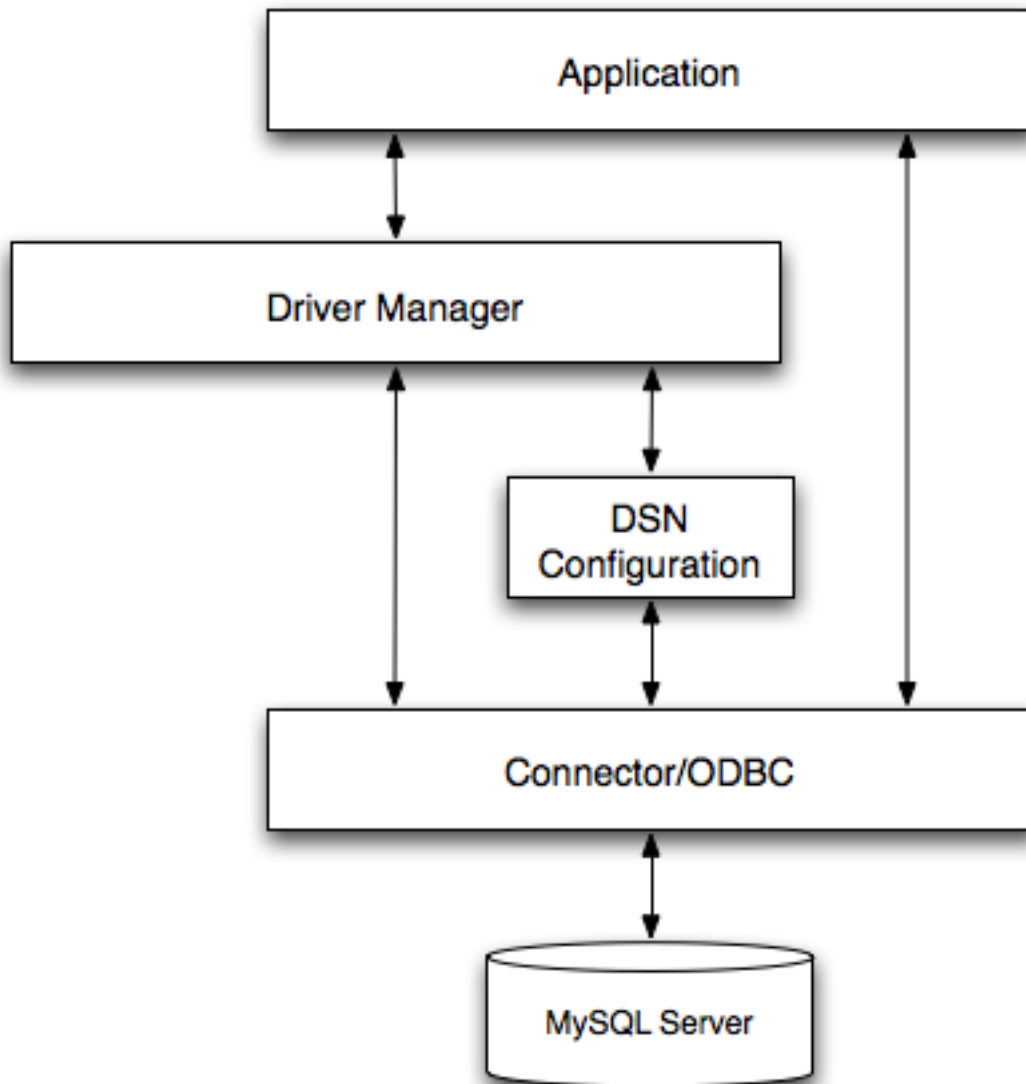
### **20.1.2.2. General Information About ODBC and Connector/ODBC**

Open Database Connectivity (ODBC) is a widely accepted application-programming interface (API) for database access. It is based on the Call-Level Interface (CLI) specifications from X/Open and ISO/IEC for database APIs and uses Structured Query Language (SQL) as its database access language.

A survey of ODBC functions supported by Connector/ODBC is given at [Section 20.1.6.1, "Connector/ODBC API Reference"](#). For general information about ODBC, see <http://support.microsoft.com/kb/110093>.

#### **20.1.2.2.1. Connector/ODBC Architecture**

The Connector/ODBC architecture is based on five components, as shown in the following diagram:



- **Application:**

The Application uses the ODBC API to access the data from the MySQL server. The ODBC API in turn uses the communicates with the Driver Manager. The Application communicates with the Driver Manager using the standard ODBC calls. The Application does not care where the data is stored, how it is stored, or even how the system is configured to access the data. It needs to know only the Data Source Name (DSN).

A number of tasks are common to all applications, no matter how they use ODBC. These tasks are:

- Selecting the MySQL server and connecting to it
- Submitting SQL statements for execution
- Retrieving results (if any)
- Processing errors
- Committing or rolling back the transaction enclosing the SQL statement
- Disconnecting from the MySQL server

Because most data access work is done with SQL, the primary tasks for applications that use ODBC are submitting SQL statements and retrieving any results generated by those statements.

- **Driver manager:**

The Driver Manager is a library that manages communication between application and driver or drivers. It performs the following tasks:

- Resolves Data Source Names (DSN). The DSN is a configuration string that identifies a given database driver, database, database host and optionally authentication information that enables an ODBC application to connect to a database using a standardized reference.

Because the database connectivity information is identified by the DSN, any ODBC compliant application can connect to the data source using the same DSN reference. This eliminates the need to separately configure each application that needs access to a given database; instead you instruct the application to use a pre-configured DSN.

- Loading and unloading of the driver required to access a specific database as defined within the DSN. For example, if you have configured a DSN that connects to a MySQL database then the driver manager will load the Connector/ODBC driver to enable the ODBC API to communicate with the MySQL host.
- Processes ODBC function calls or passes them to the driver for processing.

- **Connector/ODBC Driver:**

The Connector/ODBC driver is a library that implements the functions supported by the ODBC API. It processes ODBC function calls, submits SQL requests to MySQL server, and returns results back to the application. If necessary, the driver modifies an application's request so that the request conforms to syntax supported by MySQL.

- **DSN Configuration:**

The ODBC configuration file stores the driver and database information required to connect to the server. It is used by the Driver Manager to determine which driver to be loaded according to the definition in the DSN. The driver uses this to read connection parameters based on the DSN specified. For more information, [Section 20.1.4, “Connector/ODBC Configuration”](#).

- **MySQL Server:**

The MySQL database where the information is stored. The database is used as the source of the data (during queries) and the destination for data (during inserts and updates).

### 20.1.2.2.2. ODBC Driver Managers

An ODBC Driver Manager is a library that manages communication between the ODBC-aware application and any drivers. Its main functionality includes:

- Resolving Data Source Names (DSN).
- Driver loading and unloading.
- Processing ODBC function calls or passing them to the driver.

Both Windows and Mac OS X include ODBC driver managers with the operating system. Most ODBC Driver Manager implementations also include an administration application that makes the configuration of DSN and drivers easier. Examples and information on these managers, including Unix ODBC driver managers are listed below:

- Microsoft Windows ODBC Driver Manager (`odbc32.dll`), <http://support.microsoft.com/kb/110093>.
- Mac OS X includes [ODBC Administrator](#), a GUI application that provides a simpler configuration mechanism for the Unix iODBC Driver Manager. You can configure DSN and driver information either through ODBC Administrator or through the iODBC configuration files. This also means that you can test ODBC Administrator configurations using the `iodbctest` command. <http://www.apple.com>.
- [unixODBC Driver Manager for Unix](#) (`libodbc.so`). See <http://www.unixodbc.org>, for more information. The [unixODBC Driver Manager](#) includes the Connector/ODBC driver 3.51 in the installation package, starting with version [unixODBC 2.1.2](#).
- [iODBC ODBC Driver Manager for Unix](#) (`libiodbc.so`), see <http://www.iodbc.org>, for more information.

## 20.1.3. Connector/ODBC Installation

You can install the Connector/ODBC drivers using two different methods, a binary installation and a source installation. The binary

installation is the easiest and most straightforward method of installation. Using the source installation methods should only be necessary on platforms where a binary installation package is not available, or in situations where you want to customize or modify the installation process or Connector/ODBC drivers before installation.

### Where to Get Connector/ODBC

Sun Microsystems, Inc distributes its MySQL products under the General Public License (GPL). You can get a copy of the latest version of Connector/ODBC binaries and sources from our Web site at <http://dev.mysql.com/downloads/>.

For more information about Connector/ODBC, visit <http://www.mysql.com/products/myodbc/>.

For more information about licensing, visit <http://www.mysql.com/company/legal/licensing/>.

### Supported Platforms

Connector/ODBC can be used on all major platforms supported by MySQL. You can install it on:

- Windows 95, 98, Me, NT, 2000, XP, and 2003
- All Unix-like Operating Systems, including: AIX, Amiga, BSDI, DEC, FreeBSD, HP-UX 10/11, Linux, NetBSD, OpenBSD, OS/2, SGI Irix, Solaris, SunOS, SCO OpenServer, SCO UnixWare, Tru64 Unix
- Mac OS X and Mac OS X Server

Using a binary distribution offers the most straightforward method for installing Connector/ODBC. If you want more control over the driver, the installation location and or to customize elements of the driver you will need to build and install from the source.

If a binary distribution is not available for a particular platform build the driver from the original source code. You can contribute the binaries you create to MySQL by sending a mail message to [<myodbc@lists.mysql.com>](mailto:myodbc@lists.mysql.com), so that it becomes available for other users.

#### Note

On all non-Windows platforms except Mac OS X, the driver is built against `unixODBC` and is expecting a 2-byte `SQLWCHAR`, not 4 bytes as `iODBC` is using. For this reason, the binaries are **only** compatible with `unixODBC` and you will need to recompile the driver against `iODBC` if you wish to use them together. For further information see [Section 20.1.2.2.2, “ODBC Driver Managers”](#).

For further instructions:

Platform	Binary	Source
Windows	<a href="#">Installation Instructions</a>	<a href="#">Build Instructions</a>
Unix/Linux	<a href="#">Installation Instructions</a>	<a href="#">Build Instructions</a>
Mac OS X	<a href="#">Installation Instructions</a>	

### 20.1.3.1. Installing Connector/ODBC from a Binary Distribution on Windows

Before installing the Connector/ODBC drivers on Windows you should ensure that your Microsoft Data Access Components (MDAC) are up to date. You can obtain the latest version from the [Microsoft Data Access and Storage Web site](#).

There are three available distribution types to use when installing for Windows. The contents in each case are identical, it is only the installation method which is different.

- Zipped installer consists of a Zipped package containing a standalone installation application. To install from this package, you must unzip the installer, and then run the installation application. See [Section 20.1.3.1.1, “Installing the Windows Connector/ODBC Driver using an installer”](#) to complete the installation.
- MSI installer, an installation file that can be used with the installer included in Windows 2000, Windows XP and Windows Server 2003. See [Section 20.1.3.1.1, “Installing the Windows Connector/ODBC Driver using an installer”](#) to complete the installation.
- Zipped DLL package, containing the DLL files that need must be manually installed. See [Section 20.1.3.1.2, “Installing the Windows Connector/ODBC Driver using the Zipped DLL package”](#) to complete the installation.

**Note**

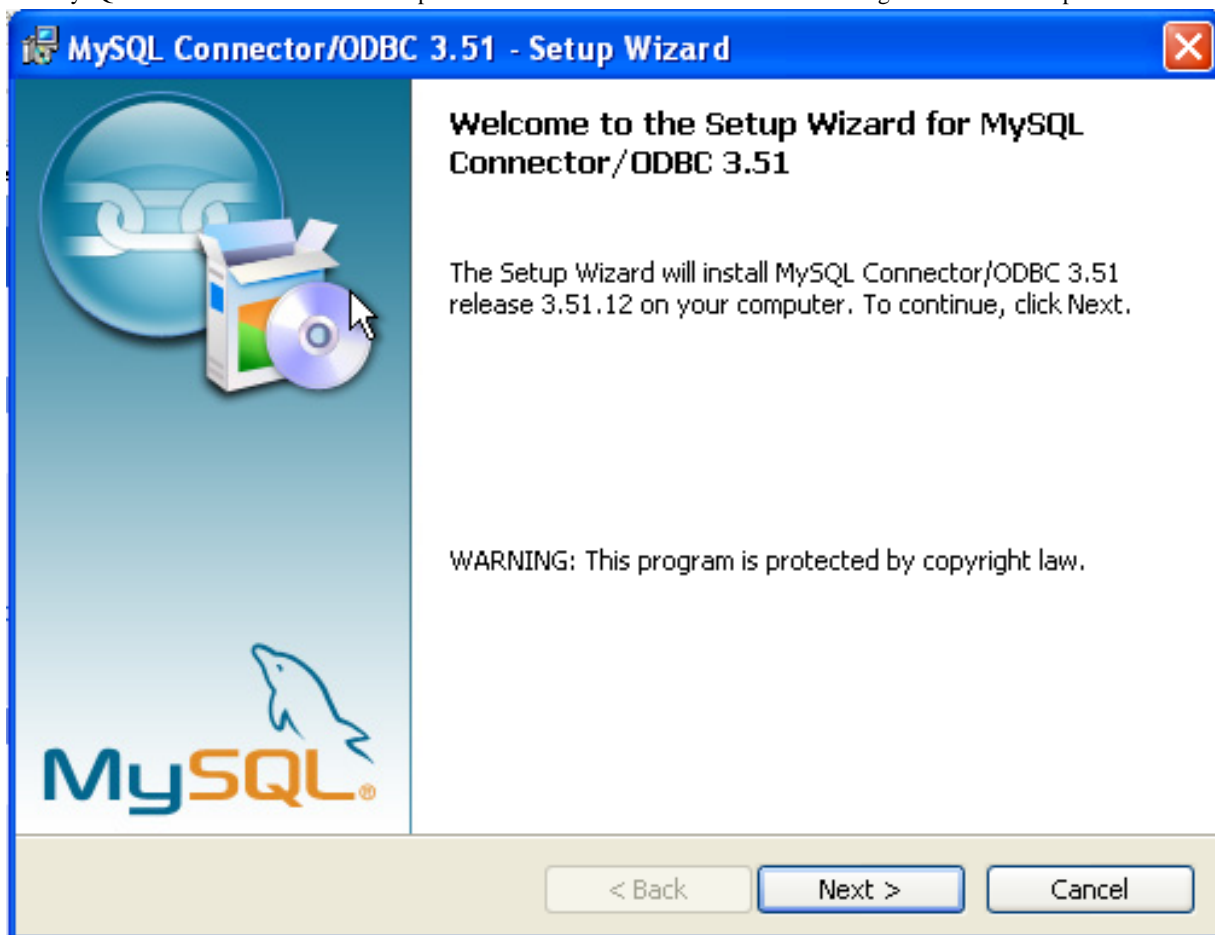
An OLEDB/ODBC driver for Windows 64-bit is available from [Microsoft Downloads](#).

**20.1.3.1.1. Installing the Windows Connector/ODBC Driver using an installer**

The installer packages offer a very simple method for installing the Connector/ODBC drivers. If you have downloaded the zipped installer then you must extract the installer application. The basic installation process is identical for both installers.

You should follow these steps to complete the installation:

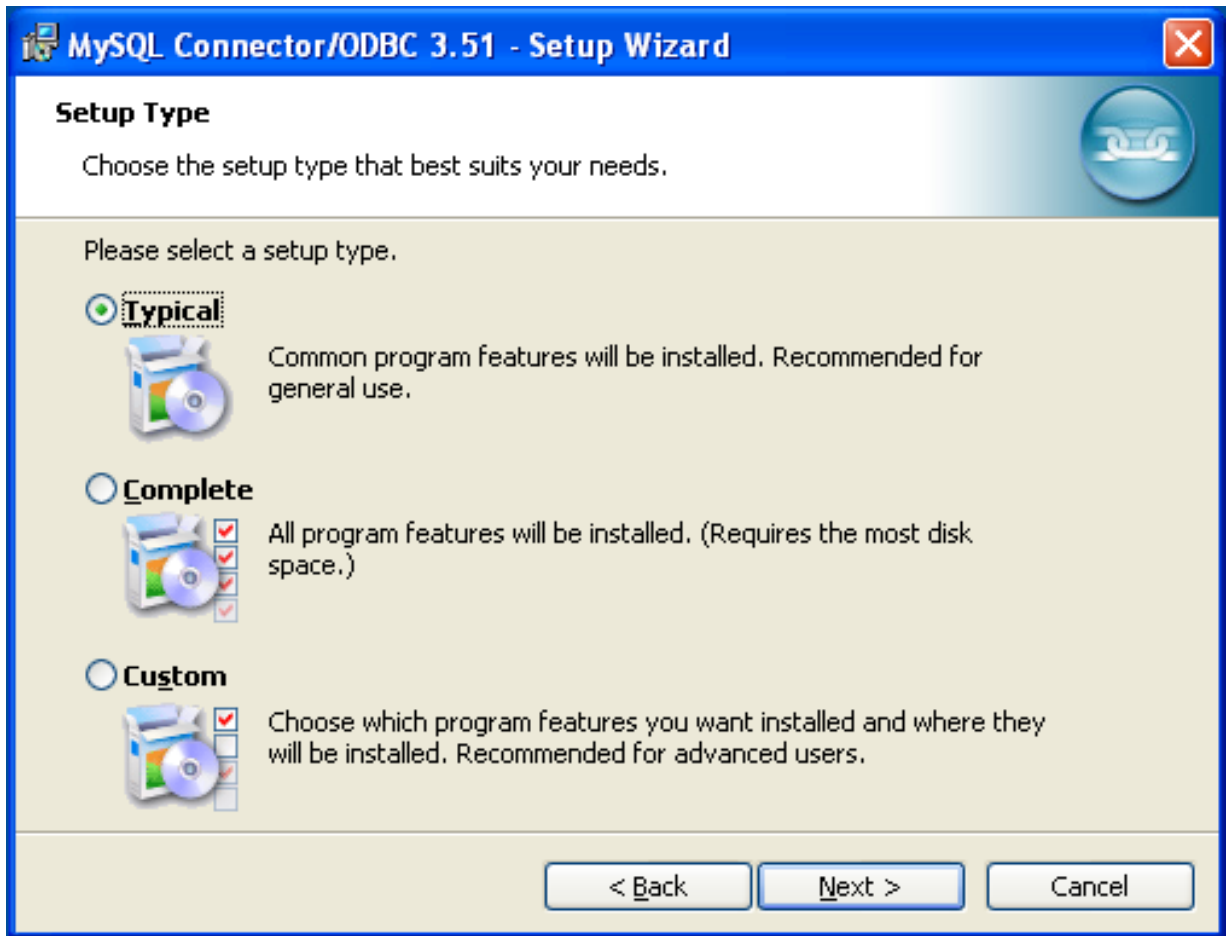
1. Double click on the standalone installer that you extracted, or the MSI file you downloaded.
2. The MySQL Connector/ODBC 3.51 - Setup Wizard will start. Click the NEXT button to begin the installation process.



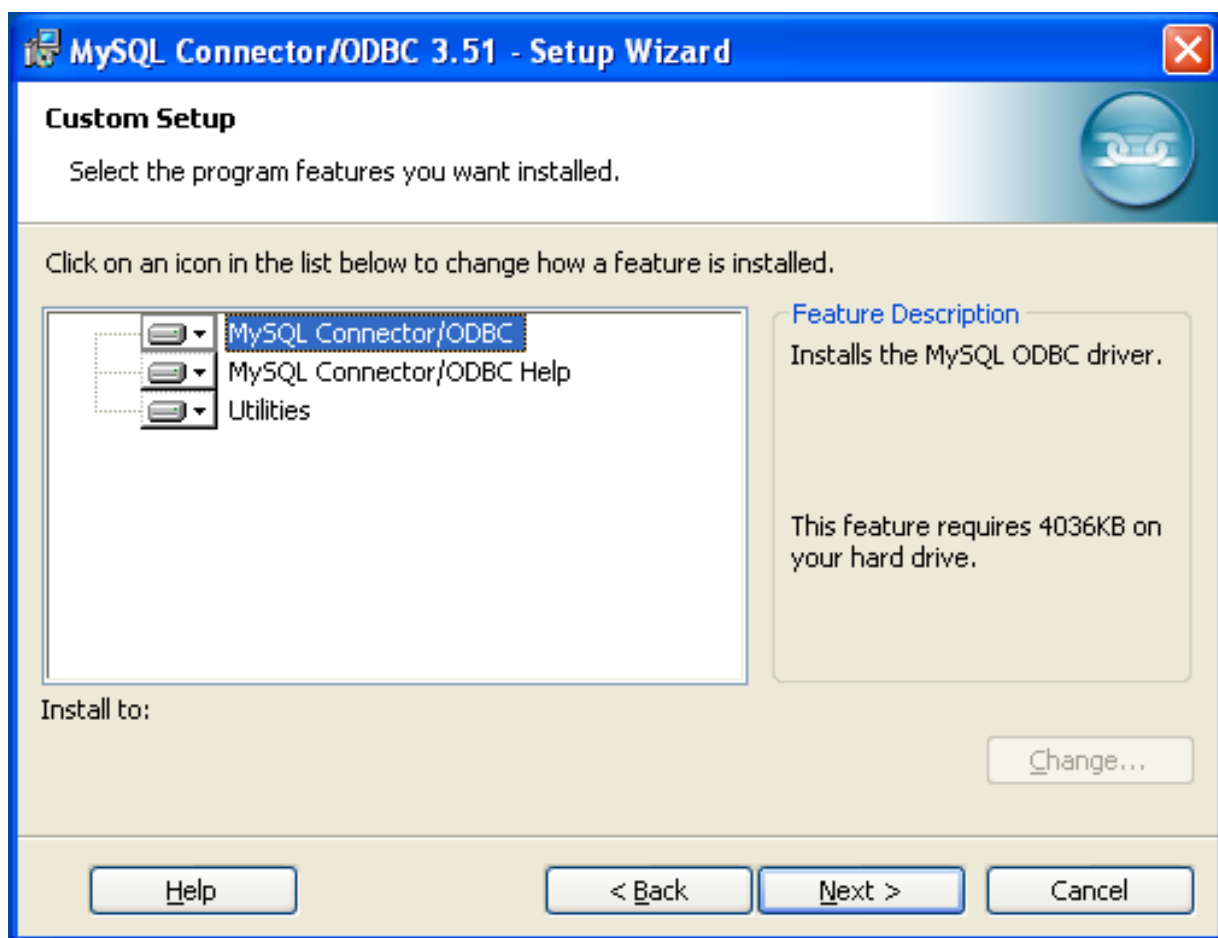
3. You will need to choose the installation type. The Typical installation provides the standard files you will need to connect to a MySQL database using ODBC. The Complete option installs all the available files, including debug and utility components. It is recommended you choose one of these two options to complete the installation. If choose one of these methods, click NEXT and then proceed to step 5.

You may also choose a Custom installation, which enables you to select the individual components that you want to install. You have chosen this method, click NEXT and then proceed to step 4.

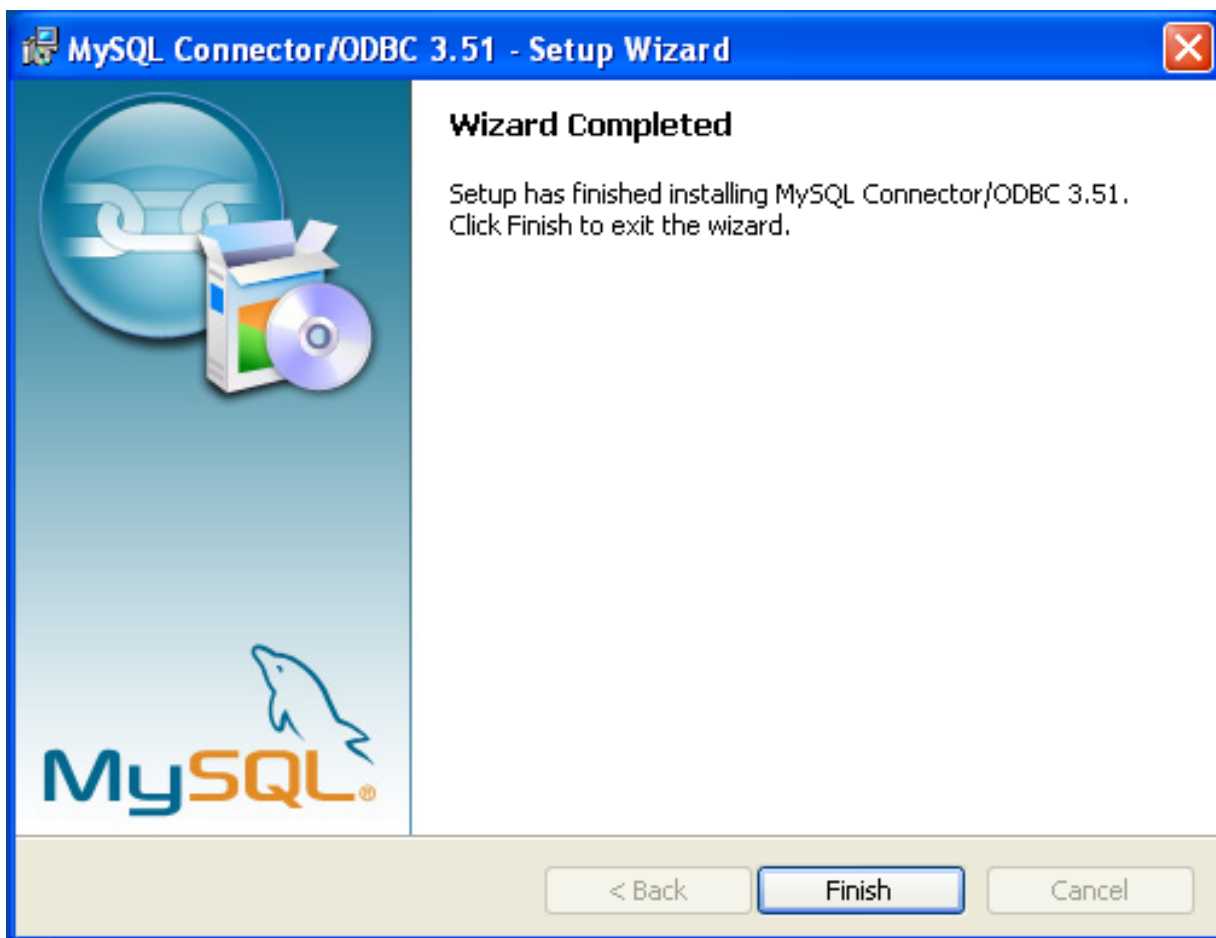




4. If you have chosen a custom installation, use the pop-ups to select which components to install and then click NEXT to install the necessary files.



5. Once the files have copied to your machine, the installation is complete. Click FINISH to exit the installer.



Now the installation is complete, you can continue to configure your ODBC connections using [Section 20.1.4, “Connector/ODBC Configuration”](#).

#### 20.1.3.1.2. Installing the Windows Connector/ODBC Driver using the Zipped DLL package

If you have downloaded the Zipped DLL package then you must install the individual files required for Connector/ODBC operation manually. Once you have unzipped the installation files, you can either perform this operation by hand, executing each statement individually, or you can use the included Batch file to perform an installation to the default locations.

To install using the Batch file:

1. Unzip the Connector/ODBC Zipped DLL package.
2. Open a Command Prompt.
3. Change to the directory created when you unzipped the Connector/ODBC Zipped DLL package.
4. Run `Install.bat`:

```
c:\> Install.bat
```

This will copy the necessary files into the default location, and then register the Connector/ODBC driver with the Windows ODBC manager.

If you want to copy the files to an alternative location - for example, to run or test different versions of the Connector/ODBC driver on the same machine, then you must copy the files by hand. It is however not recommended to install these files in a non-standard location. To copy the files by hand to the default installation location use the following steps:

1. Unzip the Connector/ODBC Zipped DLL package.

2. Open a Command Prompt.
3. Change to the directory created when you unzipped the Connector/ODBC Zipped DLL package.
4. Copy the library files to a suitable directory. The default is to copy them into the default Windows system directory `\Windows\System32`:

```
C:\> copy lib\myodbc3S.dll \Windows\System32
C:\> copy lib\myodbc3S.lib \Windows\System32
C:\> copy lib\myodbc3.dll \Windows\System32
C:\> copy lib\myodbc3.lib \Windows\System32
```

5. Copy the Connector/ODBC tools. These must be placed into a directory that is in the system `PATH`. The default is to install these into the Windows system directory `\Windows\System32`:

```
C:\> copy bin\myodbc3i.exe \Windows\System32
C:\> copy bin\myodbc3m.exe \Windows\System32
C:\> copy bin\myodbc3c.exe \Windows\System32
```

6. Optionally copy the help files. For these files to be accessible through the help system, they must be installed in the Windows system directory:

```
C:\> copy doc\*.hlp \Windows\System32
```

7. Finally, you must register the Connector/ODBC driver with the ODBC manager:

```
C:\> myodbc3i -a -d -t"MySQL ODBC 3.51 Driver;\
DRIVER=myodbc3.dll;SETUP=myodbc3S.dll"
```

You must change the references to the DLL files and command location in the above statement if you have not installed these files into the default location.

### 20.1.3.2. Installing Connector/ODBC from a Binary Distribution on Unix

There are two methods available for installing Connector/ODBC on Unix from a binary distribution. For most Unix environments you will need to use the tarball distribution. For Linux systems, there is also an RPM distribution available.

#### Note

To install Connector/ODBC 5.1 on Unix you require unixODBC 2.2.12 or later to be installed.

#### 20.1.3.2.1. Installing Connector/ODBC from a Binary Tarball Distribution

To install the driver from a tarball distribution (`.tar.gz` file), download the latest version of the driver for your operating system and follow these steps that demonstrate the process using the Linux version of the tarball:

```
shell> su root
shell> gunzip mysql-connector-odbc-3.51.11-i686-pc-linux.tar.gz
shell> tar xvf mysql-connector-odbc-3.51.11-i686-pc-linux.tar
shell> cd mysql-connector-odbc-3.51.11-i686-pc-linux
```

Read the installation instructions in the `INSTALL` file and execute these commands.

Then proceed on to [Section 20.1.4.5, “Configuring a Connector/ODBC DSN on Unix”](#), to configure the DSN for Connector/ODBC. For more information, refer to the `INSTALL` file that comes with your distribution.

#### 20.1.3.2.2. Installing Connector/ODBC from an RPM Distribution

To install or upgrade Connector/ODBC from an RPM distribution on Linux, simply download the RPM distribution of the latest version of Connector/ODBC and follow the instructions below. Use `su root` to become `root`, then install the RPM file.

If you are installing for the first time:

```
shell> su root
shell> rpm -ivh mysql-connector-odbc-3.51.12.i386.rpm
```

If the driver exists, upgrade it like this:

```
shell> su root
shell> rpm -Uvh mysql-connector-odbc-3.51.12.i386.rpm
```

If there is any dependency error for MySQL client library, `libmysqlclient`, simply ignore it by supplying the `--nodeps` option, and then make sure the MySQL client shared library is in the path or set through `LD_LIBRARY_PATH`.

This installs the driver libraries and related documents to `/usr/local/lib` and `/usr/share/doc/MyODBC`, respectively. Proceed onto [Section 20.1.4.5, “Configuring a Connector/ODBC DSN on Unix”](#).

To **uninstall** the driver, become `root` and execute an `rpm` command:

```
shell> su root
shell> rpm -e mysql-connector-odbc
```

### 20.1.3.3. Installing Connector/ODBC from a Binary Distribution on Mac OS X

Mac OS X is based on the FreeBSD operating system, and you can normally use the MySQL network port for connecting to MySQL servers on other hosts. Installing the Connector/ODBC driver enables you to connect to MySQL databases on any platform through the ODBC interface. You should only need to install the Connector/ODBC driver when your application requires an ODBC interface. Applications that require or can use ODBC (and therefore the Connector/ODBC driver) include ColdFusion, Filemaker Pro, 4th Dimension and many other applications.

Mac OS X includes its own ODBC manager, based on the `iODBC` manager. Mac OS X includes an administration tool that provides easier administration of ODBC drivers and configuration, updating the underlying `iODBC` configuration files.

The method for installing Connector/ODBC on Mac OS X depends on the version on Connector/ODBC you are using. For Connector/ODBC 3.51.14 and later, the package is provided as a compressed tar archive that you must manually install. For Connector/ODBC 3.51.13 and earlier the software was provided on a compressed disk image (`.dmg`) file and included an installer.

In either case, the driver is designed to work with the `iODBC` driver manager included with Mac OS X.

To install Connector/ODBC 3.51.14 and later:

1. Download the installation file. Note that versions are available for both PowerPC and Intel platforms.
2. Extract the archive:

```
shell> tar zxf mysql-connector-odbc-3.51.16-osx10.4-x86-32bit.tar.gz
```

3. The directory created will contain two subdirectories, `lib` and `bin`. You need to copy these to a suitable location such as `/usr/local`:

```
shell> cp bin/* /usr/local/bin
shell> cp lib/* /usr/local/lib
```

4. Finally, you must register the driver with `iODBC` using the `myodbc3i` tool you just installed:

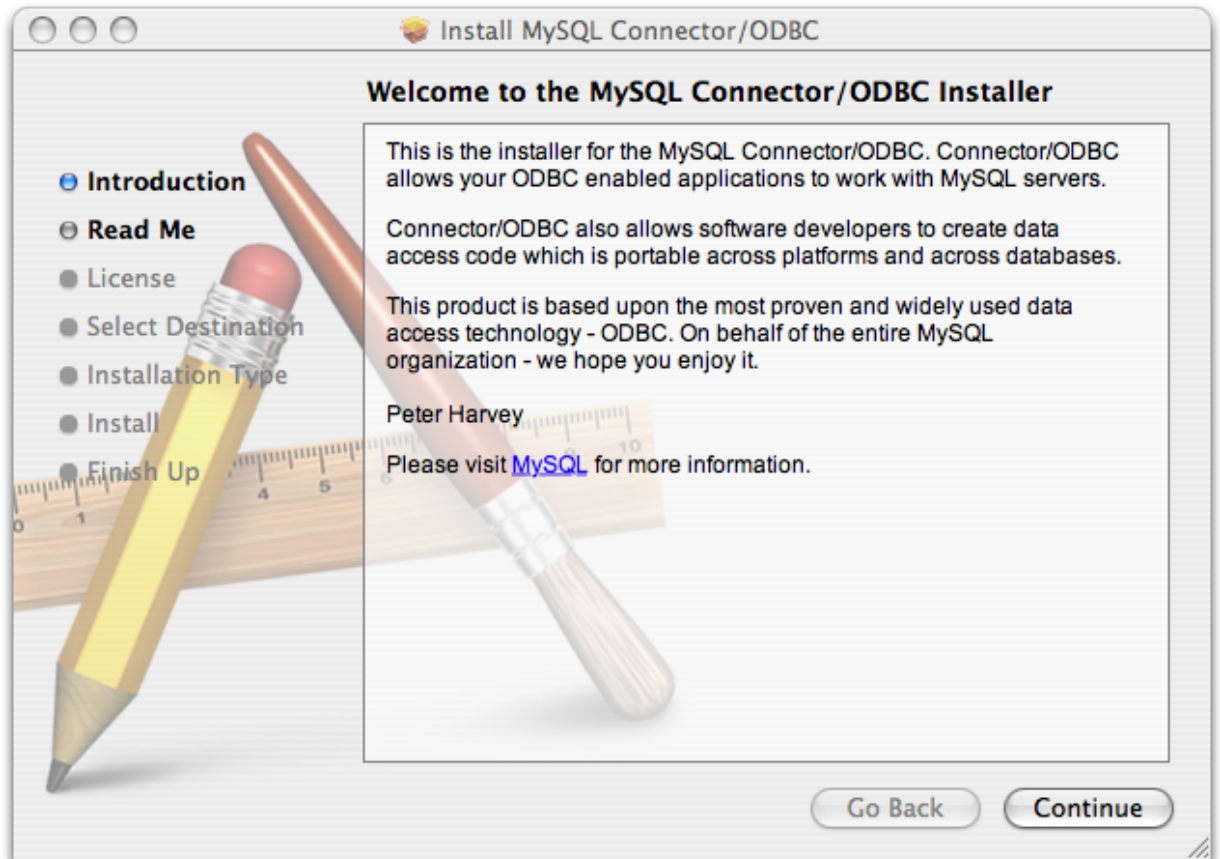
```
shell> myodbc3i -a -d -t"MySQL ODBC 3.51 Driver;Driver=/usr/local/lib/libmyodbc3.so;Setup=/usr/local/lib/libmyodbc3i" /usr/local/lib/libmyodbc3i
```

You can verify the installed drivers either by using the ODBC Administrator application or the `myodbc3i` utility:

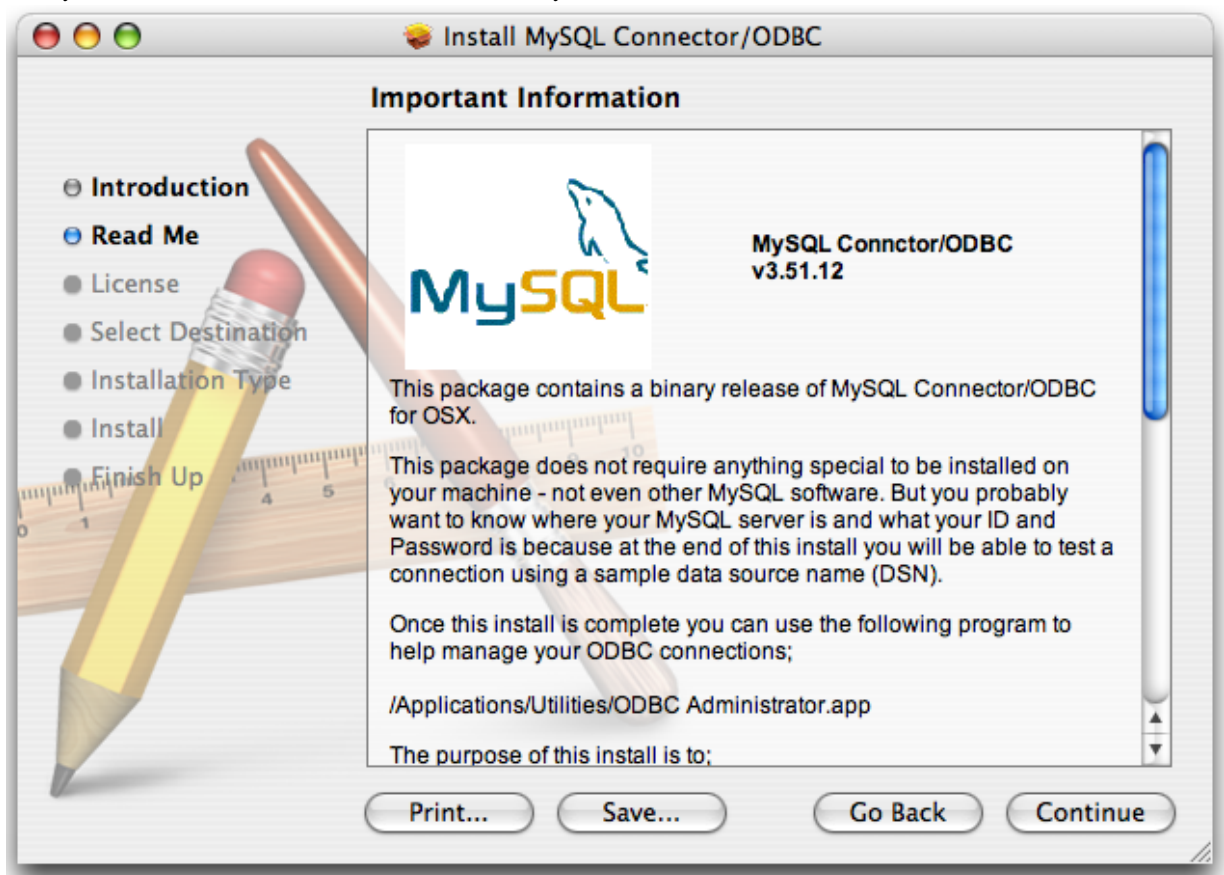
```
shell> myodbc3i -q -d
```

To install Connector/ODBC 3.51.13 and earlier, follow these steps:

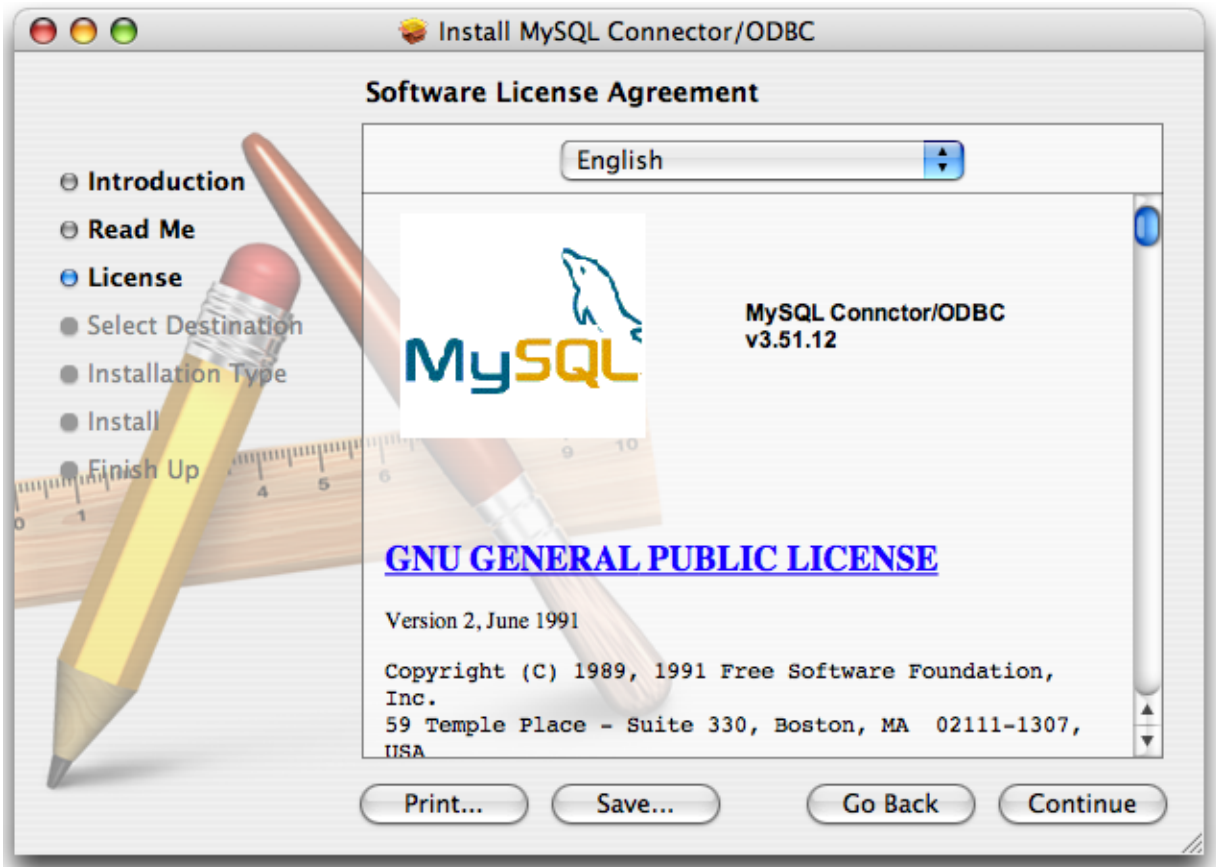
1. Download the file to your computer and double-click on the downloaded image file.
2. Within the disk image you will find an installer package (with the `.pkg` extension). Double click on this file to start the Mac OS X installer.
3. You will be presented with the installer welcome message. Click the `CONTINUE` button to begin the installation process.



4. Please take the time to read the Important Information as it contains guidance on how to complete the installation process. Once you have read the notice and collected the necessary information, click CONTINUE.

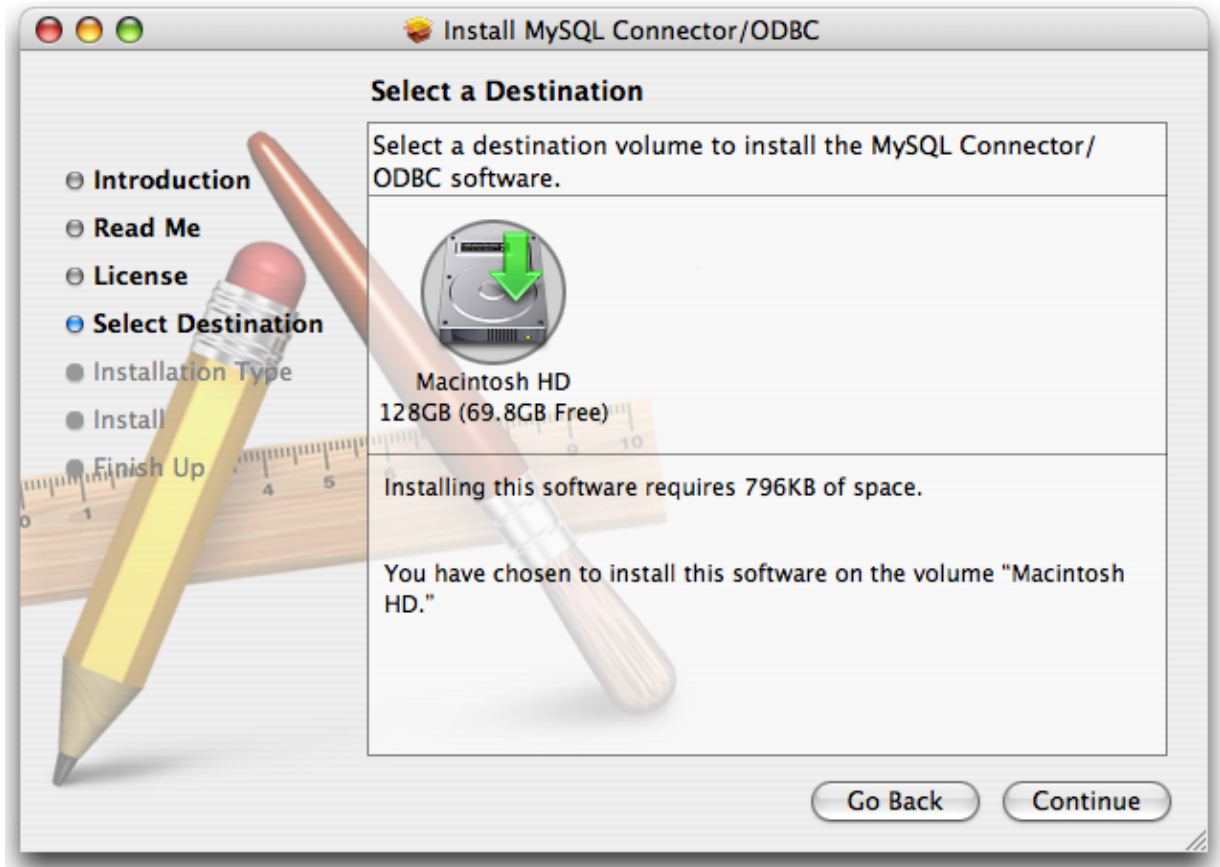


- Connector/ODBC drivers are made available under the GNU General Public License. Please read the license if you are not familiar with it before continuing installation. Click CONTINUE to approve the license (you will be asked to confirm that decision) and continue the installation.

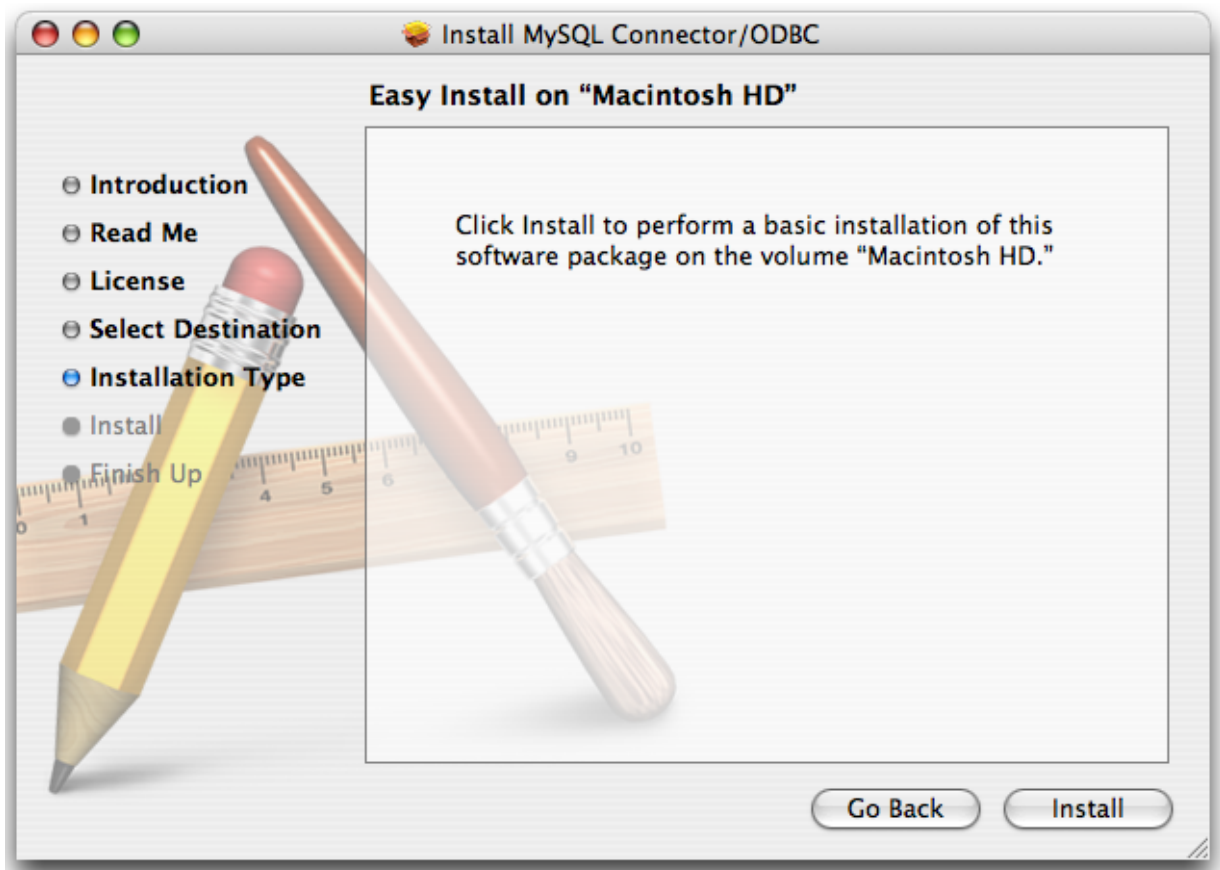


- Choose a location to install the Connector/ODBC drivers and the ODBC Administrator application. You must install the files onto a drive with an operating system and you may be limited in the choices available. Select the drive you want to use, and then click CONTINUE.



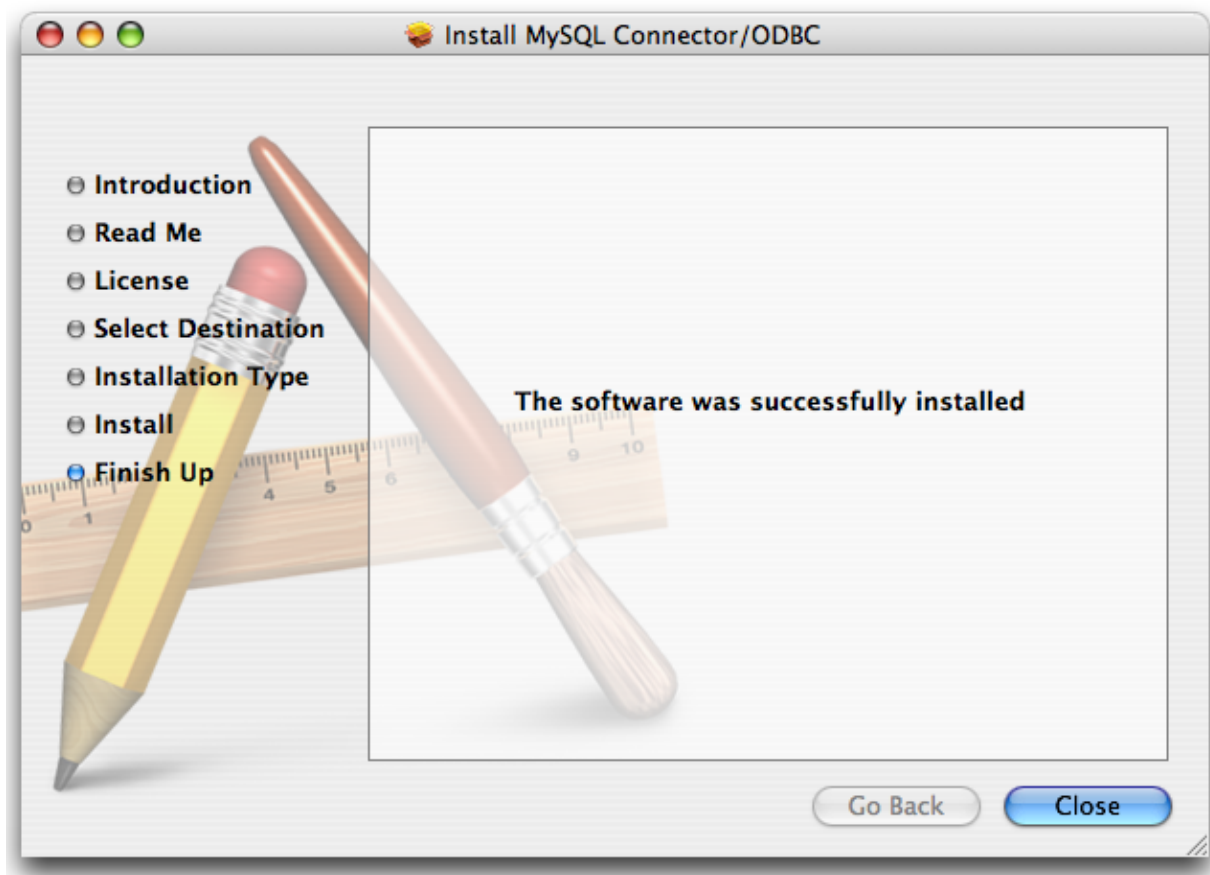


7. The installer will automatically select the files that need to be installed on your machine. Click **INSTALL** to continue. The installer will copy the necessary files to your machine. A progress bar will be shown indicating the installation progress.





8. When installation has been completed you will get a window like the one shown below. Click CLOSE to close and quit the installer.



#### 20.1.3.4. Installing Connector/ODBC from a Source Distribution on Windows

You should only need to install Connector/ODBC from source on Windows if you want to change or modify the source or installation. If you are unsure whether to install from source, please use the binary installation detailed in [Section 20.1.3.1, “Installing Connector/ODBC from a Binary Distribution on Windows”](#).

Installing Connector/ODBC from source on Windows requires a number of different tools and packages:

- MDAC, Microsoft Data Access SDK from <http://support.microsoft.com/kb/110093>.
- Suitable C compiler, such as Microsoft Visual C++ or the C compiler included with Microsoft Visual Studio.
- Compatible `make` tool. Microsoft's `nmake` is used in the examples in this section.
- MySQL client libraries and include files from MySQL 4.0.0 or higher. (Preferably MySQL 4.0.16 or higher). This is required because Connector/ODBC uses new calls and structures that exist only starting from this version of the library. To get the client libraries and include files, visit <http://dev.mysql.com/downloads/>.

##### 20.1.3.4.1. Building Connector/ODBC 3.51

Connector/ODBC source distributions include `Makefiles` that require the `nmake` or other `make` utility. In the distribution, you can find `Makefile` for building the release version and `Makefile_debug` for building debugging versions of the driver libraries and DLLs.

To build the driver, use this procedure:

1. Download and extract the sources to a folder, then change directory into that folder. The following command assumes the folder is named `myodbc3-src`:

```
C:\> cd myodbc3-src
```

2. Edit `Makefile` to specify the correct path for the MySQL client libraries and header files. Then use the following commands to build and install the release version:

```
C:\> nmake -f Makefile
C:\> nmake -f Makefile install
```

`nmake -f Makefile` builds the release version of the driver and places the binaries in subdirectory called `Release`.

`nmake -f Makefile install` installs (copies) the driver DLLs and libraries (`myodbc3.dll`, `myodbc3.lib`) to your system directory.

3. To build the debug version, use `Makefile_Debug` rather than `Makefile`, as shown below:

```
C:\> nmake -f Makefile_debug
C:\> nmake -f Makefile_debug install
```

4. You can clean and rebuild the driver by using:

```
C:\> nmake -f Makefile clean
C:\> nmake -f Makefile install
```

### Note

- Make sure to specify the correct MySQL client libraries and header files path in the Makefiles (set the `MYSQL_LIB_PATH` and `MYSQL_INCLUDE_PATH` variables). The default header file path is assumed to be `C:\mysql\include`. The default library path is assumed to be `C:\mysql\lib\opt` for release DLLs and `C:\mysql\lib\debug` for debug versions.
- For the complete usage of `nmake`, visit [http://msdn.microsoft.com/library/default.asp?url=/library/en-us/dv\\_vcce4/html/evgrfRunningNMAKE.asp](http://msdn.microsoft.com/library/default.asp?url=/library/en-us/dv_vcce4/html/evgrfRunningNMAKE.asp).
- If you are using the Subversion tree for compiling, all Windows-specific `Makefiles` are named as `Win_Makefile*`.

#### 20.1.3.4.2. Testing

After the driver libraries are copied/installed to the system directory, you can test whether the libraries are properly built by using the samples provided in the `samples` subdirectory:

```
C:\> cd samples
C:\> nmake -f Makefile all
```

#### 20.1.3.5. Installing Connector/ODBC from a Source Distribution on Unix

You need the following tools to build MySQL from source on Unix:

- A working ANSI C++ compiler. `gcc` 2.95.2 or later, SGI C++, and SunPro C++ are some of the compilers that are known to work.
- A good `make` program. GNU `make` is always recommended and is sometimes required.
- MySQL client libraries and include files from MySQL 4.0.0 or higher. (Preferably MySQL 4.0.16 or higher). This is required because Connector/ODBC uses new calls and structures that exist only starting from this version of the library. To get the client libraries and include files, visit <http://dev.mysql.com/downloads/>.

If you have built your own MySQL server and/or client libraries from source then you must have used the `-enable-thread-safe-client` option to `configure` when the libraries were built.

You should also ensure that the `libmysqlclient` library were built and installed as a shared library.

- A compatible ODBC manager must be installed. Connector/ODBC is known to work with the `iODBC` and `unixODBC` managers. See [Section 20.1.2.2.2, “ODBC Driver Managers”](#), for more information.
- If you are using a character set that isn't compiled into the MySQL client library then you need to install the MySQL character

definitions from the `charsets` directory into `SHAREDIR` (by default, `/usr/local/mysql/share/mysql/charsets`). These should be in place if you have installed the MySQL server on the same machine. See [Section 9.1, “Character Set Support”](#), for more information on character set support.

Once you have all the required files, unpack the source files to a separate directory, you then have to run `configure` and build the library using `make`.

### 20.1.3.5.1. Typical `configure` Options

The `configure` script gives you a great deal of control over how you configure your Connector/ODBC build. Typically you do this using options on the `configure` command line. You can also affect `configure` using certain environment variables. For a list of options and environment variables supported by `configure`, run this command:

```
shell> ./configure --help
```

Some of the more commonly used `configure` options are described here:

1. To compile Connector/ODBC, you need to supply the MySQL client include and library files path using the `--with-mysql-path=DIR` option, where `DIR` is the directory where MySQL is installed.

MySQL compile options can be determined by running `DIR/bin/mysql_config`.

2. Supply the standard header and library files path for your ODBC Driver Manager (`iODBC` or `unixODBC`).

- If you are using `iODBC` and `iODBC` is not installed in its default location (`/usr/local`), you might have to use the `--with-iodbc=DIR` option, where `DIR` is the directory where `iODBC` is installed.

If the `iODBC` headers do not reside in `DIR/include`, you can use the `--with-iodbc-includes=INCDIR` option to specify their location.

The applies to libraries. If they are not in `DIR/lib`, you can use the `--with-iodbc-libs=LIBDIR` option.

- If you are using `unixODBC`, use the `--with-unixODBC=DIR` option (case sensitive) to make `configure` look for `unixODBC` instead of `iODBC` by default, `DIR` is the directory where `unixODBC` is installed.

If the `unixODBC` headers and libraries aren't located in `DIR/include` and `DIR/lib`, use the `--with-unixODBC-includes=INCDIR` and `--with-unixODBC-libs=LIBDIR` options.

3. You might want to specify an installation prefix other than `/usr/local`. For example, to install the Connector/ODBC drivers in `/usr/local/odbc/lib`, use the `--prefix=/usr/local/odbc` option.

The final configuration command looks something like this:

```
shell> ./configure --prefix=/usr/local \
  --with-iodbc=/usr/local \
  --with-mysql-path=/usr/local/mysql
```

### 20.1.3.5.2. Additional `configure` Options

There are a number of other options that you need, or want, to set when configuring the Connector/ODBC driver before it is built.

- To link the driver with MySQL thread safe client libraries `libmysqlclient_r.so` or `libmysqlclient_r.a`, you must specify the following `configure` option:

```
--enable-thread-safe
```

and can be disabled (default) using

```
--disable-thread-safe
```

This option enables the building of the driver thread-safe library `libmyodbc3_r.so` from by linking with MySQL thread-safe client library `libmysqlclient_r.so` (The extensions are OS dependent).

If the compilation with the thread-safe option fails, it may be because the correct thread-libraries on the system could not be located. You should set the value of `LIBS` to point to the correct thread library for your system.

```
LIBS="-lpthread" ./configure ..
```

- You can enable or disable the shared and static versions of Connector/ODBC using these options:

```
--enable-shared[=yes/no]
--disable-shared
--enable-static[=yes/no]
--disable-static
```

- By default, all the binary distributions are built as non-debugging versions (configured with `--without-debug`).

To enable debugging information, build the driver from source distribution and use the `--with-debug` option when you run `configure`.

- This option is available only for source trees that have been obtained from the Subversion repository. This option does not apply to the packaged source distributions.

By default, the driver is built with the `--without-docs` option. If you would like the documentation to be built, then execute `configure` with:

```
--with-docs
```

### 20.1.3.5.3. Building and Compilation

To build the driver libraries, you have to just execute `make`.

```
shell> make
```

If any errors occur, correct them and continue the build process. If you aren't able to build, then send a detailed email to [myodbc@lists.mysql.com](mailto:myodbc@lists.mysql.com) for further assistance.

### 20.1.3.5.4. Building Shared Libraries

On most platforms, MySQL does not build or support `.so` (shared) client libraries by default. This is based on our experience of problems when building shared libraries.

In cases like this, you have to download the MySQL distribution and configure it with these options:

```
--without-server --enable-shared
```

To build shared driver libraries, you must specify the `--enable-shared` option for `configure`. By default, `configure` does not enable this option.

If you have configured with the `--disable-shared` option, you can build the `.so` file from the static libraries using the following commands:

```
shell> cd mysql-connector-odbc-3.51.01
shell> make
shell> cd driver
shell> CC=/usr/bin/gcc \
    $CC -bundle -flat_namespace -undefined error \
    -o .libs/libmyodbc3-3.51.01.so \
    catalog.o connect.o cursor.o dll.o error.o execute.o \
    handle.o info.o misc.o myodbc3.o options.o prepare.o \
    results.o transact.o utility.o \
    -L/usr/local/mysql/lib/mysql/ \
    -L/usr/local/iodbc/lib/ \
    -lz -lc -lmysqlclient -liodbcinst
```

Make sure to change `-liodbcinst` to `-lodbcinst` if you are using `unixODBC` instead of `iODBC`, and configure the library paths accordingly.

This builds and places the `libmyodbc3-3.51.01.so` file in the `.libs` directory. Copy this file to the Connector/ODBC library installation directory (`/usr/local/lib` (or the `lib` directory under the installation directory that you supplied with the `-prefix`)).

```
shell> cd .libs
shell> cp libmyodbc3-3.51.01.so /usr/local/lib
shell> cd /usr/local/lib
shell> ln -s libmyodbc3-3.51.01.so libmyodbc3.so
```

To build the thread-safe driver library:

```
shell> CC=/usr/bin/gcc \
  $CC -bundle -flat_namespace -undefined error
  -o .libs/libmyodbc3_r-3.51.01.so
  catalog.o connect.o cursor.o dll.o error.o execute.o
  handle.o info.o misc.o myodbc3.o options.o prepare.o
  results.o transact.o utility.o
  -L/usr/local/mysql/lib/mysql/
  -L/usr/local/iodbc/lib/
  -lz -lc -lmysqlclient_r -liodbcinst
```

### 20.1.3.5.5. Installing Driver Libraries

To install the driver libraries, execute the following command:

```
shell> make install
```

That command installs one of the following sets of libraries:

For Connector/ODBC 3.51:

- `libmyodbc3.so`
- `libmyodbc3-3.51.01.so`, where 3.51.01 is the version of the driver
- `libmyodbc3.a`

For thread-safe Connector/ODBC 3.51:

- `libmyodbc3_r.so`
- `libmyodbc3-3_r.51.01.so`
- `libmyodbc3_r.a`

For more information on build process, refer to the `INSTALL` file that comes with the source distribution. Note that if you are trying to use the `make` from Sun, you may end up with errors. On the other hand, GNU `gmake` should work fine on all platforms.

### 20.1.3.5.6. Testing Connector/ODBC on Unix

To run the basic samples provided in the distribution with the libraries that you built, use the following command:

```
shell> make test
```

Before running the tests, create the DSN 'myodbc3' in `odbc.ini` and set the environment variable `ODBCINI` to the correct `odbc.ini` file; and MySQL server is running. You can find a sample `odbc.ini` with the driver distribution.

You can even modify the `samples/run-samples` script to pass the desired DSN, UID, and PASSWORD values as the command-line arguments to each sample.

### 20.1.3.5.7. Building Connector/ODBC from Source on Mac OS X

To build the driver on Mac OS X (Darwin), make use of the following `configure` example:

```
shell> ./configure --prefix=/usr/local
  --with-unixODBC=/usr/local
  --with-mysql-path=/usr/local/mysql
  --disable-shared
  --enable-gui=no
  --host=powerpc-apple
```

The command assumes that the `unixODBC` and MySQL are installed in the default locations. If not, configure accordingly.

On Mac OS X, `--enable-shared` builds `.dylib` files by default. You can build `.so` files like this:

```
shell> make
shell> cd driver
shell> CC=/usr/bin/gcc \
  $CC -bundle -flat_namespace -undefined error
```

```
-o .libs/libmyodbc3-3.51.01.so *.o
-L/usr/local/mysql/lib/
-L/usr/local/iodbc/lib
-liodbcinst -lmysqlclient -lz -lc
```

To build the thread-safe driver library:

```
shell> CC=/usr/bin/gcc \
$CC -bundle -flat_namespace -undefined error
-o .libs/libmyodbc3-3.51.01.so *.o
-L/usr/local/mysql/lib/
-L/usr/local/iodbc/lib
-liodbcinst -lmysqlclient_r -lz -lc -lpthread
```

Make sure to change the `-liodbcinst` to `-lodbcinst` in case of using `unixODBC` instead of `iODBC` and configure the libraries path accordingly.

In Apple's version of GCC, both `cc` and `gcc` are actually symbolic links to `gcc3`.

Copy this library to the `$prefix/lib` directory and symlink to `libmyodbc3.so`.

You can cross-check the output shared-library properties using this command:

```
shell> otool -LD .libs/libmyodbc3-3.51.01.so
```

### 20.1.3.5.8. Building Connector/ODBC from Source on HP-UX

To build the driver on HP-UX 10.x or 11.x, make use of the following `configure` example:

If using `cc`:

```
shell> CC="cc" \
CFLAGS="+z" \
LDFLAGS="-Wl,+b:-Wl,+s" \
./configure --prefix=/usr/local
--with-unixodbc=/usr/local
--with-mysql-path=/usr/local/mysql/lib/mysql
--enable-shared
--enable-thread-safe
```

If using `gcc`:

```
shell> CC="gcc" \
LDFLAGS="-Wl,+b:-Wl,+s" \
./configure --prefix=/usr/local
--with-unixodbc=/usr/local
--with-mysql-path=/usr/local/mysql
--enable-shared
--enable-thread-safe
```

Once the driver is built, cross-check its attributes using `chatr .libs/libmyodbc3.sl` to determine whether you need to have set the MySQL client library path using the `SHLIB_PATH` environment variable. For static versions, ignore all shared-library options and run `configure` with the `--disable-shared` option.

### 20.1.3.5.9. Building Connector/ODBC from Source on AIX

To build the driver on AIX, make use of the following `configure` example:

```
shell> ./configure --prefix=/usr/local
--with-unixodbc=/usr/local
--with-mysql-path=/usr/local/mysql
--disable-shared
--enable-thread-safe
```

#### Note

For more information about how to build and set up the static and shared libraries across the different platforms refer to 'Using static and shared libraries across platforms'.

### 20.1.3.6. Installing Connector/ODBC from the Development Source Tree

#### Caution

You should read this section only if you are interested in helping us test our new code. If you just want to get MySQL Connector/ODBC up and running on your system, you should use a standard release distribution.

To be able to access the Connector/ODBC source tree, you must have Subversion installed. Subversion is freely available from <http://subversion.tigris.org/>.

To build from the source trees, you need the following tools:

- autoconf 2.52 (or newer)
- automake 1.4 (or newer)
- libtool 1.4 (or newer)
- m4

The most recent development source tree is available from our public Subversion trees at <http://dev.mysql.com/tech-resources/sources.html>.

To checkout out the Connector/ODBC sources, change to the directory where you want the copy of the Connector/ODBC tree to be stored, then use the following command:

```
shell> svn co http://svn.mysql.com/svnpublic/connector-odbc3
```

You should now have a copy of the entire Connector/ODBC source tree in the directory `connector-odbc3`. To build from this source tree on Unix or Linux follow these steps:

```
shell> cd connector-odbc3
shell> aclocal
shell> autoheader
shell> autoconf
shell> automake;
shell> ./configure # Add your favorite options here
shell> make
```

For more information on how to build, refer to the `INSTALL` file located in the same directory. For more information on options to `configure`, see [Section 20.1.3.5.1, “Typical configure Options”](#)

When the build is done, run `make install` to install the Connector/ODBC 3.51 driver on your system.

If you have gotten to the `make` stage and the distribution does not compile, please report it to [<myodbc@lists.mysql.com>](mailto:<myodbc@lists.mysql.com>).

On Windows, make use of Windows Makefiles `WIN-Makefile` and `WIN-Makefile_debug` in building the driver. For more information, see [Section 20.1.3.4, “Installing Connector/ODBC from a Source Distribution on Windows”](#).

After the initial checkout operation to get the source tree, you should run `svn update` periodically update your source according to the latest version.

## 20.1.4. Connector/ODBC Configuration

Before you connect to a MySQL database using the Connector/ODBC driver you must configure an ODBC *Data Source Name*. The DSN associates the various configuration parameters required to communicate with a database to a specific name. You use the DSN in an application to communicate with the database, rather than specifying individual parameters within the application itself. DSN information can be user specific, system specific, or provided in a special file. ODBC data source names are configured in different ways, depending on your platform and ODBC driver.

### 20.1.4.1. Data Source Names

A Data Source Name associates the configuration parameters for communicating with a specific database. Generally a DSN consists of the following parameters:

- Name
- Host Name
- Database Name
- Login
- Password

In addition, different ODBC drivers, including Connector/ODBC, may accept additional driver-specific options and parameters.

There are three types of DSN:

- A *System DSN* is a global DSN definition that is available to any user and application on a particular system. A System DSN can normally only be configured by a systems administrator, or by a user who has specific permissions that let them create System DSNs.
- A *User DSN* is specific to an individual user, and can be used to store database connectivity information that the user regularly uses.
- A *File DSN* uses a simple file to define the DSN configuration. File DSNs can be shared between users and machines and are therefore more practical when installing or deploying DSN information as part of an application across many machines.

DSN information is stored in different locations depending on your platform and environment.

### 20.1.4.2. Connector/ODBC Connection Parameters

You can specify the parameters in the following tables for Connector/ODBC when configuring a DSN. Users on Windows can use the Options and Advanced panels when configuring a DSN to set these parameters; see the table for information on which options relate to which fields and checkboxes. On Unix and Mac OS X, use the parameter name and value as the keyword/value pair in the DSN configuration. Alternatively, you can set these parameters within the `InConnectionString` argument in the `SQLDriverConnect()` call.

Parameter	Default Value	Comment
<code>user</code>	ODBC	The user name used to connect to MySQL.
<code>uid</code>	ODBC	Synonymous with <code>user</code> . Added in 3.51.16.
<code>server</code>	<code>localhost</code>	The host name of the MySQL server.
<code>database</code>		The default database.
<code>option</code>	0	Options that specify how Connector/ODBC should work. See below.
<code>port</code>	3306	The TCP/IP port to use if <code>server</code> is not <code>localhost</code> .
<code>initstmt</code>		Initial statement. A statement to execute when connecting to MySQL. In version 3.51 the parameter is called <code>stmt</code> . Note, the driver supports the initial statement being executed only at the time of the initial connection.
<code>password</code>		The password for the <code>user</code> account on <code>server</code> .
<code>pwd</code>		Synonymous with <code>password</code> . Added in 3.51.16.
<code>socket</code>		The Unix socket file or Windows named pipe to connect to if <code>server</code> is <code>localhost</code> .
<code>sslca</code>		The path to a file with a list of trust SSL CAs. Added in 3.51.16.
<code>sslcapath</code>		The path to a directory that contains trusted SSL CA certificates in PEM format. Added in 3.51.16.
<code>sslcert</code>		The name of the SSL certificate file to use for establishing a secure connection. Added in 3.51.16.
<code>sslcipher</code>		A list of allowable ciphers to use for SSL encryption. The cipher list has the same format as the <code>openssl ciphers</code> command. Added in 3.51.16.
<code>sslkey</code>		The name of the SSL key file to use for establishing a secure connection. Added in 3.51.16.
<code>charset</code>		The character set to use for the connection. Added in 3.51.17.
<code>sslverify</code>		If set to 1, the SSL certificate will be verified when used with the MySQL connection. If not set, then the default behaviour is to ignore SSL certificate verification.
<code>readtimeout</code>		The timeout in seconds for attempts to read from the server. Each attempt uses this timeout value and there are retries if necessary, so the total effective timeout value is three times the option value. You can set the value so that a lost connection can be detected earlier than the TCP/IP <code>Close_Wait_Timeout</code> value of 10 minutes. This option works only for TCP/IP connections, and only for Windows prior to MySQL 5.1.12. Corresponds to the <code>MYSQL_OPT_READ_TIMEOUT</code> option of the MySQL Client Library. This option was added in Connector/ODBC 3.51.27.
<code>writetimeout</code>		The timeout in seconds for attempts to write to the server. Each attempt uses this timeout value and there are <code>net_retry_count</code> retries if necessary, so the total



Parameter	Default Value	Comment
		effective timeout value is <code>net_retry_count</code> times the option value. This option works only for TCP/IP connections, and only for Windows prior to MySQL 5.1.12. Corresponds to the <code>MYSQL_OPT_WRITE_TIMEOUT</code> option of the MySQL Client Library. This option was added in Connector/ODBC 3.51.27.

## Note

The SSL configuration parameters can also be automatically loaded from a `my.ini` or `my.cnf` file.

The `option` argument is used to tell Connector/ODBC that the client isn't 100% ODBC compliant. On Windows, you normally select options by toggling the checkboxes in the connection screen, but you can also select them in the `option` argument. The following options are listed in the order in which they appear in the Connector/ODBC connect screen.

Value	Flagname	GUI Option	Description
1	<code>FLAG_FIELD_LENGTH</code>	Do not Optimize Column Width	The client cannot handle that Connector/ODBC returns the real width of a column. This option was removed in 3.51.18.
2	<code>FLAG_FOUND_ROWS</code>	Return Matching Rows	The client cannot handle that MySQL returns the true value of affected rows. If this flag is set, MySQL returns "found rows" instead. You must have MySQL 3.21.14 or newer to get this to work.
4	<code>FLAG_DEBUG</code>	Trace Driver Calls To myodbc.log	Make a debug log in <code>C:\myodbc.log</code> on Windows, or <code>/tmp/myodbc.log</code> on Unix variants. This option was removed in Connector/ODBC 3.51.18.
8	<code>FLAG_BIG_PACKETS</code>	Allow Big Results	Do not set any packet limit for results and bind parameters. Without this option, parameter binding will be truncated to 255 characters.
16	<code>FLAG_NO_PROMPT</code>	Do not Prompt Upon Connect	Do not prompt for questions even if driver would like to prompt.
32	<code>FLAG_DYNAMIC_CURSOR</code>	Enable Dynamic Cursor	Enable or disable the dynamic cursor support.
64	<code>FLAG_NO_SCHEMA</code>	Ignore # in Table Name	Ignore use of database name in <code>db_name.tbl_name.col_name</code> .
128	<code>FLAG_NO_DEFAULT_CURSOR</code>	User Manager Cursors	Force use of ODBC manager cursors (experimental).
256	<code>FLAG_NO_LOCALE</code>	Do not Use Set Locale	Disable the use of extended fetch (experimental).
512	<code>FLAG_PAD_SPACE</code>	Pad Char To Full Length	Pad <code>CHAR</code> columns to full column length.
1024	<code>FLAG_FULL_COLUMN_NAMES</code>	Return Table Names for SQLDescribeCol	<code>SQLDescribeCol()</code> returns fully qualified column names.
2048	<code>FLAG_COMPRESSED_PROTO</code>	Use Compressed Protocol	Use the compressed client/server protocol.
4096	<code>FLAG_IGNORE_SPACE</code>	Ignore Space After Function Names	Tell server to ignore space after function name and before "(" (needed by PowerBuilder). This makes all function names keywords.
8192	<code>FLAG_NAMED_PIPE</code>	Force Use of Named Pipes	Connect with named pipes to a <code>mysqld</code> server running on NT.
16384	<code>FLAG_NO_BIGINT</code>	Change BIGINT Columns to Int	Change <code>BIGINT</code> columns to <code>INT</code> columns (some applications cannot handle <code>BIGINT</code> ).
32768	<code>FLAG_NO_CATALOG</code>	No Catalog	Forces results from the catalog functions, such as <code>SQLTables</code> , to always return <code>NULL</code> and the driver to report that catalogs are not supported.
65536	<code>FLAG_USE_MYCNF</code>	Read Options From my.cnf	Read parameters from the <code>[client]</code> and <code>[odbc]</code> groups from <code>my.cnf</code> .
131072	<code>FLAG_SAFE</code>	Safe	Add some extra safety checks.
262144	<code>FLAG_NO_TRANSACTIONS</code>	Disable transactions	Disable transactions.
524288	<code>FLAG_LOG_QUERY</code>	Save queries to myodbc.sql	Enable query logging to <code>c:\myodbc.sql(/tmp/myodbc.sql)</code> file. (Enabled only in debug mode.)

1048576	FLAG_NO_CACHE	Do not Cache Result (forward only cursors)	Do not cache the results locally in the driver, instead read from server ( <code>mysql_use_result()</code> ). This works only for forward-only cursors. This option is very important in dealing with large tables when you do not want the driver to cache the entire result set.
2097152	FLAG_FORWARD_CURSOR	Force Use Of Forward Only Cursors	Force the use of <code>Forward-only</code> cursor type. In case of applications setting the default static/dynamic cursor type, and one wants the driver to use non-cache result sets, then this option ensures the forward-only cursor behavior.
4194304	FLAG_AUTO_RECONNECT	Enable auto-reconnect.	Enables auto-reconnection functionality. You should not use this option with transactions, since a auto reconnection during a incomplete transaction may cause corruption. Note that an auto-reconnected connection will not inherit the same settings and environment as the original. This option was added in Connector/ODBC 3.51.13.
8388608	FLAG_AUTO_IS_NULL	Flag Auto Is Null	<p>When <code>FLAG_AUTO_IS_NULL</code> is set, the driver does not change the default value of <code>sql_auto_is_null</code>, leaving it at 1, so you get the MySQL default, not the SQL standard behavior.</p> <p>When <code>FLAG_AUTO_IS_NULL</code> is not set, the driver changes the default value of <code>SQL_AUTO_IS_NULL</code> to 0 after connecting, so you get the SQL standard, not the MySQL default behaviour.</p> <p>Thus, omitting the flag disables the compatibility option and forces SQL standard behaviour.</p> <p>See <code>IS NULL</code>. This option was added in Connector/ODBC 3.51.13.</p>
16777216	FLAG_ZERO_DATE_TO_MIN	Flag Zero Date to Min	Translates zero dates ( <code>XXXX-00-00</code> ) into the minimum date values supported by ODBC, <code>XXXX-01-01</code> . This resolves an issue where some statements will not work because the date returned and the minimum ODBC date value are incompatible. This option was added in Connector/ODBC 3.51.17.
33554432	FLAG_MIN_DATE_TO_ZERO	Flag Min Date to Zero	Translates the minimum ODBC date value ( <code>XXXX-01-01</code> ) to the zero date format supported by MySQL ( <code>XXXX-00-00</code> ). This resolves an issue where some statements will not work because the date returned and the minimum ODBC date value are incompatible. This option was added in Connector/ODBC 3.51.17.
67108864	FLAG_MULTI_STATEMENTS	Allow multiple statements	Enables support for batched statements. This option was added in Connector/ODBC 3.51.18.
134217728	FLAG_COLUMN_SIZE_S32	Limit column size to 32-bit value	Limits the column size to a signed 32-bit value to prevent problems with larger column sizes in applications that do not support them. This option is automatically enabled when working with ADO applications. This option was added in Connector/ODBC 3.51.22.
268435456	FLAG_NO_BINARY_RESULT	Always handle binary function results as character data	When set this option disables charset 63 for columns with an empty <code>org_table</code> . This option was added in Connector/ODBC 3.51.26.

To select multiple options, add together their values. For example, setting `option` to 12 (4+8) gives you debugging without packet limits.

The following table shows some recommended `option` values for various configurations.

Configuration	Option Value
Microsoft Access, Visual Basic	3
Driver trace generation (Debug mode)	4
Microsoft Access (with improved DELETE queries)	35
Large tables with too many rows	2049
Sybase PowerBuilder	135168

Query log generation (Debug mode)	524288
Generate driver trace as well as query log (Debug mode)	524292
Large tables with no-cache results	3145731

### 20.1.4.3. Configuring a Connector/ODBC DSN on Windows

The [ODBC Data Source Administrator](#) within Windows enables you to create DSNs, check driver installation and configure ODBC systems such as tracing (used for debugging) and connection pooling.

Different editions and versions of Windows store the [ODBC Data Source Administrator](#) in different locations depending on the version of Windows that you are using.

To open the [ODBC Data Source Administrator](#) in Windows Server 2003:

#### Tip

Because it is possible to create DSN using either the 32-bit or 64-bit driver, but using the same DNS identifier, it is advisable to include the driver being used within the DSN identifier. This will help you to identify the DSN when using it from applications such as Excel that are only compatible with the 32-bit driver. For example, you might add [Using32bitCODBC](#) to the DSN identifier for the 32-bit interface and [Using64bitCODBC](#) for those using the 64-bit Connector/ODBC driver.

1. On the [Start](#) menu, choose [Administrative Tools](#), and then click [Data Sources \(ODBC\)](#).

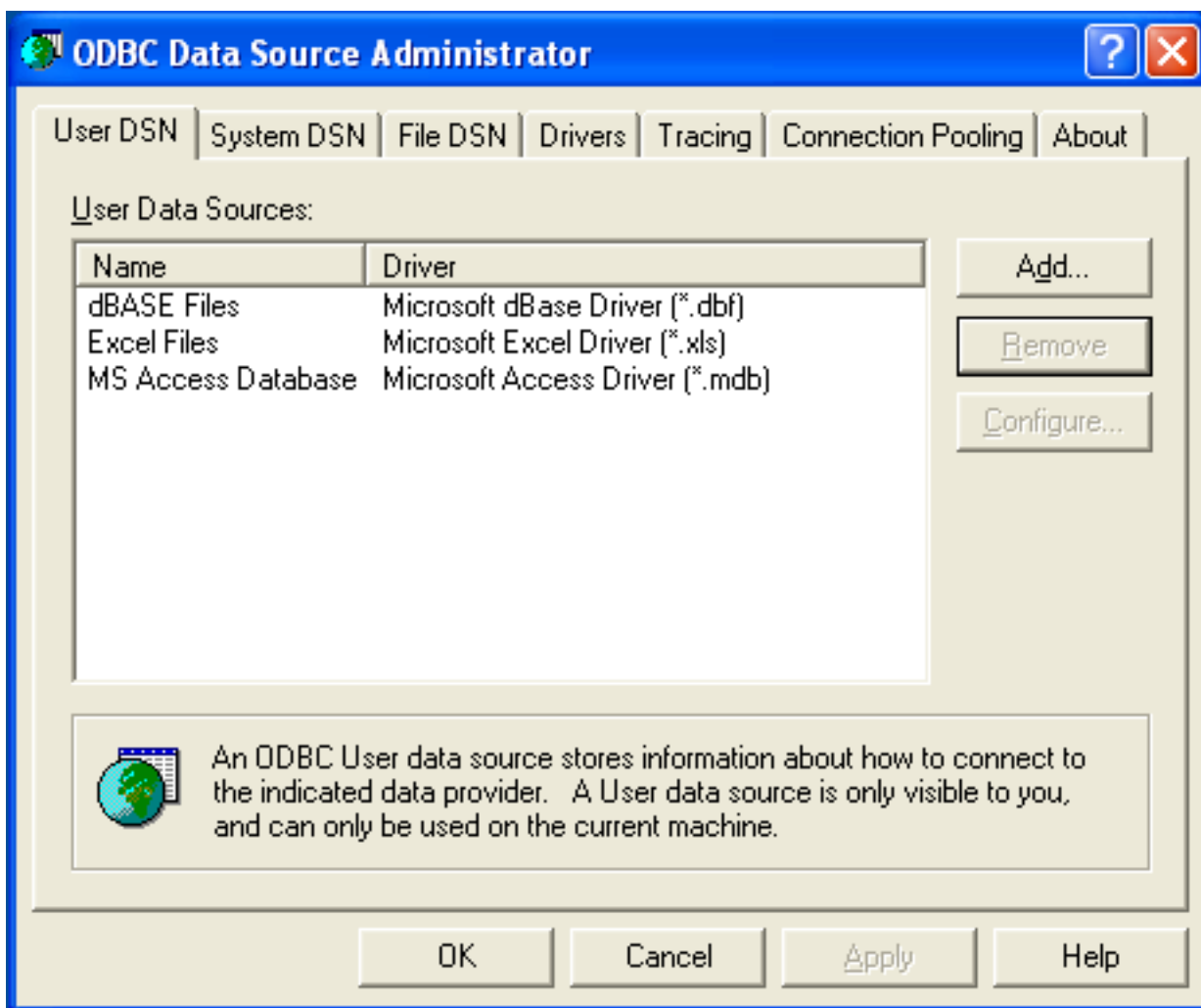
To open the [ODBC Data Source Administrator](#) in Windows 2000 Server or Windows 2000 Professional:

1. On the [Start](#) menu, choose [Settings](#), and then click [Control Panel](#).
2. In [Control Panel](#), click [Administrative Tools](#).
3. In [Administrative Tools](#), click [Data Sources \(ODBC\)](#).

To open the [ODBC Data Source Administrator](#) on Windows XP:

1. On the [Start](#) menu, click [Control Panel](#).
2. In the [Control Panel](#) when in [Category View](#) click [Performance and Maintenance](#) and then click [Administrative Tools](#). If you are viewing the [Control Panel](#) in [Classic View](#), click [Administrative Tools](#).
3. In [Administrative Tools](#), click [Data Sources \(ODBC\)](#).

Irrespective of your Windows version, you should be presented the [ODBC Data Source Administrator](#) window:



Within Windows XP, you can add the [Administrative Tools](#) folder to your START menu to make it easier to locate the ODBC Data Source Administrator. To do this:

1. Right click on the START menu.
2. Select [Properties](#).
3. Click CUSTOMIZE....
4. Select the ADVANCED tab.
5. Within [Start menu items](#), within the [System Administrative Tools](#) section, select [Display on the All Programs menu](#).

Within both Windows Server 2003 and Windows XP you may want to permanently add the [ODBC Data Source Administrator](#) to your START menu. To do this, locate the [Data Sources \(ODBC\)](#) icon using the methods shown, then right-click on the icon and then choose PIN TO START MENU.

The interfaces for the 3.51 and 5.1 versions of the Connector/ODBC driver are different, although the fields and information that you need to enter remain the same.

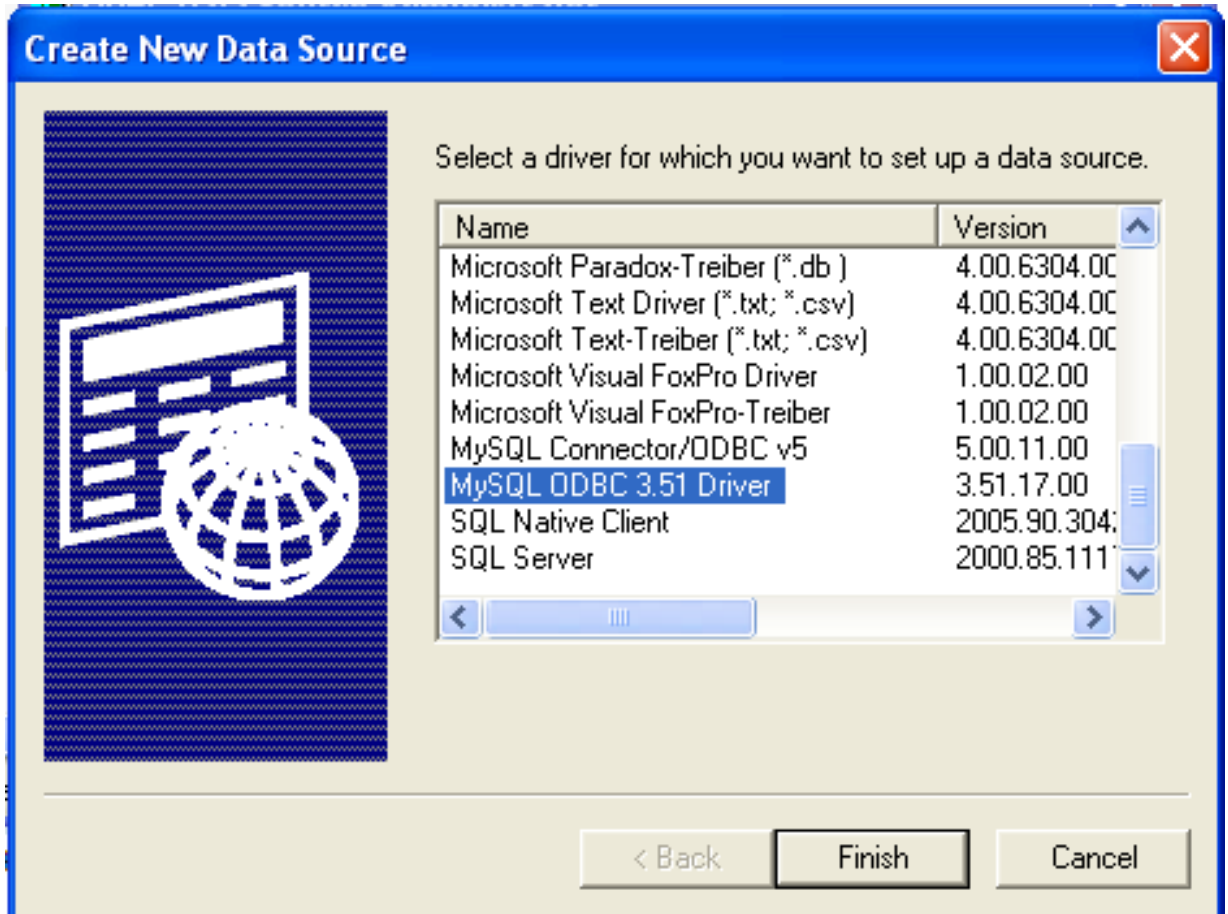
To configure a DSN using Connector/ODBC 3.51.x or Connector/ODBC 5.1.0, see [Section 20.1.4.3.1, “Configuring a Connector/ODBC 3.51 DSN on Windows”](#).

To configure a DSN using Connector/ODBC 5.1.1 or later, see [Section 20.1.4.3.2, “Configuring a Connector/ODBC 5.1 DSN on Windows”](#).

### 20.1.4.3.1. Configuring a Connector/ODBC 3.51 DSN on Windows

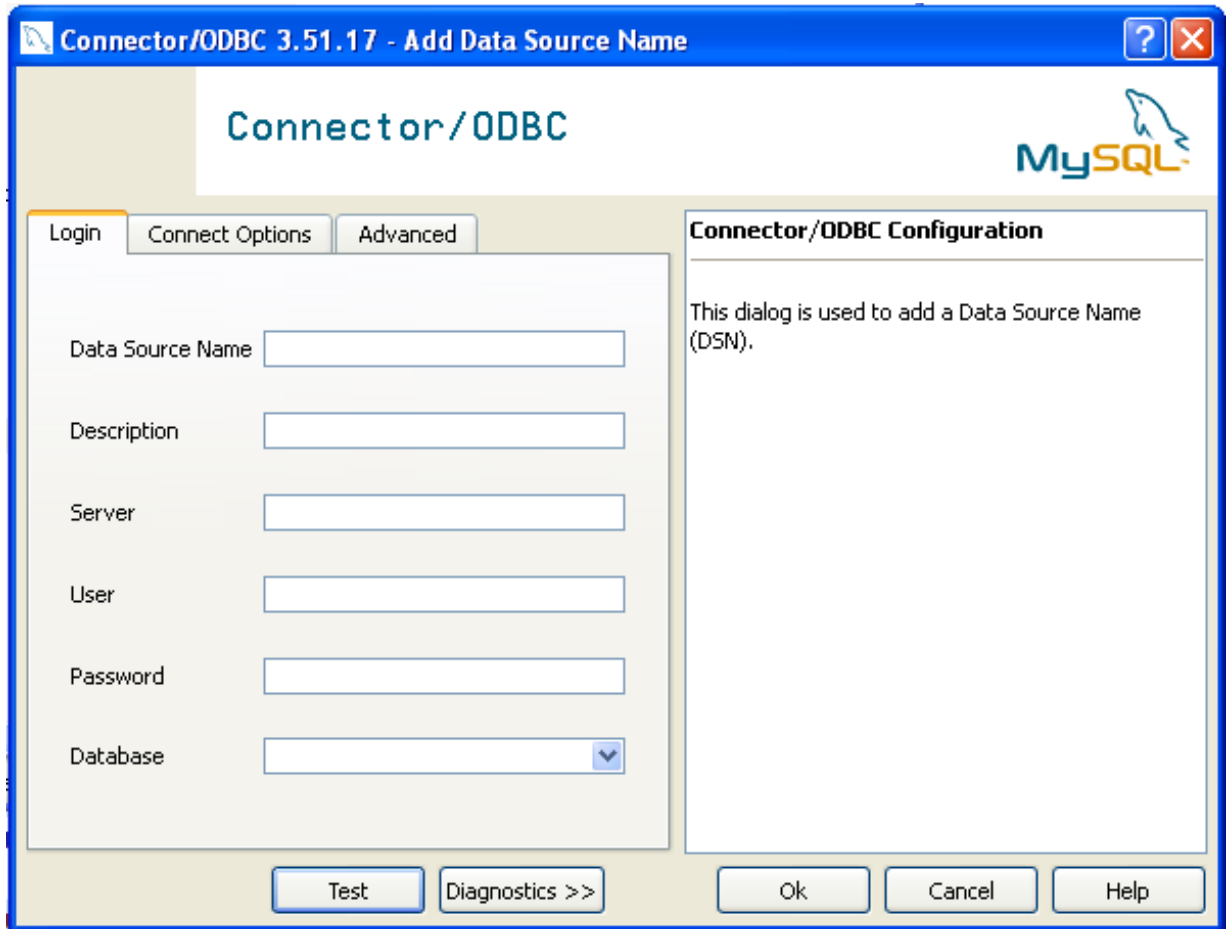
To add and configure a new Connector/ODBC data source on Windows, use the [ODBC Data Source Administrator](#):

1. Open the [ODBC Data Source Administrator](#).
2. To create a System DSN (which will be available to all users) , select the [System DSN](#) tab. To create a User DSN, which will be unique only to the current user, click the [ADD...](#) button.
3. You will need to select the ODBC driver for this DSN.



Select [MySQL ODBC 3.51 Driver](#), then click [FINISH](#).

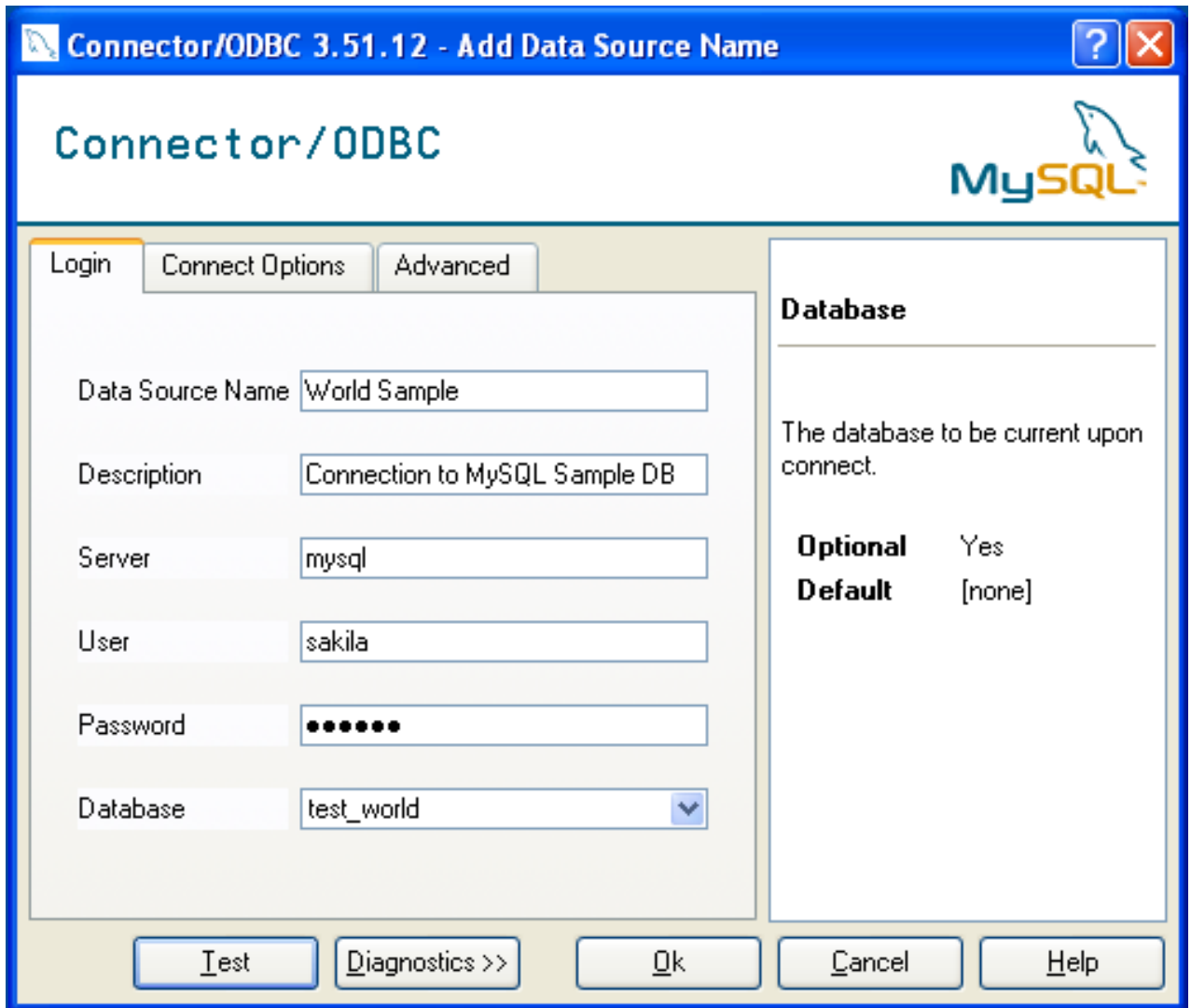
4. You now need to configure the specific fields for the DSN you are creating through the [Add Data Source Name](#) dialog.



In the **DATA SOURCE NAME** box, enter the name of the data source you want to access. It can be any valid name that you choose.

5. In the **DESCRIPTION** box, enter some text to help identify the connection.
6. In the **SERVER** field, enter the name of the MySQL server host that you want to access. By default, it is `localhost`.
7. In the **USER** field, enter the user name to use for this connection.
8. In the **PASSWORD** field, enter the corresponding password for this connection.
9. The **DATABASE** pop-up should automatically populate with the list of databases that the user has permissions to access.
10. Click **OK** to save the DSN.

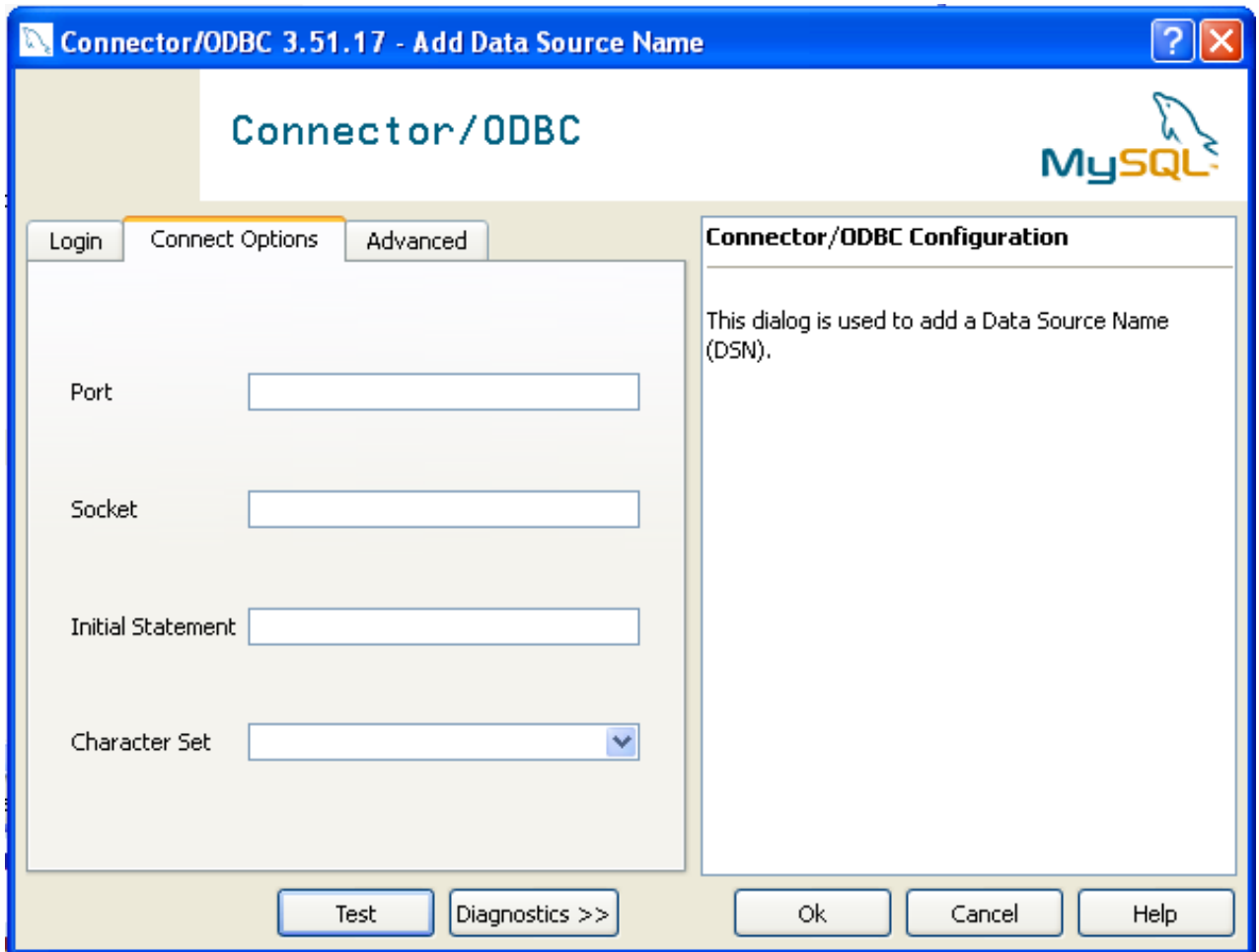
A completed DSN configuration may look like this:



You can verify the connection using the parameters you have entered by clicking the TEST button. If the connection could be made successfully, you will be notified with a `Success; connection was made!` dialog.

If the connection failed, you can obtain more information on the test and why it may have failed by clicking the DIAGNOSTICS... button to show additional error messages.

You can configure a number of options for a specific DSN by using either the CONNECT OPTIONS or ADVANCED tabs in the DSN configuration dialog.

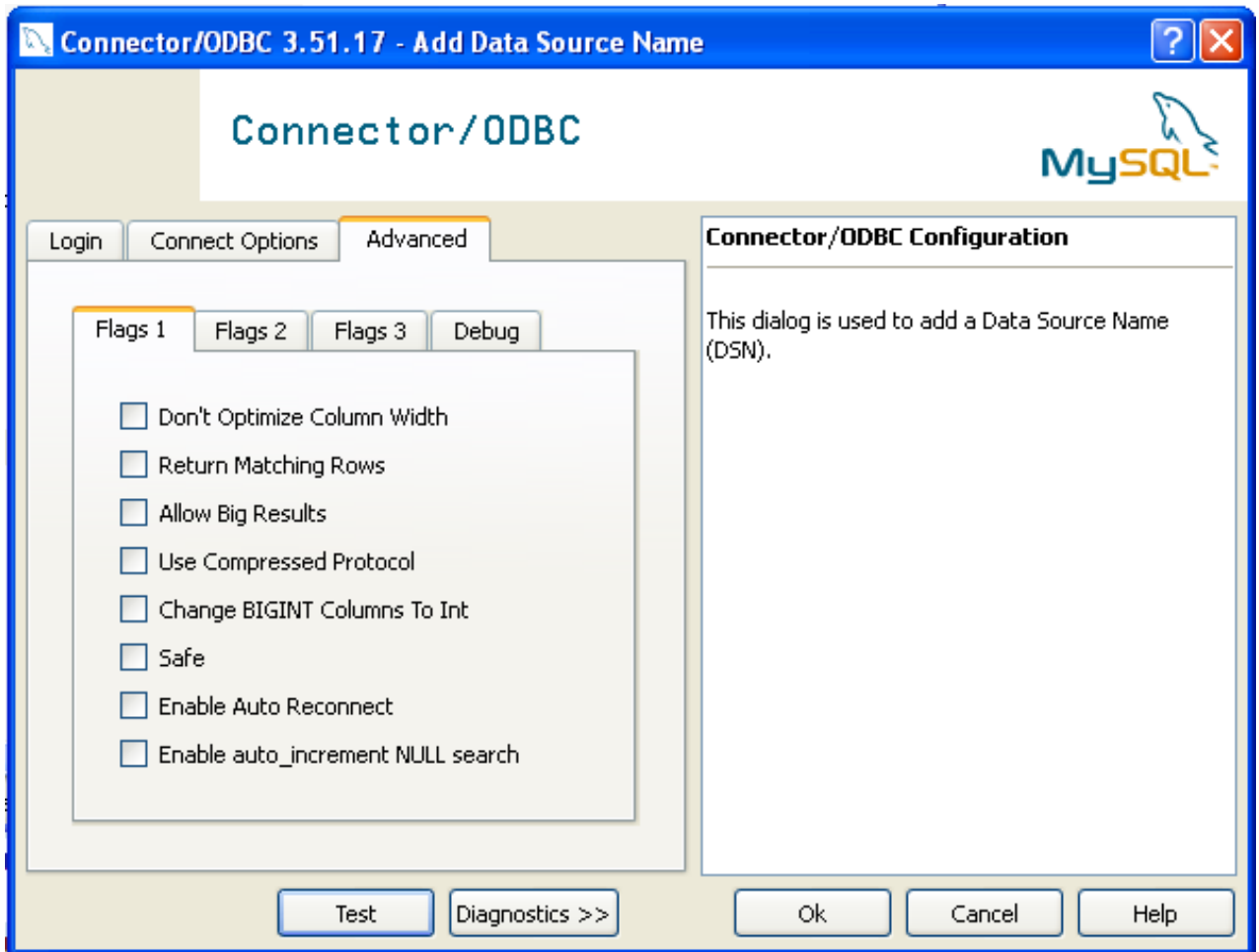


The three options you can configure are:

- **PORT** sets the TCP/IP port number to use when communicating with MySQL. Communication with MySQL uses port 3306 by default. If your server is configured to use a different TCP/IP port, you must specify that port number here.
- **SOCKET** sets the name or location of a specific socket or Windows pipe to use when communicating with MySQL.
- **INITIAL STATEMENT** defines an SQL statement that will be executed when the connection to MySQL is opened. You can use this to set MySQL options for your connection, such as disabling autocommit.
- **CHARACTER SET** is a pop-up list from which you can select the default character set to be used with this connection. The Character Set option was added in 3.5.17.

The **ADVANCED** tab enables you to configure Connector/ODBC connection parameters. Refer to [Section 20.1.4.2, “Connector/ODBC Connection Parameters”](#), for information about the meaning of these options.



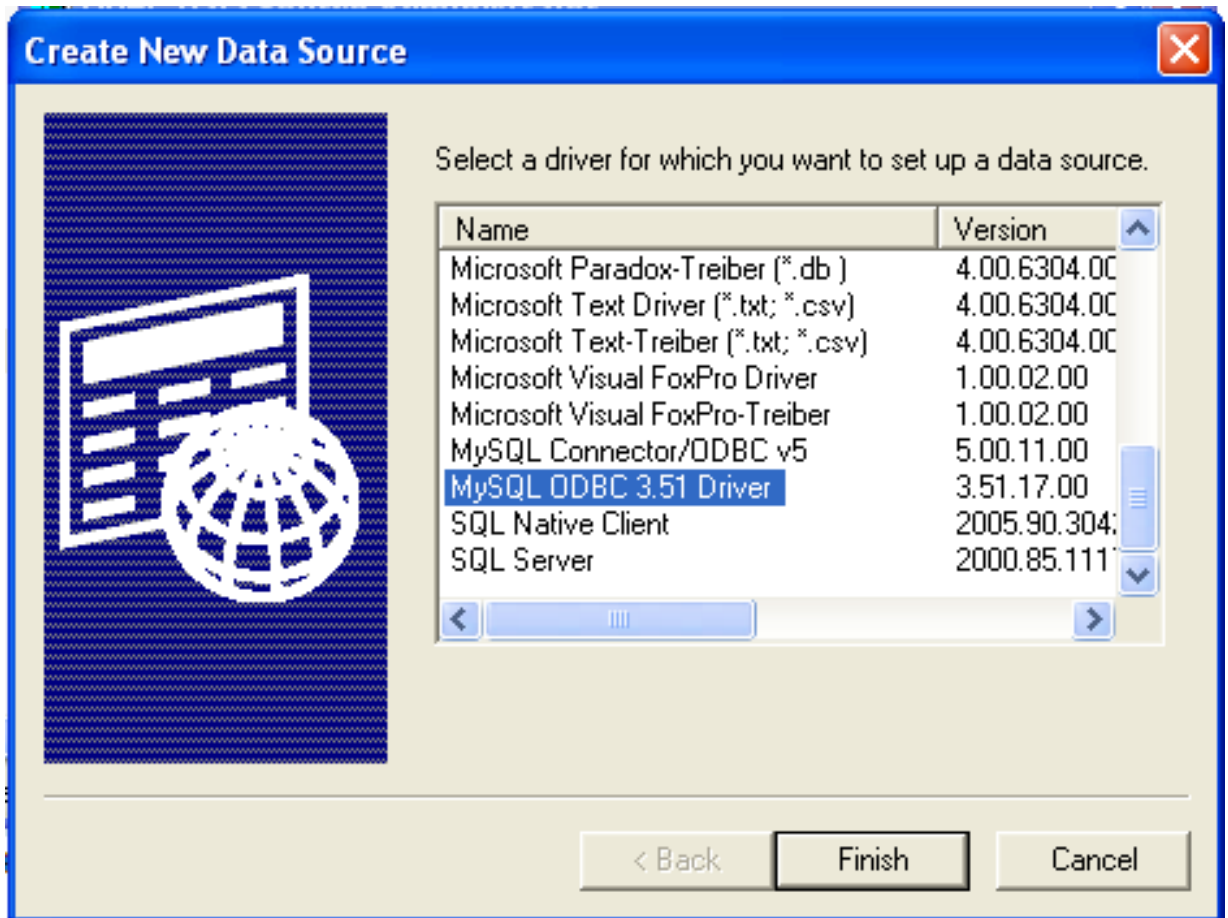


#### 20.1.4.3.2. Configuring a Connector/ODBC 5.1 DSN on Windows

The DSN configuration when using Connector/ODBC 5.1.1 and later has a slightly different layout. Also, due to the native Unicode support within Connector/ODBC 5.1, you no longer need to specify the initial character set to be used with your connection.

To configure a DSN using the Connector/ODBC 5.1.1 or later driver:

1. Open the [ODBC Data Source Administrator](#).
2. To create a System DSN (which will be available to all users), select the **SYSTEM DSN** tab. To create a User DSN, which will be unique only to the current user, click the **ADD...** button.
3. You will need to select the ODBC driver for this DSN.



Select **MySQL ODBC 3.51 Driver**, then click FINISH.

4. You now need to configure the specific fields for the DSN you are creating through the [Connection Parameters](#) dialog.

MySQL Connector/ODBC Data Source Configuration

MySQL Connector/ODBC

Connection Parameters

Data Source Name:

Description:

Server:  Port:

User:

Password:

Database:

In the **DATA SOURCE NAME** box, enter the name of the data source you want to access. It can be any valid name that you choose.

5. In the **DESCRIPTION** box, enter some text to help identify the connection.
6. In the **SERVER** field, enter the name of the MySQL server host that you want to access. By default, it is `localhost`.
7. In the **USER** field, enter the user name to use for this connection.
8. In the **PASSWORD** field, enter the corresponding password for this connection.
9. The **DATABASE** pop-up should automatically populate with the list of databases that the user has permissions to access.
10. To communicate over a different TCP/IP port than the default (3306), change the value of the **PORT**.
11. Click OK to save the DSN.

You can verify the connection using the parameters you have entered by clicking the **TEST** button. If the connection could be made successfully, you will be notified with a `Success; connection was made!` dialog.

You can configure a number of options for a specific DSN by using the **DETAILS** button.

MySQL Connector/ODBC Data Source Configuration

MySQL Connector/ODBC

Connection Parameters

Data Source Name:

Description:

Server:  Port:

User:

Password:

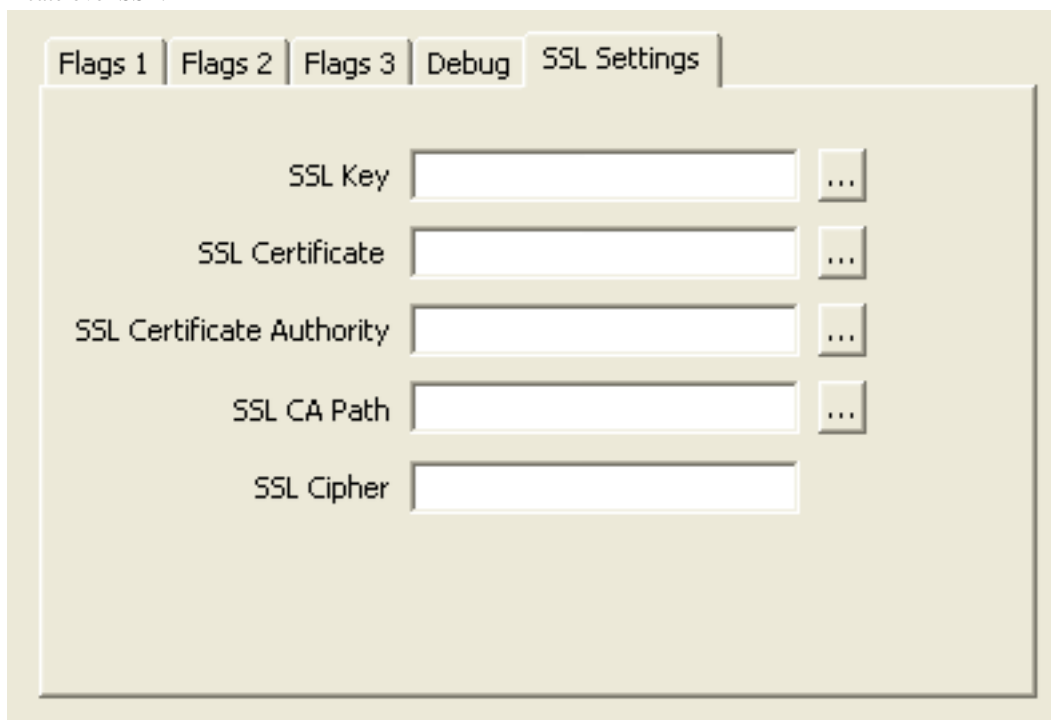
Database:

Flags 1 | Flags 2 | Flags 3 | Debug | SSL Settings

- Return matched rows instead of affected rows
- Allow big result sets
- Use compression
- Treat BIGINT columns as INT columns
- Enable safe options (see documentation)
- Enable automatic reconnect
- Enable SQL\_AUTO\_IS\_NULL

The **DETAILS** button opens a tabbed display which allows you to set additional options:

- **FLAGS 1**, **FLAGS 2**, and **FLAGS 3** enable you to select the additional flags for the DSN connection. For more information on these flags, see [Section 20.1.4.2, “Connector/ODBC Connection Parameters”](#).
- **DEBUG** allows you to enable ODBC debugging to record the queries you execute through the DSN to the `myodbc.sql` file. For more information, see [Section 20.1.4.8, “Getting an ODBC Trace File”](#).
- **SSL SETTINGS** configures the additional options required for using the Secure Sockets Layer (SSL) when communicating with MySQL server. Note that you must have enabled SSL and configured the MySQL server with suitable certificates to communicate over SSL.



The **ADVANCED** tab enables you to configure Connector/ODBC connection parameters. Refer to [Section 20.1.4.2, “Connector/ODBC Connection Parameters”](#), for information about the meaning of these options.

### 20.1.4.3.3. Errors and Debugging

This section answers Connector/ODBC connection-related questions.

- **While configuring a Connector/ODBC DSN, a [Could Not Load Translator or Setup Library](#) error occurs**

For more information, refer to [MS KnowledgeBase Article\(Q260558\)](#). Also, make sure you have the latest valid `ct13d32.dll` in your system directory.

- On Windows, the default `myodbc3.dll` is compiled for optimal performance. If you want to debug Connector/ODBC 3.51 (for example, to enable tracing), you should instead use `myodbc3d.dll`. To install this file, copy `myodbc3d.dll` over the installed `myodbc3.dll` file. Make sure to revert back to the release version of the driver DLL once you are done with the debugging because the debug version may cause performance issues. Note that the `myodbc3d.dll` isn't included in Connector/ODBC 3.51.07 through 3.51.11. If you are using one of these versions, you should copy that DLL from a previous version (for example, 3.51.06).

### 20.1.4.4. Configuring a Connector/ODBC DSN on Mac OS X

To configure a DSN on Mac OS X you can either use the `myodbc3i` utility, edit the `odbc.ini` file within the `Library/ODBC` directory of the user or the should use the ODBC Administrator. If you have Mac OS X 10.2 or earlier, refer to [Section 20.1.4.5, “Configuring a Connector/ODBC DSN on Unix”](#). Select whether you want to create a User DSN or a System DSN. If you want to add a System DSN, you may need to authenticate with the system. You must click the padlock and enter a user and password with administrator privileges.

For correct operation of ODBC Administrator, you should ensure that the `/Library/ODBC/odbc.ini` file used to set up ODBC connectivity and DSNs are writable by the `admin` group. If this file is not writable by this group then the ODBC Administrator may fail, or may appear to have worked but not generated the correct entry.

### Warning

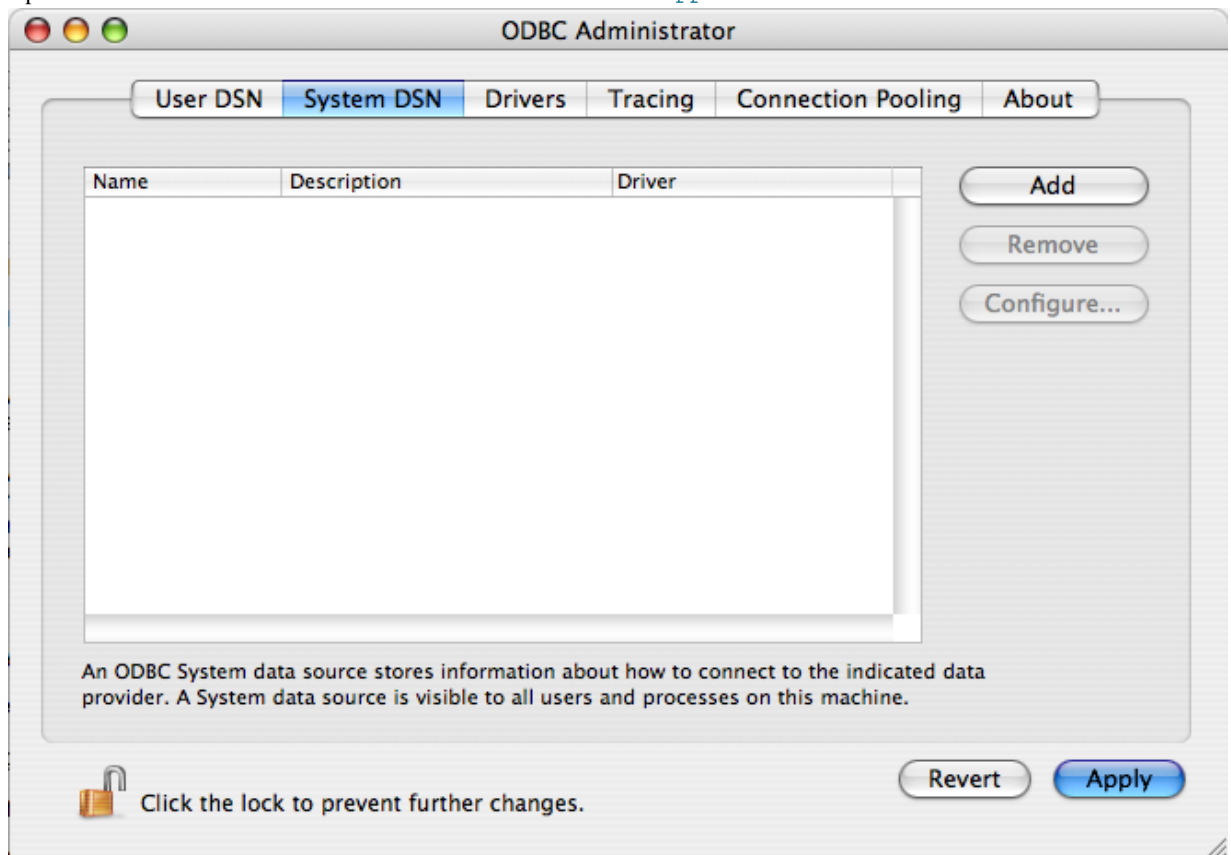
There are known issues with the OS X ODBC Administrator and Connector/ODBC that may prevent you from creating a DSN using this method. In this case you should use the command-line or edit the `odbc.ini` file directly. Note that existing DSNs or those that you create via the `myodbc3i` or `myodbc-installertool` can still be checked and edited using ODBC Administrator.

To create a DSN using the `myodbc3i` utility, you need only specify the DSN type and the DSN connection string. For example:

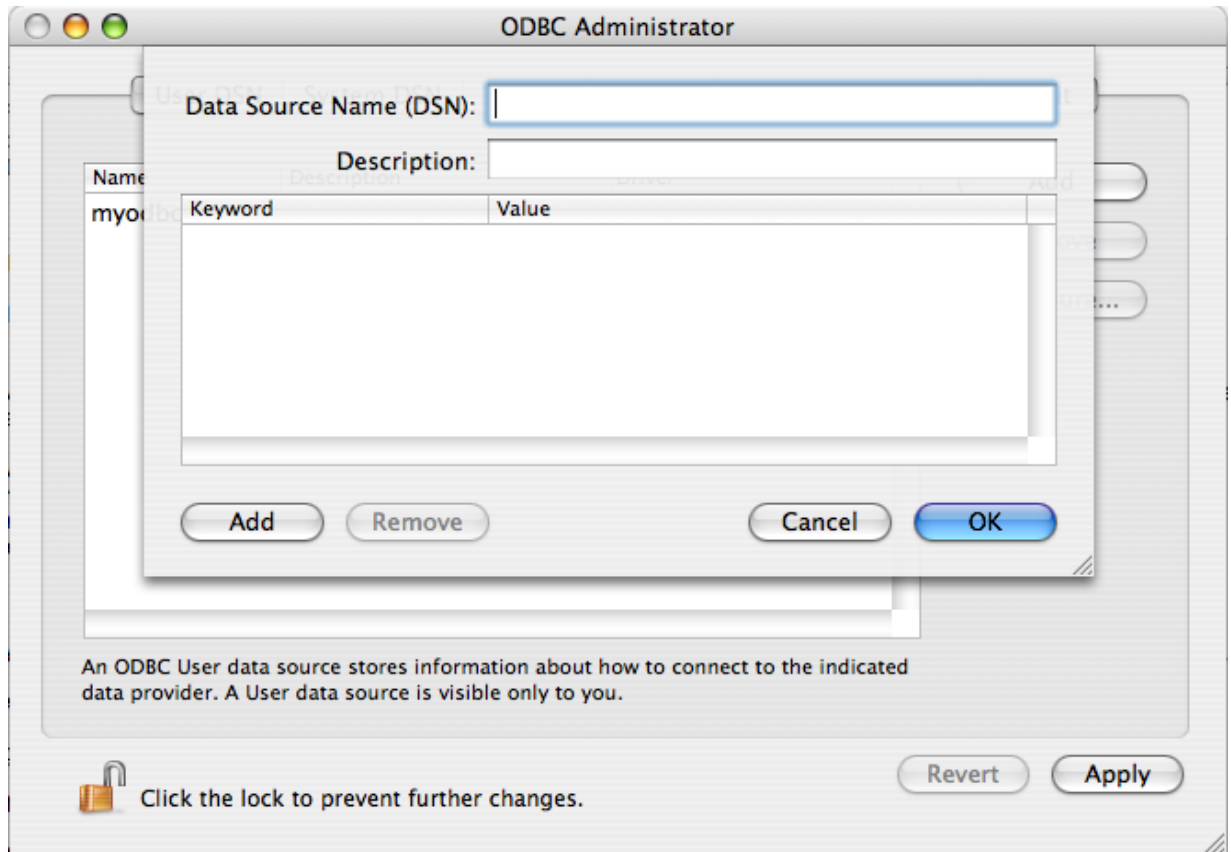
```
shell> myodbc3i -a -s -t "DSN=mydb;DRIVER=MySQL ODBC 3.51 Driver;SERVER=mysql;USER=username;PASSWORD=pass"
```

To use ODBC Administrator:

1. Open the ODBC Administrator from the `Utilities` folder in the `Applications` folder.

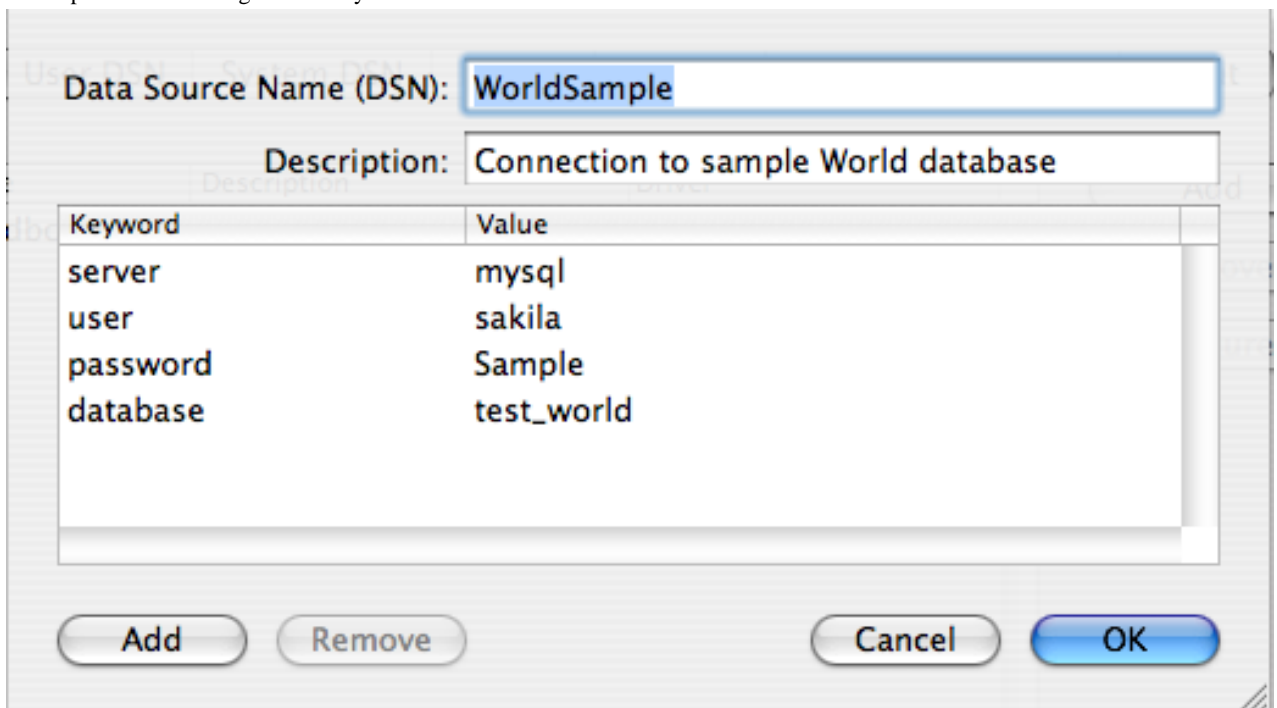


2. On the User DSN or System DSN panel, click ADD.
3. Select the Connector/ODBC driver and click OK.
4. You will be presented with the `Data Source Name` dialog. Enter The `Data Source Name` and an optional `Description` for the DSN.



5. Click ADD to add a new keyword/value pair to the panel. You should configure at least four pairs to specify the `server`, `username`, `password` and `database` connection parameters. See [Section 20.1.4.2, “Connector/ODBC Connection Parameters”](#).
6. Click OK to add the DSN to the list of configured data source names.

A completed DSN configuration may look like this:



You can configure additional ODBC options to your DSN by adding further keyword/value pairs and setting the corresponding values. See [Section 20.1.4.2, “Connector/ODBC Connection Parameters”](#).

### 20.1.4.5. Configuring a Connector/ODBC DSN on Unix

On [Unix](#), you configure DSN entries directly in the `odbc.ini` file. Here is a typical `odbc.ini` file that configures `myodbc3` as the DSN name for Connector/ODBC 3.51:

```
;
; odbc.ini configuration for Connector/ODBC and Connector/ODBC 3.51 drivers
;

[ODBC Data Sources]
myodbc3      = MyODBC 3.51 Driver DSN

[myodbc3]
Driver       = /usr/local/lib/libmyodbc3.so
Description  = Connector/ODBC 3.51 Driver DSN
SERVER      = localhost
PORT        =
USER        = root
Password     =
Database    = test
OPTION      = 3
SOCKET      =

[Default]
Driver       = /usr/local/lib/libmyodbc3.so
Description  = Connector/ODBC 3.51 Driver DSN
SERVER      = localhost
PORT        =
USER        = root
Password     =
Database    = test
OPTION      = 3
SOCKET      =
```

Refer to the [Section 20.1.4.2, “Connector/ODBC Connection Parameters”](#), for the list of connection parameters that can be supplied.

#### Note

If you are using `unixODBC`, you can use the following tools to set up the DSN:

- ODBCConfig GUI tool([HOWTO: ODBCConfig](#))
- `odbcinst`

In some cases when using `unixODBC`, you might get this error:

```
Data source name not found and no default driver specified
```

If this happens, make sure the `ODBCINI` and `ODBCSYSINI` environment variables are pointing to the right `odbc.ini` file. For example, if your `odbc.ini` file is located in `/usr/local/etc`, set the environment variables like this:

```
export ODBCINI=/usr/local/etc/odbc.ini
export ODBCSYSINI=/usr/local/etc
```

### 20.1.4.6. Connecting Without a Predefined DSN

You can connect to the MySQL server using `SQLDriverConnect`, by specifying the `DRIVER` name field. Here are the connection strings for Connector/ODBC using DSN-Less connections:

#### For Connector/ODBC 3.51:

```
ConnectionString = "DRIVER={MySQL ODBC 3.51 Driver};\
SERVER=localhost;\
DATABASE=test;\
USER=venu;\
PASSWORD=venu;\
OPTION=3;"
```

If your programming language converts backslash followed by whitespace to a space, it is preferable to specify the connection string as a single long string, or to use a concatenation of multiple strings that does not add spaces in between. For example:

```
ConnectionString = "DRIVER={MySQL ODBC 3.51 Driver};"
```



```
"SERVER=localhost;"  
"DATABASE=test;"  
"USER=venu;"  
"PASSWORD=venu;"  
"OPTION=3;"
```

**Note.** Note that on Mac OS X you may need to specify the full path to the Connector/ODBC driver library.

Refer to the [Section 20.1.4.2, “Connector/ODBC Connection Parameters”](#), for the list of connection parameters that can be supplied.

### 20.1.4.7. ODBC Connection Pooling

Connection pooling enables the ODBC driver to re-use existing connections to a given database from a pool of connections, instead of opening a new connection each time the database is accessed. By enabling connection pooling you can improve the overall performance of your application by lowering the time taken to open a connection to a database in the connection pool.

For more information about connection pooling: <http://support.microsoft.com/default.aspx?scid=kb;EN-US;q169470>.

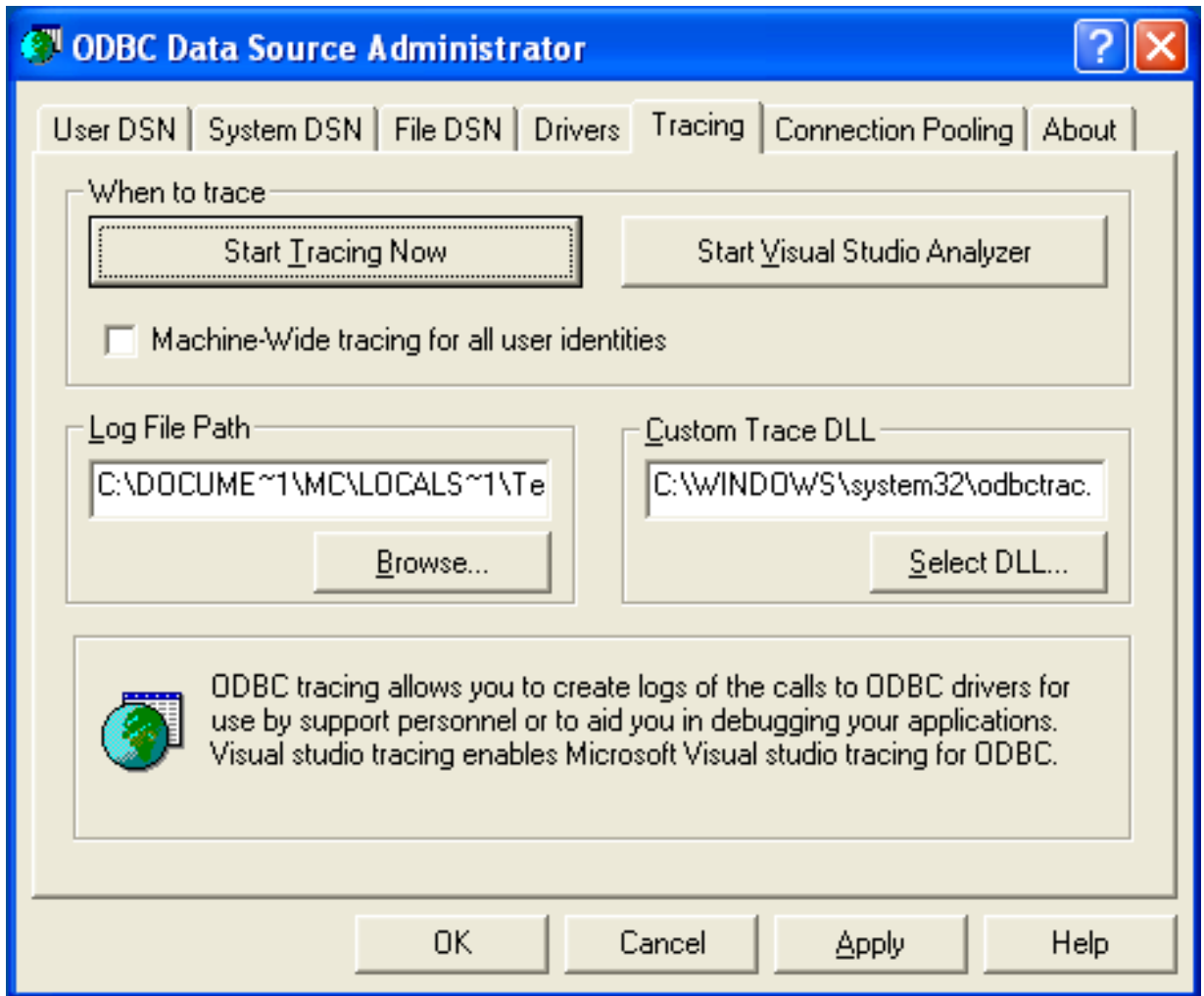
### 20.1.4.8. Getting an ODBC Trace File

If you encounter difficulties or problems with Connector/ODBC, you should start by making a log file from the [ODBC Manager](#) and Connector/ODBC. This is called *tracing*, and is enabled through the ODBC Manager. The procedure for this differs for Windows, Mac OS X and Unix.

#### 20.1.4.8.1. Enabling ODBC Tracing on Windows

To enable the trace option on Windows:

1. The [Tracing](#) tab of the ODBC Data Source Administrator dialog box enables you to configure the way ODBC function calls are traced.

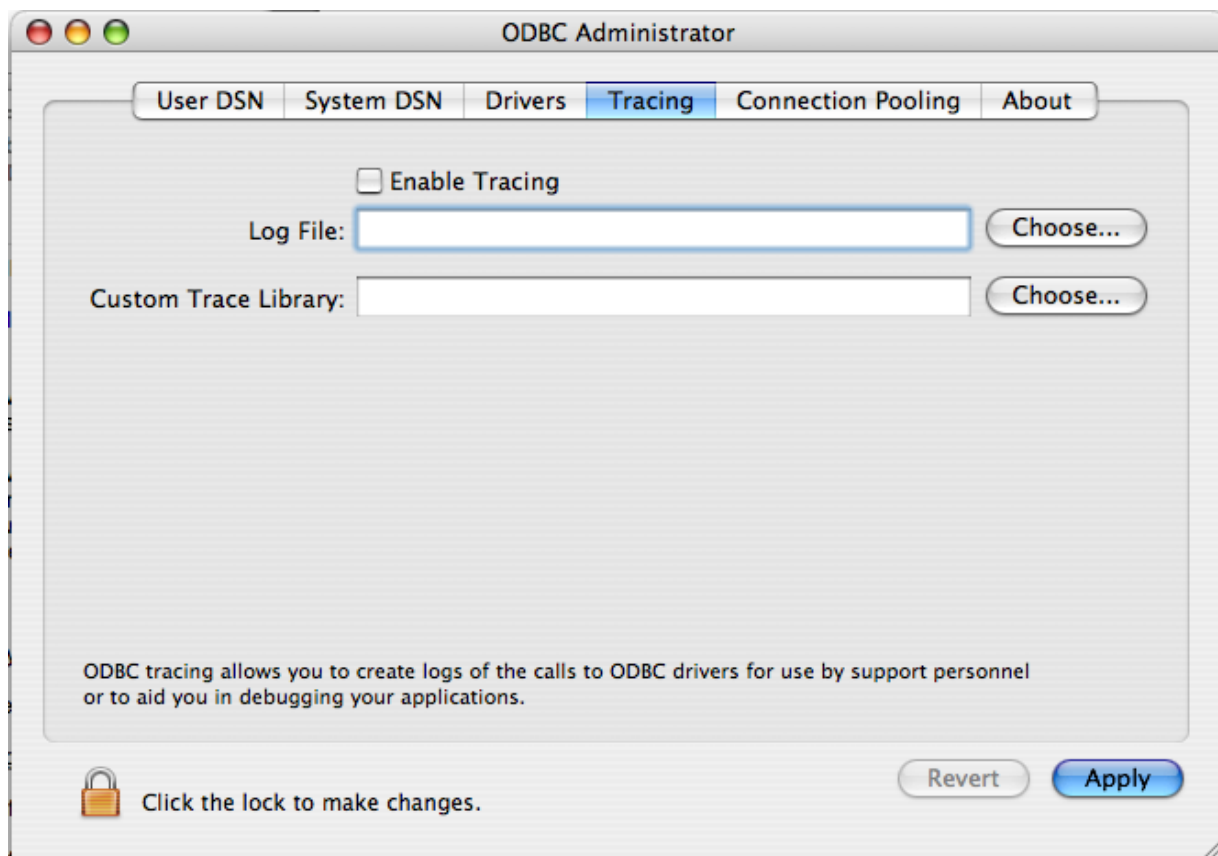


2. When you activate tracing from the [Tracing](#) tab, the [Driver Manager](#) logs all ODBC function calls for all subsequently run applications.
3. ODBC function calls from applications running before tracing is activated are not logged. ODBC function calls are recorded in a log file you specify.
4. Tracing ceases only after you click [Stop Tracing Now](#). Remember that while tracing is on, the log file continues to increase in size and that tracing affects the performance of all your ODBC applications.

#### 20.1.4.8.2. Enabling ODBC Tracing on Mac OS X

To enable the trace option on Mac OS X 10.3 or later you should use the [Tracing](#) tab within ODBC Administrator .

1. Open the ODBC Administrator.
2. Select the [Tracing](#) tab.



3. Select the `Enable Tracing` checkbox.
4. Enter the location where you want to save the Tracing log. If you want to append information to an existing log file, click the `CHOOSE...` button.

### 20.1.4.8.3. Enabling ODBC Tracing on Unix

To enable the trace option on Mac OS X 10.2 (or earlier) or Unix you must add the `trace` option to the ODBC configuration:

1. On Unix, you need to explicitly set the `Trace` option in the `ODBC.INI` file.

Set the tracing `ON` or `OFF` by using `TraceFile` and `Trace` parameters in `odbc.ini` as shown below:

```
TraceFile = /tmp/odbc.trace
Trace     = 1
```

`TraceFile` specifies the name and full path of the trace file and `Trace` is set to `ON` or `OFF`. You can also use `1` or `YES` for `ON` and `0` or `NO` for `OFF`. If you are using `ODBCConfig` from `unixODBC`, then follow the instructions for tracing `unixODBC` calls at [HOWTO-ODBCConfig](#).

### 20.1.4.8.4. Enabling a Connector/ODBC Log

To generate a Connector/ODBC log, do the following:

1. Within Windows, enable the `Trace Connector/ODBC` option flag in the Connector/ODBC connect/configure screen. The log is written to file `C:\myodbc.log`. If the trace option is not remembered when you are going back to the above screen, it means that you are not using the `myodbcd.dll` driver, see [Section 20.1.4.3.3, "Errors and Debugging"](#).

On Mac OS X, Unix, or if you are using DSN-Less connection, then you need to supply `OPTION=4` in the connection string or set the corresponding keyword/value pair in the DSN.

2. Start your application and try to get it to fail. Then check the Connector/ODBC trace file to find out what could be wrong.

If you need help determining what is wrong, see [Section 20.1.8.1, “Connector/ODBC Community Support”](#).

## 20.1.5. Connector/ODBC Examples

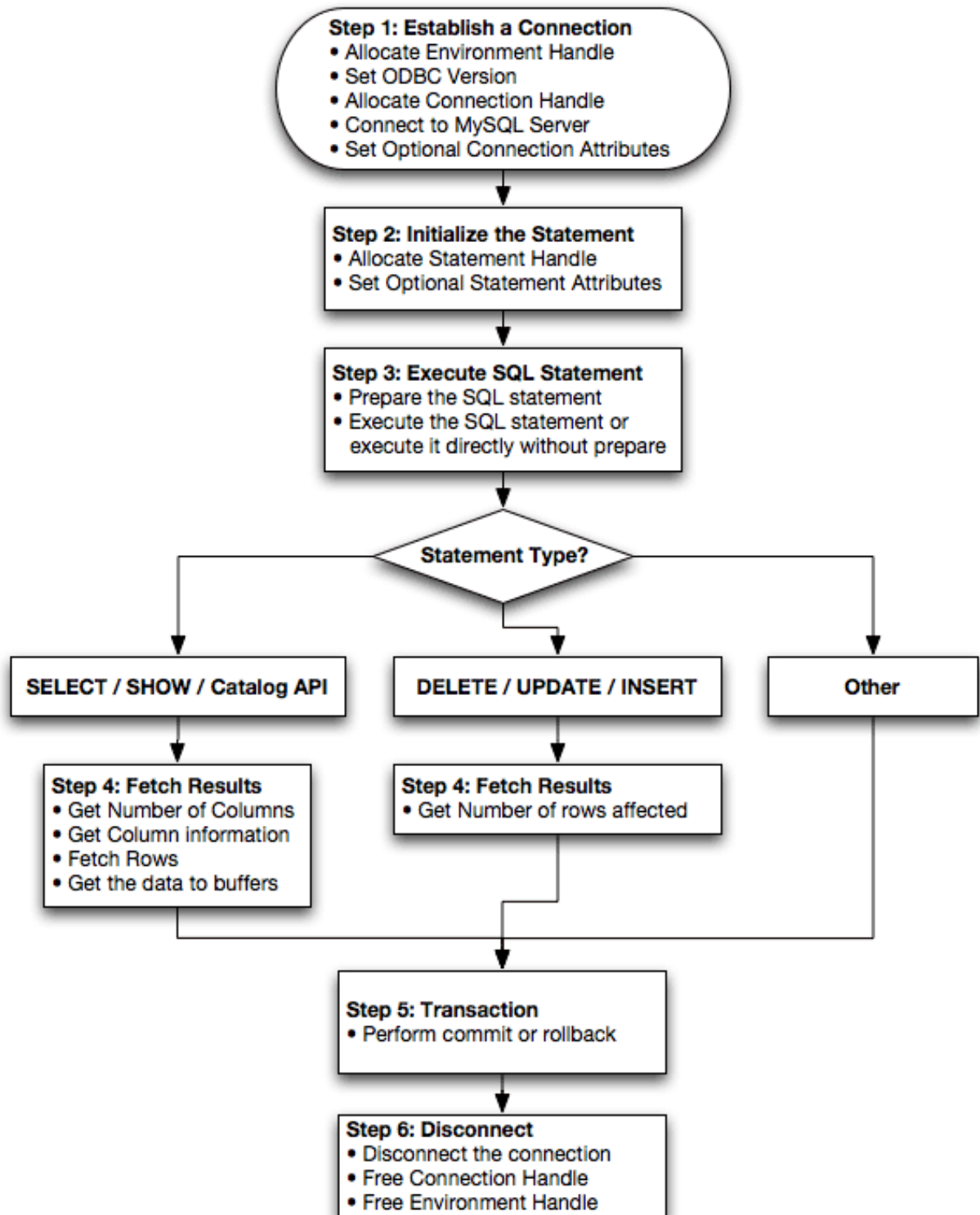
Once you have configured a DSN to provide access to a database, how you access and use that connection is dependent on the application or programming language. As ODBC is a standardized interface, any application or language that supports ODBC can use the DSN and connect to the configured database.

### 20.1.5.1. Basic Connector/ODBC Application Steps

Interacting with a MySQL server from an applications using the Connector/ODBC typically involves the following operations:

- Configure the Connector/ODBC DSN
- Connect to MySQL server
- Initialization operations
- Execute SQL statements
- Retrieve results
- Perform Transactions
- Disconnect from the server

Most applications use some variation of these steps. The basic application steps are shown in the following diagram:



### 20.1.5.2. Step-by-step Guide to Connecting to a MySQL Database through Connector/ODBC

A typical installation situation where you would install Connector/ODBC is when you want to access a database on a Linux or Unix host from a Windows machine.

As an example of the process required to set up access between two machines, the steps below take you through the basic steps. These instructions assume that you want to connect to system ALPHA from system BETA with a user name and password of `my-user` and `mypassword`.

On system ALPHA (the MySQL server) follow these steps:

1. Start the MySQL server.
2. Use `GRANT` to set up an account with a user name of `myuser` that can connect from system BETA using a password of `my-user` to the database `test`:

```
GRANT ALL ON test.* to 'myuser'@'BETA' IDENTIFIED BY 'mypassword';
```

For more information about MySQL privileges, refer to [Section 5.5, “MySQL User Account Management”](#).

On system BETA (the Connector/ODBC client), follow these steps:

1. Configure a Connector/ODBC DSN using parameters that match the server, database and authentication information that you have just configured on system ALPHA.

Parameter	Value	Comment
DSN	remote_test	A name to identify the connection.
SERVER	ALPHA	The address of the remote server.
DATABASE	test	The name of the default database.
USER	myuser	The user name configured for access to this database.
PASSWORD	mypassword	The password for <code>myuser</code> .

2. Using an ODBC-capable application, such as Microsoft Office, connect to the MySQL server using the DSN you have just created. If the connection fails, use tracing to examine the connection process. See [Section 20.1.4.8, “Getting an ODBC Trace File”](#), for more information.

### 20.1.5.3. Connector/ODBC and Third-Party ODBC Tools

Once you have configured your Connector/ODBC DSN, you can access your MySQL database through any application that supports the ODBC interface, including programming languages and third-party applications. This section contains guides and help on using Connector/ODBC with various ODBC-compatible tools and applications, including Microsoft Word, Microsoft Excel and Adobe/Macromedia ColdFusion.

Connector/ODBC has been tested with the following applications.

Publisher	Application	Notes
Adobe	ColdFusion	Formerly Macromedia ColdFusion
Borland	C++ Builder	
	Builder 4	
	Delphi	
Business Objects	Crystal Reports	
Claris	Filemaker Pro	
Corel	Paradox	
Computer Associates	Visual Objects	Also known as CAVO
	AllFusion ERwin Data Modeler	
Gupta	Team Developer	Previously known as Centura Team Developer; Gupta SQL/Windows
Gensym	G2-ODBC Bridge	
Inline	iHTML	
Lotus	Notes	Versions 4.5 and 4.6
Microsoft	Access	
	Excel	
	Visio Enterprise	
	Visual C++	
	Visual Basic	

	ODBC.NET	Using C#, Visual Basic, C++
	FoxPro	
	Visual Interdev	
OpenOffice.org	OpenOffice.org	
Perl	DBD::ODBC	
Pervasive Software	DataJunction	
Sambar Technologies	Sambar Server	
SPSS	SPSS	
SoftVelocity	Clarion	
SQLExpress	SQLExpress for Xbase++	
Sun	StarOffice	
SunSystems	Vision	
Sybase	PowerBuilder	
	PowerDesigner	
theKompany.com	Data Architect	

If you know of any other applications that work with Connector/ODBC, please send mail to [<myodbc@lists.mysql.com>](mailto:myodbc@lists.mysql.com) about them.

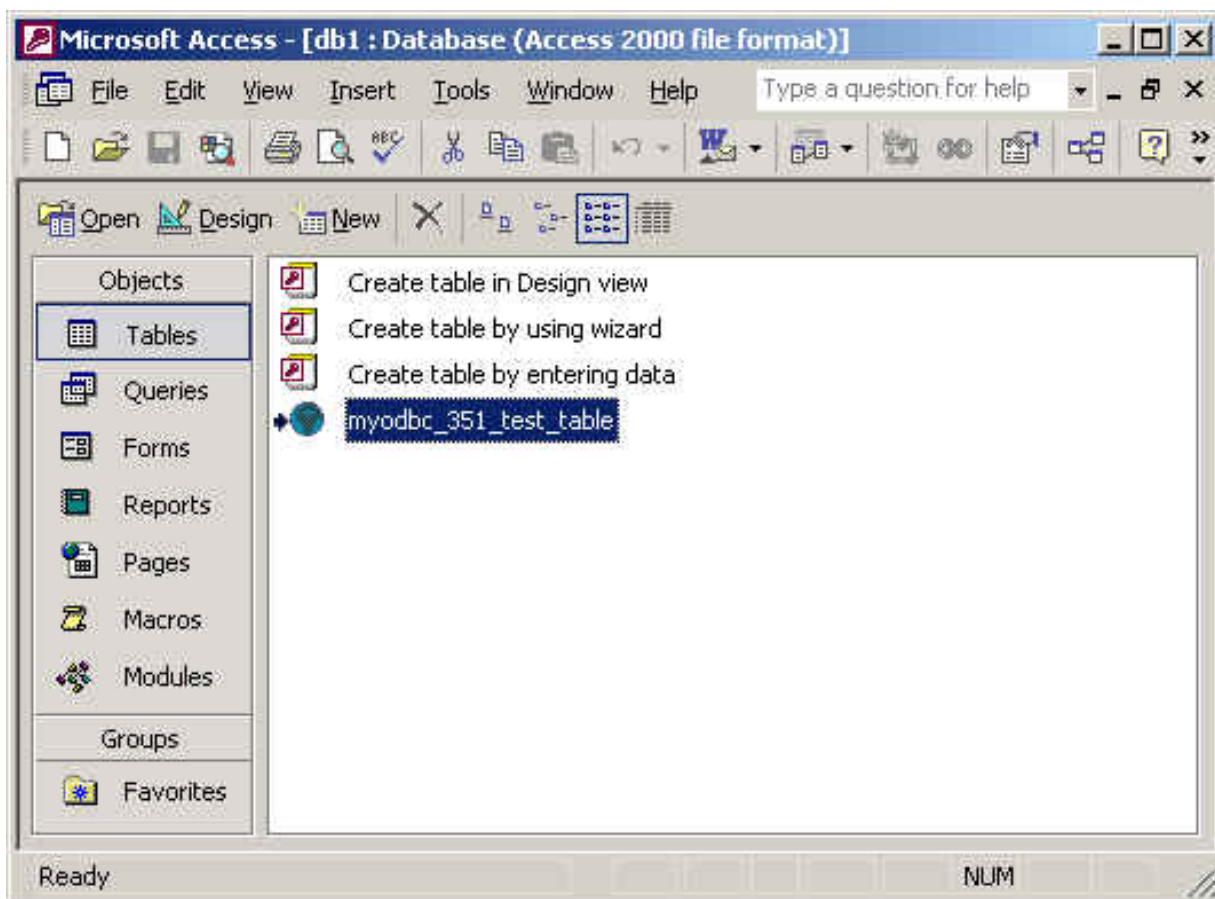
#### 20.1.5.4. Using Connector/ODBC with Microsoft Access

You can use MySQL database with Microsoft Access using Connector/ODBC. The MySQL database can be used as an import source, an export source, or as a linked table for direct use within an Access application, so you can use Access as the front-end interface to a MySQL database.

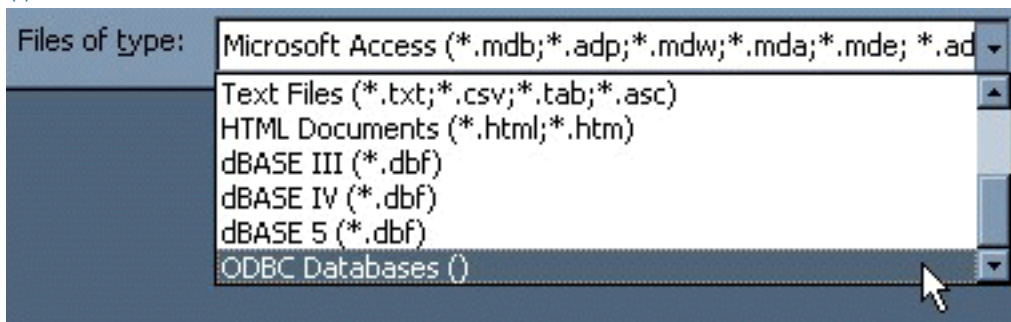
##### 20.1.5.4.1. Exporting Access Data to MySQL

To export a table of data from an Access database to MySQL, follow these instructions:

1. When you open an Access database or an Access project, a Database window appears. It displays shortcuts for creating new database objects and opening existing objects.



2. Click the name of the [table](#) or [query](#) you want to export, and then in the **File** menu, select **Export**.
3. In the **Export Object Type Object name To** dialog box, in the **Save As Type** box, select **ODBC Databases ()** as shown here:



4. In the **Export** dialog box, enter a name for the file (or use the suggested name), and then select **OK**.
5. The **Select Data Source** dialog box is displayed; it lists the defined data sources for any ODBC drivers installed on your computer. Click either the **File Data Source** or **Machine Data Source** tab, and then double-click the **Connector/ODBC** or **Connector/ODBC 3.51** data source that you want to export to. To define a new data source for **Connector/ODBC**, please [Section 20.1.4.3, "Configuring a Connector/ODBC DSN on Windows"](#).

#### Note

Ensure that the information that you are exporting to the MySQL table is valid for the corresponding MySQL data types. Values that are outside of the supported range of the MySQL data type but valid within Access may trigger an "overflow" error during the export.

Microsoft Access connects to the MySQL Server through this data source and exports new tables and or data.

#### 20.1.5.4.2. Importing MySQL Data to Access



To import a table or tables from MySQL to Access, follow these instructions:

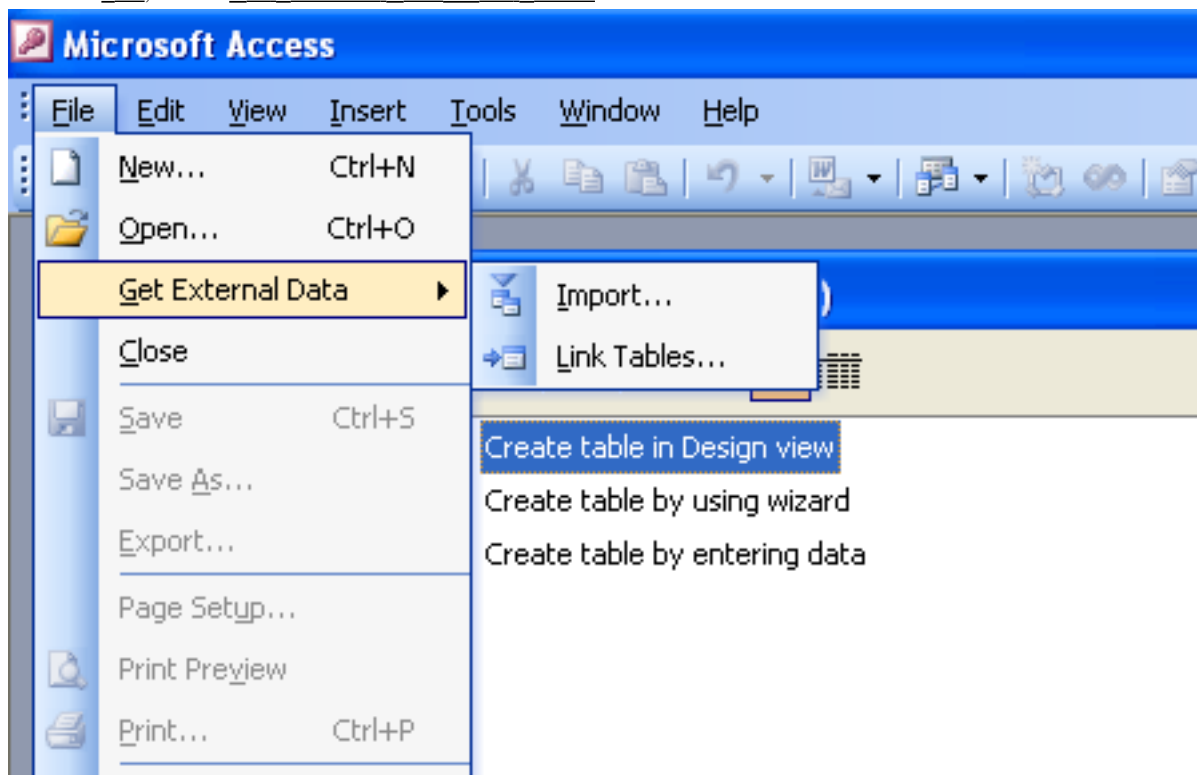
1. Open a database, or switch to the Database window for the open database.
2. To import tables, on the **File** menu, point to **Get External Data**, and then click **Import**.
3. In the **Import** dialog box, in the Files Of Type box, select **ODBC DATABASES ()**. The Select Data Source dialog box lists the defined data sources **THE SELECT DATA SOURCE** dialog box is displayed; it lists the defined data source names.
4. If the ODBC data source that you selected requires you to log on, enter your login ID and password (additional information might also be required), and then click **OK**.
5. Microsoft Access connects to the MySQL server through **ODBC data source** and displays the list of tables that you can **import**.
6. Click each table that you want to **import**, and then click **OK**.

### 20.1.5.4.3. Using Microsoft Access as a Front-end to MySQL

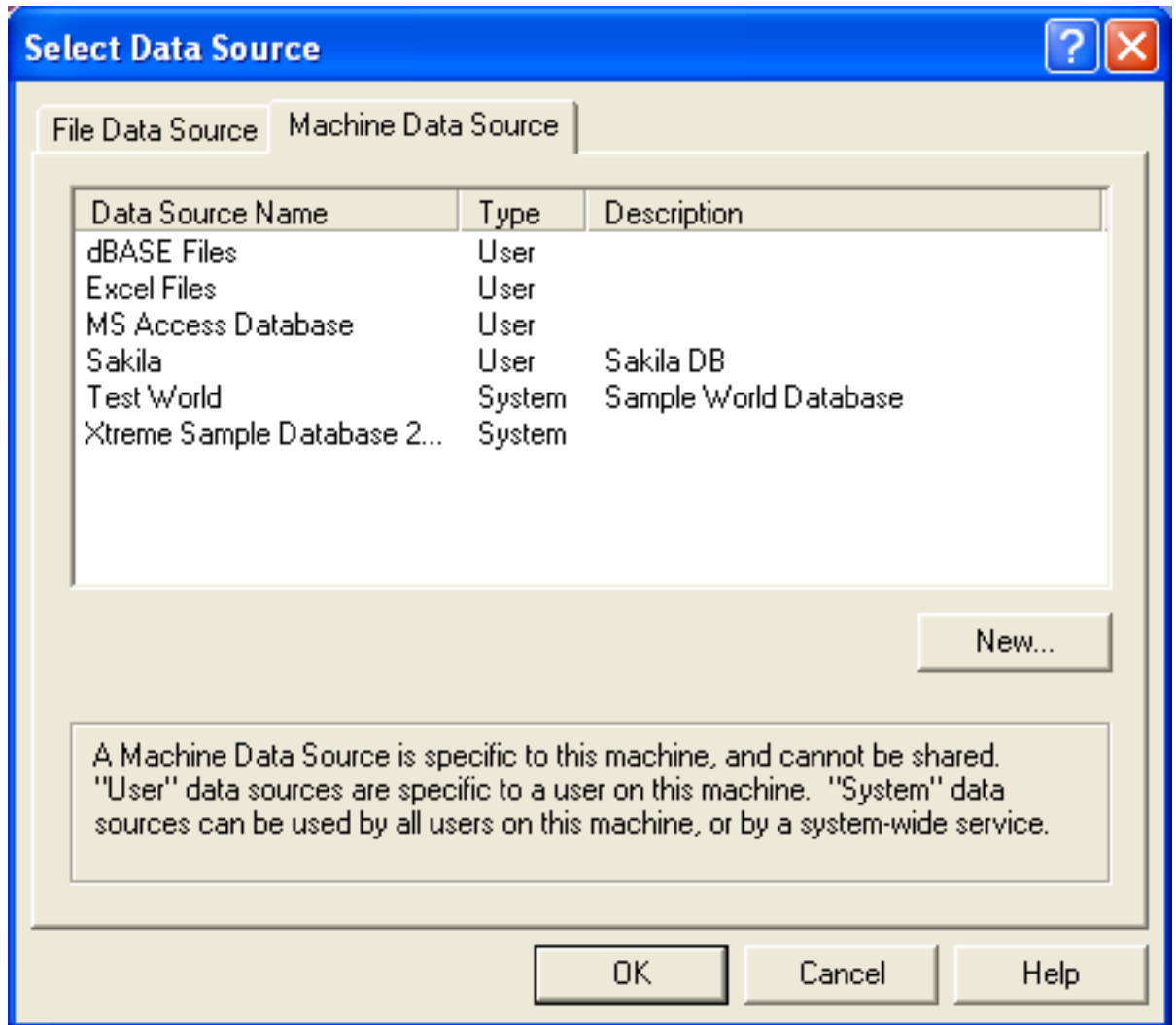
You can use Microsoft Access as a front end to a MySQL database by linking tables within your Microsoft Access database to tables that exist within your MySQL database. When a query is requested on a table within Access, ODBC is used to execute the queries on the MySQL database instead.

**To create a linked table:**

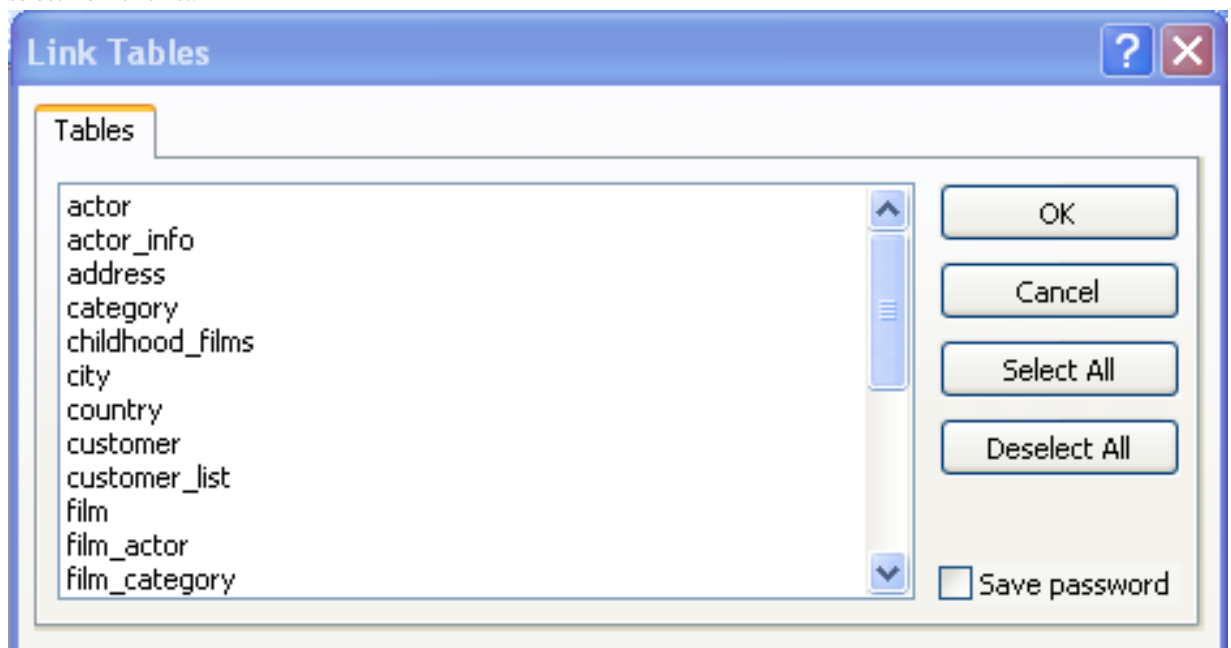
1. Open the Access database that you want to link to MySQL.
2. From the **FILE**, choose **GET EXTERNAL DATA->LINK TABLES**.



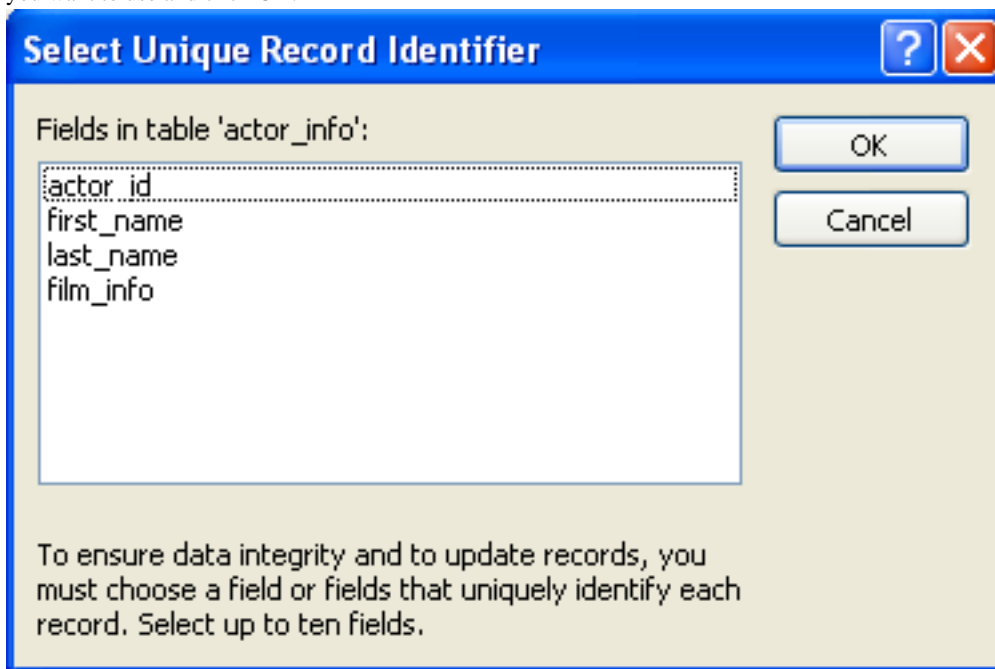
3. From the browser, choose **ODBC DATABASES ()** from the **FILES OF TYPE** pop-up.
4. In the **SELECT DATA SOURCE** window, choose an existing DSN, either from a **FILE DATA SOURCE** or **MACHINE DATA SOURCE**. You can also create a new DSN using the **NEW...** button. For more information on creating a DSN see [Section 20.1.4.3, "Configuring a Connector/ODBC DSN on Windows"](#).



5. In the **LINK TABLES** dialog, select one or more tables from the MySQL database. A link will be created to each table that you select from this list.



- If Microsoft Access is unable to determine the unique record identifier for a table automatically then it may ask you to confirm the column, or combination of columns, to be used to uniquely identify each row from the source table. Select the columns you want to use and click OK.



Once the process has been completed, you can now build interfaces and queries to the linked tables just as you would for any Access database.

Use the following procedure to view or to refresh links when the structure or location of a linked table has changed. The Linked Table Manager lists the paths to all currently linked tables.

**To view or refresh links:**

- Open the database that contains links to MySQL tables.
- On the **Tools** menu, point to **Add-ins (Database Utilities)** in Access 2000 or newer, and then click **Linked Table Manager**.
- Select the check box for the tables whose links you want to refresh.
- Click OK to refresh the links.

Microsoft Access confirms a successful refresh or, if the table wasn't found, displays the **Select New Location of <table name>** dialog box in which you can specify its the table's new location. If several selected tables have moved to the new location that you specify, the Linked Table Manager searches that location for all selected tables, and updates all links in one step.

**To change the path for a set of linked tables:**

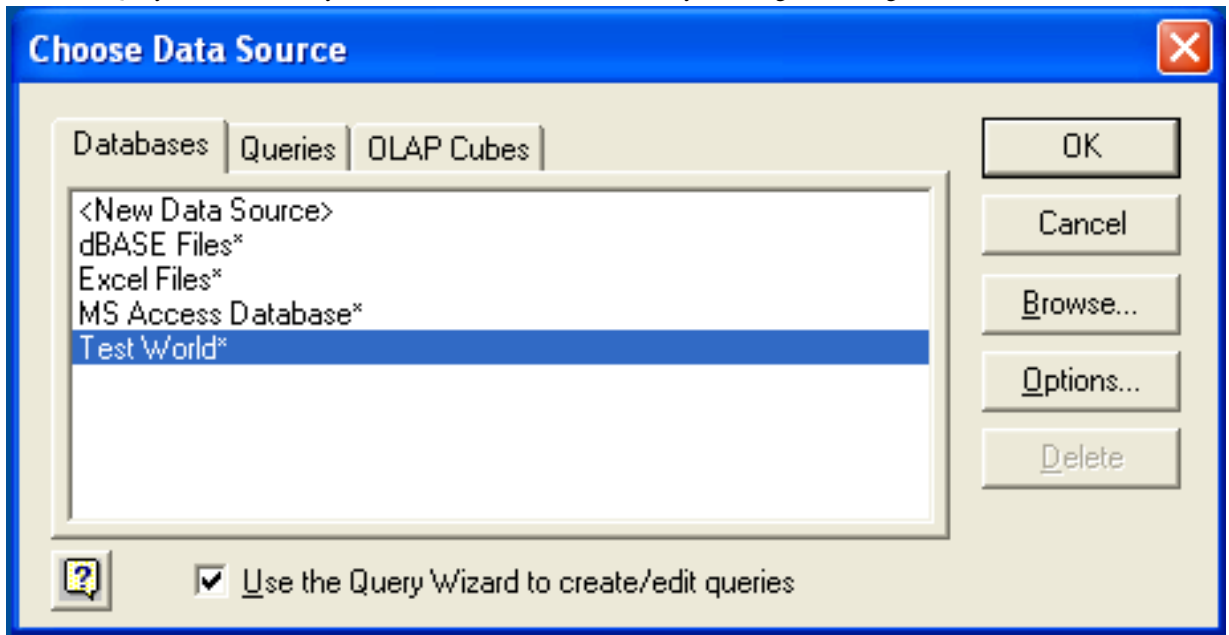
- Open the database that contains links to tables.
- On the **Tools** menu, point to **Add-ins (Database Utilities)** in Access 2000 or newer, and then click **Linked Table Manager**.
- Select the **Always Prompt For A New Location** check box.
- Select the check box for the tables whose links you want to change, and then click **OK**.
- In the **Select New Location of <table name>** dialog box, specify the new location, click **Open**, and then click **OK**.

### 20.1.5.5. Using Connector/ODBC with Microsoft Word or Excel

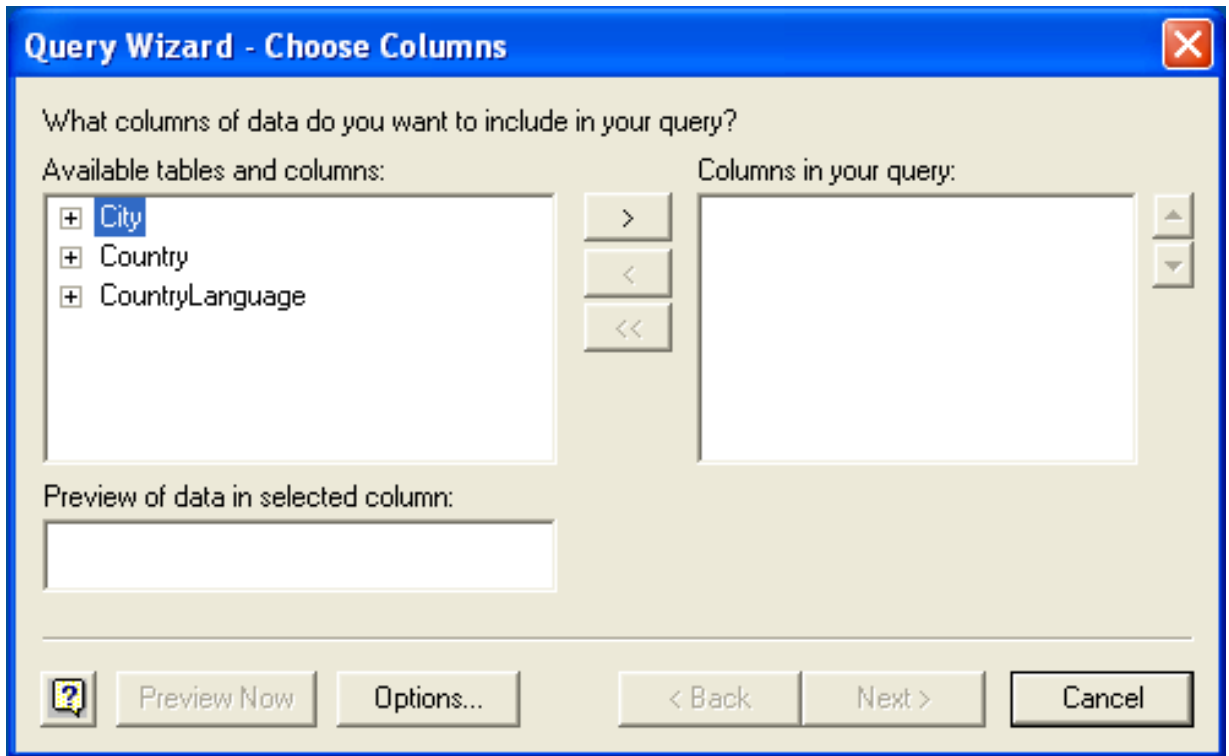
You can use Microsoft Word and Microsoft Excel to access information from a MySQL database using Connector/ODBC. Within Microsoft Word, this facility is most useful when importing data for mailmerge, or for tables and data to be included in reports. Within Microsoft Excel, you can execute queries on your MySQL server and import the data directly into an Excel Worksheet, presenting the data as a series of rows and columns.

With both applications, data is accessed and imported into the application using Microsoft Query, which enables you to execute a query through an ODBC source. You use Microsoft Query to build the SQL statement to be executed, selecting the tables, fields, selection criteria and sort order. For example, to insert information from a table in the World test database into an Excel spreadsheet, using the DSN samples shown in [Section 20.1.4, "Connector/ODBC Configuration"](#):

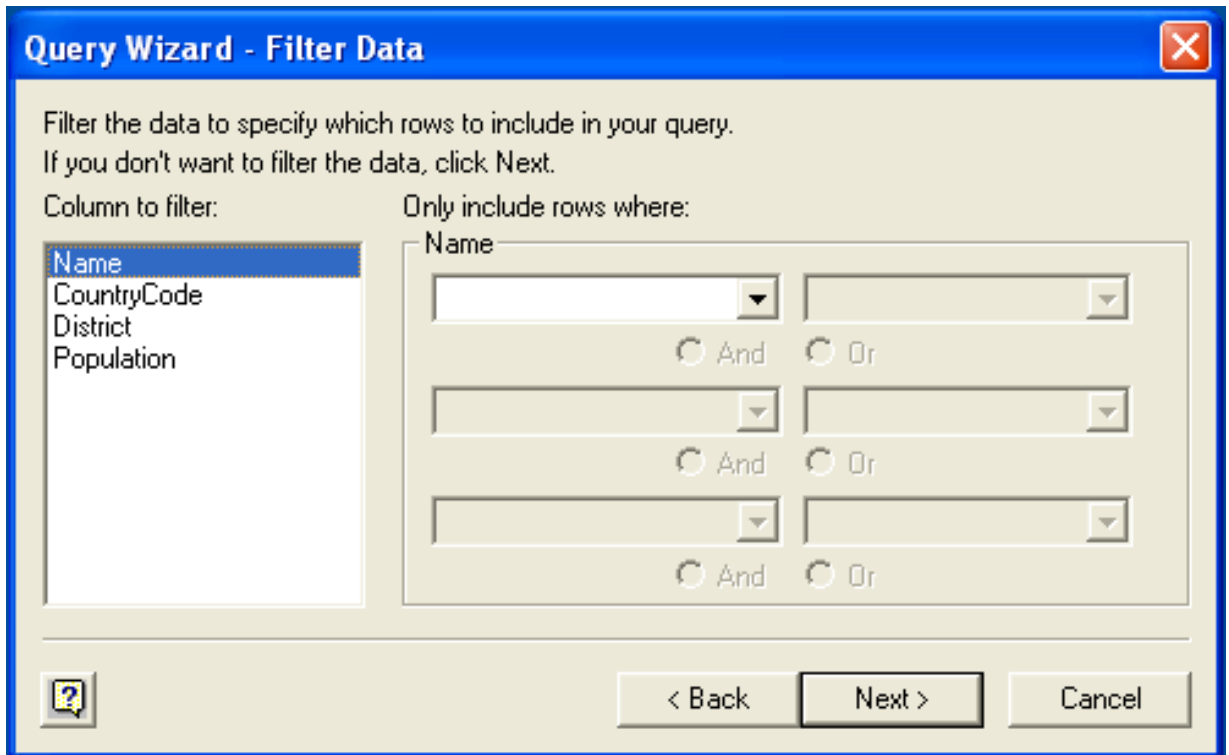
1. Create a new Worksheet.
2. From the **Data** menu, choose **Import External Data**, and then select **New Database Query**.
3. Microsoft Query will start. First, you need to choose the data source, by selecting an existing Data Source Name.



4. Within the **Query Wizard**, you must choose the columns that you want to import. The list of tables available to the user configured through the DSN is shown on the left, the columns that will be added to your query are shown on the right. The columns you choose are equivalent to those in the first section of a **SELECT** query. Click **NEXT** to continue.



5. You can filter rows from the query (the equivalent of a `WHERE` clause) using the `Filter Data` dialog. Click `NEXT` to continue.



6. Select an (optional) sort order for the data. This is equivalent to using a `ORDER BY` clause in your SQL query. You can select up to three fields for sorting the information returned by the query. Click `NEXT` to continue.

**Query Wizard - Sort Order**

Specify how you want your data sorted.  
If you don't want to sort the data, click Next.

Sort by  
Name  Ascending  Descending

Then by  Ascending  Descending

Then by  Ascending  Descending

7. Select the destination for your query. You can select to return the data Microsoft Excel, where you can choose a worksheet and cell where the data will be inserted; you can continue to view the query and results within Microsoft Query, where you can edit the SQL query and further filter and sort the information returned; or you can create an OLAP Cube from the query, which can then be used directly within Microsoft Excel. Click FINISH.

**Query Wizard - Finish**

What would you like to do next?

Return Data to Microsoft Office Excel

View data or edit query in Microsoft Query

Create an OLAP Cube from this query

The same process can be used to import data into a Word document, where the data will be inserted as a table. This can be used for mail merge purposes (where the field data is read from a Word table), or where you want to include data and reports within a report or other document.

### 20.1.5.6. Using Connector/ODBC with Crystal Reports

Crystal Reports can use an ODBC DSN to connect to a database from which you to extract data and information for reporting purposes.

### Note

There is a known issue with certain versions of Crystal Reports where the application is unable to open and browse tables and fields through an ODBC connection. Before using Crystal Reports with MySQL, please ensure that you have update to the latest version, including any outstanding service packs and hotfixes. For more information on this issue, see the [Business\) Objects Knowledgebase](#) for more information.

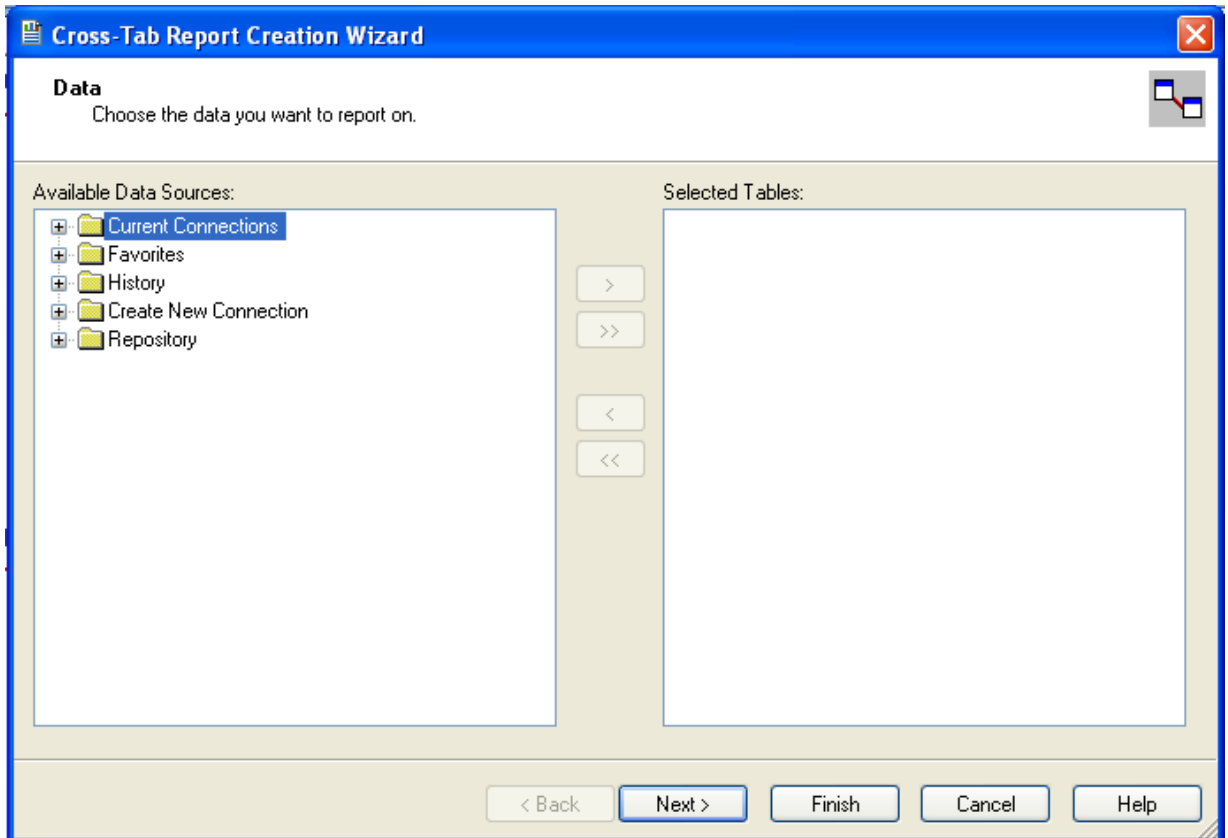
For example, to create a simple crosstab report within Crystal Reports XI, you should follow these steps:

1. Create a DSN using the [Data Sources \(ODBC\)](#) tool. You can either specify a complete database, including user name and password, or you can build a basic DSN and use Crystal Reports to set the user name and password.

For the purposes of this example, a DSN that provides a connection to an instance of the MySQL Sakila sample database has been created.

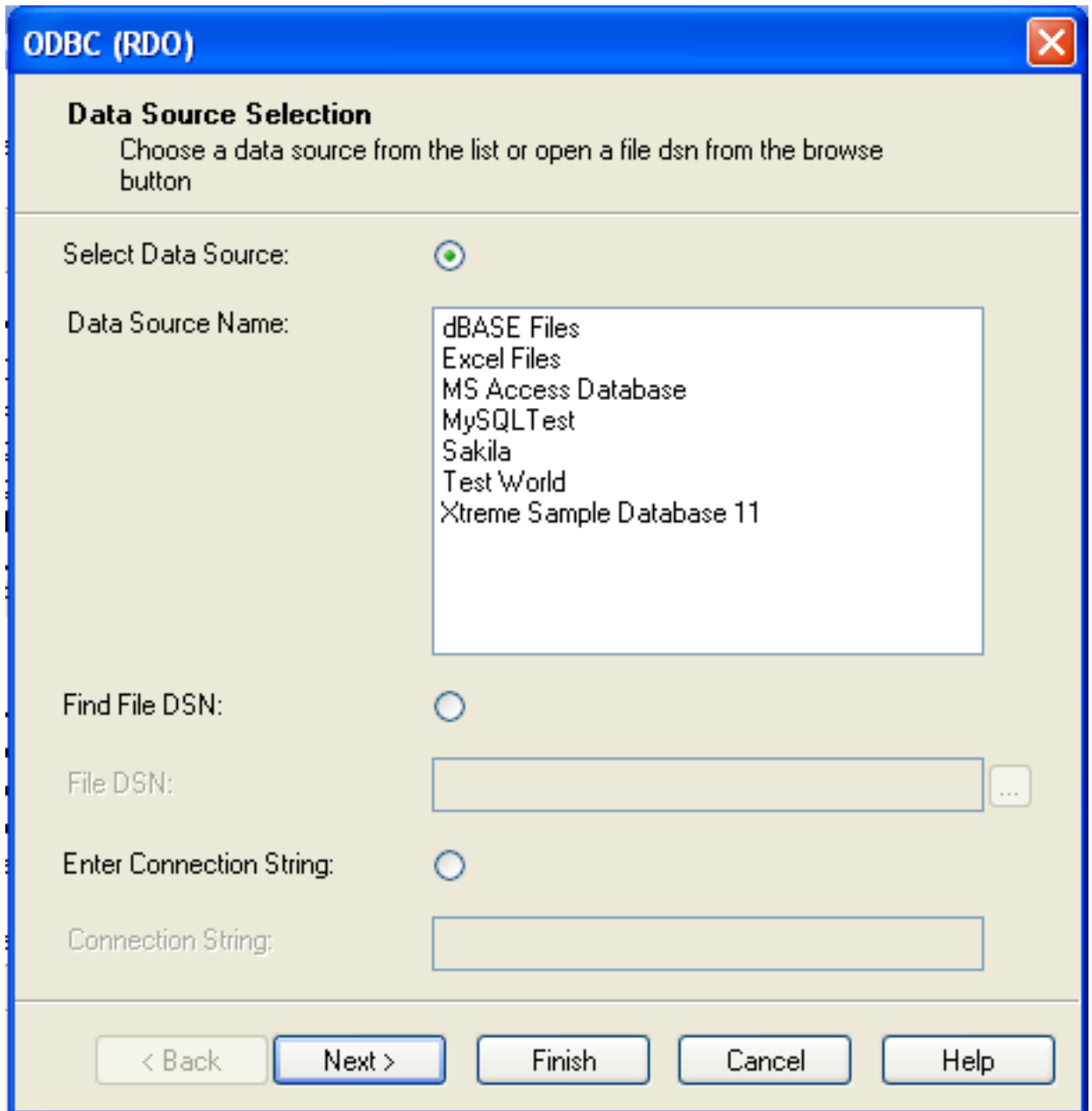
2. Open Crystal Reports and create a new project, or an open an existing reporting project into which you want to insert data from your MySQL data source.
3. Start the Cross-Tab Report Wizard, either by clicking on the option on the Start Page. Expand the **CREATE NEW CONNECTION** folder, then expand the **ODBC (RDO)** folder to obtain a list of ODBC data sources.

You will be asked to select a data source.



4. When you first expand the **ODBC (RDO)** folder you will be presented the Data Source Selection screen. From here you can select either a pre-configured DSN, open a file-based DSN or enter and manual connection string. For this example, the **SAKILA** DSN will be used.

If the DSN contains a user name/password combination, or you want to use different authentication credentials, click **NEXT** to enter the user name and password that you want to use. Otherwise, click **FINISH** to continue the data source selection wizard.

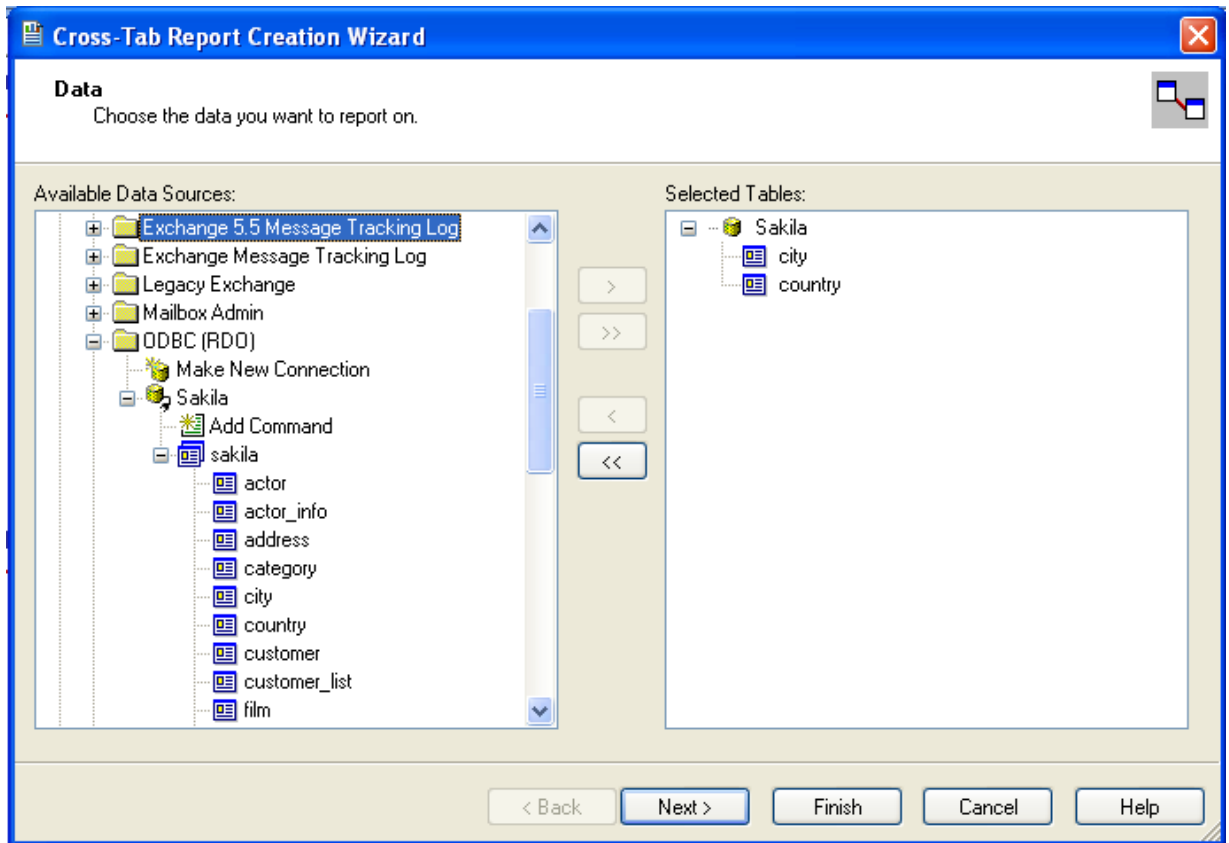


5. You will be returned the Cross-Tab Report Creation Wizard. You now need to select the database and tables that you want to include in your report. For our example, we will expand the selected Sakila database. Click the `city` table and use the `>` button to add the table to the report. Then repeat the action with the `country` table. Alternatively you can select multiple tables and add them to the report.

Finally, you can select the parent **SAKILA** resource and add of the tables to the report.

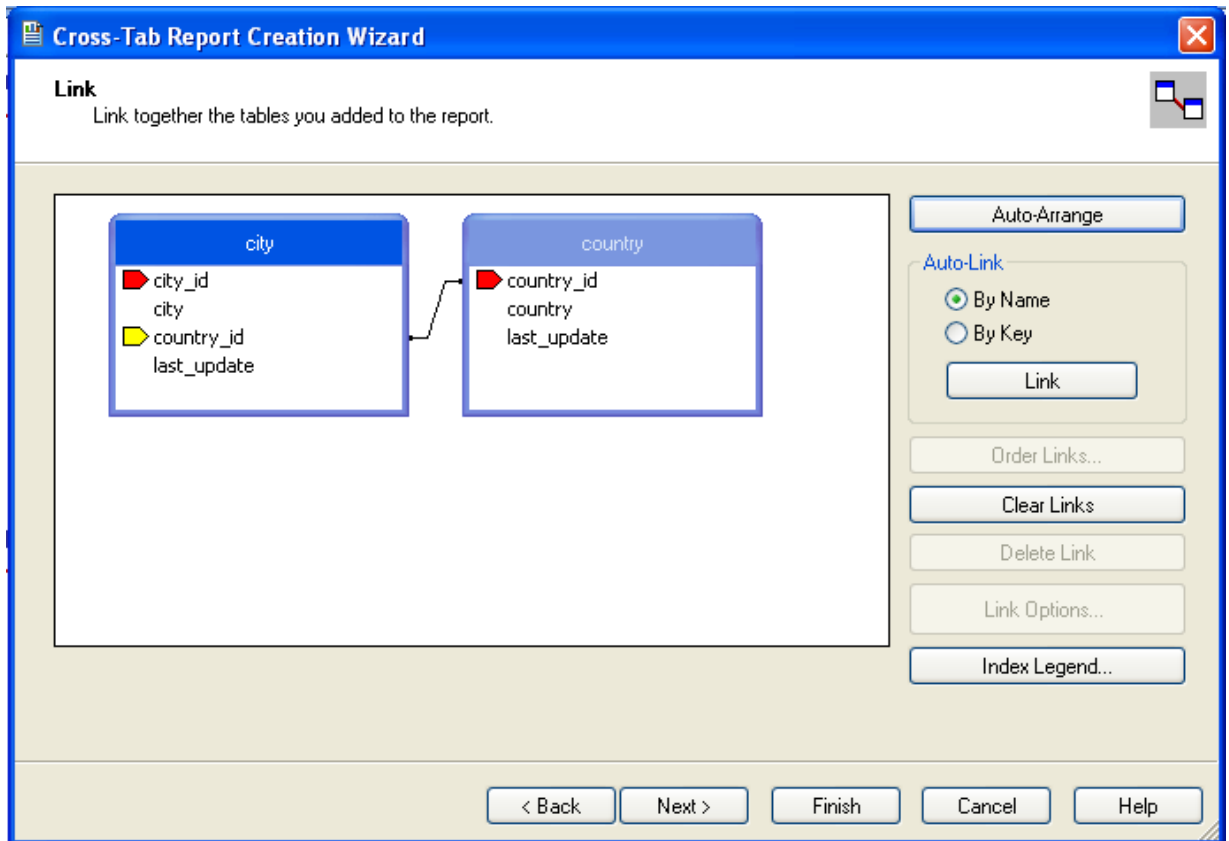
Once you have selected the tables you want to include, click **NEXT** to continue.





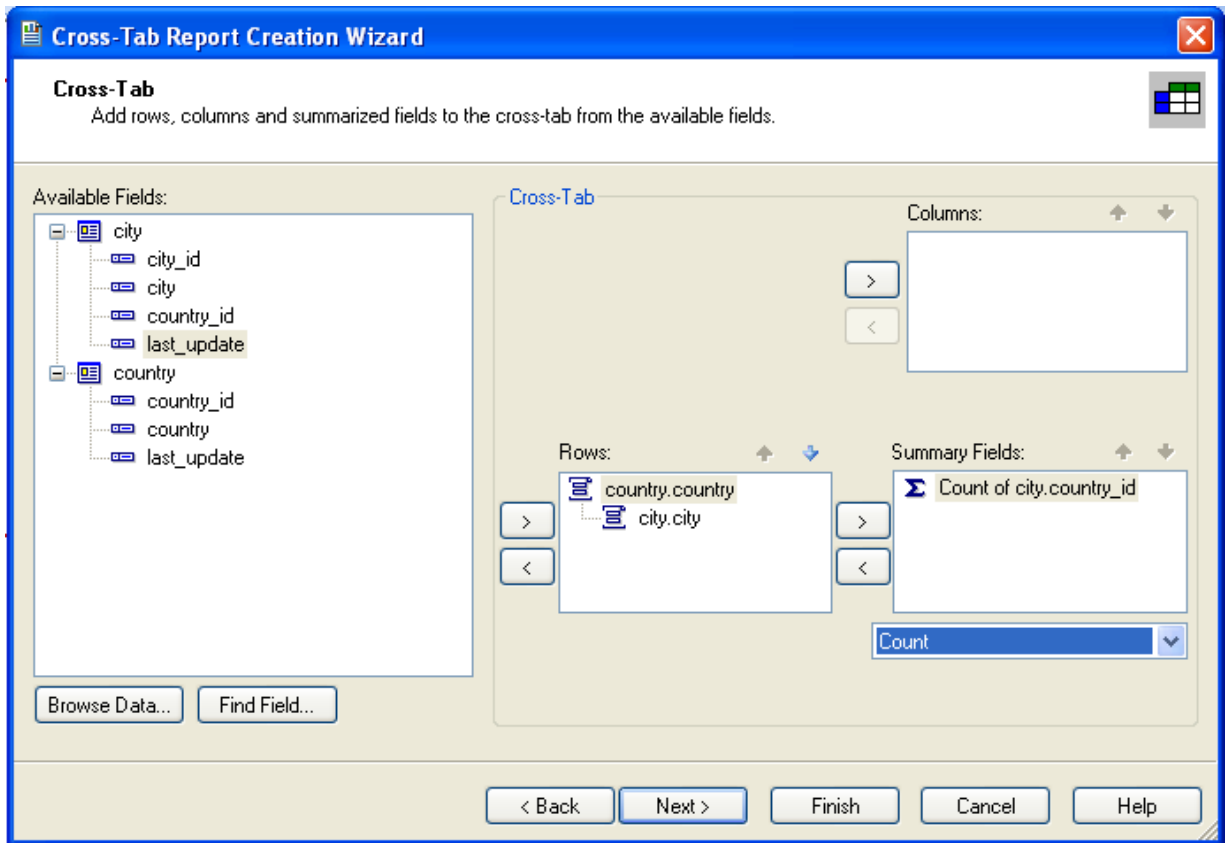
6. Crystal Reports will now read the table definitions and automatically identify the links between the tables. The identification of links between tables enables Crystal Reports to automatically lookup and summarize information based on all the tables in the database according to your query. If Crystal Reports is unable to perform the linking itself, you can manually create the links between fields in the tables you have selected.

Click NEXT to continue the process.



7. You can now select the columns and rows that you wish to include within the Cross-Tab report. Drag and drop or use the > buttons to add fields to each area of the report. In the example shown, we will report on cities, organized by country, incorporating a count of the number of cities within each country. If you want to browse the data, select a field and click the BROWSE DATA... button.

Click NEXT to create a graph of the results. Since we are not creating a graph from this data, click FINISH to generate the report.



8. The finished report will be shown, a sample of the output from the Sakila sample database is shown below.

		<b>Total</b>
<b>Total</b>		600
<b>Afghanistan</b>	<b>Total</b>	1
	<b>Kabul</b>	1
<b>Algeria</b>	<b>Total</b>	3
	<b>Batna</b>	1
	<b>Bchar</b>	1
	<b>Skikda</b>	1
<b>American Samoa</b>	<b>Total</b>	1
	<b>Tafuna</b>	1
<b>Angola</b>	<b>Total</b>	2
	<b>Benguela</b>	1
	<b>Namibe</b>	1
<b>Anguilla</b>	<b>Total</b>	1
	<b>South Hill</b>	1
<b>Argentina</b>	<b>Total</b>	13
	<b>Almirante Brow</b>	1

Once the ODBC connection has been opened within Crystal Reports, you can browse and add any fields within the available tables into your reports.

### 20.1.5.7. Connector/ODBC Programming

With a suitable ODBC Manager and the Connector/ODBC driver installed, any programming language or environment that can support ODBC should be able to connect to a MySQL database through Connector/ODBC.

This includes, but is certainly not limited to, Microsoft support languages (including Visual Basic, C# and interfaces such as ODBC.NET), Perl (through the DBI module, and the DBD::ODBC driver).

#### 20.1.5.7.1. Using Connector/ODBC with Visual Basic Using ADO, DAO and RDO

This section contains simple examples of the use of MySQL ODBC 3.51 Driver with ADO, DAO and RDO.

### 20.1.5.7.1.1. ADO: `rs.addNew`, `rs.delete`, and `rs.update`

The following ADO (ActiveX Data Objects) example creates a table `my_ado` and demonstrates the use of `rs.addNew`, `rs.delete`, and `rs.update`.

```
Private Sub myodbc_ado_Click()

Dim conn As ADODB.Connection
Dim rs As ADODB.Recordset
Dim fld As ADODB.Field
Dim sql As String

'connect to MySQL server using MySQL ODBC 3.51 Driver
Set conn = New ADODB.Connection
conn.ConnectionString = "DRIVER={MySQL ODBC 3.51 Driver};" _
& "SERVER=localhost;" _
& "DATABASE=test;" _
& "UID=venu;PWD=venu; OPTION=3"

conn.Open

'create table
conn.Execute "DROP TABLE IF EXISTS my_ado"
conn.Execute "CREATE TABLE my_ado(id int not null primary key, name varchar(20)," _
& "txt text, dt date, tm time, ts timestamp)"

'direct insert
conn.Execute "INSERT INTO my_ado(id,name,txt) values(1,100,'venu')"
conn.Execute "INSERT INTO my_ado(id,name,txt) values(2,200,'MySQL')"
conn.Execute "INSERT INTO my_ado(id,name,txt) values(3,300,'Delete'"

Set rs = New ADODB.Recordset
rs.CursorLocation = adUseServer

'fetch the initial table ..
rs.Open "SELECT * FROM my_ado", conn
Debug.Print rs.RecordCount
rs.MoveFirst
Debug.Print String(50, "-") & "Initial my_ado Result Set " & String(50, "-")
For Each fld In rs.Fields
Debug.Print fld.Name,
Next
Debug.Print

Do Until rs.EOF
For Each fld In rs.Fields
Debug.Print fld.Value,
Next
rs.MoveNext
Debug.Print
Loop
rs.Close

'rs insert
rs.Open "select * from my_ado", conn, adOpenDynamic, adLockOptimistic
rs.AddNew
rs!Name = "Monty"
rs!txt = "Insert row"
rs.Update
rs.Close

'rs update
rs.Open "SELECT * FROM my_ado"
rs!Name = "update"
rs!txt = "updated-row"
rs.Update
rs.Close

'rs update second time..
rs.Open "SELECT * FROM my_ado"
rs!Name = "update"
rs!txt = "updated-second-time"
rs.Update
rs.Close

'rs delete
rs.Open "SELECT * FROM my_ado"
rs.MoveNext
rs.MoveNext
rs.Delete
rs.Close

'fetch the updated table ..
rs.Open "SELECT * FROM my_ado", conn
Debug.Print rs.RecordCount
rs.MoveFirst
Debug.Print String(50, "-") & "Updated my_ado Result Set " & String(50, "-")
For Each fld In rs.Fields
Debug.Print fld.Name,
Next
Debug.Print

Do Until rs.EOF
For Each fld In rs.Fields
Debug.Print fld.Value,
```

```

Next
rs.MoveNext
Debug.Print
Loop
rs.Close
conn.Close
End Sub

```

### 20.1.5.7.1.2. DAO: `rs.addNew`, `rs.update`, and Scrolling

The following DAO (Data Access Objects) example creates a table `my_dao` and demonstrates the use of `rs.addNew`, `rs.update`, and result set scrolling.

```

Private Sub myodbc_dao_Click()

Dim ws As Workspace
Dim conn As Connection
Dim queryDef As queryDef
Dim str As String

'connect to MySQL using MySQL ODBC 3.51 Driver
Set ws = DBEngine.CreateWorkspace("", "venu", "venu", dbUseODBC)
str = "odbc;DRIVER={MySQL ODBC 3.51 Driver};_"
& "SERVER=localhost;_"
& "DATABASE=test;_"
& "UID=venu;PWD=venu; OPTION=3"
Set conn = ws.OpenConnection("test", dbDriverNoPrompt, False, str)

'Create table my_dao
Set queryDef = conn.CreateQueryDef("", "drop table if exists my_dao")
queryDef.Execute

Set queryDef = conn.CreateQueryDef("", "create table my_dao(Id INT AUTO_INCREMENT PRIMARY KEY, " _
& "Ts TIMESTAMP(14) NOT NULL, Name varchar(20), Id2 INT)")
queryDef.Execute

'Insert new records using rs.addNew
Set rs = conn.OpenRecordset("my_dao")
Dim i As Integer

For i = 10 To 15
rs.AddNew
rs!Name = "insert record" & i
rs!Id2 = i
rs.Update
Next i
rs.Close

'rs update..
Set rs = conn.OpenRecordset("my_dao")
rs.Edit
rs!Name = "updated-string"
rs.Update
rs.Close

'fetch the table back...
Set rs = conn.OpenRecordset("my_dao", dbOpenDynamic)
str = "Results:"
rs.MoveFirst
While Not rs.EOF
str = " " & rs!Id & " , " & rs!Name & " , " & rs!Ts & " , " & rs!Id2
Debug.Print "DATA:" & str
rs.MoveNext
Wend

'rs Scrolling
rs.MoveFirst
str = " FIRST ROW: " & rs!Id & " , " & rs!Name & " , " & rs!Ts & " , " & rs!Id2
Debug.Print str

rs.MoveLast
str = " LAST ROW: " & rs!Id & " , " & rs!Name & " , " & rs!Ts & " , " & rs!Id2
Debug.Print str

rs.MovePrevious
str = " LAST-1 ROW: " & rs!Id & " , " & rs!Name & " , " & rs!Ts & " , " & rs!Id2
Debug.Print str

'free all resources
rs.Close
queryDef.Close
conn.Close
ws.Close

End Sub

```

### 20.1.5.7.1.3. RDO: `rs.addNew` and `rs.update`

The following RDO (Remote Data Objects) example creates a table `my_rdo` and demonstrates the use of `rs.addNew` and `rs.update`.

```

Dim rs As rdoResultset
Dim cn As New rdoConnection
Dim cl As rdoColumn
Dim SQL As String

'cn.Connect = "DSN=test;"
cn.Connect = "DRIVER={MySQL ODBC 3.51 Driver};"_
& "SERVER=localhost;"_
& "DATABASE=test;"_
& "UID=venu;PWD=venu; OPTION=3"

cn.CursorDriver = rdUseOdbc
cn.EstablishConnection rdDriverPrompt

'drop table my_rdo
SQL = "drop table if exists my_rdo"
cn.Execute SQL, rdExecDirect

'create table my_rdo
SQL = "create table my_rdo(id int, name varchar(20))"
cn.Execute SQL, rdExecDirect

'insert - direct
SQL = "insert into my_rdo values (100,'venu')"
cn.Execute SQL, rdExecDirect

SQL = "insert into my_rdo values (200,'MySQL')"
cn.Execute SQL, rdExecDirect

'rs insert
SQL = "select * from my_rdo"
Set rs = cn.OpenResultset(SQL, rdOpenStatic, rdConcurRowVer, rdExecDirect)
rs.AddNew
rs!id = 300
rs!Name = "Insert1"
rs.Update
rs.Close

'rs insert
SQL = "select * from my_rdo"
Set rs = cn.OpenResultset(SQL, rdOpenStatic, rdConcurRowVer, rdExecDirect)
rs.AddNew
rs!id = 400
rs!Name = "Insert 2"
rs.Update
rs.Close

'rs update
SQL = "select * from my_rdo"
Set rs = cn.OpenResultset(SQL, rdOpenStatic, rdConcurRowVer, rdExecDirect)
rs.Edit
rs!id = 999
rs!Name = "updated"
rs.Update
rs.Close

'fetch back...
SQL = "select * from my_rdo"
Set rs = cn.OpenResultset(SQL, rdOpenStatic, rdConcurRowVer, rdExecDirect)
Do Until rs.EOF
For Each cl In rs.rdoColumns
Debug.Print cl.Value,
Next
rs.MoveNext
Debug.Print
Loop
Debug.Print "Row count="; rs.RowCount

'close
rs.Close
cn.Close

End Sub

```

### 20.1.5.7.2. Using Connector/ODBC with .NET

This section contains simple examples that demonstrate the use of Connector/ODBC drivers with ODBC.NET.

#### 20.1.5.7.2.1. Using Connector/ODBC with ODBC.NET and C# (C sharp)

The following sample creates a table `my_odbc_net` and demonstrates its use in C#.

```

/**
 * @sample      : mycon.cs
 * @purpose     : Demo sample for ODBC.NET using Connector/ODBC
 * @author      : Venu, <myodbc@lists.mysql.com>
 *
 * (C) Copyright MySQL AB, 1995-2006
 *
 **/

```

```

/* build command
 *
 * csc /t:exe
 * /out:mycon.exe mycon.cs
 * /r:Microsoft.Data.Odbc.dll
 */

using Console = System.Console;
using Microsoft.Data.Odbc;

namespace myodbc3
{
    class mycon
    {
        static void Main(string[] args)
        {
            try
            {
                //Connection string for Connector/ODBC 3.51
                string MyConString = "DRIVER={MySQL ODBC 3.51 Driver};" +
                    "SERVER=localhost;" +
                    "DATABASE=test;" +
                    "UID=venu;" +
                    "PASSWORD=venu;" +
                    "OPTION=3";

                //Connect to MySQL using Connector/ODBC
                OdbcConnection MyConnection = new OdbcConnection(MyConString);
                MyConnection.Open();

                Console.WriteLine("\n !!! success, connected successfully !!!\n");

                //Display connection information
                Console.WriteLine("Connection Information:");
                Console.WriteLine("\tConnection String:" +
                    MyConnection.ConnectionString);
                Console.WriteLine("\tConnection Timeout:" +
                    MyConnection.ConnectionTimeout);
                Console.WriteLine("\tDatabase:" +
                    MyConnection.Database);
                Console.WriteLine("\tDataSource:" +
                    MyConnection.DataSource);
                Console.WriteLine("\tDriver:" +
                    MyConnection.Driver);
                Console.WriteLine("\tServerVersion:" +
                    MyConnection.ServerVersion);

                //Create a sample table
                OdbcCommand MyCommand =
                    new OdbcCommand("DROP TABLE IF EXISTS my_odbc_net",
                    MyConnection);
                MyCommand.ExecuteNonQuery();
                MyCommand.CommandText =
                    "CREATE TABLE my_odbc_net(id int, name varchar(20), idb bigint)";
                MyCommand.ExecuteNonQuery();

                //Insert
                MyCommand.CommandText =
                    "INSERT INTO my_odbc_net VALUES(10,'venu', 300)";
                Console.WriteLine("INSERT, Total rows affected:" +
                    MyCommand.ExecuteNonQuery());

                //Insert
                MyCommand.CommandText =
                    "INSERT INTO my_odbc_net VALUES(20,'mysql',400)";
                Console.WriteLine("INSERT, Total rows affected:" +
                    MyCommand.ExecuteNonQuery());

                //Insert
                MyCommand.CommandText =
                    "INSERT INTO my_odbc_net VALUES(20,'mysql',500)";
                Console.WriteLine("INSERT, Total rows affected:" +
                    MyCommand.ExecuteNonQuery());

                //Update
                MyCommand.CommandText =
                    "UPDATE my_odbc_net SET id=999 WHERE id=20";
                Console.WriteLine("Update, Total rows affected:" +
                    MyCommand.ExecuteNonQuery());

                //COUNT(*)
                MyCommand.CommandText =
                    "SELECT COUNT(*) as TRows FROM my_odbc_net";
                Console.WriteLine("Total Rows:" +
                    MyCommand.ExecuteScalar());

                //Fetch
                MyCommand.CommandText = "SELECT * FROM my_odbc_net";
                OdbcDataReader MyDataReader;
                MyDataReader = MyCommand.ExecuteReader();
                while (MyDataReader.Read())
                {
                    if(string.Compare(MyConnection.Driver,"myodbc3.dll") == 0) {
                        //Supported only by Connector/ODBC 3.51
                        Console.WriteLine("Data:" + MyDataReader.GetInt32(0) + " " +
                            MyDataReader.GetString(1) + " " +
                            MyDataReader.GetInt64(2));
                    }
                }
            }
        }
    }
}

```



```

        else {
            //BIGINTs not supported by Connector/ODBC
            Console.WriteLine("Data:" + MyDataReader.GetInt32(0) + " " +
                MyDataReader.GetString(1) + " " +
                MyDataReader.GetInt32(2));
        }
    }

    //Close all resources
    MyDataReader.Close();
    MyConnection.Close();
}
catch (OdbcException MyOdbcException) //Catch any ODBC exception ..
{
    for (int i=0; i < MyOdbcException.Errors.Count; i++)
    {
        Console.Write("ERROR #" + i + "\n" +
            "Message: " +
            MyOdbcException.Errors[i].Message + "\n" +
            "Native: " +
            MyOdbcException.Errors[i].NativeError.ToString() + "\n" +
            "Source: " +
            MyOdbcException.Errors[i].Source + "\n" +
            "SQL: " +
            MyOdbcException.Errors[i].SQLState + "\n");
    }
}
}
}
}
}
}

```

### 20.1.5.7.2.2. Using Connector/ODBC with ODBC.NET and Visual Basic

The following sample creates a table `my_vb_net` and demonstrates the use in VB.

```

' @sample      : myvb.vb
' @purpose     : Demo sample for ODBC.NET using Connector/ODBC
' @author      : Venu, <myodbc@lists.mysql.com>
'
' (C) Copyright MySQL AB, 1995-2006
'
'
'
' build command
'
' vbc /target:exe
'     /out:myvb.exe
'     /r:Microsoft.Data.Odbc.dll
'     /r:System.dll
'     /r:System.Data.dll
'
Imports Microsoft.Data.Odbc
Imports System

Module myvb
    Sub Main()
        Try

            'Connector/ODBC 3.51 connection string
            Dim MyConString As String = "DRIVER={MySQL ODBC 3.51 Driver};" & _
                "SERVER=localhost;" & _
                "DATABASE=test;" & _
                "UID=venu;" & _
                "PASSWORD=venu;" & _
                "OPTION=3;"

            'Connection
            Dim MyConnection As New OdbcConnection(MyConString)
            MyConnection.Open()

            Console.WriteLine("Connection State::" & MyConnection.State.ToString)

            'Drop
            Console.WriteLine("Dropping table")
            Dim MyCommand As New OdbcCommand()
            MyCommand.Connection = MyConnection
            MyCommand.CommandText = "DROP TABLE IF EXISTS my_vb_net"
            MyCommand.ExecuteNonQuery()

            'Create
            Console.WriteLine("Creating...")
            MyCommand.CommandText = "CREATE TABLE my_vb_net(id int, name varchar(30))"
            MyCommand.ExecuteNonQuery()

            'Insert
            MyCommand.CommandText = "INSERT INTO my_vb_net VALUES(10,'venu')"
            Console.WriteLine("INSERT, Total rows affected:" & _
                MyCommand.ExecuteNonQuery())

            'Insert
            MyCommand.CommandText = "INSERT INTO my_vb_net VALUES(20,'mysql')"
            Console.WriteLine("INSERT, Total rows affected:" & _
                MyCommand.ExecuteNonQuery())
        }
    }
}

```

```

'Insert
MyCommand.CommandText = "INSERT INTO my_vb_net VALUES(20,'mysql')"
Console.WriteLine("INSERT, Total rows affected:" & _
MyCommand.ExecuteNonQuery())

'Insert
MyCommand.CommandText = "INSERT INTO my_vb_net(id) VALUES(30)"
Console.WriteLine("INSERT, Total rows affected:" & _
MyCommand.ExecuteNonQuery())

'Update
MyCommand.CommandText = "UPDATE my_vb_net SET id=999 WHERE id=20"
Console.WriteLine("Update, Total rows affected:" & _
MyCommand.ExecuteNonQuery())

'COUNT(*)
MyCommand.CommandText = "SELECT COUNT(*) as TRows FROM my_vb_net"
Console.WriteLine("Total Rows:" & MyCommand.ExecuteScalar())

'Select
Console.WriteLine("Select * FROM my_vb_net")
MyCommand.CommandText = "SELECT * FROM my_vb_net"
Dim MyDataReader As OdbcDataReader
MyDataReader = MyCommand.ExecuteReader
While MyDataReader.Read
If MyDataReader("name") Is DBNull.Value Then
Console.WriteLine("id = " & _
CStr(MyDataReader("id")) & " name = " & _
"NULL")
Else
Console.WriteLine("id = " & _
CStr(MyDataReader("id")) & " name = " & _
CStr(MyDataReader("name")))
End If
End While

'Catch ODBC Exception
Catch MyOdbcException As OdbcException
Dim i As Integer
Console.WriteLine(MyOdbcException.ToString)

'Catch program exception
Catch MyException As Exception
Console.WriteLine(MyException.ToString)
End Try
End Sub

```

## 20.1.6. Connector/ODBC Reference

This section provides reference material for the Connector/ODBC API, showing supported functions and methods, supported MySQL column types and the corresponding native type in Connector/ODBC, and the error codes returned by Connector/ODBC when a fault occurs.

### 20.1.6.1. Connector/ODBC API Reference

This section summarizes ODBC routines, categorized by functionality.

For the complete ODBC API reference, please refer to the ODBC Programmer's Reference at <http://msdn.microsoft.com/en-us/library/ms714177.aspx>.

An application can call [SQLGetInfo](#) function to obtain conformance information about Connector/ODBC. To obtain information about support for a specific function in the driver, an application can call [SQLGetFunctions](#).

#### Note

For backward compatibility, the Connector/ODBC 3.51 driver supports all deprecated functions.

The following tables list Connector/ODBC API calls grouped by task:

#### Connecting to a data source

Function name	C/ODBC 3.51	Standard	Purpose
<a href="#">SQLAllocHandle</a>	Yes	ISO 92	Obtains an environment, connection, statement, or descriptor handle.
<a href="#">SQLConnect</a>	Yes	ISO 92	Connects to a specific driver by data source name, user ID, and password.
<a href="#">SQLDriverConnect</a>	Yes	ODBC	Connects to a specific driver by connection string or requests that the Driver Manager and driver display connection dialog boxes for the user.

<a href="#">SQLAllocEnv</a>	Yes	Deprecated	Obtains an environment handle allocated from driver.
<a href="#">SQLAllocConnect</a>	Yes	Deprecated	Obtains a connection handle

#### Obtaining information about a driver and data source

Function name	C/ODBC 3.51	Standard	Purpose
<a href="#">SQLDataSources</a>	No	ISO 92	Returns the list of available data sources, handled by the Driver Manager
<a href="#">SQLDrivers</a>	No	ODBC	Returns the list of installed drivers and their attributes, handles by Driver Manager
<a href="#">SQLGetInfo</a>	Yes	ISO 92	Returns information about a specific driver and data source.
<a href="#">SQLGetFunctions</a>	Yes	ISO 92	Returns supported driver functions.
<a href="#">SQLGetTypeInfo</a>	Yes	ISO 92	Returns information about supported data types.

#### Setting and retrieving driver attributes

Function name	C/ODBC 3.51	Standard	Purpose
<a href="#">SQLSetConnectAttr</a>	Yes	ISO 92	Sets a connection attribute.
<a href="#">SQLGetConnectAttr</a>	Yes	ISO 92	Returns the value of a connection attribute.
<a href="#">SQLSetConnectOption</a>	Yes	Deprecated	Sets a connection option
<a href="#">SQLGetConnectOption</a>	Yes	Deprecated	Returns the value of a connection option
<a href="#">SQLSetEnvAttr</a>	Yes	ISO 92	Sets an environment attribute.
<a href="#">SQLGetEnvAttr</a>	Yes	ISO 92	Returns the value of an environment attribute.
<a href="#">SQLSetStmtAttr</a>	Yes	ISO 92	Sets a statement attribute.
<a href="#">SQLGetStmtAttr</a>	Yes	ISO 92	Returns the value of a statement attribute.
<a href="#">SQLSetStmtOption</a>	Yes	Deprecated	Sets a statement option
<a href="#">SQLGetStmtOption</a>	Yes	Deprecated	Returns the value of a statement option

#### Preparing SQL requests

Function name	C/ODBC 3.51	Standard	Purpose
<a href="#">SQLAllocStmt</a>	Yes	Deprecated	Allocates a statement handle
<a href="#">SQLPrepare</a>	Yes	ISO 92	Prepares an SQL statement for later execution.
<a href="#">SQLBindParameter</a>	Yes	ODBC	Assigns storage for a parameter in an SQL statement.
<a href="#">SQLGetCursorName</a>	Yes	ISO 92	Returns the cursor name associated with a statement handle.
<a href="#">SQLSetCursorName</a>	Yes	ISO 92	Specifies a cursor name.
<a href="#">SQLSetScrollOptions</a>	Yes	ODBC	Sets options that control cursor behavior.

#### Submitting requests

Function name	C/ODBC 3.51	Standard	Purpose
<a href="#">SQLExecute</a>	Yes	ISO 92	Executes a prepared statement.
<a href="#">SQLExecDirect</a>	Yes	ISO 92	Executes a statement
<a href="#">SQLNativeSql</a>	Yes	ODBC	Returns the text of an SQL statement as translated by the driver.
<a href="#">SQLDescribeParam</a>	Yes	ODBC	Returns the description for a specific parameter in a statement.
<a href="#">SQLNumParams</a>	Yes	ISO 92	Returns the number of parameters in a statement.
<a href="#">SQLParamData</a>	Yes	ISO 92	Used in conjunction with <a href="#">SQLPutData</a> to supply parameter data at execution time. (Useful for long data values.)

SQLPutData	Yes	ISO 92	Sends part or all of a data value for a parameter. (Useful for long data values.)
------------	-----	--------	---

#### Retrieving results and information about results

Function name	C/ODBC 3.51	Standard	Purpose
SQLRowCount	Yes	ISO 92	Returns the number of rows affected by an insert, update, or delete request.
SQLNumResultCols	Yes	ISO 92	Returns the number of columns in the result set.
SQLDescribeCol	Yes	ISO 92	Describes a column in the result set.
SQLColAttribute	Yes	ISO 92	Describes attributes of a column in the result set.
SQLColAttributes	Yes	Deprecated	Describes attributes of a column in the result set.
SQLFetch	Yes	ISO 92	Returns multiple result rows.
SQLFetchScroll	Yes	ISO 92	Returns scrollable result rows.
SQLExtendedFetch	Yes	Deprecated	Returns scrollable result rows.
SQLSetPos	Yes	ODBC	Positions a cursor within a fetched block of data and allows an application to refresh data in the rowset or to update or delete data in the result set.
SQLBulkOperations	Yes	ODBC	Performs bulk insertions and bulk bookmark operations, including update, delete, and fetch by bookmark.

#### Retrieving error or diagnostic information

Function name	C/ODBC 3.51	Standard	Purpose
SQLError	Yes	Deprecated	Returns additional error or status information
SQLGetDiagField	Yes	ISO 92	Returns additional diagnostic information (a single field of the diagnostic data structure).
SQLGetDiagRec	Yes	ISO 92	Returns additional diagnostic information (multiple fields of the diagnostic data structure).

#### Obtaining information about the data source's system tables (catalog functions) item

Function name	C/ODBC 3.51	Standard	Purpose
SQLColumnPrivileges	Yes	ODBC	Returns a list of columns and associated privileges for one or more tables.
SQLColumns	Yes	X/Open	Returns the list of column names in specified tables.
SQLForeignKeys	Yes	ODBC	Returns a list of column names that make up foreign keys, if they exist for a specified table.
SQLPrimaryKeys	Yes	ODBC	Returns the list of column names that make up the primary key for a table.
SQLSpecialColumns	Yes	X/Open	Returns information about the optimal set of columns that uniquely identifies a row in a specified table, or the columns that are automatically updated when any value in the row is updated by a transaction.
SQLStatistics	Yes	ISO 92	Returns statistics about a single table and the list of indexes associated with the table.
SQLTablePrivileges	Yes	ODBC	Returns a list of tables and the privileges associated with each table.
SQLTables	Yes	X/Open	Returns the list of table names stored in a specific data source.

#### Performing transactions

Function name	C/ODBC 3.51	Standard	Purpose
<a href="#">SQLTransact</a>	Yes	Deprecated	Commits or rolls back a transaction
<a href="#">SQLEndTran</a>	Yes	ISO 92	Commits or rolls back a transaction.

#### Terminating a statement

Function name	C/ODBC 3.51	Standard	Purpose
<a href="#">SQLFreeStmt</a>	Yes	ISO 92	Ends statement processing, discards pending results, and, optionally, frees all resources associated with the statement handle.
<a href="#">SQLCloseCursor</a>	Yes	ISO 92	Closes a cursor that has been opened on a statement handle.
<a href="#">SQLCancel</a>	Yes	ISO 92	Cancels an SQL statement.

#### Terminating a connection

Function name	C/ODBC 3.51	Standard	Purpose
<a href="#">SQLDisconnect</a>	Yes	ISO 92	Closes the connection.
<a href="#">SQLFreeHandle</a>	Yes	ISO 92	Releases an environment, connection, statement, or descriptor handle.
<a href="#">SQLFreeConnect</a>	Yes	Deprecated	Releases connection handle
<a href="#">SQLFreeEnv</a>	Yes	Deprecated	Releases an environment handle

### 20.1.6.2. Connector/ODBC Data Types

The following table illustrates how driver maps the server data types to default SQL and C data types.

Native Value	SQL Type	C Type
<code>bigint unsigned</code>	SQL_BIGINT	SQL_C_UBIGINT
<code>bigint</code>	SQL_BIGINT	SQL_C_SBIGINT
<code>bit</code>	SQL_BIT	SQL_C_BIT
<code>bit</code>	SQL_CHAR	SQL_C_CHAR
<code>blob</code>	SQL_LONGVARBINARY	SQL_C_BINARY
<code>bool</code>	SQL_CHAR	SQL_C_CHAR
<code>char</code>	SQL_CHAR	SQL_C_CHAR
<code>date</code>	SQL_DATE	SQL_C_DATE
<code>datetime</code>	SQL_TIMESTAMP	SQL_C_TIMESTAMP
<code>decimal</code>	SQL_DECIMAL	SQL_C_CHAR
<code>double precision</code>	SQL_DOUBLE	SQL_C_DOUBLE
<code>double</code>	SQL_FLOAT	SQL_C_DOUBLE
<code>enum</code>	SQL_VARCHAR	SQL_C_CHAR
<code>float</code>	SQL_REAL	SQL_C_FLOAT
<code>int unsigned</code>	SQL_INTEGER	SQL_C_ULONG
<code>int</code>	SQL_INTEGER	SQL_C_SLONG
<code>integer unsigned</code>	SQL_INTEGER	SQL_C_ULONG
<code>integer</code>	SQL_INTEGER	SQL_C_SLONG
<code>long varbinary</code>	SQL_LONGVARBINARY	SQL_C_BINARY
<code>long varchar</code>	SQL_LONGVARCHAR	SQL_C_CHAR
<code>longblob</code>	SQL_LONGVARBINARY	SQL_C_BINARY
<code>longtext</code>	SQL_LONGVARCHAR	SQL_C_CHAR

mediumblob	SQL_LONGVARBINARY	SQL_C_BINARY
mediumint unsigned	SQL_INTEGER	SQL_C_ULONG
mediumint	SQL_INTEGER	SQL_C_SLONG
mediumtext	SQL_LONGVARCHAR	SQL_C_CHAR
numeric	SQL_NUMERIC	SQL_C_CHAR
real	SQL_FLOAT	SQL_C_DOUBLE
set	SQL_VARCHAR	SQL_C_CHAR
smallint unsigned	SQL_SMALLINT	SQL_C_USHORT
smallint	SQL_SMALLINT	SQL_C_SSHORT
text	SQL_LONGVARCHAR	SQL_C_CHAR
time	SQL_TIME	SQL_C_TIME
timestamp	SQL_TIMESTAMP	SQL_C_TIMESTAMP
tinyblob	SQL_LONGVARBINARY	SQL_C_BINARY
tinyint unsigned	SQL_TINYINT	SQL_C_UTINYINT
tinyint	SQL_TINYINT	SQL_C_STINYINT
tinytext	SQL_LONGVARCHAR	SQL_C_CHAR
varchar	SQL_VARCHAR	SQL_C_CHAR
year	SQL_SMALLINT	SQL_C_SHORT

### 20.1.6.3. Connector/ODBC Error Codes

The following tables lists the error codes returned by the driver apart from the server errors.

Native Code	SQLSTATE 2	SQLSTATE 3	Error Message
500	01000	01000	General warning
501	01004	01004	String data, right truncated
502	01S02	01S02	Option value changed
503	01S03	01S03	No rows updated/deleted
504	01S04	01S04	More than one row updated/deleted
505	01S06	01S06	Attempt to fetch before the result set returned the first row set
506	07001	07002	<code>SQLBindParameter</code> not used for all parameters
507	07005	07005	Prepared statement not a cursor-specification
508	07009	07009	Invalid descriptor index
509	08002	08002	Connection name in use
510	08003	08003	Connection does not exist
511	24000	24000	Invalid cursor state
512	25000	25000	Invalid transaction state
513	25S01	25S01	Transaction state unknown
514	34000	34000	Invalid cursor name
515	S1000	HY000	General driver defined error
516	S1001	HY001	Memory allocation error
517	S1002	HY002	Invalid column number
518	S1003	HY003	Invalid application buffer type
519	S1004	HY004	Invalid SQL data type
520	S1009	HY009	Invalid use of null pointer
521	S1010	HY010	Function sequence error
522	S1011	HY011	Attribute can not be set now
523	S1012	HY012	Invalid transaction operation code

524	S1013	HY013	Memory management error
525	S1015	HY015	No cursor name available
526	S1024	HY024	Invalid attribute value
527	S1090	HY090	Invalid string or buffer length
528	S1091	HY091	Invalid descriptor field identifier
529	S1092	HY092	Invalid attribute/option identifier
530	S1093	HY093	Invalid parameter number
531	S1095	HY095	Function type out of range
532	S1106	HY106	Fetch type out of range
533	S1117	HY117	Row value out of range
534	S1109	HY109	Invalid cursor position
535	S1C00	HYC00	Optional feature not implemented
0	21S01	21S01	Column count does not match value count
0	23000	23000	Integrity constraint violation
0	42000	42000	Syntax error or access violation
0	42S02	42S02	Base table or view not found
0	42S12	42S12	Index not found
0	42S21	42S21	Column already exists
0	42S22	42S22	Column not found
0	08S01	08S01	Communication link failure

## 20.1.7. Connector/ODBC Notes and Tips

Here are some common notes and tips for using Connector/ODBC within different environments, applications and tools. The notes provided here are based on the experiences of Connector/ODBC developers and users.

### 20.1.7.1. Connector/ODBC General Functionality

This section provides help with common queries and areas of functionality in MySQL and how to use them with Connector/ODBC.

#### 20.1.7.1.1. Obtaining Auto-Increment Values

Obtaining the value of column that uses `AUTO_INCREMENT` after an `INSERT` statement can be achieved in a number of different ways. To obtain the value immediately after an `INSERT`, use a `SELECT` query with the `LAST_INSERT_ID()` function.

For example, using Connector/ODBC you would execute two separate statements, the `INSERT` statement and the `SELECT` query to obtain the auto-increment value.

```
INSERT INTO tbl (auto,text) VALUES(NULL,'text');
SELECT LAST_INSERT_ID();
```

If you do not require the value within your application, but do require the value as part of another `INSERT`, the entire process can be handled by executing the following statements:

```
INSERT INTO tbl (auto,text) VALUES(NULL,'text');
INSERT INTO tbl2 (id,text) VALUES(LAST_INSERT_ID(),'text');
```

Certain ODBC applications (including Delphi and Access) may have trouble obtaining the auto-increment value using the previous examples. In this case, try the following statement as an alternative:

```
SELECT * FROM tbl WHERE auto IS NULL;
```

See [Section 20.10.10.3, “How to Get the Unique ID for the Last Inserted Row”](#).

#### 20.1.7.1.2. Dynamic Cursor Support

Support for the `dynamic cursor` is provided in Connector/ODBC 3.51, but dynamic cursors are not enabled by default. You can enable this function within Windows by selecting the `Enable Dynamic Cursor` checkbox within the ODBC Data Source Administrator.

On other platforms, you can enable the dynamic cursor by adding 32 to the `OPTION` value when creating the DSN.

### 20.1.7.1.3. Connector/ODBC Performance

The Connector/ODBC driver has been optimized to provide very fast performance. If you experience problems with the performance of Connector/ODBC, or notice a large amount of disk activity for simple queries, there are a number of aspects you should check:

- Ensure that `ODBC Tracing` is not enabled. With tracing enabled, a lot of information is recorded in the tracing file by the ODBC Manager. You can check, and disable, tracing within Windows using the TRACING panel of the ODBC Data Source Administrator. Within Mac OS X, check the TRACING panel of ODBC Administrator. See [Section 20.1.4.8, “Getting an ODBC Trace File”](#).
- Make sure you are using the standard version of the driver, and not the debug version. The debug version includes additional checks and reporting measures.
- Disable the Connector/ODBC driver trace and query logs. These options are enabled for each DSN, so make sure to examine only the DSN that you are using in your application. Within Windows, you can disable the Connector/ODBC and query logs by modifying the DSN configuration. Within Mac OS X and Unix, ensure that the driver trace (option value 4) and query logging (option value 524288) are not enabled.

### 20.1.7.1.4. Setting ODBC Query Timeout in Windows

For more information on how to set the query timeout on Microsoft Windows when executing queries through an ODBC connection, read the Microsoft knowledgebase document at <http://support.microsoft.com/default.aspx?scid=kb%3Ben-us%3B153756>.

### 20.1.7.2. Connector/ODBC Application Specific Tips

Most programs should work with Connector/ODBC, but for each of those listed here, there are specific notes and tips to improve or enhance the way you work with Connector/ODBC and these applications.

With all applications you should ensure that you are using the latest Connector/ODBC drivers, ODBC Manager and any supporting libraries and interfaces used by your application. For example, on Windows, using the latest version of Microsoft Data Access Components (MDAC) will improve the compatibility with ODBC in general, and with the Connector/ODBC driver.

#### 20.1.7.2.1. Using Connector/ODBC with Microsoft Applications

The majority of Microsoft applications have been tested with Connector/ODBC, including Microsoft Office, Microsoft Access and the various programming languages supported within ASP and Microsoft Visual Studio.

##### 20.1.7.2.1.1. Microsoft Access

To improve the integration between Microsoft Access and MySQL through Connector/ODBC:

- For all versions of Access, you should enable the Connector/ODBC `Return matching rows` option. For Access 2.0, you should additionally enable the `Simulate ODBC 1.0` option.
- You should have a `TIMESTAMP` column in all tables that you want to be able to update. For maximum portability, do not use a length specification in the column declaration (which is unsupported within MySQL in versions earlier than 4.1).
- You should have a primary key in each MySQL table you want to use with Access. If not, new or updated rows may show up as `#DELETED#`.
- Use only `DOUBLE` float fields. Access fails when comparing with single-precision floats. The symptom usually is that new or updated rows may show up as `#DELETED#` or that you cannot find or update rows.
- If you are using Connector/ODBC to link to a table that has a `BIGINT` column, the results are displayed as `#DELETED#`. The work around solution is:
  - Have one more dummy column with `TIMESTAMP` as the data type.
  - Select the `Change BIGINT columns to INT` option in the connection dialog in ODBC DSN Administrator.
  - Delete the table link from Access and re-create it.

Old records may still display as `#DELETED#`, but newly added/updated records are displayed properly.



- If you still get the error [Another user has changed your data](#) after adding a `TIMESTAMP` column, the following trick may help you:

Do not use a `table` data sheet view. Instead, create a form with the fields you want, and use that `form` data sheet view. You should set the `DefaultValue` property for the `TIMESTAMP` column to `NOW()`. It may be a good idea to hide the `TIMESTAMP` column from view so your users are not confused.

- In some cases, Access may generate SQL statements that MySQL cannot understand. You can fix this by selecting "`Query|SQLSpecific|Pass-Through`" from the Access menu.
- On Windows NT, Access reports `BLOB` columns as `OLE OBJECTS`. If you want to have `MEMO` columns instead, you should change `BLOB` columns to `TEXT` with `ALTER TABLE`.
- Access cannot always handle the MySQL `DATE` column properly. If you have a problem with these, change the columns to `DATETIME`.
- If you have in Access a column defined as `BYTE`, Access tries to export this as `TINYINT` instead of `TINYINT UNSIGNED`. This gives you problems if you have values larger than 127 in the column.
- If you have very large (long) tables in Access, it might take a very long time to open them. Or you might run low on virtual memory and eventually get an `ODBC Query Failed` error and the table cannot open. To deal with this, select the following options:
  - Return Matching Rows (2)
  - Allow BIG Results (8).

These add up to a value of 10 (`OPTION=10`).

Some external articles and tips that may be useful when using Access, ODBC and Connector/ODBC:

- Read [How to Trap ODBC Login Error Messages in Access](#)
- [Optimizing Access ODBC Applications](#)
  - [Optimizing for Client/Server Performance](#)
  - [Tips for Converting Applications to Using ODBCdirect](#)
  - [Tips for Optimizing Queries on Attached SQL Tables](#)
- For a list of tools that can be used with Access and ODBC data sources, refer to [converters](#) section for list of available tools.

#### MySQL Enterprise

MySQL Enterprise subscribers will find more information about using ODBC with Access in Knowledge Base articles such as [Use MySQL-Specific Syntax with Microsoft Access](#). To subscribe to MySQL Enterprise see <http://www.mysql.com/products/enterprise/advisors.html>.

### 20.1.7.2.1.2. Microsoft Excel and Column Types

If you have problems importing data into Microsoft Excel, particularly numerical, date, and time values, this is probably because of a bug in Excel, where the column type of the source data is used to determine the data type when that data is inserted into a cell within the worksheet. The result is that Excel incorrectly identifies the content and this affects both the display format and the data when it is used within calculations.

To address this issue, use the `CONCAT()` function in your queries. The use of `CONCAT()` forces Excel to treat the value as a string, which Excel will then parse and usually correctly identify the embedded information.

However, even with this option, some data may be incorrectly formatted, even though the source data remains unchanged. Use the [Format Cells](#) option within Excel to change the format of the displayed information.

### 20.1.7.2.1.3. Microsoft Visual Basic

To be able to update a table, you must define a primary key for the table.

Visual Basic with ADO cannot handle big integers. This means that some queries like `SHOW PROCESSLIST` do not work properly. The fix is to use `OPTION=16384` in the ODBC connect string or to select the `Change BIGINT columns to INT` option in the Connector/ODBC connect screen. You may also want to select the [Return matching rows](#) option.

**MySQL Enterprise**

MySQL Enterprise subscribers can find a discussion about using VBA in the Knowledge Base article, [MySQL-Specific Syntax with VBA](http://www.mysql.com/products/enterprise/advisors.html). To subscribe to MySQL Enterprise see <http://www.mysql.com/products/enterprise/advisors.html>.

**20.1.7.2.1.4. Microsoft Visual InterDev**

If you have a `BIGINT` in your result, you may get the error `[Microsoft][ODBC Driver Manager] Driver does not support this parameter`. Try selecting the `Change BIGINT columns to INT` option in the Connector/ODBC connect screen.

**20.1.7.2.1.5. Visual Objects**

You should select the `Don't optimize column widths` option.

**20.1.7.2.1.6. Microsoft ADO**

When you are coding with the ADO API and Connector/ODBC, you need to pay attention to some default properties that aren't supported by the MySQL server. For example, using the `CursorLocation Property` as `adUseServer` returns a result of `-1` for the `RecordCount Property`. To have the right value, you need to set this property to `adUseClient`, as shown in the VB code here:

```
Dim myconn As New ADOConnection
Dim myrs As New Recordset
Dim mySQL As String
Dim myrows As Long

myconn.Open "DSN=MyODBCsample"
mySQL = "SELECT * from user"
myrs.Source = mySQL
Set myrs.ActiveConnection = myconn
myrs.CursorLocation = adUseClient
myrs.Open
myrows = myrs.RecordCount

myrs.Close
myconn.Close
```

Another workaround is to use a `SELECT COUNT( *)` statement for a similar query to get the correct row count.

To find the number of rows affected by a specific SQL statement in ADO, use the `RecordsAffected` property in the ADO `execute` method. For more information on the usage of `execute` method, refer to <http://msdn.microsoft.com/library/default.asp?url=/library/en-us/ado270/htm/mdmthcnnextexecute.asp>.

For information, see [ActiveX Data Objects\(ADO\) Frequently Asked Questions](#).

**20.1.7.2.1.7. Using Connector/ODBC with Active Server Pages (ASP)**

You should select the `Return matching rows` option in the DSN.

For more information about how to access MySQL via ASP using Connector/ODBC, refer to the following articles:

- [Using MyODBC To Access Your MySQL Database Via ASP](#)
- [ASP and MySQL at DWAM.NT](#)

A Frequently Asked Questions list for ASP can be found at <http://support.microsoft.com/default.aspx?scid=/Support/ActiveServer/faq/data/adofaq.asp>.

**20.1.7.2.1.8. Using Connector/ODBC with Visual Basic (ADO, DAO and RDO) and ASP**

Some articles that may help with Visual Basic and ASP:

- [MySQL BLOB columns and Visual Basic 6](#) by Mike Hillyer (<mike@openwin.org>).
- [How to map Visual basic data type to MySQL types](#) by Mike Hillyer (<mike@openwin.org>).

**20.1.7.2.2. Using Connector/ODBC with Borland Applications**

With all Borland applications where the Borland Database Engine (BDE) is used, follow these steps to improve compatibility:

- Update to BDE 3.2 or newer.
- Enable the `Don't optimize column widths` option in the DSN.
- Enabled the `Return matching rows` option in the DSN.

#### 20.1.7.2.2.1. Using Connector/ODBC with Borland Builder 4

When you start a query, you can use the `Active` property or the `Open` method. Note that `Active` starts by automatically issuing a `SELECT * FROM ...` query. That may not be a good thing if your tables are large.

#### 20.1.7.2.2.2. Using Connector/ODBC with Delphi

Also, here is some potentially useful Delphi code that sets up both an ODBC entry and a BDE entry for Connector/ODBC. The BDE entry requires a BDE Alias Editor that is free at a Delphi Super Page near you. (Thanks to Bryan Brunton <bryan@flesherfab.com> for this):

```
fReg:= TRegistry.Create;
fReg.OpenKey('\Software\ODBC\ODBC.INI\DocumentsFab', True);
fReg.WriteString('Database', 'Documents');
fReg.WriteString('Description', '');
fReg.WriteString('Driver', 'C:\WINNT\System32\myodbc.dll');
fReg.WriteString('Flag', '1');
fReg.WriteString('Password', '');
fReg.WriteString('Port', '');
fReg.WriteString('Server', 'xmark');
fReg.WriteString('User', 'winuser');
fReg.OpenKey('\Software\ODBC\ODBC.INI\ODBC Data Sources', True);
fReg.WriteString('DocumentsFab', 'MySQL');
fReg.CloseKey;
fReg.Free;

Memol.Lines.Add('DATABASE NAME=');
Memol.Lines.Add('USER NAME=');
Memol.Lines.Add('ODBC DSN=DocumentsFab');
Memol.Lines.Add('OPEN MODE=READ/WRITE');
Memol.Lines.Add('BATCH COUNT=200');
Memol.Lines.Add('LANGDRIVER=');
Memol.Lines.Add('MAX ROWS=-1');
Memol.Lines.Add('SCHEMA CACHE DIR=');
Memol.Lines.Add('SCHEMA CACHE SIZE=8');
Memol.Lines.Add('SCHEMA CACHE TIME=-1');
Memol.Lines.Add('SQLPASSTHRU MODE=SHARED AUTOCOMMIT');
Memol.Lines.Add('SQLQRYMODE=');
Memol.Lines.Add('ENABLE SCHEMA CACHE=FALSE');
Memol.Lines.Add('ENABLE BCD=FALSE');
Memol.Lines.Add('ROWSET SIZE=20');
Memol.Lines.Add('BLOBS TO CACHE=64');
Memol.Lines.Add('BLOB SIZE=32');

AliasEditor.Add('DocumentsFab', 'MySQL', Memol.Lines);
```

#### 20.1.7.2.2.3. Using Connector/ODBC with C++ Builder

Tested with BDE 3.0. The only known problem is that when the table schema changes, query fields are not updated. BDE, however, does not seem to recognize primary keys, only the index named `PRIMARY`, although this has not been a problem.

#### 20.1.7.2.3. Using Connector/ODBC with ColdFusion

The following information is taken from the ColdFusion documentation:

Use the following information to configure ColdFusion Server for Linux to use the `unixODBC` driver with Connector/ODBC for MySQL data sources. You can download Connector/ODBC at <http://dev.mysql.com/downloads/connector/odbc/>.

ColdFusion version 4.5.1 allows you to use the ColdFusion Administrator to add the MySQL data source. However, the driver is not included with ColdFusion version 4.5.1. Before the MySQL driver appears in the ODBC data sources drop-down list, you must build and copy the Connector/ODBC driver to `/opt/coldfusion/lib/libmyodbc.so`.

The Contrib directory contains the program `mysdn-xxx.zip` which allows you to build and remove the DSN registry file for the Connector/ODBC driver on ColdFusion applications.

For more information and guides on using ColdFusion and Connector/ODBC, see the following external sites:

- [Troubleshooting Data Sources and Database Connectivity for Unix Platforms](#).

#### 20.1.7.2.4. Using Connector/ODBC with OpenOffice.org

Open Office (<http://www.openoffice.org>) [How-to: MySQL + OpenOffice](#). [How-to: OpenOffice + MyODBC + unixODBC](#).

### 20.1.7.2.5. Using Connector/ODBC with Sambar Server

Sambar Server (<http://www.sambarserver.info>) [How-to: MyODBC + SambarServer + MySQL](#).

### 20.1.7.2.6. Using Connector/ODBC with Pervasive Software DataJunction

You have to change it to output `VARCHAR` rather than `ENUM`, as it exports the latter in a manner that causes MySQL problems.

### 20.1.7.2.7. Using Connector/ODBC with SunSystems Vision

You should select the `Return matching rows` option.

## 20.1.7.3. Connector/ODBC Errors and Resolutions (FAQ)

The following section details some common errors and their suggested fix or alternative solution. If you are still experiencing problems, use the Connector/ODBC mailing list; see [Section 20.1.8.1, “Connector/ODBC Community Support”](#).

Many problems can be resolved by upgrading your Connector/ODBC drivers to the latest available release. On Windows, you should also make sure that you have the latest versions of the Microsoft Data Access Components (MDAC) installed.

### Questions

- [20.1.7.3.1](#): I have installed Connector/ODBC on Windows XP x64 Edition or Windows Server 2003 R2 x64. The installation completed successfully, but the Connector/ODBC driver does not appear in `ODBC Data Source Administrator`.
- [20.1.7.3.2](#): When connecting or using the TEST button in `ODBC Data Source Administrator` I get error 10061 (Cannot connect to server)
- [20.1.7.3.3](#): The following error is reported when using transactions: `Transactions are not enabled`
- [20.1.7.3.4](#): Access reports records as `#DELETED#` when inserting or updating records in linked tables.
- [20.1.7.3.5](#): How do I handle Write Conflicts or Row Location errors?
- [20.1.7.3.6](#): Exporting data from Access 97 to MySQL reports a `Syntax Error`.
- [20.1.7.3.7](#): Exporting data from Microsoft DTS to MySQL reports a `Syntax Error`.
- [20.1.7.3.8](#): Using ODBC.NET with Connector/ODBC, while fetching empty string (0 length), it starts giving the `SQL_NO_DATA` exception.
- [20.1.7.3.9](#): Using `SELECT COUNT(*) FROM tbl_name` within Visual Basic and ASP returns an error.
- [20.1.7.3.10](#): Using the `AppendChunk()` or `GetChunk()` ADO methods, the `Multiple-step operation generated errors. Check each status value` error is returned.
- [20.1.7.3.11](#): Access Returns `Another user had modified the record that you have modified while editing records on a Linked Table`.
- [20.1.7.3.12](#): When linking an application directly to the Connector/ODBC library under Unix/Linux, the application crashes.
- [20.1.7.3.13](#): Applications in the Microsoft Office suite are unable to update tables that have `DATE` or `TIMESTAMP` columns.
- [20.1.7.3.14](#): When connecting Connector/ODBC 5.x (Beta) to a MySQL 4.x server, the error `1044 Access denied for user 'xxx'@'%' to database 'information_schema'` is returned.
- [20.1.7.3.15](#): When calling `SQLTables`, the error `S1T00` is returned, but I cannot find this in the list of error numbers for Connector/ODBC.
- [20.1.7.3.16](#): When linking to tables in Access 2000 and generating links to tables programmatically, rather than through the table designer interface, you may get errors about tables not existing.
- [20.1.7.3.17](#): When I try to use batched statements, the execution of the batched statements fails.
- [20.1.7.3.18](#): When connecting to a MySQL server using ADODB and Excel, occasionally the application fails to communicate with the server and the error `Got an error reading communication packets` appears in the error log.
- [20.1.7.3.19](#): When using some applications to access a MySQL server using C/ODBC and outer joins, an error is reported re-

garding the Outer Join Escape Sequence.

- [20.1.7.3.20](#): I can correctly store extended characters in the database (Hebrew/CJK) using C/ODBC 5.1, but when I retrieve the data, the text is not formatted correctly and I get garbled characters.
- [20.1.7.3.21](#): I have a duplicate MySQL Connector/ODBC entry within my **INSTALLED PROGRAMS** list, but I cannot delete one of them.
- [20.1.7.3.22](#): When submitting queries with parameter binding using `UPDATE`, my field values are being truncated to 255 characters.
- [20.1.7.3.23](#): Is it possible to disable data-at-execution using a flag?

## Questions and Answers

### **20.1.7.3.1: I have installed Connector/ODBC on Windows XP x64 Edition or Windows Server 2003 R2 x64. The installation completed successfully, but the Connector/ODBC driver does not appear in ODBC Data Source Administrator.**

This is not a bug, but is related to the way Windows x64 editions operate with the ODBC driver. On Windows x64 editions, the Connector/ODBC driver is installed in the `%SystemRoot%\SysWOW64` folder. However, the default `ODBC Data Source Administrator` that is available through the `Administrative Tools` or `Control Panel` in Windows x64 Editions is located in the `%SystemRoot%\system32` folder, and only searches this folder for ODBC drivers.

On Windows x64 editions, you should use the ODBC administration tool located at `%SystemRoot%\SysWOW64\odbcad32.exe`, this will correctly locate the installed Connector/ODBC drivers and enable you to create a Connector/ODBC DSN.

This issue was originally reported as [Bug#20301](#).

### **20.1.7.3.2: When connecting or using the TEST button in ODBC Data Source Administrator I get error 10061 (Cannot connect to server)**

This error can be raised by a number of different issues, including server problems, network problems, and firewall and port blocking problems. For more information, see [Section B.1.2.2](#), “Can't connect to [local] MySQL server”.

### **20.1.7.3.3: The following error is reported when using transactions: Transactions are not enabled**

This error indicates that you are trying to use transactions with a MySQL table that does not support transactions. Transactions are supported within MySQL when using the `InnoDB` database engine. In versions of MySQL before MySQL 5.1 you may also use the `BDB` engine.

You should check the following before continuing:

- Verify that your MySQL server supports a transactional database engine. Use `SHOW ENGINES` to obtain a list of the available engine types.
- Verify that the tables you are updating use a transaction database engine.
- Ensure that you have not enabled the `disable transactions` option in your DSN.

### **20.1.7.3.4: Access reports records as #DELETED# when inserting or updating records in linked tables.**

If the inserted or updated records are shown as `#DELETED#` in the access, then:

- If you are using Access 2000, you should get and install the newest (version 2.6 or higher) Microsoft MDAC ([Microsoft Data Access Components](#)) from <http://support.microsoft.com/kb/110093>. This fixes a bug in Access that when you export data to MySQL, the table and column names aren't specified.

You should also get and apply the Microsoft Jet 4.0 Service Pack 5 (SP5) which can be found at <http://support.microsoft.com/default.aspx?scid=kb;EN-US;q239114>. This fixes some cases where columns are marked as `#DELETED#` in Access.

- For all versions of Access, you should enable the Connector/ODBC `Return matching rows` option. For Access 2.0, you should additionally enable the `Simulate ODBC 1.0` option.
- You should have a timestamp in all tables that you want to be able to update.
- You should have a primary key in the table. If not, new or updated rows may show up as `#DELETED#`.

- Use only `DOUBLE` float fields. Access fails when comparing with single-precision floats. The symptom usually is that new or updated rows may show up as `#DELETED#` or that you cannot find or update rows.
- If you are using Connector/ODBC to link to a table that has a `BIGINT` column, the results are displayed as `#DELETED`. The work around solution is:
  - Have one more dummy column with `TIMESTAMP` as the data type.
  - Select the `Change BIGINT columns to INT` option in the connection dialog in ODBC DSN Administrator.
  - Delete the table link from Access and re-create it.

Old records still display as `#DELETED#`, but newly added/updated records are displayed properly.

#### 20.1.7.3.5: How do I handle Write Conflicts or Row Location errors?

If you see the following errors, select the `Return Matching Rows` option in the DSN configuration dialog, or specify `OPTION=2`, as the connection parameter:

```
Write Conflict. Another user has changed your data.
Row cannot be located for updating. Some values may have been changed
since it was last read.
```

#### 20.1.7.3.6: Exporting data from Access 97 to MySQL reports a Syntax Error.

This error is specific to Access 97 and versions of Connector/ODBC earlier than 3.51.02. Update to the latest version of the Connector/ODBC driver to resolve this problem.

#### 20.1.7.3.7: Exporting data from Microsoft DTS to MySQL reports a Syntax Error.

This error occurs only with MySQL tables using the `TEXT` or `VARCHAR` data types. You can fix this error by upgrading your Connector/ODBC driver to version 3.51.02 or higher.

#### 20.1.7.3.8: Using ODBC.NET with Connector/ODBC, while fetching empty string (0 length), it starts giving the SQL\_NO\_DATA exception.

You can get the patch that addresses this problem from <http://support.microsoft.com/default.aspx?scid=kb;EN-US;q319243>.

#### 20.1.7.3.9: Using SELECT COUNT(\*) FROM tbl\_name within Visual Basic and ASP returns an error.

This error occurs because the `COUNT(*)` expression is returning a `BIGINT`, and ADO cannot make sense of a number this big. Select the `Change BIGINT columns to INT` option (option value 16384).

#### 20.1.7.3.10: Using the AppendChunk() or GetChunk() ADO methods, the Multiple-step operation generated errors. Check each status value error is returned.

The `GetChunk()` and `AppendChunk()` methods from ADO doesn't work as expected when the cursor location is specified as `adUseServer`. On the other hand, you can overcome this error by using `adUseClient`.

A simple example can be found from [http://www.dwam.net/iishelp/ado/docs/adomth02\\_4.htm](http://www.dwam.net/iishelp/ado/docs/adomth02_4.htm)

#### 20.1.7.3.11: Access Returns Another user had modified the record that you have modified while editing records on a Linked Table.

In most cases, this can be solved by doing one of the following things:

- Add a primary key for the table if one doesn't exist.
- Add a timestamp column if one doesn't exist.
- Only use double-precision float fields. Some programs may fail when they compare single-precision floats.

If these strategies do not help, you should start by making a log file from the ODBC manager (the log you get when requesting logs from ODBCADMIN) and a Connector/ODBC log to help you figure out why things go wrong. For instructions, see [Section 20.1.4.8, "Getting an ODBC Trace File"](#).

#### 20.1.7.3.12: When linking an application directly to the Connector/ODBC library under Unix/Linux, the application crashes.



Connector/ODBC 3.51 under Unix/Linux is not compatible with direct application linking. You must use a driver manager, such as iODBC or unixODBC to connect to an ODBC source.

**20.1.7.3.13: Applications in the Microsoft Office suite are unable to update tables that have `DATE` or `TIMESTAMP` columns.**

This is a known issue with Connector/ODBC. You must ensure that the field has a default value (rather than `NULL` and that the default value is non-zero (i.e. the default value is not `0000-00-00 00:00:00`).

**20.1.7.3.14: When connecting Connector/ODBC 5.x (Beta) to a MySQL 4.x server, the error `1044 Access denied for user 'xxx'@'%' to database 'information_schema'` is returned.**

Connector/ODBC 5.x is designed to work with MySQL 5.0 or later, taking advantage of the `INFORMATION_SCHEMA` database to determine data definition information. Support for MySQL 4.1 is planned for the final release.

**20.1.7.3.15: When calling `SQLTables`, the error `S1T00` is returned, but I cannot find this in the list of error numbers for Connector/ODBC.**

The `S1T00` error indicates that a general timeout has occurred within the ODBC system and is not a MySQL error. Typically it indicates that the connection you are using is stale, the server is too busy to accept your request or that the server has gone away.

**20.1.7.3.16: When linking to tables in Access 2000 and generating links to tables programmatically, rather than through the table designer interface, you may get errors about tables not existing.**

There is a known issue with a specific version of the `msjet40.dll` that exhibits this issue. The version affected is 4.0.9025.0. Reverting to an older version will enable you to create the links. If you have recently updated your version, check your `WINDOWS` directory for the older version of the file and copy it to the drivers directory.

**20.1.7.3.17: When I try to use batched statements, the execution of the batched statements fails.**

Batched statement support was added in 3.51.18. Support for batched statements is not enabled by default. You must enable option `FLAG_MULTI_STATEMENTS`, value 67108864, or select the `ALLOW MULTIPLE STATEMENTS` flag within a GUI configuration.

**20.1.7.3.18: When connecting to a MySQL server using ADODB and Excel, occasionally the application fails to communicate with the server and the error `Got an error reading communication packets` appears in the error log.**

This error may be related to Keyboard Logger 1.1 from PanteraSoft.com, which is known to interfere with the network communication between MySQL Connector/ODBC and MySQL.

**20.1.7.3.19: When using some applications to access a MySQL server using C/ODBC and outer joins, an error is reported regarding the Outer Join Escape Sequence.**

This is a known issue with MySQL Connector/ODBC which is not correctly parsing the "Outer Join Escape Sequence", as per the specs at [Microsoft ODBC Specs](#). Currently, Connector/ODBC will return value `> 0` when asked for `SQL_OJ_CAPABILITIES` even though no parsing takes place in the driver to handle the outer join escape sequence.

**20.1.7.3.20: I can correctly store extended characters in the database (Hebrew/CJK) using C/ODBC 5.1, but when I retrieve the data, the text is not formatted correctly and I get garbled characters.**

When using ASP and UTF8 characters you should add the following to your ASP files to ensure that the data returned is correctly encoded:

```
Response.CodePage = 65001
Response.CharSet = "utf-8"
```

**20.1.7.3.21: I have a duplicate MySQL Connector/ODBC entry within my INSTALLED PROGRAMS list, but I cannot delete one of them.**

This problem can occur when you upgrade an existing Connector/ODBC installation, rather than removing and then installing the updated version.

### Warning

To fix the problem you should use any working uninstallers to remove existing installations and then may have to edit the contents of the registry. Make sure you have a backup of your registry information before attempting any editing of the registry contents.

**20.1.7.3.22: When submitting queries with parameter binding using `UPDATE`, my field values are being truncated to 255 characters.**

You should ensure that the `FLAG_BIG_PACKETS` option is set for your connection. This removes the 255 character limitation on bound parameters.

### 20.1.7.3.23: Is it possible to disable data-at-execution using a flag?

If you do not wish to use data-at-execution, simply remove the corresponding calls. For example:

```
SQLLEN ylen = SQL_LEN_DATA_AT_EXEC(10);
SQLBindCol(hstmt,2,SQL_C_BINARY, buf, 10, &ylen);
```

Would become:

```
SQLBindCol(hstmt,2,SQL_C_BINARY, buf, 10, NULL);
```

Note that in the call to `SQLBindCol()`, `&ylen` has been replaced by `NULL`.

For further information please refer to the [MSDN documentation](#) for `SQLBindCol()`.

## 20.1.8. Connector/ODBC Support

There are many different places where you can get support for using Connector/ODBC. You should always try the Connector/ODBC Mailing List or Connector/ODBC Forum. See [Section 20.1.8.1, “Connector/ODBC Community Support”](#), for help before reporting a specific bug or issue to MySQL.

### 20.1.8.1. Connector/ODBC Community Support

Sun Microsystems, Inc. provides assistance to the user community by means of its mailing lists. For Connector/ODBC-related issues, you can get help from experienced users by using the `<myodbc@lists.mysql.com>` mailing list. Archives are available online at <http://lists.mysql.com/myodbc>.

For information about subscribing to MySQL mailing lists or to browse list archives, visit <http://lists.mysql.com/>. See [Section 1.5.1, “MySQL Mailing Lists”](#).

Community support from experienced users is also available through the [ODBC Forum](#). You may also find help from other users in the other MySQL Forums, located at <http://forums.mysql.com>. See [Section 1.5.2, “MySQL Community Support at the MySQL Forums”](#).

### 20.1.8.2. How to Report Connector/ODBC Problems or Bugs

If you encounter difficulties or problems with Connector/ODBC, you should start by making a log file from the [ODBC Manager](#) (the log you get when requesting logs from `ODBC ADMIN`) and Connector/ODBC. The procedure for doing this is described in [Section 20.1.4.8, “Getting an ODBC Trace File”](#).

Check the Connector/ODBC trace file to find out what could be wrong. You should be able to determine what statements were issued by searching for the string `>mysql_real_query` in the `myodbc.log` file.

You should also try issuing the statements from the `mysql` client program or from `admindemo`. This helps you determine whether the error is in Connector/ODBC or MySQL.

If you find out something is wrong, please only send the relevant rows (maximum 40 rows) to the `myodbc` mailing list. See [Section 1.5.1, “MySQL Mailing Lists”](#). Please never send the whole Connector/ODBC or ODBC log file!

You should ideally include the following information with the email:

- Operating system and version
- Connector/ODBC version
- ODBC Driver Manager type and version
- MySQL server version
- ODBC trace from Driver Manager
- Connector/ODBC log file from Connector/ODBC driver
- Simple reproducible sample

Remember that the more information you can supply to us, the more likely it is that we can fix the problem!

Also, before posting the bug, check the MyODBC mailing list archive at <http://lists.mysql.com/myodbc>.



If you are unable to find out what is wrong, the last option is to create an archive in `tar` or Zip format that contains a Connector/ODBC trace file, the ODBC log file, and a `README` file that explains the problem. You can send this to <ftp://ftp.mysql.com/pub/mysql/upload/>. Only MySQL engineers have access to the files you upload, and we are very discreet with the data.

If you can create a program that also demonstrates the problem, please include it in the archive as well.

If the program works with another SQL server, you should include an ODBC log file where you perform exactly the same SQL statements so that we can compare the results between the two systems.

Remember that the more information you can supply to us, the more likely it is that we can fix the problem.

### 20.1.8.3. How to Submit a Connector/ODBC Patch

You can send a patch or suggest a better solution for any existing code or problems by sending a mail message to [<myodbc@lists.mysql.com>](mailto:myodbc@lists.mysql.com).

### 20.1.8.4. Connector/ODBC Change History

The Connector/ODBC Change History (Changelog) is located with the main Changelog for MySQL. See [Section C.4, “MySQL Connector/ODBC \(MyODBC\) Change History”](#).

### 20.1.8.5. Credits

These are the developers that have worked on the Connector/ODBC and Connector/ODBC 3.51 Drivers from MySQL AB.

- Michael (Monty) Widenius
- Venu Anuganti
- Peter Harvey

## 20.2. MySQL Connector/NET

Connector/NET enables developers to easily create .NET applications that require secure, high-performance data connectivity with MySQL. It implements the required ADO.NET interfaces and integrates into ADO.NET aware tools. Developers can build applications using their choice of .NET languages. Connector/NET is a fully managed ADO.NET driver written in 100% pure C#.

Connector/NET includes full support for:

- MySQL 6.0 features
- MySQL 5.1 features
- MySQL 5.0 features (such as stored procedures)
- MySQL 4.1 features (server-side prepared statements, Unicode, and shared memory access, and so forth)
- Large-packet support for sending and receiving rows and BLOBs up to 2 gigabytes in size.
- Protocol compression which allows for compressing the data stream between the client and server.
- Support for connecting using TCP/IP sockets, named pipes, or shared memory on Windows.
- Support for connecting using TCP/IP sockets or Unix sockets on Unix.
- Support for the Open Source Mono framework developed by Novell.
- Fully managed, does not utilize the MySQL client library.

This document is intended as a user's guide to Connector/NET and includes a full syntax reference. Syntax information is also included within the [Documentation.chm](#) file included with the Connector/NET distribution.

If you are using MySQL 5.0 or later, and Visual Studio as your development environment, you may want also want to use the MySQL Visual Studio Plugin. The plugin acts as a DDEX (Data Designer Extensibility) provider, enabling you to use the data design tools within Visual Studio to manipulate the schema and objects within a MySQL database. For more information, see [Sec-](#)

tion 20.2.3, “Visual Studio User Guide”.

### Note

Connector/NET 5.1.2 and later include the Visual Studio Plugin by default.

#### Key topics:

- For connection string properties when using the `MySqlConnection` class, see [Section 20.2.4.5, “Connector/NET Connection String Options Reference”](#).

## 20.2.1. Connector/NET Versions

There are several versions of Connector/NET available:

- Connector/NET 1.0 includes support for MySQL 4.0, and MySQL 5.0 features, and full compatibility with the ADO.NET driver interface.
- Connector/NET 5.0 includes support for MySQL 4.0, MySQL 4.1, MySQL 5.0 and MySQL 5.1 features. Connector/NET 5.0 also includes full support for the ADO.Net 2.0 interfaces and subclasses, includes support for the usage advisor and performance monitor (PerfMon) hooks.
- Connector/NET 5.1 includes support for MySQL 4.0, MySQL 5.0, MySQL 5.1 and MySQL 6.0 (Falcon Preview) features. Connector/NET 5.1 also includes support for a new membership/role provider, Compact Framework 2.0, a new stored procedure parser and improvements to `GetSchema`. Connector/NET 5.1 also includes the Visual Studio Plugin as a standard installable component.
- Connector/NET 5.2 includes support for MySQL 4.0, MySQL 5.0, MySQL 5.1 and MySQL 6.0 (Falcon Preview) features. Connector/NET 5.2 also includes support for a new membership/role provider, Compact Framework 2.0, a new stored procedure parser and improvements to `GetSchema`. Connector/NET 5.2 also includes the Visual Studio Plugin as a standard installable component.
- Connector/NET 6.0 includes support for MySQL 4.0, MySQL 5.0, MySQL 5.1 and MySQL 6.0. Connector/NET 6.0 is currently available as an Alpha release.

The latest source code for Connector/NET can be downloaded from the MySQL public Subversion server. For further details see [Section 20.2.2.3, “Installing Connector/NET from the source code”](#).

The following table shows the .NET Framework version required, and MySQL Server version supported by Connector/NET:

Connector/NET version	ADO.NET version supported	.NET Framework version required	MySQL Server version supported
1.0	1.x	1.x	4.0, 5.0
5.0	1.x+	1.x+	4.0, 5.0
5.1	1.x+	1.x+	4.0, 5.0, 5.1, 6.0
5.2	1.x+	1.x+	4.0, 5.0, 5.1, 6.0
6.0	2.x+	2.x+	4.0, 5.0, 5.1, 6.0

### Note

Version numbers for MySQL products are formatted as X.X.X. However, Windows tools (Control Panel, properties display) may show the version numbers as XX.XX.XX. For example, the official MySQL formatted version number 5.0.9 may be displayed by Windows tools as 5.00.09. The two versions are the same; only the number display format is different.

## 20.2.2. Connector/NET Installation

Connector/NET runs on any platform that supports the .NET framework. The .NET framework is primarily supported on recent versions of Microsoft Windows, and is supported on Linux through the Open Source Mono framework (see <http://www.mono-project.com>).

Connector/NET is available for download from <http://dev.mysql.com/downloads/connector/net/5.2.html>.

## 20.2.2.1. Installing Connector/NET on Windows

On Windows, installation is supported either through a binary installation process or by downloading a Zip file with the Connector/NET components.

Before installing, you should ensure that your system is up to date, including installing the latest version of the .NET Framework.

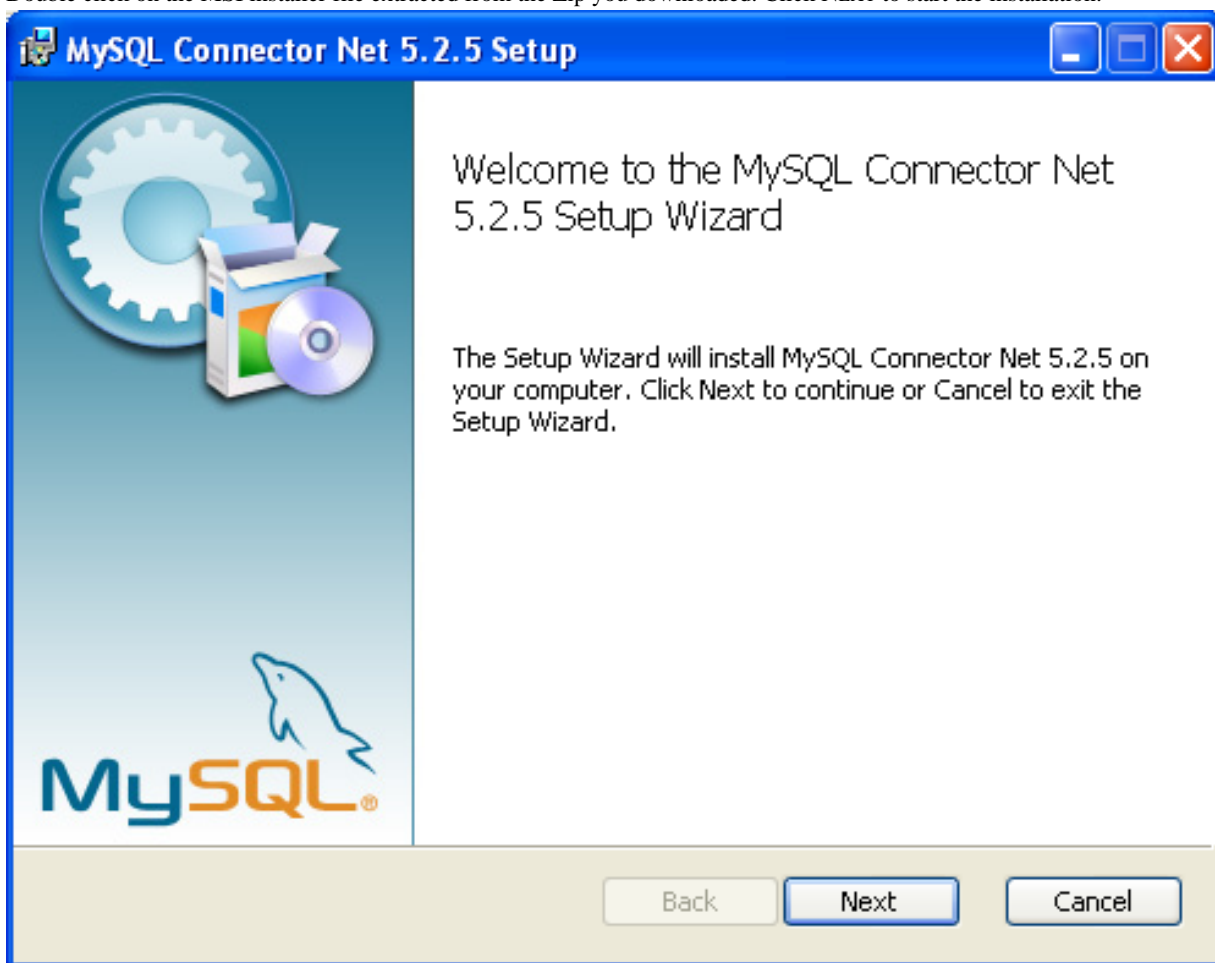
### 20.2.2.1.1. Installing Connector/NET using the Installer

Using the installer is the most straightforward method of installing Connector/NET on Windows and the installed components include the source code, test code and full reference documentation.

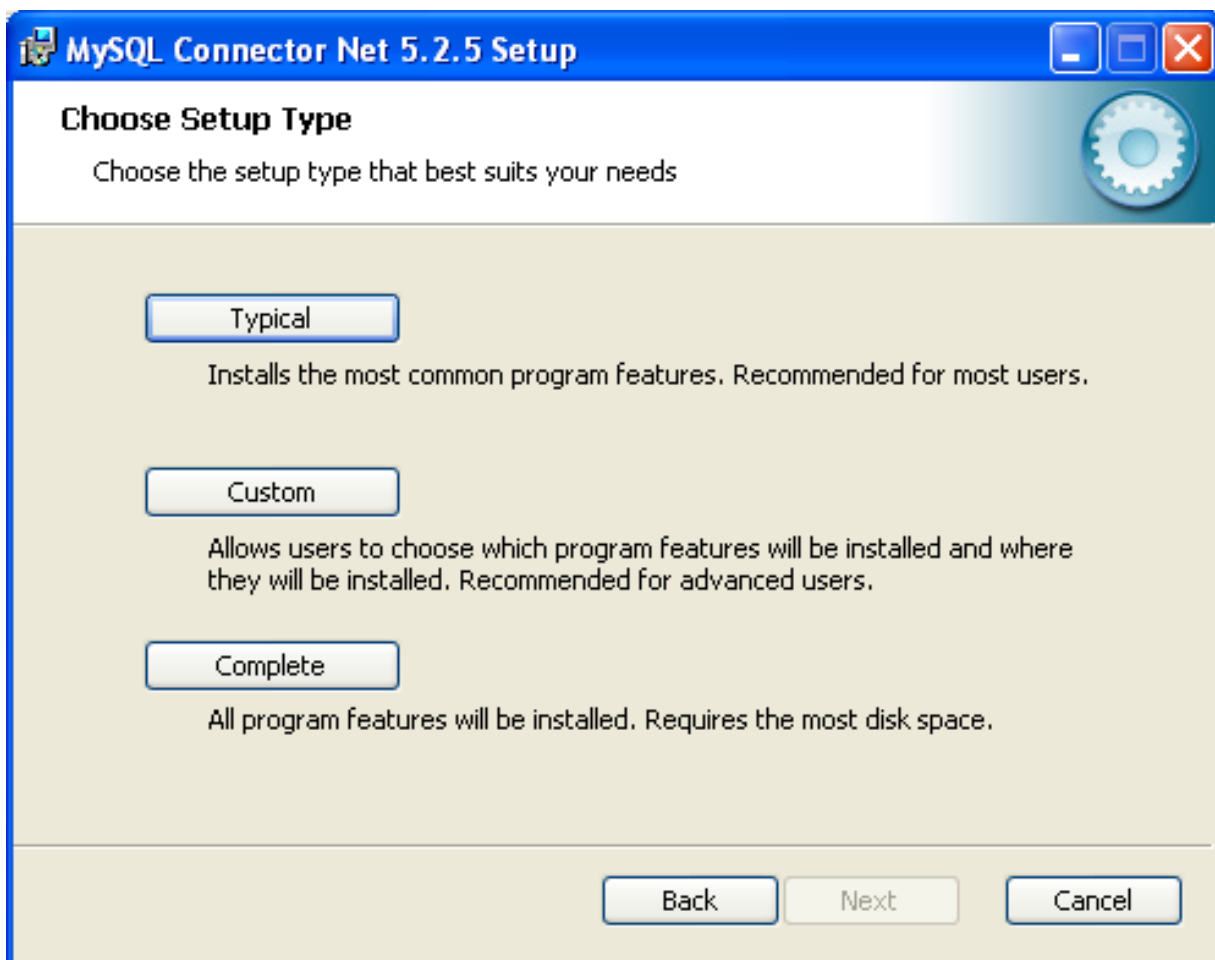
Connector/NET is installed through the use of a Windows Installer (.msi) installation package, which can be used to install Connector/NET on all Windows operating systems. The MSI package is contained within a ZIP archive named `mysql-connector-net-version.zip`, where `version` indicates the Connector/NET version.

To install Connector/NET:

1. Double click on the MSI installer file extracted from the Zip you downloaded. Click NEXT to start the installation.



2. You must choose the type of installation that you want to perform.



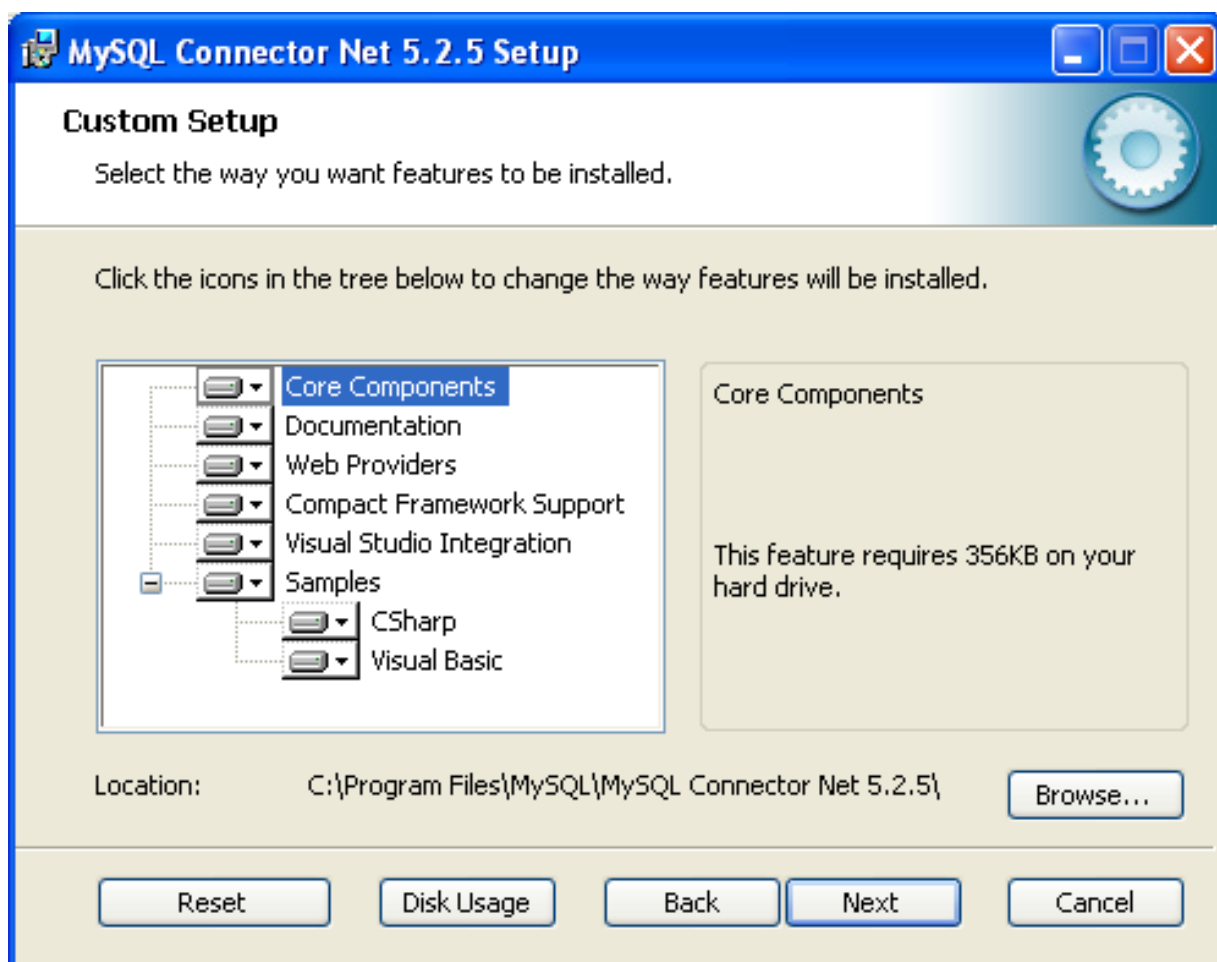
For most situations, the Typical installation will be suitable. Click the TYPICAL button and proceed to Step 5. A Complete installation installs all the available files. To conduct a Complete installation, click the COMPLETE button and proceed to step 5. If you want to customize your installation, including choosing the components to install and some installation options, click the CUSTOM button and proceed to Step 3.

The Connector/NET installer will register the connector within the Global Assembly Cache (GAC) - this will make the Connector/NET component available to all applications, not just those where you explicitly reference the Connector/NET component. The installer will also create the necessary links in the Start menu to the documentation and release notes.

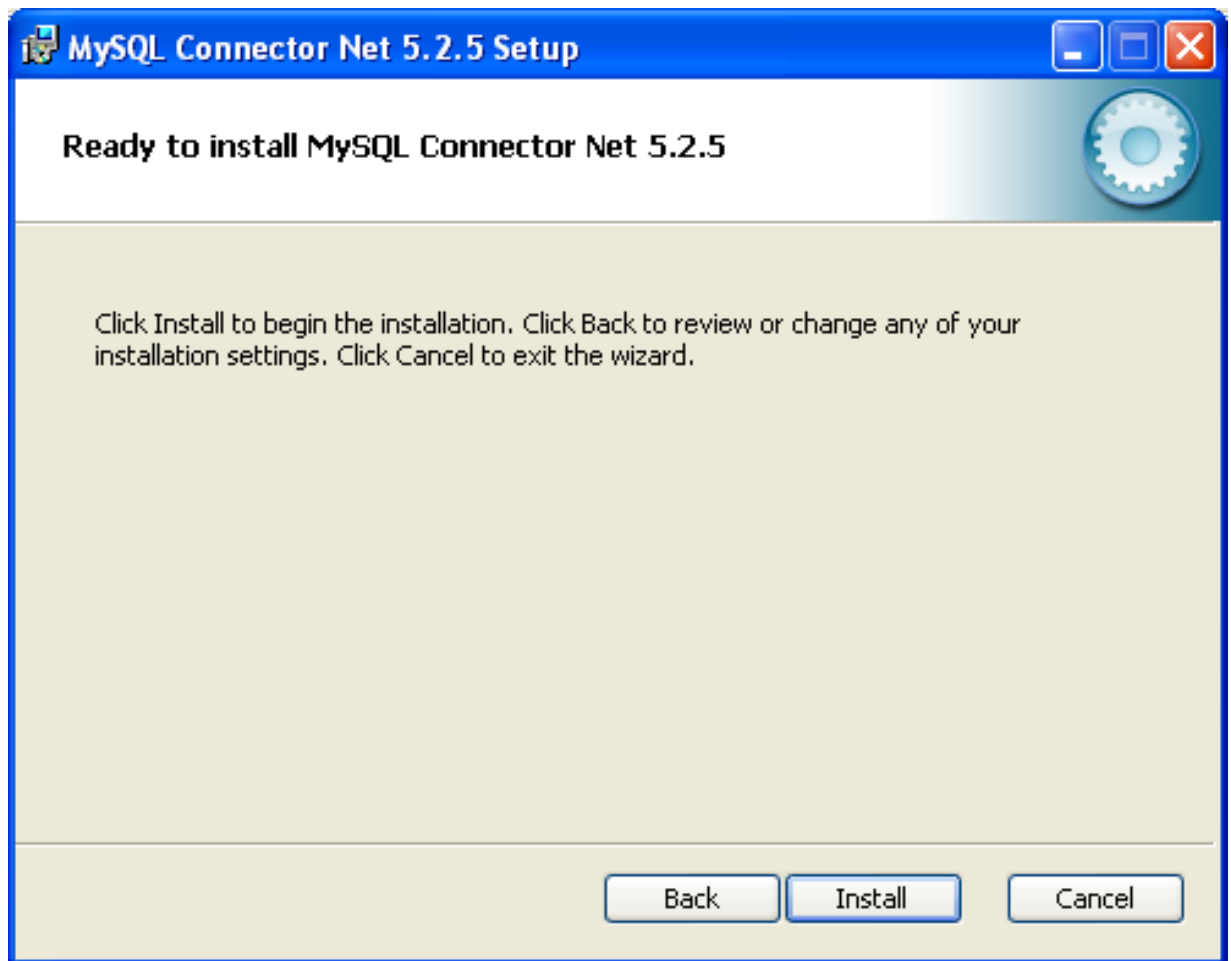
3. If you have chosen a custom installation, you can select the individual components that you want to install, including the core interface component, supporting documentation (a CHM file) samples and examples and the source code. Select the items, and their installation level, and then click NEXT to continue the installation.

#### Note

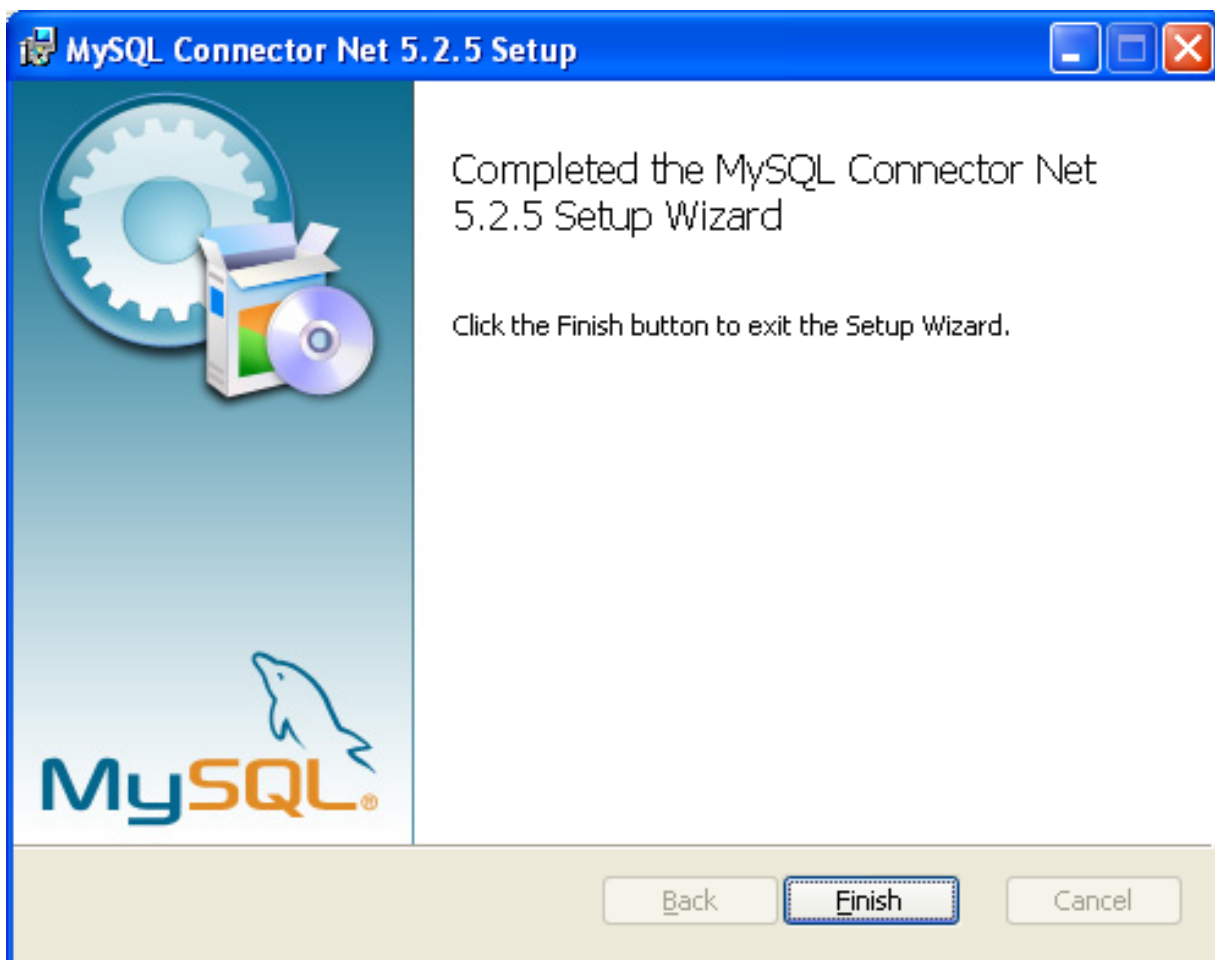
For Connector/NET 1.0.8 or lower and Connector 5.0.4 and lower the installer will attempt to install binaries for both 1.x and 2.x of the .NET Framework. If you only have one version of the framework installed, the connector installation may fail. If this happens, you can choose the framework version to be installed through the custom installation step.



4. You will be given a final opportunity to confirm the installation. Click **INSTALL** to copy and install the files onto your machine.



5. Once the installation has been completed, click FINISH to exit the installer.



Unless you choose otherwise, Connector/NET is installed in `C:\Program Files\MySQL\MySQL Connector Net X.X.X`, where `X.X.X` is replaced with the version of Connector/NET you are installing. New installations do not overwrite existing versions of Connector/NET.

Depending on your installation type, the installed components will include some or all of the following components:

- `bin` - Connector/NET MySQL libraries for different versions of the .NET environment.
- `docs` - contains a CHM of the Connector/NET documentation.
- `samples` - sample code and applications that use the Connector/NET component.
- `src` - the source code for the Connector/NET component.

You may also use the `/quiet` or `/q` command-line option with the `msiexec` tool to install the Connector/NET package automatically (using the default options) with no notification to the user. Using this method the user cannot select options. Additionally, no prompts, messages or dialog boxes will be displayed.

```
C:\> msiexec /package conector-net.msi /quiet
```

To provide a progress bar to the user during automatic installation, use the `/passive` option.

#### 20.2.2.1.2. Installing Connector/NET using the Zip packages

If you are having problems running the installer, you can download a Zip file without an installer as an alternative. That file is called `mysql-connector-net-version-noinstall.zip`. Once downloaded, you can extract the files to a location of your choice.

The file contains the following directories:

- [bin](#) - Connector/NET MySQL libraries for different versions of the .NET environment.
- [Docs](#) - contains a CHM of the Connector/NET documentation.
- [Samples](#) - sample code and applications that use the Connector/NET component.

Connector/NET 6.0.x has a different directory structure:

- [Assemblies](#) - contains a collection of DLLs that make up the connector functionality.
- [Documentation](#) - contains the Connector/NET documentation as a CHM file.
- [Samples](#) - sample code and applications that use the Connector/NET component.

There is also another Zip file available for download called [mysql-connector-net-version-src.zip](#). This file contains the source code distribution.

The file contains the following directories:

- [Documentation](#) - This folder contains the source files to build the documentation into the compiled HTML (CHM) format.
- [Installer](#) - This folder contains the source files to build the Connector/NET installer program.
- [MySQL.Data](#) - This folder contains the source files for the core data provider.
- [MySQL.VisualStudio](#) - This folder contains the source files for the Microsoft Visual Studio extensions.
- [MySQL.Web](#) - This folder contains the source files for the web providers. This includes code for the membership provider, role provider and profile provider. These are used in ASP.NET web sites.
- [Samples](#) - This folder contains the source files for several example applications.
- [Tests](#) - This folder contains a spreadsheet listing test cases.
- [VisualStudio](#) - Contains resources used by the Visual Studio plug in.

Finally, you need to ensure that [MySQL.Data.dll](#) is accessible to your program at build time (and run time). If using Microsoft Visual Studio you will need to add [MySQL.Data](#) as a Reference to your project.

### 20.2.2.2. Installing Connector/NET on Unix with Mono

There is no installer available for installing the Connector/NET component on your Unix installation. Before installing, please ensure that you have a working Mono project installation. You can test whether your system has Mono installed by typing:

```
shell> mono --version
```

The version of the Mono JIT compiler will be displayed.

To compile C# source code you will also need to make sure a Mono C# compiler, is installed. Note that there are two Mono C# compilers available, [mcs](#), which accesses the 1.0-profile libraries, and [gmcs](#), which accesses the 2.0-profile libraries.

To install Connector/NET on Unix/Mono:

1. Download the [mysql-connector-net-version-noinstall.zip](#) and extract the contents to a directory of your choice, for example: [~/connector-net/](#).
2. In the directory where you unzipped the connector to, change into the [bin](#) directory. Ensure the file [MySQL.Data.dll](#) is present.
3. You must register the Connector/NET component, [MySQL.Data](#), in the Global Assembly Cache (GAC). In the current directory enter the [gacutil](#) command:

```
root-shell> gacutil /i MySQL.Data.dll
```

This will register [MySQL.Data](#) into the GAC. You can check this by listing the contents of [/usr/lib/mono/gac](#), where



you will find `MySQL.Data` if the registration has been successful.

You are now ready to compile your application. You must ensure that when you compile your application you include the Connector/NET component using the `-r:` command-line option. For example:

```
shell> gmcsc -r:System.dll -r:System.Data.dll -r:MySQL.Data.dll HelloWorld.cs
```

Note, the assemblies that need to be referenced will depend on the requirements of the application, but applications using Connector/NET will need to provide `-r:MySQL.Data` as a minimum.

You can further check your installation by running the compiled program, for example:

```
shell> mono HelloWorld.exe
```

### 20.2.2.3. Installing Connector/NET from the source code

#### Caution

You should read this section only if you are interested in helping us test our new code. If you just want to get Connector/NET up and running on your system, you should use a standard release distribution.

#### Obtaining the source code

To be able to access the Connector/NET source tree, you must have Subversion installed. Subversion is freely available from <http://subversion.tigris.org/>.

The most recent development source tree is available from our public Subversion trees at <http://dev.mysql.com/tech-resources/sources.html>.

To checkout out the Connector/NET sources, change to the directory where you want the copy of the Connector/NET tree to be stored, then use the following command:

```
shell> svn co http://svn.mysql.com/svnpublic/connector-net
```

Source packages are also available on the downloads page.

#### Building the source code on Windows

The following procedure can be used to build the connector on Microsoft Windows.

- Obtain the source code, either from the Subversion server, or through one of the prepared source code packages.
- Navigate to the root of the source code tree.
- A Microsoft Visual Studio 2005 solution file is available to build the connector, this is called `MySQL-VS2005.sln`. Click on this file to load the solution into Visual Studio.
- Select **BUILD**, **BUILD SOLUTION** from the main menu to build the solution.

#### Building the source code on Unix

Support for building Connector/NET on Mono/Unix is currently not available.

## 20.2.3. Visual Studio User Guide

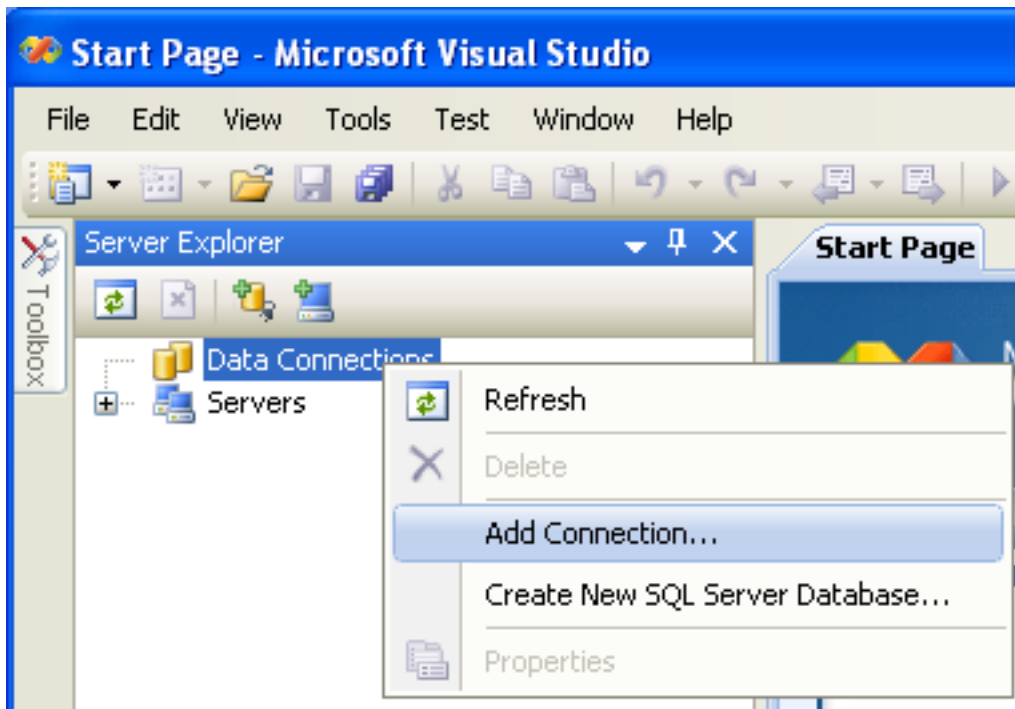
### 20.2.3.1. Making a connection

Once the connector is installed, you can use it to create, modify, and delete connections to MySQL databases. To create a connection with a MySQL database, perform the following steps:

- Start Visual Studio, and open the Server Explorer window (**VIEW**, **SERVER EXPLORER** option in the main Visual Studio menu, or **Ctrl+W, L** hot keys).
- Right-click on the Data Connections node, and choose the **ADD CONNECTION...** menu item.

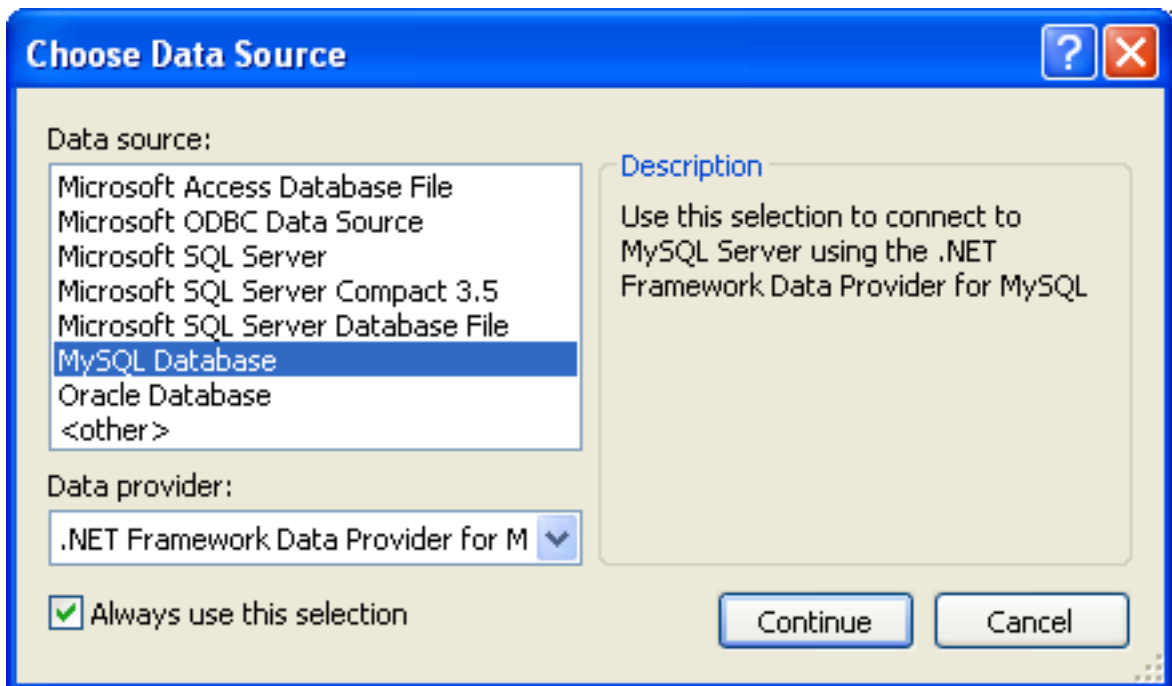
- Add Connection dialog opens. Press the CHANGE button to choose MySQL Database as a data source.

**Figure 20.1. Add Connection Context Menu**

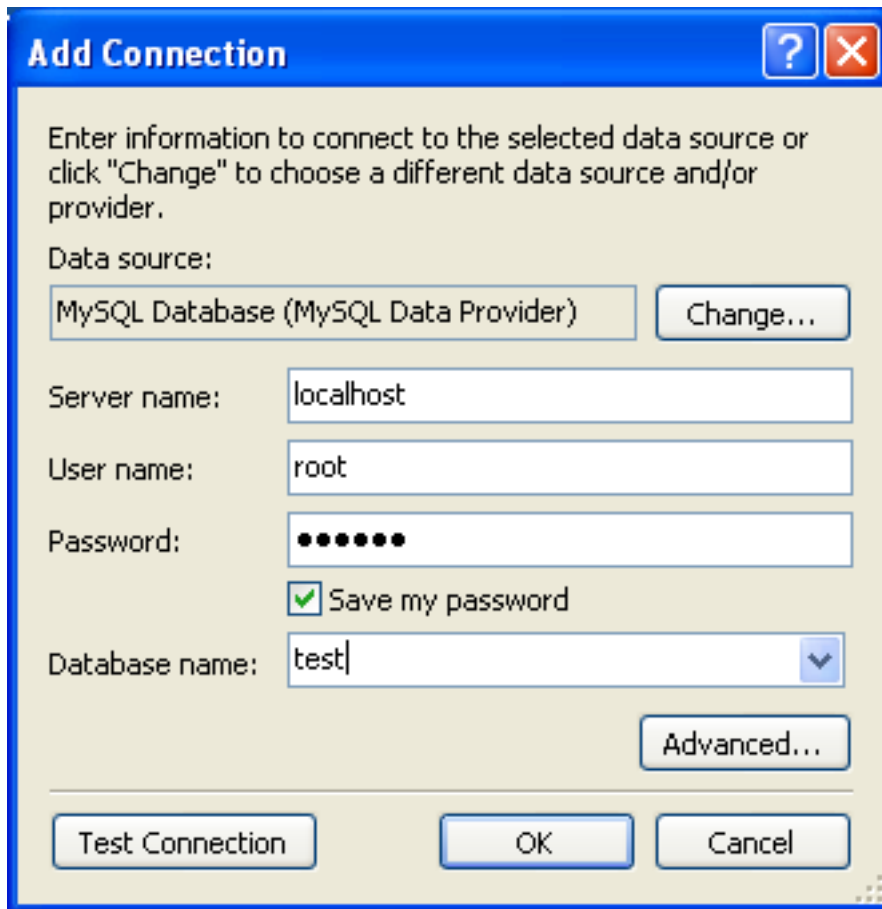


- Change Data Source dialog opens. Choose MySQL Database in the list of data sources (or the <other> option, if MySQL Database is absent), and then choose .NET Framework Data Provider for MySQL in the combo box of data providers.

**Figure 20.2. Choose Data Source**

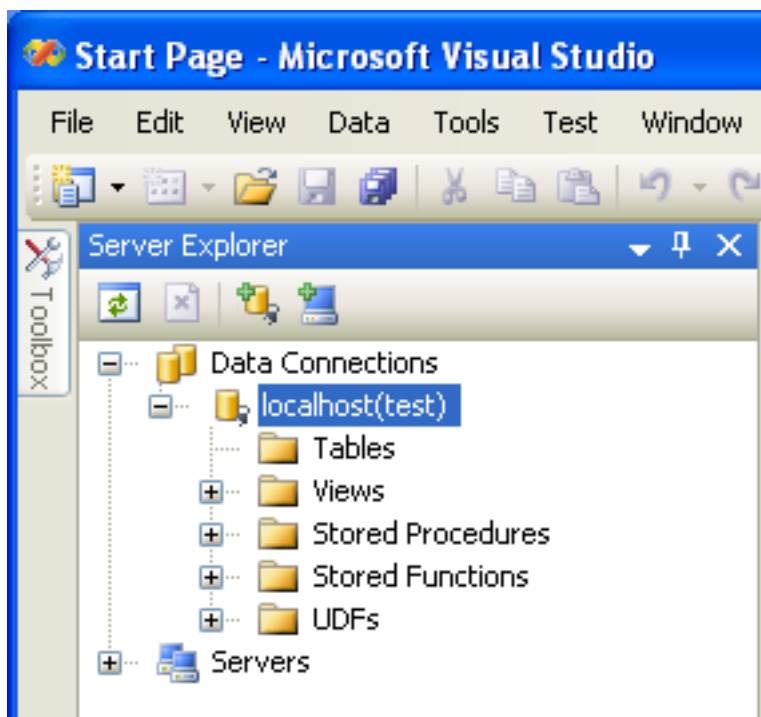


- Input the connection settings: the server host name (for example, localhost if the MySQL server is installed on the local machine), the user name, the password, and the default schema name. Note that you must specify the default schema name to open the connection.

**Figure 20.3. Add Connection Dialog**

- You can also set the port to connect with the MySQL server by pressing the **ADVANCED** button. To test connection with the MySQL server, set the server host name, the user name, and the password, and press the **TEST CONNECTION** button. If the test succeeds, the success confirmation dialog opens.
- After you set all settings and test the connection, press **OK**. The newly created connection is displayed in Server Explorer. Now you can work with the MySQL server through standard Server Explorer GUI.

**Figure 20.4. New Data Connection**



After the connection is successfully established, all settings are saved for future use. When you start Visual Studio for the next time, just open the connection node in Server Explorer to establish a connection to the MySQL server again.

To modify and delete a connection, use the Server Explorer context menu for the corresponding node. You can modify any of the settings just by overwriting the existing values with new ones. Note that the connection may be modified or deleted only if no active editor for its objects is opened: otherwise you may lose your data.

### 20.2.3.2. Editing Tables

Connector/Net contains a table editor, which enables the visual creation and modification of tables.

The Table Designer can be accessed through a mouse action on table-type node of Server Explorer. To create a new table, right-click on the **TABLES** node (under the connection node) and choose the **CREATE TABLE** command from the context menu.

To modify an existing table, double-click on the node of the table you wish to modify, or right-click on this node and choose the **DESIGN** item from the context menu. Either of the commands opens the Table Designer.

The table editor is implemented in the manner of the well-known Query Browser Table Editor, but with minor differences.

**Figure 20.5. Editing New Table**

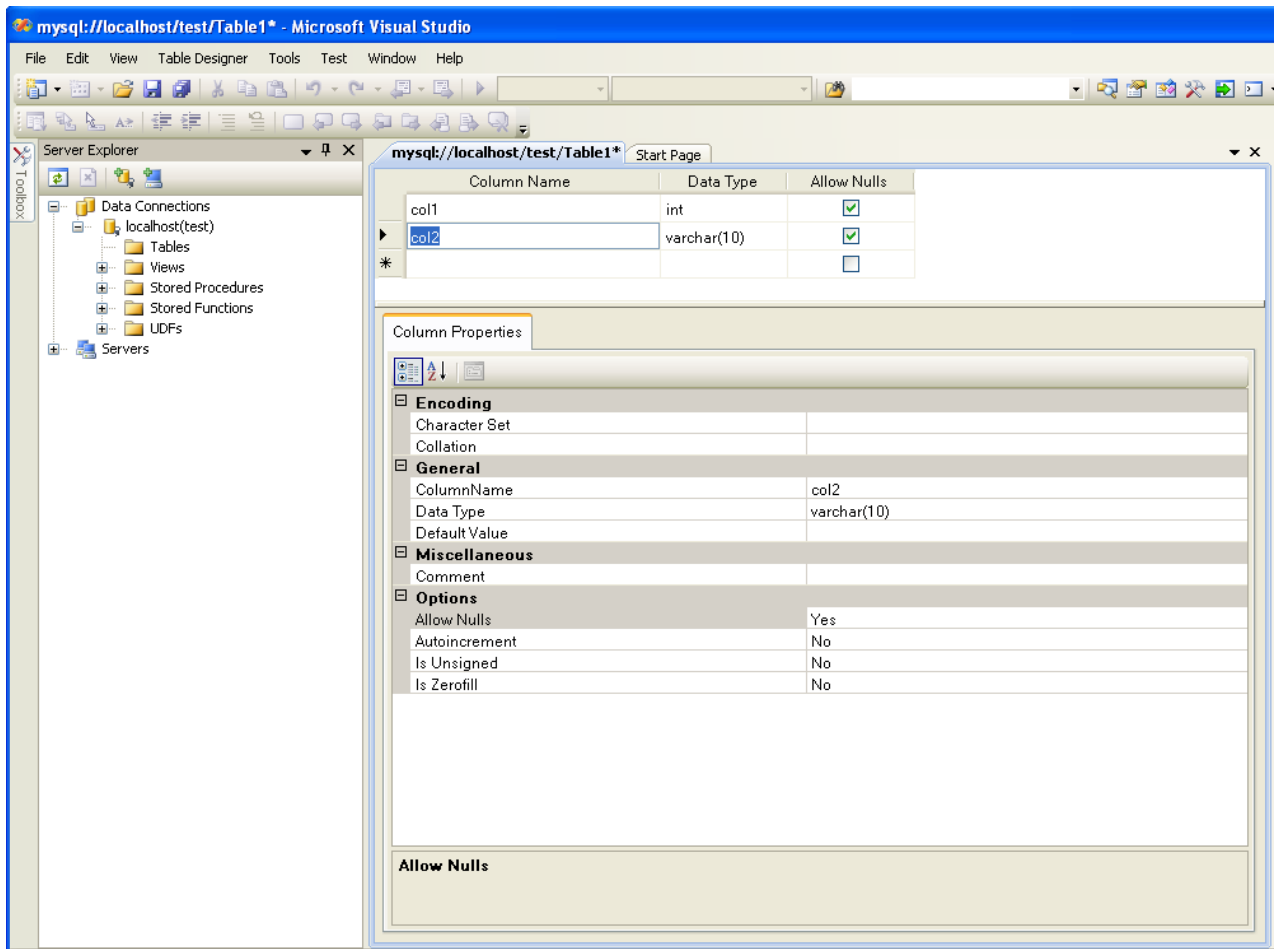


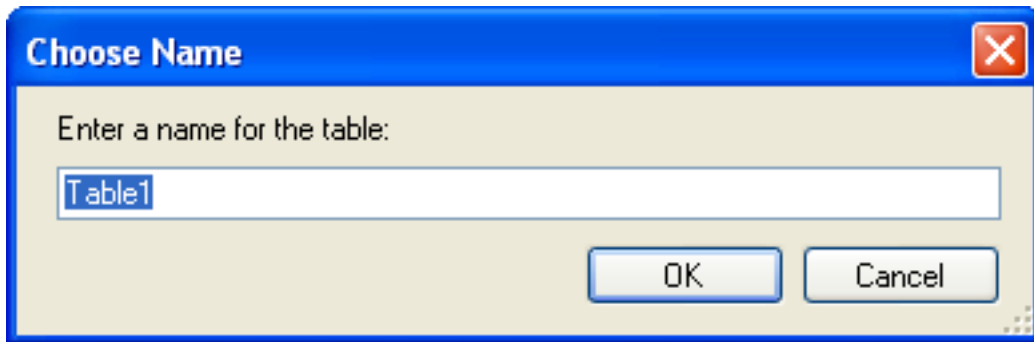
Table Designer consists of the following parts:

- Columns Editor - a data grid on top of the Table Designer. Use the Columns grid for column creation, modification, and deletion.
- Indexes tab - a tab on bottom of the Table Designer. Use the Indexes tab for indexes management.
- Foreign Keys tab - a tab on bottom of the Table Designer. Use the Foreign Keys tab for foreign keys management.
- Column Details tab - a tab on bottom of the Table Designer. Use the Column Details tab to set advanced column options.
- Properties window - a standard Visual Studio Properties window, where the properties of the edited table are displayed. Use the Properties window to set the table properties.

Each of these areas is discussed in more detail in subsequent sections.

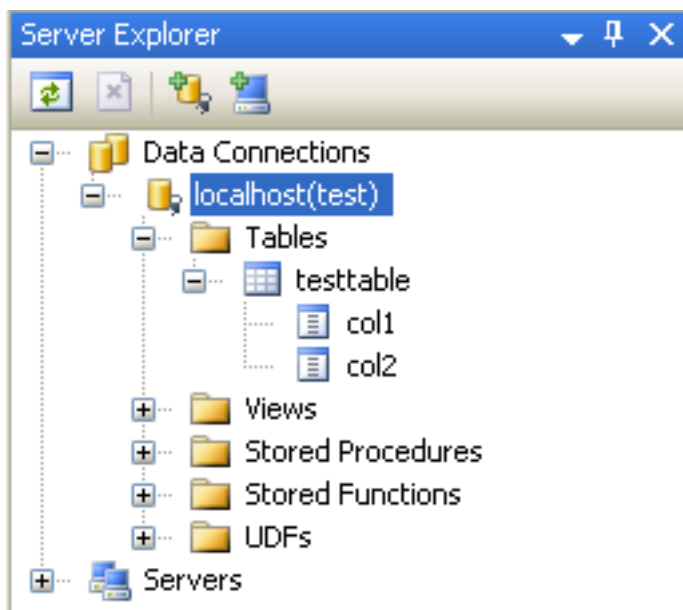
To save changes you have made in the Table Designer, use either SAVE or SAVE ALL button of the Visual Studio main toolbar, or just press **Ctrl+S**. If you have not already named the table you will be prompted to do so.

**Figure 20.6. Choose Table Name**



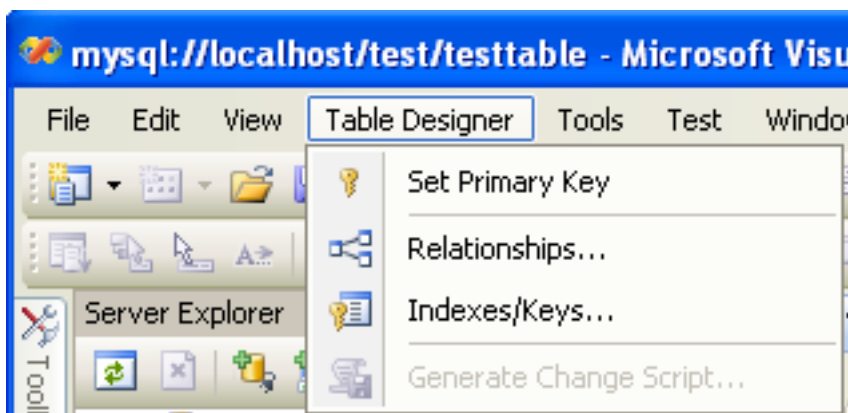
Once created you can view the table in the Server Explorer.

**Figure 20.7. Newly Created Table**



The Table Designer main menu allows you to set a Primary Key column, edit Relationships such as Foreign Keys, and create Indexes.

**Figure 20.8. Table Designer Main Menu**



### 20.2.3.2.1. Column Editor

You can use the Column Editor to set or change the name, data type, default value, and other properties of a table column. To set

the focus to a needed cell of a grid, use the mouse click. Also you can move through the grid using **Tab** and **Shift+Tab** keys.

To set or change the name, data type, default value and comment of a column, activate the appropriate cell and type the desired value.

To set or unset flag-type column properties (**NOT NULL**, auto incremented, flags), check or uncheck the corresponding check boxes. Note that the set of column flags depends on its data type.

To reorder columns, index columns or foreign key columns in the Column Editor, select the whole column you wish to reorder by clicking on the selector column on the left of the column grid. Then move the column by using **Ctrl+Up** (to move the column up) or **Ctrl+Down** (to move the column down) keys.

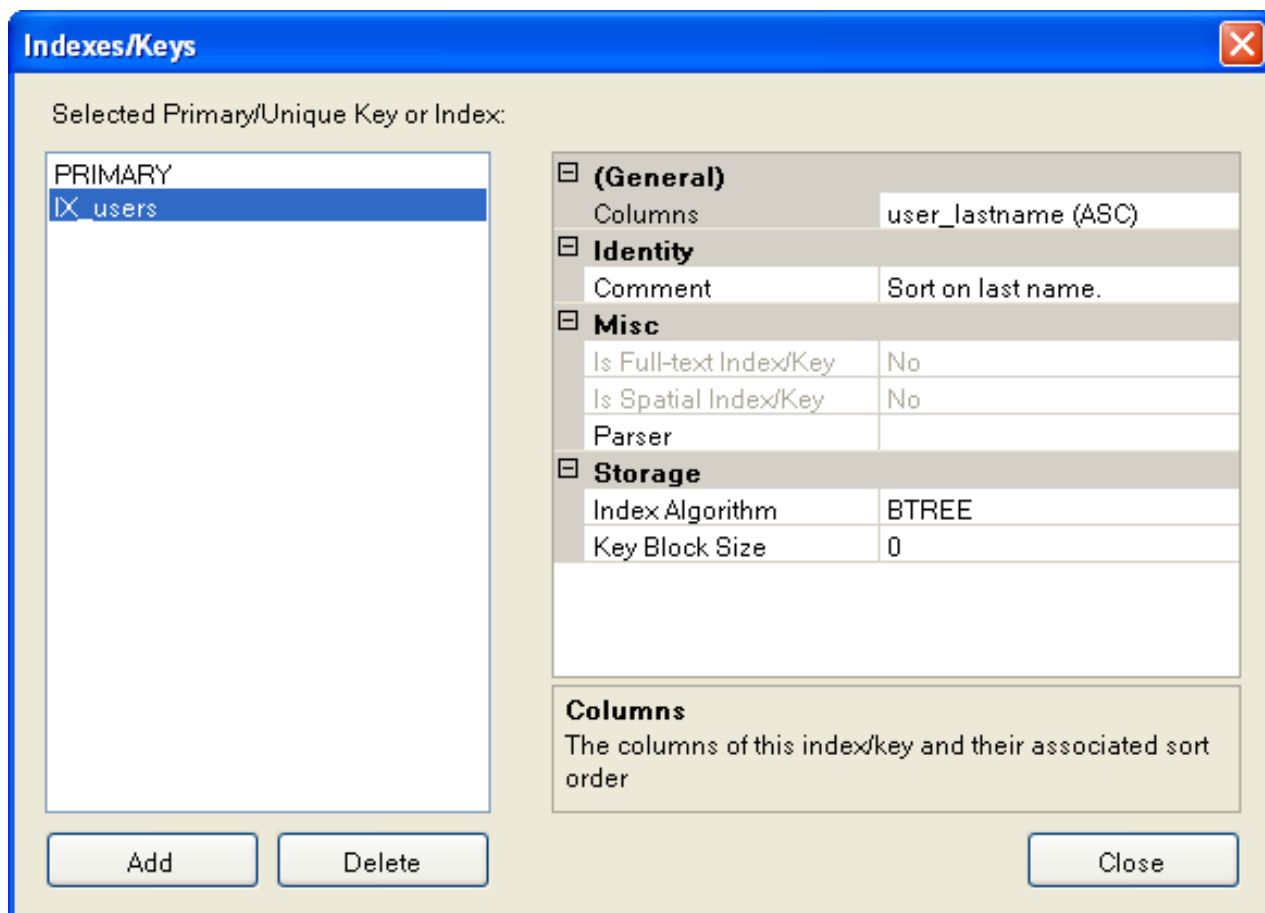
To delete a column, select it by clicking on the selector column on the left of the column grid, then press the **Delete** button on a keyboard.

### 20.2.3.2.2. Editing Indexes

Indexes management is performed via the **INDEXES/KEYS** dialog.

To add an index, select **TABLE DESIGNER, INDEXES/KEYS...** from the main menu, and click **ADD** to add a new index. You can then set the index name, index kind, index type, and a set of index columns.

**Figure 20.9. Indexes Dialog**



To remove an index, select it in the list box on the left, and click the **DELETE** button.

To change index settings, select the needed index in the list box on the left. The detailed information about the index is displayed in the panel on the right hand side. Change the desired values.

### 20.2.3.2.3. Editing Foreign Keys

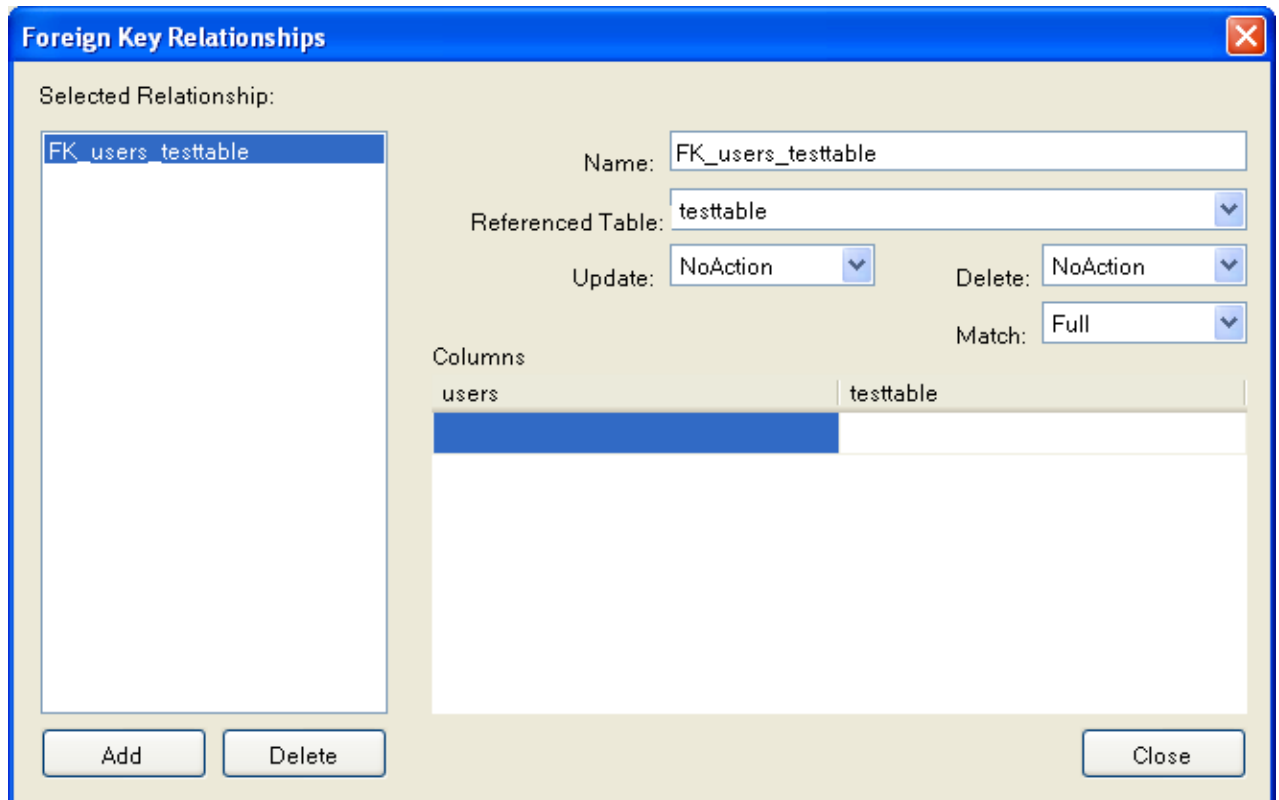
Foreign Keys management is performed via the **FOREIGN KEY RELATIONSHIPS** dialog.

To add a foreign key, select **TABLE DESIGNER, RELATIONSHIPS...** from the main menu. This displays the **FOREIGN KEY RELATIONSHIP** dialog. Click **ADD**. You can then set the foreign key name, referenced table name, foreign key columns, and actions upon update and delete.

To remove a foreign key, select it in the list box on the left, and click the **DELETE** button.

To change foreign key settings, select the required foreign key in the list box on the left. The detailed information about the foreign key is displayed in the right hand panel. Change the desired values.

**Figure 20.10. Foreign Key Relationships Dialog**



#### 20.2.3.2.4. Column Properties

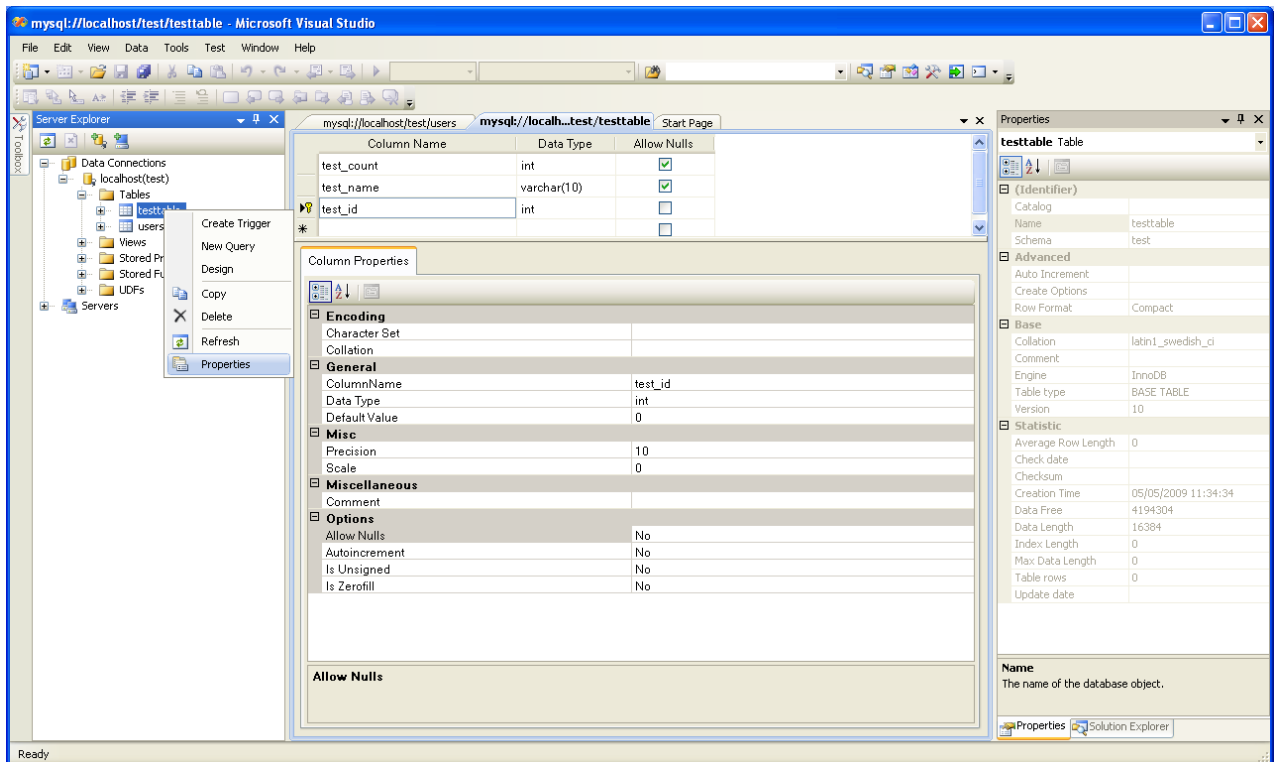
The **COLUMN PROPERTIES** tab can be used to set column options. In addition to the general column properties presented in the Column Editor, in the **COLUMN PROPERTIES** tab you can set additional properties such as Character Set, Collation and Precision.

#### 20.2.3.2.5. Table Properties

To bring up Table Properties select the table and right click to activate the context menu. Select **PROPERTIES**. The **TABLE PROPERTIES** dockable window will be displayed.

**Figure 20.11. Table Properties Menu Item**



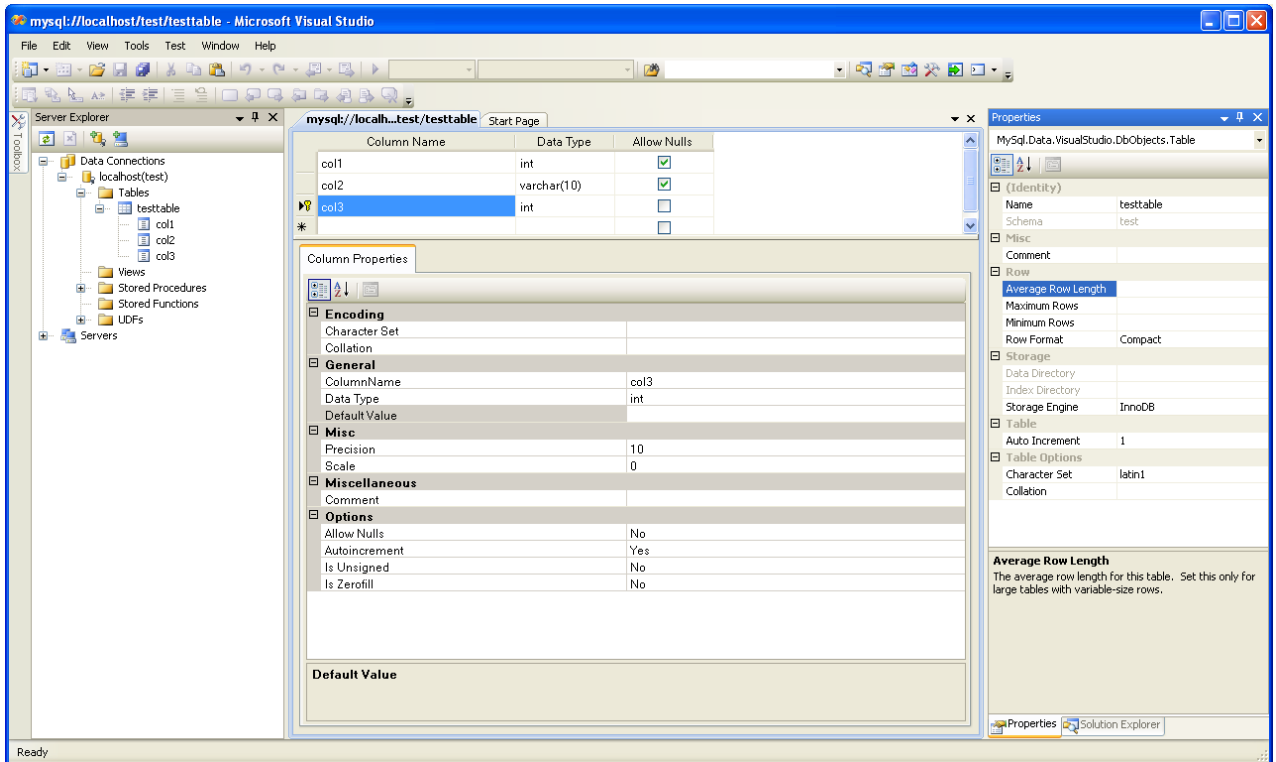


The following table properties can be set:

- Auto Increment
- Average Row Length
- Character Set
- Collation
- Comment
- Data Directory
- Index Directory
- Maximum Rows
- Minimum Rows
- Name
- Row Format
- Schema
- Storage Engine

The property [Schema](#) is read only.

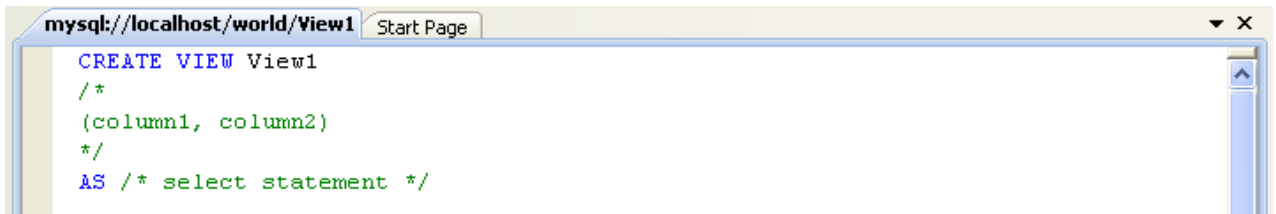
**Figure 20.12. Table Properties**



### 20.2.3.3. Editing Views

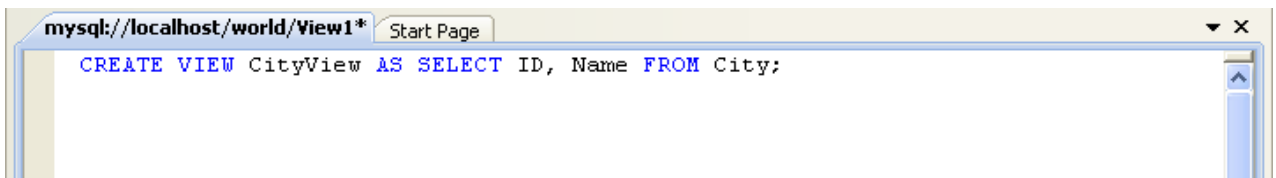
To create a new view, right click the Views node under the connection node in Server Explorer. From the node's context menu, choose the CREATE VIEW command. This command opens the SQL Editor.

**Figure 20.13. Editing View SQL**



You can then enter the SQL for your view.

**Figure 20.14. View SQL Added**



To modify an existing view, double click on a node of the view you wish to modify, or right click on this node and choose the ALTER VIEW command from a context menu. Either of the commands opens the SQL Editor.

All other view properties can be set in the Properties window. These properties are:

- Catalog
- Check Option

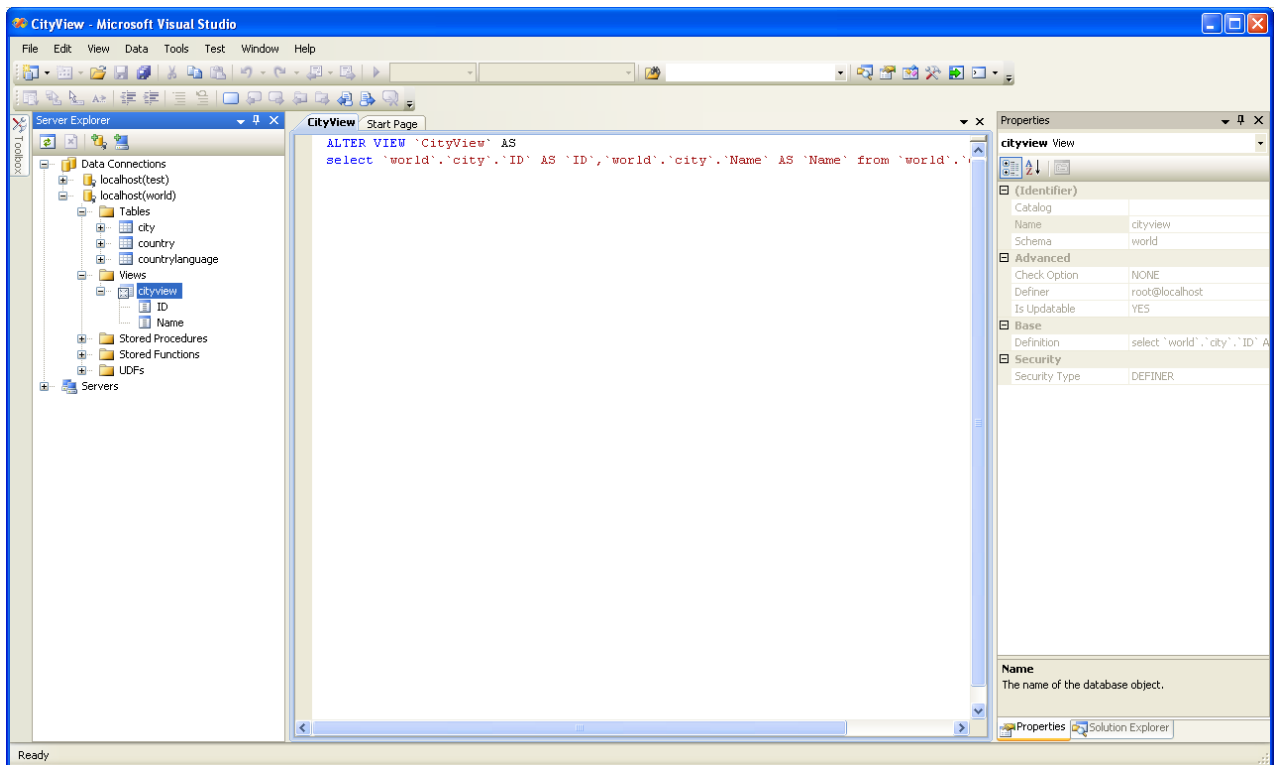
- Definer
- Definition
- Definer
- Is Updatable
- Name
- Schema
- Security Type

Some of these properties can have arbitrary text values, others accept values from a predefined set. In the latter case you set the desired value with an embedded combobox.

The properties `Is Updatable` and `Schema` are readonly.

To save changes you have made, use either `SAVE` or `SAVE ALL` buttons of the Visual Studio main toolbar, or just press `Ctrl+S`.

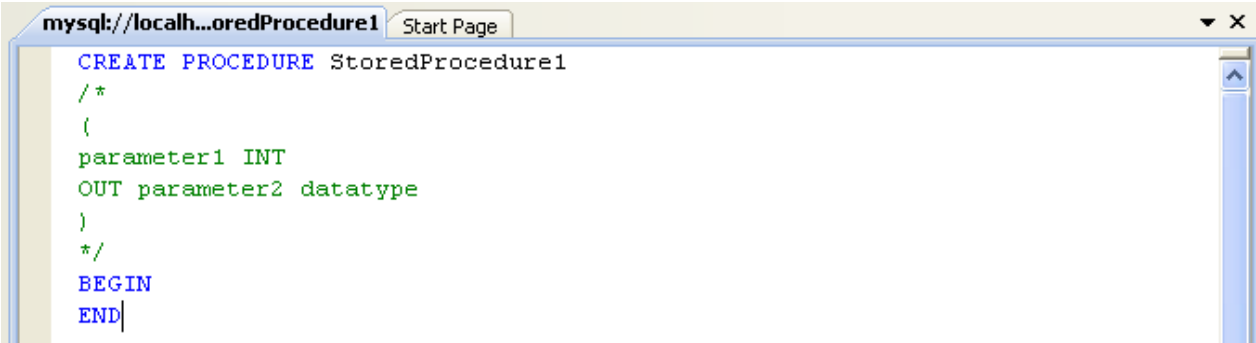
**Figure 20.15. View SQL Saved**



#### 20.2.3.4. Editing Stored Procedures and Functions

To create a new stored procedure, right-click on the **STORED PROCEDURES** node under the connection node in Server Explorer. From the node's context menu, choose the **CREATE ROUTINE** command. This command opens the SQL Editor.

**Figure 20.16. Edit Stored Procedure SQL**



```
mysql://localh...oredProcedure1 Start Page
CREATE PROCEDURE StoredProcedure1
/*
(
parameter1 INT
OUT parameter2 datatype
)
*/
BEGIN
END|
```

To create a new stored function, right-click on the **FUNCTIONS** node under the connection node in Server Explorer. From the node's context menu, choose the **CREATE ROUTINE** command.

To modify an existing stored routine (procedure or function), double-click on the node of the routine you wish to modify, or right-click on this node and choose the **ALTER ROUTINE** command from the context menu. Either of the commands opens the SQL Editor.

To create or alter the routine definition using SQL Editor, type this definition in the SQL Editor using standard SQL. All other routine properties can be set in the Properties window. These properties are:

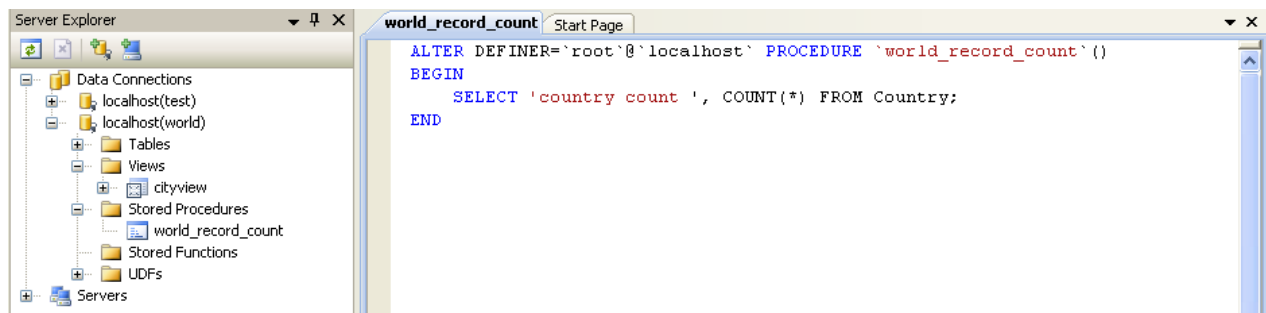
- Body
- Catalog
- Comment
- Creation Time
- Data Access
- Definer
- Definition
- External Name
- External Language
- Is Deterministic
- Last Modified
- Name
- Parameter Style
- Returns
- Schema
- Security Type
- Specific Name
- SQL Mode
- SQL Path
- Type

Some of these properties can have arbitrary text values, others accept values from a predefined set. In the latter case set the desired value using the embedded combo box.

You can also set all the options directly in the SQL Editor, using the standard **CREATE PROCEDURE** or **CREATE FUNCTION** statement. However, it is recommended to use the Properties window instead.

To save changes you have made, use either **SAVE** or **SAVE ALL** buttons of the Visual Studio main toolbar, or just press **Ctrl+S**.

**Figure 20.17. Stored Procedure SQL Saved**



### 20.2.3.5. Editing Triggers

To create a new trigger, right-click on the node of the table, for which you wish to add a trigger. From the node's context menu, choose the **CREATE TRIGGER** command. This command opens the SQL Editor.

To modify an existing trigger, double-click on the node of the trigger you wish to modify, or right-click on this node and choose the **ALTER TRIGGER** command from the context menu. Either of the commands opens the SQL Editor.

To create or alter the trigger definition using SQL Editor, type the trigger statement in the SQL Editor using standard SQL.

#### Note

You should enter only the trigger statement, that is, the part of the **CREATE TRIGGER** query that is placed after the **FOR EACH ROW** clause.

All other trigger properties are set in the Properties window. These properties are:

- Definer
- Event Manipulation
- Name
- Timing

Some of these properties can have arbitrary text values, others accept values from a predefined set. In the latter case set the desired value using the embedded combo box.

The properties **Event Table**, **Schema**, and **Server** in the Properties window are read only.

To save changes you have made, use either **SAVE** or **SAVE ALL** buttons of the Visual Studio main toolbar, or just press **Ctrl+S**. Before changes are saved, you will be asked to confirm the execution of the corresponding SQL query in a confirmation dialog.

### 20.2.3.6. Editing User Defined Functions (UDF)

To create a new User Defined Function (UDF), right-click on the **UDFS** node under the connection node in Server Explorer. From the node's context menu, choose the **CREATE UDF** command. This command opens the UDF Editor.

To modify an existing UDF, double-click on the node of the UDF you wish to modify, or right-click on this node and choose the **ALTER UDF** command from the context menu. Either of the commands opens the UDF Editor.

The UDF editor allows you to set the following properties:

- Name
- So-name (DLL name)
- Return type

- Is Aggregate

There are text fields for both names, a combo box for the return type, and a check box to indicate if the UDF is aggregate. All these options are also accessible via the Properties window.

The property `Server` in the Properties window is read only.

To save changes you have made, use either `SAVE` or `SAVE ALL` buttons of the Visual Studio main toolbar, or just press **Ctrl+S**. Before changes are saved, you will be asked to confirm the execution of the corresponding SQL query in a confirmation dialog.

### 20.2.3.7. Cloning Database Objects

Tables, views, stored procedures, and functions can be cloned using the appropriate Clone command from the context menu: `CLONE TABLE`, `CLONE VIEW`, `CLONE ROUTINE`. The clone commands open the corresponding editor for a new object: the `TABLE EDITOR` for cloning a table, and the `SQL EDITOR` for cloning a view or a routine.

The editor is filled with values of the original object. You can modify these values in a usual manner.

To save the cloned object, use either `Save` or `Save All` buttons of the Visual Studio main toolbar, or just press **Ctrl+S**. Before changes are saved, you will be asked to confirm the execution of the corresponding SQL query in a confirmation dialog.

### 20.2.3.8. Dropping Database Objects

Tables, views, stored routines, triggers, and UDFs can be dropped with the appropriate Drop command selected from its context menu: `DROP TABLE`, `DROP VIEW`, `DROP ROUTINE`, `DROP TRIGGER`, `DROP UDF`.

You will be asked to confirm the execution of the corresponding drop query in a confirmation dialog.

Dropping of multiple objects is not supported.

### 20.2.3.9. Using the ADO.NET Entity Framework

Connector/NET 6.0 introduced support for the ADO.NET Entity Framework. ADO.NET Entity Framework was included with .NET Framework 3.5 Service Pack 1, and Visual Studio 2008 Service Pack 1. ADO.NET Entity Framework was released on 11th August 2008.

ADO.NET Entity Framework provides an Object Relational Mapping (ORM) service, mapping the relational database schema to objects. The ADO.NET Entity Framework defines several layers, these can be summarized as:

- **Logical** - this layer defines the relational data and is defined by the Store Schema Definition Language (SSDL).
- **Conceptual** - this layer defines the .NET classes and is defined by the Conceptual Schema Definition Language (CSDL)
- **Mapping** - this layer defines the mapping from .NET classes to relational tables and associations, and is defined by Mapping Specification Language (MSL).

Connector/NET integrates with Visual Studio 2008 to provide a range of helpful tools to assist the developer.

A full treatment of ADO.NET Entity Framework is beyond the scope of this manual. You are encouraged to review the [Microsoft ADO.NET Entity Framework documentation](#).

#### 20.2.3.9.1. Tutorial: Using an Entity Framework Entity as a Windows Forms Data Source

In this tutorial you will learn how to create a Windows Forms Data Source from an Entity in an Entity Data Model. This tutorial assumes that you have installed the World example database, which can be downloaded from the [MySQL Documentation page](#). You can also find details on how to install the database on the same page. It will also be convenient for you to create a connection to the World database after it is installed. For instructions on how to do this see [Section 20.2.3.1, "Making a connection"](#).

##### Creating a new Windows Forms application

The first step is to create a new Windows Forms application.

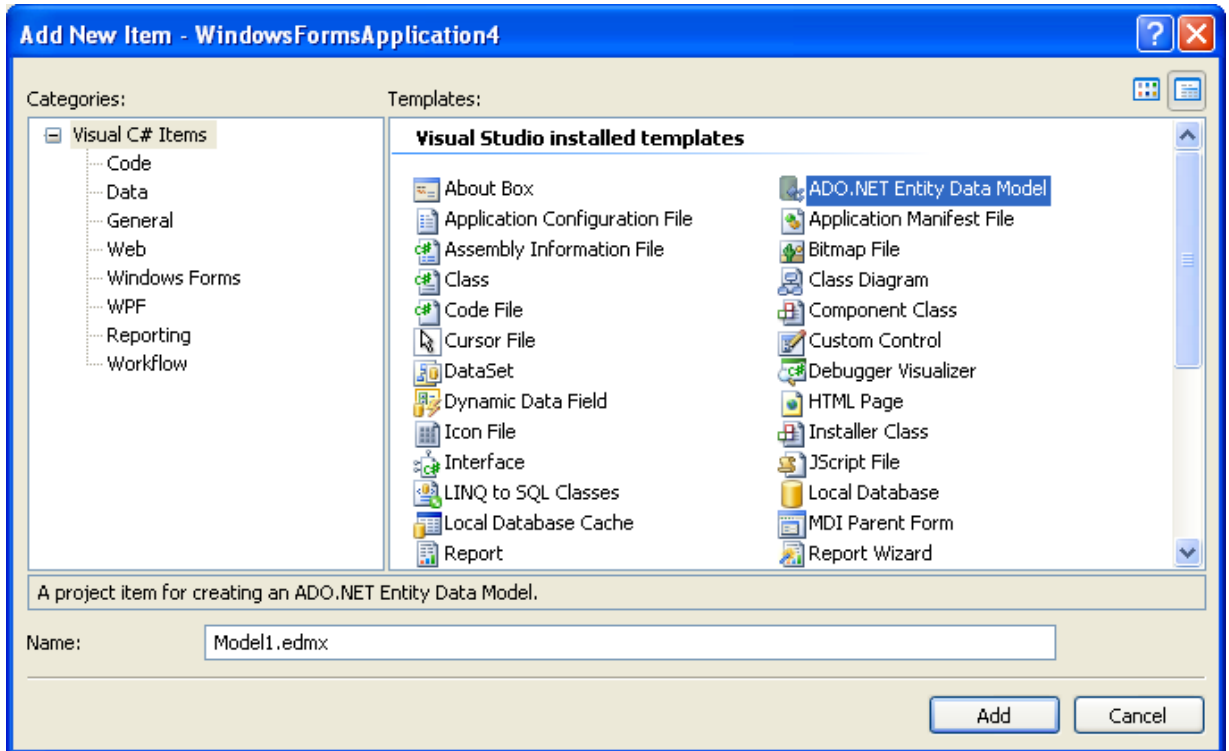
1. In Visual Studio, select `FILE`, `NEW`, `PROJECT` from the main menu.
2. Choose the `WINDOWS FORMS APPLICATION` installed template. Click `OK`. The solution is created.

### Adding an Entity Data Model

You will now add an Entity Data Model to your solution.

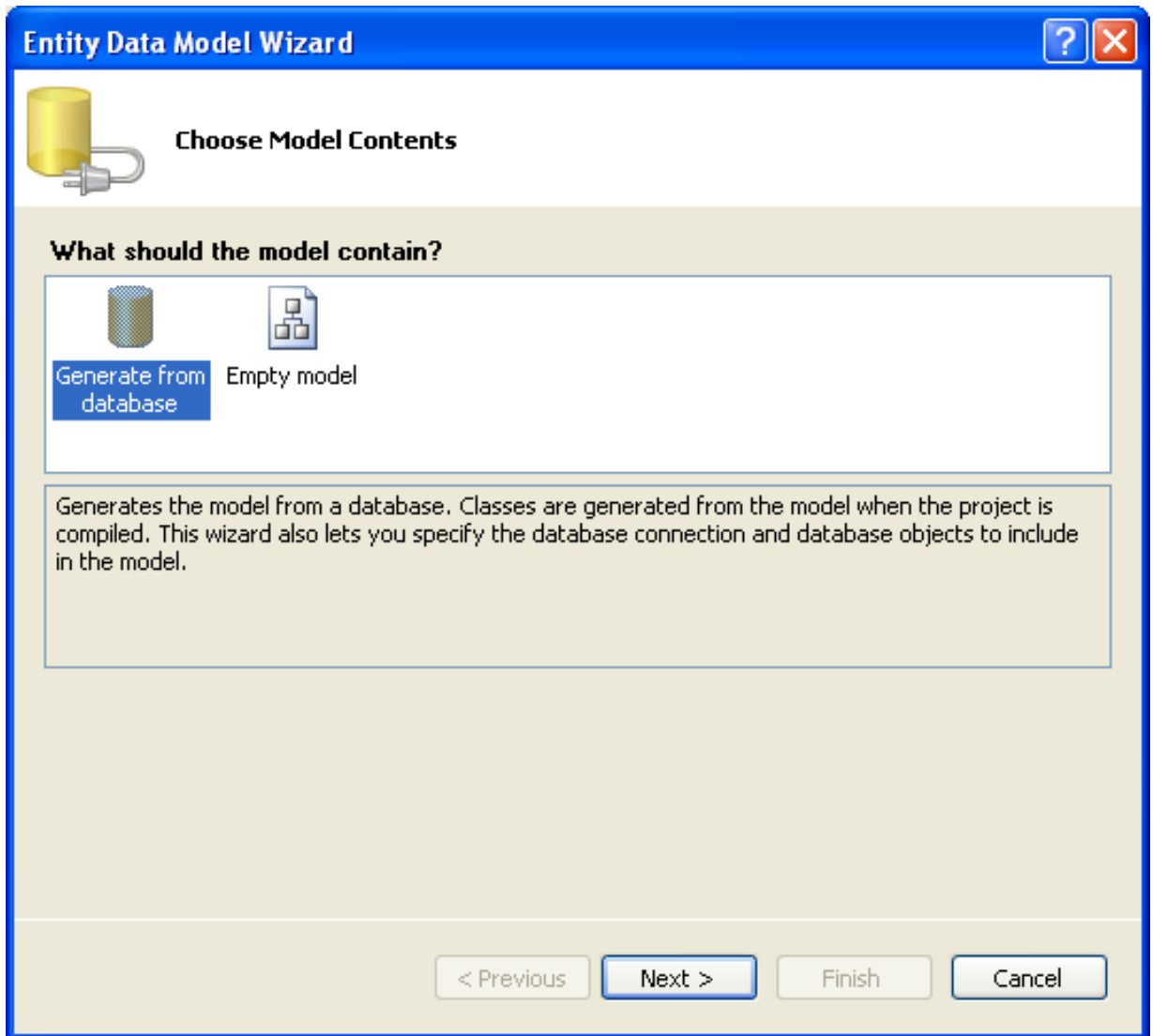
1. In the Solution Explorer, right click on your application and select **ADD, NEW ITEM...**. From **VISUAL STUDIO INSTALLED TEMPLATES** select **ADO.NET ENTITY DATA MODEL**. Click **ADD**.

**Figure 20.18. Add Entity Data Model**



2. You will now see the Entity Data Model Wizard. You will use the wizard to generate the Entity Data Model from the world example database. Select the icon **GENERATE FROM DATABASE**. Click **NEXT**.

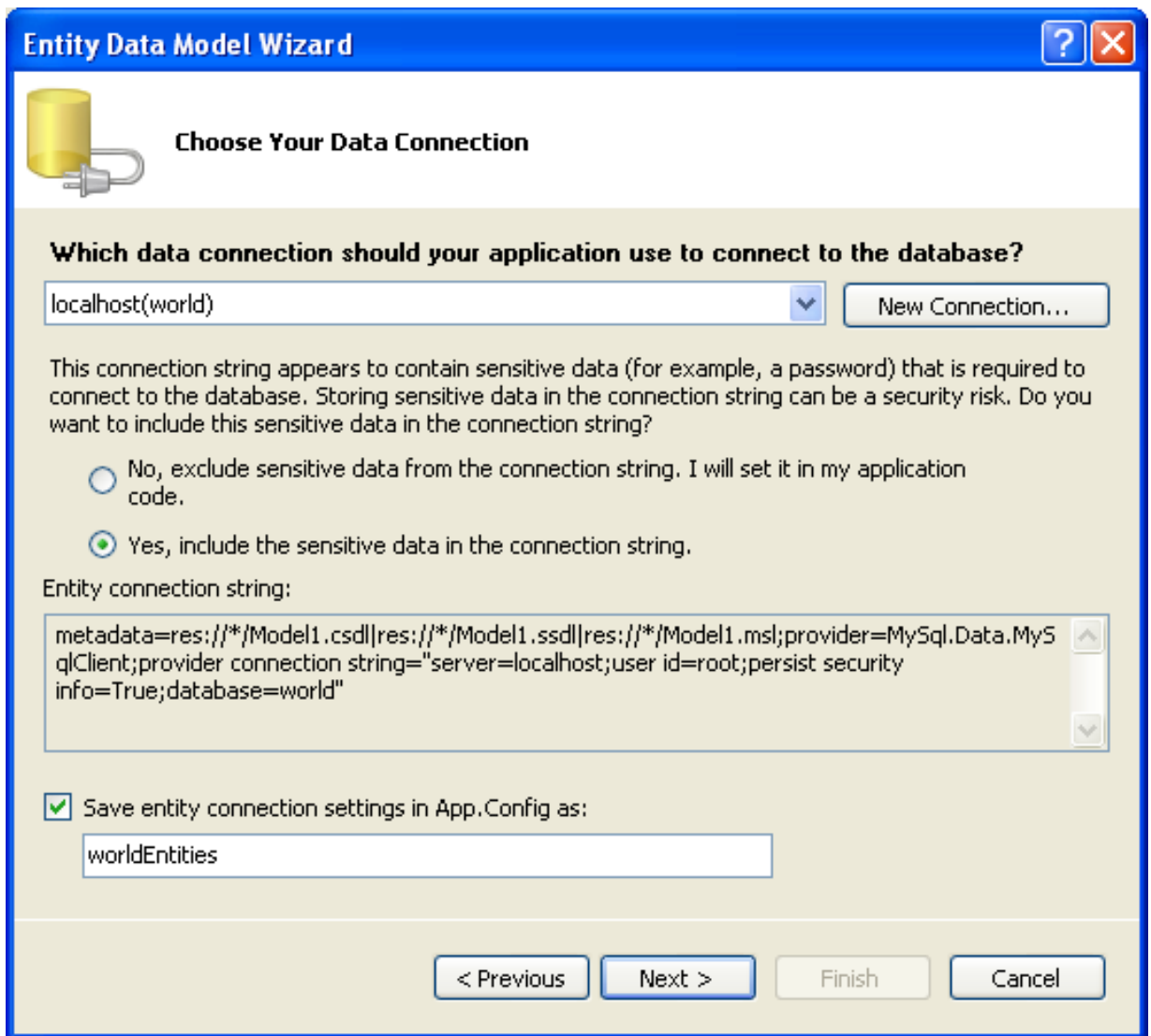
**Figure 20.19. Entity Data Model Wizard Screen 1**



3. You can now select the connection you made earlier to the World database. If you have not already done so, you can create the new connection at this time by clicking on NEW CONNECTION.... For further instructions on creating a connection to a database see [Section 20.2.3.1, "Making a connection"](#).

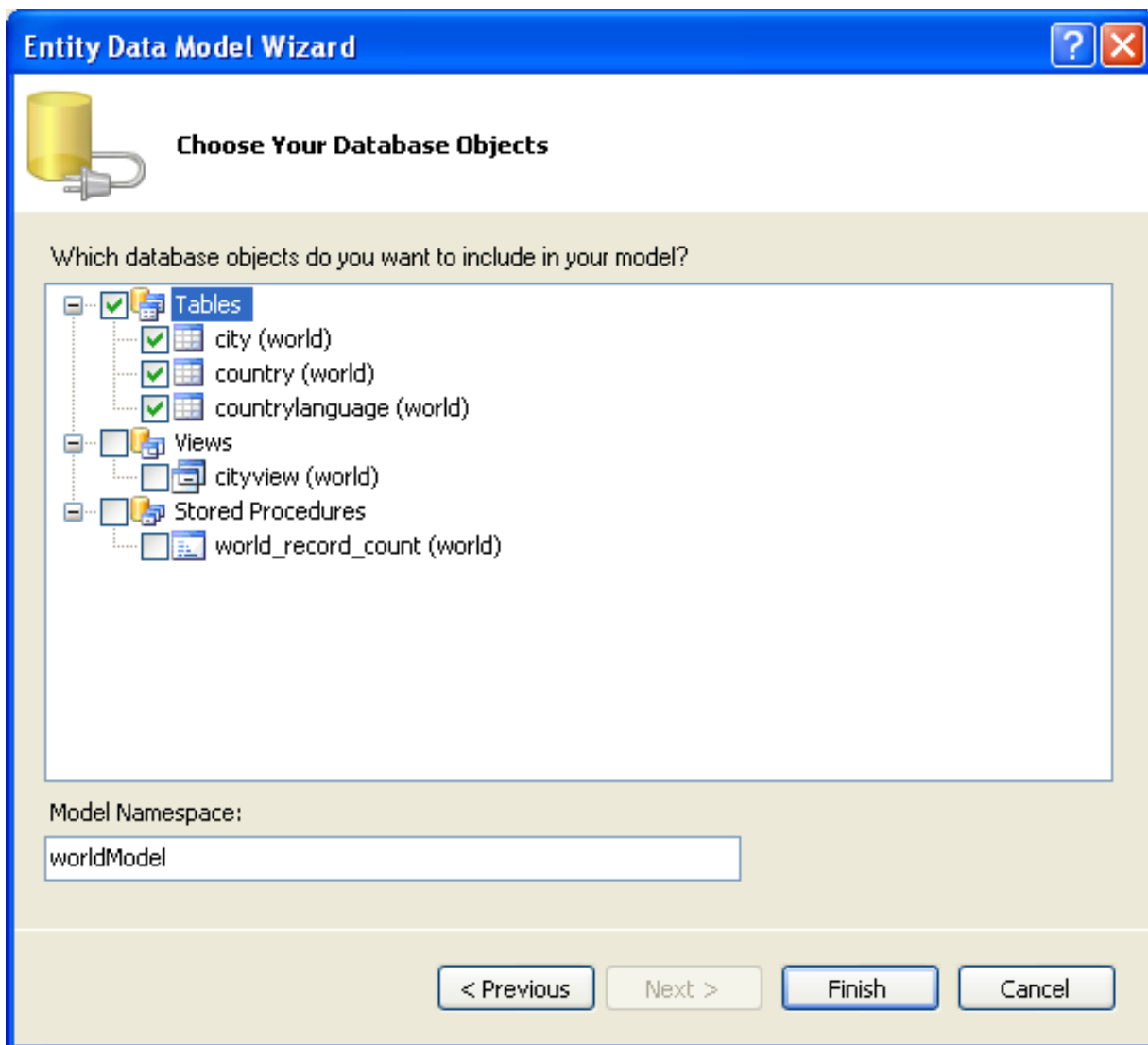
**Figure 20.20. Entity Data Model Wizard Screen 2**





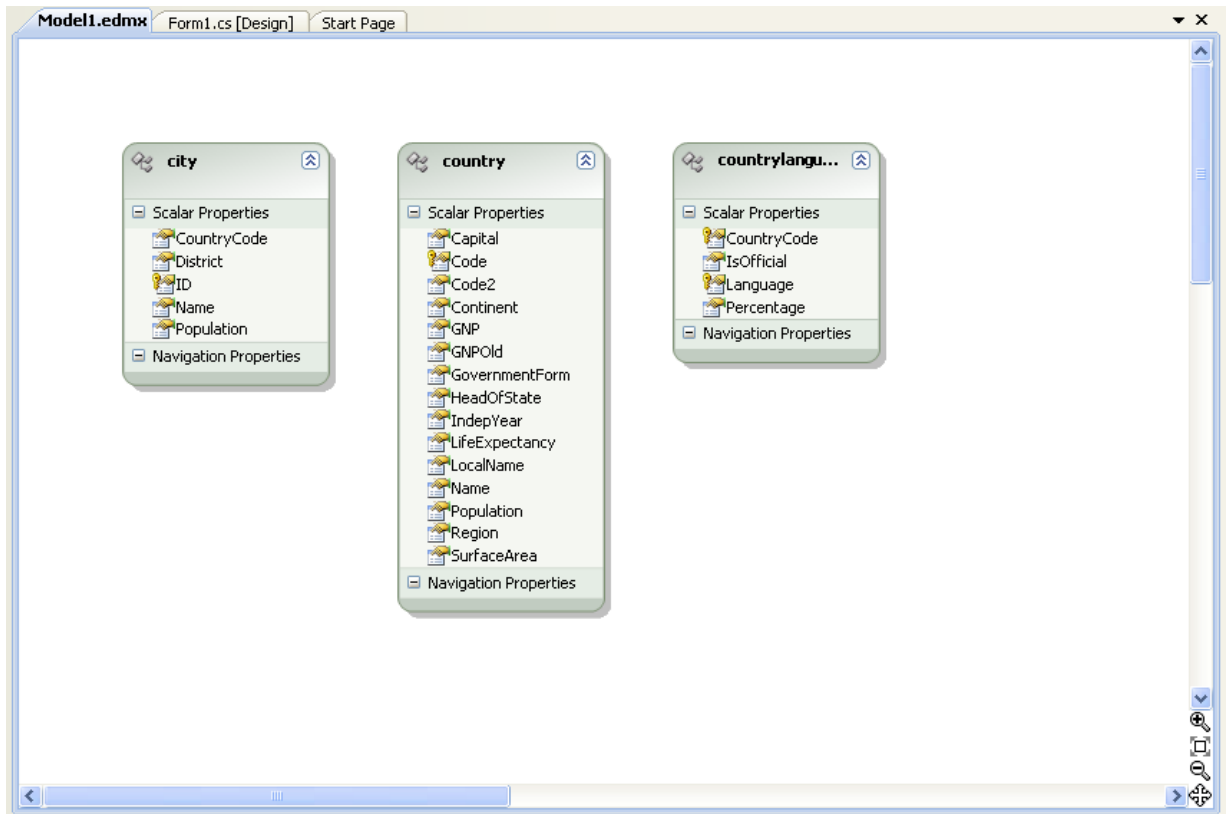
4. Make a note of the entity connection settings to be used in App.Config, as these will be used later to write the necessary control code.
5. Click NEXT.
6. The Entity Data Model Wizard connects to the database. You are then presented with a tree structure of the database. From this you can select the object you would like to include in your model. If you had created Views and Stored Routines these will be displayed along with any tables. In this example you just need to select the tables. Click FINISH to create the model and exit the wizard.

**Figure 20.21. Entity Data Model Wizard Screen 3**



7. Visual Studio will generate the model and then display it.

**Figure 20.22. Entity Data Model Diagram**



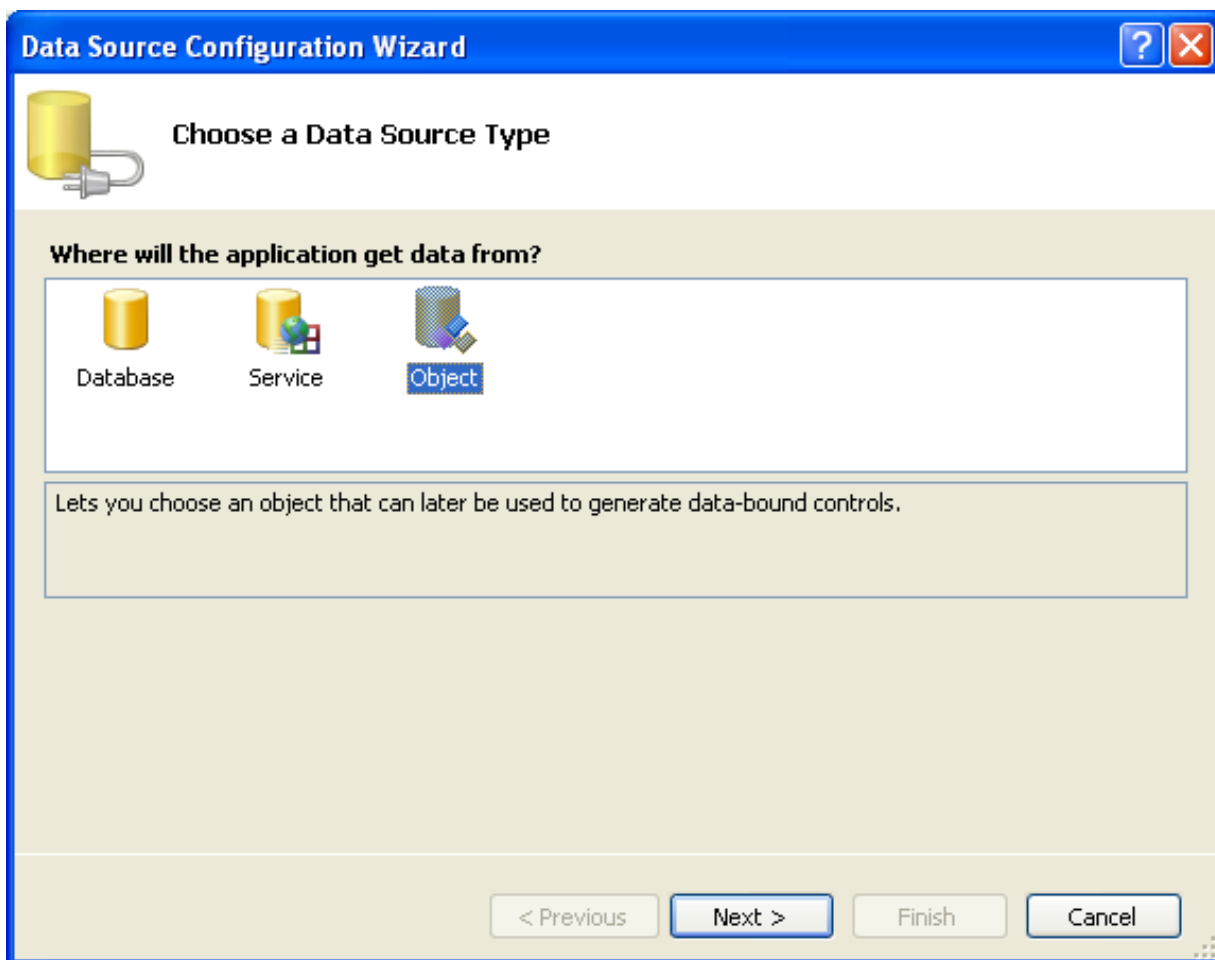
8. From the Visual Studio main menu select **BUILD, BUILD SOLUTION**, to ensure that everything compiles correctly so far.

### Adding a new Data Source

You will now add a new Data Source to your project and see how it can be used to read and write to the database.

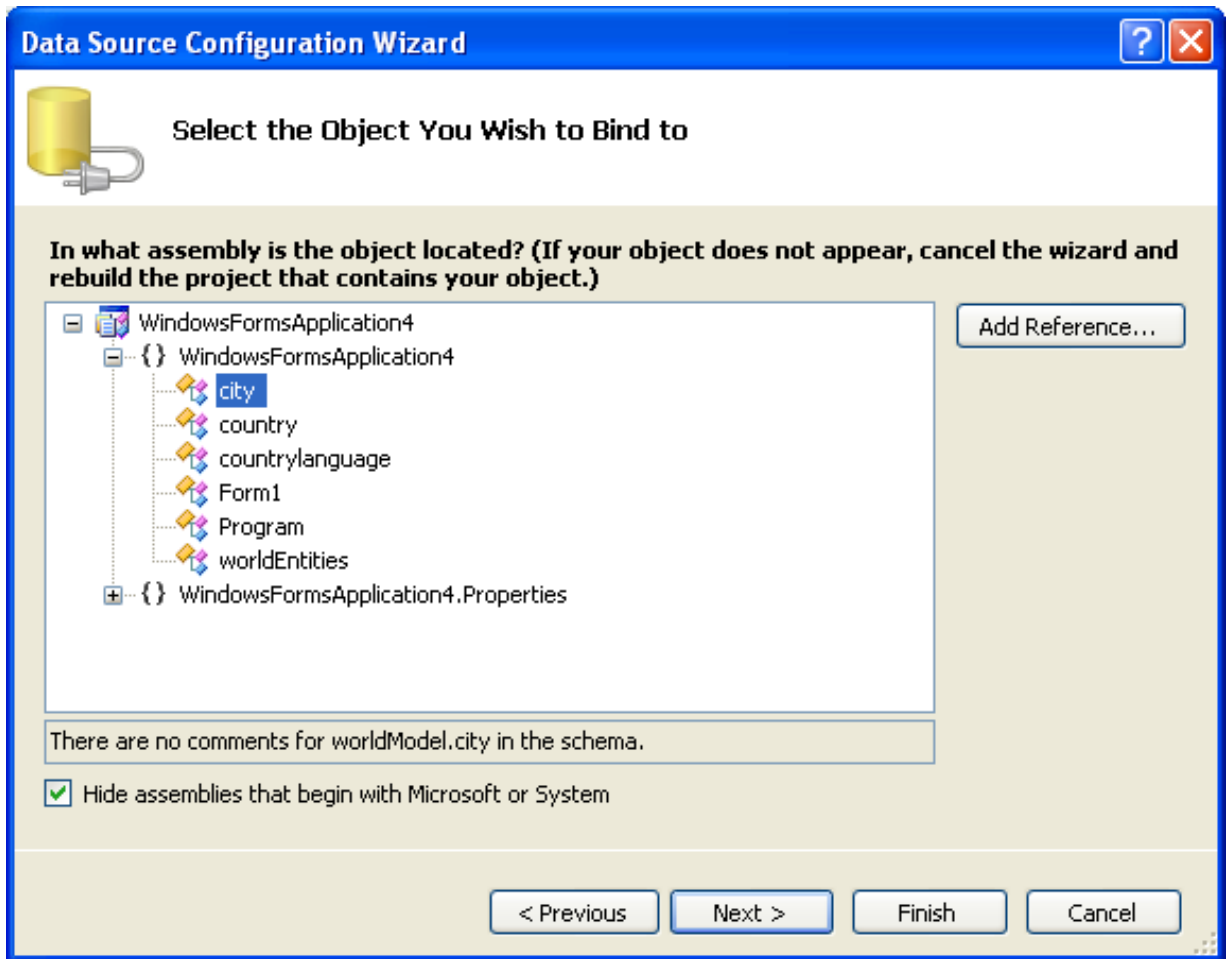
1. From the Visual Studio main menu select **DATA, ADD NEW DATA SOURCE...**. You will be presented with the Data Source Configuration Wizard.

**Figure 20.23. Entity Data Source Configuration Wizard Screen 1**



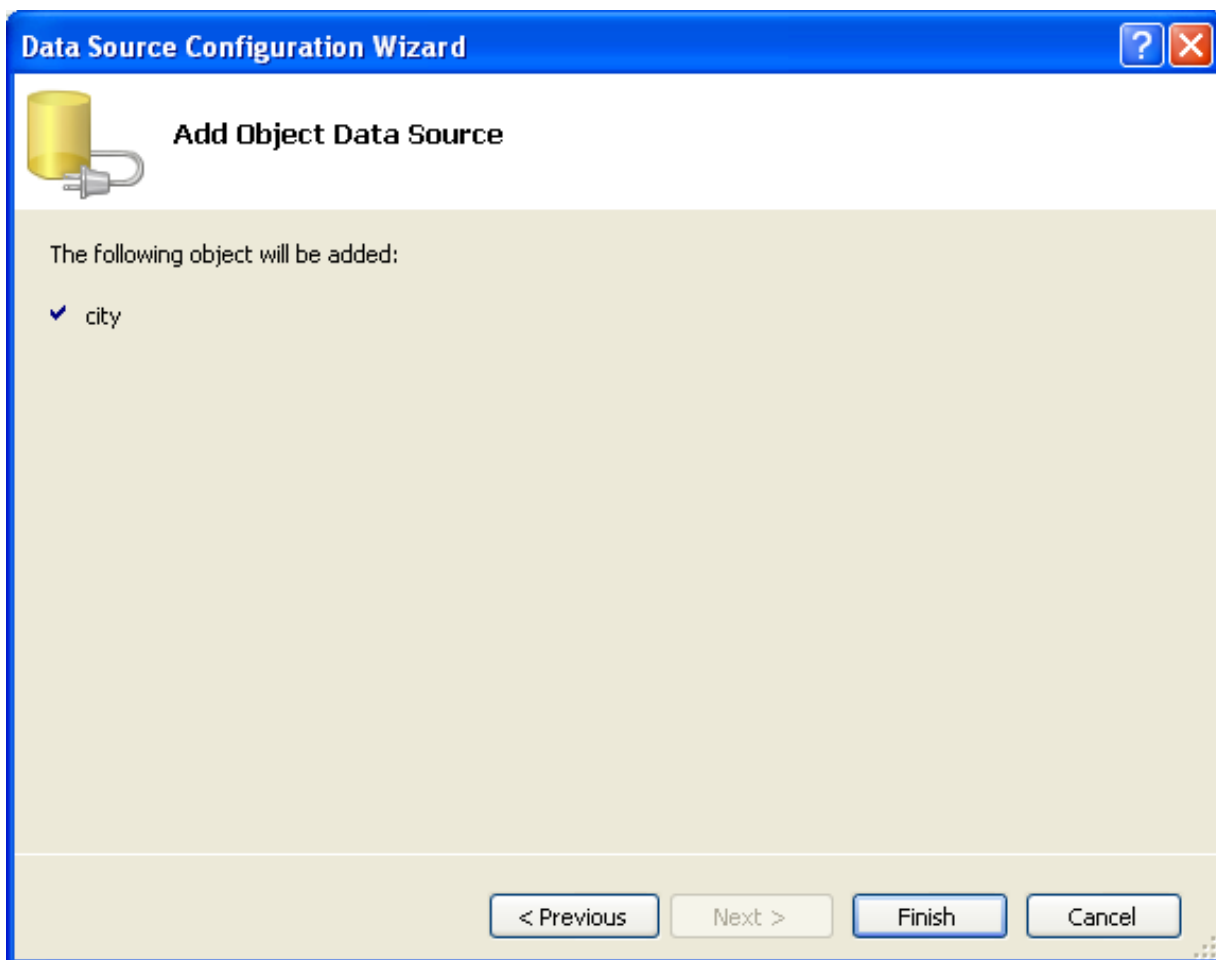
2. Select the **OBJECT** icon. Click NEXT.
3. You will now select the Object you wish to bind to. Expand the tree. In this tutorial you will select the city table. Once the city table has been selected click NEXT.

**Figure 20.24. Entity Data Source Configuration Wizard Screen 2**



4. The wizard will confirm that the city object is to be added. Click FINISH.

**Figure 20.25. Entity Data Source Configuration Wizard Screen 3**



5. The city object will be display in the Data Sources panel. If the Data Sources panel is not displayed, select DATA, SHOW DATA SOURCES from the Visual Studio main menu. The docked panel will then be displayed.

**Figure 20.26. Data Sources**

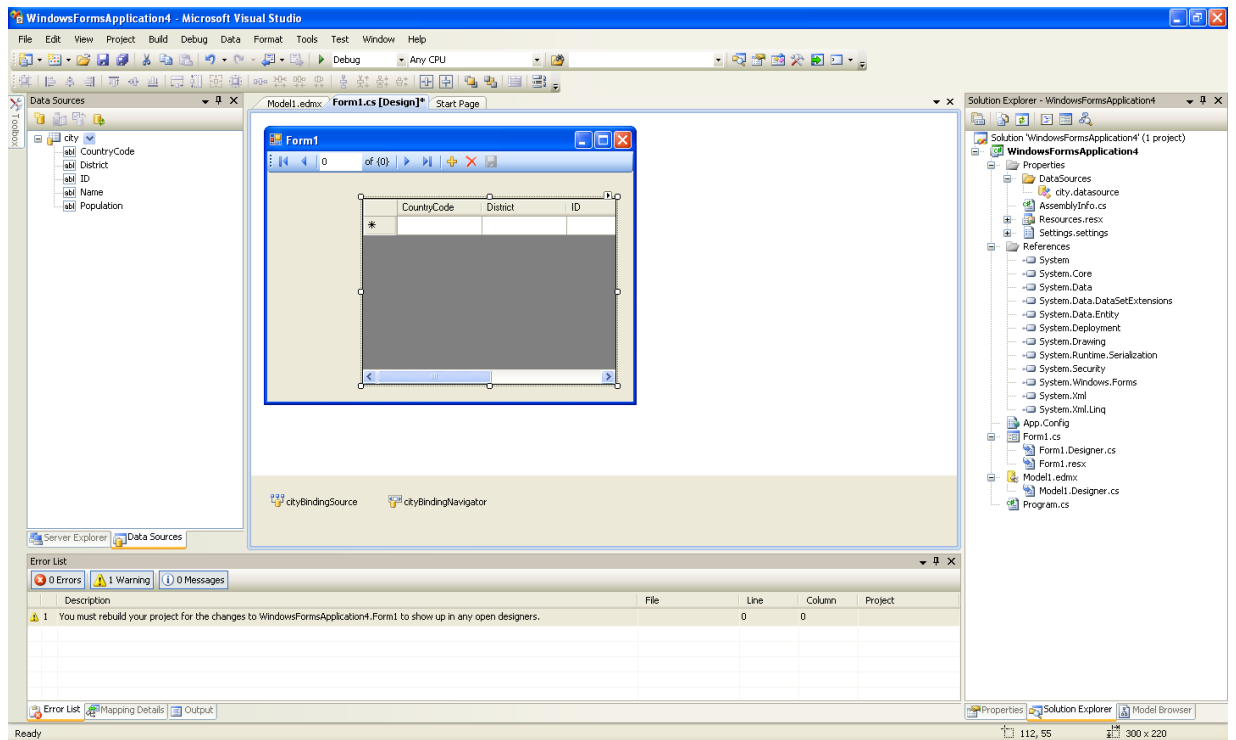


### Using the Data Source in a Windows Form

You will now learn how to use the Data Source in a Windows Form.

1. In the Data Sources panel select the Data Source you just created and drag and drop it onto the Form Designer. By default the Data Source object will be added as a Data Grid View control. Note that the Data Grid View control is bound to the `cityBindingSource` and the Navigator control is bound to `cityBindingNavigator`.

Figure 20.27. Data Form Designer



2. Save and rebuild the solution before continuing.

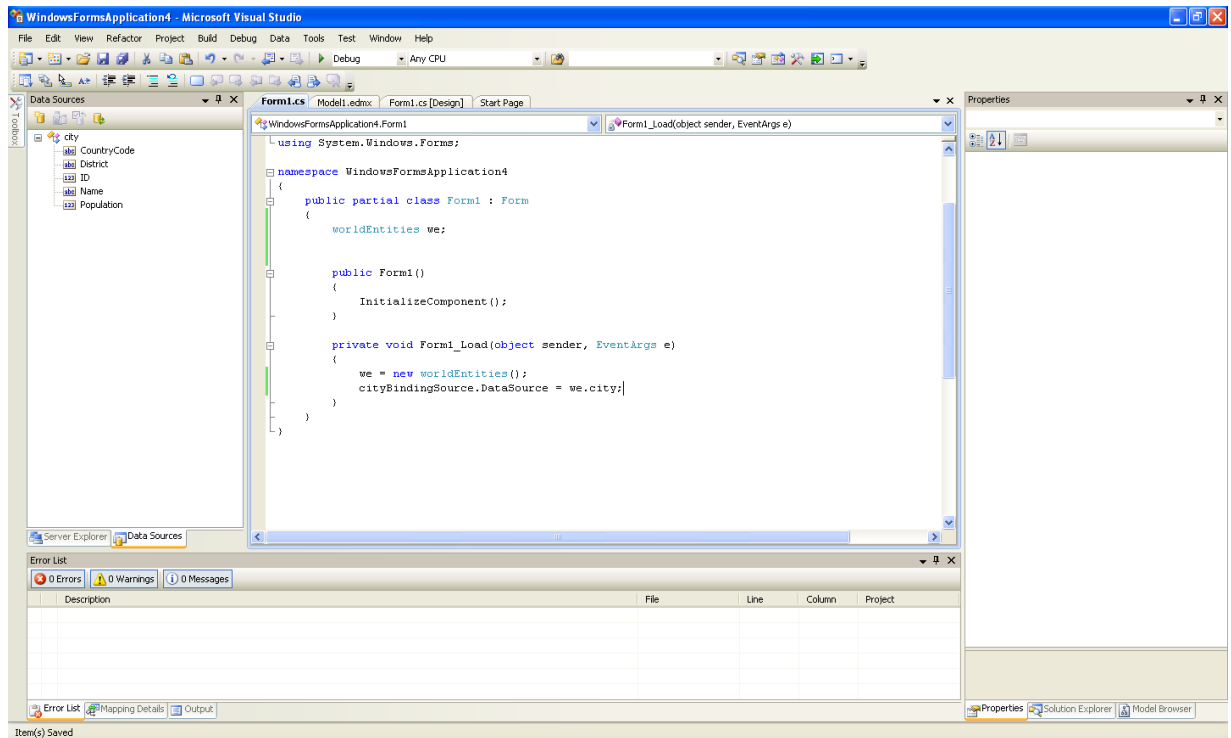
### Adding Code to Populate the Data Grid View

You are now ready to add code to ensure that the Data Grid View control will be populated with data from the City database table.

1. Double click the form to access its code.
2. Add code to instantiate the Entity Data Model's EntityContainer object and retrieve data from the database to populate the control.

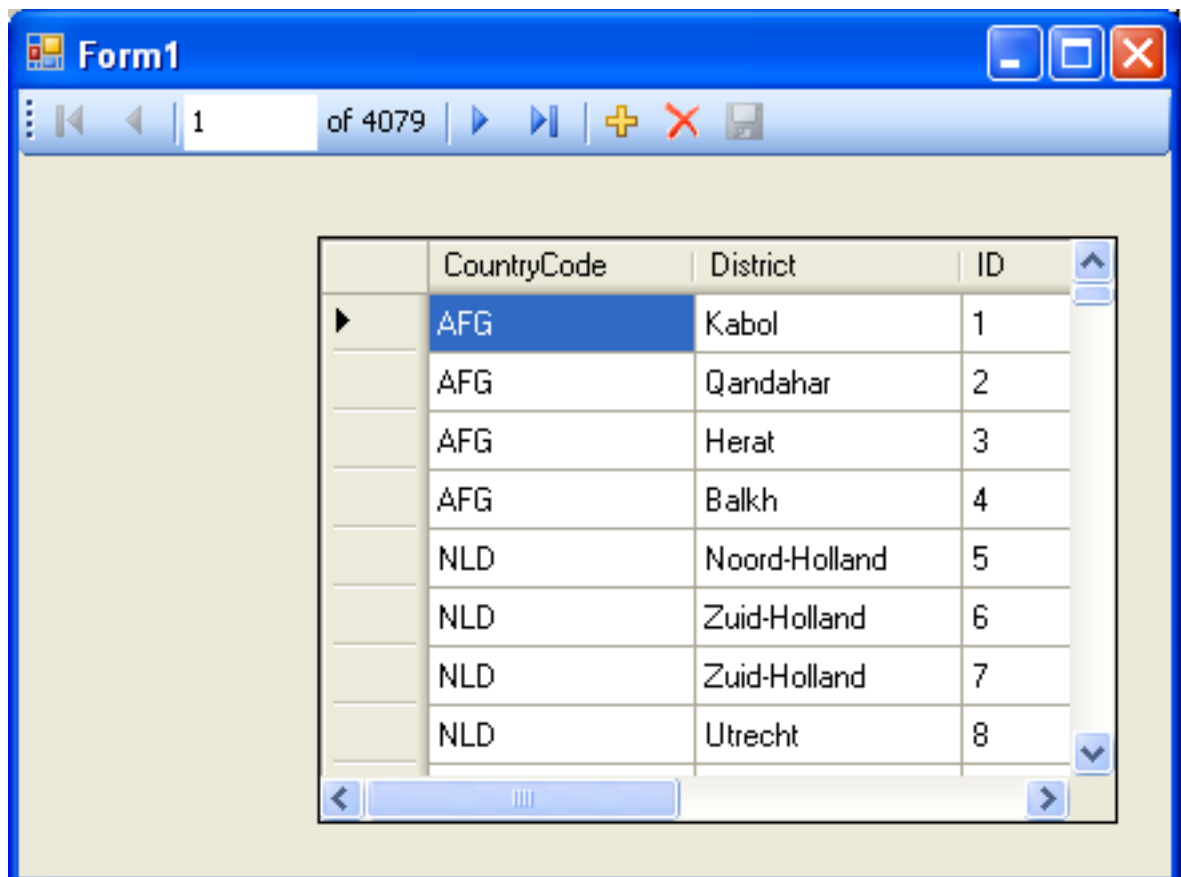
Figure 20.28. Adding Code to the Form





3. Save and rebuild the solution.
4. Run the solution. Ensure the grid is populated and you can navigate the database.

**Figure 20.29. The Populated Grid Control**



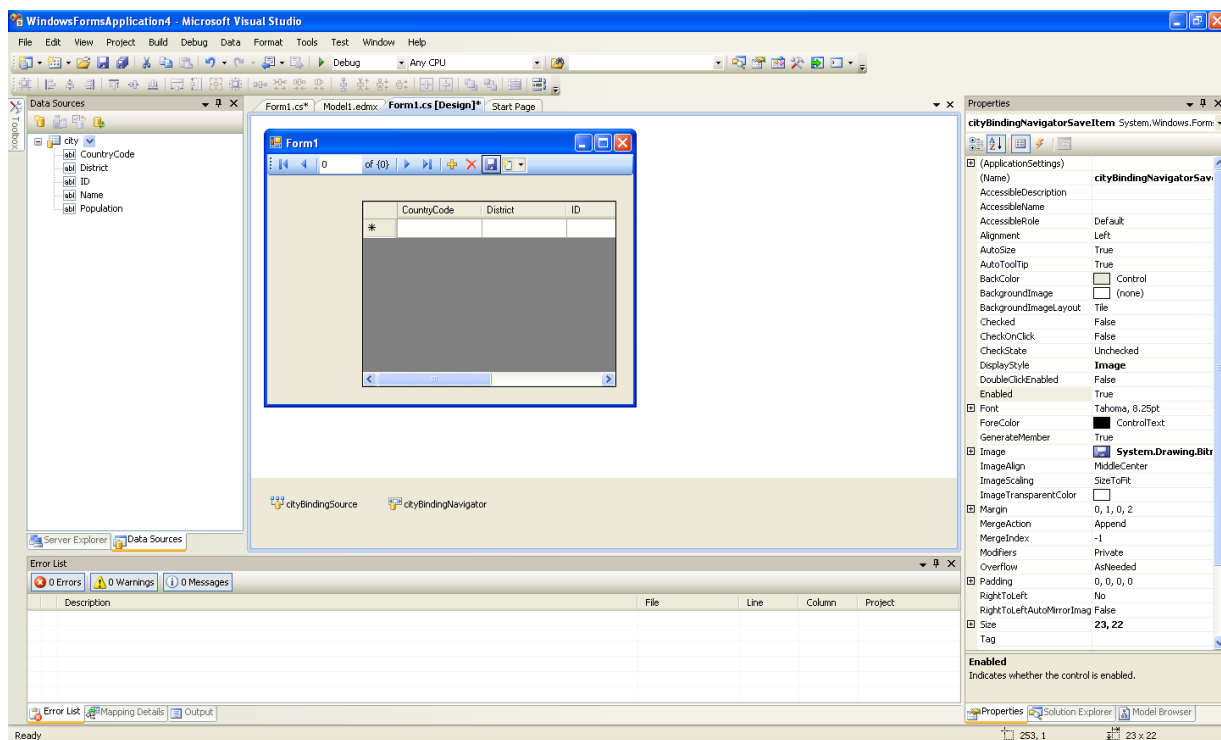
## Adding Code to Save Changes to the Database

You will now add code to enable you to save changes to the database.

The Binding source component ensures that changes made in the Data Grid View control are also made to the Entity classes bound to it. However, that data needs to be saved back from the entities to the database itself. This can be achieved by the enabling of the Save button in the Navigator control, and the addition of some code.

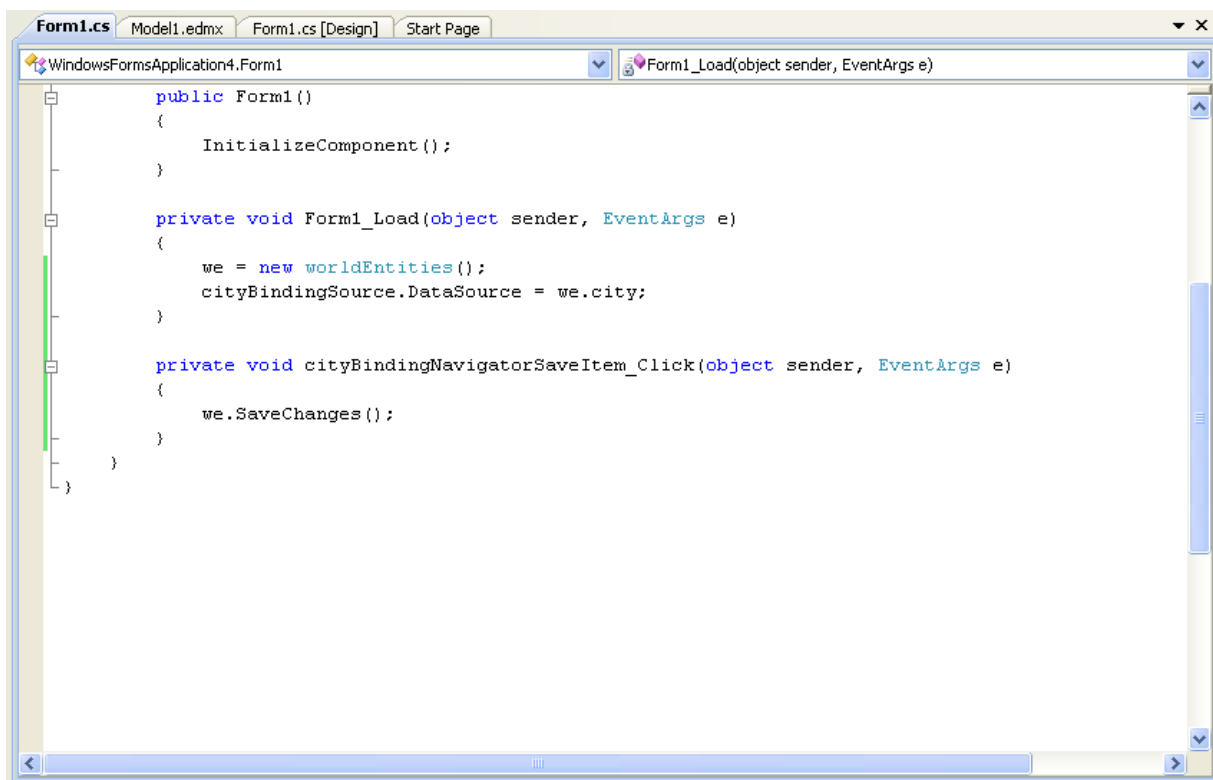
1. In the Form Designer click on the Save icon in the Form toolbar and ensure that its Enabled property is set to True.

**Figure 20.30. Save Button Enabled**



2. Double click the Save icon in the Form toolbar to display its code.
3. You now need to add code to ensure that data is saved to the database when the save button is click in the application.

**Figure 20.31. Adding Save Code to the Form**



4. Once the code has been added, save the solution and rebuild it. Run the application and verify that changes made in the grid are saved.

### 20.2.3.9.2. Tutorial: Databinding in ASP.NET using LINQ on Entities

In this tutorial you create an ASP.NET web page that binds LINQ queries to entities using the Entity Framework mapping.

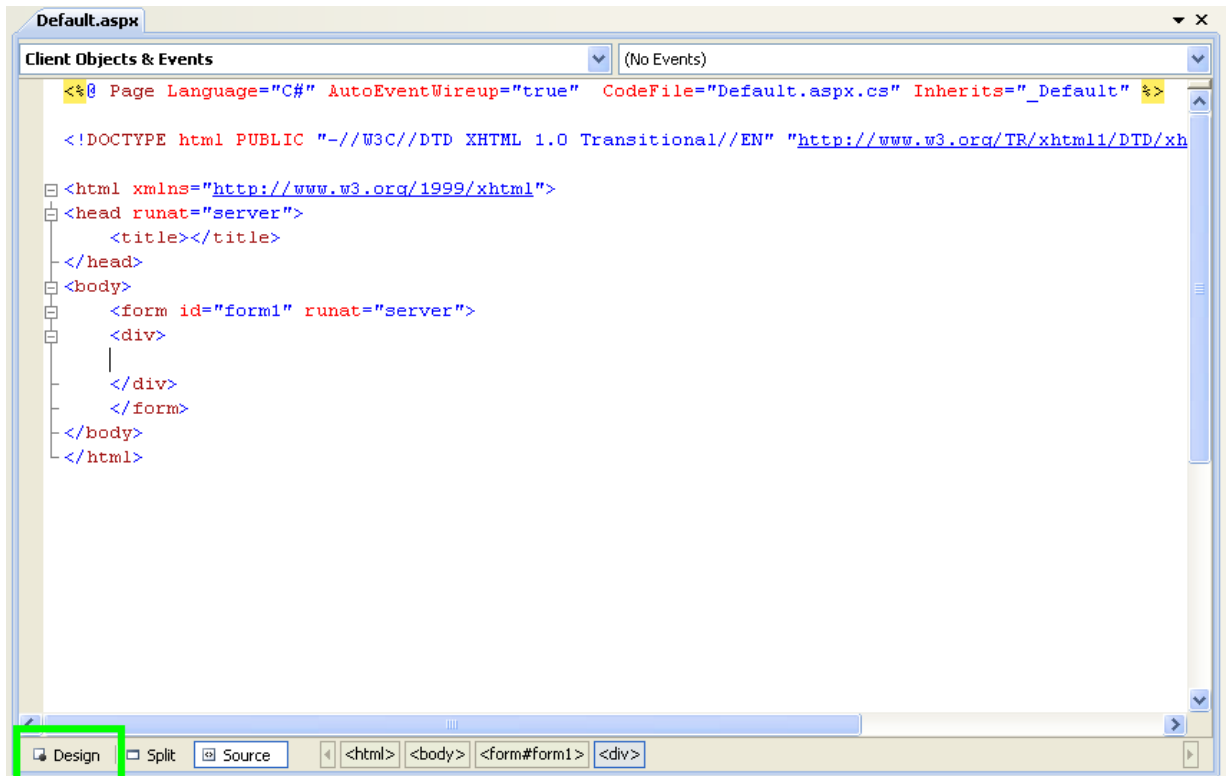
If you have not already done so, you should install the World example database prior to attempting this tutorial. Instructions on where to obtain the database and instructions on how to install it where given in the tutorial [Section 20.2.3.9.1, "Tutorial: Using an Entity Framework Entity as a Windows Forms Data Source"](#).

#### Creating an ASP.NET web site

In this part of the tutorial you will create an ASP.NET web site. The web site will use the World database. The main web page will feature a drop down list from which you can select a country, data about that country's cities will then be displayed in a grid view control.

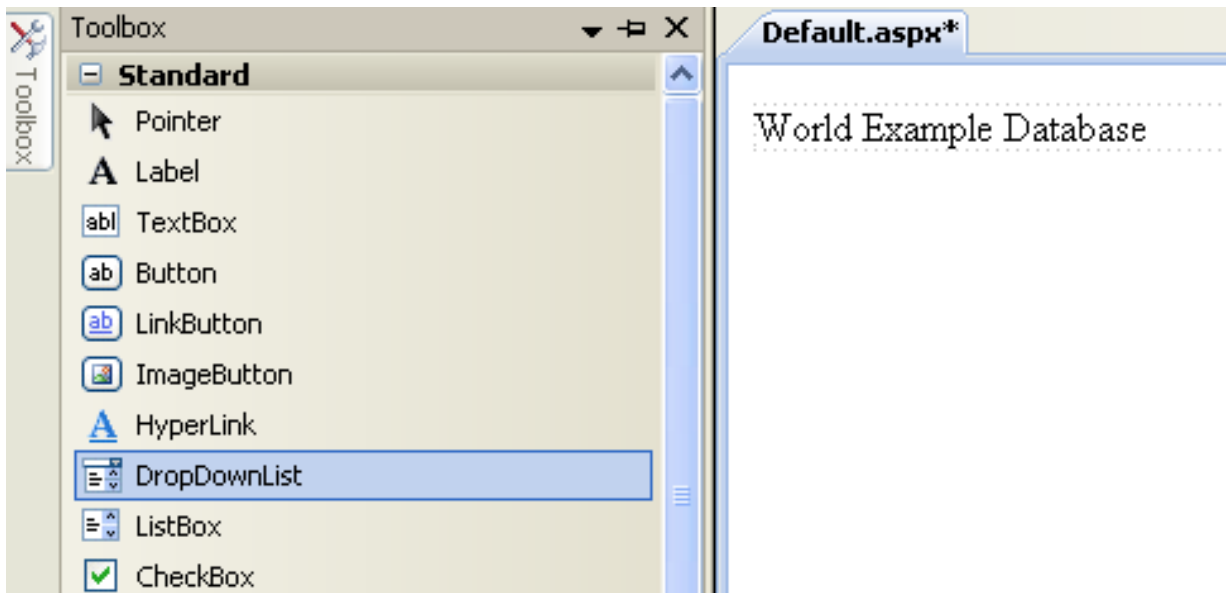
1. From the Visual Studio main menu select **FILE, NEW, WEB SITE....**
2. From the Visual Studio installed templates select **ASP.NET WEB SITE**. Click OK. You will be presented with the Source view of your web page by default.
3. Click the Design view tab situated underneath the Source view panel.

#### Figure 20.32. The Design Tab



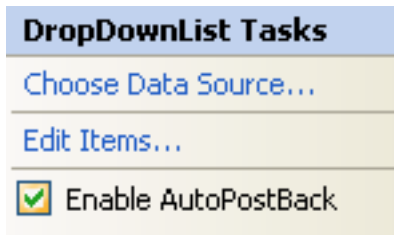
4. In the Design view panel, enter some text to decorate the blank web page.
5. Click on Toolbox. From the list of controls select **DROPDOWNLIST**. Drag and drop the control to a location beneath the text on your web page.

**Figure 20.33. Drop Down List**



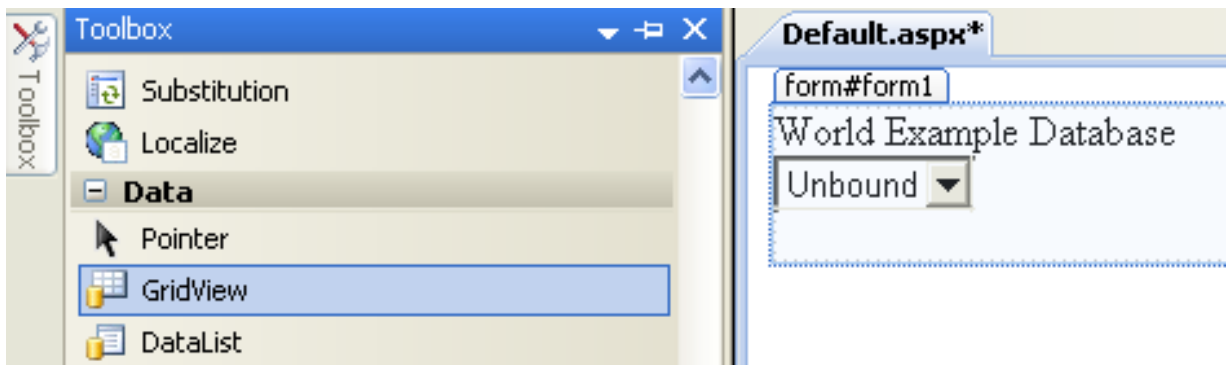
6. From the **DROPDOWNLIST** control's context menu, ensure that the **ENABLE AUTOPOSTBACK** check box is enabled. This will ensure the control's event handler is called when an item is selected. The user's choice will in turn be used to populate the **GRIDVIEW** control.

**Figure 20.34. Enable AutoPostBack**



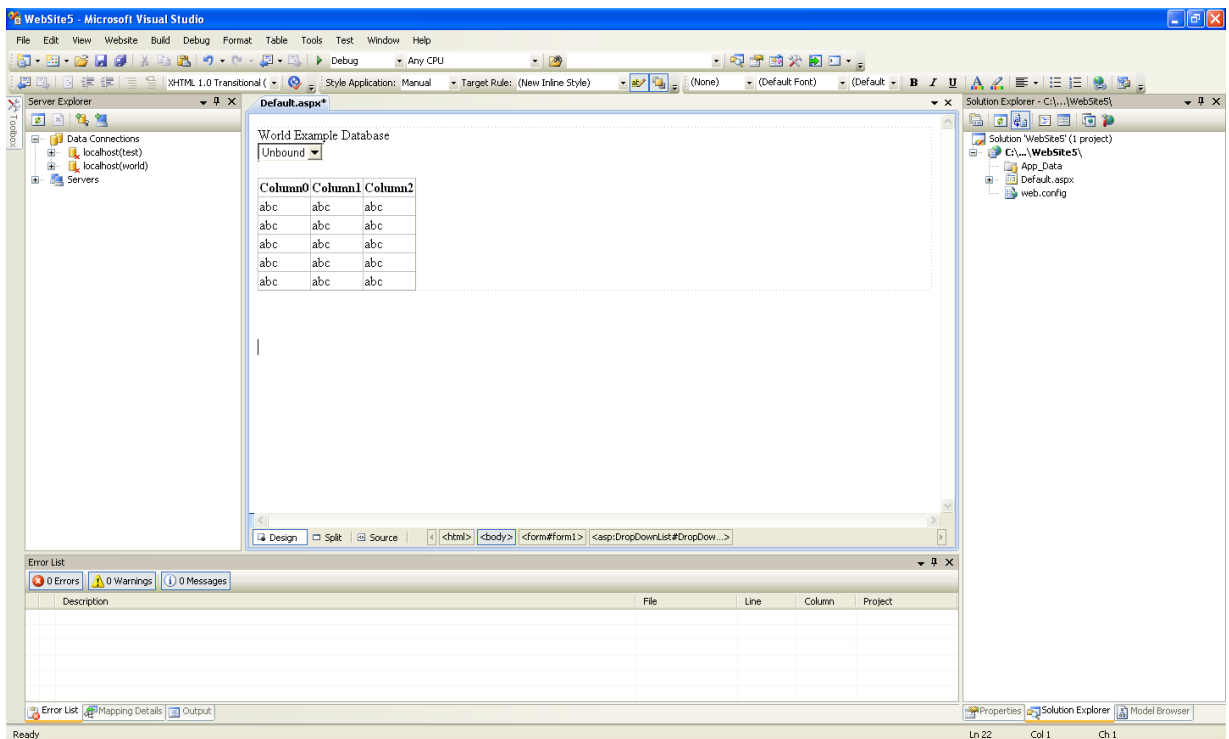
- From the Toolbox select the **GRIDVIEW** control.

**Figure 20.35. Grid View Control**



Drag and drop the Grid View control to a location just below the Drop Down List you already placed.

**Figure 20.36. Placed Grid View Control**



- At this point it is recommended that you save your solution, and build the solution to ensure that there are no errors.
- If you run the solution you will see that the text and drop down list are displayed, but the list is empty. Also, the grid view does not appear at all. Adding this functionality is described in the following sections.

At this stage you have a web site that will build, but further functionality is required. The next step will be to use the Entity Framework to create a mapping from the World database into entities that you can control programmatically.

### Creating an ADO.NET Entity Data Model

In this stage of the tutorial you will add an ADO.NET Entity Data Model to your project, using the World database at the storage level. The procedure for doing this is described in the tutorial [Section 20.2.3.9.1, “Tutorial: Using an Entity Framework Entity as a Windows Forms Data Source”](#), and so will not be repeated here.

### Populating a Drop Data List Box with using the results of a entity LINQ query

In this part of the tutorial you will write code to populate the DropDownList control. When the web page loads the data to populate the list will be achieved by using the results of a LINQ query on the model created previously.

1. In the Design view panel, double click on any blank area. This brings up the [Page\\_Load](#) method.
2. Modify the relevant section of code according to the following listing:

```
...
public partial class _Default : System.Web.UI.Page
{
    worldModel.worldEntities we;

    protected void Page_Load(object sender, EventArgs e)
    {
        we = new worldModel.worldEntities();

        if (!IsPostBack)
        {
            var countryQuery = from c in we.country
                               orderby c.Name
                               select new { c.Code, c.Name };
            DropDownList1.DataValueField = "Code";
            DropDownList1.DataTextField = "Name";
            DropDownList1.DataSource = countryQuery;
            DataBind();
        }
    }
}
...
```

Note that the list control only needs to be populated when the page first loads. The conditional code ensures that if the page is subsequently reloaded, the list control is not repopulated, which would cause the user selection to be lost.

3. Save the solution, build it and run it. You should see the list control has been populated. You can select an item, but as yet the grid view control does not appear.

At this point you have a working Drop Down List control, populated by a LINQ query on your entity data model.

### Populating a Grid View control using an entity LINQ query

In the last part of this tutorial you will populate the Grid View Control using a LINQ query on your entity data model.

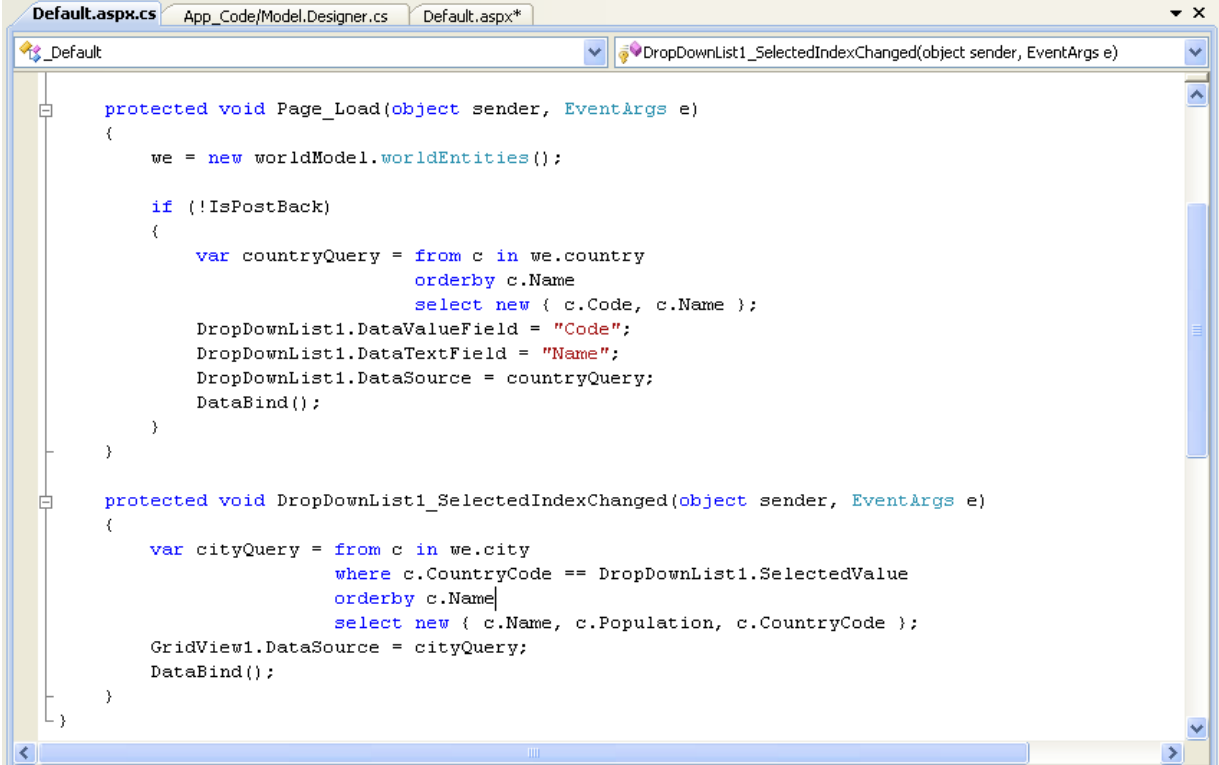
1. In the Design view double click on the **DROPDOWNLIST** control. This causes its [SelectedIndexChanged](#) code to be displayed. This method is called when a user selects an item in the list control and thus fires an AutoPostBack event.
2. Modify the relevant section of code accordingly to the following listing:

```
...
protected void DropDownList1_SelectedIndexChanged(object sender, EventArgs e)
{
    var cityQuery = from c in we.city
                    where c.CountryCode == DropDownList1.SelectedValue
                    orderby c.Name
                    select new { c.Name, c.Population, c.CountryCode };
    GridView1.DataSource = cityQuery;
    DataBind();
}
...
```

The grid view control is populated from the result of the LINQ query on the entity data model.

3. As a check compare your code to that shown in the following screenshot:

### Figure 20.37. Source Code



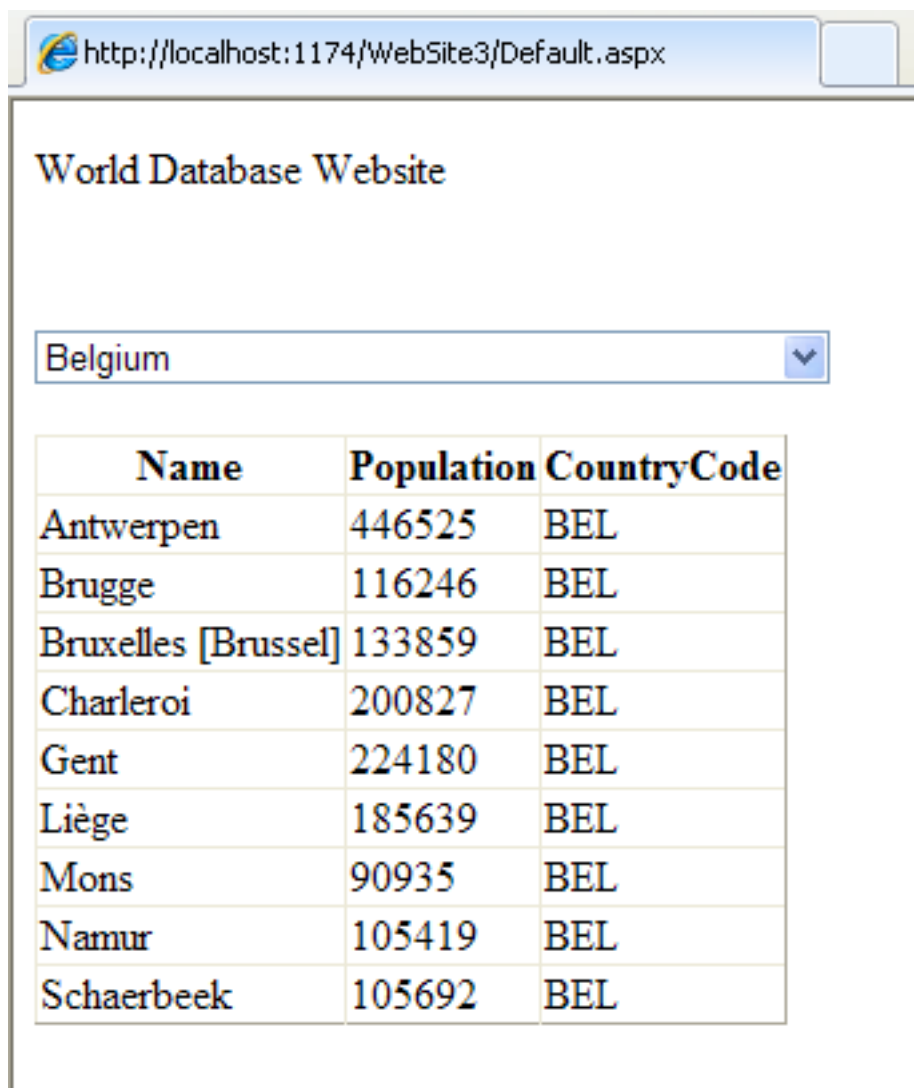
```
protected void Page_Load(object sender, EventArgs e)
{
    we = new worldModel.worldEntities();

    if (!IsPostBack)
    {
        var countryQuery = from c in we.country
                           orderby c.Name
                           select new { c.Code, c.Name };
        DropDownList1.DataValueField = "Code";
        DropDownList1.DataTextField = "Name";
        DropDownList1.DataSource = countryQuery;
        DataBind();
    }
}

protected void DropDownList1_SelectedIndexChanged(object sender, EventArgs e)
{
    var cityQuery = from c in we.city
                   where c.CountryCode == DropDownList1.SelectedValue
                   orderby c.Name
                   select new { c.Name, c.Population, c.CountryCode };
    GridView1.DataSource = cityQuery;
    DataBind();
}
```

4. Save, build and run the solution. As you select a country you will see its cities are displayed in the grid view control.

**Figure 20.38. The Working Web Site**



In this tutorial you have seen how to create an ASP.NET web site, you have also seen how you can access a MySQL database via LINQ queries on an entity data model.

## 20.2.4. Connector/NET Programming

Connector/NET comprises several classes that are used to connect to the database, execute queries and statements, and manage query results.

The following are the major classes of Connector/NET:

- [MySqlCommand](#): Represents an SQL statement to execute against a MySQL database.
- [MySqlCommandBuilder](#): Automatically generates single-table commands used to reconcile changes made to a DataSet with the associated MySQL database.
- [MySqlConnection](#): Represents an open connection to a MySQL Server database.
- [MySqlDataAdapter](#): Represents a set of data commands and a database connection that are used to fill a data set and update a MySQL database.
- [MySqlDataReader](#): Provides a means of reading a forward-only stream of rows from a MySQL database.
- [MySqlException](#): The exception that is thrown when MySQL returns an error.



- [MySQLHelper](#): Helper class that makes it easier to work with the provider.
- [MySQLTransaction](#): Represents an SQL transaction to be made in a MySQL database.

In the following sections you will learn about some common use cases for Connector/NET, including BLOB handling, date handling, and using Connector/NET with common tools such as Crystal Reports.

### 20.2.4.1. Tutorial: An Introduction to Connector/NET Programming

This section provides a gentle introduction to programming with Connector/NET. The example code is written in C#, and is designed to work on both Microsoft .NET Framework and Mono.

This tutorial is designed to get you up and running with Connector/NET as quickly as possible, it does not go into detail on any particular topic. However, the following sections of this manual describe each of the topics introduced in this tutorial in more detail. In this tutorial you are encouraged to type in and run the code, modifying it as required for your setup.

This tutorial assumes you have MySQL and Connector/NET already installed. It also assumes that you have installed the World example database, which can be downloaded from the [MySQL Documentation page](#). You can also find details on how to install the database on the same page.

#### Note

Before compiling the example code make sure that you have added References to your project as required. The References required are [System](#), [System.Data](#) and [MySQL.Data](#).

#### 20.2.4.1.1. The MySqlConnection Object

For your Connector/NET application to connect to a MySQL database it needs to establish a connection. This is achieved through the use of a [MySqlConnection](#) object.

The [MySqlConnection](#) constructor takes a connection string as one of its parameters. The connection string provides necessary information to make the connection to the MySQL database. The connection string is discussed more fully in [Section 20.2.4.2, "Connecting to MySQL Using Connector/NET"](#). A reference containing a list of supported connection string options can also be found in [Section 20.2.4.5, "Connector/NET Connection String Options Reference"](#).

The following code shows how to create a connection object.

```
using System;
using System.Data;

using MySql.Data;
using MySql.Data.MySqlClient;

public class Tutorial1
{
    public static void Main()
    {
        string connStr = "server=localhost;user=root;database=world;port=3306;password=*****";
        MySqlConnection conn = new MySqlConnection(connStr);
        try
        {
            Console.WriteLine("Connecting to MySQL...");
            conn.Open();
            // Perform database operations
            conn.Close();
        }
        catch (Exception ex)
        {
            Console.WriteLine(ex.ToString());
        }
        Console.WriteLine("Done.");
    }
}
```

When the [MySqlConnection](#) constructor is invoked it returns a connection object, which is used for subsequent database operations. The first operation in this example is to open the connection. This needs to be done before further operations take place. Before the application exits the connection to the database needs to be closed by calling [Close](#) on the connection object.

Sometimes an attempt to perform an [Open](#) on a connection object can fail, this will generate an exception that can be handled via standard exception handling code.

In this section you have learned how to create a connection to a MySQL database, and open and close the corresponding connection object.

#### 20.2.4.1.2. The MySqlCommand Object

Once a connection has been established with the MySQL database, the next step is to carry out the desired database operations. This can be achieved through the use of the [MySQLCommand](#) object.

You will see how to create a [MySQLCommand](#) object. Once it has been created there are three main methods of interest that you can call:

- **ExecuteReader** - used to query the database. Results are usually returned in a [MySQLDataReader](#) object, created by [ExecuteReader](#).
- **ExecuteNonQuery** - used to insert and delete data.
- **ExecuteScalar** - used to return a single value.

Once a [MySQLCommand](#) object has been created, you will call one of the above methods on it to carry out a database operation, such as perform a query. The results are usually returned into a [MySQLDataReader](#) object, and then processed, for example the results might be displayed. The following code demonstrates how this could be done.

```
using System;
using System.Data;

using MySql.Data;
using MySql.Data.MySqlClient;

public class Tutorial2
{
    public static void Main()
    {
        string connStr = "server=localhost;user=root;database=world;port=3306;password=*****";
        MySqlConnection conn = new MySqlConnection(connStr);
        try
        {
            Console.WriteLine("Connecting to MySQL...");
            conn.Open();

            string sql = "SELECT Name, HeadOfState FROM Country WHERE Continent='Oceania'";
            MySqlCommand cmd = new MySqlCommand(sql, conn);
            MySQLDataReader rdr = cmd.ExecuteReader();

            while (rdr.Read())
            {
                Console.WriteLine(rdr[0]+" -- "+rdr[1]);
            }

            rdr.Close();
            conn.Close();
        }
        catch (Exception ex)
        {
            Console.WriteLine(ex.ToString());
        }
        Console.WriteLine("Done.");
    }
}
```

When a connection has been created and opened, the code then creates a [MySQLCommand](#) object. Note that the SQL query to be executed is passed to the [MySQLCommand](#) constructor. The [ExecuteReader](#) method is then used to generate a [MySQLReader](#) object. The [MySQLReader](#) object contains the results generated by the SQL executed on the command object. Once the results have been obtained in a [MySQLReader](#) object, the results can be processed. In this case the information is simply printed out as part of a [while](#) loop. Finally, the [MySQLReader](#) object is disposed of by running its [Close](#) method on it.

In the next example you will see how to use the [ExecuteNonQuery](#) method.

The procedure for performing an [ExecuteNonQuery](#) method call is simpler, as there is no need to create an object to store results. This is because [ExecuteNonQuery](#) is only used for inserting, updating and deleting data. The following example illustrates a simple update to the Country table:

```
using System;
using System.Data;

using MySql.Data;
using MySql.Data.MySqlClient;

public class Tutorial3
{
    public static void Main()
    {
        string connStr = "server=localhost;user=root;database=world;port=3306;password=*****";
        MySqlConnection conn = new MySqlConnection(connStr);
        try
        {
            Console.WriteLine("Connecting to MySQL...");
            conn.Open();
```

```

        string sql = "INSERT INTO Country (Name, HeadOfState, Continent) VALUES ('Disneyland','Mickey Mouse', 'Nor'
        MySqlCommand cmd = new MySqlCommand(sql, conn);
        cmd.ExecuteNonQuery();

        conn.Close();
    }
    catch (Exception ex)
    {
        Console.WriteLine(ex.ToString());
    }
    Console.WriteLine("Done.");
}
}

```

The query is constructed, the command object created and the [ExecuteNonQuery](#) method called on the command object. You can access your MySQL database with the MySQL Client program and verify that the update was carried out correctly.

Finally, you will see how the [ExecuteScalar](#) method can be used to return a single value. Again, this is straightforward, as a [MySqlDataReader](#) object is not required to store results, a simple variable will do. The following code illustrates how to use [ExecuteScalar](#):

```

using System;
using System.Data;

using MySql.Data;
using MySql.Data.MySqlClient;

public class Tutorial4
{
    public static void Main()
    {
        string connStr = "server=localhost;user=root;database=world;port=3306;password=*****";
        MySqlConnection conn = new MySqlConnection(connStr);
        try
        {
            Console.WriteLine("Connecting to MySQL...");
            conn.Open();

            string sql = "SELECT COUNT(*) FROM Country";
            MySqlCommand cmd = new MySqlCommand(sql, conn);
            object result = cmd.ExecuteScalar();
            if (result != null)
            {
                int r = Convert.ToInt32(result);
                Console.WriteLine("Number of countries in the World database is: " + r);
            }

            conn.Close();
        }
        catch (Exception ex)
        {
            Console.WriteLine(ex.ToString());
        }
        Console.WriteLine("Done.");
    }
}

```

This example uses a simple query to count the rows in the Country table. The result is obtained by calling [ExecuteScaler](#) on the command object.

### 20.2.4.1.3. Working with Decoupled Data

Previously, when using [MySqlDataReader](#), the connection to the database was continually maintained, unless explicitly closed. It is also possible to work in a manner where a connection is only established when needed. For example, in this mode, a connection could be established in order to read a chunk of data, the data could then be modified by the application as required. A connection could then be reestablished only if and when the application needs to write data back to the database. This decouples the working data set from the database.

This decouple mode of working with data is supported by Connector/NET. There are several parts involved in allowing this method to work:

- **Data Set** - The Data Set is the area in which data is loaded in order to read or modify it. A [DataSet](#) object is instantiated, which can store multiple tables of data.
- **Data Adapter** - The Data Adapter is the interface between the Data Set and the database itself. The Data Adapter is responsible for efficiently managing connections to the database, opening and closing them as required. The Data Adapter is created by instantiating an object of the [MySqlDataAdapter](#) class. The [MySqlDataAdapter](#) object has two main methods: [Fill](#) which reads data into the Data Set, and [Update](#), which writes data from the Data Set to the database.
- **Command Builder** - The Command Builder is a support object. The Command Builder works in conjunction with the Data

Adapter. When a `MySqlDataAdapter` object is created it is typically given an initial SELECT statement. From this SELECT statement the Command Builder can work out the corresponding INSERT, UPDATE and DELETE statements that would be required should the database need to be updated. To create the Command Builder an object of the class `MySqlCommandBuilder` is created.

Each of these classes will now be discussed in more detail.

### Instantiating a DataSet object

A `DataSet` object can be created simply, as shown in the following example code snippet:

```
DataSet dsCountry;
...
dsCountry = new DataSet();
```

Although this creates the `DataSet` object it has not yet filled it with data. For that a Data Adapter is required.

### Instantiating a MySqlDataAdapter object

The `MySqlDataAdapter` can be created as illustrated by the following example:

```
MySqlDataAdapter daCountry;
...
string sql = "SELECT Code, Name, HeadOfState FROM Country WHERE Continent='North America'";
daCountry = new MySqlDataAdapter (sql, conn);
```

Note, the `MySqlDataAdapter` is given the SQL specifying the data you wish to work with.

### Instantiating a MySqlCommandBuilder object

Once the `MySqlDataAdapter` has been created, it is necessary to generate the additional statements required for inserting, updating and deleting data. There are several ways to do this, but in this tutorial you will see how this can most easily be done with `MySqlCommandBuilder`. The following code snippet illustrates how this is done:

```
MySqlCommandBuilder cb = new MySqlCommandBuilder(daCountry);
```

Note that the `MySqlDataAdapter` object is passed as a parameter to the command builder.

### Filling the Data Set

In order to do anything useful with the data from your database, you need to load it into a Data Set. This is one of the jobs of the `MySqlDataAdapter` object, and is carried out with its `Fill` method. The following example code illustrates this:

```
DataSet dsCountry;
...
dsCountry = new DataSet();
...
daCountry.Fill(dsCountry, "Country");
```

Note the `Fill` method is a `MySqlDataAdapter` method, the Data Adapter knows how to establish a connection with the database and retrieve the required data, and then populates the Data Set when the `Fill` method is called. The second parameter "Country" is the table in the Data Set to update.

### Updating the Data Set

The data in the Data Set can now be manipulated by the application as required. At some point, changes to data will need to be written back to the database. This is achieved through a `MySqlDataAdapter` method, the `Update` method.

```
daCountry.Update(dsCountry, "Country");
```

Again, the Data Set and the table within the Data Set to update are specified.

### Working Example

The interactions between the `DataSet`, `MySqlDataAdapter` and `MySqlCommandBuilder` classes can be a little confusing, so their operation can perhaps be best illustrated by working code.

In this example, data from the World database is read into a Data Grid View control. Here, the data can be viewed and changed before clicking an update button. The update button then activates code to write changes back to the database. The code uses the principles explained above. The application was built using the Microsoft Visual Studio in order to place and create the user interface

controls, but the main code that uses the key classes described above is shown below, and is portable.

```
using System;
using System.Collections.Generic;
using System.ComponentModel;
using System.Data;
using System.Drawing;
using System.Linq;
using System.Text;
using System.Windows.Forms;

using MySql.Data;
using MySql.Data.MySqlClient;

namespace WindowsFormsApplication5
{
    public partial class Form1 : Form
    {
        MySqlDataAdapter daCountry;
        DataSet dsCountry;

        public Form1()
        {
            InitializeComponent();
        }

        private void Form1_Load(object sender, EventArgs e)
        {
            string connStr = "server=localhost;user=root;database=world;port=3306;password=*****";
            MySqlConnection conn = new MySqlConnection(connStr);
            try
            {
                label2.Text = "Connecting to MySQL...";

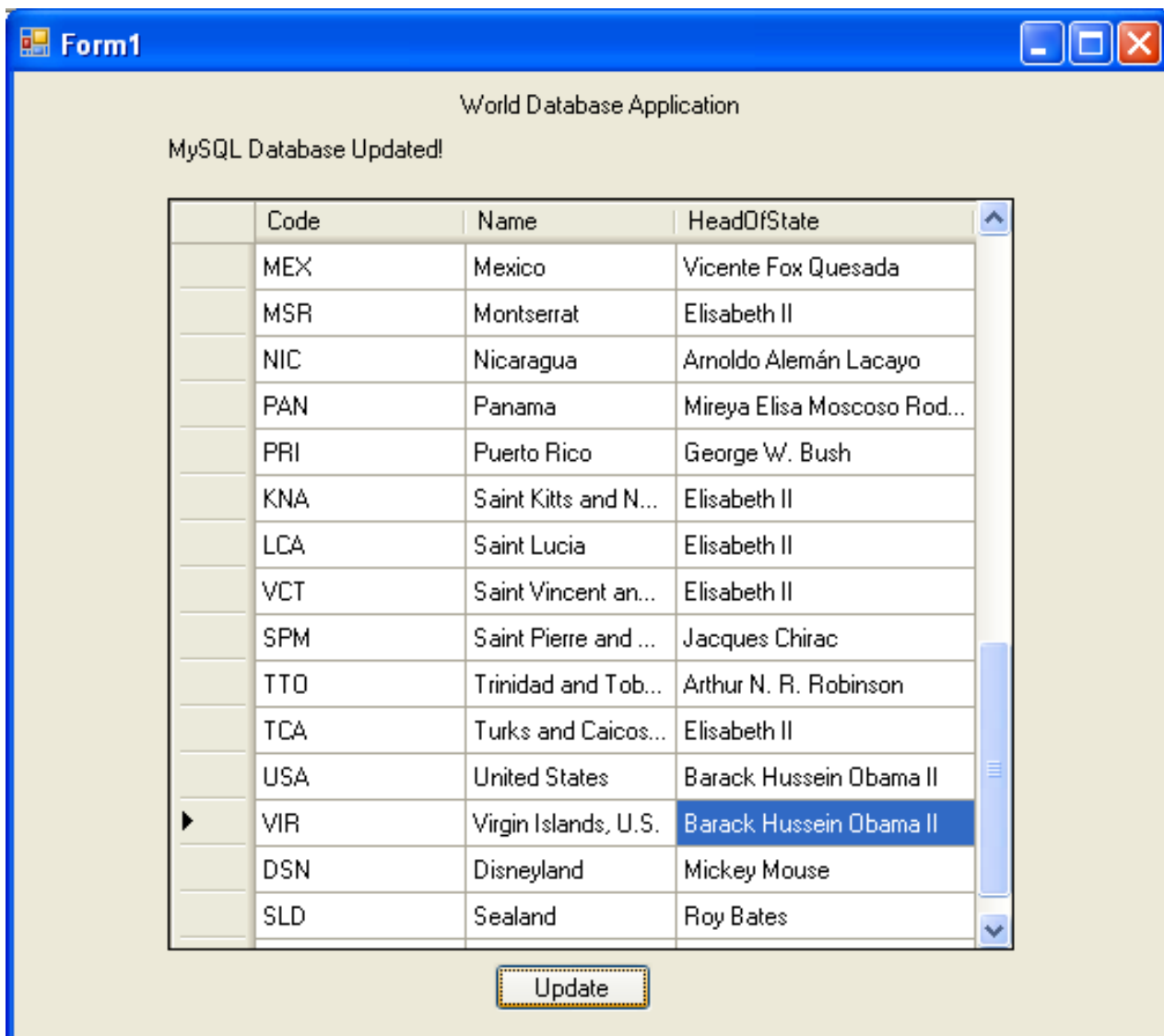
                string sql = "SELECT Code, Name, HeadOfState FROM Country WHERE Continent='North America'";
                daCountry = new MySqlDataAdapter (sql, conn);
                MySqlCommandBuilder cb = new MySqlCommandBuilder(daCountry);

                dsCountry = new DataSet();
                daCountry.Fill(dsCountry, "Country");
                dataGridView1.DataSource = dsCountry;
                dataGridView1.DataMember = "Country";
            }
            catch (Exception ex)
            {
                label2.Text = ex.ToString();
            }
        }

        private void button1_Click(object sender, EventArgs e)
        {
            daCountry.Update(dsCountry, "Country");
            label2.Text = "MySQL Database Updated!";
        }
    }
}
```

The application running is shown below:

**Figure 20.39. World Database Application**



#### 20.2.4.1.4. Working with Parameters

This part of the tutorial shows you how to use parameters in your Connector/.NET application.

Although it is possible to build SQL query strings directly from user input, this is not advisable as it does not prevent from erroneous or malicious information being entered. It is safer to use parameters as they will be processed as field data only. For example, imagine the following query was constructed from user input:

```
string sql = "SELECT Name, HeadOfState FROM Country WHERE Continent = "+user_continent;
```

If the string `user_continent` came from a Text Box control, there would potentially be no control over the string entered by the user. The user could enter a string that generates a run time error, or in the worst case actually harms the system. When using parameters it is not possible to do this because a parameter is only ever treated as a field parameter, rather than an arbitrary piece of SQL code.

The same query written using a parameter for user input would be:

```
string sql = "SELECT Name, HeadOfState FROM Country WHERE Continent = @Continent";
```

Note that the parameter is preceded by an '@' symbol to indicate it is to be treated as a parameter.

As well as marking the position of the parameter in the query string, it is necessary to create a parameter object that can be passed to the Command object. In Connector/.NET the class `MySQLParameter` is used for this purpose. The use of `MySQLParameter` is best illustrated by a small code snippet:

```

MySQLParameter param = new MySQLParameter();
param.ParameterName = "@Continent";
param.Value = "North America";
cmd.Parameters.Add(param);

```

In this example the string "North America" is supplied as the parameter value statically, but in a more practical example it would come from a user input control. Once the parameter has its name and value set it needs to be added to the Command object using the [Add](#) method.

A further example illustrates this:

```

using System;
using System.Data;

using MySql.Data;
using MySql.Data.MySqlClient;

public class Tutorial5
{
    public static void Main()
    {
        string connStr = "server=localhost;user=root;database=world;port=3306;password=*****";
        MySqlConnection conn = new MySqlConnection(connStr);
        try
        {
            Console.WriteLine("Connecting to MySQL...");
            conn.Open();

            string sql = "SELECT Name, HeadOfState FROM Country WHERE Continent=@Continent";
            MySqlCommand cmd = new MySqlCommand(sql, conn);

            Console.WriteLine("Enter a continent e.g. 'North America', 'Europe': ");
            string user_input = Console.ReadLine();

            MySQLParameter param = new MySQLParameter();
            param.ParameterName = "@Continent";
            param.Value = user_input;
            cmd.Parameters.Add(param);

            MySqlDataReader rdr = cmd.ExecuteReader();

            while (rdr.Read())
            {
                Console.WriteLine(rdr["Name"]+" --- "+rdr["HeadOfState"]);
            }

            conn.Close();
        }
        catch (Exception ex)
        {
            Console.WriteLine(ex.ToString());
        }
        Console.WriteLine("Done.");
    }
}

```

In this part of the tutorial you have see how to use parameters to make your code more secure.

### 20.2.4.1.5. Working with Stored Procedures

In this section you will see how to work with Stored Procedures. This section assumes you have a basic understanding of what a Stored Procedure is, and how to create one.

For the purposes of this tutorial, you will create a simple Stored Procedure to see how it can be called from Connector/NET. In the MySQL Client program, connect to the World database and enter the following Stored Procedure:

```

DELIMITER //
CREATE PROCEDURE country_hos
(IN con CHAR(20))
BEGIN
    SELECT Name, HeadOfState FROM Country
    WHERE Continent = con;
END //
DELIMITER ;

```

Test the Stored Procedure works as expected by typing the following into the MySQL Client program:

```
CALL country_hos('Europe');
```

Note that The Stored Routine takes a single parameter, which is the continent you wish to restrict your search to.

Having confirmed that the Stored Procedure is present and correct you can now move on to seeing how it can be accessed from Connector/NET.

Calling a Stored Procedure from your Connector/NET application is similar to techniques you have seen earlier in this tutorial. A `MySQLCommand` object is created, but rather than taking a SQL query as a parameter it takes the name of the Stored Procedure to call. The `MySQLCommand` object also needs to be set to the type of Stored Procedure. This is illustrated by the following code snippet:

```
string rtn = "country_hos";
MySQLCommand cmd = new MySQLCommand(rtn, conn);
cmd.CommandType = CommandType.StoredProcedure;
```

In this case you also need to pass a parameter to the Stored Procedure. This can be achieved using the techniques seen in the previous section on parameters, [Section 20.2.4.1.4, "Working with Parameters"](#). This is shown in the following code snippet:

```
MySQLParameter param = new MySQLParameter();
param.ParameterName = "@con";
param.Value = "Europe";
cmd.Parameters.Add(param);
```

The value of the parameter `@con` could more realistically have come from a user input control, but for simplicity it is set as a static string in this example.

At this point everything is set up and all that now needs to be done is to call the routine. This can be achieved using techniques also learned in earlier sections, but in this case the `ExecuteReader` method of the `MySQLCommand` object is used.

Complete working code for the Stored Procedure example is shown below:

```
using System;
using System.Data;

using MySql.Data;
using MySql.Data.MySqlClient;

public class Tutorial6
{
    public static void Main()
    {
        string connStr = "server=localhost;user=root;database=world;port=3306;password=*****";
        MySqlConnection conn = new MySqlConnection(connStr);
        try
        {
            Console.WriteLine("Connecting to MySQL...");
            conn.Open();

            string rtn = "country_hos";
            MySQLCommand cmd = new MySQLCommand(rtn, conn);
            cmd.CommandType = CommandType.StoredProcedure;
            MySQLParameter param = new MySQLParameter();
            param.ParameterName = "@con";
            param.Value = "Europe";
            cmd.Parameters.Add(param);

            MySQLDataReader rdr = cmd.ExecuteReader();
            while (rdr.Read())
            {
                Console.WriteLine(rdr[0] + " --- " + rdr[1]);
            }
            conn.Close();
        }
        catch (Exception ex)
        {
            Console.WriteLine(ex.ToString());
        }
        Console.WriteLine("Done.");
    }
}
```

In this section you have seen how to call a Stored Procedure from Connector/NET. For the moment, this concludes our introductory tutorial on programming with Connector/NET.

## 20.2.4.2. Connecting to MySQL Using Connector/NET

### Introduction

All interaction between a .NET application and the MySQL server is routed through a `MySQLConnection` object. Before your application can interact with the server, a `MySQLConnection` object must be instantiated, configured, and opened.

Even when using the `MySQLHelper` class, a `MySQLConnection` object is created by the helper class.

In this section, we will describe how to connect to MySQL using the `MySQLConnection` object.

## 20.2.4.3. Creating a Connection String



The `MySqlConnection` object is configured using a connection string. A connection string contains several key/value pairs, separated by semicolons. Each key/value pair is joined with an equals sign.

The following is a sample connection string:

```
Server=127.0.0.1;Uid=root;Pwd=12345;Database=test;
```

In this example, the `MySqlConnection` object is configured to connect to a MySQL server at `127.0.0.1`, with a user name of `root` and a password of `12345`. The default database for all statements will be the `test` database.

The following options are available:

### Note

Using the '@' symbol for parameters is now the preferred approach although the old pattern of using '?' is still supported.

Please be aware however that using '@' can cause conflicts when user variables are also used. To help with this situation please see the documentation on the [Allow User Variables](#) connection string option, which can be found here: [Section 20.2.4.3, "Creating a Connection String"](#). The `Old Syntax` connection string option has now been deprecated.

## 20.2.4.3.1. Opening a Connection

Once you have created a connection string it can be used to open a connection to the MySQL server.

The following code is used to create a `MySqlConnection` object, assign the connection string, and open the connection.

### Visual Basic Example

```
Dim conn As New MySql.Data.MySqlClient.MySqlConnection
Dim myConnectionString as String

myConnectionString = "server=127.0.0.1;" _
    & "uid=root;" _
    & "pwd=12345;" _
    & "database=test;"

Try
    conn.ConnectionString = myConnectionString
    conn.Open()
Catch ex As MySql.Data.MySqlClient.MySqlException
    MessageBox.Show(ex.Message)
End Try
```

### C# Example

```
MySql.Data.MySqlClient.MySqlConnection conn;
string myConnectionString;

myConnectionString = "server=127.0.0.1;uid=root;" +
    "pwd=12345;database=test;";

try
{
    conn = new MySql.Data.MySqlClient.MySqlConnection();
    conn.ConnectionString = myConnectionString;
    conn.Open();
}
catch (MySql.Data.MySqlClient.MySqlException ex)
{
    MessageBox.Show(ex.Message);
}
```

You can also pass the connection string to the constructor of the `MySqlConnection` class:

### Visual Basic Example

```
Dim myConnectionString as String

myConnectionString = "server=127.0.0.1;" _
    & "uid=root;" _
    & "pwd=12345;" _
    & "database=test;"

Try
    Dim conn As New MySql.Data.MySqlClient.MySqlConnection(myConnectionString)
    conn.Open()
End Try
```

```
Catch ex As MySql.Data.MySqlClient.MySqlException
    MessageBox.Show(ex.Message)
End Try
```

### C# Example

```
MySql.Data.MySqlClient.MySqlConnection conn;
string myConnectionString;

myConnectionString = "server=127.0.0.1;uid=root;" +
    "pwd=12345;database=test;";

try
{
    conn = new MySql.Data.MySqlClient.MySqlConnection(myConnectionString);
    conn.Open();
}
catch (MySql.Data.MySqlClient.MySqlException ex)
{
    MessageBox.Show(ex.Message);
}
```

Once the connection is open it can be used by the other Connector/.NET classes to communicate with the MySQL server.

### 20.2.4.3.2. Handling Connection Errors

Because connecting to an external server is unpredictable, it is important to add error handling to your .NET application. When there is an error connecting, the `MySqlConnection` class will return a `MySqlException` object. This object has two properties that are of interest when handling errors:

- **Message:** A message that describes the current exception.
- **Number:** The MySQL error number.

When handling errors, you can your application's response based on the error number. The two most common error numbers when connecting are as follows:

- **0:** Cannot connect to server.
- **1045:** Invalid user name and/or password.

The following code shows how to adapt the application's response based on the actual error:

#### Visual Basic Example

```
Dim myConnectionString as String

myConnectionString = "server=127.0.0.1;" _
    & "uid=root;" _
    & "pwd=12345;" _
    & "database=test;"

Try
    Dim conn As New MySql.Data.MySqlClient.MySqlConnection(myConnectionString)
    conn.Open()
Catch ex As MySql.Data.MySqlClient.MySqlException
    Select Case ex.Number
        Case 0
            MessageBox.Show("Cannot connect to server. Contact administrator")
        Case 1045
            MessageBox.Show("Invalid username/password, please try again")
    End Select
End Try
```

### C# Example

```
MySql.Data.MySqlClient.MySqlConnection conn;
string myConnectionString;

myConnectionString = "server=127.0.0.1;uid=root;" +
    "pwd=12345;database=test;";

try
{
    conn = new MySql.Data.MySqlClient.MySqlConnection(myConnectionString);
    conn.Open();
}
```

```

}
catch (MySql.Data.MySqlClient.MySqlException ex)
{
    switch (ex.Number)
    {
        case 0:
            MessageBox.Show("Cannot connect to server. Contact administrator");
        case 1045:
            MessageBox.Show("Invalid username/password, please try again");
    }
}
}

```

### Important

Note that if you are using multilanguage databases you must specify the character set in the connection string. If you do not specify the character set, the connection defaults to the `latin1` charset. You can specify the character set as part of the connection string, for example:

```

MySqlConnection myConnection = new MySqlConnection("server=127.0.0.1;uid=root;" +
"pwd=12345;database=test;Charset=latin1;");

```

## 20.2.4.4. Using Connector/NET with Connection Pooling

The Connector/NET supports connection pooling. This is enabled by default, but can be turned off via connection string options. See [Section 20.2.4.3, “Creating a Connection String”](#) for further information.

Connection pooling works by keeping the native connection to the server live when the client disposes of a `MySqlConnection`. Subsequently, if a new `MySqlConnection` object is opened, it will be created from the connection pool, rather than creating a new native connection. This improves performance.

To work as designed, it is best to let the connection pooling system manage all connections. You should not create a globally accessible instance of `MySqlConnection` and then manually open and close it. This interferes with the way the pooling works and can lead to unpredictable results or even exceptions.

One approach that simplifies things is to avoid manually creating a `MySqlConnection` object. Instead use the overloaded methods that take a connection string as an argument. Using this approach, Connector/NET will automatically create, open, close and destroy connections, using the connection pooling system for best performance.

Typed Datasets and the `MembershipProvider` and `RoleProvider` classes use this approach. Most classes that have methods that take a `MySqlConnection` as an argument, also have methods that take a connection string as an argument. This includes `MySqlDataAdapter`.

Instead of manually creating `MySqlCommand` objects, you can use the static methods of the `MySqlHelper` class. These take a connection string as an argument, and they fully support connection pooling.

## 20.2.4.5. Connector/NET Connection String Options Reference

Name	Default	Description
<code>Allow Batch</code>	true	When true, multiple SQL statements can be sent with one command execution. -Note- Starting with MySQL 4.1.1, batch statements should be separated by the server-defined separator character. Commands sent to earlier versions of MySQL should be separated with ';'.
<code>Allow User Variables</code>	false	Setting this to <code>true</code> indicates that the provider expects user variables in the SQL. This option was added in Connector/NET version 5.2.2.
<code>Allow Zero Datetime</code>	false	True to have <code>MySqlDataReader.GetValue()</code> return a <code>MySqlDateTime</code> for date or datetime columns that have illegal values. False will cause a <code>System.DateTime</code> object to be returned for legal values and an exception will be thrown for illegal values.
<code>AutoEnlist</code>	true	
<code>BlobAsUTF8ExcludePattern</code>	null	
<code>BlobAsUTF8IncludePattern</code>	null	
<code>CharSet, Character Set</code>		Specifies the character set that should be used to encode all queries sent to the server. Resultsets are still returned in the character set of the data returned.
<code>Connect Timeout, Connection Timeout</code>	15	The length of time (in seconds) to wait for a connection to the server before terminating the attempt and generating an error.
<code>Connection Reset</code>	false	

Convert Zero Datetime	false	True to have <code>MySqlDataReader.GetValue()</code> and <code>MySqlDataReader.GetDateTime()</code> return <code>DateTime.MinValue</code> for date or datetime columns that have illegal values.
Default Command Timeout		Sets the default value of the command timeout to be used. This does not supercede the individual command timeout property on an individual command object. If you set the command timeout property, that will be used. This option was added in Connector/NET 5.1.4
Encrypt, UseSSL	false	For Connector/NET 5.0.3 and later, when <code>true</code> , SSL encryption is used for all data sent between the client and server if the server has a certificate installed. Recognized values are <code>true</code> , <code>false</code> , <code>yes</code> , and <code>no</code> . In versions before 5.0.3, this option had no effect.
FunctionsReturnString	false	
Host, Server, Data Source, Data-Source, Address, Addr, Network Address	localhost	The name or network address of the instance of MySQL to which to connect. Multiple hosts can be specified separated by <code>&amp;</code> . This can be useful where multiple MySQL servers are configured for replication and you are not concerned about the precise server you are connecting to. No attempt is made by the provider to synchronize writes to the database so care should be taken when using this option. In Unix environment with Mono, this can be a fully qualified path to MySQL socket file name. With this configuration, the Unix socket will be used instead of TCP/IP socket. Currently only a single socket name can be given so accessing MySQL in a replicated environment using Unix sockets is not currently supported.
Ignore Prepare	true	When true, instructs the provider to ignore any calls to <code>MySqlCommand.Prepare()</code> . This option is provided to prevent issues with corruption of the statements when use with server side prepared statements. If you want to use server-side prepare statements, set this option to false. This option was added in Connector/NET 5.0.3 and Connector/NET 1.0.9.
Initial Catalog, Database	mysql	The name of the database to use intially
InteractiveSession	false	
Logging	false	When true, various pieces of information is output to any configured TraceListeners.
Old Syntax, OldSyntax	false	Allows use of '@' symbol as a parameter marker. See <code>MySqlCommand</code> for more info. This option was deprecated in Connector/NET 5.2.2. All future code should be written using the '@' symbol.
Password, pwd		The password for the MySQL account being used.
Persist Security Info	false	When set to <code>false</code> or <code>no</code> (strongly recommended), security-sensitive information, such as the password, is not returned as part of the connection if the connection is open or has ever been in an open state. Re-setting the connection string resets all connection string values including the password. Recognized values are <code>true</code> , <code>false</code> , <code>yes</code> , and <code>no</code> .
Pipe Name, Pipe	mysql	When set to the name of a named pipe, the <code>MySqlConnection</code> will attempt to connect to MySQL on that named pipe. This settings only applies to the Windows platform.
Port	3306	The port MySQL is using to listen for connections. This value is ignored if Unix socket is used.
Procedure Cache Size	25	Sets the size of the stored procedure cache. By default, Connector/NET will store the metadata (input/output datatypes) about the last 25 stored procedures used. To disable the stored procedure cache, set the value to zero (0). This option was added in Connector/NET 5.0.2 and Connector/NET 1.0.9.
Protocol	socket	Specifies the type of connection to make to the server. Values can be: <code>socket</code> or <code>tcp</code> for a socket connection, <code>pipe</code> for a named pipe connection, <code>unix</code> for a Unix socket connection, <code>memory</code> to use MySQL shared memory.
Respect Binary Flags	true	Setting this option to <code>false</code> means that Connector/NET will ignore a column's binary flags as set by the server. This option was added in Connector/NET version 5.1.3.
Shared Memory Name	MYSQL	The name of the shared memory object to use for communication if the connection protocol is set to memory.

<code>TreatBlobsAsUTF8</code>	false	
<code>Treat Tiny As Boolean</code>	true	Setting this value to <code>false</code> indicates that <code>TINYINT(1)</code> will be treated as an <code>INT</code> . See also <a href="#">Section 10.1.1, “Overview of Numeric Types”</a> for a further explanation of the <code>TINYINT</code> and <code>BOOL</code> data types.
<code>Use Affected Rows</code>	false	When <code>true</code> the connection will report changed rows instead of found rows. This option was added in Connector/NET version 5.2.6.
<code>Use Procedure Bodies</code>	true	Setting this option to <code>false</code> indicates that the user connecting to the database does not have the <code>SELECT</code> privileges for the <code>mysql.proc</code> (stored procedures) table. When set to <code>false</code> , Connector/NET will not rely on this information being available when the procedure is called. Because Connector/NET will be unable to determine this information, you should explicitly set the types of all the parameters before the call and the parameters should be added to the command in the exact same order as they appear in the procedure definition. This option was added in Connector/NET 5.0.4 and Connector/NET 1.0.10.
<code>User Id, Username, Uid, User name</code>		The MySQL login account being used.
<code>Use Compression</code>	false	Setting this option to <code>true</code> enables compression of packets exchanged between the client and the server. This exchange is defined by the MySQL client-server protocol.  Compression is used if both client and server support ZLIB compression, and the client has requested compression using this option.  A compressed packet header is: packet length (3 bytes), packet number (1 byte), and Uncompressed Packet Length (3 bytes). The Uncompressed Packet Length is the number of bytes in the original, uncompressed packet. If this is zero then the data in this packet has not been compressed. When the compression protocol is in use, either the client or the server may compress packets. However, compression will not occur if the compressed length is greater than the original length. Thus, some packets will contain compressed data while other packets will not.
<code>Use Usage Advisor</code>	false	
<code>Use Performance Monitor</code>	false	

The following table lists the valid names for connection pooling values within the `ConnectionString`. For more information about connection pooling, see [Connection Pooling](#) for the MySQL Data Provider.

Name	Default	Description
<code>Cache Server Configuration, CacheServerConfiguration, CacheServerConfig</code>	false	Specifies whether server variables should be updated when a pooled connection is returned. Turning this one will yield faster opens but will also not catch any server changes made by other connections.
<code>Connection Lifetime</code>	0	When a connection is returned to the pool, its creation time is compared with the current time, and the connection is destroyed if that time span (in seconds) exceeds the value specified by <code>Connection Lifetime</code> . This is useful in clustered configurations to force load balancing between a running server and a server just brought online. A value of zero (0) causes pooled connections to have the maximum connection timeout.
<code>Max Pool Size</code>	100	The maximum number of connections allowed in the pool.
<code>Min Pool Size</code>	0	The minimum number of connections allowed in the pool.
<code>Pooling</code>	true	When <code>true</code> , the <code>MySqlConnection</code> object is drawn from the appropriate pool, or if necessary, is created and added to the appropriate pool. Recognized values are <code>true</code> , <code>false</code> , <code>yes</code> , and <code>no</code> .
<code>Reset Pooled Connections, ResetConnections, ResetPooledConnections</code>	true	Specifies whether a ping and a reset should be sent to the server before a pooled connection is returned. Not resetting will yield faster connection opens but also will not clear out session items such as temp tables.

#### 20.2.4.6. Using the Connector/NET with Prepared Statements

## Introduction

As of MySQL 4.1, it is possible to use prepared statements with Connector/NET. Use of prepared statements can provide significant performance improvements on queries that are executed more than once.

Prepared execution is faster than direct execution for statements executed more than once, primarily because the query is parsed only once. In the case of direct execution, the query is parsed every time it is executed. Prepared execution also can provide a reduction of network traffic because for each execution of the prepared statement, it is necessary only to send the data for the parameters.

Another advantage of prepared statements is that it uses a binary protocol that makes data transfer between client and server more efficient.

### 20.2.4.6.1. Preparing Statements in Connector/NET

To prepare a statement, create a command object and set the `.CommandText` property to your query.

After entering your statement, call the `.Prepare` method of the `MySQLCommand` object. After the statement is prepared, add parameters for each of the dynamic elements in the query.

After you enter your query and enter parameters, execute the statement using the `.ExecuteNonQuery()`, `.ExecuteScalar()`, or `.ExecuteReader` methods.

For subsequent executions, you need only modify the values of the parameters and call the execute method again, there is no need to set the `.CommandText` property or redefine the parameters.

#### Visual Basic Example

```
Dim conn As New MySqlConnection
Dim cmd As New MySqlCommand

conn.ConnectionString = strConnection

Try
    conn.Open()
    cmd.Connection = conn

    cmd.CommandText = "INSERT INTO myTable VALUES(NULL, @number, @text)"
    cmd.Prepare()

    cmd.Parameters.Add("@number", 1)
    cmd.Parameters.Add("@text", "One")

    For i = 1 To 1000
        cmd.Parameters["@number"].Value = i
        cmd.Parameters["@text"].Value = "A string value"

        cmd.ExecuteNonQuery()
    Next
Catch ex As MySqlException
    MessageBox.Show("Error " & ex.Number & " has occurred: " & ex.Message, "Error", MessageBoxButtons.OK, MessageBoxIcon.Error)
End Try
```

#### C# Example

```
MySQL.Data.MySqlClient.MySqlConnection conn;
MySQL.Data.MySqlClient.MySqlCommand cmd;

conn = new MySQL.Data.MySqlClient.MySqlConnection();
cmd = new MySQL.Data.MySqlClient.MySqlCommand();

conn.ConnectionString = strConnection;

try
{
    conn.Open();
    cmd.Connection = conn;

    cmd.CommandText = "INSERT INTO myTable VALUES(NULL, @number, @text)";
    cmd.Prepare();

    cmd.Parameters.Add("@number", 1);
    cmd.Parameters.Add("@text", "One");

    for (int i=1; i <= 1000; i++)
    {
        cmd.Parameters["@number"].Value = i;
        cmd.Parameters["@text"].Value = "A string value";

        cmd.ExecuteNonQuery();
    }
}
catch (MySQL.Data.MySqlClient.MySqlException ex)
```

```
{
    MessageBox.Show("Error " + ex.Number + " has occurred: " + ex.Message,
        "Error", MessageBoxButtons.OK, MessageBoxIcon.Error);
}
```

## 20.2.4.7. Accessing Stored Procedures with Connector/NET

### Introduction

With the release of MySQL version 5 the MySQL server now supports stored procedures with the SQL 2003 stored procedure syntax.

A stored procedure is a set of SQL statements that can be stored in the server. Once this has been done, clients do not need to keep reissuing the individual statements but can refer to the stored procedure instead.

Stored procedures can be particularly useful in situations such as the following:

- When multiple client applications are written in different languages or work on different platforms, but need to perform the same database operations.
- When security is paramount. Banks, for example, use stored procedures for all common operations. This provides a consistent and secure environment, and procedures can ensure that each operation is properly logged. In such a setup, applications and users would not get any access to the database tables directly, but can only execute specific stored procedures.

Connector/NET supports the calling of stored procedures through the `MySQLCommand` object. Data can be passed in and out of a MySQL stored procedure through use of the `MySQLCommand.Parameters` collection.

### Note

When you call a stored procedure, the command object makes an additional `SELECT` call to determine the parameters of the stored procedure. You must ensure that the user calling the procedure has the `SELECT` privilege on the `mysql.proc` table to enable them to verify the parameters. Failure to do this will result in an error when calling the procedure.

This section will not provide in-depth information on creating Stored Procedures. For such information, please refer to <http://dev.mysql.com/doc/mysql/en/stored-routines.html>.

A sample application demonstrating how to use stored procedures with Connector/NET can be found in the `Samples` directory of your Connector/NET installation.

### 20.2.4.7.1. Creating Stored Procedures from Connector/NET

Stored procedures in MySQL can be created using a variety of tools. First, stored procedures can be created using the `mysql` command-line client. Second, stored procedures can be created using the `MySQL Query Browser` GUI client. Finally, stored procedures can be created using the `.ExecuteNonQuery` method of the `MySQLCommand` object:

#### Visual Basic Example

```
Dim conn As New MySqlConnection
Dim cmd As New MySqlCommand

conn.ConnectionString = "server=127.0.0.1;" _
    & "uid=root;" _
    & "pwd=12345;" _
    & "database=test"

Try
    conn.Open()
    cmd.Connection = conn

    cmd.CommandText = "CREATE PROCEDURE add_emp(" _
        & "IN fname VARCHAR(20), IN lname VARCHAR(20), IN bday DATETIME, OUT empno INT) " _
        & "BEGIN INSERT INTO emp(first_name, last_name, birthdate) " _
        & "VALUES(fname, lname, DATE(bday)); SET empno = LAST_INSERT_ID(); END"

    cmd.ExecuteNonQuery()
Catch ex As MySqlException
    MessageBox.Show("Error " & ex.Number & " has occurred: " & ex.Message, "Error", MessageBoxButtons.OK, MessageBoxIcon.Error)
End Try
```

#### C# Example

```
MySQL.Data.MySqlClient.MySqlConnection conn;
MySQL.Data.MySqlClient.MySqlCommand cmd;
```

```

conn = new MySql.Data.MySqlClient.MySqlConnection();
cmd = new MySql.Data.MySqlClient.MySqlCommand();

conn.ConnectionString = "server=127.0.0.1;uid=root;" +
    "pwd=12345;database=test;";

try
{
    conn.Open();
    cmd.Connection = conn;

    cmd.CommandText = "CREATE PROCEDURE add_emp(" +
        "IN fname VARCHAR(20), IN lname VARCHAR(20), IN bday DATETIME, OUT empno INT) " +
        "BEGIN INSERT INTO emp(first_name, last_name, birthdate) " +
        "VALUES(fname, lname, DATE(bday)); SET empno = LAST_INSERT_ID(); END";

    cmd.ExecuteNonQuery();
}
catch (MySql.Data.MySqlClient.MySqlException ex)
{
    MessageBox.Show("Error " + ex.Number + " has occurred: " + ex.Message,
        "Error", MessageBoxButtons.OK, MessageBoxIcon.Error);
}

```

It should be noted that, unlike the command-line and GUI clients, you are not required to specify a special delimiter when creating stored procedures in Connector/NET.

### 20.2.4.7.2. Calling a Stored Procedure from Connector/NET

To call a stored procedure using Connector/NET, create a `MySqlCommand` object and pass the stored procedure name as the `.CommandText` property. Set the `.CommandType` property to `CommandType.StoredProcedure`.

After the stored procedure is named, create one `MySqlCommand` parameter for every parameter in the stored procedure. `IN` parameters are defined with the parameter name and the object containing the value, `OUT` parameters are defined with the parameter name and the datatype that is expected to be returned. All parameters need the parameter direction defined.

After defining parameters, call the stored procedure by using the `MySqlCommand.ExecuteNonQuery()` method:

#### Visual Basic Example

```

Dim conn As New MySqlConnection
Dim cmd As New MySqlCommand

conn.ConnectionString = "server=127.0.0.1;" & _
    & "uid=root;" & _
    & "pwd=12345;" & _
    & "database=test"

Try
    conn.Open()
    cmd.Connection = conn

    cmd.CommandText = "add_emp"
    cmd.CommandType = CommandType.StoredProcedure

    cmd.Parameters.Add("@lname", 'Jones')
    cmd.Parameters["@lname"].Direction = ParameterDirection.Input

    cmd.Parameters.Add("@fname", 'Tom')
    cmd.Parameters["@fname"].Direction = ParameterDirection.Input

    cmd.Parameters.Add("@bday", #12/13/1977 2:17:36 PM#)
    cmd.Parameters["@bday"].Direction = ParameterDirection.Input

    cmd.Parameters.Add("@empno", MySqlDbType.Int32)
    cmd.Parameters["@empno"].Direction = ParameterDirection.Output

    cmd.ExecuteNonQuery()

    MessageBox.Show(cmd.Parameters["@empno"].Value)
Catch ex As MySqlException
    MessageBox.Show("Error " & ex.Number & " has occurred: " & ex.Message, "Error", MessageBoxButtons.OK, MessageBoxIcon.Error)
End Try

```

#### C# Example

```

MySql.Data.MySqlClient.MySqlConnection conn;
MySql.Data.MySqlClient.MySqlCommand cmd;

conn = new MySql.Data.MySqlClient.MySqlConnection();
cmd = new MySql.Data.MySqlClient.MySqlCommand();

conn.ConnectionString = "server=127.0.0.1;uid=root;" +
    "pwd=12345;database=test;";

try
{

```



```

conn.Open();
cmd.Connection = conn;

cmd.CommandText = "add_emp";
cmd.CommandType = CommandType.StoredProcedure;

cmd.Parameters.Add("@lname", "Jones");
cmd.Parameters["@lname"].Direction = ParameterDirection.Input;

cmd.Parameters.Add("@fname", "Tom");
cmd.Parameters["@fname"].Direction = ParameterDirection.Input;

cmd.Parameters.Add("@bday", DateTime.Parse("12/13/1977 2:17:36 PM"));
cmd.Parameters["@bday"].Direction = ParameterDirection.Input;

cmd.Parameters.Add("@empno", MySqlDbType.Int32);
cmd.Parameters["@empno"].Direction = ParameterDirection.Output;

cmd.ExecuteNonQuery();

MessageBox.Show(cmd.Parameters["@empno"].Value);
}
catch (MySql.Data.MySqlClient.MySqlException ex)
{
    MessageBox.Show("Error " + ex.Number + " has occurred: " + ex.Message,
        "Error", MessageBoxButtons.OK, MessageBoxIcon.Error);
}

```

Once the stored procedure is called, the values of output parameters can be retrieved by using the `.Value` property of the `MySqlConnector.Parameters` collection.

## 20.2.4.8. Handling BLOB Data With Connector/NET

### Introduction

One common use for MySQL is the storage of binary data in **BLOB** columns. MySQL supports four different BLOB datatypes: `TINYBLOB`, `BLOB`, `MEDIUMBLOB`, and `LONGBLOB`.

Data stored in a BLOB column can be accessed using Connector/NET and manipulated using client-side code. There are no special requirements for using Connector/NET with BLOB data.

Simple code examples will be presented within this section, and a full sample application can be found in the `Samples` directory of the Connector/NET installation.

### 20.2.4.8.1. Preparing the MySQL Server

The first step in using MySQL with BLOB data is to configure the server. Let's start by creating a table to be accessed. In my file tables, I usually have four columns: an `AUTO_INCREMENT` column of appropriate size (`UNSIGNED SMALLINT`) to serve as a primary key to identify the file, a `VARCHAR` column that stores the file name, an `UNSIGNED MEDIUMINT` column that stores the size of the file, and a `MEDIUMBLOB` column that stores the file itself. For this example, I will use the following table definition:

```

CREATE TABLE file(
file_id SMALLINT UNSIGNED AUTO_INCREMENT NOT NULL PRIMARY KEY,
file_name VARCHAR(64) NOT NULL,
file_size MEDIUMINT UNSIGNED NOT NULL,
file MEDIUMBLOB NOT NULL);

```

After creating a table, you may need to modify the `max_allowed_packet` system variable. This variable determines how large of a packet (i.e. a single row) can be sent to the MySQL server. By default, the server will only accept a maximum size of 1 meg from our client application. If you do not intend to exceed 1 meg, this should be fine. If you do intend to exceed 1 meg in your file transfers, this number has to be increased.

The `max_allowed_packet` option can be modified using MySQL Administrator's Startup Variables screen. Adjust the Maximum allowed option in the Memory section of the Networking tab to an appropriate setting. After adjusting the value, click the `APPLY CHANGES` button and restart the server using the `Service Control` screen of MySQL Administrator. You can also adjust this value directly in the `my.cnf` file (add a line that reads `max_allowed_packet=xxM`), or use the `SET max_allowed_packet=xxM`; syntax from within MySQL.

Try to be conservative when setting `max_allowed_packet`, as transfers of BLOB data can take some time to complete. Try to set a value that will be adequate for your intended use and increase the value if necessary.

### 20.2.4.8.2. Writing a File to the Database

To write a file to a database we need to convert the file to a byte array, then use the byte array as a parameter to an `INSERT` query.

The following code opens a file using a `FileStream` object, reads it into a byte array, and inserts it into the `file` table:

## Visual Basic Example

```

Dim conn As New MySqlConnection
Dim cmd As New MySqlCommand

Dim SQL As String

Dim FileSize As UInt32
Dim rawData() As Byte
Dim fs As FileStream

conn.ConnectionString = "server=127.0.0.1;" _
    & "uid=root;" _
    & "pwd=12345;" _
    & "database=test"

Try
    fs = New FileStream("c:\image.png", FileMode.Open, FileAccess.Read)
    FileSize = fs.Length

    rawData = New Byte(FileSize) {}
    fs.Read(rawData, 0, FileSize)
    fs.Close()

    conn.Open()

    SQL = "INSERT INTO file VALUES(NULL, @FileName, @FileSize, @File)"

    cmd.Connection = conn
    cmd.CommandText = SQL
    cmd.Parameters.Add("@FileName", strFileName)
    cmd.Parameters.Add("@FileSize", FileSize)
    cmd.Parameters.Add("@File", rawData)

    cmd.ExecuteNonQuery()

    MessageBox.Show("File Inserted into database successfully!", _
        "Success!", MessageBoxButtons.OK, MessageBoxIcon.Asterisk)

    conn.Close()
Catch ex As Exception
    MessageBox.Show("There was an error: " & ex.Message, "Error", _
        MessageBoxButtons.OK, MessageBoxIcon.Error)
End Try

```

## C# Example

```

MySQL.Data.MySqlClient.MySqlConnection conn;
MySQL.Data.MySqlClient.MySqlCommand cmd;

conn = new MySQL.Data.MySqlClient.MySqlConnection();
cmd = new MySQL.Data.MySqlClient.MySqlCommand();

string SQL;
UInt32 FileSize;
byte[] rawData;
FileStream fs;

conn.ConnectionString = "server=127.0.0.1;uid=root;" +
    "pwd=12345;database=test;";

try
{
    fs = new FileStream(@"c:\image.png", FileMode.Open, FileAccess.Read);
    FileSize = fs.Length;

    rawData = new byte[FileSize];
    fs.Read(rawData, 0, FileSize);
    fs.Close();

    conn.Open();

    SQL = "INSERT INTO file VALUES(NULL, @FileName, @FileSize, @File)";

    cmd.Connection = conn;
    cmd.CommandText = SQL;
    cmd.Parameters.Add("@FileName", strFileName);
    cmd.Parameters.Add("@FileSize", FileSize);
    cmd.Parameters.Add("@File", rawData);

    cmd.ExecuteNonQuery();

    MessageBox.Show("File Inserted into database successfully!",
        "Success!", MessageBoxButtons.OK, MessageBoxIcon.Asterisk);

    conn.Close();
}
catch (MySQL.Data.MySqlClient.MySqlException ex)
{
    MessageBox.Show("Error " + ex.Number + " has occurred: " + ex.Message,
        "Error", MessageBoxButtons.OK, MessageBoxIcon.Error);
}

```

The `Read` method of the `FileStream` object is used to load the file into a byte array which is sized according to the `Length` property of the `FileStream` object.

After assigning the byte array as a parameter of the `MySQLCommand` object, the `ExecuteNonQuery` method is called and the BLOB is inserted into the `file` table.

### 20.2.4.8.3. Reading a BLOB from the Database to a File on Disk

Once a file is loaded into the `file` table, we can use the `MySQLDataReader` class to retrieve it.

The following code retrieves a row from the `file` table, then loads the data into a `FileStream` object to be written to disk:

#### Visual Basic Example

```
Dim conn As New MySqlConnection
Dim cmd As New MySqlCommand
Dim myData As MySQLDataReader
Dim SQL As String
Dim rawData() As Byte
Dim FileSize As UInt32
Dim fs As FileStream

conn.ConnectionString = "server=127.0.0.1;" _
    & "uid=root;" _
    & "pwd=12345;" _
    & "database=test"

SQL = "SELECT file_name, file_size, file FROM file"

Try
    conn.Open()

    cmd.Connection = conn
    cmd.CommandText = SQL

    myData = cmd.ExecuteReader

    If Not myData.HasRows Then Throw New Exception("There are no BLOBs to save")

    myData.Read()

    FileSize = myData.GetUInt32(myData.GetOrdinal("file_size"))
    rawData = New Byte(FileSize) {}

    myData.GetBytes(myData.GetOrdinal("file"), 0, rawData, 0, FileSize)

    fs = New FileStream("C:\newfile.png", FileMode.OpenOrCreate, FileAccess.Write)
    fs.Write(rawData, 0, FileSize)
    fs.Close()

    MessageBox.Show("File successfully written to disk!", "Success!", MessageBoxButtons.OK, MessageBoxIcon.Asterisk)

    myData.Close()
    conn.Close()
Catch ex As Exception
    MessageBox.Show("There was an error: " & ex.Message, "Error", MessageBoxButtons.OK, MessageBoxIcon.Error)
End Try
```

#### C# Example

```
MySQL.Data.MySQLClient.MySqlConnection conn;
MySQL.Data.MySQLClient.MySqlCommand cmd;
MySQL.Data.MySQLClient.MySQLDataReader myData;

conn = new MySQL.Data.MySQLClient.MySqlConnection();
cmd = new MySQL.Data.MySQLClient.MySqlCommand();

string SQL;
UInt32 FileSize;
byte[] rawData;
FileStream fs;

conn.ConnectionString = "server=127.0.0.1;uid=root;" +
    "pwd=12345;database=test;";

SQL = "SELECT file_name, file_size, file FROM file";

try
{
    conn.Open();

    cmd.Connection = conn;
    cmd.CommandText = SQL;

    myData = cmd.ExecuteReader();

    if (! myData.HasRows)
        throw new Exception("There are no BLOBs to save");
```

```

myData.Read();
FileSize = myData.GetUInt32(myData.GetOrdinal("file_size"));
rawData = new byte[FileSize];

myData.GetBytes(myData.GetOrdinal("file"), 0, rawData, 0, FileSize);

fs = new FileStream(@"C:\newfile.png", FileMode.OpenOrCreate, FileAccess.Write);
fs.Write(rawData, 0, FileSize);
fs.Close();

MessageBox.Show("File successfully written to disk!",
    "Success!", MessageBoxButtons.OK, MessageBoxIcon.Asterisk);

myData.Close();
conn.Close();
}
catch (MySql.Data.MySqlClient.MySqlException ex)
{
    MessageBox.Show("Error " + ex.Number + " has occurred: " + ex.Message,
        "Error", MessageBoxButtons.OK, MessageBoxIcon.Error);
}

```

After connecting, the contents of the `file` table are loaded into a `MySqlDataReader` object. The `GetBytes` method of the `MySqlDataReader` is used to load the BLOB into a byte array, which is then written to disk using a `FileStream` object.

The `GetOrdinal` method of the `MySqlDataReader` can be used to determine the integer index of a named column. Use of the `GetOrdinal` method prevents errors if the column order of the `SELECT` query is changed.

## 20.2.4.9. Using Connector/NET with Crystal Reports

### Introduction

Crystal Reports is a common tool used by Windows application developers to perform reporting and document generation. In this section we will show how to use Crystal Reports XI with MySQL and Connector/NET.

### 20.2.4.9.1. Creating a Data Source

When creating a report in Crystal Reports there are two options for accessing the MySQL data while designing your report.

The first option is to use Connector/ODBC as an ADO data source when designing your report. You will be able to browse your database and choose tables and fields using drag and drop to build your report. The disadvantage of this approach is that additional work must be performed within your application to produce a data set that matches the one expected by your report.

The second option is to create a data set in VB.NET and save it as XML. This XML file can then be used to design a report. This works quite well when displaying the report in your application, but is less versatile at design time because you must choose all relevant columns when creating the data set. If you forget a column you must re-create the data set before the column can be added to the report.

The following code can be used to create a data set from a query and write it to disk:

#### Visual Basic Example

```

Dim myData As New DataSet
Dim conn As New MySqlConnection
Dim cmd As New MySqlCommand
Dim myAdapter As New MySqlDataAdapter

conn.ConnectionString = "server=127.0.0.1;" _
    & "uid=root;" _
    & "pwd=12345;" _
    & "database=world"

Try
    conn.Open()
    cmd.CommandText = "SELECT city.name AS cityName, city.population AS CityPopulation, " _
        & "country.name, country.population, country.continent " _
        & "FROM country, city ORDER BY country.continent, country.name"
    cmd.Connection = conn

    myAdapter.SelectCommand = cmd
    myAdapter.Fill(myData)

    myData.WriteXml("C:\dataset.xml", XmlWriteMode.WriteSchema)
Catch ex As Exception
    MessageBox.Show(ex.Message, "Report could not be created", MessageBoxButtons.OK, MessageBoxIcon.Error)
End Try

```

#### C# Example

```

DataSet myData = new DataSet();
MySQL.Data.MySqlClient.MySqlConnection conn;
MySQL.Data.MySqlClient.MySqlCommand cmd;
MySQL.Data.MySqlClient.MySqlDataAdapter myAdapter;

conn = new MySQL.Data.MySqlClient.MySqlConnection();
cmd = new MySQL.Data.MySqlClient.MySqlCommand();
myAdapter = new MySQL.Data.MySqlClient.MySqlDataAdapter();

conn.ConnectionString = "server=127.0.0.1;uid=root;" +
    "pwd=12345;database=test;";

try
{
    cmd.CommandText = "SELECT city.name AS cityName, city.population AS CityPopulation, " +
        "country.name, country.population, country.continent " +
        "FROM country, city ORDER BY country.continent, country.name";
    cmd.Connection = conn;

    myAdapter.SelectCommand = cmd;
    myAdapter.Fill(myData);

    myData.WriteXml(@"C:\dataset.xml", XmlWriteMode.WriteSchema);
}
catch (MySQL.Data.MySqlClient.MySqlException ex)
{
    MessageBox.Show(ex.Message, "Report could not be created",
        MessageBoxButtons.OK, MessageBoxIcon.Error);
}

```

The resulting XML file can be used as an ADO.NET XML datasource when designing your report.

If you choose to design your reports using Connector/ODBC, it can be downloaded from [dev.mysql.com](http://dev.mysql.com).

### 20.2.4.9.2. Creating the Report

For most purposes the Standard Report wizard should help with the initial creation of a report. To start the wizard, open Crystal Reports and choose the New > Standard Report option from the File menu.

The wizard will first prompt you for a data source. If you are using Connector/ODBC as your data source, use the OLEDB provider for ODBC option from the OLE DB (ADO) tree instead of the ODBC (RDO) tree when choosing a data source. If using a saved data set, choose the ADO.NET (XML) option and browse to your saved data set.

The remainder of the report creation process is done automatically by the wizard.

After the report is created, choose the Report Options... entry of the File menu. Un-check the Save Data With Report option. This prevents saved data from interfering with the loading of data within our application.

### 20.2.4.9.3. Displaying the Report

To display a report we first populate a data set with the data needed for the report, then load the report and bind it to the data set. Finally we pass the report to the crViewer control for display to the user.

The following references are needed in a project that displays a report:

- CrystalDecisions.CrystalReports.Engine
- CrystalDecisions.ReportSource
- CrystalDecisions.Shared
- CrystalDecisions.Windows.Forms

The following code assumes that you created your report using a data set saved using the code shown in [Section 20.2.4.9.1, "Creating a Data Source"](#), and have a crViewer control on your form named `myViewer`.

Visual Basic Example

```

Imports CrystalDecisions.CrystalReports.Engine
Imports System.Data
Imports MySQL.Data.MySqlClient

Dim myReport As New ReportDocument
Dim myData As New DataSet
Dim conn As New MySqlConnection
Dim cmd As New MySqlCommand
Dim myAdapter As New MySqlDataAdapter

conn.ConnectionString = _

```

```

"server=127.0.0.1;" _
& "uid=root;" _
& "pwd=12345;" _
& "database=test"

Try
    conn.Open()

    cmd.CommandText = "SELECT city.name AS cityName, city.population AS CityPopulation, " _
        & "country.name, country.population, country.continent " _
        & "FROM country, city ORDER BY country.continent, country.name"
    cmd.Connection = conn

    myAdapter.SelectCommand = cmd
    myAdapter.Fill(myData)

    myReport.Load(".\world_report.rpt")
    myReport.SetDataSource(myData)
    myViewer.ReportSource = myReport
Catch ex As Exception
    MessageBox.Show(ex.Message, "Report could not be created", MessageBoxButtons.OK, MessageBoxIcon.Error)
End Try

```

### C# Example

```

using CrystalDecisions.CrystalReports.Engine;
using System.Data;
using MySql.Data.MySqlClient;

ReportDocument myReport = new ReportDocument();
DataSet myData = new DataSet();
MySql.Data.MySqlClient.MySqlConnection conn;
MySql.Data.MySqlClient.MySqlCommand cmd;
MySql.Data.MySqlClient.MySqlDataAdapter myAdapter;

conn = new MySql.Data.MySqlClient.MySqlConnection();
cmd = new MySql.Data.MySqlClient.MySqlCommand();
myAdapter = new MySql.Data.MySqlClient.MySqlDataAdapter();

conn.ConnectionString = "server=127.0.0.1;uid=root;" +
    "pwd=12345;database=test;";

try
{
    cmd.CommandText = "SELECT city.name AS cityName, city.population AS CityPopulation, " +
        "country.name, country.population, country.continent " +
        "FROM country, city ORDER BY country.continent, country.name";
    cmd.Connection = conn;

    myAdapter.SelectCommand = cmd;
    myAdapter.Fill(myData);

    myReport.Load(@".\world_report.rpt");
    myReport.SetDataSource(myData);
    myViewer.ReportSource = myReport;
}
catch (MySql.Data.MySqlClient.MySqlException ex)
{
    MessageBox.Show(ex.Message, "Report could not be created",
        MessageBoxButtons.OK, MessageBoxIcon.Error);
}

```

A new data set is generated using the same query used to generate the previously saved data set. Once the data set is filled, a `ReportDocument` is used to load the report file and bind it to the data set. The `ReportDocument` is then passed as the `ReportSource` of the `crViewer`.

This same approach is taken when a report is created from a single table using Connector/ODBC. The data set replaces the table used in the report and the report is displayed properly.

When a report is created from multiple tables using Connector/ODBC, a data set with multiple tables must be created in our application. This allows each table in the report data source to be replaced with a report in the data set.

We populate a data set with multiple tables by providing multiple `SELECT` statements in our `MySqlCommand` object. These `SELECT` statements are based on the SQL query shown in Crystal Reports in the Database menu's Show SQL Query option. Assume the following query:

```

SELECT `country`.`Name`, `country`.`Continent`, `country`.`Population`, `city`.`Name`, `city`.`Population`
FROM `world`.`country` `country` LEFT OUTER JOIN `world`.`city` `city` ON `country`.`Code`=`city`.`CountryCode`
ORDER BY `country`.`Continent`, `country`.`Name`, `city`.`Name`

```

This query is converted to two `SELECT` queries and displayed with the following code:

### Visual Basic Example

```

Imports CrystalDecisions.CrystalReports.Engine
Imports System.Data

```

```
Imports MySql.Data.MySqlClient

Dim myReport As New ReportDocument
Dim myData As New DataSet
Dim conn As New MySqlConnection
Dim cmd As New MySqlCommand
Dim myAdapter As New MySqlDataAdapter

conn.ConnectionString = "server=127.0.0.1;" _
    & "uid=root;" _
    & "pwd=12345;" _
    & "database=world"

Try
    conn.Open()
    cmd.CommandText = "SELECT name, population, countrycode FROM city ORDER BY countrycode, name;" _
        & "SELECT name, population, code, continent FROM country ORDER BY continent, name"
    cmd.Connection = conn

    myAdapter.SelectCommand = cmd
    myAdapter.Fill(myData)

    myReport.Load(".\world_report.rpt")
    myReport.Database.Tables(0).SetDataSource(myData.Tables(0))
    myReport.Database.Tables(1).SetDataSource(myData.Tables(1))
    myViewer.ReportSource = myReport
Catch ex As Exception
    MessageBox.Show(ex.Message, "Report could not be created", MessageBoxButtons.OK, MessageBoxIcon.Error)
End Try
```

### C# Example

```
using CrystalDecisions.CrystalReports.Engine;
using System.Data;
using MySql.Data.MySqlClient;

ReportDocument myReport = new ReportDocument();
DataSet myData = new DataSet();
MySql.Data.MySqlClient.MySqlConnection conn;
MySql.Data.MySqlClient.MySqlCommand cmd;
MySql.Data.MySqlClient.MySqlDataAdapter myAdapter;

conn = new MySql.Data.MySqlClient.MySqlConnection();
cmd = new MySql.Data.MySqlClient.MySqlCommand();
myAdapter = new MySql.Data.MySqlClient.MySqlDataAdapter();

conn.ConnectionString = "server=127.0.0.1;uid=root;" +
    "pwd=12345;database=test;";

try
{
    cmd.CommandText = "SELECT name, population, countrycode FROM city ORDER " +
        "BY countrycode, name; SELECT name, population, code, continent FROM " +
        "country ORDER BY continent, name";
    cmd.Connection = conn;

    myAdapter.SelectCommand = cmd;
    myAdapter.Fill(myData);

    myReport.Load(@".\world_report.rpt");
    myReport.Database.Tables(0).SetDataSource(myData.Tables(0));
    myReport.Database.Tables(1).SetDataSource(myData.Tables(1));
    myViewer.ReportSource = myReport;
}
catch (MySql.Data.MySqlClient.MySqlException ex)
{
    MessageBox.Show(ex.Message, "Report could not be created",
        MessageBoxButtons.OK, MessageBoxIcon.Error);
}
}
```

It is important to order the [SELECT](#) queries in alphabetical order, as this is the order the report will expect its source tables to be in. One `SetDataSource` statement is needed for each table in the report.

This approach can cause performance problems because Crystal Reports must bind the tables together on the client-side, which will be slower than using a pre-saved data set.

## 20.2.4.10. Handling Date and Time Information in Connector/NET

### Introduction

MySQL and the .NET languages handle date and time information differently, with MySQL allowing dates that cannot be represented by a .NET data type, such as '0000-00-00 00:00:00'. These differences can cause problems if not properly handled.

In this section we will demonstrate how to properly handle date and time information when using Connector/NET.

#### 20.2.4.10.1. Problems when Using Invalid Dates

The differences in date handling can cause problems for developers who use invalid dates. Invalid MySQL dates cannot be loaded into native .NET `DateTime` objects, including `NULL` dates.

Because of this issue, .NET `DataSet` objects cannot be populated by the `Fill` method of the `MySqlDataAdapter` class as invalid dates will cause a `System.ArgumentOutOfRangeException` exception to occur.

### 20.2.4.10.2. Restricting Invalid Dates

The best solution to the date problem is to restrict users from entering invalid dates. This can be done on either the client or the server side.

Restricting invalid dates on the client side is as simple as always using the .NET `DateTime` class to handle dates. The `DateTime` class will only allow valid dates, ensuring that the values in your database are also valid. The disadvantage of this is that it is not useful in a mixed environment where .NET and non .NET code are used to manipulate the database, as each application must perform its own date validation.

Users of MySQL 5.0.2 and higher can use the new `traditional` SQL mode to restrict invalid date values. For information on using the `traditional` SQL mode, see [Section 5.1.7, “Server SQL Modes”](#).

### 20.2.4.10.3. Handling Invalid Dates

Although it is strongly recommended that you avoid the use of invalid dates within your .NET application, it is possible to use invalid dates by means of the `MySqlDateTime` datatype.

The `MySqlDateTime` datatype supports the same date values that are supported by the MySQL server. The default behavior of Connector/NET is to return a .NET `DateTime` object for valid date values, and return an error for invalid dates. This default can be modified to cause Connector/NET to return `MySqlDateTime` objects for invalid dates.

To instruct Connector/NET to return a `MySqlDateTime` object for invalid dates, add the following line to your connection string:

```
Allow Zero Datetime=True
```

Please note that the use of the `MySqlDateTime` class can still be problematic. The following are some known issues:

1. Data binding for invalid dates can still cause errors (zero dates like 0000-00-00 do not seem to have this problem).
2. The `ToString` method return a date formatted in the standard MySQL format (for example, 2005-02-23 08:50:25). This differs from the `ToString` behavior of the .NET `DateTime` class.
3. The `MySqlDateTime` class supports `NULL` dates, while the .NET `DateTime` class does not. This can cause errors when trying to convert a `MySqlDateTime` to a `DateTime` if you do not check for `NULL` first.

Because of the known issues, the best recommendation is still to use only valid dates in your application.

### 20.2.4.10.4. Handling NULL Dates

The .NET `DateTime` datatype cannot handle `NULL` values. As such, when assigning values from a query to a `DateTime` variable, you must first check whether the value is in fact `NULL`.

When using a `MySqlDataReader`, use the `.IsDBNull` method to check whether a value is `NULL` before making the assignment:

#### Visual Basic Example

```
If Not myReader.IsDBNull(myReader.GetOrdinal("mytime")) Then
    myTime = myReader.GetDateTime(myReader.GetOrdinal("mytime"))
Else
    myTime = DateTime.MinValue
End If
```

#### C# Example

```
if (! myReader.IsDBNull(myReader.GetOrdinal("mytime")))
    myTime = myReader.GetDateTime(myReader.GetOrdinal("mytime"));
else
    myTime = DateTime.MinValue;
```



[NULL](#) values will work in a data set and can be bound to form controls without special handling.

### 20.2.4.11. ASP.NET Provider Model

MySQL Connector/Net provides support for the ASP.NET 2.0 provider model. This model allows application developers to focus on the business logic of their application instead of having to recreate such boilerplate items as membership and roles support. Currently, only membership and role providers are supplied although session state and profile providers will be provided in upcoming releases.

#### Installing The Providers

The installation of Connector/Net 5.1 or later will install the providers and register them in your machine's .NET configuration file. The providers are implemented in the file `mysql.web.dll` and this file can be found in your Connector/Net installation folder. There is no need to run any type of SQL script to setup the database as the providers create and maintain the proper schema automatically.

#### Using The Providers

The easiest way to start using the providers is to use the ASP.NET configuration tool that is available on the Solution Explorer toolbar when you have a website project loaded.

In the web pages that open you will be able to select the MySQL membership and roles provider by indicating that you want to pick a custom provider for each area.

When the provider is installed, it creates a dummy connection string named `LocalMySqlServer`. This has to be done so that the provider will work in the ASP.NET configuration tool. However, you will want to override this connection string in your `web.config` file. You do this by first removing the dummy connection string and then adding in the proper one. Here is an example:

```
<connectionStrings>
  <remove name="LocalMySqlServer" />
  <add name="LocalMySqlServer" connectionString="server=xxx;uid=xxx;pwd=xxx" />
</connectionStrings>
```

#### Distribution

To use the providers on a production server you will need to distribute the `MySql.Data` and the `MySql.Web` assemblies and either register them in the remote system's Global Assembly Cache or keep them in your application's bin folder.

### 20.2.4.12. Binary/Nonbinary Issues

There are certain situations where MySQL will return incorrect metadata about one or more columns. More specifically, the server will sometimes report that a column is binary when it is not and vice versa. In these situations, it becomes practically impossible for the connector to be able to correctly identify the correct metadata.

Some examples of situations that may return incorrect metadata are:

- Execution of `SHOW PROCESSLIST`. Some of the columns will be returned as binary even though they only hold string data.
- When a temp table is used to process a resultset, some columns may be returned with incorrect binary flags.
- Some server functions such `DATE_FORMAT` will incorrectly return the column as binary.

With the availability of `BINARY` and `VARBINARY` data types it is important that we respect the metadata returned by the server. However, we are aware that some existing applications may break with this change so we are creating a connection string option to enable or disable it. By default, Connector/Net 5.1 will respect the binary flags returned by the server. This will mean that you may need to make small changes to your application to accommodate this change.

In the event that the changes required to your application would be too large, you can add `'respect binary flags=false'` to your connection string. This will cause the connector to use the prior behavior. In a nutshell, that behavior was that any column that is marked as string, regardless of binary flags, will be returned as string. Only columns that are specifically marked as `BLOB` will be returned as `BLOB`.

### 20.2.4.13. Character Sets

#### Treating Binary Blobs As UTF8

MySQL doesn't currently support 4 byte UTF8 sequences. This makes it difficult to represent some multi-byte languages such as Japanese. To try and alleviate this, Connector/Net now supports a mode where binary blobs can be treated as strings.

To do this, you set the 'Treat Blobs As UTF8' connection string keyword to yes. This is all that needs to be done to enable conversion of all binary blobs to UTF8 strings. If you wish to convert only some of your blob columns, then you can make use of the 'BlobAsUTF8IncludePattern' and 'BlobAsUTF8ExcludePattern' keywords. These should be set to the regular expression pattern that matches the column names you wish to include or exclude respectively.

One thing to note is that the regular expression patterns can both match a single column. When this happens, the include pattern is applied before the exclude pattern. The result, in this case, would be that the column would be excluded. You should also be aware that this mode does not apply to columns of type `BINARY` or `VARBINARY` and also do not apply to nonbinary `BLOB` columns.

Currently this mode only applies to reading strings out of MySQL. To insert 4-byte UTF8 strings into blob columns you will need to use the `.NET Encoding.GetBytes` function to convert your string to a series of bytes. You can then set this byte array as a parameter for a `BLOB` column.

#### 20.2.4.14. Working with medium trust

.NET applications operate under a given trust level. Normal desktop applications operate under full trust while web applications that are hosted in shared environments are normally run under the medium trust level. Some hosting providers host shared applications in their own app pools and allow the application to run under full trust, but this seems to be the exception rather than the rule.

Connector/Net versions prior to 5.0.8 and 5.1.3 were not compatible with medium trust hosting. Starting with these versions, Connector/Net can be used under medium trust hosting that has been modified to allow the use of sockets for communication. By default, medium trust does not include `SocketPermission`. Connector/Net uses sockets to talk with the MySQL server so it is required that a new trust level be created that is an exact clone of medium trust but that has `SocketPermission` added.

### 20.2.5. Connector/NET Support

The developers of Connector/NET greatly value the input of our users in the software development process. If you find Connector/NET lacking some feature important to you, or if you discover a bug and need to file a bug report, please use the instructions in [Section 1.6, "How to Report Bugs or Problems"](#).

#### 20.2.5.1. Connector/NET Community Support

- Community support for Connector/NET can be found through the forums at <http://forums.mysql.com>.
- Community support for Connector/NET can also be found through the mailing lists at <http://lists.mysql.com>.
- Paid support is available from Sun Microsystems, Inc. Additional information is available at <http://www.mysql.com/support/>.

#### 20.2.5.2. How to report Connector/NET Problems or Bugs

If you encounter difficulties or problems with Connector/NET, contact the Connector/NET community [Section 20.2.5.1, "Connector/NET Community Support"](#).

You should first try to execute the same SQL statements and commands from the `mysql` client program or from `admindemo`. This helps you determine whether the error is in Connector/NET or MySQL.

If reporting a problem, you should ideally include the following information with the email:

- Operating system and version
- Connector/NET version
- MySQL server version
- Copies of error messages or other unexpected output
- Simple reproducible sample

Remember that the more information you can supply to us, the more likely it is that we can fix the problem.

If you believe the problem to be a bug, then you must report the bug through <http://bugs.mysql.com/>.

#### 20.2.5.3. Connector/NET Change History

The Connector/NET Change History (Changelog) is located with the main Changelog for MySQL. See [Section C.5, "MySQL Con-](#)

ector/NET Change History”.

## 20.2.6. Connector/NET FAQ

### Questions

- [20.2.6.1](#): How do I obtain the value of an auto-incremented column?

### Questions and Answers

#### 20.2.6.1: How do I obtain the value of an auto-incremented column?

When using the `commandBuilder` you should make sure that you set the `ReturnGeneratedIdentifiers` property to `true`.

Then, you can use an active view on a table to access the updated ID. For example:

```
conn = new MySql.Data.MySqlClient.MySqlConnection();
cmd = new MySql.Data.MySqlClient.MySqlCommand();
da = new MySql.Data.MySqlClient.MySqlDataAdapter();
cmdBuilder = new MySql.Data.MySqlClient.MySqlCommandBuilder();
SystemDataDataSet = new System.Data.DataSet();
SystemDataDataView = new System.Data.DataView();
...
cmd.Connection = conn;
cmd.CommandText = "SELECT * FROM contacts";
da.SelectCommand = cmd;
da.Fill(SystemDataDataSet, "contacts");
cmdBuilder.DataAdapter = da;
cmdBuilder.ReturnGeneratedIdentifiers = true;
cmdBuilder.DataAdapter.SelectCommand.CommandText = "SELECT * FROM contacts";
cmdBuilder.RefreshSchema();

SystemDataDataView = SystemDataDataSet.Tables["contacts"].DefaultView;

SystemDataDataRow = SystemDataDataView.Table.NewRow();
SystemDataDataRow["status"] = 1;

SystemDataDataView.Table.Rows.Add(SystemDataDataRow);
da.Update(SystemDataDataSet, "contacts");
System.Console.WriteLine("ID after update: " + SystemDataDataRow["id"]);
```

The `SystemDataDataRow` object in this instance provides the interface to the updated auto-increment value in the `id` column.

## 20.3. MySQL Visual Studio Plugin

The MySQL Visual Studio Plugin is a DDEX provider; a plug-in for Visual Studio 2005 that allows developers to maintain database structures, and supports built-in data-driven application development tools.

The current version of the MySQL Visual Studio Plugin includes only database maintenance tools. Data-driven application development tools are not supported.

The MySQL DDEX Provider operates as a standard extension to the Visual Studio Data Designer functionality available through the Server Explorer menu of Visual Studio 2005, and enables developers to create database objects and data within a MySQL database.

The MySQL Visual Studio Plugin is designed to work with MySQL version 5.0, but is also compatible with MySQL 4.1.1 and provides limited compatibility with MySQL 5.1.

### 20.3.1. Installing the MySQL Visual Studio Plugin

The MySQL Visual Studio Plugin requires one of Visual Studio 2005 Standard, Professional or Team Developer Edition to be installed. Other editions of Visual Studio 2005 are not supported.

#### Note

Starting with Connector/NET 5.1.2, the Visual Studio Plugin is included in the installation. If you have installed Connector/NET 5.1.2, then you do not need to separately install the Visual Studio Plugin.

Here is the list of components that should already be installed before starting the installation of the MySQL Visual Studio Plugin:

- Visual Studio 2005 Standard, Professional or Team Developer Edition.

- MySQL Server 4.1.1 or later (either installed on the same machine, or a separate server).
- MySQL Connector/NET 5.0.

**Note**

When installing Connector/NET you must ensure that the connector is installed into the Global Assembly Cache (GAC). The Connector/NET installer handles this for you automatically, but in a custom installation the option may have been disabled.

The user used to connect to the MySQL server must have the following privileges to use the functionality provided by the MySQL Visual Studio Plugin:

- The `SELECT` privilege for the `INFORMATION_SCHEMA` database.
- The `EXECUTE` privilege for the `SHOW CREATE TABLE` statement.
- The `SELECT` privilege for the `mysql.proc` table (required for operations with stored procedures and functions).
- The `SELECT` privilege for the `mysql.func` table (required for operations with User Defined Functions (UDF)).
- The `EXECUTE` privilege for the `SHOW ENGINE STATUS` statement (required for retrieving extended error information).
- Appropriate privileges for performed operations (e.g. the `SELECT` privilege is required to browse data from a table etc.).

The MySQL Visual Studio Plugin is delivered as a MSI package that can be used to install, uninstall or reinstall the Provider. If you are not using Windows XP or Windows Server 2003 you upgrade the Windows Installer system to the latest version (see <http://support.microsoft.com/default.aspx?scid=kb;EN-US;292539> for details).

The MSI-package is named `MySQL.VisualStudio.msi`. To install the MySQL Visual Studio Plugin, right click on the MSI file and select `INSTALL`. The installation process is as follow:

1. The standard Welcome dialog is opened. Click Next to continue installation.
2. The License agreement (GNU GPL) window is opened. Accept the agreement and click NEXT to continue.
3. The destination folder choice dialog is opened. Here you can point out the folder where the MySQL Visual Studio Plugin will be installed. The default destination folder is `%ProgramFilesDir%\MySQL\MySQL DDEX Data Provider`, where `%ProgramFilesDir%` is the Program Files folder of the installation machine. After choosing the destination folder, click NEXT to continue.
4. The installer will ask to confirm that installation. Click Install to start installation process.
5. The installation will now take place. At the end of this step the Visual Studio command table is rebuilt (this process may take several minutes).
6. Once installation is complete, click FINISH to end the installation process.

To uninstall the MySQL Visual Studio Plugin, you can use either Add/Remove Programs component of the Control Panel or the same MSI-package. Choose the **REMOVE** option, and the Provider will be uninstalled automatically.

To repair the Provider, right click the MSI-package and choose the `REPAIR` option. The MySQL Visual Studio Plugin will be repaired automatically.

The installation package includes the following files:

- `MySQL.VisualStudio.dll` — the MySQL DDEX Provider assembly.
- `MySQL.Data.dll` — the assembly containing the MySQL Connector .NET which is used by the Provider.
- `MySQL.VisualStudio.dll.config` — the configuration file for the MySQL Visual Studio Plugin. This file contains default values for the provider GUI layout.

**Note**

Do not remove this file before the first use of the Provider.

- [Register.reg](#) — the file with registry entries that can be used to register the MySQL DDEX Provider in the case of the manual installation.
- [Install.js](#) — the script used to register the Connector .NET as an ADO.NET data provider in the machine.config file.
- [Release notes.doc](#) — the document with release notes.

To install the Provider manually, copy all files of the installation package in a desired folder, then set the full path to the Provider assembly as a value of the CodeBase entry. For example:

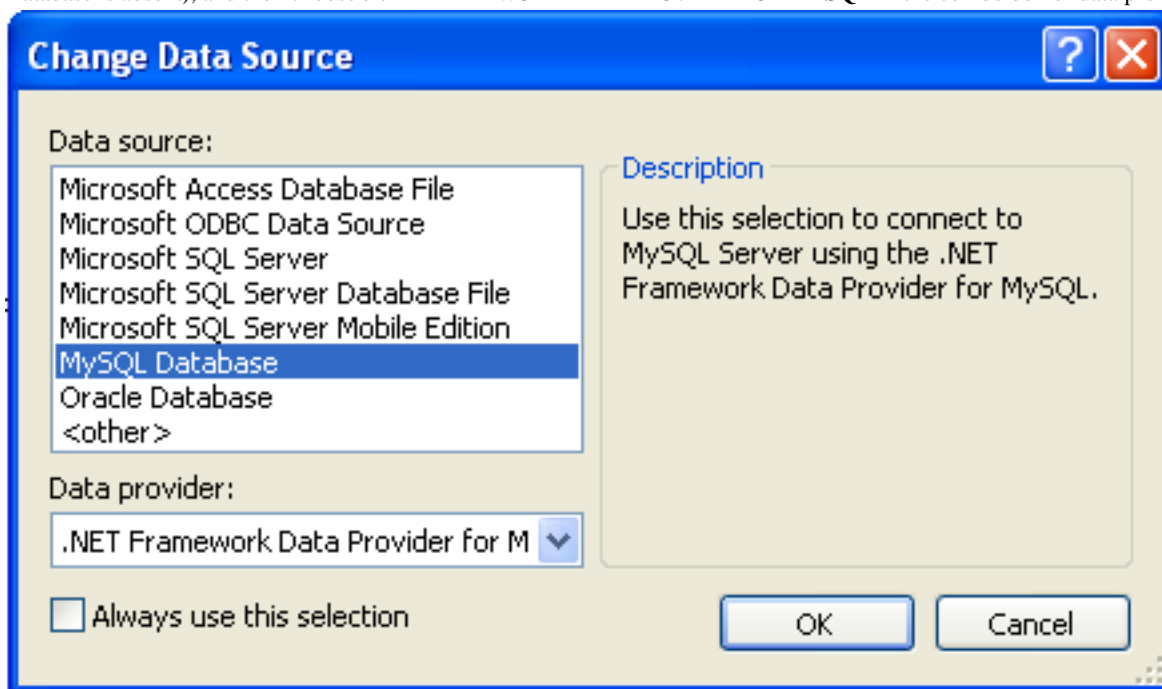
```
[HKEY_LOCAL_MACHINE\SOFTWARE\Microsoft\VisualStudio\8.0\Packages\{79A115C9-B133-4891-9E7B-242509DAD272}]@"MySQL.Data.InprocServer32"="C:\WINNT\system32\mscoree.dll"
"Class"="MySQL.Data.VisualStudio.MySqlDataProviderPackage"
"CodeBase"="C:\MySQLDdexProvider\MySQL.VisualStudio.dll"
```

Then import information from the Register.reg file to the registry by clicking of the file. At the confirmation dialog choose Yes. Next you must run the command `devenv.exe /setup` within a Command Prompt to rebuild the Visual Studio command table.

### 20.3.2. Creating a connection to the MySQL server

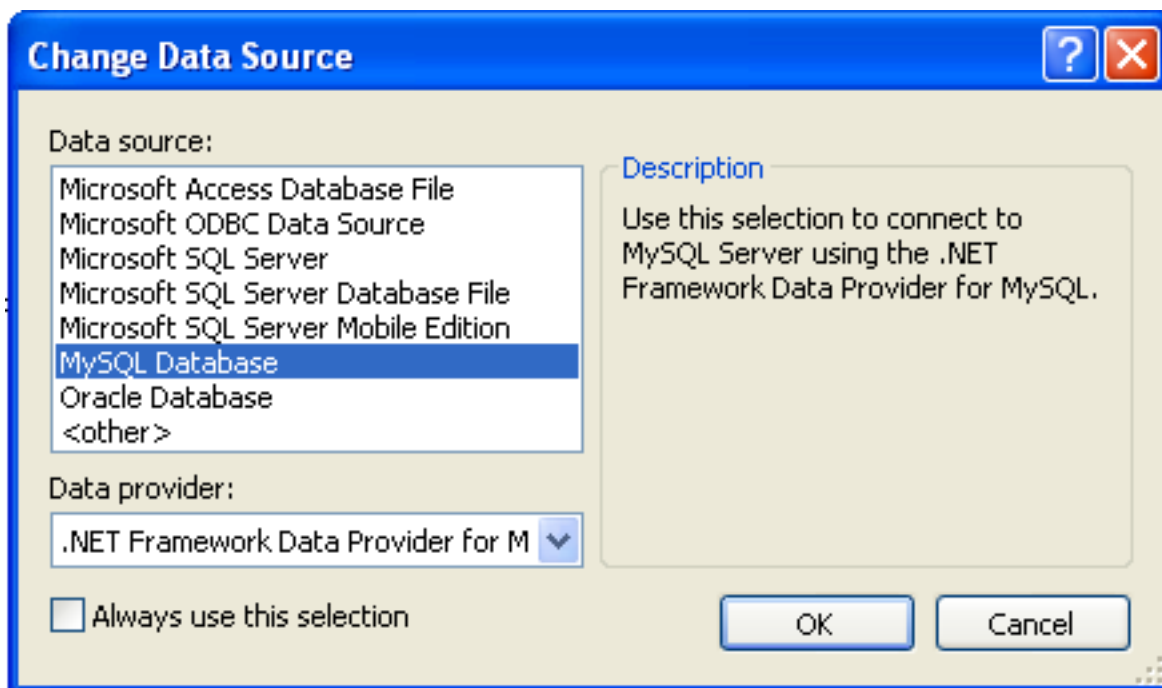
Once the MySQL Visual Studio Plugin is installed, you can use it to create, modify and delete connections to MySQL databases. To create a connection with a MySQL database, perform the following steps:

1. Start Visual Studio 2005 and open Server Explorer window by choosing the **SERVER EXPLORER** option from the **VIEW** menu.
2. Right click on the **DATA CONNECTIONS** node and choose the **ADD CONNECTION** button.
3. The Add Connection dialog is opened. Press the **CHANGE** button to choose MySQL Database as a data source.
4. Change Data Source dialog is opened. Choose MySQL Database in the list of data sources (or the **other** option, if MySQL Database is absent), and then choose **.NET FRAMEWORK DATA PROVIDER FOR MYSQL** in the combo box of data providers.



Press OK to confirm your choice.

5. Enter the connection settings: the server host name (for example, localhost if the MySQL server is installed on the local machine), the user name, the password, and the default database schema. Note that you must specify the default schema name to open the connection.



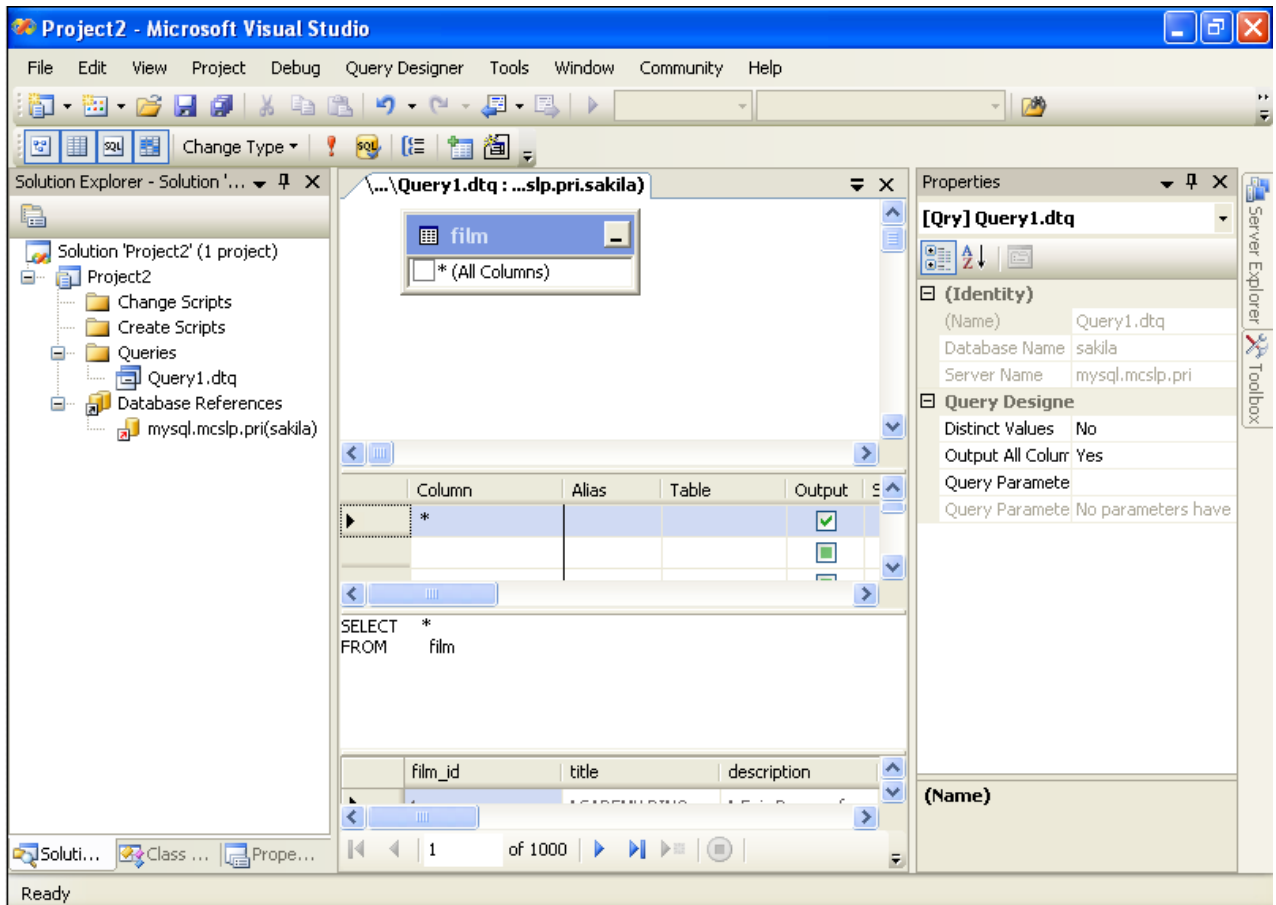
6. You can also set the port to connect with the MySQL server by pressing the **ADVANCED** button. To test a connection with the MySQL server, set the server host name, the user name, and the password, and press the **TEST CONNECTION** button. If the test fails, check the connection values that you have supplied are correct and that the corresponding user and privileges have been configured on the MySQL server.
7. After you set all settings and test the connection, press **OK**. The newly created connection is displayed in Server Explorer. Now you can work with the MySQL server through standard Server Explorer interface.

After a connection is successfully established, all the connection settings are saved. When you next open Visual Studio, the connection to the MySQL server will appear within Server Explorer so that you can re-establish a connection to the MySQL server.

To modify and delete a connection, use the **SERVER EXPLORER** context menu for the corresponding node. You can modify any of the settings just by overwriting the existing values with new ones. Note that a connection should be modified or deleted only if no active editor for its objects is opened. Otherwise your data could be lost.

### 20.3.3. Using the MySQL Visual Studio Plugin

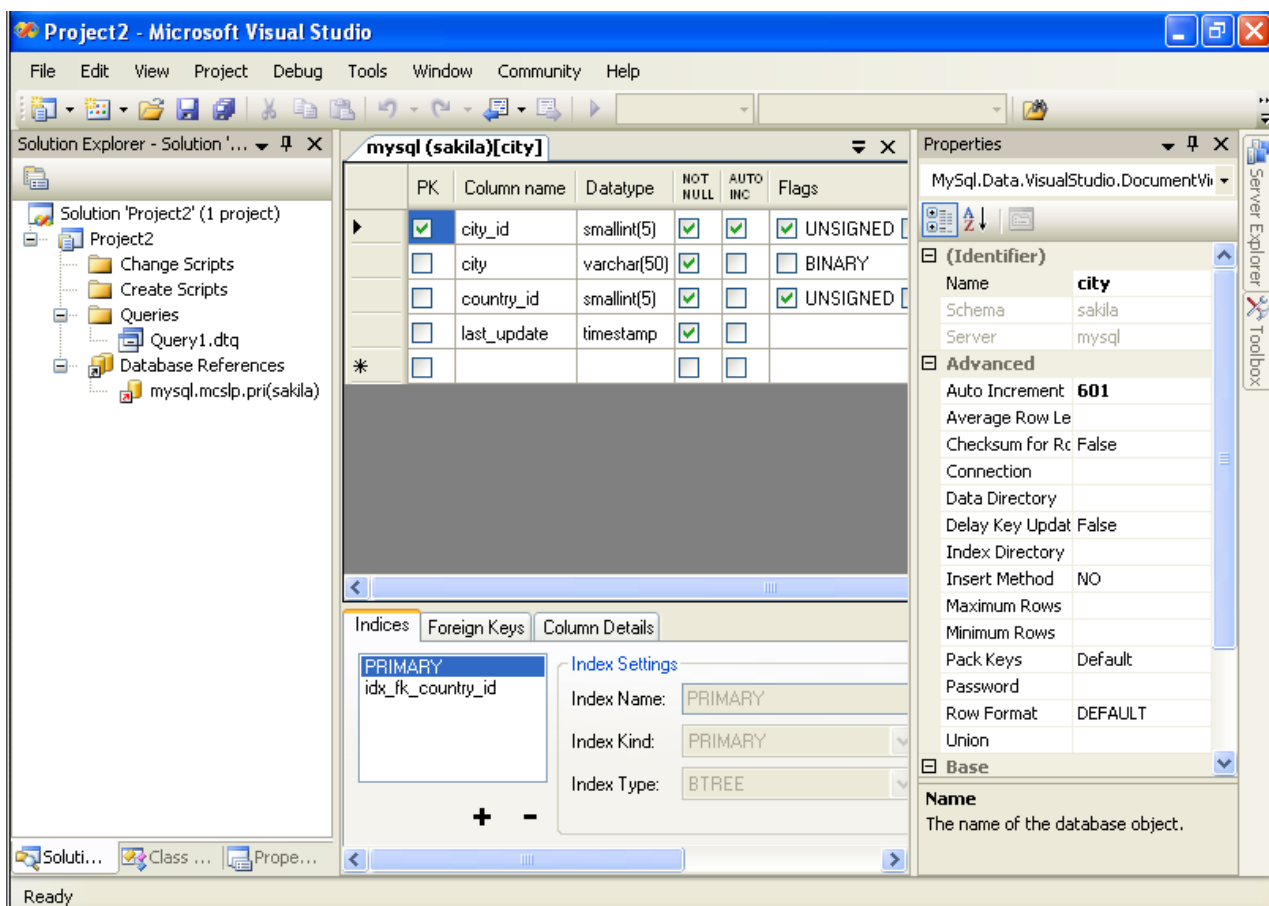
To work with a MySQL server using the MySQL Visual Studio Plugin, open the Visual Studio 2005, open the **SERVER EXPLORER**, and select the required connection. The working area of the MySQL Visual Studio Plugin consists of three parts.



- Database objects (tables, views, stored routines, triggers, and user defined functions) are displayed in the Server Explorer tree. Here you can choose an object and edit its properties and definition.
- Properties of a selected database object are displayed in the **PROPERTIES** panel. Certain properties can be edited directly within this window.
- The editor panel provides direct access to the SQL statement and definition of specific objects. For example, the SQL statements within a stored procedure definition are shown and edited within this panel.

### 20.3.3.1. Editing Tables

The Table Editor can be accessed through a mouse action on table-type node of Server Explorer. To create a new table, right click on the **TABLES** node (under the connection node) and choose the **CREATE TABLE** command from a context menu. To modify an existing table, double click on a node of the table you wish to modify, or right click on this node and choose the **ALTER TABLE** command from a context menu. Either of the commands opens the Table Editor.



The MySQL Visual Studio Plugin Table Editor is implemented in a similar fashion to the standard Query Browser Table Editor, but with minor differences.

The Table Editor consists of the following parts:

- Columns Editor — for column creation, modification and deletion.
- Indexes tab — for table/column index management.
- Foreign Keys tab — for configuration of foreign keys.
- Column Details tab — used to set advanced column options.
- Properties window — used to set table properties.

To save changes you have made in the Table Editor, use either Save or Save All buttons of the Visual Studio main toolbar, or just press **Ctrl+S**. Before changes are saved, a confirmation dialog will be displayed to confirm that you want to update the corresponding object within the MySQL database.

### 20.3.3.1.1. Column Editor

You can use the Column Editor to set or change the name, data type, default value and other properties of a table column. To set the properties of an individual column, select the column using the mouse. Alternatively, you can move through the grid using **Tab** and **Shift+Tab** keys.

- To set or change the name, data type, default value and comment of a column, select the appropriate cell and edit the desired value.
- To set or unset flag-type column properties (i.e., primary key, **NOT NULL**, auto-incremented, flags), check or uncheck the corresponding checkboxes. Note that the available column flags will depend on the columns data type.
- To reorder columns, index columns or foreign key columns in the Column Editor, select the whole column you wish to reorder by clicking on the selector column at the left of the column grid. Then move the column by using **Ctrl+Up** (to move the



column up) and **Ctrl+Down** (to move the column down) keys.

- To delete a column, select it by clicking on the selector column at the left of the column grid, then press the **Delete** button on a keyboard.

### 20.3.3.1.2. Indexes tab

Index management is performed via the Indexes tab.

- To add an index, press the + button and set the properties in the **INDEX SETTINGS** groupbox at the right. You can set the index name, index kind, index type and a set of index columns.
- To remove an index, select the index from the list and press the - button.
- To change index settings, select the index from the list; detailed information about the index is displayed in the **INDEX SETTINGS** panel.

You cannot change a table column to an index column using drag and drop. Instead, you can add new index columns to a table and set their table columns by using the embedded editor within the Indexes tab

### 20.3.3.1.3. Foreign Keys tab

Foreign Key management is performed via the Foreign Keys tab.

- To add a foreign key, press the + button and set properties in the **FOREIGN KEYS SETTINGS** panel. You can set the foreign key name, referenced table name, foreign key columns and actions on update and delete.
- To remove a foreign key, select the foreign key and press the - button.
- To change foreign key settings, select the foreign key and use the **FOREIGN KEYS SETTINGS** panel to edit the properties.
- When a foreign key is changed, the MySQL Visual Studio Plugin generates two queries: the first query drops the changed keys and the second one recreates the new values. The reason for such a behavior is to avoid the [Bug#8377](#) and [Bug#8919](#).

#### Note

If changed values are for some reason inconsistent and cause the second query to fail, all affected foreign keys will be dropped. If this is the case, the MySQL Visual Studio Plugin will mark them as new in the Table Editor, and you will have to recreate them later. But if you close the Table Editor without saving, these foreign keys will be lost.

### 20.3.3.1.4. Column Details tab

The Column Details tab can be used to set column options. Besides the main column properties that are presented in the Column Editor, in the Column Details tab you can set two additional properties options: the character set and the collation sequence.

### 20.3.3.1.5. Table Properties window

There is no separate tab for table options and advanced options. All table options can be browsed and changed using the **PROPERTIES** window of Visual Studio 2005.

The following table properties can be set:

- **AUTO INCREMENT**
- **AVERAGE ROW LENGTH**
- **CHARACTER SET**
- **CHECKSUM FOR ROWS**
- **COLLATION**
- **COMMENT**
- **CONNECTION**

- **DATA DIRECTORY**
- **DELAY KEY UPDATES**
- **ENGINE**
- **INDEX DIRECTORY**
- **INSERT METHOD**
- **MAXIMUM ROWS**
- **MINIMUM ROWS**
- **NAME**
- **PACK KEYS**
- **PASSWORD**
- **ROW FORMAT**
- **UNION**

Some of these properties can have arbitrary text values, others accept values from a predefined set.

The properties **SCHEMA** and **SERVER** are read only.

### 20.3.3.2. Editing Table Data

The Table Data Editor, allows a user to browse, create and edit data of tables. The Table Data Editor is implemented as a simple data grid with auto generated columns.

To access the Table Data Editor, right click on a node representing the table or view in Server Explorer. From the nodes context menu, choose the **BROWSE** or **EDIT DATA** command. For tables and updatable views, this command opens the Table Data Editor in edit mode. For non-updatable views, this command opens the Table Data Editor in read-only mode.

When in the edit mode, you can modify table data by modifying the displayed table contents directly. To add a row, set desired values in the last row of the grid. To modify values, set new values in appropriate cells. To delete a row, select it by clicking on the selector column at the left of the grid, then press the **DELETE** button.

To save changes you have made in the Table Data Editor, use either **SAVE** or **SAVE ALL** buttons of the Visual Studio main toolbar, or just press **Ctrl+S**. A confirmation dialog will confirm whether you want the changes saved to the database.

### 20.3.3.3. Editing Views

To create a new view, right click the Views node under the connection node in Server Explorer. From the nodes context menu, choose the **CREATE VIEW** command. This command opens the SQL Editor.

To modify an existing view, double click on a node of the view you wish to modify, or right click on this node and choose the **ALTER VIEW** command from a context menu. Either of the commands opens the SQL Editor.

To create or alter the view definition using SQL Editor, type the appropriate SQL statement in the SQL Editor.

#### **Note**

You should enter only the defining statement itself, without the **CREATE VIEW AS** preface.

All other view properties can be set in the **PROPERTIES** window. These properties are:

- **ALGORITHM**
- **CHECK OPTION**
- **DEFINER**
- **NAME**
- **SECURITY TYPE**

Some of these properties can have arbitrary text values, others accept values from a predefined set.

The properties **IS UPDATABLE**, **SCHEMA** and **SERVER** are read-only.

To save changes you have made, use either **SAVE** or **SAVE ALL** buttons of the Visual Studio main toolbar, or just press **Ctrl+S**. A confirmation dialog will confirm whether you want the changes saved to the database.

#### 20.3.3.4. Editing Stored Procedures and Functions

To create a new stored procedure, right click the Stored Procedures node under the connection node in Server Explorer. From the nodes context menu, choose the **CREATE ROUTINE** command. This command opens the SQL Editor.

To create a new stored function, right click the **FUNCTIONS** node under the connection node in Server Explorer. From the node's context menu, choose the **CREATE ROUTINE** command.

To modify an existing stored routine (procedure or function), double click on a node of the routine you wish to modify, or right click on this node and choose the **ALTER ROUTINE** command from a context menu. Either of the commands opens the SQL Editor.

To create or alter the routine definition using SQL Editor, type this definition in the SQL Editor using standard SQL.

All other routine properties can be set in the **PROPERTIES** window. These properties are:

- Comment
- Data Access
- Definer
- Is Deterministic
- Security Type

Some of these properties can have arbitrary text values, others accept values only from a predefined set.

Also you can set all the options directly in the SQL Editor, using the standard **CREATE PROCEDURE** or **CREATE FUNCTION** statement. However, it is recommended to use the **PROPERTIES** window instead.

#### Note

You should never add the **CREATE** preface to the routine definition.

The properties **NAME**, **SCHEMA** and **SERVER** in the **PROPERTIES** window are read-only. Set or change the procedure name in the SQL editor.

To save changes you have made, use either **SAVE** or **SAVE ALL** buttons of the Visual Studio main toolbar, or just press **Ctrl+S**. A confirmation dialog will confirm whether you want the changes saved to the database..

#### 20.3.3.5. Editing Triggers

To create a new trigger, right click on a node of a table for which you wish to add a trigger. From the node's context menu, choose the **CREATE TRIGGER** command. This command opens the SQL Editor.

To modify an existing trigger, double click on a node of the trigger you wish to modify, or right click on this node and choose the **ALTER TRIGGER** command from a context menu. Either of the commands opens the SQL Editor.

To create or alter the trigger definition using SQL Editor, type the trigger statement in the SQL Editor using standard SQL.

#### Note

You should enter only the trigger statement, that is the part of the **CREATE TRIGGER** query that is placed after the **FOR EACH ROW** clause.

All other trigger properties are set in the **PROPERTIES** window. These properties are:

- **DEFINER**
- **EVENT MANIPULATION**

- **NAME**
- **TIMING**

Some of these properties can have arbitrary text values, others accept values only from a predefined set.

The properties **EVENT TABLE**, **SCHEMA** and **SERVER** in the **PROPERTIES** window are read-only.

To save changes you have made, use either **SAVE** or **SAVE ALL** buttons of the Visual Studio main toolbar, or just press **Ctrl+S**. A confirmation dialog will confirm whether you want the changes saved to the database.

### 20.3.3.6. Editing User Defined Functions (UDF)

To create a new User Defined Function (UDF), right click the UDFs node under the connection node in Server Explorer. From the node's context menu, choose the **CREATE UDF** command. This command opens the UDF Editor.

To modify an existing UDF, double click on a node of the UDF you wish to modify, or right click on this node and choose the **Alter UDF** command from a context menu. Either of the commands opens the UDF Editor.

The UDF editor allows you to set the following properties through the properties panel:

- **NAME**
- **SO-NAME (DLL NAME)**
- **RETURN TYPE**
- **IS AGGREGATE**

The property **Server** in the **PROPERTIES** window is read-only.

To save changes you have made, use either **SAVE** or **SAVE ALL** buttons of the Visual Studio main toolbar, or just press **Ctrl+S**. A confirmation dialog will confirm whether you want the changes saved to the database.

### 20.3.3.7. Dropping database objects

Tables, views, stored routines, triggers, and UDFs can be dropped with the appropriate **DROP** command from its context menu: **DROP TABLE**, **DROP VIEW**, **DROP ROUTINE**, **DROP TRIGGER**, **DROP UDF**.

You will be asked to confirm the execution of the corresponding drop query in a confirmation dialog.

Dropping of multiple objects is not supported.

### 20.3.3.8. Cloning database objects

Tables, views, stored procedures and functions can be cloned with the appropriate **CLONE** command from its context menu: **CLONE TABLE**, **CLONE VIEW**, **CLONE ROUTINE**. The clone commands open the corresponding editor for a new object: the **TABLE EDITOR** for cloning a table and the SQL Editor for cloning a view or a routine.

To save the cloned object, use either **SAVE** or **SAVE ALL** buttons of the Visual Studio main toolbar, or just press **Ctrl+S**. A confirmation dialog will confirm whether you want the changes saved to the database.

## 20.3.4. Visual Studio Plugin Support

If you have a comment, or if you discover a bug, please, use our MySQL bug tracking system (<http://bugs.mysql.com>) to report problem or add your suggestion.

### 20.3.4.1. Visual Studio Plugin FAQ

#### Questions

- **20.3.4.1.1:** When creating a connection, typing the connection details causes the connection window to immediately close.

#### Questions and Answers

**20.3.4.1.1: When creating a connection, typing the connection details causes the connection window to immediately close.**

There are known issues with versions of Connector/NET earlier than 5.0.2. Connector/NET 1.0.x is known not to work. If you have any of these versions installed, or have previously upgraded from an earlier version, uninstall Connector/NET completely and then install Connector/NET 5.0.2.

## 20.4. MySQL Connector/J

MySQL provides connectivity for client applications developed in the Java programming language via a JDBC driver, which is called MySQL Connector/J.

MySQL Connector/J is a JDBC Type 4 driver. Different versions are available that are compatible with the JDBC 3.0 and JDBC 4.0 specifications. The Type 4 designation means that the driver is pure-Java implementation of the MySQL protocol and does not rely on the MySQL client libraries.

Although JDBC is useful by itself, we would hope that if you are not familiar with JDBC that after reading the first few sections of this manual, that you would avoid using naked JDBC for all but the most trivial problems and consider using one of the popular persistence frameworks such as [Hibernate](#), [Spring's JDBC templates](#) or [Ibatis SQL Maps](#) to do the majority of repetitive work and heavier lifting that is sometimes required with JDBC.

This section is not designed to be a complete JDBC tutorial. If you need more information about using JDBC you might be interested in the following online tutorials that are more in-depth than the information presented here:

- [JDBC Basics](#) — A tutorial from Sun covering beginner topics in JDBC
- [JDBC Short Course](#) — A more in-depth tutorial from Sun and JGuru

### Key topics:

- For help with connection strings, connection options setting up your connection through JDBC, see [Section 20.4.4.1, “Driver/Datasource Class Names, URL Syntax and Configuration Properties for Connector/J”](#).
- For tips on using Connector/J and JDBC with generic J2EE toolkits, see [Section 20.4.5.2, “Using Connector/J with J2EE and Other Java Frameworks”](#).
- Developers using the Tomcat server platform, see [Section 20.4.5.2.2, “Using Connector/J with Tomcat”](#).
- Developers using JBoss, see [Section 20.4.5.2.3, “Using Connector/J with JBoss”](#).
- Developers using Spring, see [Section 20.4.5.2.4, “Using Connector/J with Spring”](#).

### MySQL Enterprise

MySQL Enterprise subscribers will find more information about using JDBC with MySQL in the Knowledge Base articles about [JDBC](#). Access to the MySQL Knowledge Base collection of articles is one of the advantages of subscribing to MySQL Enterprise. For more information, see <http://www.mysql.com/products/enterprise/advisors.html>.

### 20.4.1. Connector/J Versions

There are currently four versions of MySQL Connector/J available:

- Connector/J 5.1 is the Type 4 pure Java JDBC driver, which conforms to the JDBC 3.0 and JDBC 4.0 specifications. It provides compatibility with all the functionality of MySQL, including 4.1, 5.0, 5.1 and the 6.0 alpha release featuring the new Falcon storage engine. Connector/J 5.1 provides ease of development features, including auto-registration with the Driver Manager, standardized validity checks, categorized SQLExceptions, support for the JDBC-4.0 XML processing, per connection client information, [NCHAR](#), [NVARCHAR](#) and [NCLOB](#) types. This release also includes all bug fixes up to and including Connector/J 5.0.6.
- Connector/J 5.0 provides support for all the functionality offered by Connector/J 3.1 and includes distributed transaction (XA) support.
- Connector/J 3.1 was designed for connectivity to MySQL 4.1 and MySQL 5.0 servers and provides support for all the functionality in MySQL 5.0 except distributed transaction (XA) support.
- Connector/J 3.0 provides core functionality and was designed with connectivity to MySQL 3.x or MySQL 4.1 servers, although

it will provide basic compatibility with later versions of MySQL. Connector/J 3.0 does not support server-side prepared statements, and does not support any of the features in versions of MySQL later than 4.1.

The following table summarizes the Connector/J versions available:

Connector/J version	Driver Type	JDBC version	MySQL Server version	Status
5.1	4	3.0, 4.0	4.1, 5.0, 5.1, 6.0	Recommended version
5.0	4	3.0	4.1, 5.0	Released version
3.1	4	3.0	4.1, 5.0	Obsolete
3.0	4	3.0	3.x, 4.1	Obsolete

The current recommended version for Connector/J is 5.1. This guide covers all four connector versions, with specific notes given where a setting applies to a specific option.

### 20.4.1.1. Java Versions Supported

The following table summarizes Connector/J Java dependencies:

Connector/J version	Java RTE required	JDK required (to build source code)
5.1	1.4.x, 1.5.x, 1.6.x	1.6.x and 1.5.x (or older)
5.0	1.3.x, 1.4.x, 1.5.x, 1.6.x	1.4.2, 1.5.x, 1.6.x
3.1	1.2.x, 1.3.x, 1.4.x, 1.5.x, 1.6.x	1.4.2, 1.5.x, 1.6.x
3.0	1.2.x, 1.3.x, 1.4.x, 1.5.x, 1.6.x	1.4.2, 1.5.x, 1.6.x

MySQL Connector/J does not support JDK-1.1.x or JDK-1.0.x.

Because of the implementation of `java.sql.Savepoint`, Connector/J 3.1.0 and newer will not run on a Java runtime older than 1.4 unless the class verifier is turned off (by setting the `-Xverify:none` option to the Java runtime). This is because the class verifier will try to load the class definition for `java.sql.Savepoint` even though it is not accessed by the driver unless you actually use savepoint functionality.

Caching functionality provided by Connector/J 3.1.0 or newer is also not available on JVMs older than 1.4.x, as it relies on `java.util.LinkedHashMap` which was first available in JDK-1.4.0.

If you are building Connector/J from source code using the source distribution (see [Section 20.4.2.4, “Installing from the Development Source Tree”](#)) then you must use JDK 1.4.2 or newer to compile the Connector package. For Connector/J 5.1 you must have both JDK-1.6.x. and JDK-1.5.x installed in order to be able to build the source code.

## 20.4.2. Connector/J Installation

You can install the Connector/J package using either the binary or source distribution. The binary distribution provides the easiest method for installation; the source distribution enables you to customize your installation further. With either solution, you must manually add the Connector/J location to your Java `CLASSPATH`.

If you are upgrading from a previous version, read the upgrade information before continuing. See [Section 20.4.2.3, “Upgrading from an Older Version”](#).

### 20.4.2.1. Installing Connector/J from a Binary Distribution

The easiest method of installation is to use the binary distribution of the Connector/J package. The binary distribution is available either as a Tar/Gzip or Zip file which you must extract to a suitable location and then optionally make the information about the package available by changing your `CLASSPATH` (see [Section 20.4.2.2, “Installing the Driver and Configuring the CLASSPATH”](#)).

MySQL Connector/J is distributed as a .zip or .tar.gz archive containing the sources, the class files, and the JAR archive named `mysql-connector-java-[version]-bin.jar`, and starting with Connector/J 3.1.8 a debug build of the driver in a file named `mysql-connector-java-[version]-bin-g.jar`.

Starting with Connector/J 3.1.9, the `.class` files that constitute the JAR files are only included as part of the driver JAR file.

You should not use the debug build of the driver unless instructed to do so when reporting a problem or a bug to MySQL AB, as it

is not designed to be run in production environments, and will have adverse performance impact when used. The debug binary also depends on the Aspect/J runtime library, which is located in the `src/lib/aspectjrt.jar` file that comes with the Connector/J distribution.

You will need to use the appropriate graphical or command-line utility to extract the distribution (for example, WinZip for the .zip archive, and `tar` for the .tar.gz archive). Because there are potentially long file names in the distribution, we use the GNU tar archive format. You will need to use GNU tar (or an application that understands the GNU tar archive format) to unpack the .tar.gz variant of the distribution.

### 20.4.2.2. Installing the Driver and Configuring the CLASSPATH

Once you have extracted the distribution archive, you can install the driver by placing `mysql-connector-java-[version]-bin.jar` in your classpath, either by adding the full path to it to your `CLASSPATH` environment variable, or by directly specifying it with the command line switch `-cp` when starting your JVM.

If you are going to use the driver with the JDBC DriverManager, you would use `com.mysql.jdbc.Driver` as the class that implements `java.sql.Driver`.

You can set the `CLASSPATH` environment variable under UNIX, Linux or Mac OS X either locally for a user within their `.profile`, `.login` or other login file. You can also set it globally by editing the global `/etc/profile` file.

For example, under a C shell (csh, tcsh) you would add the Connector/J driver to your `CLASSPATH` using the following:

```
shell> setenv CLASSPATH /path/mysql-connector-java-[ver]-bin.jar:$CLASSPATH
```

Or with a Bourne-compatible shell (sh, ksh, bash):

```
shell> export set CLASSPATH=/path/mysql-connector-java-[ver]-bin.jar:$CLASSPATH
```

Within Windows 2000, Windows XP, Windows Server 2003 and Windows Vista, you must set the environment variable through the System Control Panel.

If you want to use MySQL Connector/J with an application server such as GlassFish, Tomcat or JBoss, you will have to read your vendor's documentation for more information on how to configure third-party class libraries, as most application servers ignore the `CLASSPATH` environment variable. For configuration examples for some J2EE application servers, see [Section 20.4.5.2, "Using Connector/J with J2EE and Other Java Frameworks"](#). However, the authoritative source for JDBC connection pool configuration information for your particular application server is the documentation for that application server.

If you are developing servlets or JSPs, and your application server is J2EE-compliant, you can put the driver's .jar file in the `WEB-INF/lib` subdirectory of your webapp, as this is a standard location for third party class libraries in J2EE web applications.

You can also use the `MysqlDataSource` or `MysqlConnectionPoolDataSource` classes in the `com.mysql.jdbc.jdbc2.optional` package, if your J2EE application server supports or requires them. Starting with Connector/J 5.0.0, the `javax.sql.XADataSource` interface is implemented via the `com.mysql.jdbc.jdbc2.optional.MysqlXADataSource` class, which supports XA distributed transactions when used in combination with MySQL server version 5.0.

The various `MysqlDataSource` classes support the following parameters (through standard set mutators):

- user
- password
- serverName (see the previous section about fail-over hosts)
- databaseName
- port

### 20.4.2.3. Upgrading from an Older Version

We try to keep the upgrade process as easy as possible, however as is the case with any software, sometimes changes need to be made in new versions to support new features, improve existing functionality, or comply with new standards.

This section has information about what users who are upgrading from one version of Connector/J to another (or to a new version of the MySQL server, with respect to JDBC functionality) should be aware of.



### 20.4.2.3.1. Upgrading from MySQL Connector/J 3.0 to 3.1

Connector/J 3.1 is designed to be backward-compatible with Connector/J 3.0 as much as possible. Major changes are isolated to new functionality exposed in MySQL-4.1 and newer, which includes Unicode character sets, server-side prepared statements, SQL-State codes returned in error messages by the server and various performance enhancements that can be enabled or disabled via configuration properties.

- **Unicode Character Sets** — See the next section, as well as [Section 9.1, “Character Set Support”](#), for information on this new feature of MySQL. If you have something misconfigured, it will usually show up as an error with a message similar to `Illegal mix of collations`.
- **Server-side Prepared Statements** — Connector/J 3.1 will automatically detect and use server-side prepared statements when they are available (MySQL server version 4.1.0 and newer).

Starting with version 3.1.7, the driver scans SQL you are preparing via all variants of `Connection.prepareStatement()` to determine if it is a supported type of statement to prepare on the server side, and if it is not supported by the server, it instead prepares it as a client-side emulated prepared statement. You can disable this feature by passing `emulateUnsupportedPstmts=false` in your JDBC URL.

If your application encounters issues with server-side prepared statements, you can revert to the older client-side emulated prepared statement code that is still presently used for MySQL servers older than 4.1.0 with the connection property `useServerPrepStmts=false`

- **Datetimes** with all-zero components (`0000-00-00 . . .`) — These values can not be represented reliably in Java. Connector/J 3.0.x always converted them to NULL when being read from a `ResultSet`.

Connector/J 3.1 throws an exception by default when these values are encountered as this is the most correct behavior according to the JDBC and SQL standards. This behavior can be modified using the `zeroDateTimeBehavior` configuration property. The allowable values are:

- `exception` (the default), which throws an `SQLException` with an `SQLState` of `S1009`.
- `convertToNull`, which returns `NULL` instead of the date.
- `round`, which rounds the date to the nearest closest value which is `0001-01-01`.

Starting with Connector/J 3.1.7, `ResultSet.getString()` can be decoupled from this behavior via `noDatetimeStringSync=true` (the default value is `false`) so that you can retrieve the unaltered all-zero value as a `String`. It should be noted that this also precludes using any time zone conversions, therefore the driver will not allow you to enable `noDatetimeStringSync` and `useTimezone` at the same time.

- **New SQLState Codes** — Connector/J 3.1 uses SQL:1999 `SQLState` codes returned by the MySQL server (if supported), which are different from the legacy X/Open state codes that Connector/J 3.0 uses. If connected to a MySQL server older than MySQL-4.1.0 (the oldest version to return `SQLStates` as part of the error code), the driver will use a built-in mapping. You can revert to the old mapping by using the configuration property `useSqlStateCodes=false`.
- **`ResultSet.getString()`** — Calling `ResultSet.getString()` on a `BLOB` column will now return the address of the `byte[]` array that represents it, instead of a `String` representation of the `BLOB`. `BLOB` values have no character set, so they cannot be converted to `java.lang.Strings` without data loss or corruption.

To store strings in MySQL with LOB behavior, use one of the `TEXT` types, which the driver will treat as a `java.sql.Clob`.

- **Debug builds** — Starting with Connector/J 3.1.8 a debug build of the driver in a file named `mysql-connector-java-[version]-bin-g.jar` is shipped alongside the normal binary jar file that is named `mysql-connector-java-[version]-bin.jar`.

Starting with Connector/J 3.1.9, we do not ship the `.class` files unbundled, they are only available in the JAR archives that ship with the driver.

You should not use the debug build of the driver unless instructed to do so when reporting a problem or bug, as it is not designed to be run in production environments, and will have adverse performance impact when used. The debug binary also depends on the Aspect/J runtime library, which is located in the `src/lib/aspectjrt.jar` file that comes with the Connector/J distribution.

### 20.4.2.3.2. Upgrading to MySQL Connector/J 5.1.x

- In Connector/J 5.0.x and earlier, the alias for a table in a `SELECT` statement is returned when accessing the result set metadata



using `ResultSetMetaData.getColumnname()`. This behavior however is not JDBC compliant, and in Connector/J 5.1 this behavior was changed so that the original table name, rather than the alias, is returned.

The JDBC-compliant behavior is designed to let API users reconstruct the DML statement based on the metadata within `ResultSet` and `ResultSetMetaData`.

You can get the alias for a column in a result set by calling `ResultSetMetaData.getColumnLabel()`. If you want to use the old non-compliant behavior with `ResultSetMetaData.getColumnname()`, use the `useOldAliasMetadataBehavior` option and set the value to `true`.

In Connector/J 5.0.x the default value of `useOldAliasMetadataBehavior` was true, but in Connector/J 5.1 this was changed to a default value of false.

### 20.4.2.3.3. JDBC-Specific Issues When Upgrading to MySQL Server 4.1 or Newer

- *Using the UTF-8 Character Encoding* - Prior to MySQL server version 4.1, the UTF-8 character encoding was not supported by the server, however the JDBC driver could use it, allowing storage of multiple character sets in latin1 tables on the server.

Starting with MySQL-4.1, this functionality is deprecated. If you have applications that rely on this functionality, and can not upgrade them to use the official Unicode character support in MySQL server version 4.1 or newer, you should add the following property to your connection URL:

```
useOldUTF8Behavior=true
```

- *Server-side Prepared Statements* - Connector/J 3.1 will automatically detect and use server-side prepared statements when they are available (MySQL server version 4.1.0 and newer). If your application encounters issues with server-side prepared statements, you can revert to the older client-side emulated prepared statement code that is still presently used for MySQL servers older than 4.1.0 with the following connection property:

```
useServerPrepStmts=false
```

### 20.4.2.4. Installing from the Development Source Tree

#### Caution

You should read this section only if you are interested in helping us test our new code. If you just want to get MySQL Connector/J up and running on your system, you should use a standard binary release distribution.

To install MySQL Connector/J from the development source tree, make sure that you have the following prerequisites:

- A Bazaar client, to check out the sources from our Launchpad repository (available from <http://bazaar-vcs.org/>).
- Apache Ant version 1.7 or newer (available from <http://ant.apache.org/>).
- JDK 1.4.2 or later. Although MySQL Connector/J can be used with older JDKs, to compile it from source you must have at least JDK 1.4.2. If you are building Connector/J 5.1 you will need JDK 1.6.x and an older JDK such as JDK 1.5.x. You will then need to point your JAVA\_HOME environment variable at the older installation.

The source code repository for MySQL Connector/J is located on Launchpad at <https://code.launchpad.net/connectorj>.

To check out and compile a specific branch of MySQL Connector/J, follow these steps:

1. Check out the latest code from the branch that you want with one of the following commands.

To check out the latest development branch use:

```
shell> bzz branch lp:connectorj
```

This creates a `connectorj` subdirectory in the current directory that contains the latest sources for the requested branch.

To check out the latest 5.1 code use:

```
shell> bzz branch lp:connectorj/5.1
```

This will create a [5.1](#) subdirectory in the current directory containing the latest 5.1 code.

2. If you are building Connector/J 5.1 make sure that you have both JDK 1.6.x installed and an older JDK such as JDK 1.5.x. This is because Connector/J supports both JDBC 3.0 (which was prior to JDK 1.6.x) and JDBC 4.0. Set your `JAVA_HOME` environment variable to the path of the older JDK installation.
3. Change location to either the `connectorj` or `5.1` directory, depending on which branch you want to build, to make it your current working directory. For example:

```
shell> cd connectorj
```

4. If you are building Connector/J 5.1 you need to edit the `build.xml` to reflect the location of your JDK 1.6.x installation. The lines that you need to change are:

```
<property name="com.mysql.jdbc.java6.javac" value="C:\jvms\jdk1.6.0\bin\javac.exe" />
<property name="com.mysql.jdbc.java6.rtar" value="C:\jvms\jdk1.6.0\jre\lib\rt.jar" />
```

Alternatively, you can set the value of these property names through the Ant `-D` option.

5. Issue the following command to compile the driver and create a `.jar` file suitable for installation:

```
shell> ant dist
```

This creates a `build` directory in the current directory, where all build output will go. A directory is created in the `build` directory that includes the version number of the sources you are building from. This directory contains the sources, compiled `.class` files, and a `.jar` file suitable for deployment. For other possible targets, including ones that will create a fully packaged distribution, issue the following command:

```
shell> ant -projecthelp
```

6. A newly created `.jar` file containing the JDBC driver will be placed in the directory `build/mysql-connector-java-[version]`.

Install the newly created JDBC driver as you would a binary `.jar` file that you download from MySQL by following the instructions in [Section 20.4.2.2](#), “Installing the Driver and Configuring the `CLASSPATH`”.

A package containing both the binary and source code for Connector/J 5.1 can also be found at the following location: [Connector/J 5.1 Download](#)

## 20.4.3. Connector/J Examples

Examples of using Connector/J are located throughout this document, this section provides a summary and links to these examples.

- [Example 20.1](#), “Connector/J: Obtaining a connection from the `DriverManager`”
- [Example 20.2](#), “Connector/J: Using `java.sql.Statement` to execute a `SELECT` query”
- [Example 20.3](#), “Connector/J: Calling Stored Procedures”
- [Example 20.4](#), “Connector/J: Using `Connection.prepareStatement()`”
- [Example 20.5](#), “Connector/J: Registering output parameters”
- [Example 20.6](#), “Connector/J: Setting `CallableStatement` input parameters”
- [Example 20.7](#), “Connector/J: Retrieving results and output parameter values”
- [Example 20.8](#), “Connector/J: Retrieving `AUTO_INCREMENT` column values using `Statement.getGeneratedKeys()`”
- [Example 20.9](#), “Connector/J: Retrieving `AUTO_INCREMENT` column values using `SELECT LAST_INSERT_ID()`”
- [Example 20.10](#), “Connector/J: Retrieving `AUTO_INCREMENT` column values in `Updatable ResultSets`”
- [Example 20.11](#), “Connector/J: Using a connection pool with a J2EE application server”
- [Example 20.12](#), “Connector/J: Example of transaction with retry logic”

## 20.4.4. Connector/J (JDBC) Reference

This section of the manual contains reference material for MySQL Connector/J, some of which is automatically generated during the Connector/J build process.

### 20.4.4.1. Driver/Datasource Class Names, URL Syntax and Configuration Properties for Connector/J

The name of the class that implements `java.sql.Driver` in MySQL Connector/J is `com.mysql.jdbc.Driver`. The `org.gjt.mm.mysql.Driver` class name is also usable to remain backward-compatible with MM.MySQL. You should use this class name when registering the driver, or when otherwise configuring software to use MySQL Connector/J.

The JDBC URL format for MySQL Connector/J is as follows, with items in square brackets ([, ]) being optional:

```
jdbc:mysql://[host][,failoverhost...][:port]/[database] »
[?propertyName1[=propertyValue1][&propertyName2[=propertyValue2]...
```

If the host name is not specified, it defaults to 127.0.0.1. If the port is not specified, it defaults to 3306, the default port number for MySQL servers.

```
jdbc:mysql://[host:port],[host:port].../[database] »
[?propertyName1[=propertyValue1][&propertyName2[=propertyValue2]...
```

If the database is not specified, the connection will be made with no default database. In this case, you will need to either call the `setCatalog()` method on the Connection instance or fully-specify table names using the database name (i.e. `SELECT dbname.tablename.colname FROM dbname.tablename...`) in your SQL. Not specifying the database to use upon connection is generally only useful when building tools that work with multiple databases, such as GUI database managers.

MySQL Connector/J has fail-over support. This allows the driver to fail-over to any number of slave hosts and still perform read-only queries. Fail-over only happens when the connection is in an `autoCommit(true)` state, because fail-over can not happen reliably when a transaction is in progress. Most application servers and connection pools set `autoCommit` to `true` at the end of every transaction/connection use.

The fail-over functionality has the following behavior:

- If the URL property `autoReconnect` is `false`: Failover only happens at connection initialization, and failback occurs when the driver determines that the first host has become available again.
- If the URL property `autoReconnect` is `true`: Failover happens when the driver determines that the connection has failed (before every query), and falls back to the first host when it determines that the host has become available again (after `queriesBeforeRetryMaster` queries have been issued).

In either case, whenever you are connected to a "failed-over" server, the connection will be set to read-only state, so queries that would modify data will have exceptions thrown (the query will **never** be processed by the MySQL server).

Configuration properties define how Connector/J will make a connection to a MySQL server. Unless otherwise noted, properties can be set for a `DataSource` object or for a `Connection` object.

Configuration Properties can be set in one of the following ways:

- Using the `set*()` methods on MySQL implementations of `java.sql.DataSource` (which is the preferred method when using implementations of `java.sql.DataSource`):
  - `com.mysql.jdbc.jdbc2.optional.MysqlDataSource`
  - `com.mysql.jdbc.jdbc2.optional.MysqlConnectionPoolDataSource`
- As a key/value pair in the `java.util.Properties` instance passed to `DriverManager.getConnection()` or `Driver.connect()`
- As a JDBC URL parameter in the URL given to `java.sql.DriverManager.getConnection()`, `java.sql.Driver.connect()` or the MySQL implementations of the `javax.sql.DataSource` `setURL()` method.

#### Note

If the mechanism you use to configure a JDBC URL is XML-based, you will need to use the XML character literal

& to separate configuration parameters, as the ampersand is a reserved character for XML.

The properties are listed in the following tables.

#### Connection/Authentication.

Property Name	Definition	Default Value	Since Version
user	The user to connect as		all versions
password	The password to use when connecting		all versions
socketFactory	The name of the class that the driver should use for creating socket connections to the server. This class must implement the interface 'com.mysql.jdbc.SocketFactory' and have public no-args constructor.	com.mysql.jdbc.StandardSocketFactory	3.0.3
connectTimeout	Timeout for socket connect (in milliseconds), with 0 being no timeout. Only works on JDK-1.4 or newer. Defaults to '0'.	0	3.0.1
socketTimeout	Timeout on network socket operations (0, the default means no timeout).	0	3.0.1
connectionLifecycleInterceptors	A comma-delimited list of classes that implement "com.mysql.jdbc.ConnectionLifecycleInterceptor" that should notified of connection lifecycle events (creation, destruction, commit, rollback, setCatalog and setAutoCommit) and potentially alter the execution of these commands. ConnectionLifecycleInterceptors are "stackable", more than one interceptor may be specified via the configuration property as a comma-delimited list, with the interceptors executed in order from left to right.		5.1.4
useConfigs	Load the comma-delimited list of configuration properties before parsing the URL or applying user-specified properties. These configurations are explained in the 'Configurations' of the documentation.		3.1.5
interactiveClient	Set the CLIENT_INTERACTIVE flag, which tells MySQL to timeout connections based on INTERACTIVE_TIMEOUT instead of WAIT_TIMEOUT	false	3.1.0
localSocketAddress	Host name or IP address given to explicitly configure the interface that the driver will bind the client side of the TCP/IP connection to when connecting.		5.0.5
mysqlIOFactory	The name of the class which implements "com.mysql.jdbc.MySQLIO" for communicating with mysqld. (default is "com.mysql.jdbc.MySQLIOprotocol")	com.mysql.jdbc.MySQLIOprotocol	6.0.0
propertiesTransform	An implementation of com.mysql.jdbc.ConnectionPropertiesTransform that the driver will use to modify URL properties passed to the driver before attempting a connection		3.1.4
useCompression	Use zlib compression when communicating with the server (true/false)? Defaults to 'false'.	false	3.0.17

#### Networking.

Property Name	Definition	Default Value	Since Version
tcpKeepAlive	If connecting using TCP/IP, should the driver set SO_KEEPALIVE?	true	5.0.7
tcpNoDelay	If connecting using TCP/IP, should the driver set SO_TCP_NODELAY (disabling the Nagle Algorithm)?	true	5.0.7
tcpRcvBuf	If connecting using TCP/IP, should the driver set SO_RCV_BUF to the given value? The default value of '0', means use the platform default value for this property)	0	5.0.7

tcpSndBuf	If connecting using TCP/IP, should the driver set SO_SND_BUF to the given value? The default value of '0', means use the platform default value for this property)	0	5.0.7
tcpTrafficClass	If connecting using TCP/IP, should the driver set traffic class or type-of-service fields ?See the documentation for java.net.Socket.setTrafficClass() for more information.	0	5.0.7

**High Availability and Clustering.**

Property Name	Definition	Default Value	Since Version
autoReconnect	Should the driver try to re-establish stale and/or dead connections? If enabled the driver will throw an exception for a queries issued on a stale or dead connection, which belong to the current transaction, but will attempt reconnect before the next query issued on the connection in a new transaction. The use of this feature is not recommended, because it has side effects related to session state and data consistency when applications do not handle SQLExceptions properly, and is only designed to be used when you are unable to configure your application to handle SQLExceptions resulting from dead and stale connections properly. Alternatively, investigate setting the MySQL server variable "wait_timeout" to some high value rather than the default of 8 hours.	false	1.1
autoReconnectForPools	Use a reconnection strategy appropriate for connection pools (defaults to 'false')	false	3.1.3
failOverReadOnly	When failing over in autoReconnect mode, should the connection be set to 'read-only'?	true	3.0.12
maxReconnects	Maximum number of reconnects to attempt if autoReconnect is true, default is '3'.	3	1.1
reconnectAtTxEnd	If autoReconnect is set to true, should the driver attempt reconnects at the end of every transaction?	false	3.0.10
initialTimeout	If autoReconnect is enabled, the initial time to wait between reconnect attempts (in seconds, defaults to '2').	2	1.1
roundRobinLoadBalance	When autoReconnect is enabled, and failoverReadOnly is false, should we pick hosts to connect to on a round-robin basis?	false	3.1.2
queriesBeforeRetryMaster	Number of queries to issue before falling back to master when failed over (when using multi-host failover). Whichever condition is met first, 'queriesBeforeRetryMaster' or 'secondsBeforeRetryMaster' will cause an attempt to be made to reconnect to the master. Defaults to 50.	50	3.0.2
secondsBeforeRetryMaster	How long should the driver wait, when failed over, before attempting	30	3.0.2
selfDestructOnPingMaxOperations	=If set to a nonzero value, the driver will report close the connection and report failure when Connection.ping() or Connection.isValid(int) is called if the connection's count of commands sent to the server exceeds this value.	0	5.1.6
selfDestructOnPingSecondsLifetime	If set to a nonzero value, the driver will report close the connection and report failure when Connection.ping() or Connection.isValid(int) is called if the connection's lifetime exceeds this value.	0	5.1.6
resourceId	A globally unique name that identifies the resource that this datasource or connection is connected to, used for XAResource.isSameRM() when the driver cannot determine this value based on host names used in the URL		5.0.1

**Security.**

Property Name	Definition	Default Value	Since Version
allowMultiQueries	Allow the use of ';' to delimit multiple queries during one state-	false	3.1.1

	ment (true/false), defaults to 'false'		
useSSL	Use SSL when communicating with the server (true/false), defaults to 'false'	false	3.0.2
requireSSL	Require SSL connection if useSSL=true? (defaults to 'false').	false	3.1.0
verifyServerCertificate	If "useSSL" is set to "true", should the driver verify the server's certificate? When using this feature, the keystore parameters should be specified by the "clientCertificateKeyStore*" properties, rather than system properties.	true	5.1.6
clientCertificateKeyStoreUrl	URL to the client certificate KeyStore (if not specified, use defaults)		5.1.0
clientCertificateKeyStoreType	KeyStore type for client certificates (NULL or empty means use default, standard keystore types supported by the JVM are "JKS" and "PKCS12", your environment may have more available depending on what security products are installed and available to the JVM.		5.1.0
clientCertificateKeyStorePassword	Password for the client certificates KeyStore		5.1.0
trustCertificateKeyStoreUrl	URL to the trusted root certificate KeyStore (if not specified, use defaults)		5.1.0
trustCertificateKeyStoreType	KeyStore type for trusted root certificates (NULL or empty means use default, standard keystore types supported by the JVM are "JKS" and "PKCS12", your environment may have more available depending on what security products are installed and available to the JVM.		5.1.0
trustCertificateKeyStorePassword	Password for the trusted root certificates KeyStore		5.1.0
allowLoadLocalInfile	Should the driver allow use of 'LOAD DATA LOCAL INFILE...' (defaults to 'true').	true	3.0.3
allowUrlInLocalInfile	Should the driver allow URLs in 'LOAD DATA LOCAL INFILE' statements?	false	3.1.4
paranoid	Take measures to prevent exposure sensitive information in error messages and clear data structures holding sensitive data when possible? (defaults to 'false')	false	3.0.1

**Performance Extensions.**

Property Name	Definition	Default Value	Since Version
callableStmtCacheSize	If 'cacheCallableStmts' is enabled, how many callable statements should be cached?	100	3.1.2
metadataCacheSize	The number of queries to cache ResultSetMetadata for if cacheResultSetMetaData is set to 'true' (default 50)	50	3.1.1
prepStmtCacheSize	If prepared statement caching is enabled, how many prepared statements should be cached?	25	3.0.10
prepStmtCacheSqlLimit	If prepared statement caching is enabled, what is the largest SQL the driver will cache the parsing for?	256	3.0.10
alwaysSendSetIsolation	Should the driver always communicate with the database when Connection.setTransactionIsolation() is called? If set to false, the driver will only communicate with the database when the requested transaction isolation is different than the whichever is newer, the last value that was set via Connection.setTransactionIsolation(), or the value that was read from the server when the connection was established.	true	3.1.7
maintainTimeStats	Should the driver maintain various internal timers to enable idle time calculations as well as more verbose error messages when the connection to the server fails? Setting this property to false removes at least two calls to System.getCurrentTimeMillis() per query.	true	3.1.9
useCursorFetch	If connected to MySQL > 5.0.2, and setFetchSize() > 0 on a statement, should that statement use cursor-based fetching to retrieve rows?	false	5.0.0

blobSendChunkSize	Chunk to use when sending BLOB/CLOBs via ServerPrepared-Statements	1048576	3.1.9
cacheCallableStmts	Should the driver cache the parsing stage of CallableStatements	false	3.1.2
cachePrepStmts	Should the driver cache the parsing stage of PreparedStatements of client-side prepared statements, the "check" for suitability of server-side prepared and server-side prepared statements themselves?	false	3.0.10
cacheResultSetMetadata	Should the driver cache ResultSetMetaData for Statements and PreparedStatements? (Req. JDK-1.4+, true/false, default 'false')	false	3.1.1
cacheServerConfiguration	Should the driver cache the results of 'SHOW VARIABLES' and 'SHOW COLLATION' on a per-URL basis?	false	3.1.5
defaultFetchSize	The driver will call setFetchSize(n) with this value on all newly-created Statements	0	3.1.9
dontTrackOpenResources	The JDBC specification requires the driver to automatically track and close resources, however if your application doesn't do a good job of explicitly calling close() on statements or result sets, this can cause memory leakage. Setting this property to true relaxes this constraint, and can be more memory efficient for some applications.	false	3.1.7
dynamicCalendars	Should the driver retrieve the default calendar when required, or cache it per connection/session?	false	3.1.5
elideSetAutoCommits	If using MySQL-4.1 or newer, should the driver only issue 'set autocommit=n' queries when the server's state doesn't match the requested state by Connection.setAutoCommit(boolean)?	false	3.1.3
enableQueryTimeouts	When enabled, query timeouts set via Statement.setQueryTimeout() use a shared java.util.Timer instance for scheduling. Even if the timeout doesn't expire before the query is processed, there will be memory used by the TimerTask for the given timeout which will not be reclaimed until the time the timeout would have expired if it hadn't been cancelled by the driver. High-load environments might want to consider disabling this functionality.	true	5.0.6
holdResultsOpenOverStatementClose	Should the driver close result sets on Statement.close() as required by the JDBC specification?	false	3.1.7
largeRowSizeThreshold	What size result set row should the JDBC driver consider "large", and thus use a more memory-efficient way of representing the row internally?	2048	5.1.1
loadBalanceStrategy	If using a load-balanced connection to connect to SQL nodes in a MySQL Cluster/NDB configuration (by using the URL prefix "jdbc:mysql:loadbalance://"), which load balancing algorithm should the driver use: (1) "random" - the driver will pick a random host for each request. This tends to work better than round-robin, as the randomness will somewhat account for spreading loads where requests vary in response time, while round-robin can sometimes lead to overloaded nodes if there are variations in response times across the workload. (2) "bestResponseTime" - the driver will route the request to the host that had the best response time for the previous transaction.	random	5.0.6
locatorFetchBufferSize	If 'emulateLocators' is configured to 'true', what size buffer should be used when fetching BLOB data for getBinaryInputStream?	1048576	3.2.1
rewriteBatchedStatements	Should the driver use multiqueries (irregardless of the setting of "allowMultiQueries") as well as rewriting of prepared statements for INSERT into multi-value inserts when executeBatch() is called? Notice that this has the potential for SQL injection if using plain java.sql.Statements and your code doesn't sanitize input correctly. Notice that for prepared statements, server-side prepared statements can not currently take advantage of this rewrite option, and that if you do not specify stream lengths when using PreparedStatement.set*Stream(), the driver will not be able to determine the optimum number of parameters per batch and you might receive an error from the driver that the resultant packet is too large. Statement.getGeneratedKeys() for these re-	false	3.1.13

	written statements only works when the entire batch includes INSERT statements.		
useDirectRowUnpack	Use newer result set row unpacking code that skips a copy from network buffers to a MySQL packet instance and instead reads directly into the result set row data buffers.	true	5.1.1
useDynamicCharsetInfo	Should the driver use a per-connection cache of character set information queried from the server when necessary, or use a built-in static mapping that is more efficient, but isn't aware of custom character sets or character sets implemented after the release of the JDBC driver?	true	5.0.6
useFastDateParsing	Use internal String->Date/Time/Timestamp conversion routines to avoid excessive object creation?	true	5.0.5
useFastIntParsing	Use internal String->Integer conversion routines to avoid excessive object creation?	true	3.1.4
useJvmCharsetConverters	Always use the character encoding routines built into the JVM, rather than using lookup tables for single-byte character sets?	false	5.0.1
useLocalSessionState	Should the driver refer to the internal values of autocommit and transaction isolation that are set by Connection.setAutoCommit() and Connection.setTransactionIsolation() and transaction state as maintained by the protocol, rather than querying the database or blindly sending commands to the database for commit() or rollback() method calls?	false	3.1.7
useReadAheadInput	Use newer, optimized non-blocking, buffered input stream when reading from the server?	true	3.1.5

**Debugging/Profiling.**

Property Name	Definition	Default Value	Since Version
logger	The name of a class that implements "com.mysql.jdbc.log.Log" that will be used to log messages to. (default is "com.mysql.jdbc.log.StandardLogger", which logs to STDERR)	com.mysql.jdbc.log.StandardLogger	3.1.1
gatherPerfMetrics	Should the driver gather performance metrics, and report them via the configured logger every 'reportMetricsIntervalMillis' milliseconds?	false	3.1.2
profileSQL	Trace queries and their execution/fetch times to the configured logger (true/false) defaults to 'false'	false	3.1.0
profileSql	Deprecated, use 'profileSQL' instead. Trace queries and their execution/fetch times on STDERR (true/false) defaults to 'false'		2.0.14
reportMetricsIntervalMillis	If 'gatherPerfMetrics' is enabled, how often should they be logged (in ms)?	30000	3.1.2
maxQuerySizeToLog	Controls the maximum length/size of a query that will get logged when profiling or tracing	2048	3.1.3
packetDebugBufferSize	The maximum number of packets to retain when 'enablePacketDebug' is true	20	3.1.3
slowQueryThresholdMillis	If 'logSlowQueries' is enabled, how long should a query (in ms) before it is logged as 'slow'?	2000	3.1.2
slowQueryThresholdNanos	If 'useNanosForElapsedTime' is set to true, and this property is set to a nonzero value, the driver will use this threshold (in nanosecond units) to determine if a query was slow.	0	5.0.7
useUsageAdvisor	Should the driver issue 'usage' warnings advising proper and efficient usage of JDBC and MySQL Connector/J to the log (true/false, defaults to 'false')?	false	3.1.1
autoGenerateTestcaseScript	Should the driver dump the SQL it is executing, including server-side prepared statements to STDERR?	false	3.1.9
autoSlowLog	Instead of using slowQueryThreshold* to determine if a query is slow enough to be logged, maintain statistics that allow the driver to determine queries that are outside the 99th percentile?	true	5.1.4



clientInfoProvider	The name of a class that implements the com.mysql.jdbc.JDBC4ClientInfoProvider interface in order to support JDBC-4.0's Connection.get/setClientInfo() methods	com.mysql.jdbc.JDBC4ClientInfoProvider	5.1.0
dumpMetadataOnColumnNotFound	Should the driver dump the field-level metadata of a result set into the exception message when ResultSet.findColumn() fails?	false	3.1.13
dumpQueriesOnException	Should the driver dump the contents of the query sent to the server in the message for SQLExceptions?	false	3.1.3
enablePacketDebug	When enabled, a ring-buffer of 'packetDebugBufferSize' packets will be kept, and dumped when exceptions are thrown in key areas in the driver's code	false	3.1.3
explainSlowQueries	If 'logSlowQueries' is enabled, should the driver automatically issue an 'EXPLAIN' on the server and send the results to the configured log at a WARN level?	false	3.1.2
includeInnodbStatusInDeadlockExceptions	Include the output of "SHOW ENGINE INNODB STATUS" in exception messages when deadlock exceptions are detected?	false	5.0.7
logSlowQueries	Should queries that take longer than 'slowQueryThresholdMillis' be logged?	false	3.1.2
logXaCommands	Should the driver log XA commands sent by MySQLXaConnection to the server, at the DEBUG level of logging?	false	5.0.5
profilerEventHandler	Name of a class that implements the interface com.mysql.jdbc.profiler.ProfilerEventHandler that will be used to handle profiling/tracing events.	com.mysql.jdbc.profiler.LoggingProfilerEventHandler	5.1.6
resultSetSizeThreshold	If the usage advisor is enabled, how many rows should a result set contain before the driver warns that it is suspiciously large?	100	5.0.5
traceProtocol	Should trace-level network protocol be logged?	false	3.1.2
useNanosForElapsedTime	For profiling/debugging functionality that measures elapsed time, should the driver try to use nanoseconds resolution if available (JDK >= 1.5)?	false	5.0.7

**Miscellaneous.**

Property Name	Definition	Default Value	Since Version
useUnicode	Should the driver use Unicode character encodings when handling strings? Should only be used when the driver cannot determine the character set mapping, or you are trying to 'force' the driver to use a character set that MySQL either doesn't natively support (such as UTF-8), true/false, defaults to 'true'	true	1.1g
characterEncoding	If 'useUnicode' is set to true, what character encoding should the driver use when dealing with strings? (defaults is to 'autodetect')		1.1g
characterSetResults	Character set to tell the server to return results as.		3.0.13
connectionCollation	If set, tells the server to use this collation via 'set collation_connection'		3.0.13
useBlobToStoreUTF8OutsideBMP	Tells the driver to treat [MEDIUM/LONG]BLOB columns as [LONG]VARCHAR columns holding text encoded in UTF-8 that has characters outside the BMP (4-byte encodings), which MySQL server cannot handle natively.	false	5.1.3
utf8OutsideBmpExcludedColumnNamePattern	When "useBlobToStoreUTF8OutsideBMP" is set to "true", column names matching the given regex will still be treated as BLOBs unless they match the regex specified for "utf8OutsideBmpIncludedColumnNamePattern". The regex must follow the patterns used for the java.util.regex package.		5.1.3

utf8OutsideBmpIncludedColumnNamePattern	Used to specify exclusion rules to "utf8OutsideBmpExcludedColumnNamePattern". The regex must follow the patterns used for the java.util.regex package.		5.1.3
sessionVariables	A comma-separated list of name/value pairs to be sent as SET SESSION ... to the server when the driver connects.		3.1.8
allowNaNAndInf	Should the driver allow NaN or +/- INF values in PreparedStatement.setDouble()?	false	3.1.5
autoClosePstmtStreams	Should the driver automatically call .close() on streams/readers passed as arguments via set*() methods?	false	3.1.12
autoDeserialize	Should the driver automatically detect and de-serialize objects stored in BLOB fields?	false	3.1.5
blobsAreStrings	Should the driver always treat BLOBs as Strings - specifically to work around dubious metadata returned by the server for GROUP BY clauses?	false	5.0.8
capitalizeTypeNames	Capitalize type names in DatabaseMetaData? (usually only useful when using WebObjects, true/false, defaults to 'false')	true	2.0.7
clobCharacterEncoding	The character encoding to use for sending and retrieving TEXT, MEDIUMTEXT and LONGTEXT values instead of the configured connection characterEncoding		5.0.0
clobberStreamingResults	This will cause a 'streaming' ResultSet to be automatically closed, and any outstanding data still streaming from the server to be discarded if another query is executed before all the data has been read from the server.	false	3.0.9
continueBatchOnError	Should the driver continue processing batch commands if one statement fails. The JDBC spec allows either way (defaults to 'true').	true	3.0.3
createDatabaseIfNotExist	Creates the database given in the URL if it doesn't yet exist. Assumes the configured user has permissions to create databases.	false	3.1.9
emptyStringsConvertToZero	Should the driver allow conversions from empty string fields to numeric values of '0'?	true	3.1.8
emulateLocators	Should the driver emulate java.sql.Blobs with locators? With this feature enabled, the driver will delay loading the actual Blob data until the one of the retrieval methods (getInputStream(), getBytes(), and so forth) on the blob data stream has been accessed. For this to work, you must use a column alias with the value of the column to the actual name of the Blob. The feature also has the following restrictions: The SELECT that created the result set must reference only one table, the table must have a primary key; the SELECT must alias the original blob column name, specified as a string, to an alternate name; the SELECT must cover all columns that make up the primary key.	false	3.1.0
emulateUnsupportedPstmts	Should the driver detect prepared statements that are not supported by the server, and replace them with client-side emulated versions?	true	3.1.7
functionsNeverReturnBlobs	Should the driver always treat data from functions returning BLOBs as Strings - specifically to work around dubious metadata returned by the server for GROUP BY clauses?	false	5.0.8
generateSimpleParameterMetadata	Should the driver generate simplified parameter metadata for PreparedStatements when no metadata is available either because the server couldn't support preparing the statement, or server-side prepared statements are disabled?	false	5.0.5
ignoreNonTxTables	Ignore non-transactional table warning for rollback? (defaults to 'false').	false	3.0.9
jdbcCompliantTruncation	Should the driver throw java.sql.DataTruncation exceptions when data is truncated as is required by the JDBC specification when connected to a server that supports warnings (MySQL 4.1.0 and newer)? This property has no effect if the server sql-mode includes STRICT_TRANS_TABLES.	true	3.1.2
maxRows	The maximum number of rows to return (0, the default means return all rows).	-1	all versions

netTimeoutForStreamingResults	What value should the driver automatically set the server setting 'net_write_timeout' to when the streaming result sets feature is in use? (value has unit of seconds, the value '0' means the driver will not try and adjust this value)	600	5.1.0
noAccessToProcedureBodies	When determining procedure parameter types for CallableStatements, and the connected user cannot access procedure bodies through "SHOW CREATE PROCEDURE" or select on mysql.proc should the driver instead create basic metadata (all parameters reported as IN VARCHARs, but allowing registerOutParameter() to be called on them anyway) instead of throwing an exception?	false	5.0.3
noDatetimeStringSync	Do not ensure that ResultSet.getDateType().toString().equals(ResultSet.getString())	false	3.1.7
noTimezoneConversionForTimeType	Do not convert TIME values using the server timezone if 'useTimezone'='true'	false	5.0.0
nullCatalogMeansCurrent	When DatabaseMetadataMethods ask for a 'catalog' parameter, does the value null mean use the current catalog? (this is not JDBC-compliant, but follows legacy behavior from earlier versions of the driver)	true	3.1.8
nullNamePatternMatchesAll	Should DatabaseMetaMethods that accept *pattern parameters treat null the same as '%' (this is not JDBC-compliant, however older versions of the driver accepted this departure from the specification)	true	3.1.8
overrideSupportsIntegrityEnhancementFacility	Should the driver return "true" for DatabaseMetaMethods.supportsIntegrityEnhancementFacility() even if the database doesn't support it to workaround applications that require this method to return "true" to signal support of foreign keys, even though the SQL specification states that this facility contains much more than just foreign key support (one such application being OpenOffice)?	false	3.1.12
padCharsWithSpace	If a result set column has the CHAR type and the value does not fill the amount of characters specified in the DDL for the column, should the driver pad the remaining characters with space (for ANSI compliance)?	false	5.0.6
pedantic	Follow the JDBC spec to the letter.	false	3.0.0
pinGlobalTxToPhysicalConnection	When using XAConnections, should the driver ensure that operations on a given XID are always routed to the same physical connection? This allows the XAConnection to support "XA START ... JOIN" after "XA END" has been called	false	5.0.1
populateInsertRowWithDefaultValues	When using ResultSets that are CONCUR_UPDATABLE, should the driver pre-populate the "insert" row with default values from the DDL for the table used in the query so those values are immediately available for ResultSet accessors? This functionality requires a call to the database for metadata each time a result set of this type is created. If disabled (the default), the default values will be populated by the an internal call to refreshRow() which pulls back default values and/or values changed by triggers.	false	5.0.5
processEscapeCodesForPrepStmts	Should the driver process escape codes in queries that are prepared?	true	3.1.12
relaxAutoCommit	If the version of MySQL the driver connects to does not support transactions, still allow calls to commit(), rollback() and setAutoCommit() (true/false, defaults to 'false')?	false	2.0.13
retainStatementAfterResultSetClose	Should the driver retain the Statement reference in a ResultSet after ResultSet.close() has been called. This is not JDBC-compliant after JDBC-4.0.	false	3.1.11
rollbackOnPooledClose	Should the driver issue a rollback() when the logical connection in a pool is closed?	true	3.0.15
runningCTS13	Enables workarounds for bugs in Sun's JDBC compliance test-suite version 1.3	false	3.1.7
serverTimezone	Override detection/mapping of timezone. Used when timezone from server doesn't map to Java timezone		3.0.2

statementInterceptors	A comma-delimited list of classes that implement "com.mysql.jdbc.StatementInterceptor" that should be placed "in between" query execution to influence the results. StatementInterceptors are "chainable", the results returned by the "current" interceptor will be passed on to the next in the chain, from left-to-right order, as specified in this property.		5.1.1
strictFloatingPoint	Used only in older versions of compliance test	false	3.0.0
strictUpdates	Should the driver do strict checking (all primary keys selected) of updatable result sets (true, false, defaults to 'true')?	true	3.0.4
tinyIntIsBit	Should the driver treat the datatype TINYINT(1) as the BIT type (because the server silently converts BIT -> TINYINT(1) when creating tables)?	true	3.0.16
transformedBitIsBoolean	If the driver converts TINYINT(1) to a different type, should it use BOOLEAN instead of BIT for future compatibility with MySQL-5.0, as MySQL-5.0 has a BIT type?	false	3.1.9
treatUtilDateAsTimestamp	Should the driver treat java.util.Date as a TIMESTAMP for the purposes of PreparedStatement.setObject()?	true	5.0.5
ultraDevHack	Create PreparedStatements for prepareCall() when required, because UltraDev is broken and issues a prepareCall() for _all_ statements? (true/false, defaults to 'false')	false	2.0.3
useGmtMillisForDatetimes	Convert between session timezone and GMT before creating Date and Timestamp instances (value of "false" is legacy behavior, "true" leads to more JDBC-compliant behavior.	false	3.1.12
useHostsInPrivileges	Add '@hostname' to users in Database-MetaData.getColumn/TablePrivileges() (true/false), defaults to 'true'.	true	3.0.2
useInformationSchema	When connected to MySQL-5.0.7 or newer, should the driver use the INFORMATION_SCHEMA to derive information used by DatabaseMetaData?	false	5.0.0
useJDBCCompliantTimezoneShift	Should the driver use JDBC-compliant rules when converting TIME/TIMESTAMP/DATETIME values' timezone information for those JDBC arguments which take a java.util.Calendar argument? (Notice that this option is exclusive of the "use-Timezone=true" configuration option.)	false	5.0.0
useLegacyDatetimeCode	Use code for DATE/TIME/DATETIME/TIMESTAMP handling in result sets and statements that consistently handles timezone conversions from client to server and back again, or use the legacy code for these datatypes that has been in the driver for backwards-compatibility?	true	5.1.6
useOldAliasMetadataBehavior	Should the driver use the legacy behavior for "AS" clauses on columns and tables, and only return aliases (if any) for ResultSetMetaData.getColumn() or ResultSetMetaData.getTableName() rather than the original column/table name? In 5.0.x, the default value was true.	false	5.0.4
useOldUTF8Behavior	Use the UTF-8 behavior the driver did when communicating with 4.0 and older servers	false	3.1.6
useOnlyServerErrorMessages	Do not prepend 'standard' SQLState error messages to error messages returned by the server.	true	3.0.15
useSSPSCompatibleTimezoneShift	If migrating from an environment that was using server-side prepared statements, and the configuration property "useJDBCCompliantTimezoneShift" set to "true", use compatible behavior when not using server-side prepared statements when sending TIMESTAMP values to the MySQL server.	false	5.0.5
useServerPrepStmts	Use server-side prepared statements if the server supports them?	false	3.1.0
useSqlStateCodes	Use SQL Standard state codes instead of 'legacy' X/Open/SQL state codes (true/false), default is 'true'	true	3.1.3
useStreamLengthsInPrepStmts	Honor stream length parameter in PreparedStatement/ResultSet.setXXXStream() method calls (true/false, defaults to 'true')?	true	3.0.2
useTimezone	Convert time/date types between client and server timezones (true/false, defaults to 'false')?	false	3.0.2

useUnbufferedInput	Do not use BufferedInputStream for reading data from the server	true	3.0.11
yearIsDateType	Should the JDBC driver treat the MySQL type "YEAR" as a java.sql.Date, or as a SHORT?	true	3.1.9
zeroDateTimeBehavior	What should happen when the driver encounters DATETIME values that are composed entirely of zeroes (used by MySQL to represent invalid dates)? Valid values are "exception", "round" and "convertToNull".	exception	3.1.4

Connector/J also supports access to MySQL via named pipes on Windows NT/2000/XP using the NamedPipeSocketFactory as a plugin-socket factory via the socketFactory property. If you do not use a namedPipePath property, the default of '\\.\pipe\MySQL' will be used. If you use the [NamedPipeSocketFactory](#), the host name and port number values in the JDBC url will be ignored. You can enable this feature using:

```
socketFactory=com.mysql.jdbc.NamedPipeSocketFactory
```

Named pipes only work when connecting to a MySQL server on the same physical machine as the one the JDBC driver is being used on. In simple performance tests, it appears that named pipe access is between 30%-50% faster than the standard TCP/IP access. However, this varies per system, and named pipes are slower than TCP/IP in many Windows configurations.

You can create your own socket factories by following the example code in [com.mysql.jdbc.NamedPipeSocketFactory](#), or [com.mysql.jdbc.StandardSocketFactory](#).

#### 20.4.4.2. JDBC API Implementation Notes

MySQL Connector/J passes all of the tests in the publicly-available version of Sun's JDBC compliance test suite. However, in many places the JDBC specification is vague about how certain functionality should be implemented, or the specification allows leeway in implementation.

This section gives details on a interface-by-interface level about how certain implementation decisions may affect how you use MySQL Connector/J.

- **Blob**

Starting with Connector/J version 3.1.0, you can emulate Blobs with locators by adding the property 'emulateLocators=true' to your JDBC URL. Using this method, the driver will delay loading the actual Blob data until you retrieve the other data and then use retrieval methods ([getInputStream\(\)](#), [getBytes\(\)](#), and so forth) on the blob data stream.

For this to work, you must use a column alias with the value of the column to the actual name of the Blob, for example:

```
SELECT id, 'data' as blob_data from blobtable
```

For this to work, you must also follow these rules:

- The **SELECT** must also reference only one table, the table must have a primary key.
- The **SELECT** must alias the original blob column name, specified as a string, to an alternate name.
- The **SELECT** must cover all columns that make up the primary key.

The Blob implementation does not allow in-place modification (they are copies, as reported by the [DatabaseMetaData.locatorsUpdateCopies\(\)](#) method). Because of this, you should use the corresponding [PreparedStatement.setBlob\(\)](#) or [ResultSet.updateBlob\(\)](#) (in the case of updatable result sets) methods to save changes back to the database.

#### MySQL Enterprise

MySQL Enterprise subscribers will find more information about type conversion in the Knowledge Base article, [Type Conversions Supported by MySQL Connector/J](#). To subscribe to MySQL Enterprise see <http://www.mysql.com/products/enterprise/advisors.html>.

- **CallableStatement**

Starting with Connector/J 3.1.1, stored procedures are supported when connecting to MySQL version 5.0 or newer via the [CallableStatement](#) interface. Currently, the [getParameterMetaData\(\)](#) method of [CallableStatement](#) is not supported.

- **Clob**

The Clob implementation does not allow in-place modification (they are copies, as reported by the `DatabaseMetaData.locatorsUpdateCopies()` method). Because of this, you should use the `PreparedStatement.setClob()` method to save changes back to the database. The JDBC API does not have a `ResultSet.updateClob()` method.

- **Connection**

Unlike older versions of MM.MySQL the `isClosed()` method does not ping the server to determine if it is alive. In accordance with the JDBC specification, it only returns true if `closed()` has been called on the connection. If you need to determine if the connection is still valid, you should issue a simple query, such as `SELECT 1`. The driver will throw an exception if the connection is no longer valid.

- **DatabaseMetaData**

Foreign Key information (`getImportedKeys()/getExportedKeys()` and `getCrossReference()`) is only available from InnoDB tables. However, the driver uses `SHOW CREATE TABLE` to retrieve this information, so when other storage engines support foreign keys, the driver will transparently support them as well.

- **PreparedStatement**

PreparedStatements are implemented by the driver, as MySQL does not have a prepared statement feature. Because of this, the driver does not implement `getParameterMetaData()` or `getMetaData()` as it would require the driver to have a complete SQL parser in the client.

Starting with version 3.1.0 MySQL Connector/J, server-side prepared statements and binary-encoded result sets are used when the server supports them.

Take care when using a server-side prepared statement with **large** parameters that are set via `setBinaryStream()`, `setAsciiStream()`, `setUnicodeStream()`, `setBlob()`, or `setClob()`. If you want to re-execute the statement with any large parameter changed to a non-large parameter, it is necessary to call `clearParameters()` and set all parameters again. The reason for this is as follows:

- During both server-side prepared statements and client-side emulation, large data is exchanged only when `PreparedStatement.execute()` is called.
- Once that has been done, the stream used to read the data on the client side is closed (as per the JDBC spec), and cannot be read from again.
- If a parameter changes from large to non-large, the driver must reset the server-side state of the prepared statement to allow the parameter that is being changed to take the place of the prior large value. This removes all of the large data that has already been sent to the server, thus requiring the data to be re-sent, via the `setBinaryStream()`, `setAsciiStream()`, `setUnicodeStream()`, `setBlob()` or `setClob()` methods.

Consequently, if you want to change the type of a parameter to a non-large one, you must call `clearParameters()` and set all parameters of the prepared statement again before it can be re-executed.

- **ResultSet**

By default, ResultSets are completely retrieved and stored in memory. In most cases this is the most efficient way to operate, and due to the design of the MySQL network protocol is easier to implement. If you are working with ResultSets that have a large number of rows or large values, and can not allocate heap space in your JVM for the memory required, you can tell the driver to stream the results back one row at a time.

To enable this functionality, you need to create a Statement instance in the following manner:

```
stmt = conn.createStatement( java.sql.ResultSet.TYPE_FORWARD_ONLY,
                             java.sql.ResultSet.CONCUR_READ_ONLY );
stmt.setFetchSize( Integer.MIN_VALUE );
```

The combination of a forward-only, read-only result set, with a fetch size of `Integer.MIN_VALUE` serves as a signal to the driver to stream result sets row-by-row. After this any result sets created with the statement will be retrieved row-by-row.

There are some caveats with this approach. You will have to read all of the rows in the result set (or close it) before you can issue any other queries on the connection, or an exception will be thrown.

The earliest the locks these statements hold can be released (whether they be `MyISAM` table-level locks or row-level locks in some other storage engine such as `InnoDB`) is when the statement completes.

If the statement is within scope of a transaction, then locks are released when the transaction completes (which implies that the

statement needs to complete first). As with most other databases, statements are not complete until all the results pending on the statement are read or the active result set for the statement is closed.

Therefore, if using streaming results, you should process them as quickly as possible if you want to maintain concurrent access to the tables referenced by the statement producing the result set.

- **ResultSetMetaData**

The `isAutoIncrement()` method only works when using MySQL servers 4.0 and newer.

- **Statement**

When using versions of the JDBC driver earlier than 3.2.1, and connected to server versions earlier than 5.0.3, the `setFetchSize()` method has no effect, other than to toggle result set streaming as described above.

Connector/J 5.0.0 and later include support for both `Statement.cancel()` and `Statement.setQueryTimeout()`. Both require MySQL 5.0.0 or newer server, and require a separate connection to issue the `KILL QUERY` statement. In the case of `setQueryTimeout()`, the implementation creates an additional thread to handle the timeout functionality.

### Note

Failures to cancel the statement for `setQueryTimeout()` may manifest themselves as `RuntimeException` rather than failing silently, as there is currently no way to unblock the thread that is executing the query being cancelled due to timeout expiration and have it throw the exception instead.

MySQL does not support SQL cursors, and the JDBC driver doesn't emulate them, so "setCursorName()" has no effect.

Connector/J 5.1.3 and later include two additional methods:

- `setLocalInfileInputStream()` sets an `InputStream` instance that will be used to send data to the MySQL server for a `LOAD DATA LOCAL INFILE` statement rather than a `FileInputStream` or `URLInputStream` that represents the path given as an argument to the statement.

This stream will be read to completion upon execution of a `LOAD DATA LOCAL INFILE` statement, and will automatically be closed by the driver, so it needs to be reset before each call to `execute*()` that would cause the MySQL server to request data to fulfill the request for `LOAD DATA LOCAL INFILE`.

If this value is set to `NULL`, the driver will revert to using a `FileInputStream` or `URLInputStream` as required.

- `getLocalInfileInputStream()` returns the `InputStream` instance that will be used to send data in response to a `LOAD DATA LOCAL INFILE` statement.

This method returns `NULL` if no such stream has been set via `setLocalInfileInputStream()`.

### 20.4.4.3. Java, JDBC and MySQL Types

MySQL Connector/J is flexible in the way it handles conversions between MySQL data types and Java data types.

In general, any MySQL data type can be converted to a `java.lang.String`, and any numerical type can be converted to any of the Java numerical types, although round-off, overflow, or loss of precision may occur.

Starting with Connector/J 3.1.0, the JDBC driver will issue warnings or throw `DataTruncation` exceptions as is required by the JDBC specification unless the connection was configured not to do so by using the property `jdbcCompliantTruncation` and setting it to `false`.

The conversions that are always guaranteed to work are listed in the following table:

#### Connection Properties - Miscellaneous.

These MySQL Data Types	Can always be converted to these Java types
CHAR, VARCHAR, BLOB, TEXT, ENUM, and SET	<code>java.lang.String</code> , <code>java.io.InputStream</code> , <code>java.io.Reader</code> , <code>java.sql.Blob</code> , <code>java.sql.Clob</code>
FLOAT, REAL, DOUBLE PRECISION, NUMERIC, DECIMAL, TINYINT, SMALLINT, MEDIUMINT, INTEGER, BIGINT	<code>java.lang.String</code> , <code>java.lang.Short</code> , <code>java.lang.Integer</code> , <code>java.lang.Long</code> , <code>java.lang.Double</code> , <code>java.math.BigDecimal</code>
DATE, TIME, DATETIME, TIMESTAMP	<code>java.lang.String</code> , <code>java.sql.Date</code> ,

	<code>java.sql.Timestamp</code>
--	---------------------------------

**Note**

Round-off, overflow or loss of precision may occur if you choose a Java numeric data type that has less precision or capacity than the MySQL data type you are converting to/from.

The `ResultSet.getObject()` method uses the type conversions between MySQL and Java types, following the JDBC specification where appropriate. The value returned by `ResultSetMetaData.getColumnClassName()` is also shown below. For more information on the `java.sql.Types` classes see [Java 2 Platform Types](#).

**MySQL Types to Java Types for `ResultSet.getObject()`.**

MySQL Type Name	Return value of <code>getColumnClassName</code>	Returned as Java Class
BIT(1) (new in MySQL-5.0)	BIT	<code>java.lang.Boolean</code>
BIT(> 1) (new in MySQL-5.0)	BIT	<code>byte[]</code>
TINYINT	TINYINT	<code>java.lang.Boolean</code> if the configuration property <code>tinyIntIsBit</code> is set to <code>true</code> (the default) and the storage size is 1, or <code>java.lang.Integer</code> if not.
BOOL, BOOLEAN	TINYINT	See TINYINT, above as these are aliases for TINYINT(1), currently.
SMALLINT[(M)] [UNSIGNED]	SMALLINT [UNSIGNED]	<code>java.lang.Integer</code> (regardless if UNSIGNED or not)
MEDIUMINT[(M)] [UNSIGNED]	MEDIUMINT [UNSIGNED]	<code>java.lang.Integer</code> , if UNSIGNED <code>java.lang.Long</code> (C/J 3.1 and earlier), or <code>java.lang.Integer</code> for C/J 5.0 and later
INT,INTEGER[(M)] [UNSIGNED]	INTEGER [UNSIGNED]	<code>java.lang.Integer</code> , if UNSIGNED <code>java.lang.Long</code>
BIGINT[(M)] [UNSIGNED]	BIGINT [UNSIGNED]	<code>java.lang.Long</code> , if UNSIGNED <code>java.math.BigInteger</code>
FLOAT[(M,D)]	FLOAT	<code>java.lang.Float</code>
DOUBLE[(M,B)]	DOUBLE	<code>java.lang.Double</code>
DECIMAL[(M,D)]	DECIMAL	<code>java.math.BigDecimal</code>
DATE	DATE	<code>java.sql.Date</code>
DATETIME	DATETIME	<code>java.sql.Timestamp</code>
TIMESTAMP[(M)]	TIMESTAMP	<code>java.sql.Timestamp</code>
TIME	TIME	<code>java.sql.Time</code>
YEAR[(2 4)]	YEAR	If <code>yearIsDateType</code> configuration property is set to false, then the returned object type is <code>java.sql.Short</code> . If set to true (the default) then an object of type <code>java.sql.Date</code> (with the date set to January 1st, at midnight).
CHAR(M)	CHAR	<code>java.lang.String</code> (unless the character set for the column is BINARY, then <code>byte[]</code> is returned).
VARCHAR(M) [BINARY]	VARCHAR	<code>java.lang.String</code> (unless the character set for the column is BINARY, then <code>byte[]</code> is returned).
BINARY(M)	BINARY	<code>byte[]</code>
VARBINARY(M)	VARBINARY	<code>byte[]</code>
TINYBLOB	TINYBLOB	<code>byte[]</code>
TINYTEXT	VARCHAR	<code>java.lang.String</code>
BLOB	BLOB	<code>byte[]</code>
TEXT	VARCHAR	<code>java.lang.String</code>
MEDIUMBLOB	MEDIUMBLOB	<code>byte[]</code>
MEDIUMTEXT	VARCHAR	<code>java.lang.String</code>
LOBLOB	LOBLOB	<code>byte[]</code>
LONGTEXT	VARCHAR	<code>java.lang.String</code>



ENUM('value1','value2',...)	CHAR	<code>java.lang.String</code>
SET('value1','value2',...)	CHAR	<code>java.lang.String</code>

#### 20.4.4.4. Using Character Sets and Unicode

All strings sent from the JDBC driver to the server are converted automatically from native Java Unicode form to the client character encoding, including all queries sent via `Statement.execute()`, `Statement.executeUpdate()`, `Statement.executeQuery()` as well as all `PreparedStatement` and `CallableStatement` parameters with the exclusion of parameters set using `setBytes()`, `setBinaryStream()`, `setAsciiStream()`, `setUnicodeStream()` and `setBlob()`.

Prior to MySQL Server 4.1, Connector/J supported a single character encoding per connection, which could either be automatically detected from the server configuration, or could be configured by the user through the `useUnicode` and `characterEncoding` properties.

Starting with MySQL Server 4.1, Connector/J supports a single character encoding between client and server, and any number of character encodings for data returned by the server to the client in `ResultSets`.

The character encoding between client and server is automatically detected upon connection. The encoding used by the driver is specified on the server via the `character_set` system variable for server versions older than 4.1.0 and `character_set_server` for server versions 4.1.0 and newer. For more information, see [Section 9.1.3.1, “Server Character Set and Collation”](#).

To override the automatically-detected encoding on the client side, use the `characterEncoding` property in the URL used to connect to the server.

When specifying character encodings on the client side, Java-style names should be used. The following table lists Java-style names for MySQL character sets:

##### MySQL to Java Encoding Name Translations.

MySQL Character Set Name	Java-Style Character Encoding Name
ascii	US-ASCII
big5	Big5
gbk	GBK
sjis	SJIS (or Cp932 or MS932 for MySQL Server < 4.1.11)
cp932	Cp932 or MS932 (MySQL Server > 4.1.11)
gb2312	EUC_CN
ujis	EUC_JP
euckr	EUC_KR
latin1	ISO8859_1
latin2	ISO8859_2
greek	ISO8859_7
hebrew	ISO8859_8
cp866	Cp866
tis620	TIS620
cp1250	Cp1250
cp1251	Cp1251
cp1257	Cp1257
macroman	MacRoman
macce	MacCentralEurope
utf8	UTF-8
ucs2	UnicodeBig

#### Warning

Do not issue the query 'set names' with Connector/J, as the driver will not detect that the character set has changed,

and will continue to use the character set detected during the initial connection setup.

To allow multiple character sets to be sent from the client, the UTF-8 encoding should be used, either by configuring `utf8` as the default server character set, or by configuring the JDBC driver to use UTF-8 through the `characterEncoding` property.

### 20.4.4.5. Connecting Securely Using SSL

SSL in MySQL Connector/J encrypts all data (other than the initial handshake) between the JDBC driver and the server. The performance penalty for enabling SSL is an increase in query processing time between 35% and 50%, depending on the size of the query, and the amount of data it returns.

For SSL Support to work, you must have the following:

- A JDK that includes JSSE (Java Secure Sockets Extension), like JDK-1.4.1 or newer. SSL does not currently work with a JDK that you can add JSSE to, like JDK-1.2.x or JDK-1.3.x due to the following JSSE bug: <http://developer.java.sun.com/developer/bugParade/bugs/4273544.html>
- A MySQL server that supports SSL and has been compiled and configured to do so, which is MySQL-4.0.4 or later, see [Section 5.5.7, “Using SSL for Secure Connections”](#), for more information.
- A client certificate (covered later in this section)

The system works through two Java truststore files, one file contains the certificate information for the server (`truststore` in the examples below). The other file contains the certificate for the client (`keystore` in the examples below). All Java truststore files are password protected by supplying a suitable password to the `keytool` when you create the files. You need the file names and associated passwords to create an SSL connection.

You will first need to import the MySQL server CA Certificate into a Java truststore. A sample MySQL server CA Certificate is located in the `SSL` subdirectory of the MySQL source distribution. This is what SSL will use to determine if you are communicating with a secure MySQL server. Alternatively, use the CA Certificate that you have generated or been provided with by your SSL provider.

To use Java's `keytool` to create a truststore in the current directory, and import the server's CA certificate (`cacert.pem`), you can do the following (assuming that `keytool` is in your path. The `keytool` should be located in the `bin` subdirectory of your JDK or JRE):

```
shell> keytool -import -alias mysqlServerCACert \
               -file cacert.pem -keystore truststore
```

You will need to enter the password when prompted for the keystore file. Interaction with `keytool` will look like this:

```
Enter keystore password: *****
Owner: EMAILADDRESS=walrus@example.com, CN=Walrus,
O=MySQL AB, L=Orenburg, ST=Some-State, C=RU
Issuer: EMAILADDRESS=walrus@example.com, CN=Walrus,
O=MySQL AB, L=Orenburg, ST=Some-State, C=RU
Serial number: 0
Valid from:
  Fri Aug 02 16:55:53 CDT 2002 until: Sat Aug 02 16:55:53 CDT 2003
Certificate fingerprints:
  MD5: 61:91:A0:F2:03:07:61:7A:81:38:66:DA:19:C4:8D:AB
  SHA1: 25:77:41:05:D5:AD:99:8C:14:8C:CA:68:9C:2F:B8:89:C3:34:4D:6C
Trust this certificate? [no]: yes
Certificate was added to keystore
```

You then have two options, you can either import the client certificate that matches the CA certificate you just imported, or you can create a new client certificate.

To import an existing certificate, the certificate should be in DER format. You can use `openssl` to convert an existing certificate into the new format. For example:

```
shell> openssl x509 -outform DER -in client-cert.pem -out client.cert
```

You now need to import the converted certificate into your keystore using `keytool`:

```
shell> keytool -import -file client.cert -keystore keystore -alias mysqlClientCertificate
```

To generate your own client certificate, use `keytool` to create a suitable certificate and add it to the `keystore` file:

```
shell> keytool -genkey -keyalg rsa \
```

```
-alias mysqlClientCertificate -keystore keystore
```

Keytool will prompt you for the following information, and create a keystore named `keystore` in the current directory.

You should respond with information that is appropriate for your situation:

```
Enter keystore password: *****
What is your first and last name?
[Unknown]: Matthews
What is the name of your organizational unit?
[Unknown]: Software Development
What is the name of your organization?
[Unknown]: MySQL AB
What is the name of your City or Locality?
[Unknown]: Flossmoor
What is the name of your State or Province?
[Unknown]: IL
What is the two-letter country code for this unit?
[Unknown]: US
Is <CN=Matthews, OU=Software Development, O=MySQL AB,
L=Flossmoor, ST=IL, C=US> correct?
[no]: y

Enter key password for <mysqlClientCertificate>
(RETURN if same as keystore password):
```

Finally, to get JSSE to use the keystore and truststore that you have generated, you need to set the following system properties when you start your JVM, replacing `path_to_keystore_file` with the full path to the keystore file you created, `path_to_truststore_file` with the path to the truststore file you created, and using the appropriate password values for each property. You can do this either on the command line:

```
-Djavax.net.ssl.keyStore=path_to_keystore_file
-Djavax.net.ssl.keyStorePassword=password
-Djavax.net.ssl.trustStore=path_to_truststore_file
-Djavax.net.ssl.trustStorePassword=password
```

Or you can set the values directly within the application:

```
System.setProperty("javax.net.ssl.keyStore","path_to_keystore_file");
System.setProperty("javax.net.ssl.keyStorePassword","password");
System.setProperty("javax.net.ssl.trustStore","path_to_truststore_file");
System.setProperty("javax.net.ssl.trustStorePassword","password");
```

You will also need to set `useSSL` to `true` in your connection parameters for MySQL Connector/J, either by adding `useSSL=true` to your URL, or by setting the property `useSSL` to `true` in the `java.util.Properties` instance you pass to `DriverManager.getConnection()`.

You can test that SSL is working by turning on JSSE debugging (as detailed below), and look for the following key events:

```
...
*** ClientHello, v3.1
RandomCookie: GMT: 1018531834 bytes = { 199, 148, 180, 215, 74, 12, »
 54, 244, 0, 168, 55, 103, 215, 64, 16, 138, 225, 190, 132, 153, 2, »
 217, 219, 239, 202, 19, 121, 78 }
Session ID: {}
Cipher Suites: { 0, 5, 0, 4, 0, 9, 0, 10, 0, 18, 0, 19, 0, 3, 0, 17 }
Compression Methods: { 0 }
***
[write] MD5 and SHA1 hashes: len = 59
0000: 01 00 00 37 03 01 3D B6 90 FA C7 94 B4 D7 4A 0C ...7..=.....J.
0010: 36 F4 00 A8 37 67 D7 40 10 8A E1 BE 84 99 02 D9 6...7g.@.....
0020: DB EF CA 13 79 4E 00 00 10 00 05 00 04 00 09 00 ...yN.....
0030: 0A 00 12 00 13 00 03 00 11 01 00 .....
main, WRITE: SSL v3.1 Handshake, length = 59
main, READ: SSL v3.1 Handshake, length = 74
*** ServerHello, v3.1
RandomCookie: GMT: 1018577560 bytes = { 116, 50, 4, 103, 25, 100, 58, »
 202, 79, 185, 178, 100, 215, 66, 254, 21, 83, 187, 190, 42, 170, 3, »
 132, 110, 82, 148, 160, 92 }
Session ID: {163, 227, 84, 53, 81, 127, 252, 254, 178, 179, 68, 63, »
 182, 158, 30, 11, 150, 79, 170, 76, 255, 92, 15, 226, 24, 17, 177, »
 219, 158, 177, 187, 143}
Cipher Suite: { 0, 5 }
Compression Method: 0
***
%% Created: [Session-1, SSL_RSA_WITH_RC4_128_SHA]
** SSL_RSA_WITH_RC4_128_SHA
[read] MD5 and SHA1 hashes: len = 74
0000: 02 00 00 46 03 01 3D B6 43 98 74 32 04 67 19 64 ...F..=.C.t2.g.d
0010: 3A CA 4F B9 B2 64 D7 42 FE 15 53 BB BE 2A AA 03 :.O..d.B..S..*..
0020: 84 6E 52 94 A0 5C 20 A3 E3 54 35 51 7F FC FE B2 .nR..\ ..T5Q....
0030: B3 44 3F B6 9E 1E 0B 96 4F AA 4C FF 5C 0F E2 18 .D?.....O.L.\...
0040: 11 B1 DB 9E B1 BB 8F 00 05 00 .....
main, READ: SSL v3.1 Handshake, length = 1712
...

```

JSSSE provides debugging (to STDOUT) when you set the following system property: `-Djavax.net.debug=all`. This will tell you what keystores and truststores are being used, as well as what is going on during the SSL handshake and certificate exchange. It will be helpful when trying to determine what is not working when trying to get an SSL connection to happen.

#### 20.4.4.6. Using Master/Slave Replication with ReplicationConnection

Starting with Connector/J 3.1.7, we've made available a variant of the driver that will automatically send queries to a read/write master, or a failover or round-robin loadbalanced set of slaves based on the state of `Connection.getReadOnly()`.

An application signals that it wants a transaction to be read-only by calling `Connection.setReadOnly(true)`, this replication-aware connection will use one of the slave connections, which are load-balanced per-vm using a round-robin scheme (a given connection is sticky to a slave unless that slave is removed from service). If you have a write transaction, or if you have a read that is time-sensitive (remember, replication in MySQL is asynchronous), set the connection to be not read-only, by calling `Connection.setReadOnly(false)` and the driver will ensure that further calls are sent to the master MySQL server. The driver takes care of propagating the current state of autocommit, isolation level, and catalog between all of the connections that it uses to accomplish this load balancing functionality.

To enable this functionality, use the "`com.mysql.jdbc.ReplicationDriver`" class when configuring your application server's connection pool or when creating an instance of a JDBC driver for your standalone application. Because it accepts the same URL format as the standard MySQL JDBC driver, `ReplicationDriver` does not currently work with `java.sql.DriverManager`-based connection creation unless it is the only MySQL JDBC driver registered with the `DriverManager`.

Here is a short, simple example of how `ReplicationDriver` might be used in a standalone application.

```
import java.sql.Connection;
import java.sql.ResultSet;
import java.util.Properties;

import com.mysql.jdbc.ReplicationDriver;

public class ReplicationDriverDemo {

    public static void main(String[] args) throws Exception {
        ReplicationDriver driver = new ReplicationDriver();

        Properties props = new Properties();

        // We want this for failover on the slaves
        props.put("autoReconnect", "true");

        // We want to load balance between the slaves
        props.put("roundRobinLoadBalance", "true");

        props.put("user", "foo");
        props.put("password", "bar");

        //
        // Looks like a normal MySQL JDBC url, with a
        // comma-separated list of hosts, the first
        // being the 'master', the rest being any number
        // of slaves that the driver will load balance against
        //
        Connection conn =
            driver.connect("jdbc:mysql://master,slave1,slave2,slave3/test",
                props);

        //
        // Perform read/write work on the master
        // by setting the read-only flag to "false"
        //
        conn.setReadOnly(false);
        conn.setAutoCommit(false);
        conn.createStatement().executeUpdate("UPDATE some_table ...");
        conn.commit();

        //
        // Now, do a query from a slave, the driver automatically picks one
        // from the list
        //
        conn.setReadOnly(true);

        ResultSet rs =
            conn.createStatement().executeQuery("SELECT a,b FROM alt_table");

        .....
    }
}
```

You may also want to investigate the Load Balancing JDBC Pool (lbpool) tool, which provides a wrapper around the standard JDBC driver and allows you to use DB connection pools that includes checks for system failures and uneven load distribution. For more

information, see [Load Balancing JDBC Pool \(lbpool\)](#).

### 20.4.4.7. Mapping MySQL Error Numbers to SQLStates

The table below provides a mapping of the MySQL Error Numbers to [SQL States](#)

**Table 20.3. Mapping of MySQL Error Numbers to SQLStates**

MySQL Error Number	MySQL Error Name	Legacy (X/Open) SQLState	SQL Standard SQLState
1022	ER_DUP_KEY	S1000	23000
1037	ER_OUT_OFMEMORY	S1001	HY001
1038	ER_OUT_OF_SORTMEMORY	S1001	HY001
1040	ER_CON_COUNT_ERROR	08004	08004
1042	ER_BAD_HOST_ERROR	08004	08S01
1043	ER_HANDSHAKE_ERROR	08004	08S01
1044	ER_DBACCESS_DENIED_ERROR	S1000	42000
1045	ER_ACCESS_DENIED_ERROR	28000	28000
1047	ER_UNKNOWN_COM_ERROR	08S01	HY000
1050	ER_TABLE_EXISTS_ERROR	S1000	42S01
1051	ER_BAD_TABLE_ERROR	42S02	42S02
1052	ER_NON_UNIQUE_ERROR	S1000	23000
1053	ER_SERVER_SHUTDOWN	S1000	08S01
1055	ER_BAD_SLAVE	S00	42S

MySQL Error Number	MySQL Error Name	Legacy (X/Open) SQLState	SQL Standard SQLState
4	_FIELD_ERROR	22	22
1055	ER_WRONG_FIELD_WITH_GROUP	S1009	42000
1056	ER_WRONG_GROUP_FIELD	S1009	42000
1057	ER_WRONG_SUM_SELECT	S1009	42000
1058	ER_WRONG_VALUE_COUNT	21S01	21S01
1059	ER_TOO_LONG_IDENT	S1009	42000
1060	ER_DUP_FIELD_NAME	S1009	42S21
1061	ER_DUP_KEYNAME	S1009	42000
1062	ER_DUP_ENTRY	S1009	23000
1063	ER_WRONG_FIELD_SPEC	S1009	42000
1064	ER_PARSE_ERROR	42000	42000
1065	ER_EMPTY_QUERY	42000	42000
1066	ER_NON_UNIQUE_TABLE	S1009	42000
1067	ER_INVALID_ID_DEFAULT	S1009	42000
1068	ER_MULTIPLE_PRI_KEY	S1009	42000
1069	ER_TOO_MANY_KEYS	S1009	42000
107	ER_TOO	S10	420

MySQL Error Number	MySQL Error Name	Legacy (X/Open) SQLState	SQL Standard SQLState
0	_MANY_KEY_PARTS	09	00
1071	ER_TOO_LONG_KEY	S1009	4200
1072	ER_KEY_COLUMN_DOES_NOT_EXITS	S1009	4200
1073	ER_BLOB_USED_AS_KEY	S1009	4200
1074	ER_TOO_BIG_FIELDLENGTH	S1009	4200
1075	ER_WRONG_AUTO_KEY	S1009	4200
1080	ER_FORGING_CLOSE	S1000	08S01
1081	ER_IPSOCK_ERROR	08S01	08S01
1082	ER_NO_SUCH_INDEX	S1009	42S12
1083	ER_WRONG_FIELD_TERMINATORS	S1009	4200
1084	ER_BLOB_AND_NO_TERMINATED	S1009	4200
1090	ER_CANT_REMOVE_ALL_FIELDS	S1000	4200
1091	ER_CANT_DROP_FIELD_OR_KEY	S1000	4200
1101	ER_BLOB_CANT_HAVE_DEFAULT	S1000	4200

MySQL Error Number	MySQL Error Name	Legacy (X/Open) SQLState	SQL Standard SQLState
1102	ER_WRONG_DB_NAME	S1000	42000
1103	ER_WRONG_TABLE_NAME	S1000	42000
1104	ER_TOO_BIG_SELECT	S1000	42000
1106	ER_UNKNOWN_PROCEDURE	S1000	42000
1107	ER_WRONG_PARAM_COUNT_TO_PROCEDURE	S1000	42000
1109	ER_UNKNOWN_TABLE	S1000	42S02
1110	ER_FIELD_SPECIFIED_TWICE	S1000	42000
1112	ER_UNSUPPORTED_EXTENSION	S1000	42000
1113	ER_TABLE_MUST_HAVE_COLUMNS	S1000	42000
1115	ER_UNKNOWN_CHARACTER_SET	S1000	42000
1118	ER_TOO_BIG_ROWSIZE	S1000	42000
1120	ER_WRONG OUTER JOIN	S1000	42000
1121	ER_NULL_COLUMN_IN_	S1000	42000



MySQL Error Number	MySQL Error Name	Legacy (X/Open) SQLState	SQL Standard SQLState
	INDEX		
1129	ER_HOST_IS_BLOCKED	08004	HY000
1130	ER_HOST_NOT_PRIVILEGED	08004	HY000
1131	ER_PASSWORD_ANONYMOUS_USER	S1000	42000
1132	ER_PASSWORD_NOT_ALLOWED	S1000	42000
1133	ER_PASSWORD_NO_MATCH	S1000	42000
1136	ER_WRONG_VALUE_COUNT_ON_ROW	S1000	21S01
1138	ER_INVALID_ID_USE_OF_NULL	S1000	42000
1139	ER_REGEXP_ERROR	S1000	42000
1140	ER_MIX_OF_GROUPS_AND_FIELDS	S1000	42000
1141	ER_NON_EXISTING_GRANT	S1000	42000
1142	ER_TABLEACCESS_DENIED_ERROR	S1000	42000
1143	ER_COLUMN_ACCESS_DENIED	S1000	42000

MySQL Error Number	MySQL Error Name	Legacy (X/Open) SQLState	SQL Standard SQLState
	ENIED_ERROR		
1144	ER_ILLEGAL_GRANT_FOR_TABLE	S1000	42000
1145	ER_GRANT_WRONG_HOST_OR_USER	S1000	42000
1146	ER_NO_SUCH_TABLE	S1000	42S02
1147	ER_NONEXISTING_TABLE_GRANT	S1000	42000
1148	ER_NOT_ALLOWED_COMMAND	S1000	42000
1149	ER_SYNTAX_ERROR	S1000	42000
1152	ER_ABORTING_CONNECTION	S1000	08S01
1153	ER_NET_PACKET_TOO_LARGE	S1000	08S01
1154	ER_NET_READ_ERROR_FROM_PIPE	S1000	08S01
1155	ER_NET_FCNTL_ERROR	S1000	08S01
1156	ER_NET_PACKETS_OUT_OF_ORDER	S1000	08S01
1157	ER_NET_UNCOMPRESS_ERROR	S1000	08S01
115	ER_NET	S10	08S

MySQL Error Number	MySQL Error Name	Legacy (X/Open) SQLState	SQL Standard SQLState
8	_READ_ERROR	00	01
1159	ER_NET_READ_INTERRUPTED	S1000	08S01
1160	ER_NET_ERROR_ON_WRITE	S1000	08S01
1161	ER_NET_WRITE_INTERRUPTED	S1000	08S01
1162	ER_TOO_LONG_STRING	S1000	42000
1163	ER_TABLE_CANT_HANDLE_BLOB	S1000	42000
1164	ER_TABLE_CANT_HANDLE_AUTO_INCREMENT	S1000	42000
1166	ER_WRONG_COLUMN_NAME	S1000	42000
1167	ER_WRONG_KEY_COLUMN	S1000	42000
1169	ER_DUP_UNIQUE	S1000	23000
1170	ER_BLOB_KEY_WITHOUT_LENGTH	S1000	42000
1171	ER_PRIMARY_CANT_HAVE_NULL	S1000	42000
1172	ER_TOO_MANY_ROWS	S1000	42000
1173	ER_REQUIRES_PRIMARY	S1000	42000

MySQL Error Number	MySQL Error Name	Legacy (X/Open) SQLState	SQL Standard SQLState
	Y_KEY		
1177	ER_CHECK_NO_SUCH_TABLE	S1000	42000
1178	ER_CHECK_NOT_IMPLEMENTED	S1000	42000
1179	ER_CANT_DO_THIS_DURING_AN_TRANSACTION	S1000	25000
1184	ER_NETWORK_CONNECTION	S1000	08S01
1189	ER_MASTER_NEVER_READ	S1000	08S01
1190	ER_MASTER_NEVER_WRITE	S1000	08S01
1203	ER_TOO_MANY_USER_CONNECTIONS	S1000	42000
1205	ER_LOCK_WAIT_TIMEOUT	41000	41000
1207	ER_READ_ONLY_TRANSACTION	S1000	25000
1211	ER_NO_PERMISSION_TO_CREATE_USER	S1000	42000
1213	ER_LOCK_DEADLOCK	41000	40001
1216	ER_NO_REFER-	S1000	23000

MySQL Error Number	MySQL Error Name	Legacy (X/Open) SQLState	SQL Standard SQLState
	EN- CED_ RO W		
1217	ER_RO W_IS_R EFER- ENCED	S1000	23000
1218	ER_CON NECT_T O_MAS TER	S1000	08S01
1222	ER_WR ONG_N UM- BER_OF _COLU MNS_IN _SELEC T	S1000	21000
1226	ER_USE R_LIMIT _REACH ED	S1000	42000
1230	ER_NO_ DE- FAULT	S1000	42000
1231	ER_WR ONG_V ALUE_F OR_VA R	S1000	42000
1232	ER_WR ONG_T YPE_FO R_VAR	S1000	42000
1234	ER_CAN T_USE_ OP- TION_H ERE	S1000	42000
1235	ER_NOT _SUPPO RTED_Y ET	S1000	42000
1239	ER_WR ONG_FK _DEF	S1000	42000
1241	ER_OPE RAND_ COLUM NS	S1000	21000
1242	ER_SUB QUERY_ NO_1_R OW	S1000	21000
124	ER_ILLE	S10	42S

MySQL Error Number	MySQL Error Name	Legacy (X/Open) SQLState	SQL Standard SQLState
7	GAL_REFERENCE	00	22
1248	ER_DERIVED_MUST_HAVE_ALIAS	S1000	42000
1249	ER_SELECT_REJECTED	S1000	01000
1250	ER_TABLE_NAME_NOT_ALLOWED_HERE	S1000	42000
1251	ER_NOT_SUPPORTED_AUTH_MODE	S1000	08004
1252	ER_SPATIAL_CANT_HAVE_NULL	S1000	42000
1253	ER_COLLATION_CHARSET_MISMATCH	S1000	42000
1261	ER_WARN_TOO_FEW_RECORDS	S1000	01000
1262	ER_WARN_TOO_MANY_RECORDS	S1000	01000
1263	ER_WARN_NULL_TO_NOTNULL	S1000	01000
1264	ER_WARN_DATA_OUT_OF_RANGE	S1000	01000
1265	ER_WARN_DATA_TRUNCATED	S1000	01000

MySQL Error Number	MySQL Error Name	Legacy (X/Open) SQLState	SQL Standard SQLState
1280	ER_WRONG_INDEX	S1000	42000
1281	ER_WRONG_CATALOG	S1000	42000
1286	ER_UNKNOWN_STORAGE_ENGINE	S1000	42000

## 20.4.5. Connector/J Notes and Tips

### 20.4.5.1. Basic JDBC Concepts

This section provides some general JDBC background.

#### 20.4.5.1.1. Connecting to MySQL Using the `DriverManager` Interface

When you are using JDBC outside of an application server, the `DriverManager` class manages the establishment of Connections.

The `DriverManager` needs to be told which JDBC drivers it should try to make Connections with. The easiest way to do this is to use `Class.forName()` on the class that implements the `java.sql.Driver` interface. With MySQL Connector/J, the name of this class is `com.mysql.jdbc.Driver`. With this method, you could use an external configuration file to supply the driver class name and driver parameters to use when connecting to a database.

The following section of Java code shows how you might register MySQL Connector/J from the `main()` method of your application:

```
import java.sql.Connection;
import java.sql.DriverManager;
import java.sql.SQLException;

// Notice, do not import com.mysql.jdbc.*
// or you will have problems!

public class LoadDriver {
    public static void main(String[] args) {
        try {
            // The newInstance() call is a work around for some
            // broken Java implementations

            Class.forName("com.mysql.jdbc.Driver").newInstance();
        } catch (Exception ex) {
            // handle the error
        }
    }
}
```

After the driver has been registered with the `DriverManager`, you can obtain a `Connection` instance that is connected to a particular database by calling `DriverManager.getConnection()`:

#### Example 20.1. Connector/J: Obtaining a connection from the `DriverManager`

This example shows how you can obtain a `Connection` instance from the `DriverManager`. There are a few different signatures for the `getConnection()` method. You should see the API documentation that comes with your JDK for more specific in-

formation on how to use them.

```
import java.sql.Connection;
import java.sql.DriverManager;
import java.sql.SQLException;

Connection conn = null;
...
try {
    conn =
        DriverManager.getConnection("jdbc:mysql://localhost/test?" +
                                   "user=monty&password=greatsqlldb");

    // Do something with the Connection

    ...
} catch (SQLException ex) {
    // handle any errors
    System.out.println("SQLException: " + ex.getMessage());
    System.out.println("SQLState: " + ex.getSQLState());
    System.out.println("VendorError: " + ex.getErrorCode());
}
```

Once a `Connection` is established, it can be used to create `Statement` and `PreparedStatement` objects, as well as retrieve metadata about the database. This is explained in the following sections.

### 20.4.5.1.2. Using Statements to Execute SQL

`Statement` objects allow you to execute basic SQL queries and retrieve the results through the `ResultSet` class which is described later.

To create a `Statement` instance, you call the `createStatement()` method on the `Connection` object you have retrieved via one of the `DriverManager.getConnection()` or `DataSource.getConnection()` methods described earlier.

Once you have a `Statement` instance, you can execute a `SELECT` query by calling the `executeQuery(String)` method with the SQL you want to use.

To update data in the database, use the `executeUpdate(String SQL)` method. This method returns the number of rows affected by the update statement.

If you do not know ahead of time whether the SQL statement will be a `SELECT` or an `UPDATE/INSERT`, then you can use the `execute(String SQL)` method. This method will return true if the SQL query was a `SELECT`, or false if it was an `UPDATE`, `INSERT`, or `DELETE` statement. If the statement was a `SELECT` query, you can retrieve the results by calling the `getResultSet()` method. If the statement was an `UPDATE`, `INSERT`, or `DELETE` statement, you can retrieve the affected rows count by calling `getUpdateCount()` on the `Statement` instance.

#### Example 20.2. Connector/J: Using `java.sql.Statement` to execute a `SELECT` query

```
import java.sql.Connection;
import java.sql.DriverManager;
import java.sql.SQLException;
import java.sql.Statement;
import java.sql.ResultSet;

// assume that conn is an already created JDBC connection (see previous examples)

Statement stmt = null;
ResultSet rs = null;

try {
    stmt = conn.createStatement();
    rs = stmt.executeQuery("SELECT foo FROM bar");

    // or alternatively, if you don't know ahead of time that
    // the query will be a SELECT...

    if (stmt.execute("SELECT foo FROM bar")) {
        rs = stmt.getResultSet();
    }

    // Now do something with the ResultSet ....
}
catch (SQLException ex){
    // handle any errors
    System.out.println("SQLException: " + ex.getMessage());
    System.out.println("SQLState: " + ex.getSQLState());
    System.out.println("VendorError: " + ex.getErrorCode());
}
finally {
    // it is a good idea to release
    // resources in a finally{} block
    // in reverse-order of their creation
    // if they are no-longer needed
}
```



```

if (rs != null) {
    try {
        rs.close();
    } catch (SQLException sqlEx) { } // ignore
    rs = null;
}

if (stmt != null) {
    try {
        stmt.close();
    } catch (SQLException sqlEx) { } // ignore
    stmt = null;
}
}

```

### 20.4.5.1.3. Using `CallableStatements` to Execute Stored Procedures

Starting with MySQL server version 5.0 when used with Connector/J 3.1.1 or newer, the `java.sql.CallableStatement` interface is fully implemented with the exception of the `getParameterMetaData()` method.

For more information on MySQL stored procedures, please refer to <http://dev.mysql.com/doc/mysql/en/stored-routines.html>.

Connector/J exposes stored procedure functionality through JDBC's `CallableStatement` interface.

#### Note

Current versions of MySQL server do not return enough information for the JDBC driver to provide result set metadata for callable statements. This means that when using `CallableStatement`, `ResultSetMetaData` may return `NULL`.

The following example shows a stored procedure that returns the value of `inOutParam` incremented by 1, and the string passed in via `inputParam` as a `ResultSet`:

#### Example 20.3. Connector/J: Calling Stored Procedures

```

CREATE PROCEDURE demoSp(IN inputParam VARCHAR(255), \
                       INOUT inOutParam INT)
BEGIN
    DECLARE z INT;
    SET z = inOutParam + 1;
    SET inOutParam = z;

    SELECT inputParam;

    SELECT CONCAT('zyxw', inputParam);
END

```

To use the `demoSp` procedure with Connector/J, follow these steps:

1. Prepare the callable statement by using `Connection.prepareCall()`.

Notice that you have to use JDBC escape syntax, and that the parentheses surrounding the parameter placeholders are not optional:

#### Example 20.4. Connector/J: Using `Connection.prepareCall()`

```

import java.sql.CallableStatement;
...

//
// Prepare a call to the stored procedure 'demoSp'
// with two parameters
//
// Notice the use of JDBC-escape syntax ({call ...})
//

CallableStatement cStmt = conn.prepareCall("{call demoSp(?, ?)}");

cStmt.setString(1, "abcdefg");

```

**Note**

`Connection.prepareStatement()` is an expensive method, due to the metadata retrieval that the driver performs to support output parameters. For performance reasons, you should try to minimize unnecessary calls to `Connection.prepareStatement()` by reusing `CallableStatement` instances in your code.

2. Register the output parameters (if any exist)

To retrieve the values of output parameters (parameters specified as `OUT` or `INOUT` when you created the stored procedure), JDBC requires that they be specified before statement execution using the various `registerOutputParameter()` methods in the `CallableStatement` interface:

**Example 20.5. Connector/J: Registering output parameters**

```
import java.sql.Types;
...
//
// Connector/J supports both named and indexed
// output parameters. You can register output
// parameters using either method, as well
// as retrieve output parameters using either
// method, regardless of what method was
// used to register them.
//
// The following examples show how to use
// the various methods of registering
// output parameters (you should of course
// use only one registration per parameter).
//
//
// Registers the second parameter as output, and
// uses the type 'INTEGER' for values returned from
// getObject()
//
cStmt.registerOutParameter(2, Types.INTEGER);
//
// Registers the named parameter 'inOutParam', and
// uses the type 'INTEGER' for values returned from
// getObject()
//
cStmt.registerOutParameter("inOutParam", Types.INTEGER);
...
```

3. Set the input parameters (if any exist)

Input and in/out parameters are set as for `PreparedStatement` objects. However, `CallableStatement` also supports setting parameters by name:

**Example 20.6. Connector/J: Setting `CallableStatement` input parameters**

```
...
//
// Set a parameter by index
//
cStmt.setString(1, "abcdefg");
//
// Alternatively, set a parameter using
// the parameter name
//
cStmt.setString("inputParameter", "abcdefg");
//
// Set the 'in/out' parameter using an index
//
cStmt.setInt(2, 1);
//
// Alternatively, set the 'in/out' parameter
// by name
//
cStmt.setInt("inOutParam", 1);
```

...

4. Execute the `CallableStatement`, and retrieve any result sets or output parameters.

Although `CallableStatement` supports calling any of the `Statement` execute methods (`executeUpdate()`, `executeQuery()` or `execute()`), the most flexible method to call is `execute()`, as you do not need to know ahead of time if the stored procedure returns result sets:

### Example 20.7. Connector/J: Retrieving results and output parameter values

```
...
boolean hadResults = cStmt.execute();
//
// Process all returned result sets
//
while (hadResults) {
    ResultSet rs = cStmt.getResultSet();

    // process result set
    ...

    hadResults = cStmt.getMoreResults();
}

//
// Retrieve output parameters
//
// Connector/J supports both index-based and
// name-based retrieval
//
int outputValue = cStmt.getInt(2); // index-based
outputValue = cStmt.getInt("inOutParam"); // name-based
...
```

#### 20.4.5.1.4. Retrieving `AUTO_INCREMENT` Column Values

Before version 3.0 of the JDBC API, there was no standard way of retrieving key values from databases that supported auto increment or identity columns. With older JDBC drivers for MySQL, you could always use a MySQL-specific method on the `Statement` interface, or issue the query `SELECT LAST_INSERT_ID()` after issuing an `INSERT` to a table that had an `AUTO_INCREMENT` key. Using the MySQL-specific method call isn't portable, and issuing a `SELECT` to get the `AUTO_INCREMENT` key's value requires another round-trip to the database, which isn't as efficient as possible. The following code snippets demonstrate the three different ways to retrieve `AUTO_INCREMENT` values. First, we demonstrate the use of the new JDBC-3.0 method `getGeneratedKeys()` which is now the preferred method to use if you need to retrieve `AUTO_INCREMENT` keys and have access to JDBC-3.0. The second example shows how you can retrieve the same value using a standard `SELECT LAST_INSERT_ID()` query. The final example shows how updatable result sets can retrieve the `AUTO_INCREMENT` value when using the `insertRow()` method.

### Example 20.8. Connector/J: Retrieving `AUTO_INCREMENT` column values using `Statement.getGeneratedKeys()`

```
Statement stmt = null;
ResultSet rs = null;

try {
    //
    // Create a Statement instance that we can use for
    // 'normal' result sets assuming you have a
    // Connection 'conn' to a MySQL database already
    // available
    stmt = conn.createStatement(java.sql.ResultSet.TYPE_FORWARD_ONLY,
                               java.sql.ResultSet.CONCUR_UPDATABLE);

    //
    // Issue the DDL queries for the table for this example
    //
    stmt.executeUpdate("DROP TABLE IF EXISTS autoIncTutorial");
    stmt.executeUpdate(
```

```

        "CREATE TABLE autoIncTutorial ("
        + "priKey INT NOT NULL AUTO_INCREMENT, "
        + "dataField VARCHAR(64), PRIMARY KEY (priKey))");

//
// Insert one row that will generate an AUTO INCREMENT
// key in the 'priKey' field
//
stmt.executeUpdate(
    "INSERT INTO autoIncTutorial (dataField) "
    + "values ('Can I Get the Auto Increment Field?')",
    Statement.RETURN_GENERATED_KEYS);

//
// Example of using Statement.getGeneratedKeys()
// to retrieve the value of an auto-increment
// value
//
int autoIncKeyFromApi = -1;

rs = stmt.getGeneratedKeys();

if (rs.next()) {
    autoIncKeyFromApi = rs.getInt(1);
} else {
    // throw an exception from here
}

rs.close();

rs = null;

System.out.println("Key returned from getGeneratedKeys():"
    + autoIncKeyFromApi);
} finally {
    if (rs != null) {
        try {
            rs.close();
        } catch (SQLException ex) {
            // ignore
        }
    }

    if (stmt != null) {
        try {
            stmt.close();
        } catch (SQLException ex) {
            // ignore
        }
    }
}
}

```

### Example 20.9. Connector/J: Retrieving `AUTO_INCREMENT` column values using `SELECT LAST_INSERT_ID()`

```

Statement stmt = null;
ResultSet rs = null;

try {
    //
    // Create a Statement instance that we can use for
    // 'normal' result sets.

    stmt = conn.createStatement();

    //
    // Issue the DDL queries for the table for this example
    //

    stmt.executeUpdate("DROP TABLE IF EXISTS autoIncTutorial");
    stmt.executeUpdate(
        "CREATE TABLE autoIncTutorial ("
        + "priKey INT NOT NULL AUTO_INCREMENT, "
        + "dataField VARCHAR(64), PRIMARY KEY (priKey))");

    //
    // Insert one row that will generate an AUTO INCREMENT
    // key in the 'priKey' field
    //

    stmt.executeUpdate(
        "INSERT INTO autoIncTutorial (dataField) "
        + "values ('Can I Get the Auto Increment Field?')");

    //
    // Use the MySQL LAST_INSERT_ID()

```

```

// function to do the same thing as getGeneratedKeys()
//
int autoIncKeyFromFunc = -1;
rs = stmt.executeQuery("SELECT LAST_INSERT_ID()");

if (rs.next()) {
    autoIncKeyFromFunc = rs.getInt(1);
} else {
    // throw an exception from here
}

rs.close();

System.out.println("Key returned from " +
    "'SELECT LAST_INSERT_ID()': " +
    autoIncKeyFromFunc);
} finally {
    if (rs != null) {
        try {
            rs.close();
        } catch (SQLException ex) {
            // ignore
        }
    }

    if (stmt != null) {
        try {
            stmt.close();
        } catch (SQLException ex) {
            // ignore
        }
    }
}
}

```

### Example 20.10. Connector/J: Retrieving `AUTO_INCREMENT` column values in `Updatable ResultSets`

```

Statement stmt = null;
ResultSet rs = null;

try {
    //
    // Create a Statement instance that we can use for
    // 'normal' result sets as well as an 'updatable'
    // one, assuming you have a Connection 'conn' to
    // a MySQL database already available
    //
    stmt = conn.createStatement(java.sql.ResultSet.TYPE_FORWARD_ONLY,
        java.sql.ResultSet.CONCUR_UPDATABLE);

    //
    // Issue the DDL queries for the table for this example
    //
    stmt.executeUpdate("DROP TABLE IF EXISTS autoIncTutorial");
    stmt.executeUpdate(
        "CREATE TABLE autoIncTutorial ("
        + "priKey INT NOT NULL AUTO_INCREMENT, "
        + "dataField VARCHAR(64), PRIMARY KEY (priKey))");

    //
    // Example of retrieving an AUTO INCREMENT key
    // from an updatable result set
    //
    rs = stmt.executeQuery("SELECT priKey, dataField "
        + "FROM autoIncTutorial");

    rs.moveToInsertRow();

    rs.updateString("dataField", "AUTO INCREMENT here?");
    rs.insertRow();

    //
    // the driver adds rows at the end
    //
    rs.last();

    //
    // We should now be on the row we just inserted
    //
    int autoIncKeyFromRS = rs.getInt("priKey");
}

```

```

rs.close();

rs = null;

System.out.println("Key returned for inserted row: "
    + autoIncKeyFromRS);
} finally {

    if (rs != null) {
        try {
            rs.close();
        } catch (SQLException ex) {
            // ignore
        }
    }

    if (stmt != null) {
        try {
            stmt.close();
        } catch (SQLException ex) {
            // ignore
        }
    }
}
}

```

When you run the preceding example code, you should get the following output: Key returned from `getGeneratedKeys()`: 1 Key returned from `SELECT LAST_INSERT_ID()`: 1 Key returned for inserted row: 2 You should be aware, that at times, it can be tricky to use the `SELECT LAST_INSERT_ID()` query, as that function's value is scoped to a connection. So, if some other query happens on the same connection, the value will be overwritten. On the other hand, the `getGeneratedKeys()` method is scoped by the `Statement` instance, so it can be used even if other queries happen on the same connection, but not on the same `Statement` instance.

## 20.4.5.2. Using Connector/J with J2EE and Other Java Frameworks

This section describes how to use Connector/J in several contexts.

### 20.4.5.2.1. General J2EE Concepts

This section provides general background on J2EE concepts that pertain to use of Connector/J.

#### 20.4.5.2.1.1. Understanding Connection Pooling

Connection pooling is a technique of creating and managing a pool of connections that are ready for use by any thread that needs them.

This technique of pooling connections is based on the fact that most applications only need a thread to have access to a JDBC connection when they are actively processing a transaction, which usually take only milliseconds to complete. When not processing a transaction, the connection would otherwise sit idle. Instead, connection pooling allows the idle connection to be used by some other thread to do useful work.

In practice, when a thread needs to do work against a MySQL or other database with JDBC, it requests a connection from the pool. When the thread is finished using the connection, it returns it to the pool, so that it may be used by any other threads that want to use it.

When the connection is loaned out from the pool, it is used exclusively by the thread that requested it. From a programming point of view, it is the same as if your thread called `DriverManager.getConnection()` every time it needed a JDBC connection, however with connection pooling, your thread may end up using either a new, or already-existing connection.

Connection pooling can greatly increase the performance of your Java application, while reducing overall resource usage. The main benefits to connection pooling are:

- Reduced connection creation time

Although this is not usually an issue with the quick connection setup that MySQL offers compared to other databases, creating new JDBC connections still incurs networking and JDBC driver overhead that will be avoided if connections are recycled.

- Simplified programming model

When using connection pooling, each individual thread can act as though it has created its own JDBC connection, allowing you to use straight-forward JDBC programming techniques.

- Controlled resource usage

If you do not use connection pooling, and instead create a new connection every time a thread needs one, your application's resource usage can be quite wasteful and lead to unpredictable behavior under load.

Remember that each connection to MySQL has overhead (memory, CPU, context switches, and so forth) on both the client and server side. Every connection limits how many resources there are available to your application as well as the MySQL server. Many of these resources will be used whether or not the connection is actually doing any useful work!

Connection pools can be tuned to maximize performance, while keeping resource utilization below the point where your application will start to fail rather than just run slower.

Luckily, Sun has standardized the concept of connection pooling in JDBC through the JDBC-2.0 Optional interfaces, and all major application servers have implementations of these APIs that work fine with MySQL Connector/J.

Generally, you configure a connection pool in your application server configuration files, and access it via the Java Naming and Directory Interface (JNDI). The following code shows how you might use a connection pool from an application deployed in a J2EE application server:

### Example 20.11. Connector/J: Using a connection pool with a J2EE application server

```
import java.sql.Connection;
import java.sql.SQLException;
import java.sql.Statement;

import javax.naming.InitialContext;
import javax.sql.DataSource;

public class MyServletJspOrEjb {

    public void doSomething() throws Exception {
        /*
         * Create a JNDI Initial context to be able to
         * lookup the DataSource
         *
         * In production-level code, this should be cached as
         * an instance or static variable, as it can
         * be quite expensive to create a JNDI context.
         *
         * Note: This code only works when you are using servlets
         * or EJBs in a J2EE application server. If you are
         * using connection pooling in standalone Java code, you
         * will have to create/configure datasources using whatever
         * mechanisms your particular connection pooling library
         * provides.
         */

        InitialContext ctx = new InitialContext();

        /*
         * Lookup the DataSource, which will be backed by a pool
         * that the application server provides. DataSource instances
         * are also a good candidate for caching as an instance
         * variable, as JNDI lookups can be expensive as well.
         */

        DataSource ds =
            (DataSource)ctx.lookup("java:comp/env/jdbc/MySQLDB");

        /*
         * The following code is what would actually be in your
         * Servlet, JSP or EJB 'service' method...where you need
         * to work with a JDBC connection.
         */

        Connection conn = null;
        Statement stmt = null;

        try {
            conn = ds.getConnection();

            /*
             * Now, use normal JDBC programming to work with
             * MySQL, making sure to close each resource when you're
             * finished with it, which allows the connection pool
             * resources to be recovered as quickly as possible
             */

            stmt = conn.createStatement();
            stmt.execute("SOME SQL QUERY");

            stmt.close();
            stmt = null;

            conn.close();
            conn = null;
        }
    }
}
```

```

    } finally {
        /*
         * close any jdbc instances here that weren't
         * explicitly closed during normal code path, so
         * that we don't 'leak' resources...
         */

        if (stmt != null) {
            try {
                stmt.close();
            } catch (SQLException sqlex) {
                // ignore -- as we can't do anything about it here
            }

            stmt = null;
        }

        if (conn != null) {
            try {
                conn.close();
            } catch (SQLException sqlex) {
                // ignore -- as we can't do anything about it here
            }

            conn = null;
        }
    }
}

```

As shown in the example above, after obtaining the JNDI InitialContext, and looking up the DataSource, the rest of the code should look familiar to anyone who has done JDBC programming in the past.

The most important thing to remember when using connection pooling is to make sure that no matter what happens in your code (exceptions, flow-of-control, and so forth), connections, and anything created by them (such as statements or result sets) are closed, so that they may be re-used, otherwise they will be stranded, which in the best case means that the MySQL server resources they represent (such as buffers, locks, or sockets) may be tied up for some time, or worst case, may be tied up forever.

#### What Is the Best Size for my Connection Pool?

As with all other configuration rules-of-thumb, the answer is: it depends. Although the optimal size depends on anticipated load and average database transaction time, the optimum connection pool size is smaller than you might expect. If you take Sun's Java Petstore blueprint application for example, a connection pool of 15-20 connections can serve a relatively moderate load (600 concurrent users) using MySQL and Tomcat with response times that are acceptable.

To correctly size a connection pool for your application, you should create load test scripts with tools such as Apache JMeter or The Grinder, and load test your application.

An easy way to determine a starting point is to configure your connection pool's maximum number of connections to be unbounded, run a load test, and measure the largest amount of concurrently used connections. You can then work backward from there to determine what values of minimum and maximum pooled connections give the best performance for your particular application.

### 20.4.5.2.2. Using Connector/J with Tomcat

The following instructions are based on the instructions for Tomcat-5.x, available at <http://tomcat.apache.org/tomcat-5.5-doc/jndi-datasource-examples-howto.html> which is current at the time this document was written.

First, install the .jar file that comes with Connector/J in `$(CATALINA_HOME)/common/lib` so that it is available to all applications installed in the container.

Next, Configure the JNDI DataSource by adding a declaration resource to `$(CATALINA_HOME)/conf/server.xml` in the context that defines your web application:

```

<Context ...>
    ...
    <Resource name="jdbc/MySQLDB"
              auth="Container"
              type="javax.sql.DataSource"/>

    <!-- The name you used above, must match _exactly_ here!

         The connection pool will be bound into JNDI with the name
         "java:/comp/env/jdbc/MySQLDB"
    -->

    <ResourceParams name="jdbc/MySQLDB">
        <parameter>
            <name>factory</name>
            <value>org.apache.commons.dbcp.BasicDataSourceFactory</value>
        </parameter>
    </ResourceParams>

```



```

<!-- Don't set this any higher than max_connections on your
MySQL server, usually this should be a 10 or a few 10's
of connections, not hundreds or thousands -->

<parameter>
  <name>maxActive</name>
  <value>10</value>
</parameter>

<!-- You don't want too many idle connections hanging around
if you can avoid it, only enough to soak up a spike in
the load -->

<parameter>
  <name>maxIdle</name>
  <value>5</value>
</parameter>

<!-- Don't use autoReconnect=true, it's going away eventually
and it's a crutch for older connection pools that couldn't
test connections. You need to decide whether your application
is supposed to deal with SQLExceptions (hint, it should), and
how much of a performance penalty you're willing to pay
to ensure 'freshness' of the connection -->

<parameter>
  <name>validationQuery</name>
  <value>SELECT 1</value>
</parameter>

<!-- The most conservative approach is to test connections
before they're given to your application. For most applications
this is okay, the query used above is very small and takes
no real server resources to process, other than the time used
to traverse the network.

If you have a high-load application you'll need to rely on
something else. -->

<parameter>
  <name>testOnBorrow</name>
  <value>true</value>
</parameter>

<!-- Otherwise, or in addition to testOnBorrow, you can test
while connections are sitting idle -->

<parameter>
  <name>testWhileIdle</name>
  <value>true</value>
</parameter>

<!-- You have to set this value, otherwise even though
you've asked connections to be tested while idle,
the idle evictor thread will never run -->

<parameter>
  <name>timeBetweenEvictionRunsMillis</name>
  <value>10000</value>
</parameter>

<!-- Don't allow connections to hang out idle too long,
never longer than what wait_timeout is set to on the
server...A few minutes or even fraction of a minute
is sometimes okay here, it depends on your application
and how much spikey load it will see -->

<parameter>
  <name>minEvictableIdleTimeMillis</name>
  <value>60000</value>
</parameter>

<!-- Username and password used when connecting to MySQL -->

<parameter>
  <name>username</name>
  <value>someuser</value>
</parameter>

<parameter>
  <name>password</name>
  <value>somepass</value>
</parameter>

<!-- Class name for the Connector/J driver -->

<parameter>
  <name>driverClassName</name>
  <value>com.mysql.jdbc.Driver</value>
</parameter>

<!-- The JDBC connection url for connecting to MySQL, notice
that if you want to pass any other MySQL-specific parameters
you should pass them here in the URL, setting them using the
parameter tags above will have no effect, you will also
need to use &amp; to separate parameter values as the

```

```

    ampersand is a reserved character in XML -->
    <parameter>
      <name>url</name>
      <value>jdbc:mysql://localhost:3306/test</value>
    </parameter>
  </ResourceParams>
</Context>

```

In general, you should follow the installation instructions that come with your version of Tomcat, as the way you configure data-sources in Tomcat changes from time-to-time, and unfortunately if you use the wrong syntax in your XML file, you will most likely end up with an exception similar to the following:

```

Error: java.sql.SQLException: Cannot load JDBC driver class 'null ' SQL
state: null

```

### 20.4.5.2.3. Using Connector/J with JBoss

These instructions cover JBoss-4.x. To make the JDBC driver classes available to the application server, copy the .jar file that comes with Connector/J to the `lib` directory for your server configuration (which is usually called `default`). Then, in the same configuration directory, in the subdirectory named `deploy`, create a datasource configuration file that ends with "-ds.xml", which tells JBoss to deploy this file as a JDBC Datasource. The file should have the following contents:

```

<datasources>
  <local-tx-datasource>
    <!-- This connection pool will be bound into JNDI with the name
         "java/MySQLDB" -->
    <jndi-name>MySQLDB</jndi-name>
    <connection-url>jdbc:mysql://localhost:3306/dbname</connection-url>
    <driver-class>com.mysql.jdbc.Driver</driver-class>
    <user-name>user</user-name>
    <password>pass</password>

    <min-pool-size>5</min-pool-size>

    <!-- Don't set this any higher than max_connections on your
         MySQL server, usually this should be a 10 or a few 10's
         of connections, not hundreds or thousands -->
    <max-pool-size>20</max-pool-size>

    <!-- Don't allow connections to hang out idle too long,
         never longer than what wait_timeout is set to on the
         server...A few minutes is usually okay here,
         it depends on your application
         and how much spikey load it will see -->
    <idle-timeout-minutes>5</idle-timeout-minutes>

    <!-- If you're using Connector/J 3.1.8 or newer, you can use
         our implementation of these to increase the robustness
         of the connection pool. -->
    <exception-sorter-class-name>
      com.mysql.jdbc.integration.jboss.ExtendedMysqlExceptionSorter
    </exception-sorter-class-name>
    <valid-connection-checker-class-name>
      com.mysql.jdbc.integration.jboss.MysqlValidConnectionChecker
    </valid-connection-checker-class-name>

  </local-tx-datasource>
</datasources>

```

### 20.4.5.2.4. Using Connector/J with Spring

The Spring Framework is a Java-based application framework designed for assisting in application design by providing a way to configure components. The technique used by Spring is a well known design pattern called Dependency Injection (see [Inversion of Control Containers and the Dependency Injection pattern](#)). This article will focus on Java-oriented access to MySQL databases with Spring 2.0. For those wondering, there is a .NET port of Spring appropriately named Spring.NET.

Spring is not only a system for configuring components, but also includes support for aspect oriented programming (AOP). This is one of the main benefits and the foundation for Spring's resource and transaction management. Spring also provides utilities for integrating resource management with JDBC and Hibernate.

For the examples in this section the MySQL world sample database will be used. The first task is to set up a MySQL data source through Spring. Components within Spring use the "bean" terminology. For example, to configure a connection to a MySQL server supporting the world sample database you might use:

```

<util:map id="dbProps">
  <entry key="db.driver" value="com.mysql.jdbc.Driver"/>
  <entry key="db.jdbcurl" value="jdbc:mysql://localhost/world"/>

```

```
<entry key="db.username" value="myuser" />
<entry key="db.password" value="mypass" />
</util:map>
```

In the above example we are assigning values to properties that will be used in the configuration. For the datasource configuration:

```
<bean id="dataSource"
      class="org.springframework.jdbc.datasource.DriverManagerDataSource">
  <property name="driverClassName" value="${db.driver}" />
  <property name="url" value="${db.jdbcurl}" />
  <property name="username" value="${db.username}" />
  <property name="password" value="${db.password}" />
</bean>
```

The placeholders are used to provide values for properties of this bean. This means that you can specify all the properties of the configuration in one place instead of entering the values for each property on each bean. We do, however, need one more bean to pull this all together. The last bean is responsible for actually replacing the placeholders with the property values.

```
<bean
  class="org.springframework.beans.factory.config.PropertyPlaceholderConfigurer">
  <property name="properties" ref="dbProps" />
</bean>
```

Now that we have our MySQL data source configured and ready to go, we write some Java code to access it. The example below will retrieve three random cities and their corresponding country using the data source we configured with Spring.

```
// Create a new application context. this processes the Spring config
ApplicationContext ctx =
  new ClassPathXmlApplicationContext("exlappContext.xml");
// Retrieve the data source from the application context
DataSource ds = (DataSource) ctx.getBean("dataSource");
// Open a database connection using Spring's DataSourceUtils
Connection c = DataSourceUtils.getConnection(ds);
try {
  // retrieve a list of three random cities
  PreparedStatement ps = c.prepareStatement(
    "select City.Name as 'City', Country.Name as 'Country' " +
    "from City inner join Country on City.CountryCode = Country.Code " +
    "order by rand() limit 3");
  ResultSet rs = ps.executeQuery();
  while(rs.next()) {
    String city = rs.getString("City");
    String country = rs.getString("Country");
    System.out.printf("The city %s is in %s\n", city, country);
  }
} catch (SQLException ex) {
  // something has failed and we print a stack trace to analyse the error
  ex.printStackTrace();
  // ignore failure closing connection
  try { c.close(); } catch (SQLException e) { }
} finally {
  // properly release our connection
  DataSourceUtils.releaseConnection(c, ds);
}
```

This is very similar to normal JDBC access to MySQL with the main difference being that we are using `DataSourceUtils` instead of the `DriverManager` to create the connection.

While it may seem like a small difference, the implications are somewhat far reaching. Spring manages this resource in a way similar to a container managed data source in a J2EE application server. When a connection is opened, it can be subsequently accessed in other parts of the code if it is synchronized with a transaction. This makes it possible to treat different parts of your application as transactional instead of passing around a database connection.

#### 20.4.5.2.4.1. Using `JdbcTemplate`

Spring makes extensive use of the Template method design pattern (see [Template Method Pattern](#)). Our immediate focus will be on the `JdbcTemplate` and related classes, specifically `NamedParameterJdbcTemplate`. The template classes handle obtaining and releasing a connection for data access when one is needed.

The next example shows how to use `NamedParameterJdbcTemplate` inside of a DAO (Data Access Object) class to retrieve a random city given a country code.

```
public class Ex2JdbcDao {
  /**
   * Data source reference which will be provided by Spring.
   */
  private DataSource dataSource;
```

```

/**
 * Our query to find a random city given a country code. Notice
 * the ":country" parameter towards the end. This is called a
 * named parameter.
 */
private String queryString = "select Name from City " +
    "where CountryCode = :country order by rand() limit 1";

/**
 * Retrieve a random city using Spring JDBC access classes.
 */
public String getRandomCityByCountryCode(String cntryCode) {
    // A template that allows using queries with named parameters
    NamedParameterJdbcTemplate template =
        new NamedParameterJdbcTemplate(dataSource);
    // A java.util.Map is used to provide values for the parameters
    Map params = new HashMap();
    params.put("country", cntryCode);
    // We query for an Object and specify what class we are expecting
    return (String)template.queryForObject(queryString, params, String.class);
}

/**
 * A JavaBean setter-style method to allow Spring to inject the data source.
 * @param dataSource
 */
public void setDataSource(DataSource dataSource) {
    this.dataSource = dataSource;
}
}

```

The focus in the above code is on the `getRandomCityByCountryCode()` method. We pass a country code and use the `NamedParameterJdbcTemplate` to query for a city. The country code is placed in a Map with the key "country", which is the parameter is named in the SQL query.

To access this code, you need to configure it with Spring by providing a reference to the data source.

```

<bean id="dao" class="code.Ex2JdbcDao">
  <property name="dataSource" ref="dataSource"/>
</bean>

```

At this point, we can just grab a reference to the DAO from Spring and call `getRandomCityByCountryCode()`.

```

// Create the application context
ApplicationContext ctx =
    new ClassPathXmlApplicationContext("ex2appContext.xml");
// Obtain a reference to our DAO
Ex2JdbcDao dao = (Ex2JdbcDao) ctx.getBean("dao");

String countryCode = "USA";

// Find a few random cities in the US
for(int i = 0; i < 4; ++i)
    System.out.printf("A random city in %s is %s%n", countryCode,
        dao.getRandomCityByCountryCode(countryCode));

```

This example shows how to use Spring's JDBC classes to completely abstract away the use of traditional JDBC classes including `Connection` and `PreparedStatement`.

#### 20.4.5.2.4.2. Transactional JDBC Access

You might be wondering how we can add transactions into our code if we do not deal directly with the JDBC classes. Spring provides a transaction management package that not only replaces JDBC transaction management, but also allows declarative transaction management (configuration instead of code).

In order to use transactional database access, we will need to change the storage engine of the tables in the world database. The downloaded script explicitly creates MyISAM tables which do not support transactional semantics. The InnoDB storage engine does support transactions and this is what we will be using. We can change the storage engine with the following statements.

```

ALTER TABLE City ENGINE=InnoDB;
ALTER TABLE Country ENGINE=InnoDB;
ALTER TABLE CountryLanguage ENGINE=InnoDB;

```

A good programming practice emphasized by Spring is separating interfaces and implementations. What this means is that we can create a Java interface and only use the operations on this interface without any internal knowledge of what the actual implementation is. We will let Spring manage the implementation and with this it will manage the transactions for our implementation.

First you create a simple interface:

```

public interface Ex3Dao {
    Integer createCity(String name, String countryCode,

```

```
String district, Integer population);
}
```

This interface contains one method that will create a new city record in the database and return the id of the new record. Next you need to create an implementation of this interface.

```
public class Ex3DaoImpl implements Ex3Dao {
    protected DataSource dataSource;
    protected SqlUpdate updateQuery;
    protected SqlFunction idQuery;

    public Integer createCity(String name, String countryCode,
        String district, Integer population) {
        updateQuery.update(new Object[] { name, countryCode,
            district, population });
        return getLastId();
    }

    protected Integer getLastId() {
        return idQuery.run();
    }
}
```

You can see that we only operate on abstract query objects here and do not deal directly with the JDBC API. Also, this is the complete implementation. All of our transaction management will be dealt with in the configuration. To get the configuration started, we need to create the DAO.

```
<bean id="dao" class="code.Ex3DaoImpl">
    <property name="dataSource" ref="dataSource"/>
    <property name="updateQuery">...</property>
    <property name="idQuery">...</property>
</bean>
```

Now you need to set up the transaction configuration. The first thing you must do is create transaction manager to manage the data source and a specification of what transaction properties are required for the `dao` methods.

```
<bean id="transactionManager"
    class="org.springframework.jdbc.datasource.DataSourceTransactionManager">
    <property name="dataSource" ref="dataSource"/>
</bean>

<tx:advice id="txAdvice" transaction-manager="transactionManager">
    <tx:attributes>
        <tx:method name="*" />
    </tx:attributes>
</tx:advice>
```

The preceding code creates a transaction manager that handles transactions for the data source provided to it. The `txAdvice` uses this transaction manager and the attributes specify to create a transaction for all methods. Finally you need to apply this advice with an AOP pointcut.

```
<aop:config>
    <aop:pointcut id="daoMethods"
        expression="execution(* code.Ex3Dao.*(..))"/>
    <aop:advisor advice-ref="txAdvice" pointcut-ref="daoMethods"/>
</aop:config>
```

This basically says that all methods called on the `Ex3Dao` interface will be wrapped in a transaction. To make use of this, you only have to retrieve the `dao` from the application context and call a method on the `dao` instance.

```
Ex3Dao dao = (Ex3Dao) ctx.getBean("dao");
Integer id = dao.createCity(name, countryCode, district, pop);
```

We can verify from this that there is no transaction management happening in our Java code and it is all configured with Spring. This is a very powerful notion and regarded as one of the most beneficial features of Spring.

#### 20.4.5.2.4.3. Connection Pooling

In many situations, such as web applications, there will be a large number of small database transactions. When this is the case, it usually makes sense to create a pool of database connections available for web requests as needed. Although MySQL does not spawn an extra process when a connection is made, there is still a small amount of overhead to create and set up the connection. Pooling of connections also alleviates problems such as collecting large amounts of sockets in the `TIME_WAIT` state.

Setting up pooling of MySQL connections with Spring is as simple as changing the data source configuration in the application context. There are a number of configurations that we can use. The first example is based on the [Jakarta Commons DBCP library](#). The example below replaces the source configuration that was based on `DriverManagerDataSource` with DBCP's `BasicDataSource`.

```
<bean id="dataSource" destroy-method="close"
  class="org.apache.commons.dbcp.BasicDataSource">
  <property name="driverClassName" value="{db.driver}"/>
  <property name="url" value="{db.jdbcurl}"/>
  <property name="username" value="{db.username}"/>
  <property name="password" value="{db.password}"/>
  <property name="initialSize" value="3"/>
</bean>
```

The configuration of the two solutions is very similar. The difference is that DBCP will pool connections to the database instead of creating a new connection every time one is requested. We have also set a parameter here called `initialSize`. This tells DBCP that we want three connections in the pool when it is created.

Another way to configure connection pooling is to configure a data source in our J2EE application server. Using JBoss as an example, you can set up the MySQL connection pool by creating a file called `mysql-local-ds.xml` and placing it in the server/default/deploy directory in JBoss. Once we have this setup, we can use JNDI to look it up. With Spring, this lookup is very simple. The data source configuration looks like this.

```
<jee:jndi-lookup id="dataSource" jndi-name="java:MySQL_DS"/>
```

### 20.4.5.2.5. Using Connector/J with GlassFish

## 20.4.5.3. Common Problems and Solutions

There are a few issues that seem to be commonly encountered often by users of MySQL Connector/J. This section deals with their symptoms, and their resolutions.

### Questions

- [20.4.5.3.1](#): When I try to connect to the database with MySQL Connector/J, I get the following exception:

```
SQLException: Server configuration denies access to data source
SQLState: 08001
VendorError: 0
```

What is going on? I can connect just fine with the MySQL command-line client.

- [20.4.5.3.2](#): My application throws an SQLException 'No Suitable Driver'. Why is this happening?
- [20.4.5.3.3](#): I'm trying to use MySQL Connector/J in an applet or application and I get an exception similar to:

```
SQLException: Cannot connect to MySQL server on host:3306.
Is there a MySQL server running on the machine/port you
are trying to connect to?

(java.security.AccessControlException)
SQLState: 08S01
VendorError: 0
```

- [20.4.5.3.4](#): I have a servlet/application that works fine for a day, and then stops working overnight
- [20.4.5.3.5](#): I'm trying to use JDBC-2.0 updatable result sets, and I get an exception saying my result set is not updatable.
- [20.4.5.3.6](#): I cannot connect to the MySQL server using Connector/J, and I'm sure the connection parameters are correct.
- [20.4.5.3.7](#): I am trying to connect to my MySQL server within my application, but I get the following error and stack trace:

```
java.net.SocketException
MESSAGE: Software caused connection abort: recv failed

STACKTRACE:

java.net.SocketException: Software caused connection abort: recv failed
at java.net.SocketInputStream.socketRead0(Native Method)
at java.net.SocketInputStream.read(Unknown Source)
at com.mysql.jdbc.MysqlIO.readFully(MysqlIO.java:1392)
at com.mysql.jdbc.MysqlIO.readPacket(MysqlIO.java:1414)
at com.mysql.jdbc.MysqlIO.doHandshake(MysqlIO.java:625)
at com.mysql.jdbc.Connection.createNewIO(Connection.java:1926)
at com.mysql.jdbc.Connection.<init>(Connection.java:452)
at com.mysql.jdbc.NonRegisteringDriver.connect(NonRegisteringDriver.java:411)
```

- [20.4.5.3.8](#): My application is deployed through JBoss and I am using transactions to handle the statements on the MySQL database. Under heavy loads I am getting an error and stack trace, but these only occur after a fixed period of heavy activity.

- [20.4.5.3.9](#): When using `gcj` an `java.io.CharConversionException` is raised when working with certain character sequences.
- [20.4.5.3.10](#): Updating a table that contains a primary key that is either `FLOAT` or compound primary key that uses `FLOAT` fails to update the table and raises an exception.
- [20.4.5.3.11](#): You get an `ER_NET_PACKET_TOO_LARGE` exception, even though the binary blob size you want to insert via JDBC is safely below the `max_allowed_packet` size.

## Questions and Answers

### 20.4.5.3.1: When I try to connect to the database with MySQL Connector/J, I get the following exception:

```
SQLException: Server configuration denies access to data source
SQLState: 08001
VendorError: 0
```

#### What is going on? I can connect just fine with the MySQL command-line client.

MySQL Connector/J must use TCP/IP sockets to connect to MySQL, as Java does not support Unix Domain Sockets. Therefore, when MySQL Connector/J connects to MySQL, the security manager in MySQL server will use its grant tables to determine whether the connection should be allowed.

You must add the necessary security credentials to the MySQL server for this to happen, using the `GRANT` statement to your MySQL Server. See [Section 12.5.1.3, “GRANT Syntax”](#), for more information.

#### Note

Testing your connectivity with the `mysql` command-line client will not work unless you add the `--host` flag, and use something other than `localhost` for the host. The `mysql` command-line client will use Unix domain sockets if you use the special host name `localhost`. If you are testing connectivity to `localhost`, use `127.0.0.1` as the host name instead.

#### Warning

Changing privileges and permissions improperly in MySQL can potentially cause your server installation to not have optimal security properties.

### 20.4.5.3.2: My application throws an SQLException 'No Suitable Driver'. Why is this happening?

There are three possible causes for this error:

- The Connector/J driver is not in your `CLASSPATH`, see [Section 20.4.2, “Connector/J Installation”](#).
- The format of your connection URL is incorrect, or you are referencing the wrong JDBC driver.
- When using `DriverManager`, the `jdbc.drivers` system property has not been populated with the location of the Connector/J driver.

### 20.4.5.3.3: I'm trying to use MySQL Connector/J in an applet or application and I get an exception similar to:

```
SQLException: Cannot connect to MySQL server on host:3306.
Is there a MySQL server running on the machine/port you
are trying to connect to?

(java.security.AccessControlException)
SQLState: 08S01
VendorError: 0
```

Either you're running an Applet, your MySQL server has been installed with the `--skip-networking` option set, or your MySQL server has a firewall sitting in front of it.

Applets can only make network connections back to the machine that runs the web server that served the `.class` files for the applet. This means that MySQL must run on the same machine (or you must have some sort of port re-direction) for this to work. This also means that you will not be able to test applets from your local file system, you must always deploy them to a web server.

MySQL Connector/J can only communicate with MySQL using TCP/IP, as Java does not support Unix domain sockets. TCP/IP communication with MySQL might be affected if MySQL was started with the `--skip-networking` flag, or if it is firewalled.

If MySQL has been started with the `--skip-networking` option set (the Debian Linux package of MySQL server does this for ex-

ample), you need to comment it out in the file `/etc/mysql/my.cnf` or `/etc/my.cnf`. Of course your `my.cnf` file might also exist in the `data` directory of your MySQL server, or anywhere else (depending on how MySQL was compiled for your system). Binaries created by us always look in `/etc/my.cnf` and `[datadir]/my.cnf`. If your MySQL server has been firewalled, you will need to have the firewall configured to allow TCP/IP connections from the host where your Java code is running to the MySQL server on the port that MySQL is listening to (by default, 3306).

#### 20.4.5.3.4: I have a servlet/application that works fine for a day, and then stops working overnight

MySQL closes connections after 8 hours of inactivity. You either need to use a connection pool that handles stale connections or use the `"autoReconnect"` parameter (see [Section 20.4.4.1, "Driver/Datasource Class Names, URL Syntax and Configuration Properties for Connector/J"](#)).

Also, you should be catching `SQLExceptions` in your application and dealing with them, rather than propagating them all the way until your application exits, this is just good programming practice. MySQL Connector/J will set the `SQLState` (see [`java.sql.SQLException.getSQLState\(\)`](#) in your APIDocs) to `"08S01"` when it encounters network-connectivity issues during the processing of a query. Your application code should then attempt to re-connect to MySQL at this point.

The following (simplistic) example shows what code that can handle these exceptions might look like:

#### Example 20.12. Connector/J: Example of transaction with retry logic

```
public void doBusinessOp() throws SQLException {
    Connection conn = null;
    Statement stmt = null;
    ResultSet rs = null;

    //
    // How many times do you want to retry the transaction
    // (or at least _getting_ a connection)?
    //
    int retryCount = 5;

    boolean transactionCompleted = false;

    do {
        try {
            conn = getConnection(); // assume getting this from a
                                   // javax.sql.DataSource, or the
                                   // java.sql.DriverManager

            conn.setAutoCommit(false);

            //
            // Okay, at this point, the 'retry-ability' of the
            // transaction really depends on your application logic,
            // whether or not you're using autocommit (in this case
            // not), and whether you're using transaccational storage
            // engines
            //
            // For this example, we'll assume that it's _not_ safe
            // to retry the entire transaction, so we set retry
            // count to 0 at this point
            //
            // If you were using exclusively transaction-safe tables,
            // or your application could recover from a connection going
            // bad in the middle of an operation, then you would not
            // touch 'retryCount' here, and just let the loop repeat
            // until retryCount == 0.
            //
            retryCount = 0;

            stmt = conn.createStatement();

            String query = "SELECT foo FROM bar ORDER BY baz";

            rs = stmt.executeQuery(query);

            while (rs.next()) {
            }

            rs.close();
            rs = null;

            stmt.close();
            stmt = null;

            conn.commit();
            conn.close();
            conn = null;

            transactionCompleted = true;
        } catch (SQLException sqlEx) {

            //
            // The two SQL states that are 'retry-able' are 08S01
            // for a communications error, and 40001 for deadlock.

```



```

//
// Only retry if the error was due to a stale connection,
// communications problem or deadlock
//

String sqlState = sqlEx.getSQLState();

if ("08S01".equals(sqlState) || "40001".equals(sqlState)) {
    retryCount--;
} else {
    retryCount = 0;
}
} finally {
    if (rs != null) {
        try {
            rs.close();
        } catch (SQLException sqlEx) {
            // You'd probably want to log this . . .
        }
    }

    if (stmt != null) {
        try {
            stmt.close();
        } catch (SQLException sqlEx) {
            // You'd probably want to log this as well . . .
        }
    }

    if (conn != null) {
        try {
            //
            // If we got here, and conn is not null, the
            // transaction should be rolled back, as not
            // all work has been done

            try {
                conn.rollback();
            } finally {
                conn.close();
            }
        } catch (SQLException sqlEx) {
            //
            // If we got an exception here, something
            // pretty serious is going on, so we better
            // pass it up the stack, rather than just
            // logging it. . .
            throw sqlEx;
        }
    }
}
} while (!transactionCompleted && (retryCount > 0));
}

```

### Note

Use of the `autoReconnect` option is not recommended because there is no safe method of reconnecting to the MySQL server without risking some corruption of the connection state or database state information. Instead, you should use a connection pool which will enable your application to connect to the MySQL server using an available connection from the pool. The `autoReconnect` facility is deprecated, and may be removed in a future release.

#### 20.4.5.3.5: I'm trying to use JDBC-2.0 updatable result sets, and I get an exception saying my result set is not updatable.

Because MySQL does not have row identifiers, MySQL Connector/J can only update result sets that have come from queries on tables that have at least one primary key, the query must select every primary key and the query can only span one table (that is, no joins). This is outlined in the JDBC specification.

Note that this issue only occurs when using updatable result sets, and is caused because Connector/J is unable to guarantee that it can identify the correct rows within the result set to be updated without having a unique reference to each row. There is no requirement to have a unique field on a table if you are using `UPDATE` or `DELETE` statements on a table where you can individually specify the criteria to be matched using a `WHERE` clause.

#### 20.4.5.3.6: I cannot connect to the MySQL server using Connector/J, and I'm sure the connection parameters are correct.

Make sure that the `skip-networking` option has not been enabled on your server. Connector/J must be able to communicate with your server over TCP/IP, named sockets are not supported. Also ensure that you are not filtering connections through a Firewall or other network security system. For more information, see [Section B.1.2.2, "Can't connect to \[local\] MySQL server"](#).

#### 20.4.5.3.7: I am trying to connect to my MySQL server within my application, but I get the following error and stack trace:

```

java.net.SocketException
MESSAGE: Software caused connection abort: recv failed

```

## STACKTRACE:

```

java.net.SocketException: Software caused connection abort: recv failed
at java.net.SocketInputStream.socketRead0(Native Method)
at java.net.SocketInputStream.read(Unknown Source)
at com.mysql.jdbc.MysqlIO.readFully(MysqlIO.java:1392)
at com.mysql.jdbc.MysqlIO.readPacket(MysqlIO.java:1414)
at com.mysql.jdbc.MysqlIO.doHandshake(MysqlIO.java:625)
at com.mysql.jdbc.Connection.createNewIO(Connection.java:1926)
at com.mysql.jdbc.Connection.<init>(Connection.java:452)
at com.mysql.jdbc.NonRegisteringDriver.connect(NonRegisteringDriver.java:411)

```

The error probably indicates that you are using an older version of the Connector/J JDBC driver (2.0.14 or 3.0.x) and you are trying to connect to a MySQL server with version 4.1x or newer. The older drivers are not compatible with 4.1 or newer of MySQL as they do not support the newer authentication mechanisms.

It is likely that the older version of the Connector/J driver exists within your application directory or your `CLASSPATH` includes the older Connector/J package.

#### 20.4.5.3.8: My application is deployed through JBoss and I am using transactions to handle the statements on the MySQL database. Under heavy loads I am getting an error and stack trace, but these only occur after a fixed period of heavy activity.

This is a JBoss, not Connector/J, issue and is connected to the use of transactions. Under heavy loads the time taken for transactions to complete can increase, and the error is caused because you have exceeded the predefined timeout.

You can increase the timeout value by setting the `TransactionTimeout` attribute to the `TransactionManagerService` within the `/conf/jboss-service.xml` file (pre-4.0.3) or `/deploy/jta-service.xml` for JBoss 4.0.3 or later. See `TransactionTimeout` within the JBoss wiki for more information.

#### 20.4.5.3.9: When using gcj an java.io.CharConversionException is raised when working with certain character sequences.

This is a known issue with `gcj` which raises an exception when it reaches an unknown character or one it cannot convert. You should add `useJvmCharsetConverters=true` to your connection string to force character conversion outside of the `gcj` libraries, or try a different JDK.

#### 20.4.5.3.10: Updating a table that contains a primary key that is either FLOAT or compound primary key that uses FLOAT fails to update the table and raises an exception.

Connector/J adds conditions to the `WHERE` clause during an `UPDATE` to check the old values of the primary key. If there is no match then Connector/J considers this a failure condition and raises an exception.

The problem is that rounding differences between supplied values and the values stored in the database may mean that the values never match, and hence the update fails. The issue will affect all queries, not just those from Connector/J.

To prevent this issue, use a primary key that does not use `FLOAT`. If you have to use a floating point column in your primary key use `DOUBLE` or `DECIMAL` types in place of `FLOAT`.

#### 20.4.5.3.11: You get an ER\_NET\_PACKET\_TOO\_LARGE exception, even though the binary blob size you want to insert via JDBC is safely below the max\_allowed\_packet size.

This is because the `hexEscapeBlock()` method in `com.mysql.jdbc.PreparedStatement.streamToBytes()` may almost double the size of your data.

## 20.4.6. Connector/J Support

### 20.4.6.1. Connector/J Community Support

Sun Microsystems, Inc. provides assistance to the user community by means of its mailing lists. For Connector/J related issues, you can get help from experienced users by using the MySQL and Java mailing list. Archives and subscription information is available online at <http://lists.mysql.com/java>.

For information about subscribing to MySQL mailing lists or to browse list archives, visit <http://lists.mysql.com/>. See [Section 1.5.1, “MySQL Mailing Lists”](#).

Community support from experienced users is also available through the [JDBC Forum](#). You may also find help from other users in the other MySQL Forums, located at <http://forums.mysql.com>. See [Section 1.5.2, “MySQL Community Support at the MySQL Forums”](#).

### 20.4.6.2. How to Report Connector/J Bugs or Problems

The normal place to report bugs is <http://bugs.mysql.com/>, which is the address for our bugs database. This database is public, and can be browsed and searched by anyone. If you log in to the system, you will also be able to enter new reports.

If you have found a sensitive security bug in MySQL, you can send email to [<security@mysql.com>](mailto:security@mysql.com).

Writing a good bug report takes patience, but doing it right the first time saves time both for us and for yourself. A good bug report, containing a full test case for the bug, makes it very likely that we will fix the bug in the next release.

This section will help you write your report correctly so that you do not waste your time doing things that may not help us much or at all.

If you have a repeatable bug report, please report it to the bugs database at <http://bugs.mysql.com/>. Any bug that we are able to repeat has a high chance of being fixed in the next MySQL release.

To report other problems, you can use one of the MySQL mailing lists.

Remember that it is possible for us to respond to a message containing too much information, but not to one containing too little. People often omit facts because they think they know the cause of a problem and assume that some details do not matter.

A good principle is this: If you are in doubt about stating something, state it. It is faster and less troublesome to write a couple more lines in your report than to wait longer for the answer if we must ask you to provide information that was missing from the initial report.

The most common errors made in bug reports are (a) not including the version number of Connector/J or MySQL used, and (b) not fully describing the platform on which Connector/J is installed (including the JVM version, and the platform type and version number that MySQL itself is installed on).

This is highly relevant information, and in 99 cases out of 100, the bug report is useless without it. Very often we get questions like, "Why doesn't this work for me?" Then we find that the feature requested wasn't implemented in that MySQL version, or that a bug described in a report has already been fixed in newer MySQL versions.

Sometimes the error is platform-dependent; in such cases, it is next to impossible for us to fix anything without knowing the operating system and the version number of the platform.

If at all possible, you should create a repeatable, standalone testcase that doesn't involve any third-party classes.

To streamline this process, we ship a base class for testcases with Connector/J, named `'com.mysql.jdbc.util.BaseBugReport'`. To create a testcase for Connector/J using this class, create your own class that inherits from `com.mysql.jdbc.util.BaseBugReport` and override the methods `setUp()`, `tearDown()` and `runTest()`.

In the `setUp()` method, create code that creates your tables, and populates them with any data needed to demonstrate the bug.

In the `runTest()` method, create code that demonstrates the bug using the tables and data you created in the `setUp` method.

In the `tearDown()` method, drop any tables you created in the `setUp()` method.

In any of the above three methods, you should use one of the variants of the `getConnection()` method to create a JDBC connection to MySQL:

- `getConnection()` - Provides a connection to the JDBC URL specified in `getUrl()`. If a connection already exists, that connection is returned, otherwise a new connection is created.
- `getNewConnection()` - Use this if you need to get a new connection for your bug report (that is, there is more than one connection involved).
- `getConnection(String url)` - Returns a connection using the given URL.
- `getConnection(String url, Properties props)` - Returns a connection using the given URL and properties.

If you need to use a JDBC URL that is different from `'jdbc:mysql:///test'`, override the method `getUrl()` as well.

Use the `assertTrue(boolean expression)` and `assertTrue(String failureMessage, boolean expression)` methods to create conditions that must be met in your testcase demonstrating the behavior you are expecting (vs. the behavior you are observing, which is why you are most likely filing a bug report).

Finally, create a `main()` method that creates a new instance of your testcase, and calls the `run` method:

```
public static void main(String[] args) throws Exception {
    new MyBugReport().run();
}
```

}

Once you have finished your testcase, and have verified that it demonstrates the bug you are reporting, upload it with your bug report to <http://bugs.mysql.com/>.

### 20.4.6.3. Connector/J Change History

The Connector/J Change History (Changelog) is located with the main Changelog for MySQL. See [Section C.7, “MySQL Connector/J Change History”](#).

## 20.5. MySQL Connector/MXJ

MySQL Connector/MXJ is a Java Utility package for deploying and managing a MySQL database. Deploying and using MySQL can be as easy as adding an additional parameter to the JDBC connection url, which will result in the database being started when the first connection is made. This makes it easy for Java developers to deploy applications which require a database by reducing installation barriers for their end-users.

MySQL Connector/MXJ makes the MySQL database appear to be a java-based component. It does this by determining what platform the system is running on, selecting the appropriate binary, and launching the executable. It will also optionally deploy an initial database, with any specified parameters.

Included are instructions for use with a JDBC driver and deploying as a JMX MBean to JBoss.

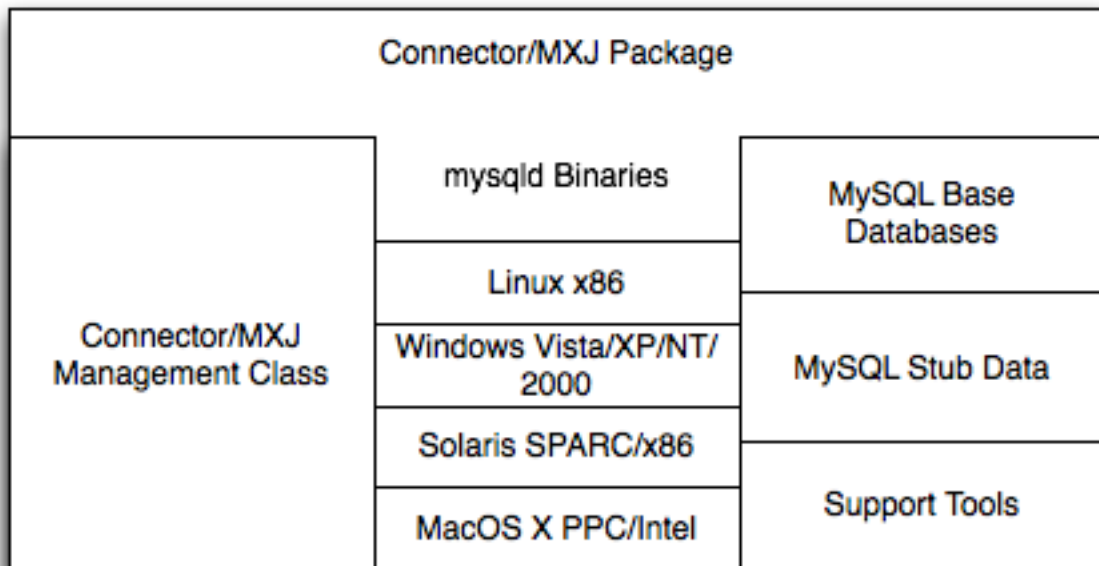
You can download sources and binaries from: <http://dev.mysql.com/downloads/connector/mxj/>

This is a beta release and feedback is welcome and encouraged.

Please send questions or comments to the [MySQL and Java mailing list](#).

### 20.5.1. Connector/MXJ Overview

Connector/MXJ consists of a Java class, a copy of the `mysqld` binary for a specific list of platforms, and associated files and support utilities. The Java class controls the initialization of an instance of the embedded `mysqld` binary, and the ongoing management of the `mysqld` process. The entire sequence and management can be controlled entirely from within Java using the Connector/MXJ Java classes. You can see an overview of the contents of the Connector/MXJ package in the figure below.



It is important to note that Connector/MXJ is not an embedded version of MySQL, or a version of MySQL written as part of a Java class. Connector/MXJ works through the use of an embedded, compiled binary of `mysqld` as would normally be used when deploying a standard MySQL installation.

It is the Connector/MXJ wrapper, support classes and tools, that enable Connector/MXJ to appear as a MySQL instance.

When Connector/MXJ is initialized, the corresponding `mysqld` binary for the current platform is extracted, along with a pre-

configured data directed. Both are contained within the Connector/MXJ JAR file. The `mysqld` instance is then started, with any additional options as specified during the initialization, and the MySQL database becomes accessible.

Because Connector/MXJ works in combination with Connector/J, you can access and integrate with the MySQL instance through a JDBC connection. When you have finished with the server, the instance is terminated, and, by default, any data created during the session is retained within the temporary directory created when the instance was started.

Connector/MXJ and the embedded `mysqld` instance can be deployed in a number of environments where relying on an existing database, or installing a MySQL instance would be impossible, including CD-ROM embedded database applications and temporary database requirements within a Java-based application environment.

## 20.5.2. Connector/MXJ Versions

- Connector/MXJ 5.x, currently in beta status, includes `mysqld` version 5.x and includes binaries for Linux x86, Mac OS X PPC, Windows XP/NT/2000 x86 and Solaris SPARC. Connector/MXJ 5.x requires the Connector/J 5.x package.

The exact version of `mysqld` included depends on the version of Connector/MXJ

- Connector/MXJ v5.0.3 included MySQL v5.0.22
  - Connector/MXJ v5.0.4 includes MySQL v5.0.27 (Community) or MySQL v5.0.32 (Enterprise)
  - Connector/MXJ v5.0.6 includes MySQL 5.0.37 (Community)
  - Connector/MXJ v5.0.7 includes MySQL 5.0.41 (Community) or MySQL 5.0.42 (Enterprise)
  - Connector/MXJ v5.0.8 includes MySQL 5.0.45 (Community) or MySQL 5.0.46 (Enterprise)
  - Connector/MXJ v5.0.9 includes MySQL 5.0.51a (Community) or MySQL 5.0.54 (Enterprise)
- Connector/MXJ 1.x includes `mysqld` version 4.1.13 and includes binaries for Linux x86, Windows XP/NT/2000 x86 and Solaris SPARC. Connector/MXJ 1.x requires the Connector/J 3.x package.

A summary of the different MySQL versions supplied with each Connector/MXJ release are shown in the table.

Connector/MXJ Version	MySQL Version(s)
5.0.8	5.0.45 (CS), 5.0.46 (ES)
5.0.7	5.0.41 (CS), 5.0.42 (ES)
5.0.6	5.0.37 (CS), 5.0.40 (ES)
5.0.5	5.0.37 (CS), 5.0.36 (ES)
5.0.4	5.0.27 (CS), 5.0.32 (ES)
5.0.3	5.0.22
5.0.2	5.0.19

This guide provides information on the Connector/MXJ 5.x release. For information on using the older releases, please see the documentation included with the appropriate distribution.

## 20.5.3. Connector/MXJ Installation

Connector/MXJ does not have a installation application or process, but there are some steps you can follow to make the installation and deployment of Connector/MXJ easier.

Before you start, there are some baseline requirements for

- Java Runtime Environment (v1.4.0 or newer) if you are only going to deploy the package.
- Java Development Kit (v1.4.0 or newer) if you want to build Connector/MXJ from source.
- Connector/J 5.0 or newer.

Depending on your target installation/deployment environment you may also require:

- JBoss - 4.0rc1 or newer
- Apache Tomcat - 5.0 or newer
- Sun's JMX reference implementation version 1.2.1 (from <http://java.sun.com/products/JavaManagement/>)

### 20.5.3.1. Supported Platforms

Connector/MXJ is compatible with any platform supporting Java and MySQL. By default, Connector/MXJ incorporates the `mysqld` binary for a select number of platforms which differs by version. The following platforms have been tested and working as deployment platforms. Support for all the platforms listed below is not included by default.

- Linux (i386)
- FreeBSD (i386)
- Windows NT (x86), Windows 2000 (x86), Windows XP (x86), Windows Vista (x86)
- Solaris 8, SPARC 32-bit (compatible with Solaris 8, Solaris 9 and Solaris 10 on SPARC 32-bit and 64-bit platforms)
- Mac OS X (PowerPC and Intel)

The Connector/MXJ 5.0.8 release includes `mysqld` binaries for the following platforms by as standard:

- Linux (i386)
- Windows (x86), compatible with Windows NT, Windows 2000, Windows XP , Windows Vista
- Solaris 8, SPARC 32-bit (compatible with Solaris 8, Solaris 9 and Solaris 10 on SPARC 32-bit and 64-bit platforms)
- Mac OS X (PowerPC and Intel)

For more information on packaging your own Connector/MXJ with the platforms you require, see [Section 20.5.6.1, “Creating your own Connector/MXJ Package”](#)

### 20.5.3.2. Connector/MXJ Base Installation

Because there is no formal installation process, the method, installation directory, and access methods you use for Connector/MXJ are entirely up to your individual requirements.

To perform a basic installation, choose a target directory for the files included in the Connector/MXJ package. On Unix/Linux systems you may opt to use a directory such as `/usr/local/connector-mxj`; On Windows, you may want to install the files in the base directory, `C:\Connector-MXJ`, or within the `Program Files` directory.

To install the files, for a Connector/MXJ 5.0.4 installation:

1. Download the Connector/MXJ package, either in Tar/Gzip format (ideal for Unix/Linux systems) or Zip format (Windows).
2. Extract the files from the package. This will create a directory `mysql-connector-mxj-gpl-[ver]`. Copy and optionally rename this directory to your desired location.
3. For best results, you should update your global `CLASSPATH` variable with the location of the required `jar` files.

Within Unix/Linux you can do this globally by editing the global shell profile, or on a user by user basis by editing their individual shell profile.

On Windows 2000, Windows NT and Windows XP, you can edit the global `CLASSPATH` by editing the `Environment Variables` configured through the `System` control panel.

For Connector/MXJ 5.0.6 and later you need the following JAR files in your `CLASSPATH`:

1. `mysql-connector-mxj-gpl-[ver].jar` — contains the main Connector/MXJ classes.

2. `mysql-connector-mxj-gpl-[ver]-db-files.jar` — contains the embedded `mysqld` and database files.
3. `aspectjrt.jar` — the AspectJ runtime library, located in `lib/aspectjrt.jar` in the Connector/MXJ package.
4. `mysql-connector-java-[ver]-bin.jar` — Connector/J, see [Section 20.4, “MySQL Connector/J”](#).

For Connector/MXJ 5.0.4 and later you need the following JAR files in your `CLASSPATH`:

1. `connector-mxj.jar` — contains the main Connector/MXJ classes.
2. `connector-mxj-db-files.jar` — contains the embedded `mysqld` and database files.
3. `aspectjrt.jar` — the AspectJ runtime library, located in `lib/aspectjrt.jar` in the Connector/MXJ package.
4. `mysql-connector-mxj-gpl-[ver].jar` — Connector/J, see [Section 20.4, “MySQL Connector/J”](#).

For Connector/MXJ 5.0.3 and earlier, you need the following JAR files:

1. `connector-mxj.jar`
2. `aspectjrt.jar` — the AspectJ runtime library, located in `lib/aspectjrt.jar` in the Connector/MXJ package.
3. `mysql-connector-mxj-gpl-[ver].jar` — Connector/J, see [Section 20.4, “MySQL Connector/J”](#).

### 20.5.3.3. Connector/MXJ Quick Start Guide

Once you have extracted the Connector/MXJ and Connector/J components you can run one of the sample applications that initiates a MySQL instance. You can test the installation by running the `ConnectorMXJUrlTestExample`:

```
shell> java ConnectorMXJUrlTestExample
jdbc:mysql:mxj://localhost:3336/our_test_app?server.basedir>
=/var/tmp/test-mxj&createDatabaseIfNotExist=true&server.initialize-user=true
[/var/tmp/test-mxj/bin/mysqld][--no-defaults][--port=3336][--socket=mysql.sock]>
[--basedir=/var/tmp/test-mxj][--datadir=/var/tmp/test-mxj/data]>
[--pid-file=/var/tmp/test-mxj/data/MysqldResource.pid]
[MysqldResource] launching mysqld (driver_launched_mysqld_1)
InnoDB: The first specified data file ./ibdata1 did not exist:
InnoDB: a new database to be created!
080220 9:40:20 InnoDB: Setting file ./ibdata1 size to 10 MB
InnoDB: Database physically writes the file full: wait...
080220 9:40:20 InnoDB: Log file ./ib_logfile0 did not exist: new to be created
InnoDB: Setting log file ./ib_logfile0 size to 5 MB
InnoDB: Database physically writes the file full: wait...
080220 9:40:20 InnoDB: Log file ./ib_logfile1 did not exist: new to be created
InnoDB: Setting log file ./ib_logfile1 size to 5 MB
InnoDB: Database physically writes the file full: wait...
InnoDB: Doublewrite buffer not found: creating new
InnoDB: Doublewrite buffer created
InnoDB: Creating foreign key constraint system tables
InnoDB: Foreign key constraint system tables created
080220 9:40:21 InnoDB: Started; log sequence number 0 0
080220 9:40:21 [Note] /var/tmp/test-mxj/bin/mysqld: ready for connections.
Version: '5.0.51a' socket: 'mysql.sock' port: 3336 MySQL Community Server (GPL)
[MysqldResource] mysqld running as process: 2238

SELECT VERSION()
-----
5.0.51a
-----
[MysqldResource] stopping mysqld (process: 2238)
080220 9:40:27 [Note] /var/tmp/test-mxj/bin/mysqld: Normal shutdown

080220 9:40:27 InnoDB: Starting shutdown...
080220 9:40:29 InnoDB: Shutdown completed; log sequence number 0 43655
080220 9:40:29 [Note] /var/tmp/test-mxj/bin/mysqld: Shutdown complete

[MysqldResource] shutdown complete
```

The above output shows an instance of MySQL starting, the necessary files being created (log files, InnoDB data files) and the MySQL database entering the running state. The instance is then shutdown by Connector/MXJ before the example terminates.

#### Warning

You should avoid running your Connector/MXJ application as the `root` user, because this will cause the `mysqld` to also be executed with root privileges. For more information, see [Section 5.3.5, “How to Run MySQL as a Normal User”](#).



### 20.5.3.4. Deploying Connector/MXJ using Driver Launch

Connector/MXJ and Connector/J work together to enable you to launch an instance of the `mysqld` server through the use of a keyword in the JDBC connection string. Deploying Connector/MXJ within a Java application can be automated through this method, making the deployment of Connector/MXJ a simple process:

1. Download and unzip Connector/MXJ, add `mysql-connector-mxj-gpl-[ver].jar` to the `CLASSPATH`.  
If you are using Connector/MXJ v5.0.4 or later you will also need to add the `mysql-connector-mxj-gpl-[ver]-db-files.jar` file to your `CLASSPATH`.
2. To the JDBC connection string, embed the `mxj` keyword, for example: `jdbc:mysql:mxj://localhost:PORT/DB-NAME`.

For more details, see [Section 20.5.4, “Connector/MXJ Configuration”](#).

### 20.5.3.5. Deploying Connector/MXJ within JBoss

For deployment within a JBoss environment, you must configure the JBoss environment to use the Connector/MXJ component within the JDBC parameters:

1. Download Connector/MXJ and copy the `mysql-connector-mxj-gpl-[ver].jar` file to the `$JBOSS_HOME/server/default/lib` directory.  
If you are using Connector/MXJ v5.0.4 or later you will also need to copy the `mysql-connector-mxj-gpl-[ver]-db-files.jar` file to `$JBOSS_HOME/server/default/lib`.
2. Download Connector/J and copy the `mysql-connector-java-5.1.5-bin.jar` file to the `$JBOSS_HOME/server/default/lib` directory.
3. Create an MBean service xml file in the `$JBOSS_HOME/server/default/deploy` directory with any attributes set, for instance the `datadir` and `autostart`.
4. Set the JDBC parameters of your web application to use:

```
String driver = "com.mysql.jdbc.Driver";
String url = "jdbc:mysql:///test?propertiesTransform="+
    "com.mysql.management.jmx.ConnectorMXJPropertiesTransform";
String user = "root";
String password = "";
Class.forName(driver);
Connection conn = DriverManager.getConnection(url, user, password);
```

You may wish to create a separate users and database table spaces for each application, rather than using "root and test".

We highly suggest having a routine backup procedure for backing up the database files in the `datadir`.

### 20.5.3.6. Verifying Installation using JUnit

The best way to ensure that your platform is supported is to run the JUnit tests. These will test the Connector/MXJ classes and the associated components.

#### 20.5.3.6.1. JUnit Test Requirements

The first thing to do is make sure that the components will work on the platform. The `MysqldResource` class is really a wrapper for a native version of MySQL, so not all platforms are supported. At the time of this writing, Linux on the i386 architecture has been tested and seems to work quite well, as does OS X v10.3. There has been limited testing on Windows and Solaris.

Requirements:

1. JDK-1.4 or newer (or the JRE if you aren't going to be compiling the source or JSPs).
2. MySQL Connector/J version 5.0 or newer (from <http://dev.mysql.com/downloads/connector/j/>) installed and available via your `CLASSPATH`.
3. The `javax.management` classes for JMX version 1.2.1, these are present in the following application servers:



- JBoss - 4.0rc1 or newer.
  - Apache Tomcat - 5.0 or newer.
  - Sun's JMX reference implementation version 1.2.1 (from <http://java.sun.com/products/JavaManagement/>).
4. JUnit 3.8.1 (from <http://www.junit.org/>).

If building from source, All of the requirements from above, plus:

1. Ant version 1.5 or newer (download from <http://ant.apache.org/>).

### 20.5.3.6.2. Running the JUnit Tests

1. The tests attempt to launch MySQL on the port 3336. If you have a MySQL running, it may conflict, but this isn't very likely because the default port for MySQL is 3306. However, You may set the "c-mxj\_test\_port" Java property to a port of your choosing. Alternatively, you may wish to start by shutting down any instances of MySQL you have running on the target machine.

The tests suppress output to the console by default. For verbose output, you may set the "c-mxj\_test\_silent" Java property to "false".

2. To run the JUnit test suite, the \$CLASSPATH must include the following:

- JUnit
- JMX
- Connector/J
- MySQL Connector/MXJ

3. If `connector-mxj.jar` is not present in your download, unzip MySQL Connector/MXJ source archive.

```
cd mysqljmx
ant dist
```

Then add `$TEMP/cmj/stage/connector-mxj/connector-mxj.jar` to the CLASSPATH.

4. if you have `junit`, execute the unit tests. From the command line, type:

```
java com.mysql.management.AllTestsSuite
```

The output should look something like this:

```
.....
.....
.....
Time: 259.438
OK (101 tests)
```

Note that the tests are a bit slow near the end, so please be patient.

## 20.5.4. Connector/MXJ Configuration

### 20.5.4.1. Running as part of the JDBC Driver

A feature of the MySQL Connector/J JDBC driver is the ability to specify a connection to an embedded Connector/MXJ instance through the use of the `mxj` keyword in the JDBC connection string.

In the following example, we have a program which creates a connection, executes a query, and prints the result to the `System.out`. The MySQL database will be deployed and started as part of the connection process, and shutdown as part of the finally block.

You can find this file in the Connector/MXJ package as [src/ConnectorMXJUrlTestExample.java](#).

```
import java.io.File;
import java.sql.Connection;
import java.sql.DriverManager;

import com.mysql.management.driverlaunched.ServerLauncherSocketFactory;
import com.mysql.management.util.QueryUtil;

public class ConnectorMXJUrlTestExample {
    public static String DRIVER = "com.mysql.jdbc.Driver";

    public static String JAVA_IO_TMPDIR = "java.io.tmpdir";

    public static void main(String[] args) throws Exception {
        File ourAppDir = new File(System.getProperty(JAVA_IO_TMPDIR));
        File databaseDir = new File(ourAppDir, "test-mxj");
        int port = Integer.parseInt(System.getProperty("c-mxj_test_port", "3336"));
        String dbName = "our_test_app";

        String url = "jdbc:mysql:mxj://localhost:" + port + "/" + dbName //
            + "?" + "serverbasedir=" + databaseDir //
            + "&" + "createDatabaseIfNotExist=true" //
            + "&" + "server.initialize-user=true" //
        ;

        System.out.println(url);

        String userName = "alice";
        String password = "q93uti0opwhkd";

        Class.forName(DRIVER);
        Connection conn = null;
        try {
            conn = DriverManager.getConnection(url, userName, password);
            String sql = "SELECT VERSION()";
            String queryForString = new QueryUtil(conn).queryForString(sql);

            System.out.println("-----");
            System.out.println(sql);
            System.out.println("-----");
            System.out.println(queryForString);
            System.out.println("-----");
            System.out.flush();
            Thread.sleep(100); // wait for System.out to finish flush
        } finally {
            try {
                if (conn != null)
                    conn.close();
            } catch (Exception e) {
                e.printStackTrace();
            }
        }

        ServerLauncherSocketFactory.shutdown(databaseDir, null);
    }
}
```

To run the above program, be sure to have connector-mxj.jar and Connector/J in the CLASSPATH. Then type:

```
java ConnectorMXJTestExample
```

### 20.5.4.2. Running within a Java Object

If you have a java application and wish to “embed” a MySQL database, make use of the [com.mysql.management.MysqldResource](#) class directly. This class may be instantiated with the default (no argument) constructor, or by passing in a [java.io.File](#) object representing the directory you wish the server to be “unzipped” into. It may also be instantiated with printstreams for “stdout” and “stderr” for logging.

Once instantiated, a [java.util.Map](#), the object will be able to provide a [java.util.Map](#) of server options appropriate for the platform and version of MySQL which you will be using.

The [MysqldResource](#) enables you to “start” MySQL with a [java.util.Map](#) of server options which you provide, as well as “shutdown” the database. The following example shows a simplistic way to embed MySQL in an application using plain java objects.

You can find this file in the Connector/MXJ package as [src/ConnectorMXJObjectTestExample.java](#).

```
import java.io.File;
import java.sql.Connection;
import java.sql.DriverManager;
import java.util.HashMap;
import java.util.Map;

import com.mysql.management.MysqldResource;
```

```

import com.mysql.management.MysqldResourceI;
import com.mysql.management.util.QueryUtil;

public class ConnectorMXJObjectTestExample {
    public static final String DRIVER = "com.mysql.jdbc.Driver";

    public static final String JAVA_IO_TMPDIR = "java.io.tmpdir";

    public static void main(String[] args) throws Exception {
        File ourAppDir = new File(System.getProperty(JAVA_IO_TMPDIR));
        File databaseDir = new File(ourAppDir, "mysql-mxj");
        int port = Integer.parseInt(System.getProperty("c-mxj_test_port",
            "3336"));
        String userName = "alice";
        String password = "q93uti0opwhkd";

        MysqldResource mysqldResource = startDatabase(databaseDir, port,
            userName, password);

        Class.forName(DRIVER);
        Connection conn = null;
        try {
            String dbName = "our_test_app";
            String url = "jdbc:mysql://localhost:" + port + "/" + dbName //
                + "?" + "createDatabaseIfNotExist=true"//
            ;
            conn = DriverManager.getConnection(url, userName, password);
            String sql = "SELECT VERSION()";
            String queryForString = new QueryUtil(conn).queryForString(sql);

            System.out.println("-----");
            System.out.println(sql);
            System.out.println("-----");
            System.out.println(queryForString);
            System.out.println("-----");
            System.out.flush();
            Thread.sleep(100); // wait for System.out to finish flush
        } finally {
            try {
                if (conn != null) {
                    conn.close();
                }
            } catch (Exception e) {
                e.printStackTrace();
            }
            try {
                mysqldResource.shutdown();
            } catch (Exception e) {
                e.printStackTrace();
            }
        }
    }

    public static MysqldResource startDatabase(File databaseDir, int port,
        String userName, String password) {
        MysqldResource mysqldResource = new MysqldResource(databaseDir);

        Map database_options = new HashMap();
        database_options.put(MysqldResourceI.PORT, Integer.toString(port));
        database_options.put(MysqldResourceI.INITIALIZE_USER, "true");
        database_options.put(MysqldResourceI.INITIALIZE_USER_NAME, userName);
        database_options.put(MysqldResourceI.INITIALIZE_PASSWORD, password);

        mysqldResource.start("test-mysqld-thread", database_options);

        if (!mysqldResource.isRunning()) {
            throw new RuntimeException("MySQL did not start.");
        }

        System.out.println("MySQL is running.");

        return mysqldResource;
    }
}

```

### 20.5.4.3. Setting server options

Of course there are many options we may wish to set for a MySQL database. These options may be specified as part of the JDBC connection string simply by prefixing each server option with `server..` In the following example we set two driver parameters and two server parameters:

```

String url = "jdbc:mysql://" + hostColonPort + "/"
    + "?"
    + "cacheServerConfiguration=true"
    + "&"
    + "useLocalSessionState=true"
    + "&"
    + "server.basedir=/opt/myapp/db"
    + "&"
    + "server.datadir=/mnt/bigdisk/myapp/data";

```

Starting with Connector/MXJ 5.0.6 you can use the `initializer-user` property to a connection string. If set to true, the default anonymous and root users will be removed and the user/password combination from the connection URL will be used to create a new user. For example:

```
String url = "jdbc:mysql:mxj://localhost:" + port
+ "/alice_db"
+ "?server.dataDir=" + dataDir.getPath()
+ "&server.initialize-user=true"
+ "&createDatabaseIfNotExist=true"
;
```

## 20.5.5. Connector/MXJ Reference

The following sections include detailed information on the different API interfaces to Connector/MXJ.

### 20.5.5.1. MysqldResource Constructors

The `MysqldResource` class supports three different constructor forms:

- `public MysqldResource(File baseDir, File dataDir, String mysqlVersionString, PrintStream out, PrintStream err)`

Enables you to set the base directory, data directory, select a server by its version string, standard out and standard error.
- `public MysqldResource(File baseDir, File dataDir, String mysqlVersionString)`

Enables you to set the base directory, data directory and select a server by its version string. Output for standard out and standard err are directed to `System.out` and `System.err`.
- `public MysqldResource(File baseDir, File dataDir)`

Enables you to set the base directory and data directory. The default MySQL version is selected, and output for standard out and standard err are directed to `System.out` and `System.err`.
- `public MysqldResource(File baseDir);`

Allows the setting of the "basedir" to deploy the MySQL files to. Output for standard out and standard err are directed to `System.out` and `System.err`.
- `public MysqldResource();`

The basedir is defaulted to a subdirectory of the `java.io.tmpdir`. Output for standard out and standard err are directed to `System.out` and `System.err`;

### 20.5.5.2. MysqldResource Methods

`MysqldResource` API includes the following methods:

- `void start(String threadName, Map mysqlArgs);`

Deploys and starts MySQL. The "threadName" string is used to name the thread which actually performs the execution of the MySQL command line. The map is the set of arguments and their values to be passed to the command line.
- `void shutdown();`

Shuts down the MySQL instance managed by the `MysqldResource` object.
- `Map getServerOptions();`

Returns a map of all the options and their current (or default, if not running) options available for the MySQL database.
- `boolean isRunning();`

Returns true if the MySQL database is running.
- `boolean isReadyForConnections();`

Returns true once the database reports that is ready for connections.

- `void setKillDelay(int millis);`

The default “Kill Delay” is 30 seconds. This represents the amount of time to wait between the initial request to shutdown and issuing a “force kill” if the database has not shutdown by itself.

- `void addCompletionListener(Runnable listener);`

Allows for applications to be notified when the server process completes. Each "listener" will be fired off in its own thread.

- `String getVersion();`

Returns the version of MySQL.

- `void setVersion(int MajorVersion, int minorVersion, int patchLevel);`

The standard distribution comes with only one version of MySQL packaged. However, it is possible to package multiple versions, and specify which version to use.

## 20.5.6. Connector/MXJ Notes and Tips

This section contains notes and tips on using the Connector/MXJ component within your applications.

### 20.5.6.1. Creating your own Connector/MXJ Package

If you want to create a custom Connector/MXJ package that includes a specific `mysqld` version or platform then you must extract and rebuild the `mysql-connector-mxj.jar` (Connector/MXJ v5.0.3 or earlier) or `mysql-connector-mxj-gpl-[ver]-db-files.jar` (Connector/MXJ v5.0.4 or later) file.

First, you should create a new directory into which you can extract the current `connector-mxj.jar`:

```
shell> mkdir custom-mxj
shell> cd custom-mxj
shell> jar -xf connector-mxj.jar
shell> ls
5-0-22/
ConnectorMXJObjectTestExample.class
ConnectorMXJUrlTestExample.class
META-INF/
TestDb.class
com/
kill.exe
```

If you are using Connector/MXJ v5.0.4 or later, you should unpack the `connector-mxj-db-files.jar`:

```
shell> mkdir custom-mxj
shell> cd custom-mxj
shell> jar -xf connector-mxj-db-files.jar
shell> ls
5-0-51a/
META-INF/
connector-mxj.properties
```

The MySQL version directory, `5-0-22` or `5-0-51a` in the preceding examples, contains all of the files used to create an instance of MySQL when Connector/MXJ is executed. All of the files in this directory are required for each version of MySQL that you want to embed. Note as well the format of the version number, which uses hyphens instead of periods to separate the version number components.

Within the version specific directory are the platform specific directories, and archives of the `data` and `share` directory required by MySQL for the various platforms. For example, here is the listing for the default Connector/MXJ package:

```
shell>> ls
Linux-i386/
META-INF/
Mac_OS_X-ppc/
SunOS-sparc/
Win-x86/
com/
data_dir.jar
share_dir.jar
win_share_dir.jar
```

Platform specific directories are listed by their OS and platform - for example the `mysqld` for Mac OS X PowerPC is located within the `Mac_OS_X-ppc` directory. You can delete directories from this location that you do not require, and add new directories for additional platforms that you want to support.

To add a platform specific `mysqld`, create a new directory with the corresponding name for your operating system/platform. For example, you could add a directory for Mac OS X/Intel using the directory `Mac_OS_X-i386`.

On Unix systems, you can determine the platform using `uname`:

```
shell> uname -p
i386
```

In Connector/MXJ v5.0.9 and later, an additional `platform-map.properties` file is used to associate a specific platform and operating system combination with the directory in which the `mysqld` for that combination is located. The determined operating system and platform are on the left, and the directory name where the appropriate `mysqld` is located is on the right. You can see a sample of the file below:

```
Linux-i386=Linux-i386
Linux-x86=Linux-i386
Linux-i686=Linux-i386
Linux-x86_64=Linux-i386
Linux-ia64=Linux-i386

#Linux-ppc=Linux-ppc
#Linux-ppc64=Linux-ppc

Mac_OS_X-i386=Mac_OS_X-i386
Mac_OS_X-ppc=Mac_OS_X-ppc
Rhapsody-PowerPC=Mac_OS_X-ppc
#Mac_OS-PowerPC=
#macos-PowerPC=
#MacOS-PowerPC=

SunOS-sparc=SunOS-sparc
Solaris-sparc=SunOS-sparc
SunOS-x86=SunOS-x86
Solaris-x86=SunOS-x86

FreeBSD-x86=FreeBSD-x86

Windows_Vista-x86=Win-x86
Windows_2003-x86=Win-x86
Windows_XP-x86=Win-x86
Windows_2000-x86=Win-x86
Windows_NT-x86=Win-x86
Windows_NT_(unknown)-x86=Win-x86
```

Now you need to download or compile `mysqld` for the MySQL version and platform you want to include in your custom `connector-mxj.jar` package into the new directory.

Create a file called `version.txt` in the OS/platform directory you have just created that contains the version string/path of the `mysqld` binary. For example:

```
mysql-5.0.22-osx10.3-i386/bin/mysqld
```

You can now recreate the `connector-mxj.jar` file with the added `mysqld`:

```
shell> cd custom-mxj
shell> jar -cf ../connector-mxj.jar *
```

For Connector/MXJ v5.0.4 and later, you should repackage to the `connector-mxj-db-files.jar`:

```
shell> cd custom-mxj
shell> jar -cf ../mysql-connector-mxj-gpl-[ver]-db-files.jar *
```

You should test this package using the steps outlined in [Section 20.5.3.3, “Connector/MXJ Quick Start Guide”](#).

### Note

Because the `mysql-connector-mxj-gpl-[ver]-db-files.jar` file is separate from the main Connector/MXJ classes you can distribute different `mysql-connector-mxj-gpl-[ver]-db-files.jar` files to different hosts or for different projects without having to create a completely new main `mysql-connector-mxj-gpl-[ver].jar` file for each one.

## 20.5.6.2. Deploying Connector/MXJ with a pre-configured database

To include a pre-configured/populated database within your Connector/MXJ JAR file you must create a custom `data_dir.jar` file, as included within the main `connector-mxj.jar` (Connector/MXJ 5.0.3 or earlier) or `mysql-connector-mxj-gpl-[ver]-db-files.jar` (Connector/MXJ 5.0.4 or later) file:

1. First extract the `connector-mxj.jar` or `mysql-connector-gpl-[ver]-db-files.jar` file, as outlined in the previous section (see [Section 20.5.6.1](#), “Creating your own Connector/MXJ Package”).
2. First, create your database and populate the database with the information you require in an existing instance of MySQL - including Connector/MXJ instances. Data file formats are compatible across platforms.
3. Shutdown the instance of MySQL.
4. Create a JAR file of the data directory and databases that you want to include your Connector/MXJ package. You should include the `mysql` database, which includes user authentication information, in addition to the specific databases you want to include. For example, to create a JAR of the `mysql` and `mxjtest` databases:

```
shell> jar -cf ../data_dir.jar mysql mxjtest
```

5. For Connector/MXJ 5.0.3 or earlier, copy the `data_dir.jar` file into the extracted `connector-mxj.jar` directory, and then create an archive for `connector-mxj.jar`.

For Connector/MXJ 5.0.4 or later, copy the `data_dir.jar` file into the extracted `mysql-connector-mxj-gpl-[ver]-db-files.jar` directory, and then create an archive for `mysql-connector-mxj-gpl-[ver]-db-files.jar`.

Note that if you are create databases using the InnoDB engine, you must include the `ibdata.*` and `ib_logfile*` files within the `data_dir.jar` archive.

### 20.5.6.3. Running within a JMX Agent (custom)

As a JMX MBean, MySQL Connector/MXJ requires a JMX v1.2 compliant MBean container, such as JBoss version 4. The MBean will use the standard JMX management APIs to present (and allow the setting of) parameters which are appropriate for that platform.

If you are not using the SUN Reference implementation of the JMX libraries, you should skip this section. Or, if you are deploying to JBoss, you also may wish to skip to the next section.

We want to see the `MysqldDynamicMBean` in action inside of a JMX agent. In the `com.mysql.management.jmx.sunri` package is a custom JMX agent with two MBeans:

1. the `MysqldDynamicMBean`, and
2. a `com.sun.jdmk.comm.HtmlAdaptorServer`, which provides a web interface for manipulating the beans inside of a JMX agent.

When this very simple agent is started, it will allow a MySQL database to be started and stopped with a web browser.

1. Complete the testing of the platform as above.
  - current JDK, JUnit, Connector/J, MySQL Connector/MXJ
  - this section *requires* the SUN reference implementation of JMX
  - `PATH`, `JAVA_HOME`, `ANT_HOME`, `CLASSPATH`

2. If not building from source, skip to next step

rebuild with the "sunri.present"

```
ant -Dsunri.present=true dist
re-run tests:
java junit.textui.TestRunner com.mysql.management.AllTestsSuite
```

3. launch the test agent from the command line:

```
java com.mysql.management.jmx.sunri.MysqldTestAgentSunHtmlAdaptor &
```

4. from a browser:

```
http://localhost:9092/
```

5. under MysqlAgent,

```
select "name=mysqlid"
```

6. Observe the MBean View
7. scroll to the bottom of the screen press the STARTMYSQLD button
8. click [Back to MBean View](#)
9. scroll to the bottom of the screen press STOPMYSQLD button
10. kill the java process running the Test Agent (jmx server)

#### 20.5.6.4. Deployment in a standard JMX Agent environment (JBoss)

Once there is confidence that the MBean will function on the platform, deploying the MBean inside of a standard JMX Agent is the next step. Included are instructions for deploying to JBoss.

1. Ensure a current version of java development kit (v1.4.x), see above.
  - Ensure `JAVA_HOME` is set (JBoss requires `JAVA_HOME`)
  - Ensure `JAVA_HOME/bin` is in the `PATH` (You will NOT need to set your `CLASSPATH`, nor will you need any of the jars used in the previous tests).
2. Ensure a current version of JBoss (v4.0RC1 or better)

```
http://www.jboss.org/index.html
select "Downloads"
select "jboss-4.0.zip"
pick a mirror
unzip ~/dload/jboss-4.0.zip
create a JBOSS_HOME environment variable set to the unzipped directory
unix only:
cd $JBOSS_HOME/bin
chmod +x *.sh
```

3. Deploy (copy) the `connector-mxj.jar` to `$JBOSS_HOME/server/default/lib`.
4. Deploy (copy) `mysql-connector-java-3.1.4-beta-bin.jar` to `$JBOSS_HOME/server/default/lib`.
5. Create a `mxjtest.war` directory in `$JBOSS_HOME/server/default/deploy`.
6. Deploy (copy) `index.jsp` to `$JBOSS_HOME/server/default/deploy/mxjtest.war`.
7. Create a `mysqlid-service.xml` file in `$JBOSS_HOME/server/default/deploy`.

```
<?xml version="1.0" encoding="UTF-8"?>
<server>
  <mbean code="com.mysql.management.jmx.jboss.JBossMysqlidDynamicMBean"
    name="mysql:type=service,name=mysqlid">
    <attribute name="datadir">/tmp/xxx_data_xxx</attribute>
    <attribute name="autostart">true</attribute>
  </mbean>
</server>
```

8. Start jboss:
  - on unix: `$JBOSS_HOME/bin/run.sh`
  - on windows: `%JBOSS_HOME%\bin\run.bat`

Be ready: JBoss sends a lot of output to the screen.

9. When JBoss seems to have stopped sending output to the screen, open a web browser to: <http://localhost:8080/jmx-console>
10. Scroll down to the bottom of the page in the `mysql` section, select the bulleted `mysqlid` link.
11. Observe the JMX MBean View page. MySQL should already be running.



12. (If "autostart=true" was set, you may skip this step.) Scroll to the bottom of the screen. You may press the INVOKE button to stop (or start) MySQL observe `Operation completed successfully without a return value`. Click `Back to MBean View`
13. To confirm MySQL is running, open a web browser to `http://localhost:8080/mxjtest/` and you should see that

```
SELECT 1
```

returned with a result of

```
1
```

14. Guided by the `$JBOSS_HOME/server/default/deploy/mxjtest.war/index.jsp` you will be able to use MySQL in your Web Application. There is a `test` database and a `root` user (no password) ready to experiment with. Try creating a table, inserting some rows, and doing some selects.
15. Shut down MySQL. MySQL will be stopped automatically when JBoss is stopped, or: from the browser, scroll down to the bottom of the MBean View press the stop service INVOKE button to halt the service. Observe `Operation completed successfully without a return value`. Using `ps` or `task manager` see that MySQL is no longer running

As of 1.0.6-beta version is the ability to have the MBean start the MySQL database upon start up. Also, we've taken advantage of the JBoss life-cycle extension methods so that the database will gracefully shut down when JBoss is shutdown.

## 20.5.7. Connector/MXJ Support

There are a wide variety of options available for obtaining support for using Connector/MXJ. You should contact the Connector/MXJ community for help before reporting a potential bug or problem. See [Section 20.5.7.1, "Connector/MXJ Community Support"](#).

### 20.5.7.1. Connector/MXJ Community Support

Sun Microsystems, Inc. provides assistance to the user community by means of a number of mailing lists and web based forums.

You can find help and support through the [MySQL and Java](#) mailing list.

For information about subscribing to MySQL mailing lists or to browse list archives, visit <http://lists.mysql.com/>. See [Section 1.5.1, "MySQL Mailing Lists"](#).

Community support from experienced users is also available through the [MyODBC Forum](#). You may also find help from other users in the other MySQL Forums, located at <http://forums.mysql.com>. See [Section 1.5.2, "MySQL Community Support at the MySQL Forums"](#).

### 20.5.7.2. How to Report Connector/MXJ Problems

If you encounter difficulties or problems with Connector/MXJ, contact the Connector/MXJ community [Section 20.5.7.1, "Connector/MXJ Community Support"](#).

If reporting a problem, you should ideally include the following information with the email:

- Operating system and version
- Connector/MXJ version
- MySQL server version
- Copies of error messages or other unexpected output
- Simple reproducible sample

Remember that the more information you can supply to us, the more likely it is that we can fix the problem.

If you believe the problem to be a bug, then you must report the bug through <http://bugs.mysql.com/>.

### 20.5.7.3. Connector/MXJ Change History

The Connector/MXJ Change History (Changelog) is located with the main Changelog for MySQL. See [Section C.8, "MySQL Con-](#)

[nector/MXJ Change History](#)".

## 20.6. MySQL Connector/C++

### Caution

Please note, official support is not available for the beta version of MySQL Connector/C++.

MySQL Connector/C++ is a MySQL database connector for C++.

The MySQL Connector/C++ is licensed under the terms of the GPL, like most MySQL Connectors. There are special exceptions to the terms and conditions of the GPL as it is applied to this software, see FLOSS License Exception. If you need a non-GPL license for commercial distribution please contact us.

The MySQL Connector/C++ is compatible with the JDBC 4.0 API. However, MySQL Connector/C++ does not implement all of the JDBC 4.0 API. The MySQL Connector/C++ current version features the following classes:

- [Connection](#)
- [DatabaseMetaData](#)
- [Driver](#)
- [PreparedStatement](#)
- [ResultSet](#)
- [ResultSetMetaData](#)
- [Savepoint](#)
- [Statement](#)

The JDBC 4.0 API defines approximately 450 methods for the above mentioned classes. MySQL Connector/C++ implements around 80% of these and makes them available in the preview release.

The Beta release has been successfully compiled and tested on the following platforms:

### AIX

- 5.2 (PPC32, PPC64)
- 5.3 (PPC32, PPC64)

### FreeBSD

- 6.0 (x86, x86\_64)

### HPUX

- 11.11 (PA-RISC 32bit, PA-RISC 64bit)

### Linux

- Debian 3.1 (PPC32, x86)
- FC4 (x86)
- RHEL 3 (ia64, x86, x86\_64)
- RHEL 4 (ia64, x86, x86\_64)
- RHEL 5 (ia64, x86, x86\_64)

- SLES 9 (ia64, x86, x86\_64)
- SLES 10 (ia64, x86\_64)
- SuSE 10.3, (x86\_64)
- Ubuntu 8.04 (x86)
- Ubuntu 8.10 (x86\_64)

#### Mac

- MacOSX 10.3 (PPC32, PPC64)
- MacOSX 10.4 (PPC32, PPC64, x86)
- MacOSX 10.5 (PPC32, PPC64, x86, x86\_64)

#### SunOS

- Solaris 8 (SPARC32, SPARC64, x86)
- Solaris 9 (SPARC32, SPARC64, x86)
- Solaris 10 (SPARC32, SPARC64, x86, x86\_64)

#### Windows

- XP Professional (32bit)
- 2003 (64bit)

Future versions will run on all platforms supported by the MySQL Server.

#### Note

MySQL Connector/C++ supports MySQL 5.1 and later.

#### Note

MySQL Connector/C++ supports only Microsoft Visual Studio 2003 and above on Windows.

#### MySQL Connector/C++ Download

You can download the source code for the MySQL Connector/C++ preview release at the [download site](#).

#### MySQL Connector/C++ Source repository

The latest development version is also available through [Launchpad](#).

Bazaar is used for the MySQL Connector/C++ code repository. You can check out the source code using the [bzc](#) command line tool:

```
shell> bzc branch lp:~mysql/mysql-connector-cpp/trunk .
```

The source of the 1.0.3alpha release is available from the following branch:

```
shell> bzc branch lp:~andrey-mysql/mysql-connector-cpp/v1_0_3
```

The source of the 1.0.2alpha release is available from the following branch:

```
shell> bzc branch lp:~andrey-mysql/mysql-connector-cpp/v1_0_2
```

The source of the 1.0.1alpha release is available from the following branch:

```
shell> bzr branch lp:~andrey-mysql/mysql-connector-cpp/v1_0_1
```

### Binary distributions

Starting with 1.0.4 Beta, binary distributions will be made available in addition to source code releases. The releases available are shown below.

Microsoft Windows platform:

- Without installer, a Zip file
- MSI installer package

Other platforms:

- Compressed GNU TAR archive (tar.gz)

#### Note

Note that source packages are available for all platforms in the Compressed GNU TAR archive (tar.gz) format.

### MySQL Connector/C++ Advantages

Using MySQL Connector/C++ instead of the MySQL C API (MySQL Client Library) offers the following advantages for C++ users:

- Convenience of pure C++, no C function calls required
- Supports an industry standard API, JDBC 4.0
- Supports the object-oriented programming paradigm
- Reduces development time
- MySQL Connector/C++ is licensed under the GPL with the FLOSS License Exception
- MySQL Connector/C++ is available under a commercial license upon request

### MySQL Connector/C++ Status

MySQL Connector/C++ is available as a development preview version. We kindly ask users and developers to try it out and provide us with feedback. We do not encourage you to use it in production environments.

Note that MySQL Workbench is successfully using MySQL Connector/C++.

#### Note

Sun Microsystems does not provide formal support for MySQL Connector/C++.

If you have any queries please [contact us](#).

## 20.6.1. MySQL Connector/C++ Binary Installation

#### Caution

Please note, official support is not available for the beta version of MySQL Connector/C++.

#### Caution

One problem that can occur is when the tools you use to build your application are not compatible with the tools used to build the binary versions of MySQL Connector/C++. Ideally you need to build your application with the same tools that were used to build the MySQL Connector/C++ binaries. To help with this the following resources are provided.

All distributions contain a [README](#) file, which contains platform-specific notes. At the end of the [README](#) file contained in the binary distribution you will find the settings used to build the binaries. If you experience build-related is-

sues on a platform, it may help to check the settings used on the platform to build the binary.

For your convenience the same information, but more frequently updated, can be found on the [MySQL Forge site](#).

A better solution is to build your MySQL Connector/C++ libraries from the source code, using the same tools that you use for building your application. This ensures compatibility.

### Archive Package

Unpack the archive into an appropriate directory. If you plan to use a dynamically linked version of MySQL Connector/C++, make sure that your system can reference the MySQL Client Library. Consult your operating system documentation on how to modify and expand the search path for libraries. In case you cannot modify the library search path it may help to copy your application, the MySQL Connector/C++ library and the MySQL Client Library into the same directory. Most systems search for libraries in the current directory.

### Windows MSI Installer

Windows users can choose between two binary packages:

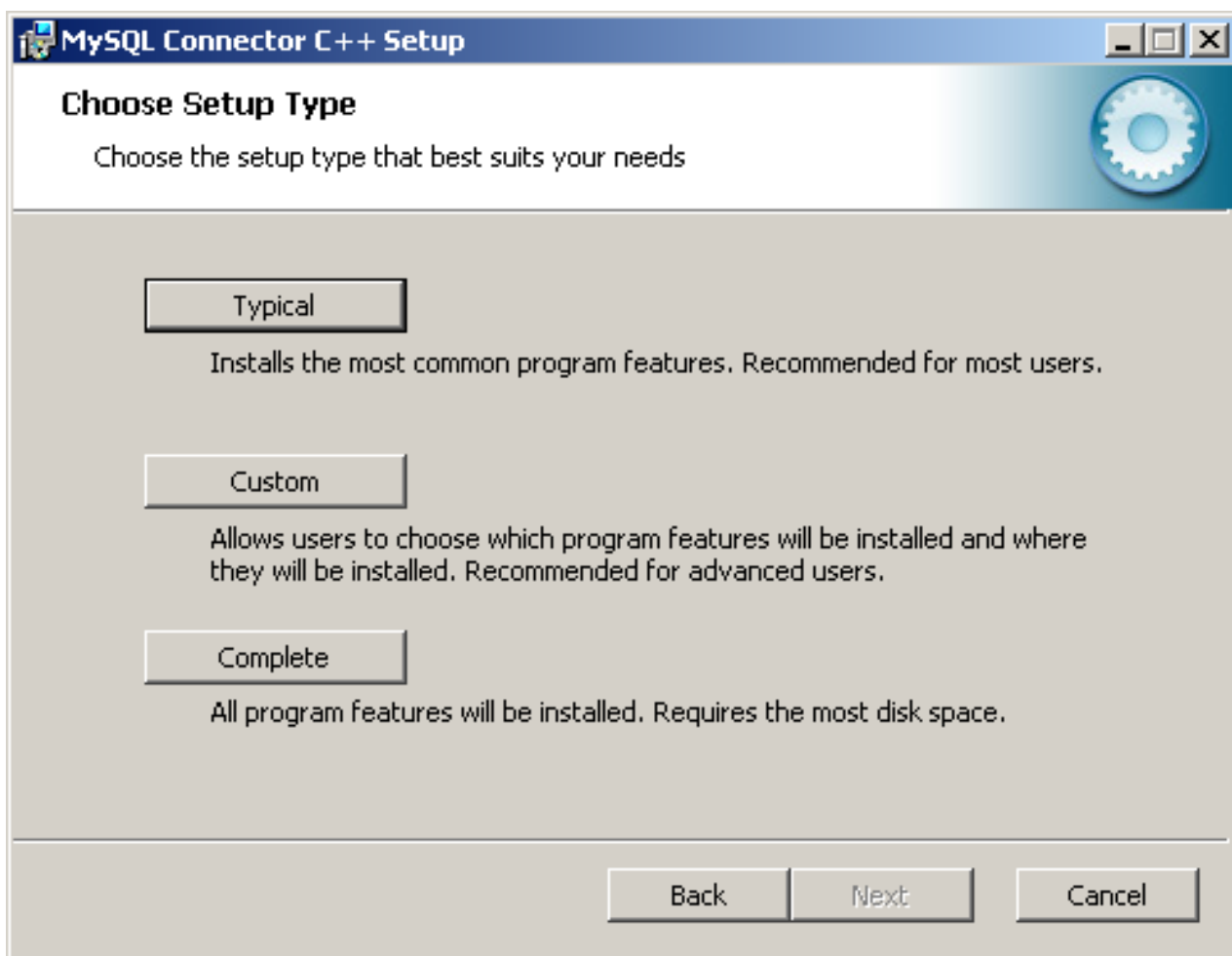
1. Without installer (unzip in C:\)
2. Windows MSI Installer (x86)

Using the MSI Installer may be the easiest solution. Running the MSI Installer does not require any administrative permissions as it simply copies files.

**Figure 20.40. Windows Installer Welcome Screen**

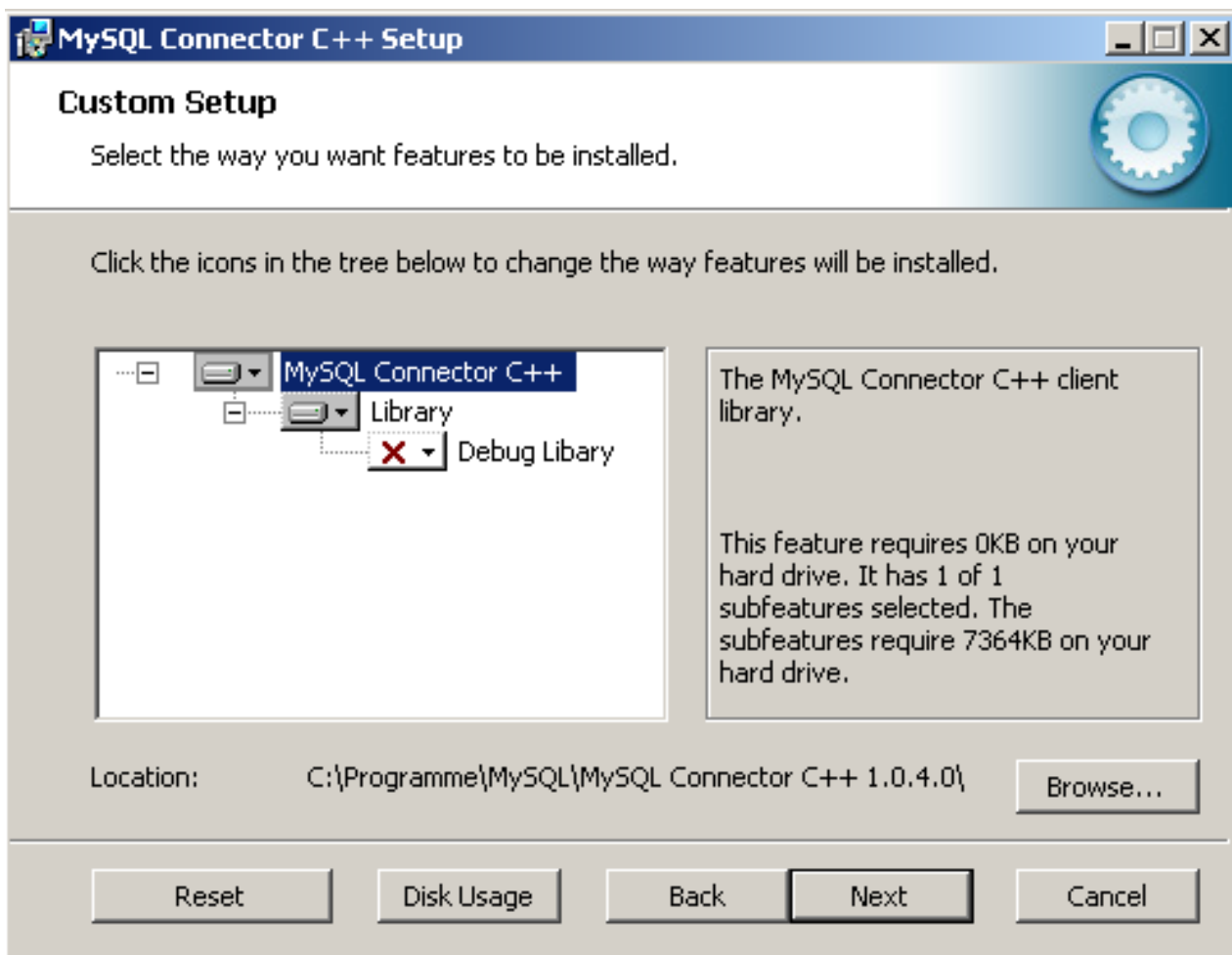


**Figure 20.41. Windows Installer Overview Screen**



The “Typical” installation consists of all required header files and the Release libraries. The only available “Custom” installation option allows you to install additional Debug versions of the connector libraries.

**Figure 20.42. Windows Installer Custom Setup Screen**



## 20.6.2. MySQL Connector/C++ Source Installation

### Caution

Please note, official support is not available for the beta version of MySQL Connector/C++.

The MySQL Connector/C++ is based on the MySQL Client Library (MySQL C API). MySQL Connector/C++ is linked against the MySQL Client Library. You need to have the MySQL Client Library installed in order to compile MySQL Connector/C++.

You also need to have the cross-platform build tool CMake 2.4, or newer, and GLib 2.2.3 or newer installed. Check the README file included with the distribution for platform specific notes on building for Windows and SunOS.

Typically the MySQL Client Library is installed when the MySQL Server is installed. However, check your operating system documentation for other installation options.

### 20.6.2.1. Building source on Unix, Solaris and Mac OS X

1. Run CMake to build a Makefile:

```
shell> me@host:/path/to/mysql-connector-cpp> cmake .
-- Check for working C compiler: /usr/local/bin/gcc
-- Check for working C compiler: /usr/local/bin/gcc -- works
[...]
-- Generating done
-- Build files have been written to: /path/to/mysql-connector-cpp/
```

On non-Windows systems, CMake first checks to see if the CMake variable `MYSQL_CONFIG_EXECUTABLE` is set. If it is not found CMake will try to locate `mysql_config` in the default locations.

If you have any problems with the configure process please check the troubleshooting instructions below.

2. Use make to build the libraries. First make sure you have a clean build:

```
shell> me@host:/path/to/mysql-connector-cpp> make clean
```

Then build the connector:

```
me@host:/path/to/mysql-connector-cpp> make
[ 1%] Building CXX object »
driver/CMakeFiles/mysqlcppconn.dir/mysql_connection.o
[ 3%] Building CXX object »
driver/CMakeFiles/mysqlcppconn.dir/mysql_constructed_resultset.o
[...]
[100%] Building CXX object examples/CMakeFiles/statement.dir/statement.o
Linking CXX executable statement
```

If all goes well, you will find the MySQL Connector/C++ library in `/path/to/cppconn/libmysqlcppconn.so`.

3. Finally make sure the header and library files are installed to their correct locations:

```
make install
```

Unless you have changed this in the configuration step, the header files will be copied to the directory `/usr/local/include`. The header files copied are `mysql_connection.h` and `mysql_driver.h`.

Again, unless you have specified otherwise, the library files will be copied to `/usr/local/lib`. The files copied are `libmysqlcppcon.so`, the dynamic library, and `libmysqlcppconn-static.a`, the static library.

If you encounter any errors, please first carry out the checks shown below:

1. CMake options: MySQL installation path, debug version and more

In case of configure and/or compile problems check the list of CMake options:

```
shell> me@host:/path/to/mysql-connector-cpp> cmake -L
[...]
CMAKE_BACKWARDS_COMPATIBILITY:STRING=2.4
CMAKE_BUILD_TYPE:STRING=
CMAKE_INSTALL_PREFIX:PATH=/usr/local
EXECUTABLE_OUTPUT_PATH:PATH=
LIBRARY_OUTPUT_PATH:PATH=
MYSQLCPPCONN_GCOV_ENABLE:BOOL=0
MYSQLCPPCONN_TRACE_ENABLE:BOOL=0
MYSQL_CONFIG_EXECUTABLE:FILEPATH=/usr/bin/mysql_config
```

For example, if your MySQL Server installation path is not `/usr/local/mysql` and you want to build a debug version of the MySQL Connector/C++ use:

```
shell> me@host:/path/to/mysql-connector-cpp> cmake »
-D CMAKE_BUILD_TYPE:STRING=Debug »
-D MYSQL_CONFIG_EXECUTABLE=/path/to/my/mysql/server/bin/mysql_config .
```

2. Verify your settings with `cmake -L`:

```
shell> me@host:/path/to/mysql-connector-cpp> cmake -L
[...]
CMAKE_BACKWARDS_COMPATIBILITY:STRING=2.4
CMAKE_BUILD_TYPE:STRING=
CMAKE_INSTALL_PREFIX:PATH=/usr/local
EXECUTABLE_OUTPUT_PATH:PATH=
LIBRARY_OUTPUT_PATH:PATH=
MYSQLCPPCONN_GCOV_ENABLE:BOOL=0
MYSQLCPPCONN_TRACE_ENABLE:BOOL=0
MYSQL_CONFIG_EXECUTABLE=/path/to/my/mysql/server/bin/mysql_config
```

Proceed by carrying out a `make clean` command followed by a `make` command, as described above.

## 20.6.2.2. Building on Windows

### Note

Please note the only compiler formally supported for Windows is Microsoft Visual Studio 2003 and above.

The basic steps for building the connector on Windows are the same as for Unix. It is important to use CMake 2.6.2 or newer to



generate build files for your compiler and to invoke the compiler.

### Note

On Windows, `mysql_config` is not present, so CMake will attempt to retrieve the location of MySQL from the environment variable `$ENV{MYSQL_DIR}`. If `MYSQL_DIR` is not set, CMake will then proceed to check for MySQL in the following locations: `$ENV{ProgramFiles}/MySQL/*/include`, and `$ENV{SystemDrive}/MySQL/*/include`.

CMake makes it easy for you to try out other compilers. However, you may experience compile warnings, compile errors or linking issues not detected by Visual Studio. Patches are gratefully accepted to fix issues with other compilers.

Consult the CMake manual or check `cmake --help` to find out which build systems are supported by your CMake version:

```
C:\>cmake --help
cmake version 2.6-patch 2
Usage
[...]
Generators

The following generators are available on this platform:
  Borland Makefiles      = Generates Borland makefiles.
  MSYS Makefiles         = Generates MSYS makefiles.
  MinGW Makefiles        = Generates a make file for use with
                          mingw32-make.
  NMake Makefiles        = Generates NMake makefiles.
  Unix Makefiles          = Generates standard UNIX makefiles.
  Visual Studio 6         = Generates Visual Studio 6 project files.
  Visual Studio 7         = Generates Visual Studio .NET 2002 project
                          files.
  Visual Studio 7 .NET 2003 = Generates Visual Studio .NET 2003 project
                          files.
  Visual Studio 8 2005    = Generates Visual Studio .NET 2005 project
                          files.
  Visual Studio 8 2005 Win64 = Generates Visual Studio .NET 2005 Win64
                          project files.
  Visual Studio 9 2008    = Generates Visual Studio 9 2008 project fil
  Visual Studio 9 2008 Win64 = Generates Visual Studio 9 2008 Win64 proje
                          files.
[...]

```

It is likely that your CMake binary will support more compilers, known by CMake as *generators*, than supported by MySQL Connector/C++. We have built the connector using the following generators:

- Microsoft Visual Studio 8 (Visual Studio 2005)
- Microsoft Visual Studio 9 (Visual Studio 2008, Visual Studio 2008 Express)
- NMake

Please see the building instructions for Unix, Solaris and Mac OS X for troubleshooting and configuration hints.

The steps to build the connector are given below:

1. Run CMake to generate build files for your *generator*:

#### Visual Studio

```
C:\path_to_mysql_cpp>cmake -G "Visual Studio 9 2008"
-- Check for working C compiler: cl
-- Check for working C compiler: cl -- works
-- Detecting C compiler ABI info
-- Detecting C compiler ABI info - done
-- Check for working CXX compiler: cl
-- Check for working CXX compiler: cl -- works
-- Detecting CXX compiler ABI info
-- Detecting CXX compiler ABI info - done
-- ENV{MYSQL_DIR} =
-- MySQL Include dir: C:/Programme/MySQL/MySQL Server 5.1/include
-- MySQL Library : C:/Progams/MySQL/MySQL Server 5.1/lib/opt/mysqlclient.lib
-- MySQL Library dir: C:/Progams/MySQL/MySQL Server 5.1/lib/opt
-- MySQL CFLAGS:
-- MySQL Link flags:
-- MySQL Include dir: C:/Progams/MySQL/MySQL Server 5.1/include
-- MySQL Library dir: C:/Progams/MySQL/MySQL Server 5.1/lib/opt
-- MySQL CFLAGS:
-- MySQL Link flags:
-- Configuring cppconn
-- Configuring test cases
-- Looking for isinf
-- Looking for isinf - not found

```

```

-- Looking for isinf
-- Looking for isinf - not found.
-- Looking for finite
-- Looking for finite - not found.
-- Configuring C/J junit tests port
-- Configuring examples
-- Configuring done
-- Generating done
-- Build files have been written to: C:\path_to_mysql_cpp
C:\path_to_mysql_cpp>dir *.sln *.vcproj
[... ]
19.11.2008  12:16          23.332  MYSQLCPPCONN.sln
[... ]
19.11.2008  12:16          27.564  ALL_BUILD.vcproj
19.11.2008  12:16          27.869  INSTALL.vcproj
19.11.2008  12:16          28.073  PACKAGE.vcproj
19.11.2008  12:16          27.495  ZERO_CHECK.vcproj

```

## NMake

```

C:\path_to_mysql_cpp>cmake -G "NMake Makefiles"
-- The C compiler identification is MSVC
-- The CXX compiler identification is MSVC
[... ]
-- Build files have been written to: C:\path_to_mysql_cpp

```

2. Use your compiler to build MySQL Connector/C++

### Visual Studio - GUI

Open the newly generated project files in the Visual Studio GUI or use a Visual Studio command line to build the driver. The project files contain a variety of different configurations. Among them debug and non-debug versions.

### Visual Studio - NMake

```

C:\path_to_mysql_cpp>nmake

Microsoft (R) Program Maintenance Utility Version 9.00.30729.01
Copyright (C) Microsoft Corporation. All rights reserved.

Scanning dependencies of target mysqlcppconn
[ 2%] Building CXX object driver/CMakeFiles/mysqlcppconn.dir/mysql_connection.obj
mysql_connection.cpp
[... ]
Linking CXX executable statement.exe
[100%] Built target statement

```

## 20.6.3. MySQL Connector/C++ Building Windows applications with Microsoft Visual Studio

MySQL Connector/C++ is available as a static or dynamic library to use with your application. This section looks at how to link the library to your application.

### Note

To avoid potential crashes the build configuration of MySQL Connector/C++ should match the build configuration of the application using it. For example, do not use the release build of MySQL Connector/C++ with a debug build of the client application.

### Static library

The MySQL Connector/C++ static library file is `mysqlcppconn-static.lib`. This needs to be statically linked with your application. You also need to link against the files `libmysql.dll` and `libmysql.lib`. Once linking has been successfully completed, the application will require access to `libmysql.dll` at run time.

### Dynamic library

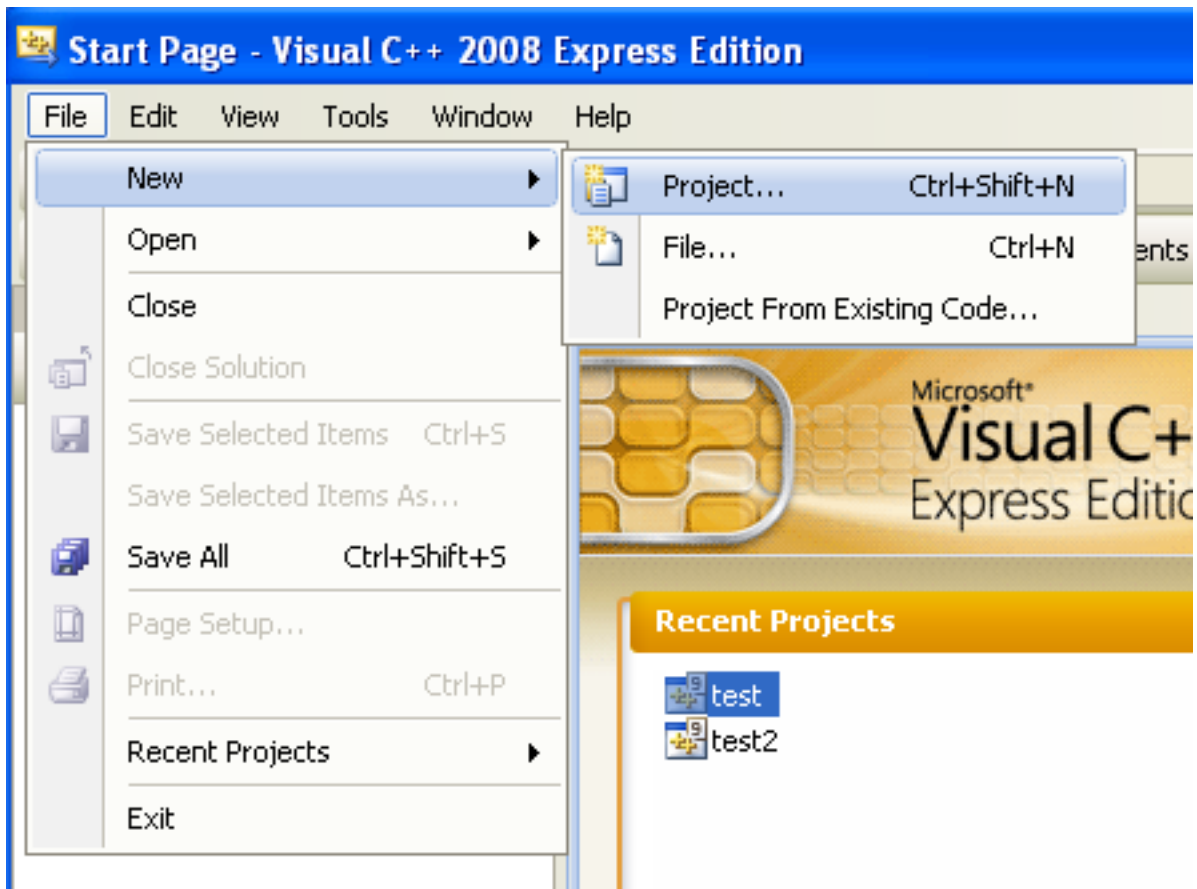
The MySQL Connector/C++ dynamic library file is `mysqlcppconn.dll`. In order to build your client application you need to link it with the file `mysqlcppconn.lib`. At run time the application will require access to the files `mysqlcppconn.dll` and `libmysql.dll`.

### Building a MySQL Connector/C++ application with Microsoft Visual Studio

Initially, the procedure for building an application to use either the static or dynamic library is the same. You then carry out some additional steps depending on whether you want to build your application to use the [static](#) or [dynamic](#) library.

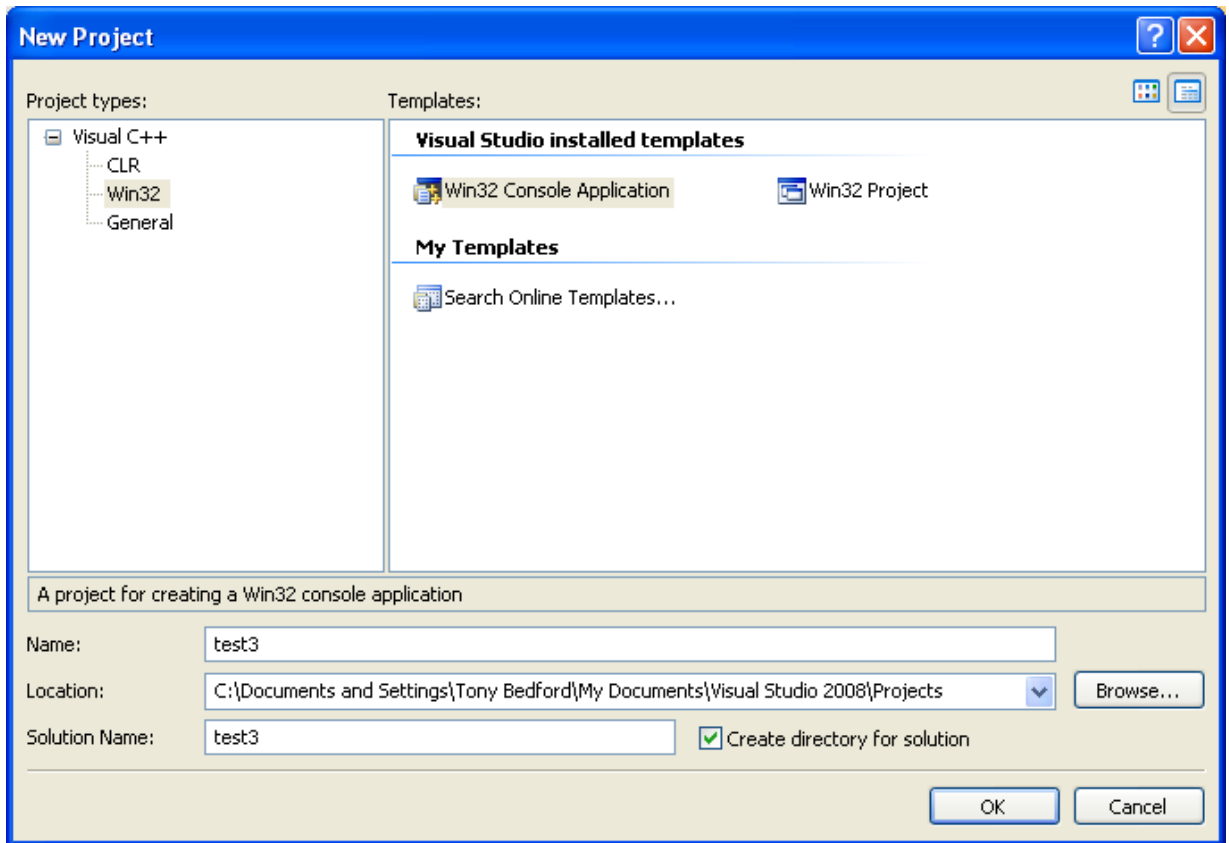
1. Select **FILE**, **NEW**, **PROJECT** from the main menu.

**Figure 20.43. Creating a new project**



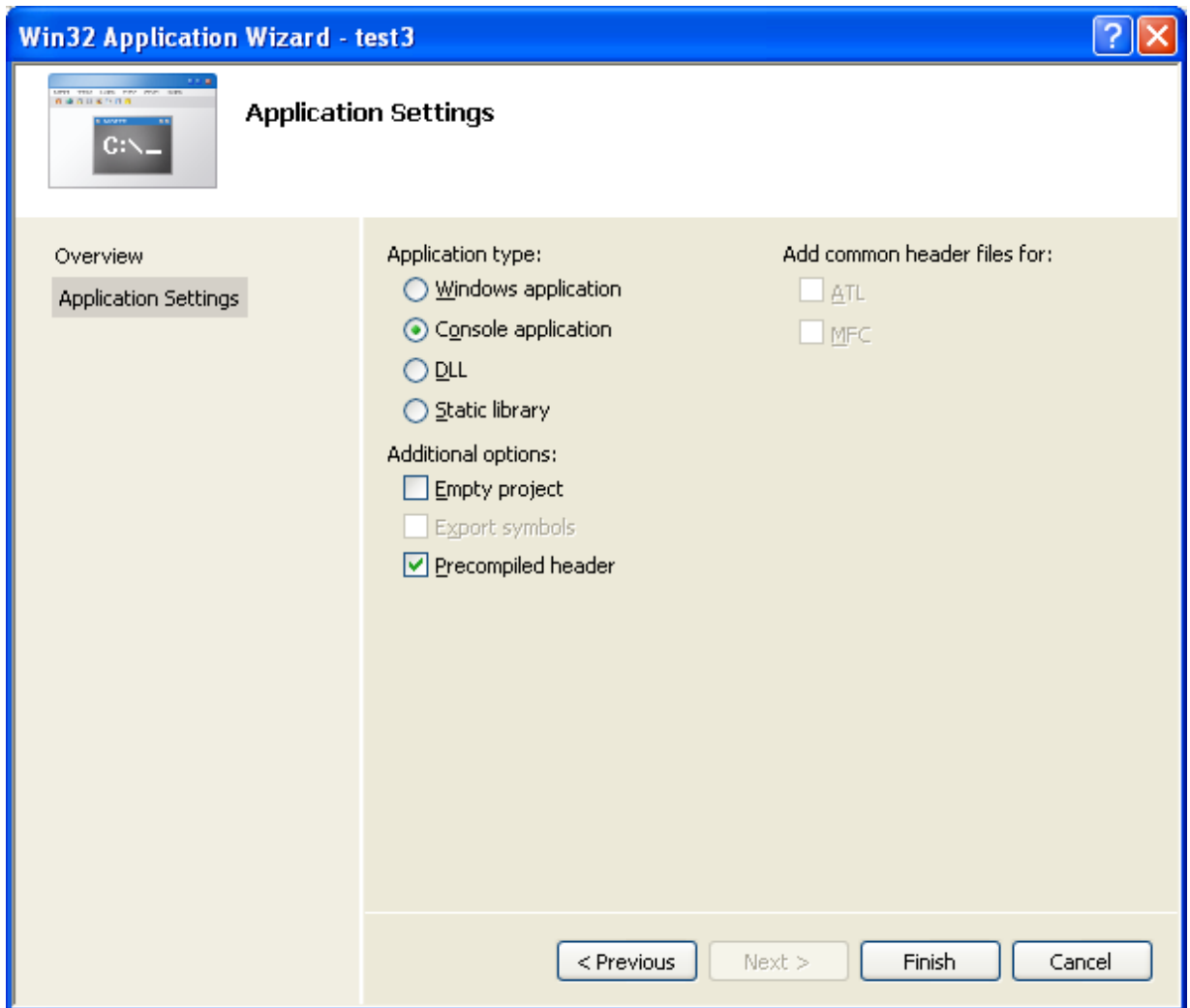
2. In the wizard select **VISUAL C++**, **WIN32**. From **VISUAL STUDIO INSTALLED TEMPLATES** select the application type **WIN32 CONSOLE APPLICATION**. Enter a name for the application, and then click **OK**, to move to the Win32 Application Wizard.

**Figure 20.44. The New Project dialog box**



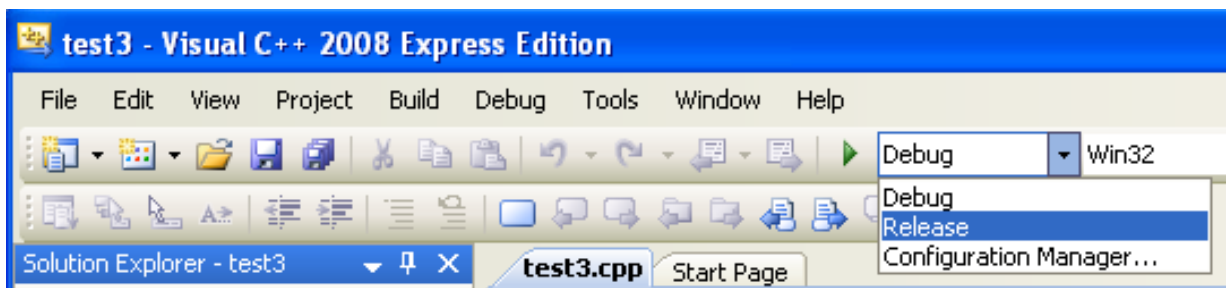
3. In the Win32 Application Wizard, click on **APPLICATION SETTINGS** and ensure the defaults are selected. The radio button **CONSOLE APPLICATION**, and the checkbox **PRECOMPILED HEADERS** will be selected. Click **FINISH** to close the wizard.

**Figure 20.45. The Win32 Application Wizard**



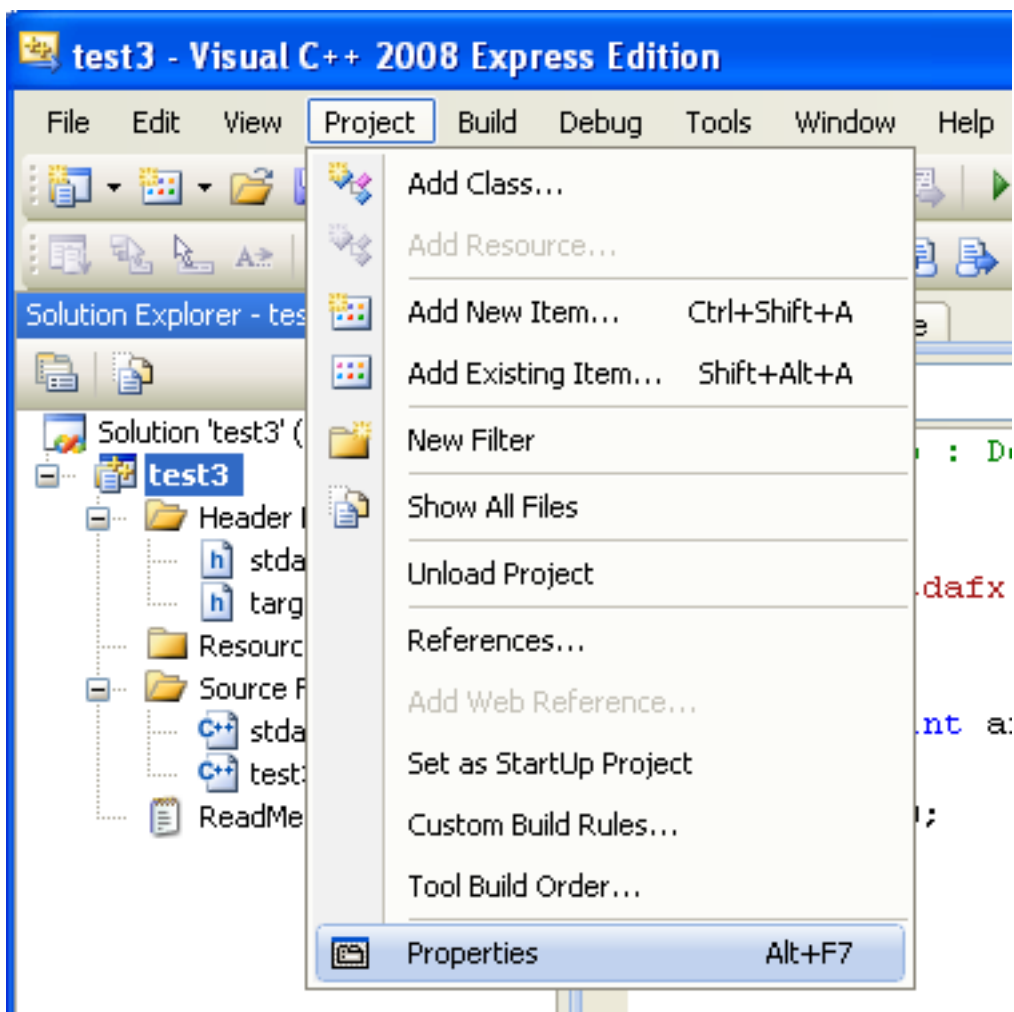
4. From the drop down list box on the toolbar, change from the default **DEBUG** build to the **RELEASE** build.

**Figure 20.46. Selecting the Release build**



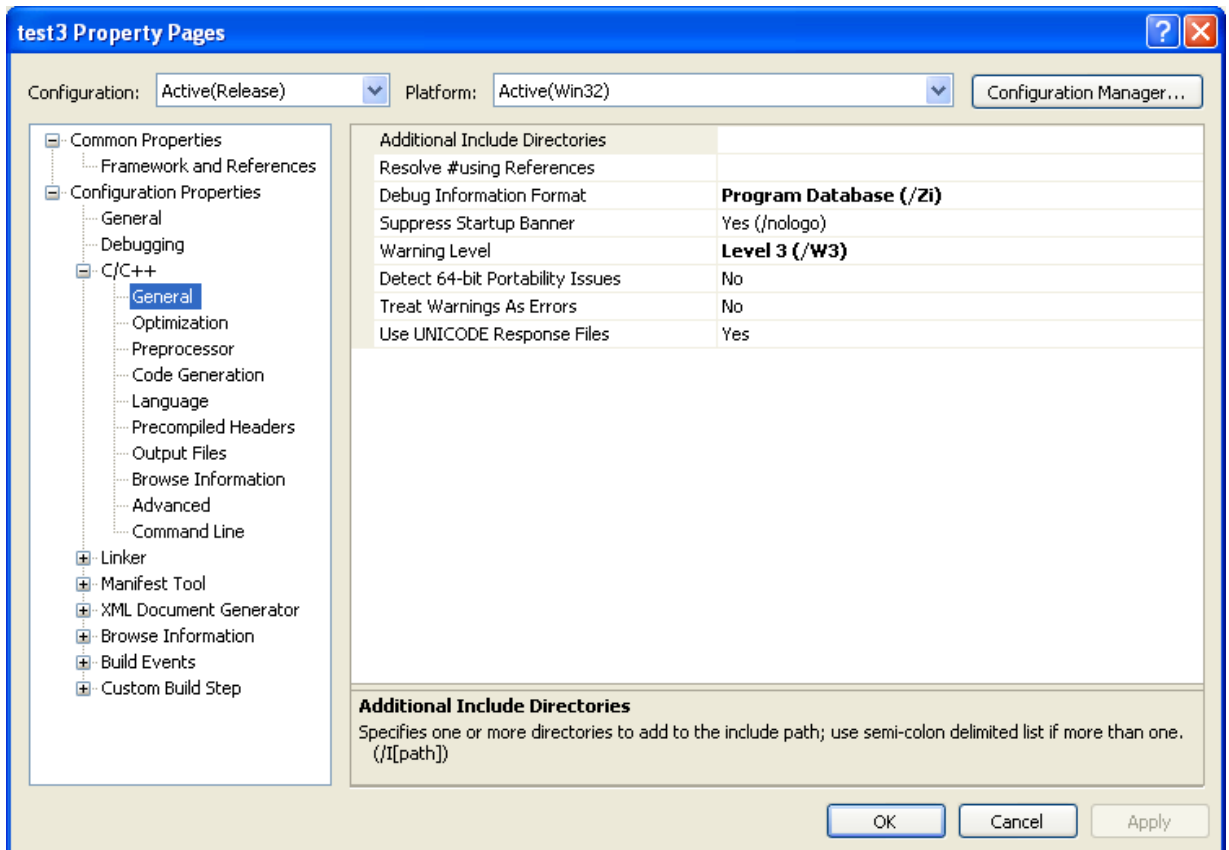
5. From the main menu select **PROJECT, PROPERTIES**. This can also be accessed using the hot key ALT + F7.

**Figure 20.47. Selecting Project Properties from the main menu**



6. Under **CONFIGURATION PROPERTIES**, open the tree view.
7. Select **C++**, **GENERAL** in the tree view.

**Figure 20.48. Setting properties**



8. You now need to ensure that Visual Studio can find the MySQL include directory. This directory includes header files that can optionally be installed when installing MySQL Server.

**Figure 20.49. MySQL include directory**

```

C:\mysql\include>dir
Volume in drive C has no label.
Volume Serial Number is 9484-B7C3

Directory of C:\mysql\include

10/12/2008  13:56    <DIR>          .
10/12/2008  13:56    <DIR>          ..
15/11/2008  06:53           10,935  config-win.h
15/11/2008  06:53           4,058  decimal.h
15/11/2008  06:53           3,854  errmsg.h
15/11/2008  06:53           6,954  keycache.h
15/11/2008  06:53           2,819  libmysql.def
10/12/2008  13:56    <DIR>          mysql
15/11/2008  06:53          33,654  mysql.h
15/11/2008  06:53          23,155  mysqld_ename.h
15/11/2008  06:53          23,212  mysqld_error.h
15/11/2008  06:53          20,174  mysql_com.h
15/11/2008  06:53           1,130  mysql_embed.h
15/11/2008  06:53           2,097  mysql_time.h
15/11/2008  06:53           860    mysql_version.h
15/11/2008  06:53           1,804  my_alloc.h
15/11/2008  06:53           1,941  my_attribute.h
15/11/2008  06:53           4,576  my_dbg.h
15/11/2008  06:53           3,460  my_dir.h
15/11/2008  06:53           3,278  my_getopt.h
15/11/2008  06:53          50,497  my_global.h
15/11/2008  06:53           1,488  my_list.h
15/11/2008  06:53           3,656  my_net.h
15/11/2008  06:53           1,542  my_no_pthread.h
15/11/2008  06:53          26,468  my_pthread.h
15/11/2008  06:53          40,097  my_sys.h
15/11/2008  06:53           2,677  my_xml.h
15/11/2008  06:53          22,584  mctype.h
15/11/2008  06:53           8,256  mstring.h
15/11/2008  06:53           1,957  sql_common.h
15/11/2008  06:53          12,484  sql_state.h
15/11/2008  06:53           1,006  sslopt-case.h
15/11/2008  06:53           2,205  sslopt-longopts.h
15/11/2008  06:53           1,107  sslopt-vars.h
15/11/2008  06:53           1,501  typelib.h
          32 File(s)              325,486 bytes
           3 Dir(s)      4,091,248,640 bytes free

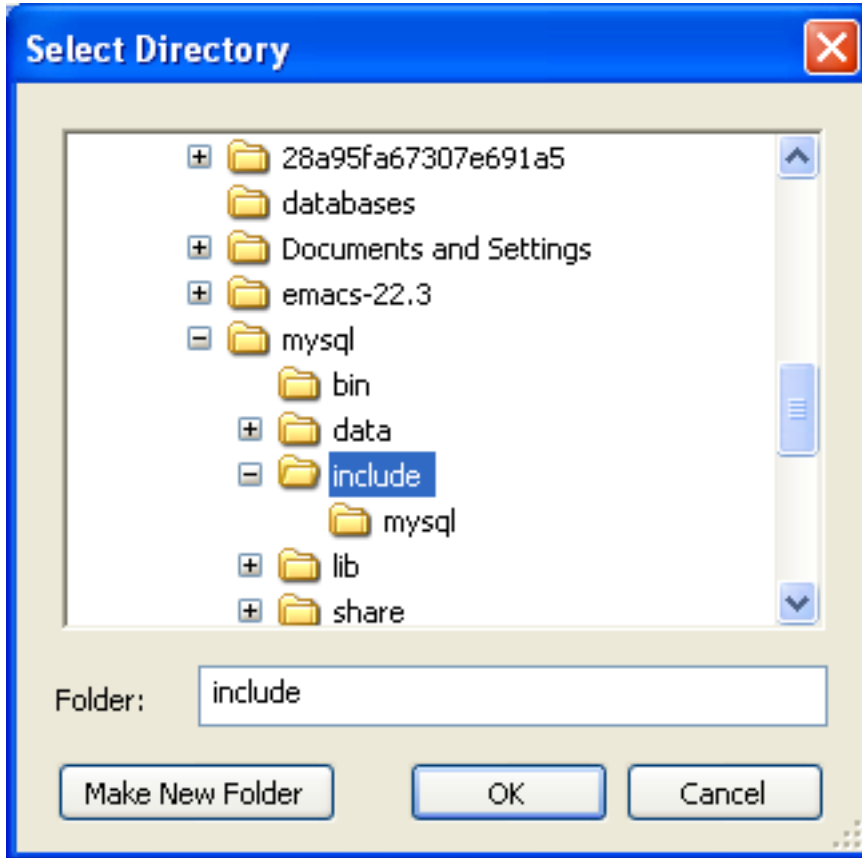
C:\mysql\include>

```

- Then in the **ADDITIONAL INCLUDE DIRECTORIES** text field, add the MySQL `include/` directory.

**Figure 20.50. Select Directory dialog**





10. You will also need to set the location of additional libraries that Visual Studio will need in order to build the application. These are located in the MySQL `lib/opt` directory, a sub-directory of the MySQL Server installation directory.

**Figure 20.51. Typical contents of MySQL `lib/opt` directory**

```

c:\ Command Prompt

C:\mysql\lib\opt>dir
Volume in drive C has no label.
Volume Serial Number is 9484-B7C3

Directory of C:\mysql\lib\opt

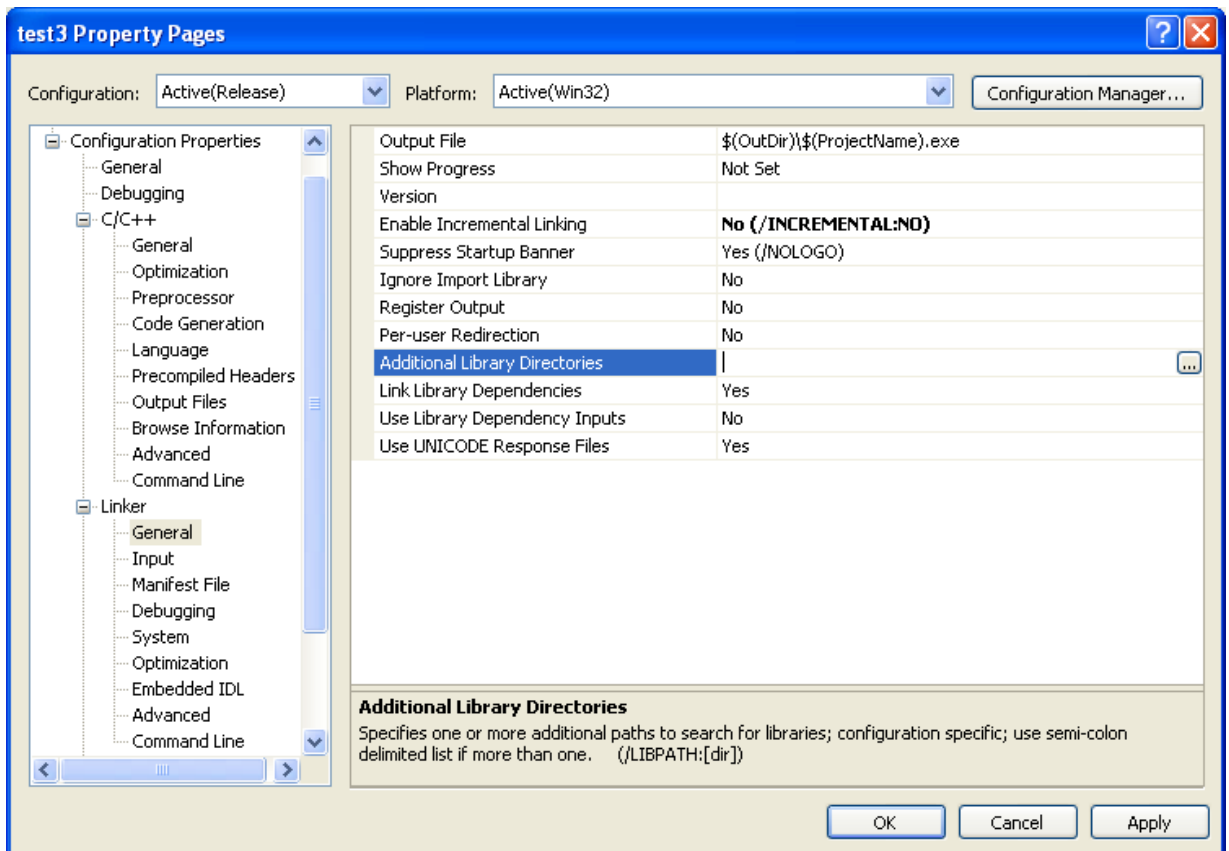
10/12/2008  13:56    <DIR>          .
10/12/2008  13:56    <DIR>          ..
15/11/2008  06:53             34,876  libmysql.lib
15/11/2008  06:53      6,590,464 libmysql.pdb
15/11/2008  06:53      7,710,426 mysqlclient.lib
15/11/2008  06:53      397,312  mysqlclient.pdb
15/11/2008  06:53      2,675,708 mysys.lib
15/11/2008  06:53       135,168 mysys.pdb
15/11/2008  06:53      235,420  regex.lib
15/11/2008  06:53       77,824  regex.pdb
15/11/2008  06:53      2,566,162 strings.lib
15/11/2008  06:53       86,016  strings.pdb
15/11/2008  06:53      202,226  zlib.lib
15/11/2008  06:53       69,632  zlib.pdb
           12 File(s)      20,781,234 bytes
           2 Dir(s)    4,091,240,448 bytes free

C:\mysql\lib\opt>_

```

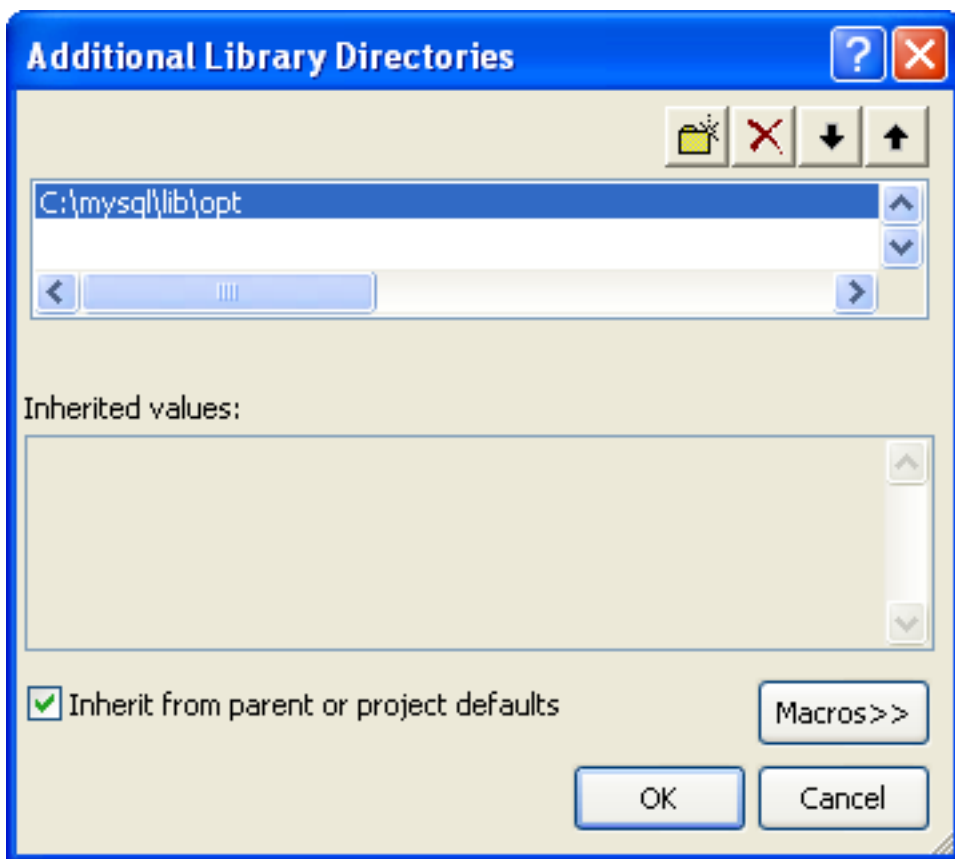
11. In the tree view open **LINKER, GENERAL, ADDITIONAL LIBRARY DIRECTORIES**.

Figure 20.52. Additional Library Directories



12. Add the `lib/opt` directory into the **ADDITIONAL LIBRARY DIRECTORIES** text field. This allows the library file `libmysql.lib` to be found.

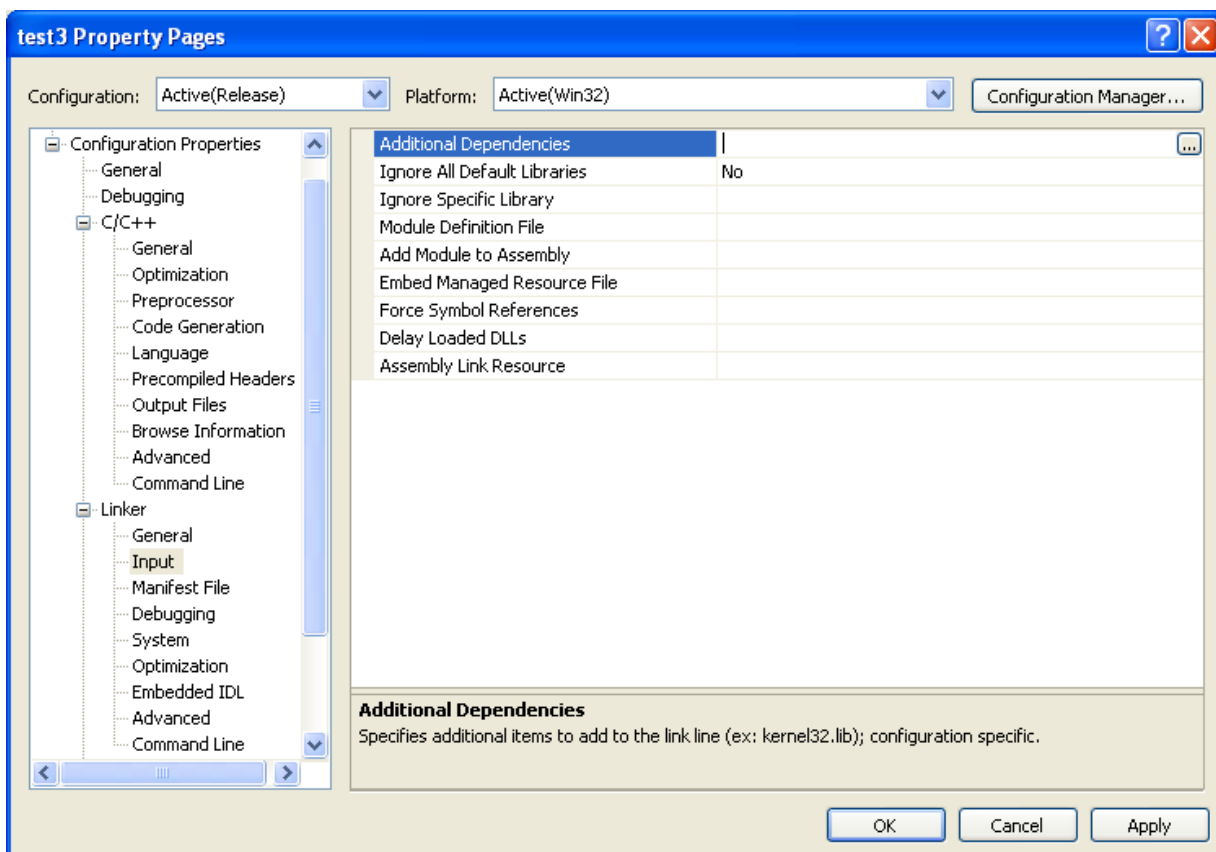
Figure 20.53. Additional Library Directories dialog



The remaining steps depend on whether you are building an application to use the MySQL Connector/C++ static or dynamic library. If you are building your application to use the dynamic library [go here](#). If you are building your application to use the static library, carry out the following steps:

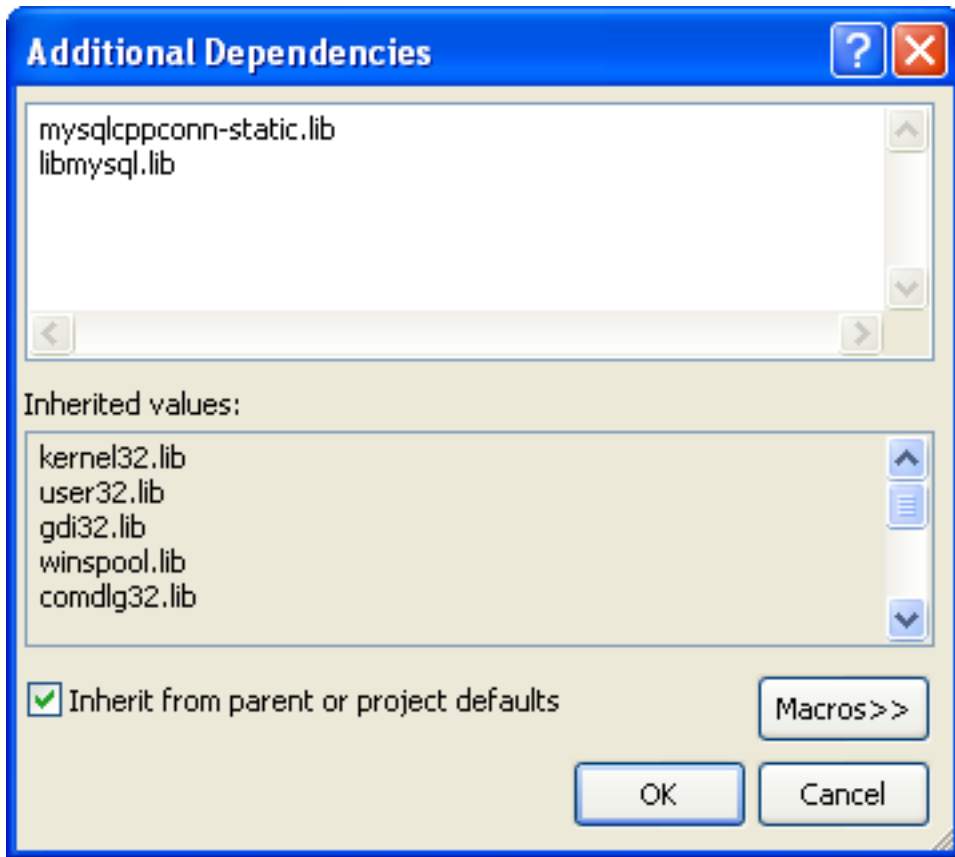
1. Then open **LINKER, INPUT, ADDITIONAL DEPENDENCIES**.

**Figure 20.54.**



2. Enter `mysqlcppconn-static.lib` and `libmysql.lib`.

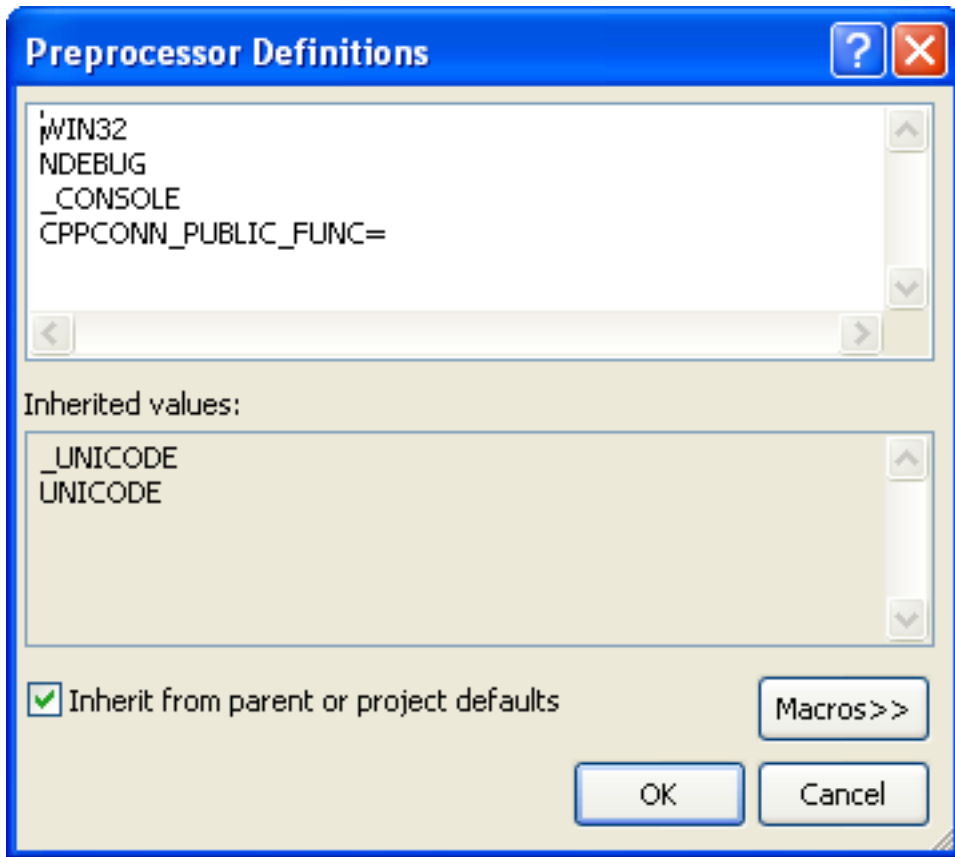
**Figure 20.55. Adding additional dependencies**



3. By default `CPPCONN_PUBLIC_FUNC` is defined to declare functions to be compatible with an application that calls a DLL. If building an application to call the static library, you must ensure that function prototypes are compatible with this. In this case `CPPCONN_PUBLIC_FUNC` needs to be defined to be an empty string, so that functions are declared with the correct prototype.

In the **PROJECT, PROPERTIES** tree view, under **C++**, **PREPROCESSOR**, enter `CPPCONN_PUBLIC_FUNC=` into the **PREPROCESSOR DEFINITIONS** text field.

**Figure 20.56. Setting the `CPPCONN_PUBLIC_FUNC` define**



### Note

Make sure you enter `CPPCONN_PUBLIC_FUNC=` and not `CPPCONN_PUBLIC_FUNC`, as it needs to be defined as an empty string.

If building an application to use the MySQL Connector/C++ dynamically linked library carry out these steps:

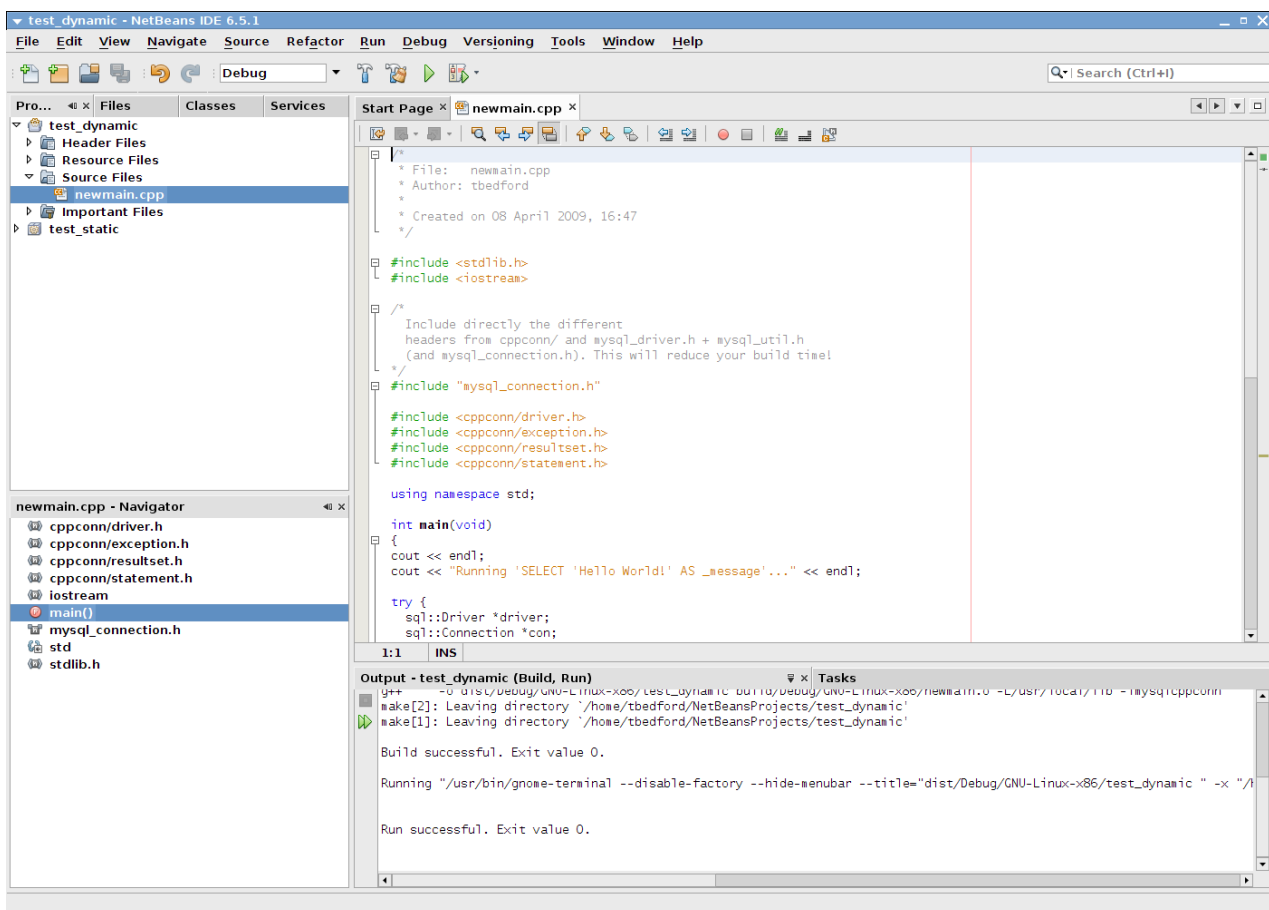
1. Under **LINKER, INPUT**, add `mysqlcppconn.lib` into the **ADDITIONAL DEPENDENCIES** text field.
2. The application will need to access the MySQL Connector/C++ Dynamic Linked Library at run time. Therefore, `mysqlcppconn.dll` needs to be in the same directory as the application executable, or somewhere on the system's path.

Copy `mysqlcppconn.dll` to the same directory as the application. Alternatively, extend the `PATH` environment variable using `SET PATH=%PATH%;C:\path\to\cpp`. Alternatively, you can copy `mysqlcppconn.dll` to the Windows installation Directory, typically `c:\windows`.

## 20.6.4. MySQL Connector/C++ Building Linux applications with NetBeans

This section describes how you can build MySQL Connector/C++ applications for Linux using the NetBeans IDE.

**Figure 20.57. The NetBeans IDE**

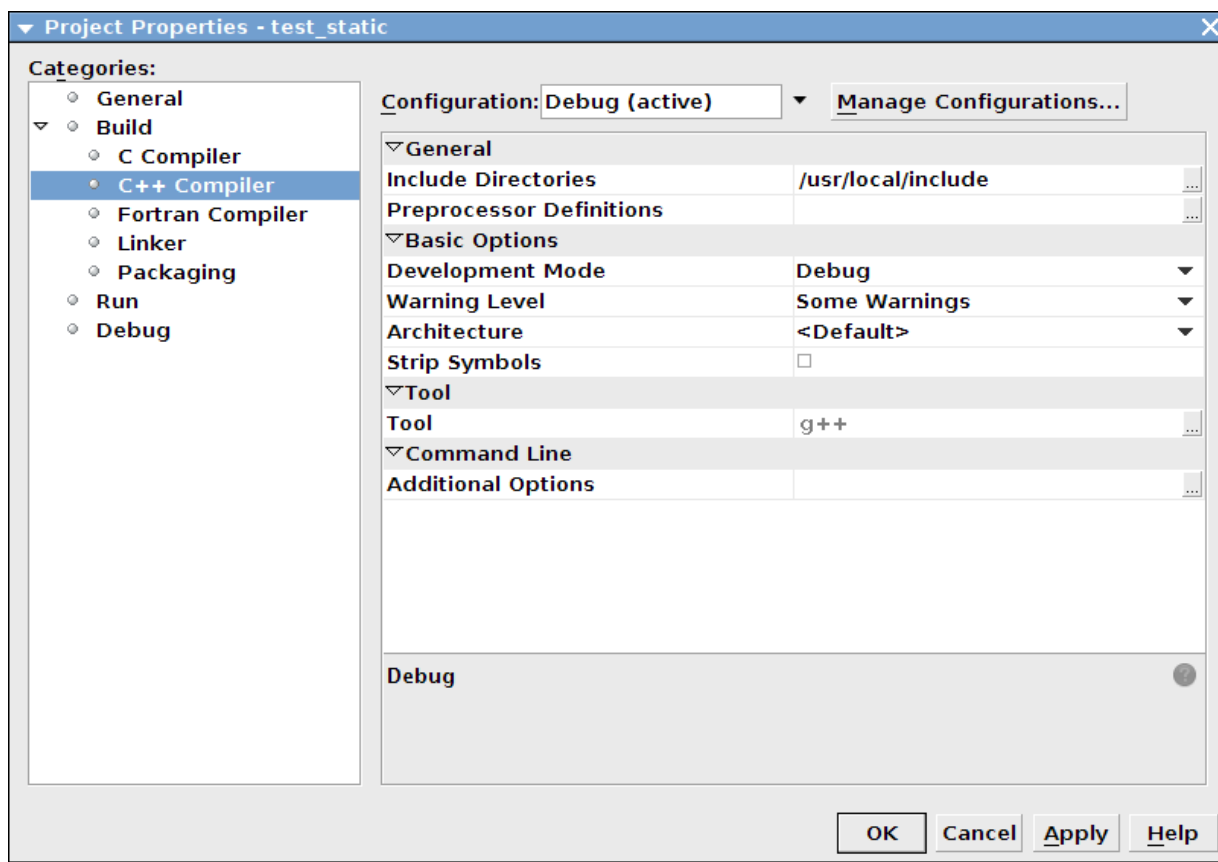


## Note

To avoid potential crashes the build configuration of MySQL Connector/C++ should match the build configuration of the application using it. For example, do not use the release build of MySQL Connector/C++ with a debug build of the client application.

1. The first step of building your application is to create a new project. Select **FILE, NEW PROJECT**. Choose a **C/C++ APPLICATION** and click **NEXT**.
2. Give the project a name and click **FINISH**. A new project is created.
3. In the **PROJECTS** tab, right-click on **SOURCE FILES** and select **NEW**, then **MAIN C++ FILE...**
4. Change the filename, or simply select the defaults and click **FINISH** to add the new file to the project.
5. You now need to add some working code to your main source file. Explore your MySQL Connector/C++ installation and navigate to the [examples](#) directory.
6. Select a suitable example such as [standalone\\_example\\_docs1.cpp](#). Copy all the code in this file, and use it to replace the code in your existing main source file. Amend the code to reflect the connection properties required for your test database. You now have a working example that will access a MySQL database using MySQL Connector/C++.
7. You will notice that at this point NetBeans is showing some errors in the source code. This is because you need to direct NetBeans to the necessary header files that need to be included. Select **FILE, PROJECT PROPERTIES** from the main menu.
8. In the **CATEGORIES:** tree view panel, navigate to **BUILD, C++ COMPILER**.
9. In the **GENERAL** panel, select **INCLUDE DIRECTORIES**.
10. Click the **...** button.
11. Click **ADD** and then navigate to the directory where the MySQL Connector/C++ header files are located. This will be [/usr/local/include](#) unless you have installed the files to a different location. Click **SELECT**. Click **OK**.

Figure 20.58. Setting the header include directory



12. Click OK again to close the **PROJECT PROPERTIES** dialog.

At this point you have created a NetBeans project, containing a single C++ source file. You have also ensured that the necessary include files are accessible. Before continuing, you need to decide whether your project is to use the MySQL Connector/C++ static or dynamic library. The project settings are slightly different in each case, as you need to link against a different library.

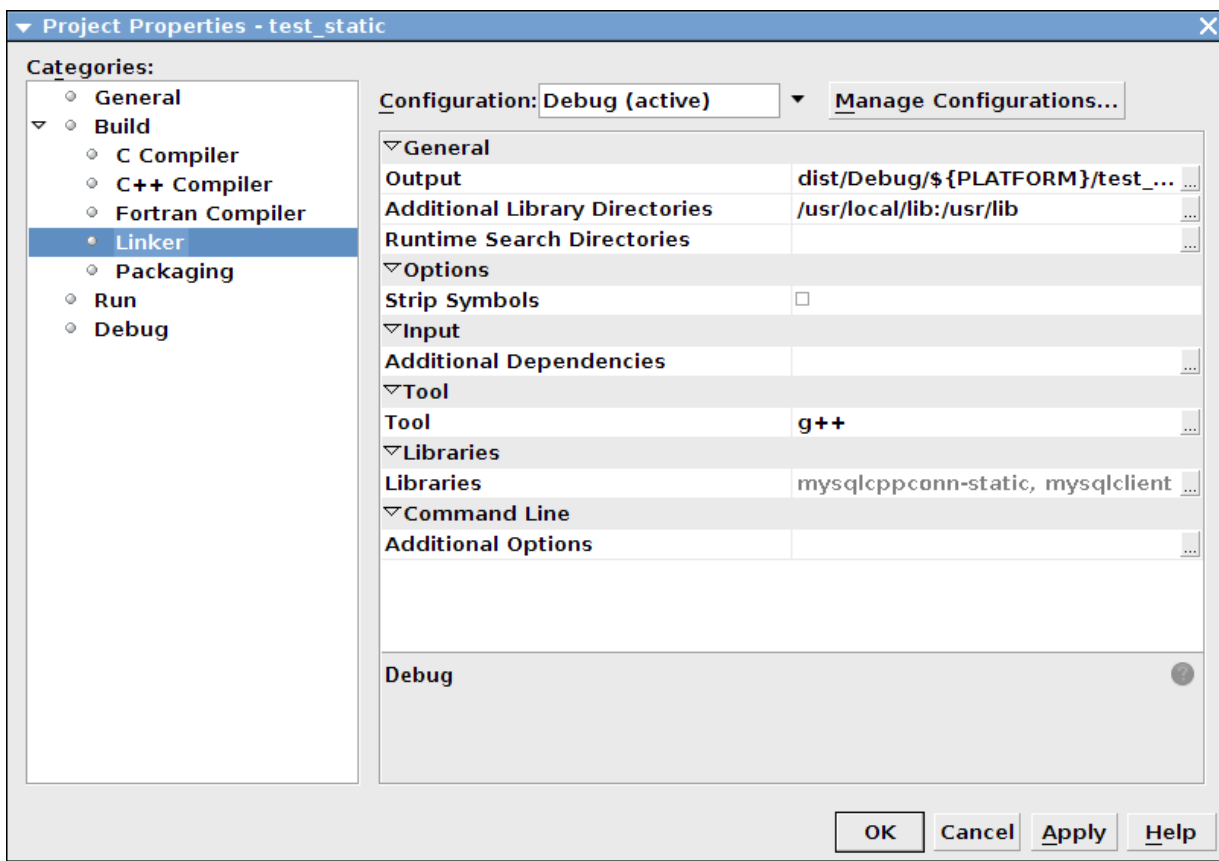
#### Using the static library

If you intend to use the static library you will need to link against two library files, `libmysqlcppconn-static.a` and `libmysqlclient.a`. The locations of the files will depend on your setup, but typically the former will be found in `/usr/local/lib` and the latter in `/usr/lib`. Note the file `libmysqlclient.a` is not part of MySQL Connector/C++, but is the MySQL Client Library file distributed with MySQL Server. Remember, the MySQL Client Library is an optional component as part of the MySQL Server installation process. Note the MySQL Client Library is also available as part of the new MySQL Connector/C distribution.

1. The first step is to set the project to link the necessary library files. Select **FILE, PROJECT PROPERTIES** from the main menu.
2. In the **CATEGORIES:** tree view navigate to **LINKER**.
3. In the **GENERAL** panel select **ADDITIONAL LIBRARY DIRECTORIES**. Click the ... button.
4. Select and add the `/usr/lib` and `/usr/local/lib` directories.
5. In the same panel add the two library files required for static linking as discussed earlier. The properties panel should then look similar to the following screenshot:

Figure 20.59. Setting the static library directories and file names





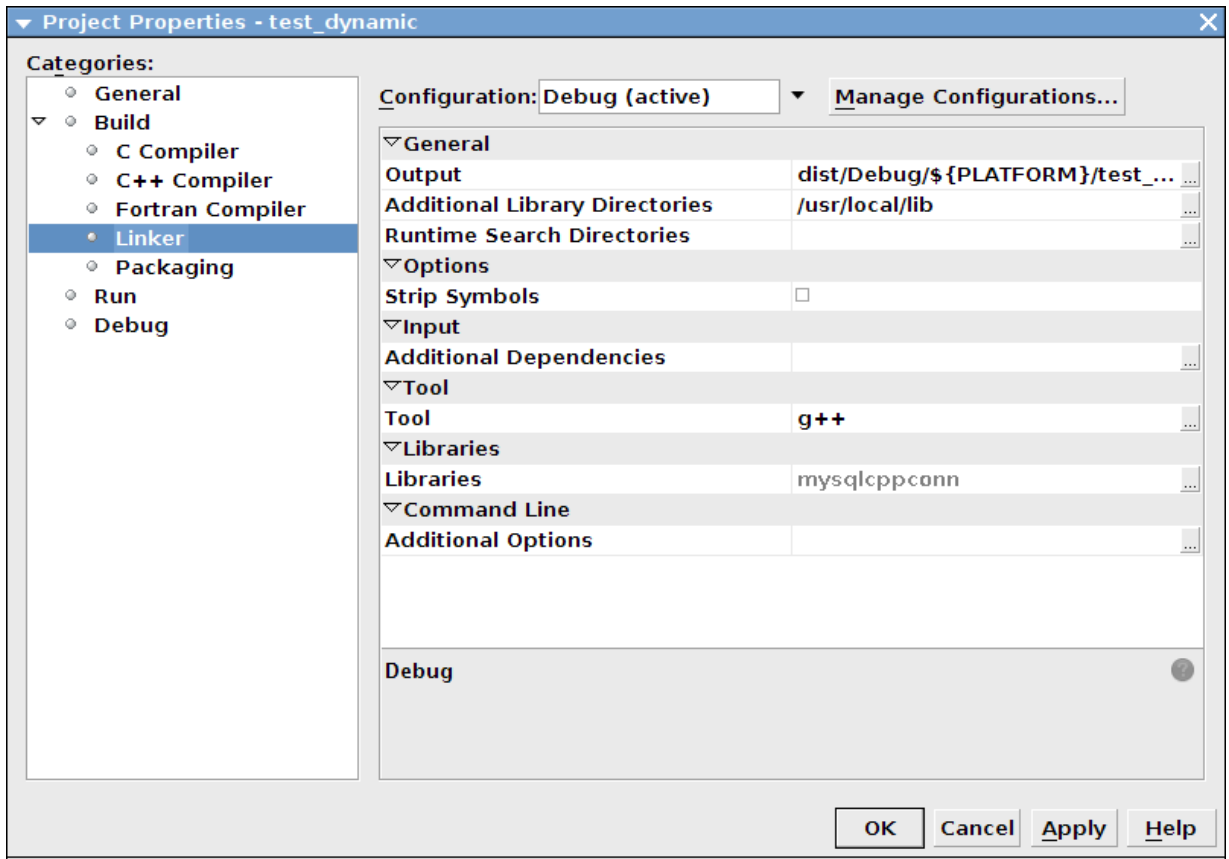
6. Click OK to close the **PROJECT PROPERTIES** dialog.

### Using the dynamic library

If you require your application to use the MySQL Connector/C++ dynamic library, you simply need to link your project with a single library file, `libmysqlcppconn.so`. The location of this file will depend on how you configured your installation of MySQL Connector/C++, but will typically be `/usr/local/lib`.

1. The first step is to set the project to link the necessary library file. Select **FILE, PROJECT PROPERTIES** from the main menu.
2. In the **CATEGORIES:** tree view navigate to **LINKER**.
3. In the **GENERAL** panel select **ADDITIONAL LIBRARY DIRECTORIES**. Click the ... button.
4. Select and add the `/usr/local/lib` directories.
5. In the same panel add the library file required for static linking as discussed earlier. The properties panel should then look similar to the following screenshot:

**Figure 20.60. Setting the dynamic library directory and file name**

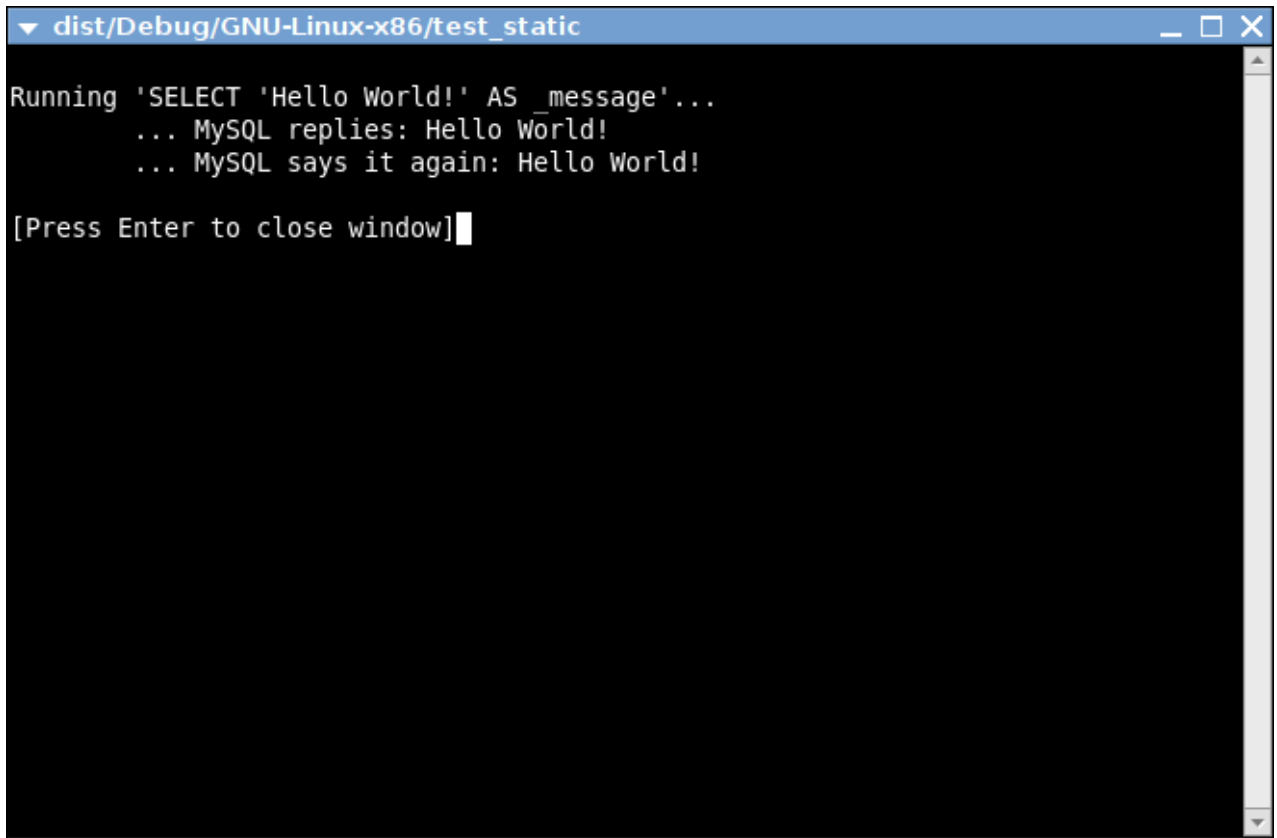


6. Click OK to close the Project Properties dialog.

Having configured your project you can build it by selecting **RUN, BUILD MAIN PROJECT** from the main menu. You can then run the project using **RUN, RUN MAIN PROJECT**.

On running the application you should see a screen similar to the following (this is actually the static version of the application shown):

**Figure 20.61. The example application running**

A terminal window titled 'dist/Debug/GNU-Linux-x86/test\_static' with a black background and white text. The text shows the execution of a MySQL query: 'SELECT 'Hello World!' AS \_message'...'. The output shows 'MySQL replies: Hello World!' and 'MySQL says it again: Hello World!'. At the bottom, it says '[Press Enter to close window]' with a cursor.

```
dist/Debug/GNU-Linux-x86/test_static
Running 'SELECT 'Hello World!' AS _message'...
... MySQL replies: Hello World!
... MySQL says it again: Hello World!

[Press Enter to close window]
```

**Note**

Note the above settings and procedures were carried out for the default [Debug](#) configuration. If you want to create a [Release](#) configuration you will need to select that configuration before setting the Project Properties.

## 20.6.5. MySQL Connector/C++ Getting Started: Usage Examples

**Caution**

Please note, official support is not available for the beta version of MySQL Connector/C++.

The download package contains usage examples in the directory [examples/](#). The examples explain the basic usage of the following classes:

- [Connection](#)
- [Driver](#)
- [PreparedStatement](#)
- [ResultSet](#)
- [ResultSetMetaData](#)
- [Statement](#)

The examples cover:

- Using the [Driver](#) class to connect to MySQL
- Creating tables, inserting rows, fetching rows using (simple) statements
- Creating tables, inserting rows, fetching rows using prepared statements

- Hints for working around prepared statement limitations
- Accessing result set meta data

The examples in this document are only code snippets. The code snippets provide a brief overview on the API. They are not complete programs. Please check the `examples/` directory of your MySQL Connector/C++ installation for complete programs. Please also read the `README` file in the `examples/` directory. Note to test the example code you will first need to edit the `examples.h` file in the `examples/` directory, to add your connection information. Then simply rebuild the code by issuing a `make` command.

The examples in the `examples/` directory include:

- `examples/connect.cpp`:  
How to create a connection, insert data into MySQL and handle exceptions.
- `examples/connection_meta_schemaobj.cpp`:  
How to obtain meta data associated with a connection object, for example, a list of tables, databases, MySQL version, connector version.
- `examples/debug.cpp`:  
How to activate and deactivate the MySQL Connector/C++ debug protocol.
- `examples/exceptions.cpp`:  
A closer look at the exceptions thrown by the connector and how to fetch error information.
- `examples/prepared_statements.cpp`:  
How to run Prepared Statements including an example how to handle SQL commands that cannot be prepared by the MySQL Server.
- `examples/resultset.cpp`:  
How to fetch data and iterate over the result set (cursor).
- `examples/resultset_meta.cpp`:  
How to obtain meta data associated with a result set, for example, number of columns and column types.
- `examples/resultset_types.cpp`:  
Result sets returned from meta data methods - this is more a test than much of an example.
- `examples/standalone_example.cpp`:  
Simple standalone program not integrated into regular CMake builds.
- `examples/statements.cpp`:  
How to run SQL commands without using Prepared Statements.
- `examples/cpp_trace_analyzer.cpp`:  
This example shows how to filter the output of the `debug trace`. Please see the inline comments for further documentation. This script is unsupported.

### 20.6.5.1. MySQL Connector/C++ Connecting to MySQL

A connection to MySQL is established by retrieving an instance of `sql::Connection` from a `sql::mysql::MySQL_Driver` object. A `sql::mysql::MySQL_Driver` object is returned by `sql::mysql::MySQL_Driver::get_mysql_driver_instance()`.

```
sql::mysql::MySQL_Driver *driver;
sql::Connection *con;

driver = sql::mysql::MySQL_Driver::get_mysql_driver_instance();
con = driver->connect("tcp://127.0.0.1:3306", "user", "password");
```

```
delete con;
```

Make sure that you free the `sql::Connection` object as soon as you do not need it any more. But do not explicitly free the connector object!

### 20.6.5.2. MySQL Connector/C++ Running a simple query

For running simple queries you can use the methods `sql::Statement::execute()`, `sql::Statement::executeQuery()` and `sql::Statement::executeUpdate()`. The method `sql::Statement::execute()` should be used if your query does not return a result set or if your query returns more than one result set. See the `examples/` directory for more on this.

```
sql::mysql::MySQL_Driver *driver;
sql::Connection *con;
sql::Statement *stmt

driver = sql::mysql::get_mysql_driver_instance();
con = driver->connect("tcp://127.0.0.1:3306", "user", "password");

stmt = con->createStatement();
stmt->execute("USE " EXAMPLE_DB);
stmt->execute("DROP TABLE IF EXISTS test");
stmt->execute("CREATE TABLE test(id INT, label CHAR(1))");
stmt->execute("INSERT INTO test(id, label) VALUES (1, 'a')");

delete stmt;
delete con;
```

Note that you have to free `sql::Statement` and `sql::Connection` objects explicitly using `delete`.

### 20.6.5.3. MySQL Connector/C++ Fetching results

The API for fetching result sets is identical for (simple) statements and prepared statements. If your query returns one result set you should use `sql::Statement::executeQuery()` or `sql::PreparedStatement::executeQuery()` to run your query. Both methods return `sql::ResultSet` objects. The preview version does buffer all result sets on the client to support cursors.

```
// ...
sql::Connection *con;
sql::Statement *stmt
sql::ResultSet *res;
// ...
stmt = con->createStatement();
// ...

res = stmt->executeQuery("SELECT id, label FROM test ORDER BY id ASC");
while (res->next()) {
    // You can use either numeric offsets...
    cout << "id = " <&& res->getInt(0);
    // ... or column names for accessing results. »
    The latter is recommended.
    cout << ", label = '" <&& res->getString("label") << "' << endl;
}

delete res;
delete stmt;
delete con;
```

Note that you have to free `sql::Statement`, `sql::Connection` and `sql::ResultSet` objects explicitly using `delete`.

The usage of cursors is demonstrated in the examples contained in the download package.

### 20.6.5.4. MySQL Connector/C++ Using Prepared Statements

If you are not familiar with Prepared Statements on MySQL have an extra look at the source code comments and explanations in the file `examples/prepared_statement.cpp`.

`sql::PreparedStatement` is created by passing a SQL query to `sql::Connection::prepareStatement()`. As `sql::PreparedStatement` is derived from `sql::Statement`, you will feel familiar with the API once you have learned how to use (simple) statements (`sql::Statement`). For example, the syntax for fetching results is identical.

```
// ...
sql::Connection *con;
sql::PreparedStatement *prep_stmt
// ...

prep_stmt = con->prepareStatement("INSERT INTO test(id, label) VALUES (?, ?);");
```

```

prep_stmt->setInt(1, 1);
prep_stmt->setString(2, "a");
prep_stmt->execute();

prep_stmt->setInt(1, 2);
prep_stmt->setString(2, "b");
prep_stmt->execute();

delete prep_stmt;
delete con;

```

As usual, you have to free `sql::PreparedStatement` and `sql::Connection` objects explicitly.

### 20.6.5.5. MySQL Connector/C++ Complete Example 1

The following code shows a complete example of how to use MySQL Connector/C++:

```

/* Copyright 2008 Sun Microsystems, Inc.

This program is free software; you can redistribute it and/or modify
it under only the terms of the GNU General Public License as published by
the Free Software Foundation; version 2 of the License.

There are special exceptions to the terms and conditions of the GPL
as it is applied to this software. View the full text of the
exception in file EXCEPTIONS-CONNECTOR-C++ in the directory of this
software distribution.

This program is distributed in the hope that it will be useful,
but WITHOUT ANY WARRANTY; without even the implied warranty of
MERCHANTABILITY or FITNESS FOR A PARTICULAR PURPOSE. See the
GNU General Public License for more details.

You should have received a copy of the GNU General Public License
along with this program; if not, write to the Free Software
Foundation, Inc., 59 Temple Place, Suite 330, Boston, MA 02111-1307 USA
*/

/* Standard C++ includes */
#include <stdlib.h>
#include <iostream>

/*
   Include directly the different
   headers from cppconn/ and mysql_driver.h + mysql_util.h
   (and mysql_connection.h). This will reduce your build time!
*/
#include "mysql_connection.h"

#include <cppconn/driver.h>
#include <cppconn/exception.h>
#include <cppconn/resultset.h>
#include <cppconn/statement.h>

using namespace std;

int main(void)
{
    cout << endl;
    cout << "Running 'SELECT 'Hello World!' AS _message' >
        AS _message'..." << endl;

    try {
        sql::Driver *driver;
        sql::Connection *con;
        sql::Statement *stmt;
        sql::ResultSet *res;

        /* Create a connection */
        driver = get_driver_instance();
        con = driver->connect("tcp://127.0.0.1:3306", "root", "root");
        /* Connect to the MySQL test database */
        con->setSchema("test");

        stmt = con->createStatement();
        res = stmt->executeQuery("SELECT 'Hello World!' AS _message");
        while (res->next()) {
            cout << "\t... MySQL replies: ";
            /* Access column data by alias or column name */
            cout << res->getString("_message") << endl;
            cout << "\t... MySQL says it again: ";
            /* Access column data by numeric offset, 1 is the first column */
            cout << res->getString(1) << endl;
        }
        delete res;
        delete stmt;
        delete con;
    } catch (sql::SQLException &e) {
        cout << "# ERR: SQLException in " << __FILE__;
        cout << "(" << __FUNCTION__ << ") on line " <<
            << __LINE__ << endl;
        cout << "# ERR: " << e.what();
    }
}

```

```

    cout << " (MySQL error code: " << e.getErrorCode();
    cout << ", SQLState: " << e.getSQLState() << ") " << endl;
}

cout << endl;

return EXIT_SUCCESS;
}

```

## 20.6.5.6. MySQL Connector/C++ Complete Example 2

The following code shows a complete example of how to use MySQL Connector/C++:

```

/* Copyright 2008 Sun Microsystems, Inc.

This program is free software; you can redistribute it and/or modify
it under the terms of the GNU General Public License as published by
the Free Software Foundation; version 2 of the License.

There are special exceptions to the terms and conditions of the GPL
as it is applied to this software. View the full text of the
exception in file EXCEPTIONS-CONNECTOR-C++ in the directory of this
software distribution.

This program is distributed in the hope that it will be useful,
but WITHOUT ANY WARRANTY; without even the implied warranty of
MERCHANTABILITY or FITNESS FOR A PARTICULAR PURPOSE. See the
GNU General Public License for more details.

You should have received a copy of the GNU General Public License
along with this program; if not, write to the Free Software
Foundation, Inc., 59 Temple Place, Suite 330, Boston, MA 02111-1307 USA
*/

/* Standard C++ includes */
#include <stdlib.h>
#include <iostream>

/*
   Include directly the different
   headers from cppconn/ and mysql_driver.h + mysql_util.h
   (and mysql_connection.h). This will reduce your build time!
*/
#include "mysql_connection.h"

#include <cppconn/driver.h>
#include <cppconn/exception.h>
#include <cppconn/resultset.h>
#include <cppconn/statement.h>
#include <cppconn/prepared_statement.h>

using namespace std;

int main(void)
{
    cout << endl;
    cout << "Let's have MySQL count from 10 to 1..." << endl;

    try {
        sql::Driver *driver;
        sql::Connection *con;
        sql::Statement *stmt;
        sql::ResultSet *res;
        sql::PreparedStatement *pstmt;

        /* Create a connection */
        driver = get_driver_instance();
        con = driver->connect("tcp://127.0.0.1:3306", "root", "root");
        /* Connect to the MySQL test database */
        con->setSchema("test");

        stmt = con->createStatement();
        stmt->execute("DROP TABLE IF EXISTS test");
        stmt->execute("CREATE TABLE test(id INT)");
        delete stmt;

        /* '?' is the supported placeholder syntax */
        pstmt = con->prepareStatement("INSERT INTO test(id) VALUES (?)");
        for (int i = 1; i <= 10; i++) {
            pstmt->setInt(1, i);
            pstmt->executeUpdate();
        }
        delete pstmt;

        /* Select in ascending order */
        pstmt = con->prepareStatement("SELECT id FROM test ORDER BY id ASC");
        res = pstmt->executeQuery();

        /* Fetch in reverse = descending order! */
        res->afterLast();
        while (res->previous())
            cout << "\t... MySQL counts: " << res->getInt("id") << endl;
        delete res;
    }
}

```

```

delete pstmt;
delete con;

} catch (sql::SQLException &e) {
cout << "# ERR: SQLException in " << __FILE__;
cout << "(" << __FUNCTION__ << ") on line " <<
    << __LINE__ << endl;
cout << "# ERR: " << e.what();
cout << " (MySQL error code: " << e.getErrorCode();
cout << ", SQLState: " << e.getSQLState() << "
    " )" << endl;
}

cout << endl;

return EXIT_SUCCESS;
}

```

## 20.6.6. MySQL Connector/C++ Debug Tracing

### Caution

Please note, official support is not available for the beta version of MySQL Connector/C++.

Although a debugger can be used to debug your application, you may find it beneficial to turn on the debug traces of the connector. Some problems happen randomly which makes them difficult to debug using a debugger. In such cases debug traces and protocol files are more useful because they allow you to trace the activities of all instances of your program.

DTrace is a very powerful technology to trace any application without having to develop an extra trace module for your application. Unfortunately, DTrace is currently only available on OpenSolaris, Solaris, MacOS 10.5 and FreeBSD.

The MySQL Connector/C++ can write two trace files:

1. Trace file generated by the MySQL Client Library
2. Trace file generated internally by MySQL Connector/C++

The first trace file can be generated by the underlying MySQL Client Library (libmysql). To enable this trace the connector will call the C-API function `mysql_debug()` internally. Only debug versions of the MySQL Client Library are capable of writing a trace file. Therefore you need to compile MySQL Connector/C++ against a debug version of the library, if you want utilize this trace. The trace shows the internal function calls and the addresses of internal objects as you can see below:

```

>mysql_stmt_init
|
|>_mymalloc
|   enter: Size: 816
|   exit: ptr: 0x68e7b8
|<_mymalloc |>init_alloc_root
|   enter: root: 0x68e7b8
|   >_mymalloc
|     enter: Size: 2064
|     exit: ptr: 0x68eb28
| [...]

```

The second trace is the MySQL Connector/C++ internal trace. It is available with debug and non-debug builds of the connector as long as you have enabled the tracing module at compile time using `cmake -DMYSQLCPPCONN_TRACE_ENABLE=BOOL=1`. By default, the tracing functionality is not available and calls to trace functions are removed by the preprocessor.

Compiling the connector with tracing functionality enabled will cause two additional tracing function calls per each connector function call. You will need to run your own benchmark to find out how much this will impact the performance of your application.

A simple test using a loop running 30,000 INSERT SQL statements showed no significant real-time impact. The two variants of this application using a trace enabled and trace disabled version of the connector performed equally well. The run time measured in real-time was not significantly impacted as long as writing a debug trace was not enabled. However, there will be a difference in the time spent in the application. When writing a debug trace the IO subsystem may become a bottleneck.

In summary, use connector builds with tracing enabled carefully. Trace enabled versions may cause higher CPU usage even if the overall run time of your application is not impacted significantly.

```

| INF: Tracing enabled
|<MySQL_Connection::setClientOption
|>MySQL_Prepared_Statement::setInt
|   INF: this=0x69a2e0
|   >MySQL_Prepared_Statement::checkClosed
|   <MySQL_Prepared_Statement::checkClosed
|   <MySQL_Prepared_Statement::setInt
| [...]

```



The example from [examples/debug.cpp](#) demonstrates how to activate the debug traces in your program. Currently they can only be activated through API calls. The traces are controlled on a per-connection basis. You can use the `setClientOptions()` method of a connection object to activate and deactivate the generation of a trace. The MySQL Client Library trace is always written into a file, whereas the connector's protocol messages are printed to standard out.

```
sql::Driver *driver;
int on_off = 1;

/* Using the Driver to create a connection */
driver = get_driver_instance();
std::auto_ptr< sql::Connection > con(driver->connect(host, user, pass));

/*
Activate debug trace of the MySQL Client Library (C-API)
Only available with a debug build of the MySQL Client Library!
*/
con->setClientOption("libmysql_debug", "d:t:0,client.trace");

/*
Tracing is available if you have compiled the driver using
cmake -DMYSQLCPPCONN_TRACE_ENABLE=BOOL=1
*/
con->setClientOption("client_trace", &on_off);
```

## 20.6.7. MySQL Connector/C++ References

### Caution

Please note, official support is not available for the beta version of MySQL Connector/C++.

See the [JDBC overview](#) for information on JDBC 4.0. Please also check the [examples/](#) directory of the download package.

### Notes on using the MySQL Connector/C++ API

- `DatabaseMetaData::supportsBatchUpdates()` returns `true` because MySQL supports batch updates in general. However, no API calls for batch updates are provided by the MySQL Connector/C++ API.
- Two non-JDBC methods have been introduced for fetching and setting unsigned integers: `getUInt64()` and `getUInt()`. These are available for `ResultSet` and `PreparedStatement`:

- `ResultSet::getUInt64()`
- `ResultSet::getUInt()`
- `PreparedStatement::setUInt64()`
- `PreparedStatement::setUInt()`

The corresponding `getLong()` and `setLong()` methods have been removed.

- The method `DatabaseMetaData::getColumns()` has 23 columns in its result set, rather than the 22 columns defined by JDBC. The first 22 columns are as described in the JDBC documentation, but column 23 is new:

23. `IS_AUTOINCREMENT`: String which is “YES” if the column is an auto-increment column. Otherwise the string contains “NO”.

- MySQL Connector/C++ may return different metadata for the same column.

When you have any column that accepts a charset and a collation in its specification and you specify a binary collation, such as:

```
CHAR(250) CHARACTER SET 'latin1' COLLATE 'latin1_bin'
```

The server sets the `BINARY` flag in the result set metadata of this column. The method `ResultSetMetadata::getColumnTypeName()` uses the metadata and will report, due to the `BINARY` flag, that the column type name is `BINARY`. This is illustrated below:

```
mysql> create table varbin(a varchar(20) character set utf8 collate utf8_bin);
Query OK, 0 rows affected (0.00 sec)

mysql> select * from varbin;
Field 1: `a`
Catalog: `def`
Database: `test`
Table: `varbin`
Org_table: `varbin`
Type: VAR_STRING
```

```

Collation: latin1_swedish_ci (8)
Length: 20
Max_length: 0
Decimals: 0
Flags: BINARY

0 rows in set (0.00 sec)

mysql> select * from information_schema.columns where table_name='varbin'\G
***** 1. row *****
      TABLE_CATALOG: NULL
      TABLE_SCHEMA: test
      TABLE_NAME: varbin
      COLUMN_NAME: a
      ORDINAL_POSITION: 1
      COLUMN_DEFAULT: NULL
      IS_NULLABLE: YES
      DATA_TYPE: varchar
CHARACTER_MAXIMUM_LENGTH: 20
CHARACTER_OCTET_LENGTH: 60
      NUMERIC_PRECISION: NULL
      NUMERIC_SCALE: NULL
      CHARACTER_SET_NAME: utf8
      COLLATION_NAME: utf8_bin
      COLUMN_TYPE: varchar(20)
      COLUMN_KEY:
      EXTRA:
      PRIVILEGES: select,insert,update,references
      COLUMN_COMMENT:
1 row in set (0.01 sec)

```

However, `INFORMATION_SCHEMA` gives no hint in its `COLUMNS` table that metadata will contain the `BINARY` flag. `DatabaseMetaData::getColumn()` uses `INFORMATION_SCHEMA`. It will report the type name `CHAR` for the same column. Note, a different type code is also returned.

- The MySQL Connector/C++ class `sql::DataType` defines the following JDBC standard data types: `UNKNOWN`, `BIT`, `TINYINT`, `SMALLINT`, `MEDIUMINT`, `INTEGER`, `BIGINT`, `REAL`, `DOUBLE`, `DECIMAL`, `NUMERIC`, `CHAR`, `BINARY`, `VARCHAR`, `VARBINARY`, `LONGVARCHAR`, `LONGVARBINARY`, `TIMESTAMP`, `DATE`, `TIME`, `GEOMETRY`, `ENUM`, `SET`, `SQL-NULL`.

However, the following JDBC standard data types are *not* supported by MySQL Connector/C++: `ARRAY`, `BLOB`, `CLOB`, `DISTINCT`, `FLOAT`, `OTHER`, `REF`, `STRUCT`.

- When inserting or updating `BLOB` or `TEXT` columns, MySQL Connector/C++ developers are advised not to use `setString()`. Instead it is recommended that the dedicated API function `setBlob()` be used instead.

The use of `setString()` can cause a `Packet too large` error message. The error will occur if the length of the string passed to the connector using `setString()` exceeds `max_allowed_packet` (minus a few bytes reserved in the protocol for control purposes). This situation is not handled in MySQL Connector/C++, as this could lead to security issues, such as extremely large memory allocation requests due to malevolently long strings.

However, if `setBlob()` is used, this problem does not arise. This is because `setBlob()` takes a streaming approach based on `std::istream`. When sending the data from the stream to MySQL Server, MySQL Connector/C++ will split the stream into chunks appropriate for MySQL Server and observe the `max_allowed_packet` setting currently being used.

### Caution

When using `setString()` it is not possible to set `max_packet_size` to a value large enough for the string, prior to passing it to MySQL Connector/C++. The MySQL 6.0 [documentation](#) for `max_packet_size` states: “As of MySQL 6.0.9, the session value of this variable is read only. Before 6.0.9, setting the session value is allowed but has no effect.”

This difference with the JDBC specification ensures that MySQL Connector/C++ is not vulnerable to memory flooding attacks.

- In general MySQL Connector/C++ works with MySQL 5.0, but it is not completely supported. Some methods may not be available when connecting to MySQL 5.0. This is because the Information Schema is used to obtain the requested information. There are no plans to improve the support for 5.0 because the current GA version of MySQL Server is 5.1. As a new product, MySQL Connector/C++ is primarily targeted at the MySQL Server GA version that was available on its release.

The following methods will throw a `sql::MethodNotImplemented` exception when you connect to MySQL earlier than 5.1.0:

- `DatabaseMetadata::getCrossReference()`
- `DatabaseMetadata::getExportedKeys()`

- MySQL Connector/C++ includes a method `Connection::getClientOption()` which is not included in the JDBC API specification. The prototype is:

```
void getClientOption(const std::string & optionName, void * optionValue)
```

The method can be used to check the value of connection properties set when establishing a database connection. The values are returned through the `optionValue` argument passed to the method with the type `void *`.

Currently, `getClientOption()` supports fetching the `optionValue` of the following options:

- `metadataUseInfoSchema`
- `defaultStatementResultType`
- `defaultPreparedStatementResultType`

The connection option `metadataUseInfoSchema` controls whether to use the `Information_Schemata` for returning the meta data of `SHOW` commands. In the case of `metadataUseInfoSchema` the `optionValue` argument should be interpreted as a boolean upon return.

In the case of both `defaultStatementResultType` and `defaultPreparedStatementResultType`, the `optionValue` argument should be interpreted as an integer upon return.

The connection property can be either set when establishing the connection through the connection property map or using `void Connection::setClientOption(const std::string & optionName, const void * optionValue)` where `optionName` is assigned the value `metadataUseInfoSchema`.

Some examples are given below:

```
int defaultStmtResType;
int defaultPStmtResType;
conn->getClientOption("defaultStatementResultType", (void *) &defaultStmtResType);
conn->getClientOption("defaultPreparedStatementResultType", (void *) &defaultPStmtResType);

bool isInfoSchemaUsed;
conn->getClientOption("metadataUseInfoSchema", (void *) &isInfoSchemaUsed);
```

- MySQL Connector/C++ also supports the following methods not found in the JDBC API standard:

```
std::string MySQL_Connection::getSessionVariable(const std::string & varname)
```

```
void MySQL_Connection::setSessionVariable(const std::string & varname, const std::string & value)
```

Note that both methods are members of the `MySQL_Connection` class. The methods get and set MySQL session variables.

`setSessionVariable()` is equivalent to executing:

```
SET SESSION <varname> = <value>
```

`getSessionVariable()` is equivalent to executing the following and fetching the first return value:

```
SHOW SESSION VARIABLES LIKE "<varname>"
```

You can use “%” and other placeholders in `<varname>`, if the underlying MySQL server supports this.

## 20.6.8. MySQL Connector/C++ Known Bugs and Issues

### Caution

Please note, official support is not available for the beta version of MySQL Connector/C++.

### Note

Please report bugs through [MySQL Bug System](#).

#### Known bugs:

None.

#### Known issues:

- When linking against a static library for 1.0.3 on Windows you need to define `CPPDBC_PUBLIC_FUNC` either in the compiler options (preferable) or with `/D "CPPCONN_PUBLIC_FUNC="`. You can also explicitly define it in your code by placing `#define CPPCONN_PUBLIC_FUNC` before the header inclusions.
- Generally speaking C++ library binaries are less portable than C library binaries. Issues can be caused by name mangling, different Standard Template Library (STL) versions and using different compilers and linkers for linking against the libraries than were used for building the library itself.

Even a small change in the compiler version can, but does not have to, cause problems. If you obtain error messages, that you suspect are related to binary incompatibilities, build MySQL Connector/C++ from source, using the same compiler and linker that you will use to build and link your application.

Due to the variations between Linux distributions, compiler and linker versions and STL versions, it is not possible to provide binaries for each and every possible configuration. However, the MySQL Connector/C++ binary distributions contain a [README](#) file that describes the environment and settings used to build the binary versions of the libraries.

- To avoid potential crashes the build configuration of MySQL Connector/C++ should match the build configuration of the application using it. For example, do not use the release build of MySQL Connector/C++ with a debug build of the client application.

See also the MySQL Connector/C++ Changelogs which can be found here [MySQL Connector/C++ Change History](#).

## 20.6.9. MySQL Connector/C++ Feature requests

### Caution

Please note, official support is not available for the beta version of MySQL Connector/C++.

You can suggest new features in the first instance by joining the mailing list or forum and talking with the developers directly. See [Section 20.6.10, “MySQL Connector/C++ Support”](#)

The following feature requests are currently being worked on:

- C++ references for [Statements](#), [ResultSets](#), and exceptions, are being considered, instead of pointers to heap memory. This reduces the exception handling burden for the programmer.
- Adopt STL (suggestions are welcome).
- JDBC compliance: datatype interfaces and support through `ResultSet:getType()` and `PreparedStatement:bind()`. Introduce `sql::Blob`, `sql::Clob`, `sql::Date`, `sql::Time`, `sql::Timestamp`, `sql::URL`. Support `get|setBlob()`, `get|setClob()`, `get|setDate()`, `get|setTime()`, `get|setTimestamp()`, `get|setURL()`
- Add support for all C-API connection options. Improved support for `mysql_options`.
- Add connect method which supports passing options using HashMaps.
- Create Windows installer.

## 20.6.10. MySQL Connector/C++ Support

### Caution

Please note, official support is not available for the beta version of MySQL Connector/C++.

For general discussion of the MySQL Connector/C++ please use the [C/C++ community forum](#) or join the [MySQL Connector/C++ mailing list](#).

Bugs can be reported at the [MySQL bug website](#).

For Licensing questions, and to purchase MySQL Products and Services, please [Contact MySQL](#)

The MySQL Connector/C++ Changelogs can be found here [MySQL Connector/C++ Change History](#)

## 20.6.11. MySQL Connector/C++ FAQ

## Questions

- [20.6.11.1](#): What is MySQL Connector/C++?
- [20.6.11.2](#): Which MySQL Server version(s) is MySQL Connector/C++ compatible with?
- [20.6.11.3](#): Does MySQL Connector/C++ implement the client-server protocol?
- [20.6.11.4](#): Are any MySQL products using MySQL Connector/C++?

## Questions and Answers

### 20.6.11.1: What is MySQL Connector/C++?

MySQL Connector/C++ is a MySQL database connector for C++. It allows you develop applications in C++ that connect to the MySQL Server. MySQL Connector/C++ is compatible with the JDBC 4.0 API.

### 20.6.11.2: Which MySQL Server version(s) is MySQL Connector/C++ compatible with?

MySQL Connector/C++ fully supports MySQL Server version 5.1 and later.

### 20.6.11.3: Does MySQL Connector/C++ implement the client-server protocol?

No. MySQL Connector/C++ uses the MySQL Client Library for the client-server communication.

### 20.6.11.4: Are any MySQL products using MySQL Connector/C++?

Yes, MySQL Workbench and MySQL Connector/OpenOffice.org.

## 20.7. MySQL Connector/C

### What is MySQL Connector/C?

MySQL Connector/C is a C client library for client-server communication. It is a standalone replacement for the MySQL Client Library shipped with the MySQL Server.

### Why have a replacement for MySQL Client Library?

There is no need to compile or install the MySQL Server package if you only need the client library.

MySQL Connector/C does not rely on the MySQL Server release cycle, so bug fixes and new features are released more often.

MySQL Connector/C API documentation is available [online](#).

Supported platforms include:

- Windows
- Windows x64
- Linux
- Solaris
- FreeBSD
- Mac OS X
- HP-UX
- IBM AIX
- IBM i5/OS

### 20.7.1. Building MySQL Connector/C from the Source Code

#### Obtaining the Source Code

---

The source can be downloaded as a Zip file or tar-ball from the source repository on [Launchpad](#).

- **Building on Unix**

Examples of supported Unix or Unix-like operating systems include:

- Solaris
- Linux
- HP-UX
- AIX
- OS X

#### **Compiler Tools**

Ideally, the native compiler tool set for the target platform is used for compilation. This would be SunStudio for Solaris and aCC for HP-UX for example. However, the GNU tool-chain can be used across all platforms.

You also need CMake 2.6 or newer, which is available [online](#).

#### **To Build**

If using GNU AutoTools change to the MySQL Connector/C source directory and follow the procedure below.

1. To generate the makefile enter:

```
shell> cmake -G "Unix Makefiles"
```

or for a Debug build enter:

```
shell> cmake -G "Unix Makefiles" -DCMAKE_BUILD_TYPE=Debug
```

2. Then build the project using:

```
shell> make
```

#### **To Install**

By default make install will install the MySQL Connector/C files in the `/usr/local` directory. You can change this behavior by specifying another directory when generating the [makefile](#):

```
shell> cmake -G "Unix Makefiles" -DCMAKE_INSTALL_PREFIX=/mypath
```

Now, in the root shell, enter the following to install the MySQL Connector/C libraries and tools:

```
root-shell> make install
```

At this point all of the MySQL Connector/C files will be in place.

- **Building on Microsoft Windows**

Older versions of Microsoft Windows are not supported. Supported versions are Windows 2000, Windows XP, Windows Vista, Windows Server 2003, or Windows Server 2008.

#### **Compiler Tools**

Microsoft Visual Studio 8 and 9 are recommended. The Express Edition of Visual Studio and other compilers may work, but are untested.

You also need CMake 2.6 or newer, available at <http://www.cmake.org>

#### **To Build**

You need to have the environment variables set for the Visual Studio toolchain. Visual Studio includes a batch file to set these for you, and installs a shortcut into the **START** menu to open a command prompt with these variables set.

Build MySQL Connector/C using the CMake command-line tool by entering the following from the source root directory in a command prompt window:

```
shell> cmake -G "Visual Studio 9 2008"
```

This produces a project file that you can open with Visual Studio or build from the command line with either of:

```
shell> devenv.com libmysql.sln /build Release
```

```
shell> devenv.com libmysql.sln /build RelWithDebInfo
```

For other versions of Visual Studio or `nmake` based build, run the following command:

```
shell> cmake --help
```

to check the supported generators.

To compile the Debug build, you must run set the CMake build type so the correct version of external libraries are used:

```
shell> cmake -G "Visual Studio 8 2005" -DCMAKE_BUILD_TYPE=Debug
```

Followed by:

```
shell> devenv.com libmysql.sln /build Debug
```

### To Install

To create a install package you can choose between two variants:

1. Creating a Zip package
2. Creating an MSI install package

- **Zip package**

To create a Zip package, run the `cpack` command from the root of your MySQL Connector/C source directory.

- **MSI Install package**

The required tools include Windows XML Installer toolset (WIX), which is available [online](#).

To create the MSI install package change to the subdirectory `win` and generate the `makefile`:

```
shell> cmake -G "NMake Makefiles"
```

Create the MSI install package by calling `nmake`:

```
shell> nmake
```

## 20.7.2. Testing MySQL Connector/C

For testing MySQL Connector/C you will need a running MySQL server instance. Before you run the test suite you need to specify the following environment variables:

- `MYSQL_TEST_HOST` (default localhost)
- `MYSQL_TEST_USER`
- `MYSQL_TEST_PASSWD`
- `MYSQL_TEST_PORT`
- `MYSQL_TEST_SOCKET`
- `MYSQL_TEST_DB` (default test)

To run the test suite, execute `ctest` from the command line:

```
shell> ctest
```

## 20.7.3. MySQL Connector/C FAQ

### Questions

- [20.7.3.1](#): What is “libmysqld”?
- [20.7.3.2](#): What is “MySQL Connector/C”?
- [20.7.3.3](#): What is the “MySQL Native C API”? What are its typical benefits and use cases?
- [20.7.3.4](#): What is the difference between “Native C API”, “libmysql”, “libmysqld” and “MySQL Connector/C”?
- [20.7.3.5](#): Does MySQL Connector/C replace any of “Native C API”, “libmysql” and “libmysqld”?
- [20.7.3.6](#): What is “libmysql”?

### Questions and Answers

#### 20.7.3.1: What is “libmysqld”?

`libmysqld` is an embedded database server with the same API as MySQL Connector/C. It is included with the MySQL Server distribution.

#### 20.7.3.2: What is “MySQL Connector/C”?

MySQL Connector/C is a standalone distribution of the `libmysql` library, which was previously only available as part of the MySQL Server distribution. The version of `libmysql` included with MySQL Connector/C and the version bundled with the server are functionally equivalent, but the cross-platform build system for MySQL Connector/C uses CMake.

#### 20.7.3.3: What is the “MySQL Native C API”? What are its typical benefits and use cases?

MySQL Connector/C, also known as `libmysql`, or MySQL Native C API, is a standalone, C-based API and library that you can use in C applications to connect with the MySQL Server. It implements the same MySQL client API that has been in use for a decade.

It is also used as the foundation for drivers for standard database APIs such as ODBC, Perl's DBI, and Python's DB API.

#### 20.7.3.4: What is the difference between “Native C API”, “libmysql”, “libmysqld” and “MySQL Connector/C”?

MySQL Connector/C and `libmysql` are the “native C API for MySQL”, and all three terms can be used interchangeably. “libmysqld” is the embedded version of the MySQL Server, and is included in the server distribution.

#### 20.7.3.5: Does MySQL Connector/C replace any of “Native C API”, “libmysql” and “libmysqld”?

MySQL Connector/C contains `libmysql`, and implements a native C API. It does not include `libmysqld`, which can be found with the MySQL server distribution.

#### 20.7.3.6: What is “libmysql”?

`libmysql` is the name of the library that MySQL Connector/C provides.

## 20.8. MySQL Connector/OpenOffice.org

MySQL Connector/OpenOffice.org is a native MySQL database connector for OpenOffice.org. Currently, it is in preview status and supports OpenOffice.org 2.4 only. It can be used to connect OpenOffice.org applications to a MySQL server.

Before MySQL Connector/OpenOffice.org became available you would have to use MySQL Connector/J (JDBC) or MySQL Connector/ODBC to connect to a MySQL server.

Connector/OpenOffice.org is a community project, although Sun Microsystems actively contributes code. The source code for Connector/OpenOffice.org is available under GPL with the FLOSS License Exception.

In the future a closed-source StarOffice version of Connector/OpenOffice.org will be made available.



## Advantages

Using MySQL Connector/OpenOffice.org has the following advantages:

- Easy installation through the OpenOffice.org Extension Manager.
- Seamless integration into OpenOffice.org.
- No need to go through an additional Connector installation routine (ODBC/JDBC)
- No need to configure or register an additional Connector (ODBC)
- No need to install or configure a driver manager (ODBC)

## Status

MySQL Connector/OpenOffice.org is available as a development preview version. We kindly ask users and developers to try it out and provide us with feedback. We do not encourage you to use it in production environments, though.

### Note

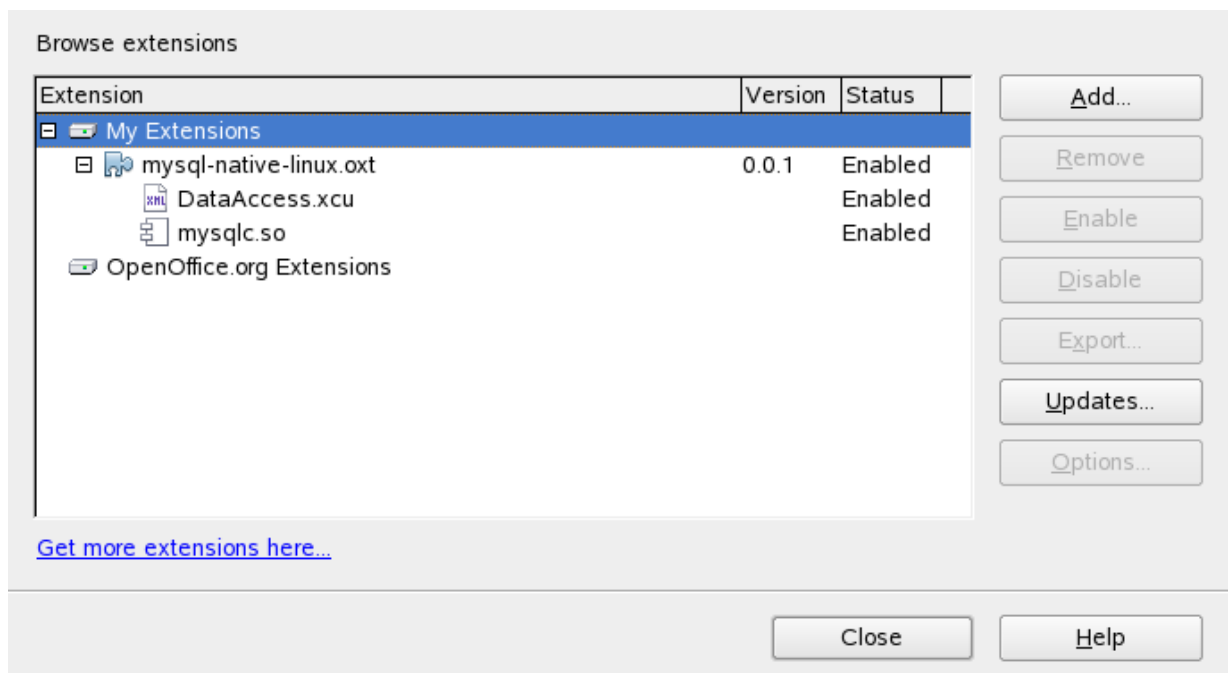
Sun Microsystems does not provide formal support for Connector/OpenOffice.org.

If you have any queries please contact us through our mailing list at [<users@dba.openoffice.org>](mailto:users@dba.openoffice.org)

## 20.8.1. Installation

1. Install or upgrade to OpenOffice.org 2.4.
2. Download MySQL Connector/OpenOffice.org from [The OpenOffice.org download site](#). Save the file, `mysql-native-win32.oxt` or `mysql-native-linux.oxt`, respectively, to a location of your choice, for example `My Documents` or `~/Documents`.
3. Add the `.oxt` extension through the Extension Manager of OpenOffice.org. In OpenOffice.org, select **TOOLS, EXTENSION MANAGER...** and specify the `.oxt` file as a new extension. When done, MySQL Connector/OpenOffice.org will show up as a new extension under **MY EXTENSIONS**.

**Figure 20.62. Adding an extension**



- Restart OpenOffice.org.

## 20.8.2. Getting Started: Connecting to MySQL

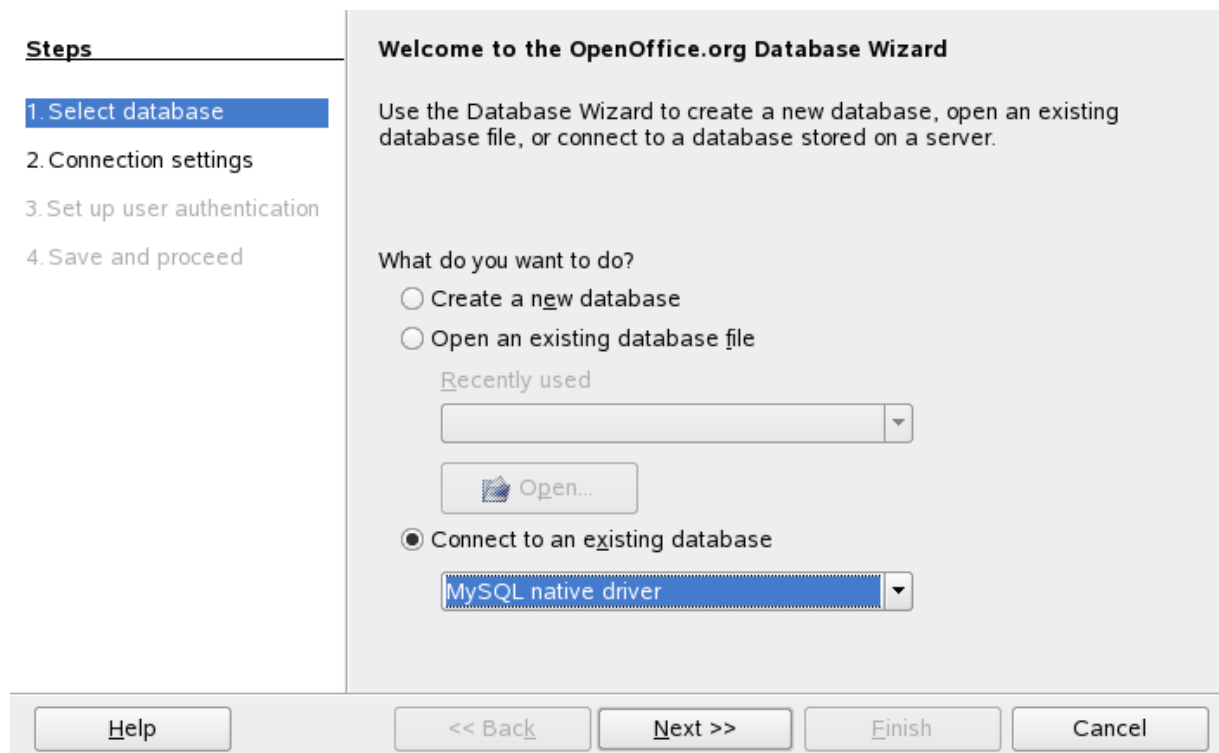
MySQL Connector/OpenOffice.org allows you to access the MySQL Server and its schemata from the OpenOffice.org suite. Currently the connector is in preview status, and only OpenOffice.org 2.4 is supported.

The following example demonstrates the creation of a new OpenOffice.org Base database which uses a local MySQL Server for storage and the new connector for connecting.

- Select the database

Create a new database by selecting **FILE, NEW, DATABASE**. This starts a wizard that allows you to create a new, open an existing, or connect to existing database. Select the latter option. From the drop-down list, select MySQL native driver. Click **NEXT >>**.

**Figure 20.63. Selecting the database**



- Fill in the connection settings

Under **MYSQL NATIVE DRIVER**, fill in the host name, and optionally a database name, and port name, for example:

**localhost/test**

This will connect to a MySQL server running on the local host and select the test database. Note that if you do not specify a database the process below will still work, and all databases will be available for selection.

On Linux, you may have to specify an IP number and a port number instead, due to a limitation in Connector/OpenOffice.org. You have to do so if your MySQL socket file is not `/tmp/mysql.sock`. Enter your data using the format illustrated in the following example:

**127.0.0.1:3306/test**

This will connect to a MySQL server running on the local host, but do so via TCP/IP using 3306 as the port number. Click **NEXT >>**.

**Figure 20.64. Entering connection settings**

The screenshot shows a wizard interface with a sidebar on the left and a main content area on the right. The sidebar is titled "Steps" and contains a list of four steps: "1. Select database", "2. Connection settings", "3. Set up user authentication", and "4. Save and proceed". The second step, "2. Connection settings", is highlighted with a blue background. The main content area is titled "MySQL native driver" and contains a text input field with the value "localhost:3306/test". At the bottom of the wizard, there are five buttons: "Help", "<< Back", "Next >>", "Finish", and "Cancel".

**Steps**

1. Select database
2. Connection settings
3. Set up user authentication
4. Save and proceed

MySQL native driver

localhost:3306/test

Help << Back Next >> Finish Cancel

3. Fill in credentials

If you are using MySQL server's anonymous account without a password, you do not have to fill in anything in this step. Otherwise, fill in your MySQL user name and check the password checkbox. Note, for security reasons, you should not normally use the anonymous account without a password.

**Figure 20.65. Setting up user authentication**

You can now test your connection to the MySQL database server by clicking the TEST CONNECTION button. Check the checkbox if you do not want OpenOffice.org to ask you for your password again in the current session. Testing the connection is optional, although recommended.

**Figure 20.66. Entering user credentials**

Click NEXT >>.

4. Finish the wizard

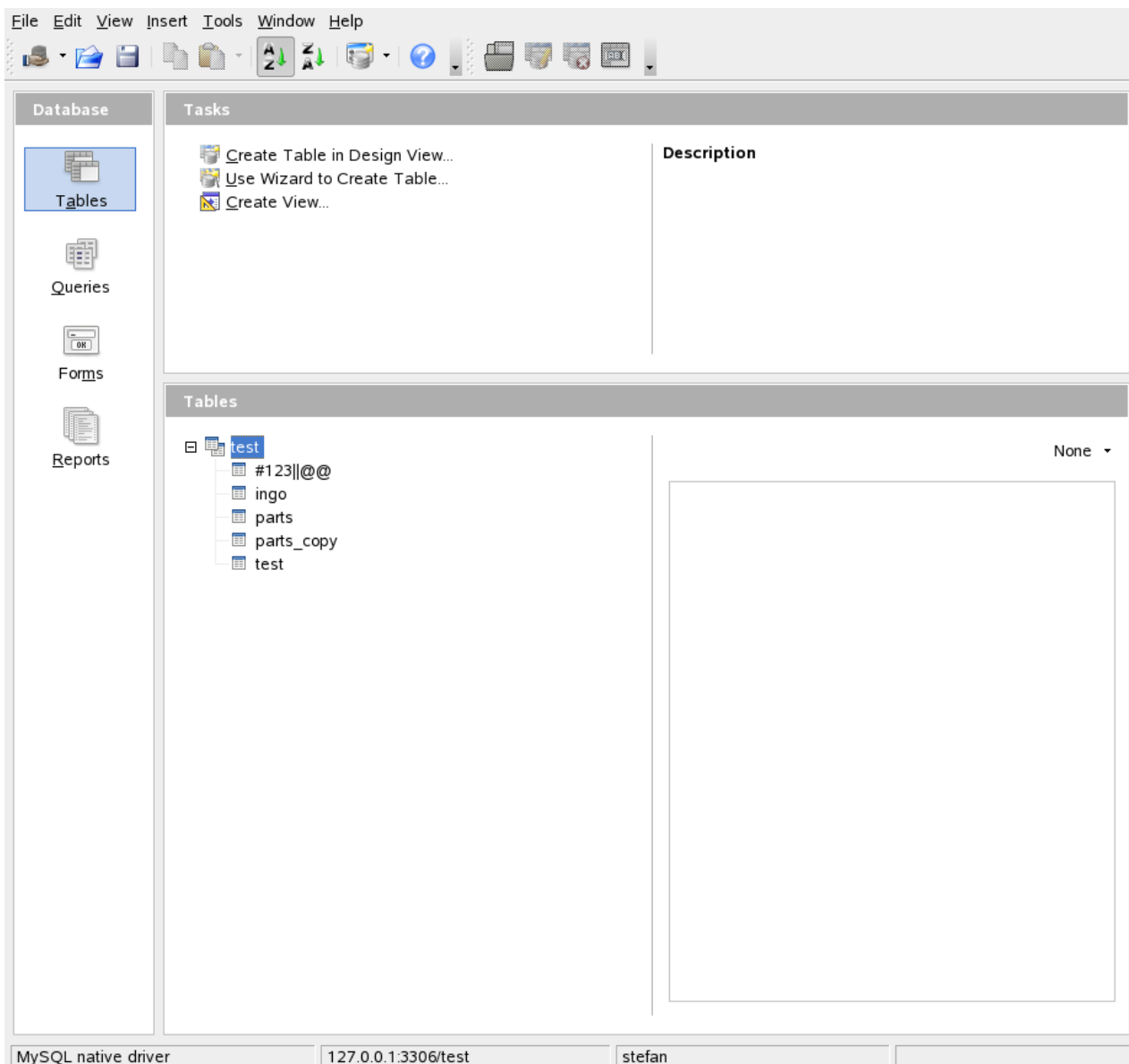
Leave the default settings and click FINISH. You will be forwarded to the OpenOffice.org Base main window. Note that you can invoke the wizard again at any point by right-clicking in the **TABLES** section of the **BASE** main window and selecting DATABASE, CONNECTION TYPE.

### 20.8.3. Getting Started: Usage Examples

#### Listing Tables

In the **DATABASE** area of the **BASE** main window, select **TABLES**. If this is the first time you are accessing the database you will be prompted for your credentials (user name and password); you can store these settings for your current Base session.

Figure 20.67. Listing tables



Depending on your connection settings you will now see all databases with all their tables, or just the database you have specified in the connection settings.

## 20.8.4. References

See the [OpenOffice.org website](http://openoffice.org) for documentation of the office suite and its Extension Manager.

## 20.8.5. Known Bugs

If you discover a bug in Connector/OpenOffice.org please [add it to this list](#) and send an email to [users@dba.openoffice.org](mailto:users@dba.openoffice.org). You need to be logged in with an OpenOffice.org account for both; see the [project mailing list](#) for details.

## 20.8.6. Contact

To discuss the new MySQL Connector/OpenOffice.org, please subscribe to the mailing list [users@dba.openoffice.org](mailto:users@dba.openoffice.org). It is a low-volume list with less than 10 mails per day.

## 20.9. libmysqld, the Embedded MySQL Server Library

The embedded MySQL server library makes it possible to run a full-featured MySQL server inside a client application. The main benefits are increased speed and more simple management for embedded applications.

The embedded server library is based on the client/server version of MySQL, which is written in C/C++. Consequently, the embedded server also is written in C/C++. There is no embedded server available in other languages.

The API is identical for the embedded MySQL version and the client/server version. To change an old threaded application to use the embedded library, you normally only have to add calls to the following functions.

Function	When to Call
<code>mysql_library_init()</code>	Should be called before any other MySQL function is called, preferably early in the <code>main()</code> function.
<code>mysql_library_end()</code>	Should be called before your program exits.
<code>mysql_thread_init()</code>	Should be called in each thread you create that accesses MySQL.
<code>mysql_thread_end()</code>	Should be called before calling <code>pthread_exit()</code>

Then you must link your code with `libmysqld.a` instead of `libmysqlclient.a`. To ensure binary compatibility between your application and the server library, be sure to compile your application against headers for the same series of MySQL that was used to compile the server library. For example, if `libmysqld` was compiled against MySQL 4.1 headers, do not compile your application against MySQL 5.1 headers, or vice versa.

The `mysql_library_xxx()` functions are also included in `libmysqlclient.a` to allow you to change between the embedded and the client/server version by just linking your application with the right library. See [Section 20.10.3.40](#), “`mysql_library_init()`”.

One difference between the embedded server and the standalone server is that for the embedded server, authentication for connections is disabled by default. To use authentication for the embedded server, specify the `-with-embedded-privilege-control` option when you invoke `configure` to configure your MySQL distribution.

### 20.9.1. Compiling Programs with `libmysqld`

In precompiled binary MySQL distributions that include `libmysqld`, the embedded server library, MySQL builds the library using the appropriate vendor compiler if there is one.

To get a `libmysqld` library if you build MySQL from source yourself, you should configure MySQL with the `-with-embedded-server` option. See [Section 2.10.2](#), “Typical configure Options”.

When you link your program with `libmysqld`, you must also include the system-specific `pthread` libraries and some libraries that the MySQL server uses. You can get the full list of libraries by executing `mysql_config --libmysqld-libs`.

The correct flags for compiling and linking a threaded program must be used, even if you do not directly call any thread functions in your code.

To compile a C program to include the necessary files to embed the MySQL server library into an executable version of a program, the compiler will need to know where to find various files and need instructions on how to compile the program. The following example shows how a program could be compiled from the command line, assuming that you are using `gcc`, use the GNU C compiler:

```
gcc mysql_test.c -o mysql_test -lz \
`/usr/local/mysql/bin/mysql_config --include --libmysqld-libs`
```

Immediately following the `gcc` command is the name of the C program source file. After it, the `-o` option is given to indicate that the file name that follows is the name that the compiler is to give to the output file, the compiled program. The next line of code tells the compiler to obtain the location of the include files and libraries and other settings for the system on which it is compiled. Because of a problem with `mysql_config`, the option `-lz` (for compression) is added here. The `mysql_config` command is contained in backticks, not single quotes.

On some non-`gcc` platforms, the embedded library depends on C++ runtime libraries and linking against the embedded library might result in missing-symbol errors. To solve this, link using a C++ compiler or explicitly list the required libraries on the link command line.

### 20.9.2. Restrictions When Using the Embedded MySQL Server

The embedded server has the following limitations:

- No user-defined functions (UDFs).
- No stack trace on core dump.
- You cannot set this up as a master or a slave (no replication).
- Very large result sets may be unusable on low memory systems.
- You cannot connect to an embedded server from an outside process with sockets or TCP/IP. However, you can connect to an intermediate application, which in turn can connect to an embedded server on the behalf of a remote client or outside process.
- **InnoDB** is not reentrant in the embedded server and cannot be used for multiple connections, either successively or simultaneously.
- The Event Scheduler is not available. Because of this, the `event_scheduler` system variable is disabled.

Some of these limitations can be changed by editing the `mysql_embed.h` include file and recompiling MySQL.

### 20.9.3. Options with the Embedded Server

Any options that may be given with the `mysqld` server daemon, may be used with an embedded server library. Server options may be given in an array as an argument to the `mysql_library_init()`, which initializes the server. They also may be given in an option file like `my.cnf`. To specify an option file for a C program, use the `--defaults-file` option as one of the elements of the second argument of the `mysql_library_init()` function. See [Section 20.10.3.40, “mysql\\_library\\_init\(\)”](#), for more information on the `mysql_library_init()` function.

Using option files can make it easier to switch between a client/server application and one where MySQL is embedded. Put common options under the `[server]` group. These are read by both MySQL versions. Client/server-specific options should go under the `[mysqld]` section. Put options specific to the embedded MySQL server library in the `[embedded]` section. Options specific to applications go under section labeled `[ApplicationName_SERVER]`. See [Section 4.2.3.2, “Using Option Files”](#).

### 20.9.4. Embedded Server Examples

These two example programs should work without any changes on a Linux or FreeBSD system. For other operating systems, minor changes are needed, mostly with file paths. These examples are designed to give enough details for you to understand the problem, without the clutter that is a necessary part of a real application. The first example is very straightforward. The second example is a little more advanced with some error checking. The first is followed by a command-line entry for compiling the program. The second is followed by a GNUmake file that may be used for compiling instead.

#### Example 1

`test1_libmysqld.c`

```
#include <stdio.h>
#include <stdlib.h>
#include <stdarg.h>
#include "mysql.h"

MYSQL *mysql;
MYSQL_RES *results;
MYSQL_ROW record;

static char *server_options[] = \
    { "mysql_test", "--defaults-file=my.cnf", NULL };
int num_elements = (sizeof(server_options) / sizeof(char *)) - 1;

static char *server_groups[] = { "libmysqld_server",
    "libmysqld_client", NULL };

int main(void)
{
    mysql_library_init(num_elements, server_options, server_groups);
    mysql = mysql_init(NULL);
    mysql_options(mysql, MYSQL_READ_DEFAULT_GROUP, "libmysqld_client");
    mysql_options(mysql, MYSQL_OPT_USE_EMBEDDED_CONNECTION, NULL);

    mysql_real_connect(mysql, NULL, NULL, NULL, "database1", 0, NULL, 0);

    mysql_query(mysql, "SELECT column1, column2 FROM table1");

    results = mysql_store_result(mysql);

    while((record = mysql_fetch_row(results))) {
        printf("%s - %s \n", record[0], record[1]);
    }

    mysql_free_result(results);
    mysql_close(mysql);
    mysql_library_end();
}
```

```

}
return 0;
}

```

Here is the command line for compiling the above program:

```

gcc test1_libmysqld.c -o test1_libmysqld -lz \
`/usr/local/mysql/bin/mysql_config --include --libmysqld-libs`

```

## Example 2

To try out the example, create an `test2_libmysqld` directory at the same level as the MySQL source directory. Save the `test2_libmysqld.c` source and the `GNUmakefile` in the directory, and run GNU `make` from inside the `test2_libmysqld` directory.

### test2\_libmysqld.c

```

/*
 * A simple example client, using the embedded MySQL server library
 */

#include <mysql.h>
#include <stdarg.h>
#include <stdio.h>
#include <stdlib.h>

MYSQL *db_connect(const char *dbname);
void db_disconnect(MYSQL *db);
void db_do_query(MYSQL *db, const char *query);

const char *server_groups[] = {
    "test2_libmysqld_SERVER", "embedded", "server", NULL
};

int
main(int argc, char **argv)
{
    MYSQL *one, *two;

    /* mysql_library_init() must be called before any other mysql
     * functions.
     *
     * You can use mysql_library_init(0, NULL, NULL), and it
     * initializes the server using groups = {
     *   "server", "embedded", NULL
     * }.
     *
     * In your $HOME/.my.cnf file, you probably want to put:
     [test2_libmysqld_SERVER]
     language = /path/to/source/of/mysql/sql/share/english
     *
     * You could, of course, modify argc and argv before passing
     * them to this function. Or you could create new ones in any
     * way you like. But all of the arguments in argv (except for
     * argv[0], which is the program name) should be valid options
     * for the MySQL server.
     *
     * If you link this client against the normal mysqlclient
     * library, this function is just a stub that does nothing.
     */
    mysql_library_init(argc, argv, (char **)server_groups);

    one = db_connect("test");
    two = db_connect(NULL);

    db_do_query(one, "SHOW TABLE STATUS");
    db_do_query(two, "SHOW DATABASES");

    mysql_close(two);
    mysql_close(one);

    /* This must be called after all other mysql functions */
    mysql_library_end();

    exit(EXIT_SUCCESS);
}

static void
die(MYSQL *db, char *fmt, ...)
{
    va_list ap;
    va_start(ap, fmt);
    vfprintf(stderr, fmt, ap);
    va_end(ap);
    (void)putc('\n', stderr);
    if (db)
        db_disconnect(db);
    exit(EXIT_FAILURE);
}

```



```

MYSQL *
db_connect(const char *dbname)
{
    MYSQL *db = mysql_init(NULL);
    if (!db)
        die(db, "mysql_init failed: no memory");
    /*
     * Notice that the client and server use separate group names.
     * This is critical, because the server does not accept the
     * client's options, and vice versa.
     */
    mysql_options(db, MYSQL_READ_DEFAULT_GROUP, "test2_libmysqld_CLIENT");
    if (!mysql_real_connect(db, NULL, NULL, NULL, dbname, 0, NULL, 0))
        die(db, "mysql_real_connect failed: %s", mysql_error(db));

    return db;
}

void
db_disconnect(MYSQL *db)
{
    mysql_close(db);
}

void
db_do_query(MYSQL *db, const char *query)
{
    if (mysql_query(db, query) != 0)
        goto err;

    if (mysql_field_count(db) > 0)
    {
        MYSQL_RES *res;
        MYSQL_ROW row, end_row;
        int num_fields;

        if (!(res = mysql_store_result(db)))
            goto err;
        num_fields = mysql_num_fields(res);
        while ((row = mysql_fetch_row(res)))
        {
            (void)fputs(">> ", stdout);
            for (end_row = row + num_fields; row < end_row; ++row)
                (void)printf("%s\t", row ? (char*)*row : "NULL");
            (void)fputc('\n', stdout);
        }
        (void)fputc('\n', stdout);
        mysql_free_result(res);
    }
    else
        (void)printf("Affected rows: %lld\n", mysql_affected_rows(db));

    return;
err:
    die(db, "db_do_query failed: %s [%s]", mysql_error(db), query);
}

```

## GNUmakefile

```

# This assumes the MySQL software is installed in /usr/local/mysql
inc      := /usr/local/mysql/include/mysql
lib      := /usr/local/mysql/lib

# If you have not installed the MySQL software yet, try this instead
#inc     := $(HOME)/mysql-5.1/include
#lib     := $(HOME)/mysql-5.1/libmysqld

CC       := gcc
CPPFLAGS := -I$(inc) -D_THREAD_SAFE -D_REENTRANT
CFLAGS  := -g -W -Wall
LDFLAGS := -static
# You can change -lmysqld to -lmysqlclient to use the
# client/server library
LDLIBS  = -L$(lib) -lmysqld -lz -lm -ldl -lcrypt

ifndef $(shell grep FreeBSD /COPYRIGHT 2>/dev/null)
# FreeBSD
LDFLAGS += -pthread
else
# Assume Linux
LDLIBS += -lpthread
endif

# This works for simple one-file test programs
sources := $(wildcard *.c)
objects := $(patsubst %c,%o,$(sources))
targets := $(basename $(sources))

all: $(targets)

clean:
    rm -f $(targets) $(objects) *.core

```

## 20.9.5. Licensing the Embedded Server

We encourage everyone to promote free software by releasing code under the GPL or a compatible license. For those who are not able to do this, another option is to purchase a commercial license for the MySQL code from Sun Microsystems, Inc. For details, please see <http://www.mysql.com/company/legal/licensing/>.

## 20.10. MySQL C API

The C API code is distributed with MySQL. It is included in the `mysqlclient` library and allows C programs to access a database.

Many of the clients in the MySQL source distribution are written in C. If you are looking for examples that demonstrate how to use the C API, take a look at these clients. You can find these in the `client` directory in the MySQL source distribution.

Most of the other client APIs (all except Connector/J and Connector/NET) use the `mysqlclient` library to communicate with the MySQL server. This means that, for example, you can take advantage of many of the same environment variables that are used by other client programs, because they are referenced from the library. See [Chapter 4, MySQL Programs](#), for a list of these variables.

The client has a maximum communication buffer size. The size of the buffer that is allocated initially (16KB) is automatically increased up to the maximum size (the maximum is 16MB). Because buffer sizes are increased only as demand warrants, simply increasing the default maximum limit does not in itself cause more resources to be used. This size check is mostly a check for erroneous statements and communication packets.

The communication buffer must be large enough to contain a single SQL statement (for client-to-server traffic) and one row of returned data (for server-to-client traffic). Each thread's communication buffer is dynamically enlarged to handle any query or row up to the maximum limit. For example, if you have `BLOB` values that contain up to 16MB of data, you must have a communication buffer limit of at least 16MB (in both server and client). The client's default maximum is 16MB, but the default maximum in the server is 1MB. You can increase this by changing the value of the `max_allowed_packet` parameter when the server is started. See [Section 7.5.3, "Tuning Server Parameters"](#).

The MySQL server shrinks each communication buffer to `net_buffer_length` bytes after each query. For clients, the size of the buffer associated with a connection is not decreased until the connection is closed, at which time client memory is reclaimed.

For programming with threads, see [Section 20.10.17, "How to Make a Threaded Client"](#). For creating a standalone application which includes the "server" and "client" in the same program (and does not communicate with an external MySQL server), see [Section 20.9, "libmysqld, the Embedded MySQL Server Library"](#).

### MySQL Enterprise

MySQL Enterprise subscribers will find more information about using the C API in the Knowledge Base articles, [The C API](#). Access to the MySQL Knowledge Base collection of articles is one of the advantages of subscribing to MySQL Enterprise. For more information, see <http://www.mysql.com/products/enterprise/advisors.html>.

### 20.10.1. C API Data Types

This section describes C API data types other than those used for prepared statements. For information about the latter, see [Section 20.10.5, "C API Prepared Statement Data Types"](#).

- `MYSQL`

This structure represents a handle to one database connection. It is used for almost all MySQL functions. You should not try to make a copy of a `MYSQL` structure. There is no guarantee that such a copy will be usable.

- `MYSQL_RES`

This structure represents the result of a query that returns rows (`SELECT`, `SHOW`, `DESCRIBE`, `EXPLAIN`). The information returned from a query is called the *result set* in the remainder of this section.

- `MYSQL_ROW`

This is a type-safe representation of one row of data. It is currently implemented as an array of counted byte strings. (You cannot treat these as null-terminated strings if field values may contain binary data, because such values may contain null bytes internally.) Rows are obtained by calling `mysql_fetch_row()`.

- `MYSQL_FIELD`

This structure contains information about a field, such as the field's name, type, and size. Its members are described in more detail here. You may obtain the `MYSQL_FIELD` structures for each field by calling `mysql_fetch_field()` repeatedly. Field

values are not part of this structure; they are contained in a `MYSQL_ROW` structure.

- `MYSQL_FIELD_OFFSET`

This is a type-safe representation of an offset into a MySQL field list. (Used by `mysql_field_seek()`.) Offsets are field numbers within a row, beginning at zero.

- `my_ulonglong`

The type used for the number of rows and for `mysql_affected_rows()`, `mysql_num_rows()`, and `mysql_insert_id()`. This type provides a range of 0 to 1.84e19.

On some systems, attempting to print a value of type `my_ulonglong` does not work. To print such a value, convert it to `unsigned long` and use a `%lu` print format. Example:

```
printf ("Number of rows: %lu\n",
        (unsigned long) mysql_num_rows(result));
```

- `my_bool`

A boolean type, for values that are true (nonzero) or false (zero).

The `MYSQL_FIELD` structure contains the members described in the following list:

- `char * name`

The name of the field, as a null-terminated string. If the field was given an alias with an `AS` clause, the value of `name` is the alias.

- `char * org_name`

The name of the field, as a null-terminated string. Aliases are ignored.

- `char * table`

The name of the table containing this field, if it isn't a calculated field. For calculated fields, the `table` value is an empty string. If the column is selected from a view, `table` names the view. If the table or view was given an alias with an `AS` clause, the value of `table` is the alias. For a `UNION`, the value is the empty string.

- `char * org_table`

The name of the table, as a null-terminated string. Aliases are ignored. If the column is selected from a view, `org_table` names the underlying table. For a `UNION`, the value is the empty string.

- `char * db`

The name of the database that the field comes from, as a null-terminated string. If the field is a calculated field, `db` is an empty string. For a `UNION`, the value is the empty string.

- `char * catalog`

The catalog name. This value is always `"def"`.

- `char * def`

The default value of this field, as a null-terminated string. This is set only if you use `mysql_list_fields()`.

- `unsigned long length`

The width of the field. This corresponds to the display length, in bytes.

- `unsigned long max_length`

The maximum width of the field for the result set (the length in bytes of the longest field value for the rows actually in the result set). If you use `mysql_store_result()` or `mysql_list_fields()`, this contains the maximum length for the field. If you use `mysql_use_result()`, the value of this variable is zero.

The value of `max_length` is the length of the string representation of the values in the result set. For example, if you retrieve a `FLOAT` column and the “widest” value is `-12.345`, `max_length` is 7 (the length of `'-12.345'`).

If you are using prepared statements, `max_length` is not set by default because for the binary protocol the lengths of the values depend on the types of the values in the result set. (See [Section 20.10.5, “C API Prepared Statement Data types”](#).) If you want the `max_length` values anyway, enable the `STMT_ATTR_UPDATE_MAX_LENGTH` option with `mysql_stmt_attr_set()` and the lengths will be set when you call `mysql_stmt_store_result()`. (See [Section 20.10.7.3, “mysql\\_stmt\\_attr\\_set\(\)”](#), and [Section 20.10.7.27, “mysql\\_stmt\\_store\\_result\(\)”](#).)

- `unsigned int name_length`  
The length of `name`.
- `unsigned int org_name_length`  
The length of `org_name`.
- `unsigned int table_length`  
The length of `table`.
- `unsigned int org_table_length`  
The length of `org_table`.
- `unsigned int db_length`  
The length of `db`.
- `unsigned int catalog_length`  
The length of `catalog`.
- `unsigned int def_length`  
The length of `def`.
- `unsigned int flags`  
Different bit-flags for the field. The `flags` value may have zero or more of the following bits set.

Flag Value	Flag Description
<code>NOT_NULL_FLAG</code>	Field can't be <code>NULL</code>
<code>PRI_KEY_FLAG</code>	Field is part of a primary key
<code>UNIQUE_KEY_FLAG</code>	Field is part of a unique key
<code>MULTIPLE_KEY_FLAG</code>	Field is part of a non-unique key
<code>UNSIGNED_FLAG</code>	Field has the <code>UNSIGNED</code> attribute
<code>ZEROFILL_FLAG</code>	Field has the <code>ZEROFILL</code> attribute
<code>BINARY_FLAG</code>	Field has the <code>BINARY</code> attribute
<code>AUTO_INCREMENT_FLAG</code>	Field has the <code>AUTO_INCREMENT</code> attribute
<code>ENUM_FLAG</code>	Field is an <code>ENUM</code> (deprecated)
<code>SET_FLAG</code>	Field is a <code>SET</code> (deprecated)
<code>BLOB_FLAG</code>	Field is a <code>BLOB</code> or <code>TEXT</code> (deprecated)
<code>TIMESTAMP_FLAG</code>	Field is a <code>TIMESTAMP</code> (deprecated)
<code>NO_DEFAULT_VALUE_FLAG</code>	Field has no default value; see additional notes following table

Use of the `BLOB_FLAG`, `ENUM_FLAG`, `SET_FLAG`, and `TIMESTAMP_FLAG` flags is deprecated because they indicate the type of a field rather than an attribute of its type. It is preferable to test `field->type` against `MYSQL_TYPE_BLOB`, `MYSQL_TYPE_ENUM`, `MYSQL_TYPE_SET`, or `MYSQL_TYPE_TIMESTAMP` instead.

`NUM_FLAG` indicates that a column is numeric. This includes columns with a type of `MYSQL_TYPE_DECIMAL`, `MYSQL_TYPE_TINY`, `MYSQL_TYPE_SHORT`, `MYSQL_TYPE_LONG`, `MYSQL_TYPE_FLOAT`, `MYSQL_TYPE_DOUBLE`, `MYSQL_TYPE_NULL`, `MYSQL_TYPE_TIMESTAMP`, `MYSQL_TYPE_LONGLONG`, `MYSQL_TYPE_INT24`, and `MYSQL_TYPE_YEAR`.

`NO_DEFAULT_VALUE_FLAG` indicates that a column has no `DEFAULT` clause in its definition. This does not apply to `NULL`

columns (because such columns have a default of `NULL`), or to `AUTO_INCREMENT` columns (which have an implied default value).

The following example illustrates a typical use of the `flags` value:

```
if (field->flags & NOT_NULL_FLAG)
    printf("Field can't be null\n");
```

You may use the following convenience macros to determine the boolean status of the `flags` value.

Flag Status	Description
<code>IS_NOT_NULL(flags)</code>	True if this field is defined as <code>NOT NULL</code>
<code>IS_PRI_KEY(flags)</code>	True if this field is a primary key
<code>IS_BLOB(flags)</code>	True if this field is a <code>BLOB</code> or <code>TEXT</code> (deprecated; test <code>field-&gt;type</code> instead)

- `unsigned int decimals`

The number of decimals for numeric fields.

- `unsigned int charsetnr`

An ID number that indicates the character set/collation pair for the field.

To distinguish between binary and nonbinary data for string data types, check whether the `charsetnr` value is 63. If so, the character set is `binary`, which indicates binary rather than nonbinary data. This enables you to distinguish `BINARY` from `CHAR`, `VARBINARY` from `VARCHAR`, and the `BLOB` types from the `TEXT` types.

`charsetnr` values are the same as those displayed in the `Id` column of the `SHOW COLLATION` statement or the `ID` column of the `INFORMATION_SCHEMA.COLLATIONS` table. You can use those information sources to see which character set and collation specific `charsetnr` values indicate:

```
mysql> SHOW COLLATION WHERE Id = 63;
+-----+-----+-----+-----+-----+-----+
| Collation | Charset | Id | Default | Compiled | Sortlen |
+-----+-----+-----+-----+-----+-----+
| binary   | binary  | 63 | Yes     | Yes     | 1       |
+-----+-----+-----+-----+-----+-----+

mysql> SELECT COLLATION_NAME, CHARACTER_SET_NAME
-> FROM INFORMATION_SCHEMA.COLLATIONS WHERE ID = 33;
+-----+-----+
| COLLATION_NAME | CHARACTER_SET_NAME |
+-----+-----+
| utf8_general_ci | utf8                |
+-----+-----+
```

- `enum enum_field_types type`

The type of the field. The `type` value may be one of the `MYSQL_TYPE_` symbols shown in the following table.

Type Value	Type Description
<code>MYSQL_TYPE_TINY</code>	<code>TINYINT</code> field
<code>MYSQL_TYPE_SHORT</code>	<code>SMALLINT</code> field
<code>MYSQL_TYPE_LONG</code>	<code>INTEGER</code> field
<code>MYSQL_TYPE_INT24</code>	<code>MEDIUMINT</code> field
<code>MYSQL_TYPE_LONGLONG</code>	<code>BIGINT</code> field
<code>MYSQL_TYPE_DECIMAL</code>	<code>DECIMAL</code> or <code>NUMERIC</code> field
<code>MYSQL_TYPE_NEWDECIMAL</code>	Precision math <code>DECIMAL</code> or <code>NUMERIC</code>
<code>MYSQL_TYPE_FLOAT</code>	<code>FLOAT</code> field
<code>MYSQL_TYPE_DOUBLE</code>	<code>DOUBLE</code> or <code>REAL</code> field
<code>MYSQL_TYPE_BIT</code>	<code>BIT</code> field
<code>MYSQL_TYPE_TIMESTAMP</code>	<code>TIMESTAMP</code> field
<code>MYSQL_TYPE_DATE</code>	<code>DATE</code> field
<code>MYSQL_TYPE_TIME</code>	<code>TIME</code> field

<code>MYSQL_TYPE_DATETIME</code>	<code>DATETIME</code> field
<code>MYSQL_TYPE_YEAR</code>	<code>YEAR</code> field
<code>MYSQL_TYPE_STRING</code>	<code>CHAR</code> or <code>BINARY</code> field
<code>MYSQL_TYPE_VAR_STRING</code>	<code>VARCHAR</code> or <code>VARBINARY</code> field
<code>MYSQL_TYPE_BLOB</code>	<code>BLOB</code> or <code>TEXT</code> field (use <code>max_length</code> to determine the maximum length)
<code>MYSQL_TYPE_SET</code>	<code>SET</code> field
<code>MYSQL_TYPE_ENUM</code>	<code>ENUM</code> field
<code>MYSQL_TYPE_GEOMETRY</code>	Spatial field
<code>MYSQL_TYPE_NULL</code>	<code>NULL</code> -type field

You can use the `IS_NUM()` macro to test whether a field has a numeric type. Pass the `type` value to `IS_NUM()` and it evaluates to `TRUE` if the field is numeric:

```
if (IS_NUM(field->type))
    printf("Field is numeric\n");
```

## 20.10.2. C API Function Overview

The functions available in the C API are summarized here and described in greater detail in a later section. See [Section 20.10.3, “C API Function Descriptions”](#).

Function	Description
<code>my_init()</code>	Initialize global variables, and thread handler in thread-safe programs
<code>mysql_affected_rows()</code>	Returns the number of rows changed/deleted/inserted by the last <code>UPDATE</code> , <code>DELETE</code> , or <code>INSERT</code> query
<code>mysql_autocommit()</code>	Toggles autocommit mode on/off
<code>mysql_change_user()</code>	Changes user and database on an open connection
<code>mysql_character_set_name()</code>	Return default character set name for current connection
<code>mysql_close()</code>	Closes a server connection
<code>mysql_commit()</code>	Commits the transaction
<code>mysql_connect()</code>	Connects to a MySQL server (this function is deprecated; use <code>mysql_real_connect()</code> instead)
<code>mysql_create_db()</code>	Creates a database (this function is deprecated; use the SQL statement <code>CREATE DATABASE</code> instead)
<code>mysql_data_seek()</code>	Seeks to an arbitrary row number in a query result set
<code>mysql_debug()</code>	Does a <code>DEBUG_PUSH</code> with the given string
<code>mysql_drop_db()</code>	Drops a database (this function is deprecated; use the SQL statement <code>DROP DATABASE</code> instead)
<code>mysql_dump_debug_info()</code>	Makes the server write debug information to the log
<code>mysql_eof()</code>	Determines whether the last row of a result set has been read (this function is deprecated; <code>mysql_errno()</code> or <code>mysql_error()</code> may be used instead)
<code>mysql_errno()</code>	Returns the error number for the most recently invoked MySQL function
<code>mysql_error()</code>	Returns the error message for the most recently invoked MySQL function
<code>mysql_escape_string()</code>	Escapes special characters in a string for use in an SQL statement
<code>mysql_fetch_field()</code>	Returns the type of the next table field
<code>mysql_fetch_field_direct()</code>	Returns the type of a table field, given a field number
<code>mysql_fetch_fields()</code>	Returns an array of all field structures
<code>mysql_fetch_lengths()</code>	Returns the lengths of all columns in the current row
<code>mysql_fetch_row()</code>	Fetches the next row from the result set
<code>mysql_field_count()</code>	Returns the number of result columns for the most recent statement
<code>mysql_field_seek()</code>	Puts the column cursor on a specified column

<code>mysql_field_tell()</code>	Returns the position of the field cursor used for the last <code>mysql_fetch_field()</code>
<code>mysql_free_result()</code>	Frees memory used by a result set
<code>mysql_get_character_set_info()</code>	Return information about default character set
<code>mysql_get_client_info()</code>	Returns client version information as a string
<code>mysql_get_client_version()</code>	Returns client version information as an integer
<code>mysql_get_host_info()</code>	Returns a string describing the connection
<code>mysql_get_proto_info()</code>	Returns the protocol version used by the connection
<code>mysql_get_server_info()</code>	Returns the server version number
<code>mysql_get_server_version()</code>	Returns version number of server as an integer
<code>mysql_get_ssl_cipher()</code>	Return current SSL cipher
<code>mysql_hex_string()</code>	Encode string in hexadecimal format
<code>mysql_info()</code>	Returns information about the most recently executed query
<code>mysql_init()</code>	Gets or initializes a <code>MYSQL</code> structure
<code>mysql_insert_id()</code>	Returns the ID generated for an <code>AUTO_INCREMENT</code> column by the previous query
<code>mysql_kill()</code>	Kills a given thread
<code>mysql_library_end()</code>	Finalize the MySQL C API library
<code>mysql_library_init()</code>	Initialize the MySQL C API library
<code>mysql_list_dbs()</code>	Returns database names matching a simple regular expression
<code>mysql_list_fields()</code>	Returns field names matching a simple regular expression
<code>mysql_list_processes()</code>	Returns a list of the current server threads
<code>mysql_list_tables()</code>	Returns table names matching a simple regular expression
<code>mysql_more_results()</code>	Checks whether any more results exist
<code>mysql_next_result()</code>	Returns/initiates the next result in multiple-statement executions
<code>mysql_num_fields()</code>	Returns the number of columns in a result set
<code>mysql_num_rows()</code>	Returns the number of rows in a result set
<code>mysql_options()</code>	Sets connect options for <code>mysql_real_connect()</code>
<code>mysql_ping()</code>	Checks whether the connection to the server is working, reconnecting as necessary
<code>mysql_query()</code>	Executes an SQL query specified as a null-terminated string
<code>mysql_real_connect()</code>	Connects to a MySQL server
<code>mysql_real_escape_string()</code>	Escapes special characters in a string for use in an SQL statement, taking into account the current character set of the connection
<code>mysql_real_query()</code>	Executes an SQL query specified as a counted string
<code>mysql_refresh()</code>	Flush or reset tables and caches
<code>mysql_reload()</code>	Tells the server to reload the grant tables
<code>mysql_rollback()</code>	Rolls back the transaction
<code>mysql_row_seek()</code>	Seeks to a row offset in a result set, using value returned from <code>mysql_row_tell()</code>
<code>mysql_row_tell()</code>	Returns the row cursor position
<code>mysql_select_db()</code>	Selects a database
<code>mysql_server_end()</code>	Finalize the MySQL C API library
<code>mysql_server_init()</code>	Initialize the MySQL C API library
<code>mysql_set_character_set()</code>	Set default character set for current connection
<code>mysql_set_local_infile_default()</code>	Set the <code>LOAD DATA LOCAL INFILE</code> handler callbacks to their default values
<code>mysql_set_local_infile_handler()</code>	Install application-specific <code>LOAD DATA LOCAL INFILE</code> handler callbacks
<code>mysql_set_server_option()</code>	Sets an option for the connection (like <code>multi-statements</code> )
<code>mysql_sqlstate()</code>	Returns the <code>SQLSTATE</code> error code for the last error
<code>mysql_shutdown()</code>	Shuts down the database server
<code>mysql_ssl_set()</code>	Prepare to establish SSL connection to server



<code>mysql_stat()</code>	Returns the server status as a string
<code>mysql_store_result()</code>	Retrieves a complete result set to the client
<code>mysql_thread_end()</code>	Finalize thread handler
<code>mysql_thread_id()</code>	Returns the current thread ID
<code>mysql_thread_init()</code>	Initialize thread handler
<code>mysql_thread_safe()</code>	Returns 1 if the clients are compiled as thread-safe
<code>mysql_use_result()</code>	Initiates a row-by-row result set retrieval
<code>mysql_warning_count()</code>	Returns the warning count for the previous SQL statement

Application programs should use this general outline for interacting with MySQL:

1. Initialize the MySQL library by calling `mysql_library_init()`. This function exists in both the `mysqlclient` C client library and the `mysqld` embedded server library, so it is used whether you build a regular client program by linking with the `-libmysqlclient` flag, or an embedded server application by linking with the `-libmysqld` flag.
2. Initialize a connection handler by calling `mysql_init()` and connect to the server by calling `mysql_real_connect()`.
3. Issue SQL statements and process their results. (The following discussion provides more information about how to do this.)
4. Close the connection to the MySQL server by calling `mysql_close()`.
5. End use of the MySQL library by calling `mysql_library_end()`.

The purpose of calling `mysql_library_init()` and `mysql_library_end()` is to provide proper initialization and finalization of the MySQL library. For applications that are linked with the client library, they provide improved memory management. If you don't call `mysql_library_end()`, a block of memory remains allocated. (This does not increase the amount of memory used by the application, but some memory leak detectors will complain about it.) For applications that are linked with the embedded server, these calls start and stop the server.

In a non-multi-threaded environment, the call to `mysql_library_init()` may be omitted, because `mysql_init()` will invoke it automatically as necessary. However, `mysql_library_init()` is not thread-safe in a multi-threaded environment, and thus neither is `mysql_init()`, which calls `mysql_library_init()`. You must either call `mysql_library_init()` prior to spawning any threads, or else use a mutex to protect the call, whether you invoke `mysql_library_init()` or indirectly via `mysql_init()`. This should be done prior to any other client library call.

To connect to the server, call `mysql_init()` to initialize a connection handler, then call `mysql_real_connect()` with that handler (along with other information such as the host name, user name, and password). Upon connection, `mysql_real_connect()` sets the `reconnect` flag (part of the `MYSQL` structure) to a value of `1` in versions of the API older than 5.0.3, or `0` in newer versions. A value of `1` for this flag indicates that if a statement cannot be performed because of a lost connection, to try reconnecting to the server before giving up. You can use the `MYSQL_OPT_RECONNECT` option to `mysql_options()` to control reconnection behavior. When you are done with the connection, call `mysql_close()` to terminate it.

While a connection is active, the client may send SQL statements to the server using `mysql_query()` or `mysql_real_query()`. The difference between the two is that `mysql_query()` expects the query to be specified as a null-terminated string whereas `mysql_real_query()` expects a counted string. If the string contains binary data (which may include null bytes), you must use `mysql_real_query()`.

For each non-`SELECT` query (for example, `INSERT`, `UPDATE`, `DELETE`), you can find out how many rows were changed (affected) by calling `mysql_affected_rows()`.

For `SELECT` queries, you retrieve the selected rows as a result set. (Note that some statements are `SELECT`-like in that they return rows. These include `SHOW`, `DESCRIBE`, and `EXPLAIN`. They should be treated the same way as `SELECT` statements.)

There are two ways for a client to process result sets. One way is to retrieve the entire result set all at once by calling `mysql_store_result()`. This function acquires from the server all the rows returned by the query and stores them in the client. The second way is for the client to initiate a row-by-row result set retrieval by calling `mysql_use_result()`. This function initializes the retrieval, but does not actually get any rows from the server.

In both cases, you access rows by calling `mysql_fetch_row()`. With `mysql_store_result()`, `mysql_fetch_row()` accesses rows that have previously been fetched from the server. With `mysql_use_result()`, `mysql_fetch_row()` actually retrieves the row from the server. Information about the size of the data in each row is available by calling `mysql_fetch_lengths()`.



After you are done with a result set, call `mysql_free_result()` to free the memory used for it.

The two retrieval mechanisms are complementary. Client programs should choose the approach that is most appropriate for their requirements. In practice, clients tend to use `mysql_store_result()` more commonly.

An advantage of `mysql_store_result()` is that because the rows have all been fetched to the client, you not only can access rows sequentially, you can move back and forth in the result set using `mysql_data_seek()` or `mysql_row_seek()` to change the current row position within the result set. You can also find out how many rows there are by calling `mysql_num_rows()`. On the other hand, the memory requirements for `mysql_store_result()` may be very high for large result sets and you are more likely to encounter out-of-memory conditions.

An advantage of `mysql_use_result()` is that the client requires less memory for the result set because it maintains only one row at a time (and because there is less allocation overhead, `mysql_use_result()` can be faster). Disadvantages are that you must process each row quickly to avoid tying up the server, you don't have random access to rows within the result set (you can only access rows sequentially), and you don't know how many rows are in the result set until you have retrieved them all. Furthermore, you **must** retrieve all the rows even if you determine in mid-retrieval that you've found the information you were looking for.

The API makes it possible for clients to respond appropriately to statements (retrieving rows only as necessary) without knowing whether the statement is a `SELECT`. You can do this by calling `mysql_store_result()` after each `mysql_query()` (or `mysql_real_query()`). If the result set call succeeds, the statement was a `SELECT` and you can read the rows. If the result set call fails, call `mysql_field_count()` to determine whether a result was actually to be expected. If `mysql_field_count()` returns zero, the statement returned no data (indicating that it was an `INSERT`, `UPDATE`, `DELETE`, and so forth), and was not expected to return rows. If `mysql_field_count()` is nonzero, the statement should have returned rows, but didn't. This indicates that the statement was a `SELECT` that failed. See the description for `mysql_field_count()` for an example of how this can be done.

Both `mysql_store_result()` and `mysql_use_result()` allow you to obtain information about the fields that make up the result set (the number of fields, their names and types, and so forth). You can access field information sequentially within the row by calling `mysql_fetch_field()` repeatedly, or by field number within the row by calling `mysql_fetch_field_direct()`. The current field cursor position may be changed by calling `mysql_field_seek()`. Setting the field cursor affects subsequent calls to `mysql_fetch_field()`. You can also get information for fields all at once by calling `mysql_fetch_fields()`.

For detecting and reporting errors, MySQL provides access to error information by means of the `mysql_errno()` and `mysql_error()` functions. These return the error code or error message for the most recently invoked function that can succeed or fail, allowing you to determine when an error occurred and what it was.

### 20.10.3. C API Function Descriptions

In the descriptions here, a parameter or return value of `NULL` means `NULL` in the sense of the C programming language, not a MySQL `NULL` value.

Functions that return a value generally return a pointer or an integer. Unless specified otherwise, functions returning a pointer return a non-`NULL` value to indicate success or a `NULL` value to indicate an error, and functions returning an integer return zero to indicate success or nonzero to indicate an error. Note that “nonzero” means just that. Unless the function description says otherwise, do not test against a value other than zero:

```
if (result)                /* correct */
    ... error ...

if (result < 0)            /* incorrect */
    ... error ...

if (result == -1)         /* incorrect */
    ... error ...
```

When a function returns an error, the **Errors** subsection of the function description lists the possible types of errors. You can find out which of these occurred by calling `mysql_errno()`. A string representation of the error may be obtained by calling `mysql_error()`.

#### MySQL Enterprise

MySQL Enterprise subscribers will find more information about the C API functions in the Knowledge Base articles, [The C API](#). Access to the MySQL Knowledge Base collection of articles is one of the advantages of subscribing to MySQL Enterprise. For more information, see <http://www.mysql.com/products/enterprise/advisors.html>.

#### 20.10.3.1. `mysql_affected_rows()`

```
my_ulonglong mysql_affected_rows(MYSQL *mysql)
```

##### Description

After executing a statement with `mysql_query()` or `mysql_real_query()`, returns the number of rows changed (for `UPDATE`), deleted (for `DELETE`), or inserted (for `INSERT`). For `SELECT` statements, `mysql_affected_rows()` works like `mysql_num_rows()`.

### Return Values

An integer greater than zero indicates the number of rows affected or retrieved. Zero indicates that no records were updated for an `UPDATE` statement, no rows matched the `WHERE` clause in the query or that no query has yet been executed. -1 indicates that the query returned an error or that, for a `SELECT` query, `mysql_affected_rows()` was called prior to calling `mysql_store_result()`. Because `mysql_affected_rows()` returns an unsigned value, you can check for -1 by comparing the return value to `(my_ulonglong)-1` (or to `(my_ulonglong)~0`, which is equivalent).

### Errors

None.

### Example

```
char *stmt = "UPDATE products SET cost=cost*1.25 WHERE group=10";
mysql_query(&mysql,stmt);
printf("%ld products updated",
       (long) mysql_affected_rows(&mysql));
```

For `UPDATE` statements, if you specify the `CLIENT_FOUND_ROWS` flag when connecting to `mysqld`, `mysql_affected_rows()` returns the number of rows matched by the `WHERE` clause. Otherwise, the default behavior is to return the number of rows actually changed.

Note that when you use a `REPLACE` command, `mysql_affected_rows()` returns 2 if the new row replaced an old row, because in this case, one row was inserted after the duplicate was deleted.

If you use `INSERT ... ON DUPLICATE KEY UPDATE` to insert a row, `mysql_affected_rows()` returns 1 if the row is inserted as a new row and 2 if an existing row is updated.

`mysql_affected_rows()` returns 0 following a `CALL` statement for a stored procedure that contains a statement that modifies rows because in this case `mysql_insert_id()` applies to `CALL` and not the statement within the procedure. Within the procedure, you can use `ROW_COUNT()` at the SQL level to obtain the `AUTO_INCREMENT` value.

## 20.10.3.2. `mysql_autocommit()`

```
my_bool mysql_autocommit(MYSQL *mysql, my_bool mode)
```

### Description

Sets autocommit mode on if `mode` is 1, off if `mode` is 0.

### Return Values

Zero if successful. Nonzero if an error occurred.

### Errors

None.

## 20.10.3.3. `mysql_change_user()`

```
my_bool mysql_change_user(MYSQL *mysql, const char *user, const char *password, const char *db)
```

### Description

Changes the user and causes the database specified by `db` to become the default (current) database on the connection specified by `mysql`. In subsequent queries, this database is the default for table references that do not include an explicit database specifier.

`mysql_change_user()` fails if the connected user cannot be authenticated or doesn't have permission to use the database. In this case, the user and database are not changed.

The `db` parameter may be set to `NULL` if you don't want to have a default database.

This command resets the state as if one had done a new connect. (See [Section 20.10.11, "Controlling Automatic Reconnection Behavior"](#).) It always performs a `ROLLBACK` of any active transactions, closes and drops all temporary tables, and unlocks all locked tables. Session system variables are reset to the values of the corresponding global system variables. Prepared statements are re-

leased and `HANDLER` variables are closed. Locks acquired with `GET_LOCK()` are released. These effects occur even if the user didn't change.

### Return Values

Zero for success. Nonzero if an error occurred.

### Errors

The same that you can get from `mysql_real_connect()`.

- `CR_COMMANDS_OUT_OF_SYNC`  
Commands were executed in an improper order.
- `CR_SERVER_GONE_ERROR`  
The MySQL server has gone away.
- `CR_SERVER_LOST`  
The connection to the server was lost during the query.
- `CR_UNKNOWN_ERROR`  
An unknown error occurred.
- `ER_UNKNOWN_COM_ERROR`  
The MySQL server doesn't implement this command (probably an old server).
- `ER_ACCESS_DENIED_ERROR`  
The user or password was wrong.
- `ER_BAD_DB_ERROR`  
The database didn't exist.
- `ER_DBACCESS_DENIED_ERROR`  
The user did not have access rights to the database.
- `ER_WRONG_DB_NAME`  
The database name was too long.

### Example

```
if (mysql_change_user(&mysql, "user", "password", "new_database"))
{
    fprintf(stderr, "Failed to change user. Error: %s\n",
            mysql_error(&mysql));
}
```

## 20.10.3.4. `mysql_character_set_name()`

```
const char *mysql_character_set_name(MYSQL *mysql)
```

### Description

Returns the default character set name for the current connection.

### Return Values

The default character set name

### Errors

None.

### 20.10.3.5. `mysql_close()`

```
void mysql_close(MYSQL *mysql)
```

#### Description

Closes a previously opened connection. `mysql_close()` also deallocates the connection handle pointed to by `mysql` if the handle was allocated automatically by `mysql_init()` or `mysql_connect()`.

#### Return Values

None.

#### Errors

None.

### 20.10.3.6. `mysql_commit()`

```
my_bool mysql_commit(MYSQL *mysql)
```

#### Description

Commits the current transaction.

The action of this function is subject to the value of the `completion_type` system variable. In particular, if the value of `completion_type` is 2, the server performs a release after terminating a transaction and closes the client connection. The client program should call `mysql_close()` to close the connection from the client side.

#### Return Values

Zero if successful. Nonzero if an error occurred.

#### Errors

None.

### 20.10.3.7. `mysql_connect()`

```
MYSQL *mysql_connect(MYSQL *mysql, const char *host, const char *user, const char *passwd)
```

#### Description

This function is deprecated. Use `mysql_real_connect()` instead.

`mysql_connect()` attempts to establish a connection to a MySQL database engine running on `host`. `mysql_connect()` must complete successfully before you can execute any of the other API functions, with the exception of `mysql_get_client_info()`.

The meanings of the parameters are the same as for the corresponding parameters for `mysql_real_connect()` with the difference that the connection parameter may be `NULL`. In this case, the C API allocates memory for the connection structure automatically and frees it when you call `mysql_close()`. The disadvantage of this approach is that you can't retrieve an error message if the connection fails. (To get error information from `mysql_errno()` or `mysql_error()`, you must provide a valid `MYSQL` pointer.)

#### Return Values

Same as for `mysql_real_connect()`.

#### Errors

Same as for `mysql_real_connect()`.

### 20.10.3.8. `mysql_create_db()`

```
int mysql_create_db(MYSQL *mysql, const char *db)
```

#### Description

Creates the database named by the `db` parameter.

This function is deprecated. It is preferable to use `mysql_query()` to issue an SQL `CREATE DATABASE` statement instead.

#### Return Values

Zero if the database was created successfully. Nonzero if an error occurred.

#### Errors

- `CR_COMMANDS_OUT_OF_SYNC`  
Commands were executed in an improper order.
- `CR_SERVER_GONE_ERROR`  
The MySQL server has gone away.
- `CR_SERVER_LOST`  
The connection to the server was lost during the query.
- `CR_UNKNOWN_ERROR`  
An unknown error occurred.

#### Example

```
if(mysql_create_db(&mysql, "my_database"))
{
    fprintf(stderr, "Failed to create new database. Error: %s\n",
            mysql_error(&mysql));
}
```

### 20.10.3.9. `mysql_data_seek()`

```
void mysql_data_seek(MYSQL_RES *result, my_ulonglong offset)
```

#### Description

Seeks to an arbitrary row in a query result set. The `offset` value is a row number and should be in the range from 0 to `mysql_num_rows(result)-1`.

This function requires that the result set structure contains the entire result of the query, so `mysql_data_seek()` may be used only in conjunction with `mysql_store_result()`, not with `mysql_use_result()`.

#### Return Values

None.

#### Errors

None.

### 20.10.3.10. `mysql_debug()`

```
void mysql_debug(const char *debug)
```

#### Description

Does a `DEBUG_PUSH` with the given string. `mysql_debug()` uses the Fred Fish debug library. To use this function, you must compile the client library to support debugging. See [MySQL Internals: Porting](#).

#### Return Values

None.

#### Errors

None.

**Example**

The call shown here causes the client library to generate a trace file in `/tmp/client.trace` on the client machine:

```
mysql_debug("d:t:0,/tmp/client.trace");
```

**20.10.3.11. `mysql_drop_db()`**

```
int mysql_drop_db(MYSQL *mysql, const char *db)
```

**Description**

Drops the database named by the `db` parameter.

This function is deprecated. It is preferable to use `mysql_query()` to issue an SQL `DROP DATABASE` statement instead.

**Return Values**

Zero if the database was dropped successfully. Nonzero if an error occurred.

**Errors**

- `CR_COMMANDS_OUT_OF_SYNC`  
Commands were executed in an improper order.
- `CR_SERVER_GONE_ERROR`  
The MySQL server has gone away.
- `CR_SERVER_LOST`  
The connection to the server was lost during the query.
- `CR_UNKNOWN_ERROR`  
An unknown error occurred.

**Example**

```
if(mysql_drop_db(&mysql, "my_database"))  
    fprintf(stderr, "Failed to drop the database: Error: %s\n",  
           mysql_error(&mysql));
```

**20.10.3.12. `mysql_dump_debug_info()`**

```
int mysql_dump_debug_info(MYSQL *mysql)
```

**Description**

Instructs the server to write some debug information to the log. For this to work, the connected user must have the `SUPER` privilege.

**Return Values**

Zero if the command was successful. Nonzero if an error occurred.

**Errors**

- `CR_COMMANDS_OUT_OF_SYNC`  
Commands were executed in an improper order.
- `CR_SERVER_GONE_ERROR`  
The MySQL server has gone away.
- `CR_SERVER_LOST`

The connection to the server was lost during the query.

- `CR_UNKNOWN_ERROR`

An unknown error occurred.

### 20.10.3.13. `mysql_eof()`

```
my_bool mysql_eof(MYSQL_RES *result)
```

#### Description

This function is deprecated. `mysql_errno()` or `mysql_error()` may be used instead.

`mysql_eof()` determines whether the last row of a result set has been read.

If you acquire a result set from a successful call to `mysql_store_result()`, the client receives the entire set in one operation. In this case, a `NULL` return from `mysql_fetch_row()` always means the end of the result set has been reached and it is unnecessary to call `mysql_eof()`. When used with `mysql_store_result()`, `mysql_eof()` always returns true.

On the other hand, if you use `mysql_use_result()` to initiate a result set retrieval, the rows of the set are obtained from the server one by one as you call `mysql_fetch_row()` repeatedly. Because an error may occur on the connection during this process, a `NULL` return value from `mysql_fetch_row()` does not necessarily mean the end of the result set was reached normally. In this case, you can use `mysql_eof()` to determine what happened. `mysql_eof()` returns a nonzero value if the end of the result set was reached and zero if an error occurred.

Historically, `mysql_eof()` predates the standard MySQL error functions `mysql_errno()` and `mysql_error()`. Because those error functions provide the same information, their use is preferred over `mysql_eof()`, which is deprecated. (In fact, they provide more information, because `mysql_eof()` returns only a boolean value whereas the error functions indicate a reason for the error when one occurs.)

#### Return Values

Zero if no error occurred. Nonzero if the end of the result set has been reached.

#### Errors

None.

#### Example

The following example shows how you might use `mysql_eof()`:

```
mysql_query(&mysql,"SELECT * FROM some_table");
result = mysql_use_result(&mysql);
while((row = mysql_fetch_row(result)))
{
    // do something with data
}
if(!mysql_eof(result)) // mysql_fetch_row() failed due to an error
{
    fprintf(stderr, "Error: %s\n", mysql_error(&mysql));
}
```

However, you can achieve the same effect with the standard MySQL error functions:

```
mysql_query(&mysql,"SELECT * FROM some_table");
result = mysql_use_result(&mysql);
while((row = mysql_fetch_row(result)))
{
    // do something with data
}
if(mysql_errno(&mysql)) // mysql_fetch_row() failed due to an error
{
    fprintf(stderr, "Error: %s\n", mysql_error(&mysql));
}
```

### 20.10.3.14. `mysql_errno()`

```
unsigned int mysql_errno(MYSQL *mysql)
```

#### Description

For the connection specified by `mysql`, `mysql_errno()` returns the error code for the most recently invoked API function that can succeed or fail. A return value of zero means that no error occurred. Client error message numbers are listed in the MySQL `errmsg.h` header file. Server error message numbers are listed in `mysqld_error.h`. Errors also are listed at [Appendix B, Errors, Error Codes, and Common Problems](#).

Note that some functions like `mysql_fetch_row()` don't set `mysql_errno()` if they succeed.

A rule of thumb is that all functions that have to ask the server for information reset `mysql_errno()` if they succeed.

MySQL-specific error numbers returned by `mysql_errno()` differ from SQLSTATE values returned by `mysql_sqlstate()`. For example, the `mysql` client program displays errors using the following format, where `1146` is the `mysql_errno()` value and `'42S02'` is the corresponding `mysql_sqlstate()` value:

```
shell> SELECT * FROM no_such_table;
ERROR 1146 (42S02): Table 'test.no_such_table' doesn't exist
```

### Return Values

An error code value for the last `mysql_xxx()` call, if it failed. zero means no error occurred.

### Errors

None.

## 20.10.3.15. `mysql_error()`

```
const char *mysql_error(MYSQL *mysql)
```

### Description

For the connection specified by `mysql`, `mysql_error()` returns a null-terminated string containing the error message for the most recently invoked API function that failed. If a function didn't fail, the return value of `mysql_error()` may be the previous error or an empty string to indicate no error.

A rule of thumb is that all functions that have to ask the server for information reset `mysql_error()` if they succeed.

For functions that reset `mysql_error()`, the following two tests are equivalent:

```
if(*mysql_error(&mysql))
{
    // an error occurred
}

if(mysql_error(&mysql)[0])
{
    // an error occurred
}
```

The language of the client error messages may be changed by recompiling the MySQL client library. Currently, you can choose error messages in several different languages. See [Section 9.3, "Setting the Error Message Language"](#).

### Return Values

A null-terminated character string that describes the error. An empty string if no error occurred.

### Errors

None.

## 20.10.3.16. `mysql_escape_string()`

You should use `mysql_real_escape_string()` instead!

This function is identical to `mysql_real_escape_string()` except that `mysql_real_escape_string()` takes a connection handler as its first argument and escapes the string according to the current character set. `mysql_escape_string()` does not take a connection argument and does not respect the current character set.

## 20.10.3.17. `mysql_fetch_field()`

```
MYSQL_FIELD *mysql_fetch_field(MYSQL_RES *result)
```

### Description



Returns the definition of one column of a result set as a `MYSQL_FIELD` structure. Call this function repeatedly to retrieve information about all columns in the result set. `mysql_fetch_field()` returns `NULL` when no more fields are left.

`mysql_fetch_field()` is reset to return information about the first field each time you execute a new `SELECT` query. The field returned by `mysql_fetch_field()` is also affected by calls to `mysql_field_seek()`.

If you've called `mysql_query()` to perform a `SELECT` on a table but have not called `mysql_store_result()`, MySQL returns the default blob length (8KB) if you call `mysql_fetch_field()` to ask for the length of a `BLOB` field. (The 8KB size is chosen because MySQL doesn't know the maximum length for the `BLOB`. This should be made configurable sometime.) Once you've retrieved the result set, `field->max_length` contains the length of the largest value for this column in the specific query.

#### Return Values

The `MYSQL_FIELD` structure for the current column. `NULL` if no columns are left.

#### Errors

None.

#### Example

```
MYSQL_FIELD *field;

while((field = mysql_fetch_field(result)))
{
    printf("field name %s\n", field->name);
}
```

### 20.10.3.18. `mysql_fetch_field_direct()`

```
MYSQL_FIELD *mysql_fetch_field_direct(MYSQL_RES *result, unsigned int fieldnr)
```

#### Description

Given a field number `fieldnr` for a column within a result set, returns that column's field definition as a `MYSQL_FIELD` structure. You may use this function to retrieve the definition for an arbitrary column. The value of `fieldnr` should be in the range from 0 to `mysql_num_fields(result)-1`.

#### Return Values

The `MYSQL_FIELD` structure for the specified column.

#### Errors

None.

#### Example

```
unsigned int num_fields;
unsigned int i;
MYSQL_FIELD *field;

num_fields = mysql_num_fields(result);
for(i = 0; i < num_fields; i++)
{
    field = mysql_fetch_field_direct(result, i);
    printf("Field %u is %s\n", i, field->name);
}
```

### 20.10.3.19. `mysql_fetch_fields()`

```
MYSQL_FIELD *mysql_fetch_fields(MYSQL_RES *result)
```

#### Description

Returns an array of all `MYSQL_FIELD` structures for a result set. Each structure provides the field definition for one column of the result set.

#### Return Values

An array of `MYSQL_FIELD` structures for all columns of a result set.

#### Errors

None.

### Example

```
unsigned int num_fields;
unsigned int i;
MYSQL_FIELD *fields;

num_fields = mysql_num_fields(result);
fields = mysql_fetch_fields(result);
for(i = 0; i < num_fields; i++)
{
    printf("Field %u is %s\n", i, fields[i].name);
}
```

### 20.10.3.20. `mysql_fetch_lengths()`

```
unsigned long *mysql_fetch_lengths(MYSQL_RES *result)
```

#### Description

Returns the lengths of the columns of the current row within a result set. If you plan to copy field values, this length information is also useful for optimization, because you can avoid calling `strlen()`. In addition, if the result set contains binary data, you **must** use this function to determine the size of the data, because `strlen()` returns incorrect results for any field containing null characters.

The length for empty columns and for columns containing `NULL` values is zero. To see how to distinguish these two cases, see the description for `mysql_fetch_row()`.

#### Return Values

An array of unsigned long integers representing the size of each column (not including any terminating null characters). `NULL` if an error occurred.

#### Errors

`mysql_fetch_lengths()` is valid only for the current row of the result set. It returns `NULL` if you call it before calling `mysql_fetch_row()` or after retrieving all rows in the result.

#### Example

```
MYSQL_ROW row;
unsigned long *lengths;
unsigned int num_fields;
unsigned int i;

row = mysql_fetch_row(result);
if (row)
{
    num_fields = mysql_num_fields(result);
    lengths = mysql_fetch_lengths(result);
    for(i = 0; i < num_fields; i++)
    {
        printf("Column %u is %lu bytes in length.\n",
            i, lengths[i]);
    }
}
```

### 20.10.3.21. `mysql_fetch_row()`

```
MYSQL_ROW mysql_fetch_row(MYSQL_RES *result)
```

#### Description

Retrieves the next row of a result set. When used after `mysql_store_result()`, `mysql_fetch_row()` returns `NULL` when there are no more rows to retrieve. When used after `mysql_use_result()`, `mysql_fetch_row()` returns `NULL` when there are no more rows to retrieve or if an error occurred.

The number of values in the row is given by `mysql_num_fields(result)`. If `row` holds the return value from a call to `mysql_fetch_row()`, pointers to the values are accessed as `row[0]` to `row[mysql_num_fields(result)-1]`. `NULL` values in the row are indicated by `NULL` pointers.

The lengths of the field values in the row may be obtained by calling `mysql_fetch_lengths()`. Empty fields and fields containing `NULL` both have length 0; you can distinguish these by checking the pointer for the field value. If the pointer is `NULL`, the field is `NULL`; otherwise, the field is empty.

**Return Values**

A `MYSQL_ROW` structure for the next row. `NULL` if there are no more rows to retrieve or if an error occurred.

**Errors**

Note that error is not reset between calls to `mysql_fetch_row()`

- `CR_SERVER_LOST`

The connection to the server was lost during the query.

- `CR_UNKNOWN_ERROR`

An unknown error occurred.

**Example**

```
MYSQL_ROW row;
unsigned int num_fields;
unsigned int i;

num_fields = mysql_num_fields(result);
while ((row = mysql_fetch_row(result)))
{
    unsigned long *lengths;
    lengths = mysql_fetch_lengths(result);
    for(i = 0; i < num_fields; i++)
    {
        printf("[%s] ", (int) lengths[i],
            row[i] ? row[i] : "NULL");
    }
    printf("\n");
}
```

**20.10.3.22. `mysql_field_count()`**

```
unsigned int mysql_field_count(MYSQL *mysql)
```

**Description**

Returns the number of columns for the most recent query on the connection.

The normal use of this function is when `mysql_store_result()` returned `NULL` (and thus you have no result set pointer). In this case, you can call `mysql_field_count()` to determine whether `mysql_store_result()` should have produced a non-empty result. This allows the client program to take proper action without knowing whether the query was a `SELECT` (or `SELECT`-like) statement. The example shown here illustrates how this may be done.

See [Section 20.10.10.1, “Why `mysql\_store\_result\(\)` Sometimes Returns `NULL` After `mysql\_query\(\)` Returns Success”](#).

**Return Values**

An unsigned integer representing the number of columns in a result set.

**Errors**

None.

**Example**

```
MYSQL_RES *result;
unsigned int num_fields;
unsigned int num_rows;

if (mysql_query(&mysql, query_string))
{
    // error
}
else // query succeeded, process any data returned by it
{
    result = mysql_store_result(&mysql);
    if (result) // there are rows
    {
        num_fields = mysql_num_fields(result);
        // retrieve rows, then call mysql_free_result(result)
    }
}
```

```
else // mysql_store_result() returned nothing; should it have?
{
    if(mysql_field_count(&mysql) == 0)
    {
        // query does not return data
        // (it was not a SELECT)
        num_rows = mysql_affected_rows(&mysql);
    }
    else // mysql_store_result() should have returned data
    {
        fprintf(stderr, "Error: %s\n", mysql_error(&mysql));
    }
}
}
```

An alternative is to replace the `mysql_field_count(&mysql)` call with `mysql_errno(&mysql)`. In this case, you are checking directly for an error from `mysql_store_result()` rather than inferring from the value of `mysql_field_count()` whether the statement was a `SELECT`.

### 20.10.3.23. `mysql_field_seek()`

```
MYSQL_FIELD_OFFSET mysql_field_seek(MYSQL_RES *result, MYSQL_FIELD_OFFSET offset)
```

#### Description

Sets the field cursor to the given offset. The next call to `mysql_fetch_field()` retrieves the field definition of the column associated with that offset.

To seek to the beginning of a row, pass an `offset` value of zero.

#### Return Values

The previous value of the field cursor.

#### Errors

None.

### 20.10.3.24. `mysql_field_tell()`

```
MYSQL_FIELD_OFFSET mysql_field_tell(MYSQL_RES *result)
```

#### Description

Returns the position of the field cursor used for the last `mysql_fetch_field()`. This value can be used as an argument to `mysql_field_seek()`.

#### Return Values

The current offset of the field cursor.

#### Errors

None.

### 20.10.3.25. `mysql_free_result()`

```
void mysql_free_result(MYSQL_RES *result)
```

#### Description

Frees the memory allocated for a result set by `mysql_store_result()`, `mysql_use_result()`, `mysql_list_dbs()`, and so forth. When you are done with a result set, you must free the memory it uses by calling `mysql_free_result()`.

Do not attempt to access a result set after freeing it.

#### Return Values

None.

#### Errors

None.

### 20.10.3.26. `mysql_get_character_set_info()`

```
void mysql_get_character_set_info(MYSQL *mysql, MY_CHARSET_INFO *cs)
```

#### Description

This function provides information about the default client character set. The default character set may be changed with the `mysql_set_character_set()` function.

#### Example

This example shows the fields that are available in the `MY_CHARSET_INFO` structure:

```
if (!mysql_set_character_set(&mysql, "utf8"))
{
    MY_CHARSET_INFO cs;
    mysql_get_character_set_info(&mysql, &cs);
    printf("character set information:\n");
    printf("character set+collation number: %d\n", cs.number);
    printf("character set name: %s\n", cs.name);
    printf("collation name: %s\n", cs.csname);
    printf("comment: %s\n", cs.comment);
    printf("directory: %s\n", cs.dir);
    printf("multi byte character min. length: %d\n", cs.mbminlen);
    printf("multi byte character max. length: %d\n", cs.mbmaxlen);
}
```

### 20.10.3.27. `mysql_get_client_info()`

```
const char *mysql_get_client_info(void)
```

#### Description

Returns a string that represents the client library version.

#### Return Values

A character string that represents the MySQL client library version.

#### Errors

None.

### 20.10.3.28. `mysql_get_client_version()`

```
unsigned long mysql_get_client_version(void)
```

#### Description

Returns an integer that represents the client library version. The value has the format `XYZZZ` where `X` is the major version, `YY` is the release level, and `ZZ` is the version number within the release level. For example, a value of `40102` represents a client library version of `4.1.2`.

#### Return Values

An integer that represents the MySQL client library version.

#### Errors

None.

### 20.10.3.29. `mysql_get_host_info()`

```
const char *mysql_get_host_info(MYSQL *mysql)
```

#### Description

Returns a string describing the type of connection in use, including the server host name.

#### Return Values

A character string representing the server host name and the connection type.

**Errors**

None.

**20.10.3.30. `mysql_get_proto_info()`**

```
unsigned int mysql_get_proto_info(MYSQL *mysql)
```

**Description**

Returns the protocol version used by current connection.

**Return Values**

An unsigned integer representing the protocol version used by the current connection.

**Errors**

None.

**20.10.3.31. `mysql_get_server_info()`**

```
const char *mysql_get_server_info(MYSQL *mysql)
```

**Description**

Returns a string that represents the server version number.

**Return Values**

A character string that represents the server version number.

**Errors**

None.

**20.10.3.32. `mysql_get_server_version()`**

```
unsigned long mysql_get_server_version(MYSQL *mysql)
```

**Description**

Returns the version number of the server as an integer.

**Return Values**

A number that represents the MySQL server version in this format:

```
major_version*10000 + minor_version *100 + sub_version
```

For example, 5.1.5 is returned as 50105.

This function is useful in client programs for quickly determining whether some version-specific server capability exists.

**Errors**

None.

**20.10.3.33. `mysql_get_ssl_cipher()`**

```
const char *mysql_get_ssl_cipher(MYSQL *mysql)
```

**Description**

`mysql_get_ssl_cipher()` returns the SSL cipher used for the given connection to the server. `mysql` is the connection handler returned from `mysql_init()`.

This function was added in MySQL 5.1.11.

**Return Values**

A string naming the SSL cipher used for the connection, or `NULL` if no cipher is being used.

### 20.10.3.34. `mysql_hex_string()`

```
unsigned long mysql_hex_string(char *to, const char *from, unsigned long length)
```

#### Description

This function is used to create a legal SQL string that you can use in an SQL statement. See [Section 8.1.1, “Strings”](#).

The string in `from` is encoded to hexadecimal format, with each character encoded as two hexadecimal digits. The result is placed in `to` and a terminating null byte is appended.

The string pointed to by `from` must be `length` bytes long. You must allocate the `to` buffer to be at least `length*2+1` bytes long. When `mysql_hex_string()` returns, the contents of `to` is a null-terminated string. The return value is the length of the encoded string, not including the terminating null character.

The return value can be placed into an SQL statement using either `0xvalue` or `X'value'` format. However, the return value does not include the `0x` or `X'` ...'. The caller must supply whichever of those is desired.

#### Example

```
char query[1000],*end;

end = strmov(query,"INSERT INTO test_table values(");
end = strmov(end,"0x");
end += mysql_hex_string(end,"What is this",12);
end = strmov(end,"");
end += mysql_hex_string(end,"binary data: \0\r\n",16);
*end++ = '\0';

if (mysql_real_query(&mysql,query,(unsigned int) (end - query)))
{
    fprintf(stderr, "Failed to insert row, Error: %s\n",
            mysql_error(&mysql));
}
```

The `strmov()` function used in the example is included in the `mysqlclient` library and works like `strcpy()` but returns a pointer to the terminating null of the first parameter.

#### Return Values

The length of the value placed into `to`, not including the terminating null character.

#### Errors

None.

### 20.10.3.35. `mysql_info()`

```
const char *mysql_info(MYSQL *mysql)
```

#### Description

Retrieves a string providing information about the most recently executed statement, but only for the statements listed here. For other statements, `mysql_info()` returns `NULL`. The format of the string varies depending on the type of statement, as described here. The numbers are illustrative only; the string contains values appropriate for the statement.

- `INSERT INTO ... SELECT ...`  
String format: `Records: 100 Duplicates: 0 Warnings: 0`
- `INSERT INTO ... VALUES (...),(...),(...)...`  
String format: `Records: 3 Duplicates: 0 Warnings: 0`
- `LOAD DATA INFILE ...`  
String format: `Records: 1 Deleted: 0 Skipped: 0 Warnings: 0`
- `ALTER TABLE`  
String format: `Records: 3 Duplicates: 0 Warnings: 0`

- `UPDATE`

String format: `Rows matched: 40 Changed: 40 Warnings: 0`

Note that `mysql_info()` returns a non-`NULL` value for `INSERT ... VALUES` only for the multiple-row form of the statement (that is, only if multiple value lists are specified).

#### Return Values

A character string representing additional information about the most recently executed statement. `NULL` if no information is available for the statement.

#### Errors

None.

### 20.10.3.36. `mysql_init()`

```
MYSQL *mysql_init(MYSQL *mysql)
```

#### Description

Allocates or initializes a `MYSQL` object suitable for `mysql_real_connect()`. If `mysql` is a `NULL` pointer, the function allocates, initializes, and returns a new object. Otherwise, the object is initialized and the address of the object is returned. If `mysql_init()` allocates a new object, it is freed when `mysql_close()` is called to close the connection.

#### Return Values

An initialized `MYSQL*` handle. `NULL` if there was insufficient memory to allocate a new object.

#### Errors

In case of insufficient memory, `NULL` is returned.

### 20.10.3.37. `mysql_insert_id()`

```
my_ulonglong mysql_insert_id(MYSQL *mysql)
```

#### Description

Returns the value generated for an `AUTO_INCREMENT` column by the previous `INSERT` or `UPDATE` statement. Use this function after you have performed an `INSERT` statement into a table that contains an `AUTO_INCREMENT` field, or have used `INSERT` or `UPDATE` to set a column value with `LAST_INSERT_ID(expr)`.

The return value of `mysql_insert_id()` is always zero unless explicitly updated under one of the following conditions:

- `INSERT` statements that store a value into an `AUTO_INCREMENT` column. This is true whether the value is automatically generated by storing the special values `NULL` or `0` into the column, or is an explicit non-special value.
- In the case of a multiple-row `INSERT` statement, the return value of `mysql_insert_id()` depends on the MySQL server version.

In MySQL 5.1.12 and later, `mysql_insert_id()` returns the *first* automatically generated `AUTO_INCREMENT` value that was *successfully* inserted. In MySQL 5.1.11 and earlier, `mysql_insert_id()` returns the *first* automatically generated `AUTO_INCREMENT` value, regardless of whether insertion of that value was successful.

If no rows are successfully inserted, `mysql_insert_id()` returns 0.

- Starting in MySQL 5.1.12, if an `INSERT ... SELECT` statement is executed, and no automatically generated value is successfully inserted, `mysql_insert_id()` returns the ID of the last inserted row.
- Starting in MySQL 5.1.12, if an `INSERT ... SELECT` statement uses `LAST_INSERT_ID(expr)`, `mysql_insert_id()` returns `expr`.
- `INSERT` statements that generate an `AUTO_INCREMENT` value by inserting `LAST_INSERT_ID(expr)` into any column or by updating any column to `LAST_INSERT_ID(expr)`.
- If the previous statement returned an error, the value of `mysql_insert_id()` is undefined.



For 5.1.12 and later, the return value of `mysql_insert_id()` can be simplified to the following sequence:

1. If there is an `AUTO_INCREMENT` column, and an automatically generated value was successfully inserted, return the first such value.
2. If `LAST_INSERT_ID(expr)` occurred in the statement, return `expr`, even if there was an `AUTO_INCREMENT` column in the affected table.
3. The return value varies depending on the statement used. When called after an `INSERT` statement:
  - If there is an `AUTO_INCREMENT` column in the table, and there were some explicit values for this column that were successfully inserted into the table, return the last of the explicit values.

When called after an `INSERT ... ON DUPLICATE KEY UPDATE` statement:

- If there is an `AUTO_INCREMENT` column in the table and there were some explicit successfully inserted values, or some updated rows, return the last of the inserted or updated values.

`mysql_insert_id()` returns 0 if the previous statement does not use an `AUTO_INCREMENT` value. If you need to save the value for later, be sure to call `mysql_insert_id()` immediately after the statement that generates the value.

The value of `mysql_insert_id()` is affected only by statements issued within the current client connection. It is not affected by statements issued by other clients.

The `LAST_INSERT_ID()` SQL function returns the value of the first automatically generated value that was successfully inserted (starting from 5.1.12) or the first automatically generated value if any rows were successfully inserted (before 5.1.12). `LAST_INSERT_ID()` is not reset between statements because the value of that function is maintained in the server. Another difference from `mysql_insert_id()` is that `LAST_INSERT_ID()` is not updated if you set an `AUTO_INCREMENT` column to a specific non-special value. See [Section 11.11.3, “Information Functions”](#).

`mysql_insert_id()` returns 0 following a `CALL` statement for a stored procedure that generates an `AUTO_INCREMENT` value because in this case `mysql_insert_id()` applies to `CALL` and not the statement within the procedure. Within the procedure, you can use `LAST_INSERT_ID()` at the SQL level to obtain the `AUTO_INCREMENT` value.

The reason for the differences between `LAST_INSERT_ID()` and `mysql_insert_id()` is that `LAST_INSERT_ID()` is made easy to use in scripts while `mysql_insert_id()` tries to provide more exact information about what happens to the `AUTO_INCREMENT` column.

### Return Values

Described in the preceding discussion.

### Errors

None.

## 20.10.3.38. `mysql_kill()`

```
int mysql_kill(MYSQL *mysql, unsigned long pid)
```

### Description

Asks the server to kill the thread specified by `pid`.

This function is deprecated. It is preferable to use `mysql_query()` to issue an SQL `KILL` statement instead.

### Return Values

Zero for success. Nonzero if an error occurred.

### Errors

- `CR_COMMANDS_OUT_OF_SYNC`  
Commands were executed in an improper order.
- `CR_SERVER_GONE_ERROR`

The MySQL server has gone away.

- `CR_SERVER_LOST`

The connection to the server was lost during the query.

- `CR_UNKNOWN_ERROR`

An unknown error occurred.

### 20.10.3.39. `mysql_library_end()`

```
void mysql_library_end(void)
```

#### Description

This function finalizes the MySQL library. You should call it when you are done using the library (for example, after disconnecting from the server). The action taken by the call depends on whether your application is linked to the MySQL client library or the MySQL embedded server library. For a client program linked against the `libmysqlclient` library by using the `-lmysqlclient` flag, `mysql_library_end()` performs some memory management to clean up. For an embedded server application linked against the `libmysqld` library by using the `-lmysqld` flag, `mysql_library_end()` shuts down the embedded server and then cleans up.

For usage information, see [Section 20.10.2, “C API Function Overview”](#), and [Section 20.10.3.40, “mysql\\_library\\_init\(\)”](#).

### 20.10.3.40. `mysql_library_init()`

```
int mysql_library_init(int argc, char **argv, char **groups)
```

#### Description

This function should be called to initialize the MySQL library before you call any other MySQL function, whether your application is a regular client program or uses the embedded server. If the application uses the embedded server, this call starts the server and initializes any subsystems (`mysys`, `InnoDB`, and so forth) that the server uses.

After your application is done using the MySQL library, call `mysql_library_end()` to clean up. See [Section 20.10.3.39, “mysql\\_library\\_end\(\)”](#).

The choice of whether the application operates as a regular client or uses the embedded server depends on whether you use the `libmysqlclient` or `libmysqld` library at link time to produce the final executable. For additional information, see [Section 20.10.2, “C API Function Overview”](#).

In a non-multi-threaded environment, the call to `mysql_library_init()` may be omitted, because `mysql_init()` will invoke it automatically as necessary. However, `mysql_library_init()` is not thread-safe in a multi-threaded environment, and thus neither is `mysql_init()`, which calls `mysql_library_init()`. You must either call `mysql_library_init()` prior to spawning any threads, or else use a mutex to protect the call, whether you invoke `mysql_library_init()` or indirectly via `mysql_init()`. This should be done prior to any other client library call.

The `argc` and `argv` arguments are analogous to the arguments to `main()`, and enable passing of options to the embedded server. For convenience, `argc` may be 0 (zero) if there are no command-line arguments for the server. This is the usual case for applications intended for use only as regular (non-embedded) clients, and the call typically is written as `mysql_library_init(0, NULL, NULL)`.

```
#include <mysql.h>
#include <stdlib.h>

int main(void) {
    if (mysql_library_init(0, NULL, NULL)) {
        fprintf(stderr, "could not initialize MySQL library\n");
        exit(1);
    }

    /* Use any MySQL API functions here */

    mysql_library_end();

    return EXIT_SUCCESS;
}
```

When arguments are to be passed (`argc` is greater than 0), the first element of `argv` is ignored (it typically contains the program name). `mysql_library_init()` makes a copy of the arguments so it is safe to destroy `argv` or `groups` after the call.

For embedded applications, if you want to connect to an external server without starting the embedded server, you have to specify a negative value for `argc`.

The `groups` argument should be an array of strings that indicate the groups in option files from which options should be read. See [Section 4.2.3.2, “Using Option Files”](#). The final entry in the array should be `NULL`. For convenience, if the `groups` argument itself is `NULL`, the `[server]` and `[embedded]` groups are used by default.

```
#include <mysql.h>
#include <stdlib.h>

static char *server_args[] = {
    "this_program", /* this string is not used */
    "--datadir=.",
    "--key_buffer_size=32M"
};
static char *server_groups[] = {
    "embedded",
    "server",
    "this_program_SERVER",
    (char *)NULL
};

int main(void) {
    if (mysql_library_init(sizeof(server_args) / sizeof(char *),
                          server_args, server_groups)) {
        fprintf(stderr, "could not initialize MySQL library\n");
        exit(1);
    }

    /* Use any MySQL API functions here */

    mysql_library_end();

    return EXIT_SUCCESS;
}
```

### Return Values

Zero if successful. Nonzero if an error occurred.

## 20.10.3.41. `mysql_list_dbs()`

```
MYSQL_RES *mysql_list_dbs(MYSQL *mysql, const char *wild)
```

### Description

Returns a result set consisting of database names on the server that match the simple regular expression specified by the `wild` parameter. `wild` may contain the wildcard characters “%” or “\_”, or may be a `NULL` pointer to match all databases. Calling `mysql_list_dbs()` is similar to executing the query `SHOW DATABASES [LIKE wild]`.

You must free the result set with `mysql_free_result()`.

### Return Values

A `MYSQL_RES` result set for success. `NULL` if an error occurred.

### Errors

- `CR_COMMANDS_OUT_OF_SYNC`  
Commands were executed in an improper order.
- `CR_OUT_OF_MEMORY`  
Out of memory.
- `CR_SERVER_GONE_ERROR`  
The MySQL server has gone away.
- `CR_SERVER_LOST`  
The connection to the server was lost during the query.
- `CR_UNKNOWN_ERROR`  
An unknown error occurred.

### 20.10.3.42. `mysql_list_fields()`

```
MYSQL_RES *mysql_list_fields(MYSQL *mysql, const char *table, const char *wild)
```

#### Description

Returns a result set consisting of field names in the given table that match the simple regular expression specified by the `wild` parameter. `wild` may contain the wildcard characters “%” or “\_”, or may be a `NULL` pointer to match all fields. Calling `mysql_list_fields()` is similar to executing the query `SHOW COLUMNS FROM tbl_name [LIKE wild]`.

It is recommended that you use `SHOW COLUMNS FROM tbl_name` instead of `mysql_list_fields()`.

You must free the result set with `mysql_free_result()`.

#### Return Values

A `MYSQL_RES` result set for success. `NULL` if an error occurred.

#### Errors

- `CR_COMMANDS_OUT_OF_SYNC`  
Commands were executed in an improper order.
- `CR_SERVER_GONE_ERROR`  
The MySQL server has gone away.
- `CR_SERVER_LOST`  
The connection to the server was lost during the query.
- `CR_UNKNOWN_ERROR`  
An unknown error occurred.

### 20.10.3.43. `mysql_list_processes()`

```
MYSQL_RES *mysql_list_processes(MYSQL *mysql)
```

#### Description

Returns a result set describing the current server threads. This is the same kind of information as that reported by `mysqladmin processlist` or a `SHOW PROCESSLIST` query.

You must free the result set with `mysql_free_result()`.

#### Return Values

A `MYSQL_RES` result set for success. `NULL` if an error occurred.

#### Errors

- `CR_COMMANDS_OUT_OF_SYNC`  
Commands were executed in an improper order.
- `CR_SERVER_GONE_ERROR`  
The MySQL server has gone away.
- `CR_SERVER_LOST`  
The connection to the server was lost during the query.
- `CR_UNKNOWN_ERROR`  
An unknown error occurred.

### 20.10.3.44. `mysql_list_tables()`

```
MYSQL_RES *mysql_list_tables(MYSQL *mysql, const char *wild)
```

#### Description

Returns a result set consisting of table names in the current database that match the simple regular expression specified by the `wild` parameter. `wild` may contain the wildcard characters “%” or “\_”, or may be a `NULL` pointer to match all tables. Calling `mysql_list_tables()` is similar to executing the query `SHOW TABLES [LIKE wild]`.

You must free the result set with `mysql_free_result()`.

#### Return Values

A `MYSQL_RES` result set for success. `NULL` if an error occurred.

#### Errors

- `CR_COMMANDS_OUT_OF_SYNC`  
Commands were executed in an improper order.
- `CR_SERVER_GONE_ERROR`  
The MySQL server has gone away.
- `CR_SERVER_LOST`  
The connection to the server was lost during the query.
- `CR_UNKNOWN_ERROR`  
An unknown error occurred.

### 20.10.3.45. `mysql_more_results()`

```
my_bool mysql_more_results(MYSQL *mysql)
```

#### Description

This function is used when you execute multiple statements specified as a single statement string, or when you execute `CALL` statements, which can return multiple result sets.

`mysql_more_results()` true if more results exist from the currently executed statement, in which case the application must call `mysql_next_result()` to fetch the results.

#### Return Values

`TRUE` (1) if more results exist. `FALSE` (0) if no more results exist.

In most cases, you can call `mysql_next_result()` instead to test whether more results exist and initiate retrieval if so.

See [Section 20.10.12, “C API Support for Multiple Statement Execution”](#), and [Section 20.10.3.46, “mysql\\_next\\_result\(\)”](#).

#### Errors

None.

### 20.10.3.46. `mysql_next_result()`

```
int mysql_next_result(MYSQL *mysql)
```

#### Description

This function is used when you execute multiple statements specified as a single statement string, or when you use `CALL` statements to execute stored procedures, which can return multiple result sets.

`mysql_next_result()` reads the next statement result and returns a status to indicate whether more results exist. If `mysql_next_result()` returns an error, there are no more results.

Before each call to `mysql_next_result()`, you must call `mysql_free_result()` for the current statement if it is a statement that returned a result set (rather than just a result status).

After calling `mysql_next_result()` the state of the connection is as if you had called `mysql_real_query()` or `mysql_query()` for the next statement. This means that you can call `mysql_store_result()`, `mysql_warning_count()`, `mysql_affected_rows()`, and so forth.

If your program uses `CALL` statements to execute stored procedures, the `CLIENT_MULTI_RESULTS` flag must be enabled. This is because each `CALL` returns a result to indicate the call status, in addition to any result sets that might be returned by statements executed within the procedure. Because `CALL` can return multiple results, you should process them using a loop that calls `mysql_next_result()` to determine whether there are more results.

`CLIENT_MULTI_RESULTS` can be enabled when you call `mysql_real_connect()`, either explicitly by passing the `CLIENT_MULTI_RESULTS` flag itself, or implicitly by passing `CLIENT_MULTI_STATEMENTS` (which also enables `CLIENT_MULTI_RESULTS`).

It is also possible to test whether there are more results by calling `mysql_more_results()`. However, this function does not change the connection state, so if it returns true, you must still call `mysql_next_result()` to advance to the next result.

For an example that shows how to use `mysql_next_result()`, see [Section 20.10.12, “C API Support for Multiple Statement Execution”](#).

### Return Values

Return Value	Description
0	Successful and there are more results
-1	Successful and there are no more results
>0	An error occurred

### Errors

- `CR_COMMANDS_OUT_OF_SYNC`

Commands were executed in an improper order. For example if you didn't call `mysql_use_result()` for a previous result set.

- `CR_SERVER_GONE_ERROR`

The MySQL server has gone away.

- `CR_SERVER_LOST`

The connection to the server was lost during the query.

- `CR_UNKNOWN_ERROR`

An unknown error occurred.

### 20.10.3.47. `mysql_num_fields()`

```
unsigned int mysql_num_fields(MYSQL_RES *result)
```

To pass a `MYSQL*` argument instead, use `unsigned int mysql_field_count(MYSQL *mysql)`.

#### Description

Returns the number of columns in a result set.

Note that you can get the number of columns either from a pointer to a result set or to a connection handle. You would use the connection handle if `mysql_store_result()` or `mysql_use_result()` returned `NULL` (and thus you have no result set pointer). In this case, you can call `mysql_field_count()` to determine whether `mysql_store_result()` should have produced a non-empty result. This allows the client program to take proper action without knowing whether the query was a `SELECT` (or `SELECT`-like) statement. The example shown here illustrates how this may be done.

See [Section 20.10.10.1, “Why `mysql\_store\_result\(\)` Sometimes Returns `NULL` After `mysql\_query\(\)` Returns Success”](#).

**Return Values**

An unsigned integer representing the number of columns in a result set.

**Errors**

None.

**Example**

```

MYSQL_RES *result;
unsigned int num_fields;
unsigned int num_rows;

if (mysql_query(&mysql, query_string))
{
    // error
}
else // query succeeded, process any data returned by it
{
    result = mysql_store_result(&mysql);
    if (result) // there are rows
    {
        num_fields = mysql_num_fields(result);
        // retrieve rows, then call mysql_free_result(result)
    }
    else // mysql_store_result() returned nothing; should it have?
    {
        if (mysql_errno(&mysql))
        {
            fprintf(stderr, "Error: %s\n", mysql_error(&mysql));
        }
        else if (mysql_field_count(&mysql) == 0)
        {
            // query does not return data
            // (it was not a SELECT)
            num_rows = mysql_affected_rows(&mysql);
        }
    }
}

```

An alternative (if you know that your query should have returned a result set) is to replace the `mysql_errno(&mysql)` call with a check whether `mysql_field_count(&mysql)` returns 0. This happens only if something went wrong.

**20.10.3.48. `mysql_num_rows()`**

```
my_ulonglong mysql_num_rows(MYSQL_RES *result)
```

**Description**

Returns the number of rows in the result set.

The use of `mysql_num_rows()` depends on whether you use `mysql_store_result()` or `mysql_use_result()` to return the result set. If you use `mysql_store_result()`, `mysql_num_rows()` may be called immediately. If you use `mysql_use_result()`, `mysql_num_rows()` does not return the correct value until all the rows in the result set have been retrieved.

`mysql_num_rows()` is intended for use with statements that return a result set, such as `SELECT`. For statements such as `INSERT`, `UPDATE`, or `DELETE`, the number of affected rows can be obtained with `mysql_affected_rows()`.

**Return Values**

The number of rows in the result set.

**Errors**

None.

**20.10.3.49. `mysql_options()`**

```
int mysql_options(MYSQL *mysql, enum mysql_option option, const void *arg)
```

**Description**

Can be used to set extra connect options and affect behavior for a connection. This function may be called multiple times to set several options.

`mysql_options()` should be called after `mysql_init()` and before `mysql_connect()` or `mysql_real_connect()`.

The `option` argument is the option that you want to set; the `arg` argument is the value for the option. If the option is an integer, `arg` should point to the value of the integer.

The following list describes the possible options, their effect, and how `arg` is used for each option. Several of the options apply only when the application is linked against the `libmysqld` embedded server library and are unused for applications linked against the `libmysql` client library. For option descriptions that indicate `arg` is unused, its value is irrelevant; it is conventional to pass 0.

- `MYSQL_INIT_COMMAND` (argument type: `char *`)  
SQL statement to execute when connecting to the MySQL server. Automatically re-executed if reconnection occurs.
- `MYSQL_OPT_COMPRESS` (argument: not used)  
Use the compressed client/server protocol.
- `MYSQL_OPT_CONNECT_TIMEOUT` (argument type: `unsigned int *`)  
Connect timeout in seconds.
- `MYSQL_OPT_GUESS_CONNECTION` (argument: not used)  
For an application linked against the `libmysqld` embedded server library, this allows the library to guess whether to use the embedded server or a remote server. “Guess” means that if the host name is set and is not `localhost`, it uses a remote server. This behavior is the default. `MYSQL_OPT_USE_EMBEDDED_CONNECTION` and `MYSQL_OPT_USE_REMOTE_CONNECTION` can be used to override it. This option is ignored for applications linked against the `libmysqlclient` client library.
- `MYSQL_OPT_LOCAL_INFILE` (argument type: optional pointer to `unsigned int`)  
If no pointer is given or if pointer points to an `unsigned int` that has a nonzero value, the `LOAD LOCAL INFILE` statement is enabled.
- `MYSQL_OPT_NAMED_PIPE` (argument: not used)  
Use named pipes to connect to a MySQL server on Windows, if the server allows named-pipe connections.
- `MYSQL_OPT_PROTOCOL` (argument type: `unsigned int *`)  
Type of protocol to use. Should be one of the enum values of `mysql_protocol_type` defined in `mysql.h`.
- `MYSQL_OPT_READ_TIMEOUT` (argument type: `unsigned int *`)  
The timeout in seconds for attempts to read from the server. Each attempt uses this timeout value and there are retries if necessary, so the total effective timeout value is three times the option value. You can set the value so that a lost connection can be detected earlier than the TCP/IP `Close_Wait_Timeout` value of 10 minutes. This option works only for TCP/IP connections and, prior to MySQL 5.1.12, only for Windows.
- `MYSQL_OPT_RECONNECT` (argument type: `my_bool *`)  
Enable or disable automatic reconnection to the server if the connection is found to have been lost. Reconnect is off by default; this option provides a way to set reconnection behavior explicitly.  
  
Note: `mysql_real_connect()` incorrectly reset the `MYSQL_OPT_RECONNECT` option to its default value before MySQL 5.1.6. Therefore, prior to that version, if you want reconnect to be enabled for each connection, you must call `mysql_options()` with the `MYSQL_OPT_RECONNECT` option after each call to `mysql_real_connect()`. This is not necessary as of 5.1.6: Call `mysql_options()` only before `mysql_real_connect()` as usual.
- `MYSQL_SET_CLIENT_IP` (argument type: `char *`)  
For an application linked against the `libmysqld` embedded server library (when `libmysqld` is compiled with authentication support), this means that the user is considered to have connected from the specified IP address (specified as a string) for authentication purposes. This option is ignored for applications linked against the `libmysqlclient` client library.
- `MYSQL_OPT_SSL_VERIFY_SERVER_CERT` (argument type: `my_bool *`)  
Enable or disable verification of the server's Common Name value in its certificate against the host name used when connecting to the server. The connection is rejected if there is a mismatch. This feature can be used to prevent man-in-the-middle attacks. Verification is disabled by default. Added in MySQL 5.1.11.



- `MYSQL_OPT_USE_EMBEDDED_CONNECTION` (argument: not used)

For an application linked against the `libmysqld` embedded server library, this forces the use of the embedded server for the connection. This option is ignored for applications linked against the `libmysqlclient` client library.

- `MYSQL_OPT_USE_REMOTE_CONNECTION` (argument: not used)

For an application linked against the `libmysqld` embedded server library, this forces the use of a remote server for the connection. This option is ignored for applications linked against the `libmysqlclient` client library.

- `MYSQL_OPT_USE_RESULT` (argument: not used)

This option is unused.

- `MYSQL_OPT_WRITE_TIMEOUT` (argument type: `unsigned int *`)

The timeout in seconds for attempts to write to the server. Each attempt uses this timeout value and there are `net_retry_count` retries if necessary, so the total effective timeout value is `net_retry_count` times the option value. This option works only for TCP/IP connections and, prior to MySQL 5.1.12, only for Windows.

- `MYSQL_READ_DEFAULT_FILE` (argument type: `char *`)

Read options from the named option file instead of from `my.cnf`.

- `MYSQL_READ_DEFAULT_GROUP` (argument type: `char *`)

Read options from the named group from `my.cnf` or the file specified with `MYSQL_READ_DEFAULT_FILE`.

- `MYSQL_REPORT_DATA_TRUNCATION` (argument type: `my_bool *`)

Enable or disable reporting of data truncation errors for prepared statements via the `error` member of `MYSQL_BIND` structures. (Default: enabled.)

- `MYSQL_SECURE_AUTH` (argument type: `my_bool *`)

Whether to connect to a server that does not support the password hashing used in MySQL 4.1.1 and later.

- `MYSQL_SET_CHARSET_DIR` (argument type: `char *`)

The path name to the directory that contains character set definition files.

- `MYSQL_SET_CHARSET_NAME` (argument type: `char *`)

The name of the character set to use as the default character set.

- `MYSQL_SHARED_MEMORY_BASE_NAME` (argument type: `char *`)

The name of the shared-memory object for communication to the server on Windows, if the server supports shared-memory connections. Should have the same value as the `--shared-memory-base-name` option used for the `mysqld` server you want to connect to.

The `client` group is always read if you use `MYSQL_READ_DEFAULT_FILE` or `MYSQL_READ_DEFAULT_GROUP`.

The specified group in the option file may contain the following options.

Option	Description
<code>character-sets-dir=path</code>	The directory where character sets are installed.
<code>compress</code>	Use the compressed client/server protocol.
<code>connect-timeout=seconds</code>	Connect timeout in seconds. On Linux this timeout is also used for waiting for the first answer from the server.
<code>database=db_name</code>	Connect to this database if no database was specified in the connect command.
<code>debug</code>	Debug options.
<code>default-character-set=charset_name</code>	The default character set to use.
<code>disable-local-infile</code>	Disable use of <code>LOAD DATA LOCAL</code> .
<code>host=host_name</code>	Default host name.

<code>init-command=stmt</code>	Statement to execute when connecting to MySQL server. Automatically re-executed if reconnection occurs.
<code>interactive-timeout=seconds</code>	Same as specifying <code>CLIENT_INTERACTIVE</code> to <code>mysql_real_connect()</code> . See <a href="#">Section 20.10.3.52</a> , “ <code>mysql_real_connect()</code> ”.
<code>local-infile[={0 1}]</code>	If no argument or nonzero argument, enable use of <code>LOAD DATA LOCAL</code> ; otherwise disable.
<code>max_allowed_packet=bytes</code>	Maximum size of packet that client can read from server.
<code>multi-queries, multi-results</code>	Allow multiple result sets from multiple-statement executions or stored procedures.
<code>multi-statements</code>	Allow the client to send multiple statements in a single string (separated by “;”).
<code>password=password</code>	Default password.
<code>pipe</code>	Use named pipes to connect to a MySQL server on Windows.
<code>port=port_num</code>	Default port number.
<code>protocol={TCP SOCKET PIPE MEMORY}</code>	The protocol to use when connecting to the server.
<code>return-found-rows</code>	Tell <code>mysql_info()</code> to return found rows instead of updated rows when using <code>UPDATE</code> .
<code>shared-memory-base-name=name</code>	Shared-memory name to use to connect to server.
<code>socket=path</code>	Default socket file.
<code>ssl-ca=file_name</code>	Certificate Authority file.
<code>ssl-capath=path</code>	Certificate Authority directory.
<code>ssl-cert=file_name</code>	Certificate file.
<code>ssl-cipher=cipher_list</code>	Allowable SSL ciphers.
<code>ssl-key=file_name</code>	Key file.
<code>timeout=seconds</code>	Like <code>connect-timeout</code> .
<code>user</code>	Default user.

`timeout` has been replaced by `connect-timeout`, but `timeout` is still supported in MySQL 5.1 for backward compatibility.

For more information about option files, see [Section 4.2.3.2](#), “Using Option Files”.

Before MySQL 5.1.18, the `arg` argument was declared as `char *`.

### Return Values

Zero for success. Nonzero if you specify an unknown option.

### Example

The following `mysql_options()` calls request the use of compression in the client/server protocol, cause options to be read from the `[odbc]` group of option files, and disable transaction autocommit mode:

```
MYSQL mysql;

mysql_init(&mysql);
mysql_options(&mysql, MYSQL_OPT_COMPRESS, 0);
mysql_options(&mysql, MYSQL_READ_DEFAULT_GROUP, "odbc");
mysql_options(&mysql, MYSQL_INIT_COMMAND, "SET autocommit=0");
if (!mysql_real_connect(&mysql, "host", "user", "passwd", "database", 0, NULL, 0))
{
    fprintf(stderr, "Failed to connect to database: Error: %s\n",
            mysql_error(&mysql));
}
```

This code requests that the client use the compressed client/server protocol and read the additional options from the `odbc` section in the `my.cnf` file.

## 20.10.3.50. `mysql_ping()`

```
int mysql_ping(MYSQL *mysql)
```

### Description

Checks whether the connection to the server is working. If the connection has gone down and auto-reconnect is enabled an attempt

to reconnect is made. If the connection is down and auto-reconnect is disabled, `mysql_ping()` returns an error.

Auto-reconnect is disabled by default. To enable it, call `mysql_options()` with the `MYSQL_OPT_RECONNECT` option. For details, see [Section 20.10.3.49](#), “`mysql_options()`”.

`mysql_ping()` can be used by clients that remain idle for a long while, to check whether the server has closed the connection and reconnect if necessary.

If `mysql_ping()` does cause a reconnect, there is no explicit indication of it. To determine whether a reconnect occurs, call `mysql_thread_id()` to get the original connection identifier before calling `mysql_ping()`, and then call `mysql_thread_id()` again to see whether the identifier has changed.

If reconnect occurs, some characteristics of the connection will have been reset. For details about these characteristics, see [Section 20.10.11](#), “Controlling Automatic Reconnection Behavior”.

### Return Values

Zero if the connection to the server is alive. Nonzero if an error occurred. A nonzero return does not indicate whether the MySQL server itself is down; the connection might be broken for other reasons such as network problems.

### Errors

- `CR_COMMANDS_OUT_OF_SYNC`  
Commands were executed in an improper order.
- `CR_SERVER_GONE_ERROR`  
The MySQL server has gone away.
- `CR_UNKNOWN_ERROR`  
An unknown error occurred.

## 20.10.3.51. `mysql_query()`

```
int mysql_query(MYSQL *mysql, const char *stmt_str)
```

### Description

Executes the SQL statement pointed to by the null-terminated string `stmt_str`. Normally, the string must consist of a single SQL statement and you should not add a terminating semicolon (“;”) or `\g` to the statement. If multiple-statement execution has been enabled, the string can contain several statements separated by semicolons. See [Section 20.10.12](#), “C API Support for Multiple Statement Execution”.

`mysql_query()` cannot be used for statements that contain binary data; you must use `mysql_real_query()` instead. (Binary data may contain the “\0” character, which `mysql_query()` interprets as the end of the statement string.)

If you want to know whether the statement should return a result set, you can use `mysql_field_count()` to check for this. See [Section 20.10.3.22](#), “`mysql_field_count()`”.

### Return Values

Zero if the statement was successful. Nonzero if an error occurred.

### Errors

- `CR_COMMANDS_OUT_OF_SYNC`  
Commands were executed in an improper order.
- `CR_SERVER_GONE_ERROR`  
The MySQL server has gone away.
- `CR_SERVER_LOST`  
The connection to the server was lost during the query.

- `CR_UNKNOWN_ERROR`

An unknown error occurred.

### 20.10.3.52. `mysql_real_connect()`

```
MYSQL *mysql_real_connect(MYSQL *mysql, const char *host, const char *user, const char
*passwd, const char *db, unsigned int port, const char *unix_socket, unsigned long cli-
ent_flag)
```

#### Description

`mysql_real_connect()` attempts to establish a connection to a MySQL database engine running on `host`. `mysql_real_connect()` must complete successfully before you can execute any other API functions that require a valid MySQL connection handle structure.

The parameters are specified as follows:

- The first parameter should be the address of an existing `MYSQL` structure. Before calling `mysql_real_connect()` you must call `mysql_init()` to initialize the `MYSQL` structure. You can change a lot of connect options with the `mysql_options()` call. See [Section 20.10.3.49, “mysql\\_options\(\)”](#).
- The value of `host` may be either a host name or an IP address. If `host` is `NULL` or the string `"localhost"`, a connection to the local host is assumed: For Windows, the client connects using a shared-memory connection, if the server has shared-memory connections enabled. Otherwise, TCP/IP is used. For Unix, the client connects using a Unix socket file. For local connections, you can also influence the type of connection to use with the `MYSQL_OPT_PROTOCOL` or `MYSQL_OPT_NAMED_PIPE` options to `mysql_options()`. The type of connection must be supported by the server. For a `host` value of `."` on Windows, the client connects using a named pipe, if the server has named-pipe connections enabled. If named-pipe connections are not enabled, an error occurs.
- The `user` parameter contains the user's MySQL login ID. If `user` is `NULL` or the empty string `" "`, the current user is assumed. Under Unix, this is the current login name. Under Windows ODBC, the current user name must be specified explicitly. See the MyODBC section of [Chapter 20, Connectors and APIs](#).
- The `passwd` parameter contains the password for `user`. If `passwd` is `NULL`, only entries in the `user` table for the user that have a blank (empty) password field are checked for a match. This allows the database administrator to set up the MySQL privilege system in such a way that users get different privileges depending on whether they have specified a password.

#### Note

Do not attempt to encrypt the password before calling `mysql_real_connect()`; password encryption is handled automatically by the client API.

- The `user` and `passwd` parameters use whatever character set has been configured for the `MYSQL` object. By default, this is `latin1`, but can be changed by calling `mysql_options(mysql, MYSQL_SET_CHARSET_NAME, "charset_name")` prior to connecting.
- `db` is the database name. If `db` is not `NULL`, the connection sets the default database to this value.
- If `port` is not 0, the value is used as the port number for the TCP/IP connection. Note that the `host` parameter determines the type of the connection.
- If `unix_socket` is not `NULL`, the string specifies the socket or named pipe that should be used. Note that the `host` parameter determines the type of the connection.
- The value of `client_flag` is usually 0, but can be set to a combination of the following flags to enable certain features.

Flag Name	Flag Description
<code>CLIENT_COMPRESS</code>	Use compression protocol.
<code>CLIENT_FOUND_ROWS</code>	Return the number of found (matched) rows, not the number of changed rows.
<code>CLIENT_IGNORE_SIGPIPE</code>	Prevents the client library from installing a <code>SIGPIPE</code> signal handler. This can be used to avoid conflicts with a handler that the application has already installed.
<code>CLIENT_IGNORE_SPACE</code>	Allow spaces after function names. Makes all functions names reserved words.
<code>CLIENT_INTERACTIVE</code>	Allow <code>interactive_timeout</code> seconds (instead of <code>wait_timeout</code> seconds) of inactivity before closing the connection. The client's session <code>wait_timeout</code> variable is set to the value of the session <code>interactive_timeout</code> variable.

<code>CLIENT_LOCAL_FILES</code>	Enable <code>LOAD DATA LOCAL</code> handling.
<code>CLIENT_MULTI_RESULTS</code>	Tell the server that the client can handle multiple result sets from multiple-statement executions or stored procedures. This flag is automatically enabled if <code>CLIENT_MULTI_STATEMENTS</code> is enabled. See the note following this table for more information about this flag.
<code>CLIENT_MULTI_STATEMENTS</code>	Tell the server that the client may send multiple statements in a single string (separated by “;”). If this flag is not set, multiple-statement execution is disabled. See the note following this table for more information about this flag.
<code>CLIENT_NO_SCHEMA</code>	Don't allow the <code>db_name.tbl_name.col_name</code> syntax. This is for ODBC. It causes the parser to generate an error if you use that syntax, which is useful for trapping bugs in some ODBC programs.
<code>CLIENT_ODBC</code>	Unused.
<code>CLIENT_SSL</code>	Use SSL (encrypted protocol). This option should not be set by application programs; it is set internally in the client library. Instead, use <code>mysql_ssl_set()</code> before calling <code>mysql_real_connect()</code> .
<code>CLIENT_REMEMBER_OPTIONS</code>	Remember options specified by calls to <code>mysql_options()</code> . Without this option, if <code>mysql_real_connect()</code> fails, you must repeat the <code>mysql_options()</code> calls before trying to connect again. With this option, the <code>mysql_options()</code> calls need not be repeated.

If your program uses `CALL` statements to execute stored procedures, the `CLIENT_MULTI_RESULTS` flag must be enabled. This is because each `CALL` returns a result to indicate the call status, in addition to any result sets that might be returned by statements executed within the procedure. Because `CALL` can return multiple results, you should process them using a loop that calls `mysql_next_result()` to determine whether there are more results.

`CLIENT_MULTI_RESULTS` can be enabled when you call `mysql_real_connect()`, either explicitly by passing the `CLIENT_MULTI_RESULTS` flag itself, or implicitly by passing `CLIENT_MULTI_STATEMENTS` (which also enables `CLIENT_MULTI_RESULTS`).

If you enable `CLIENT_MULTI_STATEMENTS` or `CLIENT_MULTI_RESULTS`, you should process the result for every call to `mysql_query()` or `mysql_real_query()` by using a loop that calls `mysql_next_result()` to determine whether there are more results. For an example, see [Section 20.10.12, “C API Support for Multiple Statement Execution”](#).

For some parameters, it is possible to have the value taken from an option file rather than from an explicit value in the `mysql_real_connect()` call. To do this, call `mysql_options()` with the `MYSQL_READ_DEFAULT_FILE` or `MYSQL_READ_DEFAULT_GROUP` option before calling `mysql_real_connect()`. Then, in the `mysql_real_connect()` call, specify the “no-value” value for each parameter to be read from an option file:

- For `host`, specify a value of `NULL` or the empty string (“”).
- For `user`, specify a value of `NULL` or the empty string.
- For `passwd`, specify a value of `NULL`. (For the password, a value of the empty string in the `mysql_real_connect()` call cannot be overridden in an option file, because the empty string indicates explicitly that the MySQL account must have an empty password.)
- For `db`, specify a value of `NULL` or the empty string.
- For `port`, specify a value of 0.
- For `unix_socket`, specify a value of `NULL`.

If no value is found in an option file for a parameter, its default value is used as indicated in the descriptions given earlier in this section.

### Return Values

A `MYSQL*` connection handle if the connection was successful, `NULL` if the connection was unsuccessful. For a successful connection, the return value is the same as the value of the first parameter.

### Errors

- [CR\\_CONN\\_HOST\\_ERROR](#)  
Failed to connect to the MySQL server.
- [CR\\_CONNECTION\\_ERROR](#)  
Failed to connect to the local MySQL server.
- [CR\\_IPSOCK\\_ERROR](#)  
Failed to create an IP socket.
- [CR\\_OUT\\_OF\\_MEMORY](#)  
Out of memory.
- [CR\\_SOCKET\\_CREATE\\_ERROR](#)  
Failed to create a Unix socket.
- [CR\\_UNKNOWN\\_HOST](#)  
Failed to find the IP address for the host name.
- [CR\\_VERSION\\_ERROR](#)  
A protocol mismatch resulted from attempting to connect to a server with a client library that uses a different protocol version.
- [CR\\_NAMEDPIPEOPEN\\_ERROR](#)  
Failed to create a named pipe on Windows.
- [CR\\_NAMEDPIPEWAIT\\_ERROR](#)  
Failed to wait for a named pipe on Windows.
- [CR\\_NAMEDPIPESETSTATE\\_ERROR](#)  
Failed to get a pipe handler on Windows.
- [CR\\_SERVER\\_LOST](#)  
If `connect_timeout > 0` and it took longer than `connect_timeout` seconds to connect to the server or if the server died while executing the `init-command`.
- [CR\\_ALREADY\\_CONNECTED](#)  
The `MYSQL` connection handle is already connected.

### Example

```
MYSQL mysql;

mysql_init(&mysql);
mysql_options(&mysql, MYSQL_READ_DEFAULT_GROUP, "your_prog_name");
if (!mysql_real_connect(&mysql, "host", "user", "passwd", "database", 0, NULL, 0))
{
    fprintf(stderr, "Failed to connect to database: Error: %s\n",
            mysql_error(&mysql));
}
```

By using `mysql_options()` the MySQL library reads the `[client]` and `[your_prog_name]` sections in the `my.cnf` file which ensures that your program works, even if someone has set up MySQL in some non-standard way.

Note that upon connection, `mysql_real_connect()` sets the `reconnect` flag (part of the `MYSQL` structure) to a value of `1` in versions of the API older than 5.0.3, or `0` in newer versions. A value of `1` for this flag indicates that if a statement cannot be performed because of a lost connection, to try reconnecting to the server before giving up. You can use the `MYSQL_OPT_RECONNECT` option to `mysql_options()` to control reconnection behavior.

### 20.10.3.53. `mysql_real_escape_string()`

```
unsigned long mysql_real_escape_string(MYSQL *mysql, char *to, const char *from, un-
```

signed long length)

Note that `mysql` must be a valid, open connection. This is needed because the escaping depends on the character set in use by the server.

### Description

This function is used to create a legal SQL string that you can use in an SQL statement. See [Section 8.1.1, “Strings”](#).

The string in `from` is encoded to an escaped SQL string, taking into account the current character set of the connection. The result is placed in `to` and a terminating null byte is appended. Characters encoded are NUL (ASCII 0), “\n”, “\r”, “\”, “'”, “””, and Control-Z (see [Section 8.1, “Literal Values”](#)). (Strictly speaking, MySQL requires only that backslash and the quote character used to quote the string in the query be escaped. This function quotes the other characters to make them easier to read in log files.)

The string pointed to by `from` must be `length` bytes long. You must allocate the `to` buffer to be at least `length*2+1` bytes long. (In the worst case, each character may need to be encoded as using two bytes, and you need room for the terminating null byte.) When `mysql_real_escape_string()` returns, the contents of `to` is a null-terminated string. The return value is the length of the encoded string, not including the terminating null character.

If you need to change the character set of the connection, you should use the `mysql_set_character_set()` function rather than executing a `SET NAMES` (or `SET CHARACTER SET`) statement. `mysql_set_character_set()` works like `SET NAMES` but also affects the character set used by `mysql_real_escape_string()`, which `SET NAMES` does not.

### Example

```
char query[1000],*end;

end = strmov(query,"INSERT INTO test_table values(");
*end++ = '\\';
end += mysql_real_escape_string(&mysql, end,"What is this",12);
*end++ = '\\';
*end++ = ',';
*end++ = '\\';
end += mysql_real_escape_string(&mysql, end,"binary data: \\0\\r\\n",16);
*end++ = '\\';
*end++ = ')';

if (mysql_real_query(&mysql,query,(unsigned int) (end - query)))
{
    fprintf(stderr, "Failed to insert row, Error: %s\\n",
            mysql_error(&mysql));
}
```

The `strmov()` function used in the example is included in the `mysqlclient` library and works like `strcpy()` but returns a pointer to the terminating null of the first parameter.

### Return Values

The length of the value placed into `to`, not including the terminating null character.

### Errors

None.

## 20.10.3.54. `mysql_real_query()`

```
int mysql_real_query(MYSQL *mysql, const char *stmt_str, unsigned long length)
```

### Description

Executes the SQL statement pointed to by `stmt_str`, which should be a string `length` bytes long. Normally, the string must consist of a single SQL statement and you should not add a terminating semicolon (“;”) or `\g` to the statement. If multiple-statement execution has been enabled, the string can contain several statements separated by semicolons. See [Section 20.10.12, “C API Support for Multiple Statement Execution”](#).

`mysql_query()` cannot be used for statements that contain binary data; you must use `mysql_real_query()` instead. (Binary data may contain the “\0” character, which `mysql_query()` interprets as the end of the statement string.) In addition, `mysql_real_query()` is faster than `mysql_query()` because it does not call `strlen()` on the statement string.

If you want to know whether the statement should return a result set, you can use `mysql_field_count()` to check for this. See [Section 20.10.3.22, “mysql\\_field\\_count\(\)”](#).

### Return Values

Zero if the statement was successful. Nonzero if an error occurred.

**Errors**

- `CR_COMMANDS_OUT_OF_SYNC`  
Commands were executed in an improper order.
- `CR_SERVER_GONE_ERROR`  
The MySQL server has gone away.
- `CR_SERVER_LOST`  
The connection to the server was lost during the query.
- `CR_UNKNOWN_ERROR`  
An unknown error occurred.

**20.10.3.55. `mysql_refresh()`**

```
int mysql_refresh(MYSQL *mysql, unsigned int options)
```

**Description**

This function flushes tables or caches, or resets replication server information. The connected user must have the `RELOAD` privilege.

The `options` argument is a bit mask composed from any combination of the following values. Multiple values can be OR'ed together to perform multiple operations with a single call.

- `REFRESH_GRANT`  
Refresh the grant tables, like `FLUSH PRIVILEGES`.
- `REFRESH_LOG`  
Flush the logs, like `FLUSH LOGS`.
- `REFRESH_TABLES`  
Flush the table cache, like `FLUSH TABLES`.
- `REFRESH_HOSTS`  
Flush the host cache, like `FLUSH HOSTS`.
- `REFRESH_STATUS`  
Reset status variables, like `FLUSH STATUS`.
- `REFRESH_THREADS`  
Flush the thread cache.
- `REFRESH_SLAVE`  
On a slave replication server, reset the master server information and restart the slave, like `RESET SLAVE`.
- `REFRESH_MASTER`  
On a master replication server, remove the binary log files listed in the binary log index and truncate the index file, like `RESET MASTER`.

**Return Values**

Zero for success. Nonzero if an error occurred.

**Errors**

---



- [CR\\_COMMANDS\\_OUT\\_OF\\_SYNC](#)  
Commands were executed in an improper order.
- [CR\\_SERVER\\_GONE\\_ERROR](#)  
The MySQL server has gone away.
- [CR\\_SERVER\\_LOST](#)  
The connection to the server was lost during the query.
- [CR\\_UNKNOWN\\_ERROR](#)  
An unknown error occurred.

### 20.10.3.56. `mysql_reload()`

```
int mysql_reload(MYSQL *mysql)
```

#### Description

Asks the MySQL server to reload the grant tables. The connected user must have the [RELOAD](#) privilege.

This function is deprecated. It is preferable to use `mysql_query()` to issue an SQL [FLUSH PRIVILEGES](#) statement instead.

#### Return Values

Zero for success. Nonzero if an error occurred.

#### Errors

- [CR\\_COMMANDS\\_OUT\\_OF\\_SYNC](#)  
Commands were executed in an improper order.
- [CR\\_SERVER\\_GONE\\_ERROR](#)  
The MySQL server has gone away.
- [CR\\_SERVER\\_LOST](#)  
The connection to the server was lost during the query.
- [CR\\_UNKNOWN\\_ERROR](#)  
An unknown error occurred.

### 20.10.3.57. `mysql_rollback()`

```
my_bool mysql_rollback(MYSQL *mysql)
```

#### Description

Rolls back the current transaction.

The action of this function is subject to the value of the `completion_type` system variable. In particular, if the value of `completion_type` is 2, the server performs a release after terminating a transaction and closes the client connection. The client program should call `mysql_close()` to close the connection from the client side.

#### Return Values

Zero if successful. Nonzero if an error occurred.

#### Errors

None.

### 20.10.3.58. `mysql_row_seek()`

```
MYSQL_ROW_OFFSET mysql_row_seek(MYSQL_RES *result, MYSQL_ROW_OFFSET offset)
```

#### Description

Sets the row cursor to an arbitrary row in a query result set. The `offset` value is a row offset that should be a value returned from `mysql_row_tell()` or from `mysql_row_seek()`. This value is not a row number; if you want to seek to a row within a result set by number, use `mysql_data_seek()` instead.

This function requires that the result set structure contains the entire result of the query, so `mysql_row_seek()` may be used only in conjunction with `mysql_store_result()`, not with `mysql_use_result()`.

#### Return Values

The previous value of the row cursor. This value may be passed to a subsequent call to `mysql_row_seek()`.

#### Errors

None.

### 20.10.3.59. `mysql_row_tell()`

```
MYSQL_ROW_OFFSET mysql_row_tell(MYSQL_RES *result)
```

#### Description

Returns the current position of the row cursor for the last `mysql_fetch_row()`. This value can be used as an argument to `mysql_row_seek()`.

You should use `mysql_row_tell()` only after `mysql_store_result()`, not after `mysql_use_result()`.

#### Return Values

The current offset of the row cursor.

#### Errors

None.

### 20.10.3.60. `mysql_select_db()`

```
int mysql_select_db(MYSQL *mysql, const char *db)
```

#### Description

Causes the database specified by `db` to become the default (current) database on the connection specified by `mysql`. In subsequent queries, this database is the default for table references that do not include an explicit database specifier.

`mysql_select_db()` fails unless the connected user can be authenticated as having permission to use the database.

#### Return Values

Zero for success. Nonzero if an error occurred.

#### Errors

- `CR_COMMANDS_OUT_OF_SYNC`  
Commands were executed in an improper order.
- `CR_SERVER_GONE_ERROR`  
The MySQL server has gone away.
- `CR_SERVER_LOST`  
The connection to the server was lost during the query.
- `CR_UNKNOWN_ERROR`

An unknown error occurred.

### 20.10.3.61. `mysql_set_character_set()`

```
int mysql_set_character_set(MYSQL *mysql, const char *csname)
```

#### Description

This function is used to set the default character set for the current connection. The string `csname` specifies a valid character set name. The connection collation becomes the default collation of the character set. This function works like the `SET NAMES` statement, but also sets the value of `mysql->charset`, and thus affects the character set used by `mysql_real_escape_string()`

#### Return Values

Zero for success. Nonzero if an error occurred.

#### Example

```
MYSQL mysql;

mysql_init(&mysql);
if (!mysql_real_connect(&mysql, "host", "user", "passwd", "database", 0, NULL, 0))
{
    fprintf(stderr, "Failed to connect to database: Error: %s\n",
            mysql_error(&mysql));
}

if (!mysql_set_character_set(&mysql, "utf8"))
{
    printf("New client character set: %s\n",
            mysql_character_set_name(&mysql));
}
```

### 20.10.3.62. `mysql_set_local_infile_default()`

```
void mysql_set_local_infile_default(MYSQL *mysql);
```

#### Description

Sets the `LOAD LOCAL DATA INFILE` handler callback functions to the defaults used internally by the C client library. The library calls this function automatically if `mysql_set_local_infile_handler()` has not been called or does not supply valid functions for each of its callbacks.

The `mysql_set_local_infile_default()` function was added in MySQL 4.1.2.

#### Return Values

None.

#### Errors

None.

### 20.10.3.63. `mysql_set_local_infile_handler()`

```
void mysql_set_local_infile_handler(MYSQL *mysql, int (*local_infile_init)(void **,
const char *, void *), int (*local_infile_read)(void *, char *, unsigned int), void
(*local_infile_end)(void *), int (*local_infile_error)(void *, char*, unsigned int),
void *userdata);
```

#### Description

This function installs callbacks to be used during the execution of `LOAD DATA LOCAL INFILE` statements. It enables application programs to exert control over local (client-side) data file reading. The arguments are the connection handler, a set of pointers to callback functions, and a pointer to a data area that the callbacks can use to share information.

To use `mysql_set_local_infile_handler()`, you must write the following callback functions:

```
int
local_infile_init(void **ptr, const char *filename, void *userdata);
```

The initialization function. This is called once to do any setup necessary, open the data file, allocate data structures, and so forth. The first `void**` argument is a pointer to a pointer. You can set the pointer (that is, `*ptr`) to a value that will be passed to each of the other callbacks (as a `void*`). The callbacks can use this pointed-to value to maintain state information. The `userdata` argument is the same value that is passed to `mysql_set_local_infile_handler()`.

The initialization function should return zero for success, nonzero for an error.

```
int
local_infile_read(void *ptr, char *buf, unsigned int buf_len);
```

The data-reading function. This is called repeatedly to read the data file. `buf` points to the buffer where the read data should be stored, and `buf_len` is the maximum number of bytes that the callback can read and store in the buffer. (It can read fewer bytes, but should not read more.)

The return value is the number of bytes read, or zero when no more data could be read (this indicates EOF). Return a value less than zero if an error occurs.

```
void
local_infile_end(void *ptr)
```

The termination function. This is called once after `local_infile_read()` has returned zero (EOF) or an error. This function should deallocate any memory allocated by `local_infile_init()` and perform any other cleanup necessary. It is invoked even if the initialization function returns an error.

```
int
local_infile_error(void *ptr,
                  char *error_msg,
                  unsigned int error_msg_len);
```

The error-handling function. This is called to get a textual error message to return to the user in case any of your other functions returns an error. `error_msg` points to the buffer into which the message should be written, and `error_msg_len` is the length of the buffer. The message should be written as a null-terminated string, so the message can be at most `error_msg_len-1` bytes long.

The return value is the error number.

Typically, the other callbacks store the error message in the data structure pointed to by `ptr`, so that `local_infile_error()` can copy the message from there into `error_msg`.

After calling `mysql_set_local_infile_handler()` in your C code and passing pointers to your callback functions, you can then issue a `LOAD DATA LOCAL INFILE` statement (for example, by using `mysql_query()`). The client library automatically invokes your callbacks. The file name specified in `LOAD DATA LOCAL INFILE` will be passed as the second parameter to the `local_infile_init()` callback.

The `mysql_set_local_infile_handler()` function was added in MySQL 4.1.2.

### Return Values

None.

### Errors

None.

## 20.10.3.64. `mysql_set_server_option()`

```
int mysql_set_server_option(MYSQL *mysql, enum enum_mysql_set_option option)
```

### Description

Enables or disables an option for the connection. `option` can have one of the following values.

<code>MYSQL_OPTION_MULTI_STATEMENTS_ON</code>	Enable multiple-statement support
<code>MYSQL_OPTION_MULTI_STATEMENTS_OFF</code>	Disable multiple-statement support

If you enable multiple-statement support, you should retrieve results from calls to `mysql_query()` or `mysql_real_query()` by using a loop that calls `mysql_next_result()` to determine whether there are more results. For an example, see [Section 20.10.12, “C API Support for Multiple Statement Execution”](#).

Enabling multiple-statement support with `MYSQL_OPTION_MULTI_STATEMENTS_ON` does not have quite the same effect as enabling it by passing the `CLIENT_MULTI_STATEMENTS` flag to `mysql_real_connect()`: `CLIENT_MULTI_STATEMENTS` also enables `CLIENT_MULTI_RESULTS`. If you are using the `CALL SQL` statement in your programs, multiple-result support must be enabled; this means that `MYSQL_OPTION_MULTI_STATEMENTS_ON` by itself is insufficient to allow the use of `CALL`.

### Return Values

Zero for success. Nonzero if an error occurred.

### Errors

- `CR_COMMANDS_OUT_OF_SYNC`  
Commands were executed in an improper order.
- `CR_SERVER_GONE_ERROR`  
The MySQL server has gone away.
- `CR_SERVER_LOST`  
The connection to the server was lost during the query.
- `ER_UNKNOWN_COM_ERROR`  
The server didn't support `mysql_set_server_option()` (which is the case that the server is older than 4.1.1) or the server didn't support the option one tried to set.

## 20.10.3.65. `mysql_shutdown()`

```
int mysql_shutdown(MYSQL *mysql, enum mysql_enum_shutdown_level shutdown_level)
```

### Description

Asks the database server to shut down. The connected user must have the `SHUTDOWN` privilege. MySQL 5.1 servers support only one type of shutdown; `shutdown_level` must be equal to `SHUTDOWN_DEFAULT`. Additional shutdown levels are planned to make it possible to choose the desired level. Dynamically linked executables which have been compiled with older versions of the `libmysqlclient` headers and call `mysql_shutdown()` need to be used with the old `libmysqlclient` dynamic library.

The shutdown process is described in [Section 5.1.10, “The Shutdown Process”](#).

### Return Values

Zero for success. Nonzero if an error occurred.

### Errors

- `CR_COMMANDS_OUT_OF_SYNC`  
Commands were executed in an improper order.
- `CR_SERVER_GONE_ERROR`  
The MySQL server has gone away.
- `CR_SERVER_LOST`  
The connection to the server was lost during the query.
- `CR_UNKNOWN_ERROR`  
An unknown error occurred.

## 20.10.3.66. `mysql_sqlstate()`

```
const char *mysql_sqlstate(MYSQL *mysql)
```

**Description**

Returns a null-terminated string containing the SQLSTATE error code for the most recently executed SQL statement. The error code consists of five characters. '00000' means “no error”. The values are specified by ANSI SQL and ODBC. For a list of possible values, see [Appendix B, Errors, Error Codes, and Common Problems](#).

SQLSTATE values returned by `mysql_sqlstate()` differ from MySQL-specific error numbers returned by `mysql_errno()`. For example, the `mysql` client program displays errors using the following format, where 1146 is the `mysql_errno()` value and '42S02' is the corresponding `mysql_sqlstate()` value:

```
shell> SELECT * FROM no_such_table;
ERROR 1146 (42S02): Table 'test.no_such_table' doesn't exist
```

Not all MySQL error numbers are mapped to SQLSTATE error codes. The value 'HY000' (general error) is used for unmapped error numbers.

If you call `mysql_sqlstate()` after `mysql_real_connect()` fails, `mysql_sqlstate()` might not return a useful value. For example, this happens if a host is blocked by the server and the connection is closed without any SQLSTATE value being sent to the client.

**Return Values**

A null-terminated character string containing the SQLSTATE error code.

**See Also**

See [Section 20.10.3.14, “mysql\\_errno\(\)”](#), [Section 20.10.3.15, “mysql\\_error\(\)”](#), and [Section 20.10.7.26, “mysql\\_stmt\\_sqlstate\(\)”](#).

**20.10.3.67. mysql\_ssl\_set()**

```
my_bool mysql_ssl_set(MYSQL *mysql, const char *key, const char *cert, const char *ca,
const char *capath, const char *cipher)
```

**Description**

`mysql_ssl_set()` is used for establishing secure connections using SSL. It must be called before `mysql_real_connect()`.

`mysql_ssl_set()` does nothing unless SSL support is enabled in the client library.

`mysql` is the connection handler returned from `mysql_init()`. The other parameters are specified as follows:

- `key` is the path name to the key file.
- `cert` is the path name to the certificate file.
- `ca` is the path name to the certificate authority file.
- `capath` is the path name to a directory that contains trusted SSL CA certificates in pem format.
- `cipher` is a list of allowable ciphers to use for SSL encryption.

Any unused SSL parameters may be given as `NULL`.

**Return Values**

This function always returns 0. If SSL setup is incorrect, `mysql_real_connect()` returns an error when you attempt to connect.

**20.10.3.68. mysql\_stat()**

```
const char *mysql_stat(MYSQL *mysql)
```

**Description**

Returns a character string containing information similar to that provided by the `mysqladmin status` command. This includes uptime in seconds and the number of running threads, questions, reloads, and open tables.

### Return Values

A character string describing the server status. `NULL` if an error occurred.

### Errors

- `CR_COMMANDS_OUT_OF_SYNC`  
Commands were executed in an improper order.
- `CR_SERVER_GONE_ERROR`  
The MySQL server has gone away.
- `CR_SERVER_LOST`  
The connection to the server was lost during the query.
- `CR_UNKNOWN_ERROR`  
An unknown error occurred.

## 20.10.3.69. `mysql_store_result()`

```
MYSQL_RES *mysql_store_result(MYSQL *mysql)
```

### Description

After invoking `mysql_query()` or `mysql_real_query()`, you must call `mysql_store_result()` or `mysql_use_result()` for every statement that successfully produces a result set (`SELECT`, `SHOW`, `DESCRIBE`, `EXPLAIN`, `CHECK TABLE`, and so forth). You must also call `mysql_free_result()` after you are done with the result set.

You don't have to call `mysql_store_result()` or `mysql_use_result()` for other statements, but it does not do any harm or cause any notable performance degradation if you call `mysql_store_result()` in all cases. You can detect whether the statement has a result set by checking whether `mysql_store_result()` returns a nonzero value (more about this later on).

If you enable multiple-statement support, you should retrieve results from calls to `mysql_query()` or `mysql_real_query()` by using a loop that calls `mysql_next_result()` to determine whether there are more results. For an example, see [Section 20.10.12, "C API Support for Multiple Statement Execution"](#).

If you want to know whether a statement should return a result set, you can use `mysql_field_count()` to check for this. See [Section 20.10.3.22, "mysql\\_field\\_count\(\)"](#).

`mysql_store_result()` reads the entire result of a query to the client, allocates a `MYSQL_RES` structure, and places the result into this structure.

`mysql_store_result()` returns a null pointer if the statement didn't return a result set (for example, if it was an `INSERT` statement).

`mysql_store_result()` also returns a null pointer if reading of the result set failed. You can check whether an error occurred by checking whether `mysql_error()` returns a non-empty string, `mysql_errno()` returns nonzero, or `mysql_field_count()` returns zero.

An empty result set is returned if there are no rows returned. (An empty result set differs from a null pointer as a return value.)

After you have called `mysql_store_result()` and gotten back a result that isn't a null pointer, you can call `mysql_num_rows()` to find out how many rows are in the result set.

You can call `mysql_fetch_row()` to fetch rows from the result set, or `mysql_row_seek()` and `mysql_row_tell()` to obtain or set the current row position within the result set.

See [Section 20.10.10.1, "Why mysql\\_store\\_result\(\) Sometimes Returns NULL After mysql\\_query\(\) Returns Success"](#).

### Return Values

A `MYSQL_RES` result structure with the results. `NULL` (0) if an error occurred.

### Errors

`mysql_store_result()` resets `mysql_error()` and `mysql_errno()` if it succeeds.

- `CR_COMMANDS_OUT_OF_SYNC`  
Commands were executed in an improper order.
- `CR_OUT_OF_MEMORY`  
Out of memory.
- `CR_SERVER_GONE_ERROR`  
The MySQL server has gone away.
- `CR_SERVER_LOST`  
The connection to the server was lost during the query.
- `CR_UNKNOWN_ERROR`  
An unknown error occurred.

### 20.10.3.70. `mysql_thread_id()`

```
unsigned long mysql_thread_id(MYSQL *mysql)
```

#### Description

Returns the thread ID of the current connection. This value can be used as an argument to `mysql_kill()` to kill the thread.

If the connection is lost and you reconnect with `mysql_ping()`, the thread ID changes. This means you should not get the thread ID and store it for later. You should get it when you need it.

#### Return Values

The thread ID of the current connection.

#### Errors

None.

### 20.10.3.71. `mysql_use_result()`

```
MYSQL_RES *mysql_use_result(MYSQL *mysql)
```

#### Description

After invoking `mysql_query()` or `mysql_real_query()`, you must call `mysql_store_result()` or `mysql_use_result()` for every statement that successfully produces a result set (`SELECT`, `SHOW`, `DESCRIBE`, `EXPLAIN`, `CHECK TABLE`, and so forth). You must also call `mysql_free_result()` after you are done with the result set.

`mysql_use_result()` initiates a result set retrieval but does not actually read the result set into the client like `mysql_store_result()` does. Instead, each row must be retrieved individually by making calls to `mysql_fetch_row()`. This reads the result of a query directly from the server without storing it in a temporary table or local buffer, which is somewhat faster and uses much less memory than `mysql_store_result()`. The client allocates memory only for the current row and a communication buffer that may grow up to `max_allowed_packet` bytes.

On the other hand, you shouldn't use `mysql_use_result()` if you are doing a lot of processing for each row on the client side, or if the output is sent to a screen on which the user may type a `^S` (stop scroll). This ties up the server and prevent other threads from updating any tables from which the data is being fetched.

When using `mysql_use_result()`, you must execute `mysql_fetch_row()` until a `NULL` value is returned, otherwise, the unfetched rows are returned as part of the result set for your next query. The C API gives the error `Commands out of sync; you can't run this command now` if you forget to do this!

You may not use `mysql_data_seek()`, `mysql_row_seek()`, `mysql_row_tell()`, `mysql_num_rows()`, or `mysql_affected_rows()` with a result returned from `mysql_use_result()`, nor may you issue other queries until `mysql_use_result()` has finished. (However, after you have fetched all the rows, `mysql_num_rows()` accurately returns the number of rows fetched.)



You must call `mysql_free_result()` once you are done with the result set.

When using the `libmysqld` embedded server, the memory benefits are essentially lost because memory usage incrementally increases with each row retrieved until `mysql_free_result()` is called.

### Return Values

A `MYSQL_RES` result structure. `NULL` if an error occurred.

### Errors

`mysql_use_result()` resets `mysql_error()` and `mysql_errno()` if it succeeds.

- `CR_COMMANDS_OUT_OF_SYNC`  
Commands were executed in an improper order.
- `CR_OUT_OF_MEMORY`  
Out of memory.
- `CR_SERVER_GONE_ERROR`  
The MySQL server has gone away.
- `CR_SERVER_LOST`  
The connection to the server was lost during the query.
- `CR_UNKNOWN_ERROR`  
An unknown error occurred.

### 20.10.3.72. `mysql_warning_count()`

```
unsigned int mysql_warning_count(MYSQL *mysql)
```

#### Description

Returns the number of warnings generated during execution of the previous SQL statement.

#### Return Values

The warning count.

#### Errors

None.

## 20.10.4. C API Prepared Statements

The MySQL client/server protocol provides for the use of prepared statements. This capability uses the `MYSQL_STMT` statement handler data structure returned by the `mysql_stmt_init()` initialization function. Prepared execution is an efficient way to execute a statement more than once. The statement is first parsed to prepare it for execution. Then it is executed one or more times at a later time, using the statement handle returned by the initialization function.

Prepared execution is faster than direct execution for statements executed more than once, primarily because the query is parsed only once. In the case of direct execution, the query is parsed every time it is executed. Prepared execution also can provide a reduction of network traffic because for each execution of the prepared statement, it is necessary only to send the data for the parameters.

Prepared statements might not provide a performance increase in some situations. For best results, test your application both with prepared and non-prepared statements and choose whichever yields best performance.

Another advantage of prepared statements is that it uses a binary protocol that makes data transfer between client and server more efficient.

The following statements can be used as prepared statements: `CALL`, `CREATE TABLE`, `DELETE`, `DO`, `INSERT`, `REPLACE`, `SELECT`, `SET`, `UPDATE`, and most `SHOW` statements.

As of MySQL 5.1.10, the following additional statements are supported:

```
ANALYZE TABLE
OPTIMIZE TABLE
REPAIR TABLE
```

As of MySQL 5.1.12, the following additional statements are supported:

```
CACHE INDEX
CHANGE MASTER
CHECKSUM {TABLE | TABLES}
{CREATE | RENAME | DROP} DATABASE
{CREATE | RENAME | DROP} USER
FLUSH {TABLE | TABLES | TABLES WITH READ LOCK | HOSTS | PRIVILEGES
      | LOGS | STATUS | MASTER | SLAVE | DES_KEY_FILE | USER_RESOURCES}
GRANT
REVOKE
KILL
LOAD INDEX INTO CACHE
RESET {MASTER | SLAVE | QUERY CACHE}
SHOW BINLOG EVENTS
SHOW CREATE {PROCEDURE | FUNCTION | EVENT | TABLE | VIEW}
SHOW {AUTHORS | CONTRIBUTORS | WARNINGS | ERRORS}
SHOW {MASTER | BINARY} LOGS
SHOW {MASTER | SLAVE} STATUS
SLAVE {START | STOP}
INSTALL PLUGIN
UNINSTALL PLUGIN
```

Other statements are not yet supported in MySQL 5.1.

#### MySQL Enterprise

MySQL Enterprise subscribers will find more information about using prepared statements in the Knowledge Base article, [How can I create server-side prepared statements?](#). Access to the MySQL Knowledge Base collection of articles is one of the advantages of subscribing to MySQL Enterprise. For more information, see <http://www.mysql.com/products/enterprise/advisors.html>.

## 20.10.5. C API Prepared Statement Data types

Prepared statements use several data structures:

- To prepare a statement, pass the statement string to `mysql_stmt_init()`, which returns a pointer to a `MYSQL_STMT` data structure.
- To provide input parameters for a prepared statement, set up `MYSQL_BIND` structures and pass them to `mysql_stmt_bind_param()`. To receive output column values, set up `MYSQL_BIND` structures and pass them to `mysql_stmt_bind_result()`.
- The `MYSQL_TIME` structure is used to transfer temporal data in both directions.

The following discussion describes the prepared statement data types in detail.

- `MYSQL_STMT`

This structure represents a prepared statement. A statement is created by calling `mysql_stmt_init()`, which returns a statement handle (that is, a pointer to a `MYSQL_STMT`). The handle is used for all subsequent operations with the statement until you close it with `mysql_stmt_close()`, at which point the handle becomes invalid.

The `MYSQL_STMT` structure has no members that are intended for application use. Also, you should not try to make a copy of a `MYSQL_STMT` structure. There is no guarantee that such a copy will be usable.

Multiple statement handles can be associated with a single connection. The limit on the number of handles depends on the available system resources.

- `MYSQL_BIND`

This structure is used both for statement input (data values sent to the server) and output (result values returned from the server):

- For input, `MYSQL_BIND` is used with `mysql_stmt_bind_param()` to bind parameter data values to buffers for use by `mysql_stmt_execute()`.

- For output, `MYSQL_BIND` is used with `mysql_stmt_bind_result()` to bind result set buffers for use in fetching rows with `mysql_stmt_fetch()`.

To use a `MYSQL_BIND` structure, you should zero its contents to initialize it, and then set its members appropriately. For example, to declare and initialize an array of three `MYSQL_BIND` structures, use this code:

```
MYSQL_BIND bind[3];
memset(bind, 0, sizeof(bind));
```

The `MYSQL_BIND` structure contains the following members for use by application programs. For several of the members, the manner of use depends on whether the structure is used for input or output.

- `enum enum_field_types buffer_type`

The type of the buffer. This member indicates the data type of the C language variable that you are binding to the statement parameter. The allowable `buffer_type` values are listed later in this section. For input, `buffer_type` indicates the type of the variable containing the value that you will send to the server. For output, it indicates the type of the variable into which you want a value received from the server to be stored.

- `void *buffer`

A pointer to the buffer to be used for data transfer. This is the address of a variable.

For input, `buffer` is a pointer to the variable in which a statement parameter's data value is stored. When you call `mysql_stmt_execute()`, MySQL takes the value that you have stored in the variable and uses it in place of the corresponding parameter marker in the statement.

For output, `buffer` is a pointer to the variable in which to return a result set column value. When you call `mysql_stmt_fetch()`, MySQL returns a column value and stores it in this variable. You can access the value when the call returns.

To minimize the need for MySQL to perform type conversions between C language values on the client side and SQL values on the server side, use variables that have types similar to those of the corresponding SQL values. For numeric data types, `buffer` should point to a variable of the proper numeric C type. (For `char` or integer variables, you should also indicate whether the variable has the `unsigned` attribute by setting the `is_unsigned` member, described later in this list.) For character (nonbinary) and binary string data types, `buffer` should point to a character buffer. For date and time data types, `buffer` should point to a `MYSQL_TIME` structure.

See the notes about type conversions later in the section.

- `unsigned long buffer_length`

The actual size of `*buffer` in bytes. This indicates the maximum amount of data that can be stored in the buffer. For character and binary C data, the `buffer_length` value specifies the length of `*buffer` when used with `mysql_stmt_bind_param()` to specify input values, or the maximum number of output data bytes that can be fetched into the buffer when used with `mysql_stmt_bind_result()`.

- `unsigned long *length`

A pointer to an `unsigned long` variable that indicates the actual number of bytes of data stored in `*buffer`. `length` is used for character or binary C data.

For input parameter data binding, `length` points to an `unsigned long` variable that indicates the actual length of the parameter value stored in `*buffer`; this is used by `mysql_stmt_execute()`.

For output value binding, the return value of `mysql_stmt_fetch()` determines the interpretation of the length:

- If `mysql_stmt_fetch()` returns 0, `*length` indicates the actual length of the parameter value.
- If `mysql_stmt_fetch()` returns `MYSQL_DATA_TRUNCATED`, `*length` indicates the non-truncated length of the parameter value. In this case, the minimum of `*length` and `buffer_length` indicates the actual length of the value.

`length` is ignored for numeric and temporal data types because the length of the data value is determined by the `buffer_type` value.

If you need to be able to determine the length of a returned value before fetching it with `mysql_stmt_fetch()`, see [Section 20.10.7.11, “mysql\\_stmt\\_fetch\(\)”](#), for some strategies.

- `my_bool *is_null`

This member points to a `my_bool` variable that is true if a value is `NULL`, false if it is not `NULL`. For input, set `*is_null` to true to indicate that you are passing a `NULL` value as a statement parameter.

The reason that `is_null` is not a boolean scalar but is instead a *pointer* to a boolean scalar is to provide flexibility in how you specify `NULL` values:

- If your data values are always `NULL`, use `MYSQL_TYPE_NULL` as the `buffer_type` value when you bind the column. The other members do not matter.
- If your data values are always `NOT NULL`, set the other members appropriately for the variable you are binding, and set `is_null = (my_bool*) 0`.
- In all other cases, set the other members appropriately, and set `is_null` to the address of a `my_bool` variable. Set that variable's value to true or false appropriately between executions to indicate whether data values are `NULL` or `NOT NULL`, respectively.

For output, the value pointed to by `is_null` is set to true after you fetch a row if the result set column value returned from the statement is `NULL`.

- `my_bool is_unsigned`

This member is used for C variables with data types that can be `unsigned` (`char`, `short int`, `int`, `long long int`). Set `is_unsigned` to true if the variable pointed to by `buffer` is `unsigned` and false otherwise. For example, if you bind a `signed char` variable to `buffer`, specify a type code of `MYSQL_TYPE_TINY` and set `is_unsigned` to false. If you bind an `unsigned char` instead, the type code is the same but `is_unsigned` should be true. (For `char`, it is not defined whether it is signed or unsigned, so it is best to be explicit about signedness by using `signed char` or `unsigned char`.)

`is_unsigned` applies only to the C language variable on the client side. It indicates nothing about the signedness of the corresponding SQL value on the server side. For example, if you use an `int` variable to supply a value for a `BIGINT UNSIGNED` column, `is_unsigned` should be false because `int` is a signed type. If you use an `unsigned int` variable to supply a value for a `BIGINT` column, `is_unsigned` should be true because `unsigned int` is an unsigned type. MySQL performs the proper conversion between signed and unsigned values in both directions, although a warning occurs if truncation results.

- `my_bool *error`

For output, set this member to point to a `my_bool` variable to have truncation information for the parameter stored there after a row fetching operation. (Truncation reporting is enabled by default, but can be controlled by calling `mysql_options()` with the `MYSQL_REPORT_DATA_TRUNCATION` option.) When truncation reporting is enabled, `mysql_stmt_fetch()` returns `MYSQL_DATA_TRUNCATED` and `*error` is true in the `MYSQL_BIND` structures for parameters in which truncation occurred. Truncation indicates loss of sign or significant digits, or that a string was too long to fit in a column.

- `MYSQL_TIME`

This structure is used to send and receive `DATE`, `TIME`, `DATETIME`, and `TIMESTAMP` data directly to and from the server. Set the `buffer_type` member of a `MYSQL_BIND` structure to one of the temporal types (`MYSQL_TYPE_TIME`, `MYSQL_TYPE_DATE`, `MYSQL_TYPE_DATETIME`, `MYSQL_TYPE_TIMESTAMP`), and set the `buffer` member to point to a `MYSQL_TIME` structure.

The `MYSQL_TIME` structure contains the members listed in the following table.

Member	Description
<code>unsigned int year</code>	The year
<code>unsigned int month</code>	The month of the year
<code>unsigned int day</code>	The day of the month
<code>unsigned int hour</code>	The hour of the day
<code>unsigned int minute</code>	The minute of the hour
<code>unsigned int second</code>	The second of the minute
<code>my_bool neg</code>	A boolean flag to indicate whether the time is negative
<code>unsigned long second_part</code>	The fractional part of the second in microseconds; currently unused

Only those parts of a `MYSQL_TIME` structure that apply to a given type of temporal value are used. The `year`, `month`, and

`day` elements are used for `DATE`, `DATETIME`, and `TIMESTAMP` values. The `hour`, `minute`, and `second` elements are used for `TIME`, `DATETIME`, and `TIMESTAMP` values. See [Section 20.10.14, “C API Prepared Statement Handling of Date and Time Values”](#).

The following table shows the allowable values that may be specified in the `buffer_type` member of `MYSQL_BIND` structures for input values. The value should be chosen according to the data type of the C language variable that you are binding. If the variable is `unsigned`, you should also set the `is_unsigned` member to true. The table shows the C variable types that you can use, the corresponding type codes, and the SQL data types for which the supplied value can be used without conversion.

Input Variable C Type	<code>buffer_type</code> Value	SQL Type of Destination Value
<code>signed char</code>	<code>MYSQL_TYPE_TINY</code>	<code>TINYINT</code>
<code>short int</code>	<code>MYSQL_TYPE_SHORT</code>	<code>SMALLINT</code>
<code>int</code>	<code>MYSQL_TYPE_LONG</code>	<code>INT</code>
<code>long long int</code>	<code>MYSQL_TYPE_LONGLONG</code>	<code>BIGINT</code>
<code>float</code>	<code>MYSQL_TYPE_FLOAT</code>	<code>FLOAT</code>
<code>double</code>	<code>MYSQL_TYPE_DOUBLE</code>	<code>DOUBLE</code>
<code>MYSQL_TIME</code>	<code>MYSQL_TYPE_TIME</code>	<code>TIME</code>
<code>MYSQL_TIME</code>	<code>MYSQL_TYPE_DATE</code>	<code>DATE</code>
<code>MYSQL_TIME</code>	<code>MYSQL_TYPE_DATETIME</code>	<code>DATETIME</code>
<code>MYSQL_TIME</code>	<code>MYSQL_TYPE_TIMESTAMP</code>	<code>TIMESTAMP</code>
<code>char[]</code>	<code>MYSQL_TYPE_STRING</code> (for nonbinary data)	<code>TEXT</code> , <code>CHAR</code> , <code>VARCHAR</code>
<code>char[]</code>	<code>MYSQL_TYPE_BLOB</code> (for binary data)	<code>BLOB</code> , <code>BINARY</code> , <code>VARBINARY</code>
	<code>MYSQL_TYPE_NULL</code>	<code>NULL</code>

The use of `MYSQL_TYPE_NULL` is described earlier in connection with the `is_null` member.

The following table shows the allowable values that may be specified in the `buffer_type` member of `MYSQL_BIND` structures for output values. The value should be chosen according to the data type of the C language variable that you are binding. If the variable is `unsigned`, you should also set the `is_unsigned` member to true. The table shows the SQL types of received values, the corresponding type code that such values have in result set metadata, and the recommended C language data types to bind to the `MYSQL_BIND` structure to receive the SQL values without conversion.

If there is a mismatch between the C variable type on the client side and the corresponding SQL value on the server side, MySQL performs implicit type conversions in both directions.

SQL Type of Received Value	<code>buffer_type</code> Value	Output Variable C Type
<code>TINYINT</code>	<code>MYSQL_TYPE_TINY</code>	<code>signed char</code>
<code>SMALLINT</code>	<code>MYSQL_TYPE_SHORT</code>	<code>short int</code>
<code>MEDIUMINT</code>	<code>MYSQL_TYPE_INT24</code>	<code>int</code>
<code>INT</code>	<code>MYSQL_TYPE_LONG</code>	<code>int</code>
<code>BIGINT</code>	<code>MYSQL_TYPE_LONGLONG</code>	<code>long long int</code>
<code>FLOAT</code>	<code>MYSQL_TYPE_FLOAT</code>	<code>float</code>
<code>DOUBLE</code>	<code>MYSQL_TYPE_DOUBLE</code>	<code>double</code>
<code>DECIMAL</code>	<code>MYSQL_TYPE_NEWDECIMAL</code>	<code>char[]</code>
<code>YEAR</code>	<code>MYSQL_TYPE_SHORT</code>	<code>short int</code>
<code>TIME</code>	<code>MYSQL_TYPE_TIME</code>	<code>MYSQL_TIME</code>
<code>DATE</code>	<code>MYSQL_TYPE_DATE</code>	<code>MYSQL_TIME</code>
<code>DATETIME</code>	<code>MYSQL_TYPE_DATETIME</code>	<code>MYSQL_TIME</code>
<code>TIMESTAMP</code>	<code>MYSQL_TYPE_TIMESTAMP</code>	<code>MYSQL_TIME</code>
<code>CHAR</code> , <code>BINARY</code>	<code>MYSQL_TYPE_STRING</code>	<code>char[]</code>
<code>VARCHAR</code> , <code>VARBINARY</code>	<code>MYSQL_TYPE_VAR_STRING</code>	<code>char[]</code>
<code>TINYBLOB</code> , <code>TINYTEXT</code>	<code>MYSQL_TYPE_TINY_BLOB</code>	<code>char[]</code>
<code>BLOB</code> , <code>TEXT</code>	<code>MYSQL_TYPE_BLOB</code>	<code>char[]</code>

MEDIUMBLOB, MEDIUMTEXT	MYSQL_TYPE_MEDIUM_BLOB	char[ ]
LOBLOB, LONGTEXT	MYSQL_TYPE_LONG_BLOB	char[ ]
BIT	MYSQL_TYPE_BIT	char[ ]

MySQL knows the type code for the SQL value on the server side. The `buffer_type` value indicates the MySQL the type code of the C variable that holds the value on the client side. The two codes together tell MySQL what conversion must be performed, if any. Here are some examples:

- If you use `MYSQL_TYPE_LONG` with an `int` variable to pass an integer value to the server that is to be stored into a `FLOAT` column, MySQL converts the value to floating-point format before storing it.
- If you fetch an SQL `MEDIUMINT` column value, but specify a `buffer_type` value of `MYSQL_TYPE_LONGLONG` and use a C variable of type `long long int` as the destination buffer, MySQL will convert the `MEDIUMINT` value (which requires less than 8 bytes) for storage into the `long long int` (an 8-byte variable).
- If you fetch a numeric column with a value of 255 into a `char[4]` character array and specify a `buffer_type` value of `MYSQL_TYPE_STRING`, the resulting value in the array will be a 4-byte string containing `'255\0'`.
- `DECIMAL` values are returned as strings, which is why the corresponding C type is `char[ ]`. `DECIMAL` values returned by the server correspond to the string representation of the original server-side value. For example, `12.345` is returned to the client as `'12.345'`. If you specify `MYSQL_TYPE_NEWDECIMAL` and bind a string buffer to the `MYSQL_BIND` structure, `mysql_stmt_fetch()` stores the value in the buffer without conversion. If instead you specify a numeric variable and type code, `mysql_stmt_fetch()` converts the string-format `DECIMAL` value to numeric form.
- For the `MYSQL_TYPE_BIT` type code, `BIT` values are returned into a string buffer (thus, the corresponding C type is `char[ ]` here, too). The value represents a bit string that requires interpretation on the client side. To return the value as a type that is easier to deal with, you can cause the value to be cast to integer using either of the following types of expressions:

```
SELECT bit_col + 0 FROM t
SELECT CAST(bit_col AS UNSIGNED) FROM t
```

To retrieve the value, bind an integer variable large enough to hold the value and specify the appropriate corresponding integer type code.

Before binding variables to the `MYSQL_BIND` structures that are to be used for fetching column values, you can check the type codes for each column of the result set. This might be desirable if you want to determine which variable types would be best to use to avoid type conversions. To get the type codes, call `mysql_stmt_result_metadata()` after executing the prepared statement with `mysql_stmt_execute()`. The metadata provides access to the type codes for the result set as described in [Section 20.10.7.22](#), “`mysql_stmt_result_metadata()`”, and [Section 20.10.1](#), “C API Data Types”.

If you cause the `max_length` member of the `MYSQL_FIELD` column metadata structures to be set (by calling `mysql_stmt_attr_set()`), be aware that the `max_length` values for the result set indicate the lengths of the longest string representation of the result values, not the lengths of the binary representation. That is, `max_length` does not necessarily correspond to the size of the buffers needed to fetch the values with the binary protocol used for prepared statements. The size of the buffers should be chosen according to the types of the variables into which you fetch the values.

For input character (nonbinary) string data (indicated by `MYSQL_TYPE_STRING`), the value is assumed to be in the character set indicated by the `character_set_client` system variable. If the value is stored into a column with a different character set, the appropriate conversion to that character set occurs. For input binary string data (indicated by `MYSQL_TYPE_BLOB`), the value is treated as having the `binary` character set; that is, it is treated as a byte string and no conversion occurs.

To determine whether output string values in a result set returned from the server contain binary or nonbinary data, check whether the `charsetnr` value of the result set metadata is 63 (see [Section 20.10.1](#), “C API Data Types”). If so, the character set is `binary`, which indicates binary rather than nonbinary data. This enables you to distinguish `BINARY` from `CHAR`, `VARBINARY` from `VARCHAR`, and the `BLOB` types from the `TEXT` types.

As of MySQL 5.1.25, metadata changes to tables or views referred to by prepared statements are detected and cause automatic reparation of the statement when it is next executed. For more information, see [Section 12.7.4](#), “Automatic Prepared Statement Reparation”.

## 20.10.6. C API Prepared Statement Function Overview

The functions available for prepared statement processing are summarized here and described in greater detail in a later section. See [Section 20.10.7](#), “C API Prepared Statement Function Descriptions”.

Function	Description
----------	-------------

<code>mysql_stmt_affected_rows()</code>	Returns the number of rows changed, deleted, or inserted by prepared <code>UPDATE</code> , <code>DELETE</code> , or <code>INSERT</code> statement
<code>mysql_stmt_attr_get()</code>	Get value of an attribute for a prepared statement
<code>mysql_stmt_attr_set()</code>	Sets an attribute for a prepared statement
<code>mysql_stmt_bind_param()</code>	Associates application data buffers with the parameter markers in a prepared SQL statement
<code>mysql_stmt_bind_result()</code>	Associates application data buffers with columns in the result set
<code>mysql_stmt_close()</code>	Frees memory used by prepared statement
<code>mysql_stmt_data_seek()</code>	Seeks to an arbitrary row number in a statement result set
<code>mysql_stmt_errno()</code>	Returns the error number for the last statement execution
<code>mysql_stmt_error()</code>	Returns the error message for the last statement execution
<code>mysql_stmt_execute()</code>	Executes the prepared statement
<code>mysql_stmt_fetch()</code>	Fetches the next row of data from the result set and returns data for all bound columns
<code>mysql_stmt_fetch_column()</code>	Fetch data for one column of the current row of the result set
<code>mysql_stmt_field_count()</code>	Returns the number of result columns for the most recent statement
<code>mysql_stmt_free_result()</code>	Free the resources allocated to the statement handle
<code>mysql_stmt_init()</code>	Allocates memory for <code>MYSQL_STMT</code> structure and initializes it
<code>mysql_stmt_insert_id()</code>	Returns the ID generated for an <code>AUTO_INCREMENT</code> column by prepared statement
<code>mysql_stmt_num_rows()</code>	Returns total row count from the buffered statement result set
<code>mysql_stmt_param_count()</code>	Returns the number of parameters in a prepared SQL statement
<code>mysql_stmt_param_metadata()</code>	(Return parameter metadata in the form of a result set.) Currently, this function does nothing
<code>mysql_stmt_prepare()</code>	Prepares an SQL string for execution
<code>mysql_stmt_reset()</code>	Reset the statement buffers in the server
<code>mysql_stmt_result_metadata()</code>	Returns prepared statement metadata in the form of a result set
<code>mysql_stmt_row_seek()</code>	Seeks to a row offset in a statement result set, using value returned from <code>mysql_stmt_row_tell()</code>
<code>mysql_stmt_row_tell()</code>	Returns the statement row cursor position
<code>mysql_stmt_send_long_data()</code>	Sends long data in chunks to server
<code>mysql_stmt_sqlstate()</code>	Returns the <code>SQLSTATE</code> error code for the last statement execution
<code>mysql_stmt_store_result()</code>	Retrieves the complete result set to the client

Call `mysql_stmt_init()` to create a statement handle, then `mysql_stmt_prepare()` to prepare it, `mysql_stmt_bind_param()` to supply the parameter data, and `mysql_stmt_execute()` to execute the statement. You can repeat the `mysql_stmt_execute()` by changing parameter values in the respective buffers supplied through `mysql_stmt_bind_param()`.

If the statement is a `SELECT` or any other statement that produces a result set, `mysql_stmt_prepare()` also returns the result set metadata information in the form of a `MYSQL_RES` result set through `mysql_stmt_result_metadata()`.

You can supply the result buffers using `mysql_stmt_bind_result()`, so that the `mysql_stmt_fetch()` automatically returns data to these buffers. This is row-by-row fetching.

You can also send the text or binary data in chunks to server using `mysql_stmt_send_long_data()`. See [Section 20.10.7.25](#), “`mysql_stmt_send_long_data()`”.

When statement execution has been completed, the statement handle must be closed using `mysql_stmt_close()` so that all resources associated with it can be freed.

If you obtained a `SELECT` statement's result set metadata by calling `mysql_stmt_result_metadata()`, you should also free the metadata using `mysql_free_result()`.

### Execution Steps

To prepare and execute a statement, an application follows these steps:



1. Create a prepared statement handle with `mysql_stmt_init()`. To prepare the statement on the server, call `mysql_stmt_prepare()` and pass it a string containing the SQL statement.
2. If the statement produces a result set, call `mysql_stmt_result_metadata()` to obtain the result set metadata. This metadata is itself in the form of result set, albeit a separate one from the one that contains the rows returned by the query. The metadata result set indicates how many columns are in the result and contains information about each column.
3. Set the values of any parameters using `mysql_stmt_bind_param()`. All parameters must be set. Otherwise, statement execution returns an error or produces unexpected results.
4. Call `mysql_stmt_execute()` to execute the statement.
5. If the statement produces a result set, bind the data buffers to use for retrieving the row values by calling `mysql_stmt_bind_result()`.
6. Fetch the data into the buffers row by row by calling `mysql_stmt_fetch()` repeatedly until no more rows are found.
7. Repeat steps 3 through 6 as necessary, by changing the parameter values and re-executing the statement.

When `mysql_stmt_prepare()` is called, the MySQL client/server protocol performs these actions:

- The server parses the statement and sends the okay status back to the client by assigning a statement ID. It also sends total number of parameters, a column count, and its metadata if it is a result set oriented statement. All syntax and semantics of the statement are checked by the server during this call.
- The client uses this statement ID for the further operations, so that the server can identify the statement from among its pool of statements.

When `mysql_stmt_execute()` is called, the MySQL client/server protocol performs these actions:

- The client uses the statement handle and sends the parameter data to the server.
- The server identifies the statement using the ID provided by the client, replaces the parameter markers with the newly supplied data, and executes the statement. If the statement produces a result set, the server sends the data back to the client. Otherwise, it sends an okay status and total number of rows changed, deleted, or inserted.

When `mysql_stmt_fetch()` is called, the MySQL client/server protocol performs these actions:

- The client reads the data from the packet row by row and places it into the application data buffers by doing the necessary conversions. If the application buffer type is same as that of the field type returned from the server, the conversions are straightforward.

If an error occurs, you can get the statement error code, error message, and SQLSTATE value using `mysql_stmt_errno()`, `mysql_stmt_error()`, and `mysql_stmt_sqlstate()`, respectively.

### Prepared Statement Logging

For prepared statements that are executed with the `mysql_stmt_prepare()` and `mysql_stmt_execute()` C API functions, the server writes `Prepare` and `Execute` lines to the general query log so that you can tell when statements are prepared and executed.

Suppose that you prepare and execute a statement as follows:

1. Call `mysql_stmt_prepare()` to prepare the statement string `"SELECT ?"`.
2. Call `mysql_stmt_bind_param()` to bind the value `3` to the parameter in the prepared statement.
3. Call `mysql_stmt_execute()` to execute the prepared statement.

As a result of the preceding calls, the server writes the following lines to the general query log:

```
Prepare [1] SELECT ?
Execute [1] SELECT 3
```



Each `Prepare` and `Execute` line in the log is tagged with a `[N]` statement identifier so that you can keep track of which prepared statement is being logged. `N` is a positive integer. If there are multiple prepared statements active simultaneously for the client, `N` may be greater than 1. Each `Execute` line shows a prepared statement after substitution of data values for `?` parameters.

Version notes: `Prepare` lines are displayed without `[N]` before MySQL 4.1.10. `Execute` lines are not displayed at all before MySQL 4.1.10.

## 20.10.7. C API Prepared Statement Function Descriptions

To prepare and execute queries, use the functions described in detail in the following sections.

All functions that operate with a `MYSQL_STMT` structure begin with the prefix `mysql_stmt_`.

To create a `MYSQL_STMT` handle, use the `mysql_stmt_init()` function.

### 20.10.7.1. `mysql_stmt_affected_rows()`

```
my_ulonglong mysql_stmt_affected_rows(MYSQL_STMT *stmt)
```

#### Description

Returns the total number of rows changed, deleted, or inserted by the last executed statement. May be called immediately after `mysql_stmt_execute()` for `UPDATE`, `DELETE`, or `INSERT` statements. For `SELECT` statements, `mysql_stmt_affected_rows()` works like `mysql_num_rows()`.

#### Return Values

An integer greater than zero indicates the number of rows affected or retrieved. Zero indicates that no records were updated for an `UPDATE` statement, no rows matched the `WHERE` clause in the query, or that no query has yet been executed. -1 indicates that the query returned an error or that, for a `SELECT` query, `mysql_stmt_affected_rows()` was called prior to calling `mysql_stmt_store_result()`. Because `mysql_stmt_affected_rows()` returns an unsigned value, you can check for -1 by comparing the return value to `(my_ulonglong)-1` (or to `(my_ulonglong)~0`, which is equivalent).

See [Section 20.10.3.1](#), “`mysql_affected_rows()`”, for additional information on the return value.

#### Errors

None.

#### Example

For the usage of `mysql_stmt_affected_rows()`, refer to the Example from [Section 20.10.7.10](#), “`mysql_stmt_execute()`”.

### 20.10.7.2. `mysql_stmt_attr_get()`

```
my_bool mysql_stmt_attr_get(MYSQL_STMT *stmt, enum enum_stmt_attr_type option, void *arg)
```

#### Description

Can be used to get the current value for a statement attribute.

The `option` argument is the option that you want to get; the `arg` should point to a variable that should contain the option value. If the option is an integer, then `arg` should point to the value of the integer.

See [Section 20.10.7.3](#), “`mysql_stmt_attr_set()`”, for a list of options and option types.

#### Note

In MySQL 5.1, `mysql_stmt_attr_get()` originally used `unsigned int *`, not `my_bool *`, for `STMT_ATTR_UPDATE_MAX_LENGTH`. This was corrected in MySQL 5.1.7.

#### Return Values

Zero if successful. Nonzero if `option` is unknown.

#### Errors

None.

### 20.10.7.3. `mysql_stmt_attr_set()`

```
my_bool mysql_stmt_attr_set(MYSQL_STMT *stmt, enum enum_stmt_attr_type option, const
void *arg)
```

#### Description

Can be used to affect behavior for a prepared statement. This function may be called multiple times to set several options.

The `option` argument is the option that you want to set. The `arg` argument is the value for the option. `arg` should point to a variable that is set to the desired attribute value. The variable type is as indicated in the following table.

The following table shows the possible `option` values.

Option	Argument Type	Function
<code>STMT_ATTR_UPDATE_MAX_LENGTH</code>	<code>my_bool *</code>	If set to 1, causes <code>mysql_stmt_store_result()</code> to update the metadata <code>MYSQL_FIELD-&gt;max_length</code> value.
<code>STMT_ATTR_CURSOR_TYPE</code>	<code>unsigned long *</code>	Type of cursor to open for statement when <code>mysql_stmt_execute()</code> is invoked. <code>*arg</code> can be <code>CURSOR_TYPE_NO_CURSOR</code> (the default) or <code>CURSOR_TYPE_READ_ONLY</code> .
<code>STMT_ATTR_PREFETCH_ROWS</code>	<code>unsigned long *</code>	Number of rows to fetch from server at a time when using a cursor. <code>*arg</code> can be in the range from 1 to the maximum value of <code>unsigned long</code> . The default is 1.

If you use the `STMT_ATTR_CURSOR_TYPE` option with `CURSOR_TYPE_READ_ONLY`, a cursor is opened for the statement when you invoke `mysql_stmt_execute()`. If there is already an open cursor from a previous `mysql_stmt_execute()` call, it closes the cursor before opening a new one. `mysql_stmt_reset()` also closes any open cursor before preparing the statement for re-execution. `mysql_stmt_free_result()` closes any open cursor.

If you open a cursor for a prepared statement, `mysql_stmt_store_result()` is unnecessary, because that function causes the result set to be buffered on the client side.

#### Return Values

Zero if successful. Nonzero if `option` is unknown.

#### Errors

None.

#### Example

The following example opens a cursor for a prepared statement and sets the number of rows to fetch at a time to 5:

```
MYSQL_STMT *stmt;
int rc;
unsigned long type;
unsigned long prefetch_rows = 5;

stmt = mysql_stmt_init(mysql);
type = (unsigned long) CURSOR_TYPE_READ_ONLY;
rc = mysql_stmt_attr_set(stmt, STMT_ATTR_CURSOR_TYPE, (void*) &type);
/* ... check return value ... */
rc = mysql_stmt_attr_set(stmt, STMT_ATTR_PREFETCH_ROWS,
                        (void*) &prefetch_rows);
/* ... check return value ... */
```

### 20.10.7.4. `mysql_stmt_bind_param()`

```
my_bool mysql_stmt_bind_param(MYSQL_STMT *stmt, MYSQL_BIND *bind)
```

#### Description

`mysql_stmt_bind_param()` is used to bind input data for the parameter markers in the SQL statement that was passed to `mysql_stmt_prepare()`. It uses `MYSQL_BIND` structures to supply the data. `bind` is the address of an array of `MYSQL_BIND` structures. The client library expects the array to contain one element for each “?” parameter marker that is present

in the query.

Suppose that you prepare the following statement:

```
INSERT INTO mytbl VALUES(?,?,?)
```

When you bind the parameters, the array of `MYSQL_BIND` structures must contain three elements, and can be declared like this:

```
MYSQL_BIND bind[3];
```

[Section 20.10.5, “C API Prepared Statement Data types”](#), describes the members of each `MYSQL_BIND` element and how they should be set to provide input values.

### Return Values

Zero if the bind operation was successful. Nonzero if an error occurred.

### Errors

- `CR_UNSUPPORTED_PARAM_TYPE`  
The conversion is not supported. Possibly the `buffer_type` value is illegal or is not one of the supported types.
- `CR_OUT_OF_MEMORY`  
Out of memory.
- `CR_UNKNOWN_ERROR`  
An unknown error occurred.

### Example

For the usage of `mysql_stmt_bind_param()`, refer to the Example from [Section 20.10.7.10, “mysql\\_stmt\\_execute\(\)”](#).

## 20.10.7.5. `mysql_stmt_bind_result()`

```
my_bool mysql_stmt_bind_result(MYSQL_STMT *stmt, MYSQL_BIND *bind)
```

### Description

`mysql_stmt_bind_result()` is used to associate (that is, bind) output columns in the result set to data buffers and length buffers. When `mysql_stmt_fetch()` is called to fetch data, the MySQL client/server protocol places the data for the bound columns into the specified buffers.

All columns must be bound to buffers prior to calling `mysql_stmt_fetch()`. `bind` is the address of an array of `MYSQL_BIND` structures. The client library expects the array to contain one element for each column of the result set. If you do not bind columns to `MYSQL_BIND` structures, `mysql_stmt_fetch()` simply ignores the data fetch. The buffers should be large enough to hold the data values, because the protocol doesn't return data values in chunks.

A column can be bound or rebound at any time, even after a result set has been partially retrieved. The new binding takes effect the next time `mysql_stmt_fetch()` is called. Suppose that an application binds the columns in a result set and calls `mysql_stmt_fetch()`. The client/server protocol returns data in the bound buffers. Then suppose that the application binds the columns to a different set of buffers. The protocol places data into the newly bound buffers when the next call to `mysql_stmt_fetch()` occurs.

To bind a column, an application calls `mysql_stmt_bind_result()` and passes the type, address, and length of the output buffer into which the value should be stored. [Section 20.10.5, “C API Prepared Statement Data types”](#), describes the members of each `MYSQL_BIND` element and how they should be set to receive output values.

### Return Values

Zero if the bind operation was successful. Nonzero if an error occurred.

### Errors

- `CR_UNSUPPORTED_PARAM_TYPE`

The conversion is not supported. Possibly the `buffer_type` value is illegal or is not one of the supported types.

- `CR_OUT_OF_MEMORY`

Out of memory.

- `CR_UNKNOWN_ERROR`

An unknown error occurred.

#### Example

For the usage of `mysql_stmt_bind_result()`, refer to the Example from [Section 20.10.7.11](#), “`mysql_stmt_fetch()`”.

### 20.10.7.6. `mysql_stmt_close()`

```
my_bool mysql_stmt_close(MYSQL_STMT *)
```

#### Description

Closes the prepared statement. `mysql_stmt_close()` also deallocates the statement handle pointed to by `stmt`.

If the current statement has pending or unread results, this function cancels them so that the next query can be executed.

#### Return Values

Zero if the statement was freed successfully. Nonzero if an error occurred.

#### Errors

- `CR_SERVER_GONE_ERROR`

The MySQL server has gone away.

- `CR_UNKNOWN_ERROR`

An unknown error occurred.

#### Example

For the usage of `mysql_stmt_close()`, refer to the Example from [Section 20.10.7.10](#), “`mysql_stmt_execute()`”.

### 20.10.7.7. `mysql_stmt_data_seek()`

```
void mysql_stmt_data_seek(MYSQL_STMT *stmt, my_ulonglong offset)
```

#### Description

Seeks to an arbitrary row in a statement result set. The `offset` value is a row number and should be in the range from 0 to `mysql_stmt_num_rows(stmt)-1`.

This function requires that the statement result set structure contains the entire result of the last executed query, so `mysql_stmt_data_seek()` may be used only in conjunction with `mysql_stmt_store_result()`.

#### Return Values

None.

#### Errors

None.

### 20.10.7.8. `mysql_stmt_errno()`

```
unsigned int mysql_stmt_errno(MYSQL_STMT *stmt)
```

#### Description

For the statement specified by `stmt`, `mysql_stmt_errno()` returns the error code for the most recently invoked statement API function that can succeed or fail. A return value of zero means that no error occurred. Client error message numbers are listed in the MySQL `errmsg.h` header file. Server error message numbers are listed in `mysqld_error.h`. Errors also are listed at [Appendix B, Errors, Error Codes, and Common Problems](#).

#### Return Values

An error code value. Zero if no error occurred.

#### Errors

None.

### 20.10.7.9. `mysql_stmt_error()`

```
const char *mysql_stmt_error(MYSQL_STMT *stmt)
```

#### Description

For the statement specified by `stmt`, `mysql_stmt_error()` returns a null-terminated string containing the error message for the most recently invoked statement API function that can succeed or fail. An empty string ("" ) is returned if no error occurred. This means the following two tests are equivalent:

```
if (*mysql_stmt_errno(stmt))
{
    // an error occurred
}

if (mysql_stmt_error(stmt)[0])
{
    // an error occurred
}
```

The language of the client error messages may be changed by recompiling the MySQL client library. Currently, you can choose error messages in several different languages.

#### Return Values

A character string that describes the error. An empty string if no error occurred.

#### Errors

None.

### 20.10.7.10. `mysql_stmt_execute()`

```
int mysql_stmt_execute(MYSQL_STMT *stmt)
```

#### Description

`mysql_stmt_execute()` executes the prepared query associated with the statement handle. The currently bound parameter marker values are sent to server during this call, and the server replaces the markers with this newly supplied data.

If the statement is an `UPDATE`, `DELETE`, or `INSERT`, the total number of changed, deleted, or inserted rows can be found by calling `mysql_stmt_affected_rows()`. If this is a statement such as `SELECT` that generates a result set, you must call `mysql_stmt_fetch()` to fetch the data prior to calling any other functions that result in query processing. For more information on how to fetch the results, refer to [Section 20.10.7.11, “mysql\\_stmt\\_fetch\(\)”](#).

For statements that generate a result set, you can request that `mysql_stmt_execute()` open a cursor for the statement by calling `mysql_stmt_attr_set()` before executing the statement. If you execute a statement multiple times, `mysql_stmt_execute()` closes any open cursor before opening a new one.

As of MySQL 5.1.25, metadata changes to tables or views referred to by prepared statements are detected and cause automatic reparation of the statement when it is next executed. For more information, see [Section 12.7.4, “Automatic Prepared Statement Reparation”](#).

#### Return Values

Zero if execution was successful. Nonzero if an error occurred.

#### Errors

- [CR\\_COMMANDS\\_OUT\\_OF\\_SYNC](#)

Commands were executed in an improper order.

- [CR\\_OUT\\_OF\\_MEMORY](#)

Out of memory.

- [CR\\_SERVER\\_GONE\\_ERROR](#)

The MySQL server has gone away.

- [CR\\_SERVER\\_LOST](#)

The connection to the server was lost during the query.

- [CR\\_UNKNOWN\\_ERROR](#)

An unknown error occurred.

### Example

The following example demonstrates how to create and populate a table using `mysql_stmt_init()`, `mysql_stmt_prepare()`, `mysql_stmt_param_count()`, `mysql_stmt_bind_param()`, `mysql_stmt_execute()`, and `mysql_stmt_affected_rows()`. The `mysql` variable is assumed to be a valid connection handle.

```
#define STRING_SIZE 50
#define DROP_SAMPLE_TABLE "DROP TABLE IF EXISTS test_table"
#define CREATE_SAMPLE_TABLE "CREATE TABLE test_table(coll INT,\
                                col2 VARCHAR(40),\
                                col3 SMALLINT,\
                                col4 TIMESTAMP)"
#define INSERT_SAMPLE "INSERT INTO \
    test_table(coll,col2,col3) \
    VALUES(?,?,?)"

MYSQL_STMT    *stmt;
MYSQL_BIND    bind[3];
my_ulonglong  affected_rows;
int           param_count;
short        small_data;
int          int_data;
char         str_data[STRING_SIZE];
unsigned long str_length;
my_bool      is_null;

if (mysql_query(mysql, DROP_SAMPLE_TABLE))
{
    fprintf(stderr, " DROP TABLE failed\n");
    fprintf(stderr, " %s\n", mysql_error(mysql));
    exit(0);
}

if (mysql_query(mysql, CREATE_SAMPLE_TABLE))
{
    fprintf(stderr, " CREATE TABLE failed\n");
    fprintf(stderr, " %s\n", mysql_error(mysql));
    exit(0);
}

/* Prepare an INSERT query with 3 parameters */
/* (the TIMESTAMP column is not named; the server */
/* sets it to the current date and time) */
stmt = mysql_stmt_init(mysql);
if (!stmt)
{
    fprintf(stderr, " mysql_stmt_init(), out of memory\n");
    exit(0);
}
if (mysql_stmt_prepare(stmt, INSERT_SAMPLE, strlen(INSERT_SAMPLE)))
{
    fprintf(stderr, " mysql_stmt_prepare(), INSERT failed\n");
    fprintf(stderr, " %s\n", mysql_stmt_error(stmt));
    exit(0);
}
fprintf(stdout, " prepare, INSERT successful\n");

/* Get the parameter count from the statement */
param_count= mysql_stmt_param_count(stmt);
fprintf(stdout, " total parameters in INSERT: %d\n", param_count);

if (param_count != 3) /* validate parameter count */
{
    fprintf(stderr, " invalid parameter count returned by MySQL\n");
}
```

```

    exit(0);
}

/* Bind the data for all 3 parameters */
memset(bind, 0, sizeof(bind));

/* INTEGER PARAM */
/* This is a number type, so there is no need
   to specify buffer_length */
bind[0].buffer_type= MYSQL_TYPE_LONG;
bind[0].buffer= (char *)&int_data;
bind[0].is_null= 0;
bind[0].length= 0;

/* STRING PARAM */
bind[1].buffer_type= MYSQL_TYPE_STRING;
bind[1].buffer= (char *)str_data;
bind[1].buffer_length= STRING_SIZE;
bind[1].is_null= 0;
bind[1].length= &str_length;

/* SMALLINT PARAM */
bind[2].buffer_type= MYSQL_TYPE_SHORT;
bind[2].buffer= (char *)&small_data;
bind[2].is_null= &is_null;
bind[2].length= 0;

/* Bind the buffers */
if (mysql_stmt_bind_param(stmt, bind))
{
    fprintf(stderr, " mysql_stmt_bind_param() failed\n");
    fprintf(stderr, " %s\n", mysql_stmt_error(stmt));
    exit(0);
}

/* Specify the data values for the first row */
int_data= 10; /* integer */
strncpy(str_data, "MySQL", STRING_SIZE); /* string */
str_length= strlen(str_data);

/* INSERT SMALLINT data as NULL */
is_null= 1;

/* Execute the INSERT statement - 1*/
if (mysql_stmt_execute(stmt))
{
    fprintf(stderr, " mysql_stmt_execute(), 1 failed\n");
    fprintf(stderr, " %s\n", mysql_stmt_error(stmt));
    exit(0);
}

/* Get the total number of affected rows */
affected_rows= mysql_stmt_affected_rows(stmt);
fprintf(stdout, " total affected rows(insert 1): %lu\n",
        (unsigned long) affected_rows);

if (affected_rows != 1) /* validate affected rows */
{
    fprintf(stderr, " invalid affected rows by MySQL\n");
    exit(0);
}

/* Specify data values for second row,
   then re-execute the statement */
int_data= 1000;
strncpy(str_data, "
    The most popular Open Source database",
        STRING_SIZE);
str_length= strlen(str_data);
small_data= 1000; /* smallint */
is_null= 0; /* reset */

/* Execute the INSERT statement - 2*/
if (mysql_stmt_execute(stmt))
{
    fprintf(stderr, " mysql_stmt_execute, 2 failed\n");
    fprintf(stderr, " %s\n", mysql_stmt_error(stmt));
    exit(0);
}

/* Get the total rows affected */
affected_rows= mysql_stmt_affected_rows(stmt);
fprintf(stdout, " total affected rows(insert 2): %lu\n",
        (unsigned long) affected_rows);

if (affected_rows != 1) /* validate affected rows */
{
    fprintf(stderr, " invalid affected rows by MySQL\n");
    exit(0);
}

/* Close the statement */
if (mysql_stmt_close(stmt))
{
    fprintf(stderr, " failed while closing the statement\n");
    fprintf(stderr, " %s\n", mysql_stmt_error(stmt));
}

```

```
exit(0);
}
```

**Note**

For complete examples on the use of prepared statement functions, refer to the file `tests/mysql_client_test.c`. This file can be obtained from a MySQL source distribution or from the Bazaar source repository.

**20.10.7.11. `mysql_stmt_fetch()`**

```
int mysql_stmt_fetch(MYSQL_STMT *stmt)
```

**Description**

`mysql_stmt_fetch()` returns the next row in the result set. It can be called only while the result set exists; that is, after a call to `mysql_stmt_execute()` for a statement such as `SELECT` that creates a result set.

`mysql_stmt_fetch()` returns row data using the buffers bound by `mysql_stmt_bind_result()`. It returns the data in those buffers for all the columns in the current row set and the lengths are returned to the `length` pointer. All columns must be bound by the application before it calls `mysql_stmt_fetch()`.

By default, result sets are fetched unbuffered a row at a time from the server. To buffer the entire result set on the client, call `mysql_stmt_store_result()` after binding the data buffers and before calling `mysql_stmt_fetch()`.

If a fetched data value is a `NULL` value, the `*is_null` value of the corresponding `MYSQL_BIND` structure contains `TRUE` (1). Otherwise, the data and its length are returned in the `*buffer` and `*length` elements based on the buffer type specified by the application. Each numeric and temporal type has a fixed length, as listed in the following table. The length of the string types depends on the length of the actual data value, as indicated by `data_length`.

Type	Length
<code>MYSQL_TYPE_TINY</code>	1
<code>MYSQL_TYPE_SHORT</code>	2
<code>MYSQL_TYPE_LONG</code>	4
<code>MYSQL_TYPE_LONGLONG</code>	8
<code>MYSQL_TYPE_FLOAT</code>	4
<code>MYSQL_TYPE_DOUBLE</code>	8
<code>MYSQL_TYPE_TIME</code>	<code>sizeof(MYSQL_TIME)</code>
<code>MYSQL_TYPE_DATE</code>	<code>sizeof(MYSQL_TIME)</code>
<code>MYSQL_TYPE_DATETIME</code>	<code>sizeof(MYSQL_TIME)</code>
<code>MYSQL_TYPE_STRING</code>	<code>data length</code>
<code>MYSQL_TYPE_BLOB</code>	<code>data_length</code>

**Return Values**

Return Value	Description
0	Successful, the data has been fetched to application data buffers.
1	Error occurred. Error code and message can be obtained by calling <code>mysql_stmt_errno()</code> and <code>mysql_stmt_error()</code> .
<code>MYSQL_NO_DATA</code>	No more rows/data exists
<code>MYSQL_DATA_TRUNCATED</code>	Data truncation occurred

`MYSQL_DATA_TRUNCATED` is returned when truncation reporting is enabled. (Reporting is enabled by default, but can be controlled with `mysql_options()`.) To determine which parameters were truncated when this value is returned, check the `error` members of the `MYSQL_BIND` parameter structures.

**Errors**

- `CR_COMMANDS_OUT_OF_SYNC`



Commands were executed in an improper order.

- `CR_OUT_OF_MEMORY`

Out of memory.

- `CR_SERVER_GONE_ERROR`

The MySQL server has gone away.

- `CR_SERVER_LOST`

The connection to the server was lost during the query.

- `CR_UNKNOWN_ERROR`

An unknown error occurred.

- `CR_UNSUPPORTED_PARAM_TYPE`

The buffer type is `MYSQL_TYPE_DATE`, `MYSQL_TYPE_TIME`, `MYSQL_TYPE_DATETIME`, or `MYSQL_TYPE_TIMESTAMP`, but the data type is not `DATE`, `TIME`, `DATETIME`, or `TIMESTAMP`.

- All other unsupported conversion errors are returned from `mysql_stmt_bind_result()`.

### Example

The following example demonstrates how to fetch data from a table using `mysql_stmt_result_metadata()`, `mysql_stmt_bind_result()`, and `mysql_stmt_fetch()`. (This example expects to retrieve the two rows inserted by the example shown in [Section 20.10.7.10](#), “`mysql_stmt_execute()`”). The `mysql` variable is assumed to be a valid connection handle.

```
#define STRING_SIZE 50

#define SELECT_SAMPLE "SELECT col1, col2, col3, col4 \
    FROM test_table"

MYSQL_STMT      *stmt;
MYSQL_BIND      bind[4];
MYSQL_RES       *prepare_meta_result;
MYSQL_TIME      ts;
unsigned long   length[4];
int             param_count, column_count, row_count;
short          small_data;
int            int_data;
char           str_data[STRING_SIZE];
my_bool        is_null[4];
my_bool        error[4];

/* Prepare a SELECT query to fetch data from test_table */
stmt = mysql_stmt_init(mysql);
if (!stmt)
{
    fprintf(stderr, " mysql_stmt_init(), out of memory\n");
    exit(0);
}
if (mysql_stmt_prepare(stmt, SELECT_SAMPLE, strlen(SELECT_SAMPLE)))
{
    fprintf(stderr, " mysql_stmt_prepare(), SELECT failed\n");
    fprintf(stderr, " %s\n", mysql_stmt_error(stmt));
    exit(0);
}
fprintf(stdout, " prepare, SELECT successful\n");

/* Get the parameter count from the statement */
param_count = mysql_stmt_param_count(stmt);
fprintf(stdout, " total parameters in SELECT: %d\n", param_count);

if (param_count != 0) /* validate parameter count */
{
    fprintf(stderr, " invalid parameter count returned by MySQL\n");
    exit(0);
}

/* Fetch result set meta information */
prepare_meta_result = mysql_stmt_result_metadata(stmt);
if (!prepare_meta_result)
{
    fprintf(stderr,
        " mysql_stmt_result_metadata(), \
        returned no meta information\n");
    fprintf(stderr, " %s\n", mysql_stmt_error(stmt));
    exit(0);
}
```

```

}

/* Get total columns in the query */
column_count= mysql_num_fields(prepare_meta_result);
fprintf(stdout,
        " total columns in SELECT statement: %d\n",
        column_count);

if (column_count != 4) /* validate column count */
{
    fprintf(stderr, " invalid column count returned by MySQL\n");
    exit(0);
}

/* Execute the SELECT query */
if (mysql_stmt_execute(stmt))
{
    fprintf(stderr, " mysql_stmt_execute(), failed\n");
    fprintf(stderr, " %s\n", mysql_stmt_error(stmt));
    exit(0);
}

/* Bind the result buffers for all 4 columns before fetching them */
memset(bind, 0, sizeof(bind));

/* INTEGER COLUMN */
bind[0].buffer_type= MYSQL_TYPE_LONG;
bind[0].buffer= (char *)&int_data;
bind[0].is_null= &is_null[0];
bind[0].length= &length[0];
bind[0].error= &error[0];

/* STRING COLUMN */
bind[1].buffer_type= MYSQL_TYPE_STRING;
bind[1].buffer= (char *)str_data;
bind[1].buffer_length= STRING_SIZE;
bind[1].is_null= &is_null[1];
bind[1].length= &length[1];
bind[1].error= &error[1];

/* SMALLINT COLUMN */
bind[2].buffer_type= MYSQL_TYPE_SHORT;
bind[2].buffer= (char *)&small_data;
bind[2].is_null= &is_null[2];
bind[2].length= &length[2];
bind[2].error= &error[2];

/* TIMESTAMP COLUMN */
bind[3].buffer_type= MYSQL_TYPE_TIMESTAMP;
bind[3].buffer= (char *)&ts;
bind[3].is_null= &is_null[3];
bind[3].length= &length[3];
bind[3].error= &error[3];

/* Bind the result buffers */
if (mysql_stmt_bind_result(stmt, bind))
{
    fprintf(stderr, " mysql_stmt_bind_result() failed\n");
    fprintf(stderr, " %s\n", mysql_stmt_error(stmt));
    exit(0);
}

/* Now buffer all results to client (optional step) */
if (mysql_stmt_store_result(stmt))
{
    fprintf(stderr, " mysql_stmt_store_result() failed\n");
    fprintf(stderr, " %s\n", mysql_stmt_error(stmt));
    exit(0);
}

/* Fetch all rows */
row_count= 0;
fprintf(stdout, "Fetching results ...\n");
while (!mysql_stmt_fetch(stmt))
{
    row_count++;
    fprintf(stdout, " row %d\n", row_count);

    /* column 1 */
    fprintf(stdout, " column1 (integer) : ");
    if (is_null[0])
        fprintf(stdout, " NULL\n");
    else
        fprintf(stdout, " %d(%ld)\n", int_data, length[0]);

    /* column 2 */
    fprintf(stdout, " column2 (string) : ");
    if (is_null[1])
        fprintf(stdout, " NULL\n");
    else
        fprintf(stdout, " %s(%ld)\n", str_data, length[1]);

    /* column 3 */
    fprintf(stdout, " column3 (smallint) : ");
    if (is_null[2])
        fprintf(stdout, " NULL\n");

```

```

else
    fprintf(stdout, " %d(%ld)\n", small_data, length[2]);

/* column 4 */
fprintf(stdout, "    column4 (timestamp): ");
if (is_null[3])
    fprintf(stdout, " NULL\n");
else
    fprintf(stdout, " %04d-%02d-%02d %02d:%02d:%02d (%ld)\n",
            ts.year, ts.month, ts.day,
            ts.hour, ts.minute, ts.second,
            length[3]);
fprintf(stdout, "\n");
}

/* Validate rows fetched */
fprintf(stdout, " total rows fetched: %d\n", row_count);
if (row_count != 2)
{
    fprintf(stderr, " MySQL failed to return all rows\n");
    exit(0);
}

/* Free the prepared result metadata */
mysql_free_result(prepare_meta_result);

/* Close the statement */
if (mysql_stmt_close(stmt))
{
    fprintf(stderr, " failed while closing the statement\n");
    fprintf(stderr, " %s\n", mysql_stmt_error(stmt));
    exit(0);
}

```

In some cases you might want to determine the length of a column value before fetching it with `mysql_stmt_fetch()`. For example, the value might be a long string or `BLOB` value for which you want to know how much space must be allocated. To accomplish this, you can use these strategies:

- Before invoking `mysql_stmt_fetch()` to retrieve individual rows, invoke `mysql_stmt_store_result()` to buffer the entire result on the client side. Then the maximal length of column values will be indicated by the `max_length` member of the result set metadata returned by `mysql_stmt_result_metadata()`. This strategy requires that you pass `STMT_ATTR_UPDATE_MAX_LENGTH` to `mysql_stmt_attr_set()` or the `max_length` values will not be calculated.
- Invoke `mysql_stmt_fetch()` with a zero-length buffer for the column in question and a pointer in which the real length can be stored. Then use the real length with `mysql_stmt_fetch_column()`.

```

real_length= 0;

bind[0].buffer= 0;
bind[0].buffer_length= 0;
bind[0].length= &real_length;
mysql_stmt_bind_result(stmt, bind);

mysql_stmt_fetch(stmt);
if (real_length > 0)
{
    data= malloc(real_length);
    bind[0].buffer= data;
    bind[0].buffer_length= real_length;
    mysql_stmt_fetch_column(stmt, bind, 0, 0);
}

```

### 20.10.7.12. `mysql_stmt_fetch_column()`

```
int mysql_stmt_fetch_column(MYSQL_STMT *stmt, MYSQL_BIND *bind, unsigned int column, unsigned long offset)
```

#### Description

Fetch one column from the current result set row. `bind` provides the buffer where data should be placed. It should be set up the same way as for `mysql_stmt_bind_result()`. `column` indicates which column to fetch. The first column is numbered 0. `offset` is the offset within the data value at which to begin retrieving data. This can be used for fetching the data value in pieces. The beginning of the value is offset 0.

As of MySQL 5.1.25, metadata changes to tables or views referred to by prepared statements are detected and cause automatic reparation of the statement when it is next executed. For more information, see [Section 12.7.4, “Automatic Prepared Statement Reparation”](#).

#### Return Values

Zero if the value was fetched successfully. Nonzero if an error occurred.

**Errors**

- `CR_INVALID_PARAMETER_NO`  
Invalid column number.
- `CR_NO_DATA`  
The end of the result set has already been reached.

**20.10.7.13. `mysql_stmt_field_count()`**

```
unsigned int mysql_stmt_field_count(MYSQL_STMT *stmt)
```

**Description**

Returns the number of columns for the most recent statement for the statement handler. This value is zero for statements such as `INSERT` or `DELETE` that do not produce result sets.

`mysql_stmt_field_count()` can be called after you have prepared a statement by invoking `mysql_stmt_prepare()`.

**Return Values**

An unsigned integer representing the number of columns in a result set.

**Errors**

None.

**20.10.7.14. `mysql_stmt_free_result()`**

```
my_bool mysql_stmt_free_result(MYSQL_STMT *stmt)
```

**Description**

Releases memory associated with the result set produced by execution of the prepared statement. If there is a cursor open for the statement, `mysql_stmt_free_result()` closes it.

**Return Values**

Zero if the result set was freed successfully. Nonzero if an error occurred.

**Errors****20.10.7.15. `mysql_stmt_init()`**

```
MYSQL_STMT *mysql_stmt_init(MYSQL *mysql)
```

**Description**

Create a `MYSQL_STMT` handle. The handle should be freed with `mysql_stmt_close(MYSQL_STMT *)`.

**Return values**

A pointer to a `MYSQL_STMT` structure in case of success. `NULL` if out of memory.

**Errors**

- `CR_OUT_OF_MEMORY`  
Out of memory.

**20.10.7.16. `mysql_stmt_insert_id()`**

```
my_ulonglong mysql_stmt_insert_id(MYSQL_STMT *stmt)
```

**Description**

Returns the value generated for an `AUTO_INCREMENT` column by the prepared `INSERT` or `UPDATE` statement. Use this function after you have executed a prepared `INSERT` statement on a table which contains an `AUTO_INCREMENT` field.

See [Section 20.10.3.37](#), “`mysql_insert_id()`”, for more information.

**Return Values**

Value for `AUTO_INCREMENT` column which was automatically generated or explicitly set during execution of prepared statement, or value generated by `LAST_INSERT_ID(expr)` function. Return value is undefined if statement does not set `AUTO_INCREMENT` value.

**Errors**

None.

**20.10.7.17. `mysql_stmt_num_rows()`**

```
my_ulonglong mysql_stmt_num_rows(MYSQL_STMT *stmt)
```

**Description**

Returns the number of rows in the result set.

The use of `mysql_stmt_num_rows()` depends on whether you used `mysql_stmt_store_result()` to buffer the entire result set in the statement handle.

If you use `mysql_stmt_store_result()`, `mysql_stmt_num_rows()` may be called immediately. Otherwise, the row count is unavailable unless you count the rows as you fetch them.

`mysql_stmt_num_rows()` is intended for use with statements that return a result set, such as `SELECT`. For statements such as `INSERT`, `UPDATE`, or `DELETE`, the number of affected rows can be obtained with `mysql_stmt_affected_rows()`.

**Return Values**

The number of rows in the result set.

**Errors**

None.

**20.10.7.18. `mysql_stmt_param_count()`**

```
unsigned long mysql_stmt_param_count(MYSQL_STMT *stmt)
```

**Description**

Returns the number of parameter markers present in the prepared statement.

**Return Values**

An unsigned long integer representing the number of parameters in a statement.

**Errors**

None.

**Example**

For the usage of `mysql_stmt_param_count()`, refer to the Example from [Section 20.10.7.10](#), “`mysql_stmt_execute()`”.

**20.10.7.19. `mysql_stmt_param_metadata()`**

```
MYSQL_RES *mysql_stmt_param_metadata(MYSQL_STMT *stmt)
```

This function currently does nothing.

**Description**

**Return Values****Errors****20.10.7.20. `mysql_stmt_prepare()`**

```
int mysql_stmt_prepare(MYSQL_STMT *stmt, const char *stmt_str, unsigned long length)
```

**Description**

Given the statement handle returned by `mysql_stmt_init()`, prepares the SQL statement pointed to by the string `stmt_str` and returns a status value. The string length should be given by the `length` argument. The string must consist of a single SQL statement. You should not add a terminating semicolon (“;”) or `\g` to the statement.

The application can include one or more parameter markers in the SQL statement by embedding question mark (“?”) characters into the SQL string at the appropriate positions.

The markers are legal only in certain places in SQL statements. For example, they are allowed in the `VALUES()` list of an `INSERT` statement (to specify column values for a row), or in a comparison with a column in a `WHERE` clause to specify a comparison value. However, they are not allowed for identifiers (such as table or column names), or to specify both operands of a binary operator such as the `=` equal sign. The latter restriction is necessary because it would be impossible to determine the parameter type. In general, parameters are legal only in Data Manipulation Language (DML) statements, and not in Data Definition Language (DDL) statements.

The parameter markers must be bound to application variables using `mysql_stmt_bind_param()` before executing the statement.

**Return Values**

Zero if the statement was prepared successfully. Nonzero if an error occurred.

**Errors**

- `CR_COMMANDS_OUT_OF_SYNC`  
Commands were executed in an improper order.
- `CR_OUT_OF_MEMORY`  
Out of memory.
- `CR_SERVER_GONE_ERROR`  
The MySQL server has gone away.
- `CR_SERVER_LOST`  
The connection to the server was lost during the query
- `CR_UNKNOWN_ERROR`  
An unknown error occurred.

If the prepare operation was unsuccessful (that is, `mysql_stmt_prepare()` returns nonzero), the error message can be obtained by calling `mysql_stmt_error()`.

**Example**

For the usage of `mysql_stmt_prepare()`, refer to the Example from [Section 20.10.7.10](#), “`mysql_stmt_execute()`”.

**20.10.7.21. `mysql_stmt_reset()`**

```
my_bool mysql_stmt_reset(MYSQL_STMT *stmt)
```

**Description**

Reset the prepared statement on the client and server to state after prepare. This is mainly used to reset data sent with `mysql_stmt_send_long_data()`. Any open cursor for the statement is closed.

To re-prepare the statement with another query, use `mysql_stmt_prepare()`.

**Return Values**

Zero if the statement was reset successfully. Nonzero if an error occurred.

**Errors**

- `CR_COMMANDS_OUT_OF_SYNC`  
Commands were executed in an improper order.
- `CR_SERVER_GONE_ERROR`  
The MySQL server has gone away.
- `CR_SERVER_LOST`  
The connection to the server was lost during the query
- `CR_UNKNOWN_ERROR`  
An unknown error occurred.

### 20.10.7.22. `mysql_stmt_result_metadata()`

```
MYSQL_RES *mysql_stmt_result_metadata(MYSQL_STMT *stmt)
```

**Description**

If a statement passed to `mysql_stmt_prepare()` is one that produces a result set, `mysql_stmt_result_metadata()` returns the result set metadata in the form of a pointer to a `MYSQL_RES` structure that can be used to process the meta information such as total number of fields and individual field information. This result set pointer can be passed as an argument to any of the field-based API functions that process result set metadata, such as:

- `mysql_num_fields()`
- `mysql_fetch_field()`
- `mysql_fetch_field_direct()`
- `mysql_fetch_fields()`
- `mysql_field_count()`
- `mysql_field_seek()`
- `mysql_field_tell()`
- `mysql_free_result()`

The result set structure should be freed when you are done with it, which you can do by passing it to `mysql_free_result()`. This is similar to the way you free a result set obtained from a call to `mysql_store_result()`.

The result set returned by `mysql_stmt_result_metadata()` contains only metadata. It does not contain any row results. The rows are obtained by using the statement handle with `mysql_stmt_fetch()`.

**Return Values**

A `MYSQL_RES` result structure. `NULL` if no meta information exists for the prepared query.

**Errors**

- `CR_OUT_OF_MEMORY`  
Out of memory.

- `CR_UNKNOWN_ERROR`

An unknown error occurred.

### Example

For the usage of `mysql_stmt_result_metadata()`, refer to the Example from [Section 20.10.7.11](#), “`mysql_stmt_fetch()`”.

### 20.10.7.23. `mysql_stmt_row_seek()`

```
MYSQL_ROW_OFFSET mysql_stmt_row_seek(MYSQL_STMT *stmt, MYSQL_ROW_OFFSET offset)
```

#### Description

Sets the row cursor to an arbitrary row in a statement result set. The `offset` value is a row offset that should be a value returned from `mysql_stmt_row_tell()` or from `mysql_stmt_row_seek()`. This value is not a row number; if you want to seek to a row within a result set by number, use `mysql_stmt_data_seek()` instead.

This function requires that the result set structure contains the entire result of the query, so `mysql_stmt_row_seek()` may be used only in conjunction with `mysql_stmt_store_result()`.

#### Return Values

The previous value of the row cursor. This value may be passed to a subsequent call to `mysql_stmt_row_seek()`.

#### Errors

None.

### 20.10.7.24. `mysql_stmt_row_tell()`

```
MYSQL_ROW_OFFSET mysql_stmt_row_tell(MYSQL_STMT *stmt)
```

#### Description

Returns the current position of the row cursor for the last `mysql_stmt_fetch()`. This value can be used as an argument to `mysql_stmt_row_seek()`.

You should use `mysql_stmt_row_tell()` only after `mysql_stmt_store_result()`.

#### Return Values

The current offset of the row cursor.

#### Errors

None.

### 20.10.7.25. `mysql_stmt_send_long_data()`

```
my_bool mysql_stmt_send_long_data(MYSQL_STMT *stmt, unsigned int parameter_number, const char *data, unsigned long length)
```

#### Description

Allows an application to send parameter data to the server in pieces (or “chunks”). Call this function after `mysql_stmt_bind_param()` and before `mysql_stmt_execute()`. It can be called multiple times to send the parts of a character or binary data value for a column, which must be one of the `TEXT` or `BLOB` data types.

`parameter_number` indicates which parameter to associate the data with. Parameters are numbered beginning with 0. `data` is a pointer to a buffer containing data to be sent, and `length` indicates the number of bytes in the buffer.

#### Note

The next `mysql_stmt_execute()` call ignores the bind buffer for all parameters that have been used with `mysql_stmt_send_long_data()` since last `mysql_stmt_execute()` or `mysql_stmt_reset()`.

If you want to reset/forget the sent data, you can do it with `mysql_stmt_reset()`. See [Section 20.10.7.21](#),



`mysql_stmt_reset()`.

### Return Values

Zero if the data is sent successfully to server. Nonzero if an error occurred.

### Errors

- `CR_INVALID_BUFFER_USE`  
The parameter does not have a string or binary type.
- `CR_COMMANDS_OUT_OF_SYNC`  
Commands were executed in an improper order.
- `CR_SERVER_GONE_ERROR`  
The MySQL server has gone away.
- `CR_OUT_OF_MEMORY`  
Out of memory.
- `CR_UNKNOWN_ERROR`  
An unknown error occurred.

### Example

The following example demonstrates how to send the data for a `TEXT` column in chunks. It inserts the data value `'MySQL - The most popular Open Source database'` into the `text_column` column. The `mysql` variable is assumed to be a valid connection handle.

```
#define INSERT_QUERY "INSERT INTO \
                    test_long_data(text_column) VALUES(?)"

MYSQL_BIND bind[1];
long          length;

stmt = mysql_stmt_init(mysql);
if (!stmt)
{
    fprintf(stderr, "mysql_stmt_init(), out of memory\n");
    exit(0);
}
if (mysql_stmt_prepare(stmt, INSERT_QUERY, strlen(INSERT_QUERY)))
{
    fprintf(stderr, "\n mysql_stmt_prepare(), INSERT failed");
    fprintf(stderr, "\n %s", mysql_stmt_error(stmt));
    exit(0);
}
memset(bind, 0, sizeof(bind));
bind[0].buffer_type= MYSQL_TYPE_STRING;
bind[0].length= &length;
bind[0].is_null= 0;

/* Bind the buffers */
if (mysql_stmt_bind_param(stmt, bind))
{
    fprintf(stderr, "\n param bind failed");
    fprintf(stderr, "\n %s", mysql_stmt_error(stmt));
    exit(0);
}

/* Supply data in chunks to server */
if (mysql_stmt_send_long_data(stmt,0,"MySQL",5))
{
    fprintf(stderr, "\n send_long_data failed");
    fprintf(stderr, "\n %s", mysql_stmt_error(stmt));
    exit(0);
}

/* Supply the next piece of data */
if (mysql_stmt_send_long_data(stmt,0,
    " - The most popular Open Source database",40))
{
    fprintf(stderr, "\n send_long_data failed");
    fprintf(stderr, "\n %s", mysql_stmt_error(stmt));
    exit(0);
}

/* Now, execute the query */
if (mysql_stmt_execute(stmt))
```

```
{
    fprintf(stderr, "\n mysql_stmt_execute failed");
    fprintf(stderr, "\n %s", mysql_stmt_error(stmt));
    exit(0);
}
```

### 20.10.7.26. `mysql_stmt_sqlstate()`

```
const char *mysql_stmt_sqlstate(MYSQL_STMT *stmt)
```

#### Description

For the statement specified by `stmt`, `mysql_stmt_sqlstate()` returns a null-terminated string containing the SQLSTATE error code for the most recently invoked prepared statement API function that can succeed or fail. The error code consists of five characters. "00000" means "no error." The values are specified by ANSI SQL and ODBC. For a list of possible values, see [Appendix B, Errors, Error Codes, and Common Problems](#).

Note that not all MySQL errors are yet mapped to SQLSTATE codes. The value "HY000" (general error) is used for unmapped errors.

#### Return Values

A null-terminated character string containing the SQLSTATE error code.

### 20.10.7.27. `mysql_stmt_store_result()`

```
int mysql_stmt_store_result(MYSQL_STMT *stmt)
```

#### Description

Result sets are produced by executing prepared statements for SQL statements such as `SELECT`, `SHOW`, `DESCRIBE`, and `EXPLAIN`. By default, result sets for successfully executed prepared statements are not buffered on the client and `mysql_stmt_fetch()` fetches them one at a time from the server. To cause the complete result set to be buffered on the client, call `mysql_stmt_store_result()` after binding data buffers with `mysql_stmt_bind_result()` and before calling `mysql_stmt_fetch()` to fetch rows. (For an example, see [Section 20.10.7.11, "mysql\\_stmt\\_fetch\(\)"](#).)

`mysql_stmt_store_result()` is optional for result set processing, unless you will call `mysql_stmt_data_seek()`, `mysql_stmt_row_seek()`, or `mysql_stmt_row_tell()`. Those functions require a seekable result set.

It is unnecessary to call `mysql_stmt_store_result()` after executing an SQL statement that does not produce a result set, but if you do, it does not harm or cause any notable performance problem. You can detect whether the statement produced a result set by checking if `mysql_stmt_result_metadata()` returns `NULL`. For more information, refer to [Section 20.10.7.22, "mysql\\_stmt\\_result\\_metadata\(\)"](#).

#### Note

MySQL doesn't by default calculate `MYSQL_FIELD->max_length` for all columns in `mysql_stmt_store_result()` because calculating this would slow down `mysql_stmt_store_result()` considerably and most applications doesn't need `max_length`. If you want `max_length` to be updated, you can call `mysql_stmt_attr_set(MYSQL_STMT, STMT_ATTR_UPDATE_MAX_LENGTH, &flag)` to enable this. See [Section 20.10.7.3, "mysql\\_stmt\\_attr\\_set\(\)"](#).

#### Return Values

Zero if the results are buffered successfully. Nonzero if an error occurred.

#### Errors

- `CR_COMMANDS_OUT_OF_SYNC`  
Commands were executed in an improper order.
- `CR_OUT_OF_MEMORY`  
Out of memory.
- `CR_SERVER_GONE_ERROR`  
The MySQL server has gone away.

- `CR_SERVER_LOST`

The connection to the server was lost during the query.

- `CR_UNKNOWN_ERROR`

An unknown error occurred.

## 20.10.8. C API Threaded Function Descriptions

You need to use the following functions when you want to create a threaded client. See [Section 20.10.17, “How to Make a Threaded Client”](#).

### 20.10.8.1. `my_init()`

```
void my_init(void)
```

#### Description

`my_init()` initializes some global variables that MySQL needs. If you are using a thread-safe client library, it also calls `mysql_thread_init()` for this thread.

It is necessary for `my_init()` to be called early in the initialization phase of a program's use of the MySQL library. However, `my_init()` is automatically called by `mysql_init()`, `mysql_library_init()`, `mysql_server_init()`, and `mysql_connect()`. If you ensure that your program invokes one of those functions before any other MySQL calls, there is no need to invoke `my_init()` explicitly.

To access the prototype for `my_init()`, your program should include these header files:

```
#include <my_global.h>
#include <my_sys.h>
```

#### Return Values

None.

### 20.10.8.2. `mysql_thread_end()`

```
void mysql_thread_end(void)
```

#### Description

This function needs to be called before calling `pthread_exit()` to free memory allocated by `mysql_thread_init()`.

`mysql_thread_end()` is not invoked automatically by the client library. It must be called explicitly to avoid a memory leak.

#### Return Values

None.

### 20.10.8.3. `mysql_thread_init()`

```
my_bool mysql_thread_init(void)
```

#### Description

This function must be called early within each created thread to initialize thread-specific variables. However, you may not necessarily need to invoke it explicitly: `mysql_thread_init()` is automatically called by `my_init()`, which itself is automatically called by `mysql_init()`, `mysql_library_init()`, `mysql_server_init()`, and `mysql_connect()`. If you invoke any of those functions, `mysql_thread_init()` will be called for you.

#### Return Values

Zero if successful. Nonzero if an error occurred.

### 20.10.8.4. `mysql_thread_safe()`

```
unsigned int mysql_thread_safe(void)
```

**Description**

This function indicates whether the client library is compiled as thread-safe.

**Return Values**

1 if the client library is thread-safe, 0 otherwise.

## 20.10.9. C API Embedded Server Function Descriptions

MySQL applications can be written to use an embedded server. See [Section 20.9, “libmysqld, the Embedded MySQL Server Library”](#). To write such an application, you must link it against the `libmysqld` library by using the `-lmysqld` flag rather than linking it against the `libmysqlclient` client library by using the `-libmysqlclient` flag. However, the calls to initialize and finalize the library are the same whether you write a client application or one that uses the embedded server: Call `mysql_library_init()` to initialize the library and `mysql_library_end()` when you are done with it. See [Section 20.10.2, “C API Function Overview”](#).

### 20.10.9.1. `mysql_server_init()`

```
int mysql_server_init(int argc, char **argv, char **groups)
```

**Description**

This function initializes the MySQL library, which must be done before you call any other MySQL function. However, `mysql_server_init()` is deprecated and you should call `mysql_library_init()` instead. See [Section 20.10.3.40, “mysql\\_library\\_init\(\)”](#).

**Return Values**

Zero if successful. Nonzero if an error occurred.

### 20.10.9.2. `mysql_server_end()`

```
void mysql_server_end(void)
```

**Description**

This function finalizes the MySQL library, which should be done when you are done using the library. However, `mysql_server_end()` is deprecated and `mysql_library_end()` should be used instead. See [Section 20.10.3.39, “mysql\\_library\\_end\(\)”](#).

**Return Values**

None.

## 20.10.10. Common Questions and Problems When Using the C API

### MySQL Enterprise

Subscribers to MySQL Enterprise will find articles about the C API in the MySQL Knowledge Base. Access to the Knowledge Base collection of articles is one of the advantages of subscribing to MySQL Enterprise. For more information, see <http://www.mysql.com/products/enterprise/advisors.html>.

### 20.10.10.1. Why `mysql_store_result()` Sometimes Returns `NULL` After `mysql_query()` Returns Success

It is possible for `mysql_store_result()` to return `NULL` following a successful call to `mysql_query()`. When this happens, it means one of the following conditions occurred:

- There was a `malloc()` failure (for example, if the result set was too large).
- The data couldn't be read (an error occurred on the connection).
- The query returned no data (for example, it was an `INSERT`, `UPDATE`, or `DELETE`).

You can always check whether the statement should have produced a non-empty result by calling `mysql_field_count()`. If `mysql_field_count()` returns zero, the result is empty and the last query was a statement that does not return values (for example, an `INSERT` or a `DELETE`). If `mysql_field_count()` returns a nonzero value, the statement should have produced a

non-empty result. See the description of the `mysql_field_count()` function for an example.

You can test for an error by calling `mysql_error()` or `mysql_errno()`.

### 20.10.10.2. What Results You Can Get from a Query

In addition to the result set returned by a query, you can also get the following information:

- `mysql_affected_rows()` returns the number of rows affected by the last query when doing an `INSERT`, `UPDATE`, or `DELETE`.  
For a fast re-create, use `TRUNCATE TABLE`.
- `mysql_num_rows()` returns the number of rows in a result set. With `mysql_store_result()`, `mysql_num_rows()` may be called as soon as `mysql_store_result()` returns. With `mysql_use_result()`, `mysql_num_rows()` may be called only after you have fetched all the rows with `mysql_fetch_row()`.
- `mysql_insert_id()` returns the ID generated by the last query that inserted a row into a table with an `AUTO_INCREMENT` index. See Section 20.10.3.37, “`mysql_insert_id()`”.
- Some queries (`LOAD DATA INFILE ...`, `INSERT INTO ... SELECT ...`, `UPDATE`) return additional information. The result is returned by `mysql_info()`. See the description for `mysql_info()` for the format of the string that it returns. `mysql_info()` returns a `NULL` pointer if there is no additional information.

### 20.10.10.3. How to Get the Unique ID for the Last Inserted Row

If you insert a record into a table that contains an `AUTO_INCREMENT` column, you can obtain the value stored into that column by calling the `mysql_insert_id()` function.

You can check from your C applications whether a value was stored in an `AUTO_INCREMENT` column by executing the following code (which assumes that you've checked that the statement succeeded). It determines whether the query was an `INSERT` with an `AUTO_INCREMENT` index:

```
if ((result = mysql_store_result(&mysql)) == 0 &&
    mysql_field_count(&mysql) == 0 &&
    mysql_insert_id(&mysql) != 0)
{
    used_id = mysql_insert_id(&mysql);
}
```

When a new `AUTO_INCREMENT` value has been generated, you can also obtain it by executing a `SELECT LAST_INSERT_ID()` statement with `mysql_query()` and retrieving the value from the result set returned by the statement.

When inserting multiple values, the last automatically incremented value is returned.

For `LAST_INSERT_ID()`, the most recently generated ID is maintained in the server on a per-connection basis. It is not changed by another client. It is not even changed if you update another `AUTO_INCREMENT` column with a non-magic value (that is, a value that is not `NULL` and not `0`). Using `LAST_INSERT_ID()` and `AUTO_INCREMENT` columns simultaneously from multiple clients is perfectly valid. Each client will receive the last inserted ID for the last statement *that* client executed.

If you want to use the ID that was generated for one table and insert it into a second table, you can use SQL statements like this:

```
INSERT INTO foo (auto,text)
VALUES(NULL,'text');           # generate ID by inserting NULL
INSERT INTO foo2 (id,text)
VALUES(LAST_INSERT_ID(),'text'); # use ID in second table
```

Note that `mysql_insert_id()` returns the value stored into an `AUTO_INCREMENT` column, whether that value is automatically generated by storing `NULL` or `0` or was specified as an explicit value. `LAST_INSERT_ID()` returns only automatically generated `AUTO_INCREMENT` values. If you store an explicit value other than `NULL` or `0`, it does not affect the value returned by `LAST_INSERT_ID()`.

For more information on obtaining the last ID in an `AUTO_INCREMENT` column:

- For information on `LAST_INSERT_ID()`, which can be used within an SQL statement, see Section 11.11.3, “Information Functions”.
- For information on `mysql_insert_id()`, the function you use from within the C API, see Section 20.10.3.37, “`mysql_insert_id()`”.

- For information on obtaining the auto-incremented value when using Connector/J, see [Section 20.4.5, “Connector/J Notes and Tips”](#).
- For information on obtaining the auto-incremented value when using Connector/ODBC, see [Section 20.1.7.1.1, “Obtaining Auto-Increment Values”](#).

#### 20.10.10.4. Problems Linking with the C API

When linking with the C API, the following errors may occur on some systems:

```
gcc -g -o client test.o -L/usr/local/lib/mysql \
    -lmysqlclient -lsocket -lnsl
Undefined      first referenced
symbol         in file
floor          /usr/local/lib/mysql/libmysqlclient.a(password.o)
ld: fatal: Symbol referencing errors. No output written to client
```

If this happens on your system, you must include the math library by adding `-lm` to the end of the compile/link line.

### 20.10.11. Controlling Automatic Reconnection Behavior

The MySQL client library can perform an automatic reconnection to the server if it finds that the connection is down when you attempt to send a statement to the server to be executed. In this case, the library tries once to reconnect to the server and send the statement again.

If it is important for your application to know that the connection has been dropped (so that it can exit or take action to adjust for the loss of state information), be sure to disable auto-reconnect. This can be done explicitly by calling `mysql_options()` with the `MYSQL_OPT_RECONNECT` option:

```
my_bool reconnect = 0;
mysql_options(&mysql, MYSQL_OPT_RECONNECT, &reconnect);
```

In MySQL 5.1, auto-reconnect is disabled by default.

If the connection has gone down, the `mysql_ping()` function performs a reconnect if auto-reconnect is enabled. If auto-reconnect is disabled, `mysql_ping()` returns an error instead.

Some client programs might provide the capability of controlling automatic reconnection. For example, `mysql` reconnects by default, but the `--skip-reconnect` option can be used to suppress this behavior.

If an automatic reconnection does occur (for example, as a result of calling `mysql_ping()`), there is no explicit indication of it. To check for reconnection, call `mysql_thread_id()` to get the original connection identifier before calling `mysql_ping()`, and then call `mysql_thread_id()` again to see whether the identifier has changed.

Automatic reconnection can be convenient because you need not implement your own reconnect code, but if a reconnection does occur, several aspects of the connection state are reset and your application will not know about it. The connection-related state is affected as follows:

- Any active transactions are rolled back and autocommit mode is reset.
- All table locks are released.
- All `TEMPORARY` tables are closed (and dropped).
- Session variables are reinitialized to the values of the corresponding variables. This also affects variables that are set implicitly by statements such as `SET NAMES`.
- User variable settings are lost.
- Prepared statements are released.
- `HANDLER` variables are closed.
- The value of `LAST_INSERT_ID()` is reset to 0.
- Locks acquired with `GET_LOCK()` are released.

If the connection drops, it is possible that the session associated with the connection on the server side will still be running if the

server has not yet detected that the client is no longer connected. In this case, any locks held by the original connection still belong to that session, so you may want to kill it by calling `mysql_kill()`.

## 20.10.12. C API Support for Multiple Statement Execution

By default, `mysql_query()` and `mysql_real_query()` interpret their statement string argument as a single statement to be executed, and you process the result according to whether the statement produces a result set (a set of rows, as for `SELECT`) or an affected-rows count (as for `INSERT`, `UPDATE`, and so forth).

MySQL 5.1 also supports the execution of a string containing multiple statements separated by semicolon (“;”) characters. This capability is enabled by special options that are specified either when you connect to the server with `mysql_real_connect()` or after connecting by calling `mysql_set_server_option()`.

Executing a multiple-statement string can produce multiple result sets or row-count indicators. Processing these results involves a different approach than for the single-statement case: After handling the result from the first statement, it is necessary to check whether more results exist and process them in turn if so. To support multiple-result processing, the C API includes the `mysql_more_results()` and `mysql_next_result()` functions. These functions are used at the end of a loop that iterates as long as more results are available. *Failure to process the result this way may result in a dropped connection to the server.*

Multiple-result processing also is required if you execute `CALL` statements for stored procedures. Results from a stored procedure have these characteristics:

- Statements within the procedure may produce result sets (for example, if it executes `SELECT` statements). These result sets are returned in the order that they are produced as the procedure executes.

In general, the caller cannot know how many result sets a procedure will return. Procedure execution may depend on loops or conditional statements that cause the execution path to differ from one call to the next. Therefore, you must be prepared to retrieve multiple results.

- The final result from the procedure is a status result that includes no result set. The status indicates whether the procedure succeeded or an error occurred.

The multiple statement and result capabilities can be used only with `mysql_query()` or `mysql_real_query()`. They cannot be used with the prepared statement interface. Prepared statement handles are defined to work only with strings that contain a single statement. See [Section 20.10.4, “C API Prepared Statements”](#).

To enable multiple-statement execution and result processing, the following options may be used:

- The `mysql_real_connect()` function has a `flags` argument for which two option values are relevant:
  - `CLIENT_MULTI_RESULTS` enables the client program to process multiple results. This option *must* be enabled if you execute `CALL` statements for stored procedures that produce result sets. Otherwise, such procedures result in an error `Error 1312 (0A000): PROCEDURE proc_name can't return a result set in the given context`.
  - `CLIENT_MULTI_STATEMENTS` enables `mysql_query()` and `mysql_real_query()` to execute statement strings containing multiple statements separated by semicolons. This option also enables `CLIENT_MULTI_RESULTS` implicitly, so a `flags` argument of `CLIENT_MULTI_STATEMENTS` to `mysql_real_connect()` is equivalent to an argument of `CLIENT_MULTI_STATEMENTS | CLIENT_MULTI_RESULTS`. That is, `CLIENT_MULTI_STATEMENTS` is sufficient to enable multiple-statement execution and all multiple-result processing.
- After the connection to the server has been established, you can use the `mysql_set_server_option()` function to enable or disable multiple-statement execution by passing it an argument of `MYSQL_OPTION_MULTI_STATEMENTS_ON` or `MYSQL_OPTION_MULTI_STATEMENTS_OFF`. Enabling multiple-statement execution with this function also enables processing of “simple” results for a multiple-statement string where each statement produces a single result, but is *not* sufficient to allow processing of stored procedures that produce result sets.

The following procedure outlines a suggested strategy for handling multiple statements:

1. Pass `CLIENT_MULTI_STATEMENTS` to `mysql_real_connect()`, to fully enable multiple-statement execution and multiple-result processing.
2. After calling `mysql_query()` or `mysql_real_query()` and verifying that it succeeds, enter a loop within which you process statement results.
3. For each iteration of the loop, handle the current statement result, retrieving either a result set or an affected-rows count. If an

error occurs, exit the loop.

4. At the end of the loop, call `mysql_next_result()` to check whether another result exists and initiate retrieval for it if so. If no more results are available, exit the loop.

One possible implementation of the preceding strategy is shown following. The final part of the loop can be reduced to a simple test of whether `mysql_next_result()` returns nonzero. The code as written distinguishes between no more results and an error, which allows a message to be printed for the latter occurrence.

```

/* connect to server with the CLIENT_MULTI_STATEMENTS option */
if (mysql_real_connect (mysql, host_name, user_name, password,
    db_name, port_num, socket_name, CLIENT_MULTI_STATEMENTS) == NULL)
{
    printf("mysql_real_connect() failed\n");
    mysql_close(mysql);
    exit(1);
}

/* execute multiple statements */
status = mysql_query(mysql,
    "DROP TABLE IF EXISTS test_table;\
    CREATE TABLE test_table(id INT);\
    INSERT INTO test_table VALUES(10);\
    UPDATE test_table SET id=20 WHERE id=10;\
    SELECT * FROM test_table;\
    DROP TABLE test_table");

if (status)
{
    printf("Could not execute statement(s)");
    mysql_close(mysql);
    exit(0);
}

/* process each statement result */
do {
    /* did current statement return data? */
    result = mysql_store_result(mysql);
    if (result)
    {
        /* yes; process rows and free the result set */
        process_result_set(mysql, result);
        mysql_free_result(result);
    }
    else /* no result set or error */
    {
        if (mysql_field_count(mysql) == 0)
        {
            printf("%lld rows affected\n",
                mysql_affected_rows(mysql));
        }
        else /* some error occurred */
        {
            printf("Could not retrieve result set\n");
            break;
        }
    }
} while ((status = mysql_next_result(mysql)) > 0);
printf("Could not execute statement\n");
mysql_close(mysql);

```

## 20.10.13. C API Prepared Statement Problems

Here follows a list of the currently known problems with prepared statements:

- `TIME`, `TIMESTAMP`, and `DATETIME` do not support parts of seconds (for example, from `DATE_FORMAT()`).
- When converting an integer to string, `ZEROFILL` is honored with prepared statements in some cases where the MySQL server doesn't print the leading zeros. (For example, with `MIN(number-with-zerofill)`).
- When converting a floating-point number to a string in the client, the rightmost digits of the converted value may differ slightly from those of the original value.
- Before MySQL 5.1.17, prepared statements do not use the query cache. As of 5.1.17, prepared statements use the query cache under the conditions described in [Section 7.5.5.1, "How the Query Cache Operates"](#).
- Prepared statements do not support multi-statements (that is, multiple statements within a single string separated by ";" characters).
- In MySQL 5.1, prepared `CALL` statements cannot invoke stored procedures that return result sets because prepared statements



do not support multiple result sets. Nor can the calling application access a stored procedure's `OUT` or `INOUT` parameters when the procedure returns. These capabilities are supported beginning with MySQL 6.0.

## 20.10.14. C API Prepared Statement Handling of Date and Time Values

The binary (prepared statement) protocol allows you to send and receive date and time values (`DATE`, `TIME`, `DATETIME`, and `TIMESTAMP`), using the `MYSQL_TIME` structure. The members of this structure are described in [Section 20.10.5, “C API Prepared Statement Data types”](#).

To send temporal data values, create a prepared statement using `mysql_stmt_prepare()`. Then, before calling `mysql_stmt_execute()` to execute the statement, use the following procedure to set up each temporal parameter:

1. In the `MYSQL_BIND` structure associated with the data value, set the `buffer_type` member to the type that indicates what kind of temporal value you're sending. For `DATE`, `TIME`, `DATETIME`, or `TIMESTAMP` values, set `buffer_type` to `MYSQL_TYPE_DATE`, `MYSQL_TYPE_TIME`, `MYSQL_TYPE_DATETIME`, or `MYSQL_TYPE_TIMESTAMP`, respectively.
2. Set the `buffer` member of the `MYSQL_BIND` structure to the address of the `MYSQL_TIME` structure in which you pass the temporal value.
3. Fill in the members of the `MYSQL_TIME` structure that are appropriate for the type of temporal value to be passed.

Use `mysql_stmt_bind_param()` to bind the parameter data to the statement. Then you can call `mysql_stmt_execute()`.

To retrieve temporal values, the procedure is similar, except that you set the `buffer_type` member to the type of value you expect to receive, and the `buffer` member to the address of a `MYSQL_TIME` structure into which the returned value should be placed. Use `mysql_stmt_bind_result()` to bind the buffers to the statement after calling `mysql_stmt_execute()` and before fetching the results.

Here is a simple example that inserts `DATE`, `TIME`, and `TIMESTAMP` data. The `mysql` variable is assumed to be a valid connection handle.

```

MYSQL_TIME  ts;
MYSQL_BIND  bind[3];
MYSQL_STMT  *stmt;

strmov(query, "INSERT INTO test_table(date_field, time_field, \
            timestamp_field) VALUES(?,?,?);");

stmt = mysql_stmt_init(mysql);
if (!stmt)
{
    fprintf(stderr, " mysql_stmt_init(), out of memory\n");
    exit(0);
}
if (mysql_stmt_prepare(mysql, query, strlen(query)))
{
    fprintf(stderr, "\n mysql_stmt_prepare(), INSERT failed");
    fprintf(stderr, "\n %s", mysql_stmt_error(stmt));
    exit(0);
}

/* set up input buffers for all 3 parameters */
bind[0].buffer_type= MYSQL_TYPE_DATE;
bind[0].buffer= (char *)&ts;
bind[0].is_null= 0;
bind[0].length= 0;
...
bind[1]= bind[2]= bind[0];
...

mysql_stmt_bind_param(stmt, bind);

/* supply the data to be sent in the ts structure */
ts.year= 2002;
ts.month= 02;
ts.day= 03;

ts.hour= 10;
ts.minute= 45;
ts.second= 20;

mysql_stmt_execute(stmt);
..

```

## 20.10.15. C API Support for Prepared `CALL` Statements

In MySQL 5.1, prepared `CALL` statements can be used only for stored procedures that produce at most one result set. Nor can the calling application use placeholders for `OUT` or `INOUT` parameters.

MySQL 6.0 expands prepared `CALL` statement support for stored procedures that produce multiple result sets and to provide placeholder access to `OUT` and `INOUT` parameters.

## 20.10.16. Building Client Programs

If you compile MySQL clients that you've written yourself or that you obtain from a third-party, they must be linked using the `-lmysqlclient -lz` options in the link command. You may also need to specify a `-L` option to tell the linker where to find the library. For example, if the library is installed in `/usr/local/mysql/lib`, use `-L/usr/local/mysql/lib -lmysqlclient -lz` in the link command.

For clients that use MySQL header files, you may need to specify an `-I` option when you compile them (for example, `-I/usr/local/mysql/include`), so that the compiler can find the header files.

To make it simpler to compile MySQL programs on Unix, we have provided the `mysql_config` script for you. See [Section 4.7.2, “mysql\\_config — Get Compile Options for Compiling Clients”](#).

You can use it to compile a MySQL client as follows:

```
CFG=/usr/local/mysql/bin/mysql_config
sh -c "gcc -o progname ` $CFG --cflags ` progname.c ` $CFG --libs `"
```

The `sh -c` is needed to get the shell not to treat the output from `mysql_config` as one word.

### MySQL Enterprise

Subscribers to MySQL Enterprise will find an example client program in the Knowledge Base article, [Sample C program using the embedded MySQL server library](#). Access to the MySQL Knowledge Base collection of articles is one of the advantages of subscribing to MySQL Enterprise. For more information, see <http://www.mysql.com/products/enterprise/advisors.html>.

## 20.10.17. How to Make a Threaded Client

The client library is almost thread-safe. The biggest problem is that the subroutines in `net.c` that read from sockets are not interrupt safe. This was done with the thought that you might want to have your own alarm that can break a long read to a server. If you install interrupt handlers for the `SIGPIPE` interrupt, the socket handling should be thread-safe.

To avoid aborting the program when a connection terminates, MySQL blocks `SIGPIPE` on the first call to `mysql_library_init()`, `mysql_init()`, or `mysql_connect()`. If you want to use your own `SIGPIPE` handler, you should first call `mysql_library_init()` and then install your handler.

Before MySQL 4.0, binary client libraries that we provided other than those for Windows were not normally compiled with the thread-safe option. Current binary distributions should have both a normal and a thread-safe client library.

To create a threaded client where you can interrupt the client from other threads and set timeouts when talking with the MySQL server, you should use the `net_serv.o` code that the server uses and the `-lmysys`, `-lmystrings`, and `-ldbbug` libraries.

If you don't need interrupts or timeouts, you can just compile a thread-safe client library (`mysqlclient_r`) and use it. In this case, you don't have to worry about the `net_serv.o` object file or the other MySQL libraries.

When using a threaded client and you want to use timeouts and interrupts, you can make great use of the routines in the `thr_alarm.c` file. If you are using routines from the `mysys` library, the only thing you must remember is to call `my_init()` first! See [Section 20.10.8, “C API Threaded Function Descriptions”](#).

In all cases, be sure to initialize the client library by calling `mysql_library_init()` before calling any other MySQL functions. When you are done with the library, call `mysql_library_end()`.

`mysql_real_connect()` is not thread-safe by default. The following notes describe how to compile a thread-safe client library and use it in a thread-safe manner. (The notes below for `mysql_real_connect()` also apply to the older `mysql_connect()` routine as well, although `mysql_connect()` is deprecated and should no longer be used.)

To make `mysql_real_connect()` thread-safe, you must configure your MySQL distribution with this command:

```
shell> ./configure --enable-thread-safe-client
```

Then recompile the distribution to create a thread-safe client library, `libmysqlclient_r`. (Assuming that your operating system has a thread-safe `gethostbyname_r()` function.) This library is thread-safe per connection. You can let two threads share the same connection with the following caveats:

- Two threads can't send a query to the MySQL server at the same time on the same connection. In particular, you have to ensure that between calls to `mysql_query()` and `mysql_store_result()` no other thread is using the same connection.
- Many threads can access different result sets that are retrieved with `mysql_store_result()`.
- If you use `mysql_use_result()`, you must ensure that no other thread is using the same connection until the result set is closed. However, it really is best for threaded clients that share the same connection to use `mysql_store_result()`.
- If you want to use multiple threads on the same connection, you must have a mutex lock around your pair of `mysql_query()` and `mysql_store_result()` calls. Once `mysql_store_result()` is ready, the lock can be released and other threads may query the same connection.
- If you use POSIX threads, you can use `pthread_mutex_lock()` and `pthread_mutex_unlock()` to establish and release a mutex lock.

You need to know the following if you have a thread that is calling MySQL functions which did not create the connection to the MySQL database:

When you call `mysql_init()`, MySQL creates a thread-specific variable for the thread that is used by the debug library (among other things). If you call a MySQL function before the thread has called `mysql_init()`, the thread does not have the necessary thread-specific variables in place and you are likely to end up with a core dump sooner or later. To get things to work smoothly you must do the following:

1. Call `mysql_library_init()` before any other MySQL functions. It is not thread-safe, so call it before threads are created, or protect the call with a mutex.
2. Arrange for `mysql_thread_init()` to be called early in the thread handler before calling any MySQL function. If you call `mysql_init()`, they will call `mysql_thread_init()` for you.
3. In the thread, call `mysql_thread_end()` before calling `pthread_exit()`. This frees the memory used by MySQL thread-specific variables.

The preceding notes regarding `mysql_init()` also apply to `mysql_connect()`, which calls `mysql_init()`.

If “undefined symbol” errors occur when linking your client with `libmysqlclient_r`, in most cases this is because you haven't included the thread libraries on the link/compile command.

## 20.11. MySQL PHP API

PHP is a server-side, HTML-embedded scripting language that may be used to create dynamic Web pages. It is available for most operating systems and Web servers, and can access most common databases, including MySQL. PHP may be run as a separate program or compiled as a module for use with the Apache Web server.

PHP actually provides two different MySQL API extensions:

- `mysql`: Available for PHP versions 4 and 5, this extension is intended for use with MySQL versions prior to MySQL 4.1. This extension does not support the improved authentication protocol used in MySQL 4.1, nor does it support prepared statements or multiple statements. If you wish to use this extension with MySQL 4.1, you will likely want to configure the MySQL server to use the `--old-passwords` option (see [Section B.1.2.4, “Client does not support authentication protocol”](#)). This extension is documented on the PHP Web site at <http://php.net/mysql>.
- [Section 20.11.2, “MySQL Improved Extension \(Mysqli\)”](#) - Stands for “MySQL, Improved”; this extension is available only in PHP 5. It is intended for use with MySQL 4.1.1 and later. This extension fully supports the authentication protocol used in MySQL 5.0, as well as the Prepared Statements and Multiple Statements APIs. In addition, this extension provides an advanced, object-oriented programming interface. You can read the documentation for the `mysqli` extension at <http://php.net/mysqli>. Helpful article can be found at <http://devzone.zend.com/node/view/id/686> and <http://devzone.zend.com/node/view/id/687>.

If you're experiencing problems with enabling both the `mysql` and the `mysqli` extension when building PHP on Linux yourself, see [Section 20.11.6, “Enabling Both `mysql` and `mysqli` in PHP”](#).

The PHP distribution and documentation are available from the [PHP Web site](#).

### MySQL Enterprise

MySQL Enterprise subscribers will find more information about MySQL and PHP in the Knowledge Base

articles found at [PHP](http://www.mysql.com/products/enterprise/knowledgebase.html). Access to the MySQL Knowledge Base collection of articles is one of the advantages of subscribing to MySQL Enterprise. For more information, see <http://www.mysql.com/products/enterprise/knowledgebase.html>.

*Portions of this section are Copyright (c) 1997-2008 the PHP Documentation Group* This material may be distributed only subject to the terms and conditions set forth in the Creative Commons Attribution 3.0 License or later. A copy of the Creative Commons Attribution 3.0 license is distributed with this manual. The latest version is presently available at <http://www.creativecommons.org/licenses/by/3.0/>. This material may be distributed only subject to the terms and conditions set forth in the Open Publication License, v1.0.8 or later (the latest version is presently available at <http://www.opencontent.org/openpub/>).

## 20.11.1. MySQL

Copyright 1997-2008 the PHP Documentation Group.

These functions allow you to access MySQL database servers. More information about MySQL can be found at <http://www.mysql.com/>.

Documentation for MySQL can be found at <http://dev.mysql.com/doc/>.

### 20.11.1.1. Installing/Configuring

Copyright 1997-2008 the PHP Documentation Group.

#### 20.11.1.1.1. Requirements

Copyright 1997-2008 the PHP Documentation Group.

In order to have these functions available, you must compile PHP with MySQL support.

#### 20.11.1.1.2. Installation

Copyright 1997-2008 the PHP Documentation Group.

For compiling, simply use the `--with-mysql[=DIR]` configuration option where the optional `[DIR]` points to the MySQL installation directory.

Although this MySQL extension is compatible with MySQL 4.1.0 and greater, it doesn't support the extra functionality that these versions provide. For that, use the [MySQLi](#) extension.

If you would like to install the `mysql` extension along with the `mysqli` extension you have to use the same client library to avoid any conflicts.

#### 20.11.1.1.2.1. Installation on Linux Systems

Copyright 1997-2008 the PHP Documentation Group.

##### 20.11.1.1.2.1.1. PHP 4

Copyright 1997-2008 the PHP Documentation Group.

The option `--with-mysql` is enabled by default. This default behavior may be disabled with the `--without-mysql` configure option. If MySQL is enabled without specifying the path to the MySQL install DIR, PHP will use the bundled MySQL client libraries.

Users who run other applications that use MySQL (for example, `auth-mysql`) should not use the bundled library, but rather specify the path to MySQL's install directory, like so: `--with-mysql=/path/to/mysql`. This will force PHP to use the client libraries installed by MySQL, thus avoiding any conflicts.

##### 20.11.1.1.2.1.2. PHP 5+

Copyright 1997-2008 the PHP Documentation Group.

MySQL is not enabled by default, nor is the MySQL library bundled with PHP. Read this [FAQ](#) for details on why. Use the `--with-mysql[=DIR]` configure option to include MySQL support. You can download *headers and libraries* from [MySQL](#).

#### 20.11.1.1.2.2. Installation on Windows Systems

Copyright 1997-2008 the PHP Documentation Group.

##### 20.11.1.1.2.2.1. PHP 4

Copyright 1997-2008 the PHP Documentation Group.

The PHP MySQL extension is compiled into PHP.

#### 20.11.1.1.2.2.2. PHP 5+

Copyright 1997-2008 the PHP Documentation Group.

MySQL is no longer enabled by default, so the `php_mysql.dll` DLL must be enabled inside of `php.ini`. Also, PHP needs access to the MySQL client library. A file named `libmysql.dll` is included in the Windows PHP distribution and in order for PHP to talk to MySQL this file needs to be available to the Windows systems `PATH`. See the FAQ titled "[How do I add my PHP directory to the PATH on Windows](#)" for information on how to do this. Although copying `libmysql.dll` to the Windows system directory also works (because the system directory is by default in the system's `PATH`), it's not recommended.

As with enabling any PHP extension (such as `php_mysql.dll`), the PHP directive `extension_dir` should be set to the directory where the PHP extensions are located. See also the [Manual Windows Installation Instructions](#). An example `extension_dir` value for PHP 5 is `c:\php\ext`

#### Note

If when starting the web server an error similar to the following occurs: "Unable to load dynamic library '.\php\_mysql.dll'", this is because `php_mysql.dll` and/or `libmysql.dll` cannot be found by the system.

#### 20.11.1.1.2.3. MySQL Installation Notes

Copyright 1997-2008 the PHP Documentation Group.

#### Warning

Crashes and startup problems of PHP may be encountered when loading this extension in conjunction with the `recode` extension. See the [recode](#) extension for more information.

#### Note

If you need charsets other than *latin* (default), you have to install external (not bundled) `libmysql` with compiled charset support.

#### 20.11.1.1.3. Runtime Configuration

Copyright 1997-2008 the PHP Documentation Group.

The behaviour of these functions is affected by settings in `php.ini`.

**Table 20.4. MySQL Configuration Options**

Name	Default	Changeable	Changelog
<code>mysql.allow_persistent</code>	"1"	PHP_INI_SYSTEM	
<code>mysql.max_persistent</code>	"-1"	PHP_INI_SYSTEM	
<code>mysql.max_links</code>	"-1"	PHP_INI_SYSTEM	
<code>mysql.trace_mode</code>	"0"	PHP_INI_ALL	Available since PHP 4.3.0.
<code>mysql.default_port</code>	NULL	PHP_INI_ALL	
<code>mysql.default_socket</code>	NULL	PHP_INI_ALL	Available since PHP 4.0.1.
<code>mysql.default_host</code>	NULL	PHP_INI_ALL	
<code>mysql.default_user</code>	NULL	PHP_INI_ALL	
<code>mysql.default_password</code>	NULL	PHP_INI_ALL	
<code>mysql.connect_timeout</code>	"60"	PHP_INI_ALL	PHP_INI_SYSTEM in PHP <= 4.3.2. Available since PHP 4.3.0.

For further details and definitions of the `PHP_INI_*` constants, see the [ini](#).

Here's a short explanation of the configuration directives.

<code>mysql.allow_persistent</code>	Whether to allow <a href="#">persistent connections</a> to MySQL.
boolean	
<code>mysql.max_persistent</code>	The maximum number of persistent MySQL connections per process.
integer	
<code>mysql.max_links</code>	The maximum number of MySQL connections per process, including persistent connections.
integer	
<code>mysql.trace_mode</code>	Trace mode. When <code>mysql.trace_mode</code> is enabled, warnings for table/index scans, non free result sets, and SQL-Errors will be displayed. (Introduced in PHP 4.3.0)
boolean	
<code>mysql.default_port</code>	The default TCP port number to use when connecting to the database server if no other port is specified. If no default is specified, the port will be obtained from the <code>MYSQL_TCP_PORT</code> environment variable, the <code>mysql-tcp</code> entry in <code>/etc/services</code> or the compile-time <code>MYSQL_PORT</code> constant, in that order. Win32 will only use the <code>MYSQL_PORT</code> constant.
string	
<code>mysql.default_socket</code>	The default socket name to use when connecting to a local database server if no other socket name is specified.
string	
<code>mysql.default_host</code>	The default server host to use when connecting to the database server if no other host is specified. Doesn't apply in <a href="#">SQL safe mode</a> .
string	
<code>mysql.default_user</code>	The default user name to use when connecting to the database server if no other name is specified. Doesn't apply in <a href="#">SQL safe mode</a> .
string	
<code>mysql.default_password</code>	The default password to use when connecting to the database server if no other password is specified. Doesn't apply in <a href="#">SQL safe mode</a> .
string	
<code>mysql.connect_timeout</code>	Connect timeout in seconds. On Linux this timeout is also used for waiting for the first answer from the server.
integer	

#### 20.11.1.1.4. Resource Types

Copyright 1997-2008 the PHP Documentation Group.

There are two resource types used in the MySQL module. The first one is the link identifier for a database connection, the second a resource which holds the result of a query.

#### 20.11.1.2. Predefined Constants

Copyright 1997-2008 the PHP Documentation Group.

The constants below are defined by this extension, and will only be available when the extension has either been compiled into PHP or dynamically loaded at runtime.

Since PHP 4.3.0 it is possible to specify additional client flags for the `mysql_connect` and `mysql_pconnect` functions. The following constants are defined:

**Table 20.5. MySQL client constants**

Constant	Description
<code>MYSQL_CLIENT_COMPRESS</code>	Use compression protocol
<code>MYSQL_CLIENT_IGNORE_SPACE</code>	Allow space after function names
<code>MYSQL_CLIENT_INTERACTIVE</code>	Allow <code>interactive_timeout</code> seconds (instead of <code>wait_timeout</code> ) of inactivity before closing the connection.
<code>MYSQL_CLIENT_SSL</code>	Use SSL encryption. This flag is only available with version 4.x of the MySQL client library or newer. Version 3.23.x is bundled both with PHP 4 and Windows binaries of PHP 5.

The function `mysql_fetch_array` uses a constant for the different types of result arrays. The following constants are defined:

**Table 20.6. MySQL fetch constants**

Constant	Description
<code>MYSQL_ASSOC</code>	Columns are returned into the array having the fieldname as the

Constant	Description
	array index.
MYSQL_BOTH	Columns are returned into the array having both a numerical index and the fieldname as the array index.
MYSQL_NUM	Columns are returned into the array having a numerical index to the fields. This index starts with 0, the first field in the result.

### 20.11.1.3. Examples

Copyright 1997-2008 the PHP Documentation Group.

#### 20.11.1.3.1. Basic

This simple example shows how to connect, execute a query, print resulting rows and disconnect from a MySQL database.

#### Example 20.13. MySQL extension overview example

Copyright 1997-2008 the PHP Documentation Group.

```
<?php
// Connecting, selecting database
$link = mysql_connect('mysql_host', 'mysql_user', 'mysql_password')
    or die('Could not connect: ' . mysql_error());
echo 'Connected successfully';
mysql_select_db('my_database') or die('Could not select database');

// Performing SQL query
$query = 'SELECT * FROM my_table';
$result = mysql_query($query) or die('Query failed: ' . mysql_error());

// Printing results in HTML
echo "<table>\n";
while ($line = mysql_fetch_array($result, MYSQL_ASSOC)) {
    echo "\t<tr>\n";
    foreach ($line as $col_value) {
        echo "\t\t<td>$col_value</td>\n";
    }
    echo "\t</tr>\n";
}
echo "</table>\n";

// Free resultset
mysql_free_result($result);

// Closing connection
mysql_close($link);
?>
```

### 20.11.1.4. MySQL Functions

Copyright 1997-2008 the PHP Documentation Group.

#### Note

Most MySQL functions accept *link\_identifier* as the last optional parameter. If it is not provided, last opened connection is used. If it doesn't exist, connection is tried to establish with default parameters defined in `php.ini`. If it is not successful, functions return `FALSE`.

#### 20.11.1.4.1. `mysql_affected_rows`

Copyright 1997-2008 the PHP Documentation Group.

- `mysql_affected_rows`

Get number of affected rows in previous MySQL operation

#### Description

```
int mysql_affected_rows(resource link_identifier);
```

Get the number of affected rows by the last INSERT, UPDATE, REPLACE or DELETE query associated with *link\_identifier*.

### Parameters

*link\_identifier* The MySQL connection. If the link identifier is not specified, the last link opened by `mysql_connect` is assumed. If no such link is found, it will try to create one as if `mysql_connect` was called with no arguments. If by chance no connection is found or established, an `E_WARNING` level error is generated.

### Return Values

Returns the number of affected rows on success, and -1 if the last query failed.

If the last query was a DELETE query with no WHERE clause, all of the records will have been deleted from the table but this function will return zero with MySQL versions prior to 4.1.2.

When using UPDATE, MySQL will not update columns where the new value is the same as the old value. This creates the possibility that `mysql_affected_rows` may not actually equal the number of rows matched, only the number of rows that were literally affected by the query.

The REPLACE statement first deletes the record with the same primary key and then inserts the new record. This function returns the number of deleted records plus the number of inserted records.

### Examples

#### Example 20.14. `mysql_affected_rows` example

```
<?php
$link = mysql_connect('localhost', 'mysql_user', 'mysql_password');
if (!$link) {
    die('Could not connect: ' . mysql_error());
}
mysql_select_db('mydb');

/* this should return the correct numbers of deleted records */
mysql_query('DELETE FROM mytable WHERE id < 10');
printf("Records deleted: %d\n", mysql_affected_rows());

/* with a where clause that is never true, it should return 0 */
mysql_query('DELETE FROM mytable WHERE 0');
printf("Records deleted: %d\n", mysql_affected_rows());
?>
```

The above example will output something similar to:

```
Records deleted: 10
Records deleted: 0
```

#### Example 20.15. `mysql_affected_rows` example using transactions

```
<?php
$link = mysql_connect('localhost', 'mysql_user', 'mysql_password');
if (!$link) {
    die('Could not connect: ' . mysql_error());
}
mysql_select_db('mydb');

/* Update records */
mysql_query("UPDATE mytable SET used=1 WHERE id < 10");
printf("Updated records: %d\n", mysql_affected_rows());
```



```
mysql_query( "COMMIT" );
?>
```

The above example will output something similar to:

```
Updated Records: 10
```

## Notes

### Transactions

If you are using transactions, you need to call `mysql_affected_rows` after your INSERT, UPDATE, or DELETE query, not after the COMMIT.

### SELECT Statements

To retrieve the number of rows returned by a SELECT, it is possible to use `mysql_num_rows`.

## See Also

`mysql_num_rows`  
`mysql_info`

## 20.11.1.4.2. `mysql_change_user`

Copyright 1997-2008 the PHP Documentation Group.

- `mysql_change_user`

Change logged in user of the active connection

## Description

```
int mysql_change_user(string user,
                     string password,
                     string database,
                     resource link_identifier);
```

`mysql_change_user` changes the logged in user of the current active connection, or the connection given by the optional `link_identifier` parameter. If a database is specified, this will be the current database after the user has been changed. If the new user and password authorization fails, the current connected user stays active.

This function is deprecated and no longer exists in PHP.

## Parameters

<code>user</code>	The new MySQL username.
<code>password</code>	The new MySQL password.
<code>database</code>	The MySQL database. If not specified, the current selected database is used.
<code>link_identifier</code>	The MySQL connection. If the link identifier is not specified, the last link opened by <code>mysql_connect</code> is assumed. If no such link is found, it will try to create one as if <code>mysql_connect</code> was called with no arguments. If by chance no connection is found or established, an <code>E_WARNING</code> level error is generated.

## Return Values

Returns `TRUE` on success or `FALSE` on failure.

#### ChangeLog

Version	Description
3.0.14	This function was removed from PHP.

#### Notes

##### Requirements

This function requires MySQL 3.23.3 or higher.

#### See Also

`mysql_connect`  
`mysql_select_db`  
`mysql_query`

### 20.11.1.4.3. `mysql_client_encoding`

Copyright 1997-2008 the PHP Documentation Group.

- `mysql_client_encoding`

Returns the name of the character set

#### Description

```
string mysql_client_encoding(resource link_identifier);
```

Retrieves the `character_set` variable from MySQL.

#### Parameters

*link\_identifier*

The MySQL connection. If the link identifier is not specified, the last link opened by `mysql_connect` is assumed. If no such link is found, it will try to create one as if `mysql_connect` was called with no arguments. If by chance no connection is found or established, an `E_WARNING` level error is generated.

#### Return Values

Returns the default character set name for the current connection.

#### Examples

#### Example 20.16. `mysql_client_encoding` example

```
<?php
$link = mysql_connect('localhost', 'mysql_user', 'mysql_password');
$charset = mysql_client_encoding($link);
echo "The current character set is: $charset\n";
?>
```

The above example will output something similar to:

```
The current character set is: latin1
```

### See Also

[mysql\\_set\\_charset](#)  
[mysql\\_real\\_escape\\_string](#)

#### 20.11.1.4.4. `mysql_close`

Copyright 1997-2008 the PHP Documentation Group.

- [mysql\\_close](#)

Close MySQL connection

### Description

```
bool mysql_close(resource link_identifier);
```

`mysql_close` closes the non-persistent connection to the MySQL server that's associated with the specified link identifier. If `link_identifier` isn't specified, the last opened link is used.

Using `mysql_close` isn't usually necessary, as non-persistent open links are automatically closed at the end of the script's execution. See also [freeing resources](#).

### Parameters

*link\_identifier* The MySQL connection. If the link identifier is not specified, the last link opened by `mysql_connect` is assumed. If no such link is found, it will try to create one as if `mysql_connect` was called with no arguments. If by chance no connection is found or established, an `E_WARNING` level error is generated.

### Return Values

Returns `TRUE` on success or `FALSE` on failure.

### Examples

#### Example 20.17. `mysql_close` example

```
<?php
$link = mysql_connect('localhost', 'mysql_user', 'mysql_password');
if (!$link) {
    die('Could not connect: ' . mysql_error());
}
echo 'Connected successfully';
mysql_close($link);
?>
```

The above example will output:

```
Connected successfully
```

**Notes****Note**

`mysql_close` will not close persistent links created by `mysql_pconnect`.

**See Also**

`mysql_connect`  
`mysql_free_result`

**20.11.1.4.5. `mysql_connect`**

Copyright 1997-2008 the PHP Documentation Group.

- `mysql_connect`

Open a connection to a MySQL Server

**Description**

```
resource mysql_connect(string server,
                       string username,
                       string password,
                       bool new_link,
                       int client_flags);
```

Opens or reuses a connection to a MySQL server.

**Parameters**

<code>server</code>	The MySQL server. It can also include a port number. e.g. "hostname:port" or a path to a local socket e.g. ":/path/to/socket" for the localhost.  If the PHP directive <code>mysql.default_host</code> is undefined (default), then the default value is 'localhost:3306'. In <a href="#">SQL safe mode</a> , this parameter is ignored and value 'localhost:3306' is always used.
<code>username</code>	The username. Default value is defined by <code>mysql.default_user</code> . In <a href="#">SQL safe mode</a> , this parameter is ignored and the name of the user that owns the server process is used.
<code>password</code>	The password. Default value is defined by <code>mysql.default_password</code> . In <a href="#">SQL safe mode</a> , this parameter is ignored and empty password is used.
<code>new_link</code>	If a second call is made to <code>mysql_connect</code> with the same arguments, no new link will be established, but instead, the link identifier of the already opened link will be returned. The <code>new_link</code> parameter modifies this behavior and makes <code>mysql_connect</code> always open a new link, even if <code>mysql_connect</code> was called before with the same parameters. In <a href="#">SQL safe mode</a> , this parameter is ignored.
<code>client_flags</code>	The <code>client_flags</code> parameter can be a combination of the following constants: 128 (enable <code>LOAD DATA LOCAL</code> handling), <code>MYSQL_CLIENT_SSL</code> , <code>MYSQL_CLIENT_COMPRESS</code> , <code>MYSQL_CLIENT_IGNORE_SPACE</code> or <code>MYSQL_CLIENT_INTERACTIVE</code> . Read the section about <a href="#">Table 20.5, "MySQL client constants"</a> for further information. In <a href="#">SQL safe mode</a> , this parameter is ignored.

**Return Values**

Returns a MySQL link identifier on success, or `FALSE` on failure.

**ChangeLog**

Version	Description
4.3.0	Added the <code>client_flags</code> parameter.

Version	Description
4.2.0	Added the <i>new_link</i> parameter.
3.0.10	Added support for ":/path/to/socket" with <i>server</i> .
3.0.0	Added support for ".:port" with <i>server</i> .

## Examples

### Example 20.18. `mysql_connect` example

```
<?php
$link = mysql_connect('localhost', 'mysql_user', 'mysql_password');
if (!$link) {
    die('Could not connect: ' . mysql_error());
}
echo 'Connected successfully';
mysql_close($link);
?>
```

### Example 20.19. `mysql_connect` example using `hostname:port` syntax

```
<?php
// we connect to example.com and port 3307
$link = mysql_connect('example.com:3307', 'mysql_user', 'mysql_password');
if (!$link) {
    die('Could not connect: ' . mysql_error());
}
echo 'Connected successfully';
mysql_close($link);

// we connect to localhost at port 3307
$link = mysql_connect('127.0.0.1:3307', 'mysql_user', 'mysql_password');
if (!$link) {
    die('Could not connect: ' . mysql_error());
}
echo 'Connected successfully';
mysql_close($link);
?>
```

### Example 20.20. `mysql_connect` example using ":/path/to/socket" syntax

```
<?php
// we connect to localhost and socket e.g. /tmp/mysql.sock

//variant 1: omit localhost
$link = mysql_connect('/:tmp/mysql', 'mysql_user', 'mysql_password');
if (!$link) {
    die('Could not connect: ' . mysql_error());
}
echo 'Connected successfully';
mysql_close($link);

// variant 2: with localhost
$link = mysql_connect('localhost:/tmp/mysql.sock', 'mysql_user', 'mysql_password');
if (!$link) {
    die('Could not connect: ' . mysql_error());
}
echo 'Connected successfully';
mysql_close($link);
?>
```

## Notes

**Note**

Whenever you specify "localhost" or "localhost:port" as server, the MySQL client library will override this and try to connect to a local socket (named pipe on Windows). If you want to use TCP/IP, use "127.0.0.1" instead of "localhost". If the MySQL client library tries to connect to the wrong local socket, you should set the correct path as [ini.mysql.default-host](#) in your PHP configuration and leave the server field blank.

**Note**

The link to the server will be closed as soon as the execution of the script ends, unless it's closed earlier by explicitly calling `mysql_close`.

**Note**

You can suppress the error message on failure by prepending a `@` to the function name.

**Note**

Error "Can't create TCP/IP socket (10106)" usually means that the [variables\\_order](#) configure directive doesn't contain character `E`. On Windows, if the environment is not copied the `SYSTEMROOT` environment variable won't be available and PHP will have problems loading Winsock.

**See Also**

[mysql\\_pconnect](#)  
[mysql\\_close](#)

**20.11.1.4.6. [mysql\\_create\\_db](#)**

Copyright 1997-2008 the PHP Documentation Group.

- [mysql\\_create\\_db](#)

Create a MySQL database

**Description**

```
bool mysql_create_db(string database_name,
                    resource link_identifier);
```

[mysql\\_create\\_db](#) attempts to create a new database on the server associated with the specified link identifier.

**Parameters**

*database\_name*

The name of the database being created.

*link\_identifier*

The MySQL connection. If the link identifier is not specified, the last link opened by [mysql\\_connect](#) is assumed. If no such link is found, it will try to create one as if [mysql\\_connect](#) was called with no arguments. If by chance no connection is found or established, an `E_WARNING` level error is generated.

**Return Values**

Returns `TRUE` on success or `FALSE` on failure.

**Examples****Example 20.21. [mysql\\_create\\_db](#) alternative example**

The function [mysql\\_create\\_db](#) is deprecated. It is preferable to use [mysql\\_query](#) to issue a sql `CREATE DATABASE` statement instead.

```
<?php
$link = mysql_connect('localhost', 'mysql_user', 'mysql_password');
if (!$link) {
    die('Could not connect: ' . mysql_error());
}

$sql = 'CREATE DATABASE my_db';
if (mysql_query($sql, $link)) {
    echo "Database my_db created successfully\n";
} else {
    echo 'Error creating database: ' . mysql_error() . "\n";
}
?>
```

The above example will output something similar to:

```
Database my_db created successfully
```

## Notes

### Note

For backward compatibility, the following deprecated alias may be used: `mysql_createdb`

### Note

This function will not be available if the MySQL extension was built against a MySQL 4.x client library.

## See Also

`mysql_query`  
`mysql_select_db`

### 20.11.1.4.7. `mysql_data_seek`

Copyright 1997-2008 the PHP Documentation Group.

- `mysql_data_seek`

Move internal result pointer

## Description

```
bool mysql_data_seek(resource result,
                    int row_number);
```

`mysql_data_seek` moves the internal row pointer of the MySQL result associated with the specified result identifier to point to the specified row number. The next call to a MySQL fetch function, such as `mysql_fetch_assoc`, would return that row.

`row_number` starts at 0. The `row_number` should be a value in the range from 0 to `mysql_num_rows` - 1. However if the result set is empty (`mysql_num_rows == 0`), a seek to 0 will fail with a `E_WARNING` and `mysql_data_seek` will return `FALSE`.

## Parameters

`result` The result resource that is being evaluated. This result comes from a call to `mysql_query`.

`row_number` The desired row number of the new result pointer.

## Return Values

Returns **TRUE** on success or **FALSE** on failure.

### Examples

#### Example 20.22. `mysql_data_seek` example

```
<?php
$link = mysql_connect('localhost', 'mysql_user', 'mysql_password');
if (!$link) {
    die('Could not connect: ' . mysql_error());
}
$db_selected = mysql_select_db('sample_db');
if (!$db_selected) {
    die('Could not select database: ' . mysql_error());
}
$query = 'SELECT last_name, first_name FROM friends';
$result = mysql_query($query);
if (!$result) {
    die('Query failed: ' . mysql_error());
}
/* fetch rows in reverse order */
for ($i = mysql_num_rows($result) - 1; $i >= 0; $i--) {
    if (!mysql_data_seek($result, $i)) {
        echo "Cannot seek to row $i: " . mysql_error() . "\n";
        continue;
    }

    if (!$row = mysql_fetch_assoc($result)) {
        continue;
    }

    echo $row['last_name'] . ' ' . $row['first_name'] . "<br />\n";
}

mysql_free_result($result);
?>
```

### Notes

#### Note

The function `mysql_data_seek` can be used in conjunction only with `mysql_query`, not with `mysql_unbuffered_query`.

### See Also

`mysql_query`  
`mysql_num_rows`  
`mysql_fetch_row`  
`mysql_fetch_assoc`  
`mysql_fetch_array`  
`mysql_fetch_object`

#### 20.11.1.4.8. `mysql_db_name`

Copyright 1997-2008 the PHP Documentation Group.

- `mysql_db_name`

Get result data

### Description

```
string mysql_db_name(resource result,
                    int row,
                    mixed field);
```

Retrieve the database name from a call to `mysql_list_dbs`.

### Parameters



<i>result</i>	The result pointer from a call to <code>mysql_list_dbs</code> .
<i>row</i>	The index into the result set.
<i>field</i>	The field name.

**Return Values**

Returns the database name on success, and `FALSE` on failure. If `FALSE` is returned, use `mysql_error` to determine the nature of the error.

**Examples****Example 20.23. `mysql_db_name` example**

```
<?php
error_reporting(E_ALL);

$link = mysql_connect('dbhost', 'username', 'password');
$db_list = mysql_list_dbs($link);

$i = 0;
$cnt = mysql_num_rows($db_list);
while ($i < $cnt) {
    echo mysql_db_name($db_list, $i) . "\n";
    $i++;
}
?>
```

**Notes****Note**

For backward compatibility, the following deprecated alias may be used: `mysql_dbname`

**See Also**

`mysql_list_dbs`  
`mysql_tablename`

**20.11.1.4.9. `mysql_db_query`**

Copyright 1997-2008 the PHP Documentation Group.

- `mysql_db_query`

Send a MySQL query

**Description**

```
resource mysql_db_query(string database,
                        string query,
                        resource link_identifier);
```

`mysql_db_query` selects a database, and executes a query on it.

**Parameters**

<i>database</i>	The name of the database that will be selected.
<i>query</i>	The MySQL query.

*link\_identifier*

The MySQL connection. If the link identifier is not specified, the last link opened by `mysql_connect` is assumed. If no such link is found, it will try to create one as if `mysql_connect` was called with no arguments. If by chance no connection is found or established, an `E_WARNING` level error is generated.

**Return Values**

Returns a positive MySQL result resource to the query result, or `FALSE` on error. The function also returns `TRUE` / `FALSE` for `INSERT/UPDATE/DELETE` queries to indicate success/failure.

**ChangeLog**

Version	Description
5.3.0	This function now throws an <code>E_DEPRECATED</code> notice.
4.0.6	This function is deprecated, do not use this function. Use <code>mysql_select_db</code> and <code>mysql_query</code> instead.

**Examples****Example 20.24. `mysql_db_query` alternative example**

```
<?php
if (!$link = mysql_connect('mysql_host', 'mysql_user', 'mysql_password')) {
    echo 'Could not connect to mysql';
    exit;
}

if (!mysql_select_db('mysql_dbname', $link)) {
    echo 'Could not select database';
    exit;
}

$sql = 'SELECT foo FROM bar WHERE id = 42';
$result = mysql_query($sql, $link);

if (!$result) {
    echo "DB Error, could not query the database\n";
    echo 'MySQL Error: ' . mysql_error();
    exit;
}

while ($row = mysql_fetch_assoc($result)) {
    echo $row['foo'];
}

mysql_free_result($result);

?>
```

**Notes****Note**

Be aware that this function does *NOT* switch back to the database you were connected before. In other words, you can't use this function to *temporarily* run a sql query on another database, you would have to manually switch back. Users are strongly encouraged to use the `database.table` syntax in their sql queries or `mysql_select_db` instead of this function.

**See Also**

`mysql_query`  
`mysql_select_db`

**20.11.1.4.10. `mysql_drop_db`**

Copyright 1997-2008 the PHP Documentation Group.

- [mysql\\_drop\\_db](#)

Drop (delete) a MySQL database

### Description

```
bool mysql_drop_db(string database_name,
                  resource link_identifier);
```

[mysql\\_drop\\_db](#) attempts to drop (remove) an entire database from the server associated with the specified link identifier. This function is deprecated, it is preferable to use [mysql\\_query](#) to issue a sql `DROP DATABASE` statement instead.

### Parameters

<i>database_name</i>	The name of the database that will be deleted.
<i>link_identifier</i>	The MySQL connection. If the link identifier is not specified, the last link opened by <a href="#">mysql_connect</a> is assumed. If no such link is found, it will try to create one as if <a href="#">mysql_connect</a> was called with no arguments. If by chance no connection is found or established, an <code>E_WARNING</code> level error is generated.

### Return Values

Returns `TRUE` on success or `FALSE` on failure.

### Examples

#### Example 20.25. [mysql\\_drop\\_db](#) alternative example

```
<?php
$link = mysql_connect('localhost', 'mysql_user', 'mysql_password');
if (!$link) {
    die('Could not connect: ' . mysql_error());
}

$sql = 'DROP DATABASE my_db';
if (mysql_query($sql, $link)) {
    echo "Database my_db was successfully dropped\n";
} else {
    echo 'Error dropping database: ' . mysql_error() . "\n";
}
?>
```

### Notes

#### Warning

This function will not be available if the MySQL extension was built against a MySQL 4.x client library.

#### Note

For backward compatibility, the following deprecated alias may be used: [mysql\\_dropdb](#)

### See Also

[mysql\\_query](#)

#### 20.11.1.4.11. [mysql\\_errno](#)

Copyright 1997-2008 the PHP Documentation Group.

- [mysql\\_errno](#)

Returns the numerical value of the error message from previous MySQL operation

### Description

```
int mysql_errno(resource link_identifier);
```

Returns the error number from the last MySQL function.

Errors coming back from the MySQL database backend no longer issue warnings. Instead, use `mysql_errno` to retrieve the error code. Note that this function only returns the error code from the most recently executed MySQL function (not including `mysql_error` and `mysql_errno`), so if you want to use it, make sure you check the value before calling another MySQL function.

### Parameters

*link\_identifier*      The MySQL connection. If the link identifier is not specified, the last link opened by `mysql_connect` is assumed. If no such link is found, it will try to create one as if `mysql_connect` was called with no arguments. If by chance no connection is found or established, an `E_WARNING` level error is generated.

### Return Values

Returns the error number from the last MySQL function, or 0 (zero) if no error occurred.

### Examples

#### Example 20.26. `mysql_errno` example

```
<?php
$link = mysql_connect("localhost", "mysql_user", "mysql_password");

if (!mysql_select_db("nonexistentdb", $link)) {
    echo mysql_errno($link) . ": " . mysql_error($link). "\n";
}

mysql_select_db("kossu", $link);
if (!mysql_query("SELECT * FROM nonexistenttable", $link)) {
    echo mysql_errno($link) . ": " . mysql_error($link). "\n";
}
?>
```

The above example will output something similar to:

```
1049: Unknown database 'nonexistentdb'
1146: Table 'kossu.nonexistenttable' doesn't exist
```

### See Also

[mysql\\_error](#)  
[MySQL error codes](#)

#### 20.11.1.4.12. `mysql_error`

Copyright 1997-2008 the PHP Documentation Group.

- [mysql\\_error](#)

Returns the text of the error message from previous MySQL operation

### Description

```
string mysql_error(resource link_identifier);
```

Returns the error text from the last MySQL function. Errors coming back from the MySQL database backend no longer issue warnings. Instead, use `mysql_error` to retrieve the error text. Note that this function only returns the error text from the most recently executed MySQL function (not including `mysql_error` and `mysql_errno`), so if you want to use it, make sure you check the value before calling another MySQL function.

### Parameters

*link\_identifier* The MySQL connection. If the link identifier is not specified, the last link opened by `mysql_connect` is assumed. If no such link is found, it will try to create one as if `mysql_connect` was called with no arguments. If by chance no connection is found or established, an `E_WARNING` level error is generated.

### Return Values

Returns the error text from the last MySQL function, or '' (empty string) if no error occurred.

### Examples

#### Example 20.27. `mysql_error` example

```
<?php
$link = mysql_connect("localhost", "mysql_user", "mysql_password");

mysql_select_db("nonexistentdb", $link);
echo mysql_errno($link) . ": " . mysql_error($link) . "\n";

mysql_select_db("kossu", $link);
mysql_query("SELECT * FROM nonexistenttable", $link);
echo mysql_errno($link) . ": " . mysql_error($link) . "\n";
?>
```

The above example will output something similar to:

```
1049: Unknown database 'nonexistentdb'
1146: Table 'kossu.nonexistenttable' doesn't exist
```

### See Also

[mysql\\_errno](#)  
[MySQL error codes](#)

#### 20.11.1.4.13. `mysql_escape_string`

Copyright 1997-2008 the PHP Documentation Group.

- [mysql\\_escape\\_string](#)

Escapes a string for use in a `mysql_query`

**Description**

```
string mysql_escape_string(string unescaped_string);
```

This function will escape the *unescaped\_string*, so that it is safe to place it in a *mysql\_query*. This function is deprecated.

This function is identical to *mysql\_real\_escape\_string* except that *mysql\_real\_escape\_string* takes a connection handler and escapes the string according to the current character set. *mysql\_escape\_string* does not take a connection argument and does not respect the current charset setting.

**Parameters**

*unescaped\_string*                      The string that is to be escaped.

**Return Values**

Returns the escaped string.

**ChangeLog**

Version	Description
5.3.0	This function now throws an E_DEPRECATED notice.
4.3.0	This function became deprecated, do not use this function. Instead, use <i>mysql_real_escape_string</i> .

**Examples****Example 20.28. *mysql\_escape\_string* example**

```
<?php
$item = "Zak's Laptop";
$escaped_item = mysql_escape_string($item);
printf("Escaped string: %s\n", $escaped_item);
?>
```

The above example will output:

```
Escaped string: Zak\'s Laptop
```

**Notes****Note**

*mysql\_escape\_string* does not escape % and \_.

**See Also**

*mysql\_real\_escape\_string*

*addslashes*

The *magic\_quotes\_gpc* directive.

**20.11.1.4.14. *mysql\_fetch\_array***

Copyright 1997-2008 the PHP Documentation Group.

- `mysql_fetch_array`

Fetch a result row as an associative array, a numeric array, or both

### Description

```
array mysql_fetch_array(resource result,
                       int result_type);
```

Returns an array that corresponds to the fetched row and moves the internal data pointer ahead.

### Parameters

`result` The result resource that is being evaluated. This result comes from a call to `mysql_query`.

`result_type` The type of array that is to be fetched. It's a constant and can take the following values: `MYSQL_ASSOC`, `MYSQL_NUM`, and the default value of `MYSQL_BOTH`.

### Return Values

Returns an array of strings that corresponds to the fetched row, or `FALSE` if there are no more rows. The type of returned array depends on how `result_type` is defined. By using `MYSQL_BOTH` (default), you'll get an array with both associative and number indices. Using `MYSQL_ASSOC`, you only get associative indices (as `mysql_fetch_assoc` works), using `MYSQL_NUM`, you only get number indices (as `mysql_fetch_row` works).

If two or more columns of the result have the same field names, the last column will take precedence. To access the other column(s) of the same name, you must use the numeric index of the column or make an alias for the column. For aliased columns, you cannot access the contents with the original column name.

### Examples

#### Example 20.29. Query with aliased duplicate field names

```
SELECT table1.field AS foo, table2.field AS bar FROM table1, table2
```

#### Example 20.30. `mysql_fetch_array` with `MYSQL_NUM`

```
<?php
mysql_connect("localhost", "mysql_user", "mysql_password") or
die("Could not connect: " . mysql_error());
mysql_select_db("mydb");

$result = mysql_query("SELECT id, name FROM mytable");

while ($row = mysql_fetch_array($result, MYSQL_NUM)) {
    printf("ID: %s Name: %s", $row[0], $row[1]);
}

mysql_free_result($result);
?>
```

#### Example 20.31. `mysql_fetch_array` with `MYSQL_ASSOC`

```
<?php
mysql_connect("localhost", "mysql_user", "mysql_password") or
die("Could not connect: " . mysql_error());
mysql_select_db("mydb");
```

```

$result = mysql_query("SELECT id, name FROM mytable");
while ($row = mysql_fetch_array($result, MYSQL_ASSOC)) {
    printf("ID: %s Name: %s", $row["id"], $row["name"]);
}
mysql_free_result($result);
?>

```

### Example 20.32. `mysql_fetch_array` with `MYSQL_BOTH`

```

<?php
mysql_connect("localhost", "mysql_user", "mysql_password") or
die("Could not connect: " . mysql_error());
mysql_select_db("mydb");

$result = mysql_query("SELECT id, name FROM mytable");
while ($row = mysql_fetch_array($result, MYSQL_BOTH)) {
    printf("ID: %s Name: %s", $row[0], $row["name"]);
}
mysql_free_result($result);
?>

```

#### Notes

##### Performance

An important thing to note is that using `mysql_fetch_array` is *not significantly* slower than using `mysql_fetch_row`, while it provides a significant added value.

##### Note

Field names returned by this function are *case-sensitive*.

##### Note

This function sets NULL fields to the PHP `NULL` value.

#### See Also

```

mysql_fetch_row
mysql_fetch_assoc
mysql_data_seek
mysql_query

```

#### 20.11.1.4.15. `mysql_fetch_assoc`

Copyright 1997-2008 the PHP Documentation Group.

- `mysql_fetch_assoc`

Fetch a result row as an associative array

#### Description

```
array mysql_fetch_assoc(resource result);
```

Returns an associative array that corresponds to the fetched row and moves the internal data pointer ahead. `mysql_fetch_assoc` is equivalent to calling `mysql_fetch_array` with `MYSQL_ASSOC` for the optional second parameter. It only returns an associative array.



## Parameters

`result` The result resource that is being evaluated. This result comes from a call to `mysql_query`.

## Return Values

Returns an associative array of strings that corresponds to the fetched row, or `FALSE` if there are no more rows.

If two or more columns of the result have the same field names, the last column will take precedence. To access the other column(s) of the same name, you either need to access the result with numeric indices by using `mysql_fetch_row` or add alias names. See the example at the `mysql_fetch_array` description about aliases.

## Examples

### Example 20.33. An expanded `mysql_fetch_assoc` example

```
<?php
$conn = mysql_connect("localhost", "mysql_user", "mysql_password");

if (!$conn) {
    echo "Unable to connect to DB: " . mysql_error();
    exit;
}

if (!mysql_select_db("mydbname")) {
    echo "Unable to select mydbname: " . mysql_error();
    exit;
}

$sql = "SELECT id as userid, fullname, userstatus
        FROM   sometable
        WHERE  userstatus = 1";

$result = mysql_query($sql);

if (!$result) {
    echo "Could not successfully run query ($sql) from DB: " . mysql_error();
    exit;
}

if (mysql_num_rows($result) == 0) {
    echo "No rows found, nothing to print so am exiting";
    exit;
}

// While a row of data exists, put that row in $row as an associative array
// Note: If you're expecting just one row, no need to use a loop
// Note: If you put extract($row); inside the following loop, you'll
//       then create $userid, $fullname, and $userstatus
while ($row = mysql_fetch_assoc($result)) {
    echo $row["userid"];
    echo $row["fullname"];
    echo $row["userstatus"];
}

mysql_free_result($result);

?>
```

## Notes

### Performance

An important thing to note is that using `mysql_fetch_assoc` is *not significantly* slower than using `mysql_fetch_row`, while it provides a significant added value.

### Note

Field names returned by this function are *case-sensitive*.

### Note

This function sets NULL fields to the PHP `NULL` value.

#### See Also

`mysql_fetch_row`  
`mysql_fetch_array`  
`mysql_data_seek`  
`mysql_query`  
`mysql_error`

#### 20.11.1.4.16. `mysql_fetch_field`

Copyright 1997-2008 the PHP Documentation Group.

- `mysql_fetch_field`

Get column information from a result and return as an object

#### Description

```
object mysql_fetch_field(resource result,  
                        int field_offset);
```

Returns an object containing field information. This function can be used to obtain information about fields in the provided query result.

#### Parameters

*result* The result resource that is being evaluated. This result comes from a call to `mysql_query`.

*field\_offset* The numerical field offset. If the field offset is not specified, the next field that was not yet retrieved by this function is retrieved. The *field\_offset* starts at 0.

#### Return Values

Returns an object containing field information. The properties of the object are:

- `name` - column name
- `table` - name of the table the column belongs to
- `def` - default value of the column
- `max_length` - maximum length of the column
- `not_null` - 1 if the column cannot be `NULL`
- `primary_key` - 1 if the column is a primary key
- `unique_key` - 1 if the column is a unique key
- `multiple_key` - 1 if the column is a non-unique key
- `numeric` - 1 if the column is numeric
- `blob` - 1 if the column is a BLOB
- `type` - the type of the column
- `unsigned` - 1 if the column is unsigned
- `zerofill` - 1 if the column is zero-filled

## Examples

### Example 20.34. `mysql_fetch_field` example

```
<?php
$conn = mysql_connect('localhost', 'mysql_user', 'mysql_password');
if (!$conn) {
    die('Could not connect: ' . mysql_error());
}
mysql_select_db('database');
$result = mysql_query('select * from table');
if (!$result) {
    die('Query failed: ' . mysql_error());
}
/* get column metadata */
$i = 0;
while ($i < mysql_num_fields($result)) {
    echo "Information for column $i:<br />\n";
    $meta = mysql_fetch_field($result, $i);
    if (!$meta) {
        echo "No information available<br />\n";
    }
    echo "<pre>
blob:          $meta->blob
max_length:    $meta->max_length
multiple_key:  $meta->multiple_key
name:          $meta->name
not_null:      $meta->not_null
numeric:       $meta->numeric
primary_key:   $meta->primary_key
table:         $meta->table
type:          $meta->type
default:       $meta->def
unique_key:    $meta->unique_key
unsigned:      $meta->unsigned
zerofill:      $meta->zerofill
</pre>";
    $i++;
}
mysql_free_result($result);
?>
```

## Notes

### Note

Field names returned by this function are *case-sensitive*.

## See Also

[mysql\\_field\\_seek](#)

### 20.11.1.4.17. `mysql_fetch_lengths`

Copyright 1997-2008 the PHP Documentation Group.

- [mysql\\_fetch\\_lengths](#)

Get the length of each output in a result

## Description

```
array mysql_fetch_lengths(resource result);
```

Returns an array that corresponds to the lengths of each field in the last row fetched by MySQL.

`mysql_fetch_lengths` stores the lengths of each result column in the last row returned by `mysql_fetch_row`, `mysql_fetch_assoc`, `mysql_fetch_array`, and `mysql_fetch_object` in an array, starting at offset 0.

## Parameters

`result` The result resource that is being evaluated. This result comes from a call to `mysql_query`.

### Return Values

An array of lengths on success, or `FALSE` on failure.

### Examples

#### Example 20.35. A `mysql_fetch_lengths` example

```
<?php
$result = mysql_query("SELECT id,email FROM people WHERE id = '42'");
if (!$result) {
    echo 'Could not run query: ' . mysql_error();
    exit;
}
$row      = mysql_fetch_assoc($result);
$lengths = mysql_fetch_lengths($result);

print_r($row);
print_r($lengths);
?>
```

The above example will output something similar to:

```
Array
(
    [id] => 42
    [email] => user@example.com
)
Array
(
    [0] => 2
    [1] => 16
)
```

### See Also

[mysql\\_field\\_len](#)  
[mysql\\_fetch\\_row](#)  
[strlen](#)

#### 20.11.1.4.18. `mysql_fetch_object`

Copyright 1997-2008 the PHP Documentation Group.

- [mysql\\_fetch\\_object](#)

Fetch a result row as an object

### Description

```
object mysql_fetch_object(resource result,
                          string class_name,
                          array params);
```

Returns an object with properties that correspond to the fetched row and moves the internal data pointer ahead.

### Parameters

<code>result</code>	The result resource that is being evaluated. This result comes from a call to <code>mysql_query</code> .
<code>class_name</code>	The name of the class to instantiate, set the properties of and return. If not specified, a <code>stdClass</code> object is returned.
<code>params</code>	An optional array of parameters to pass to the constructor for <code>class_name</code> objects.

**Return Values**

Returns an object with string properties that correspond to the fetched row, or `FALSE` if there are no more rows.

`mysql_fetch_row` fetches one row of data from the result associated with the specified result identifier. The row is returned as an array. Each result column is stored in an array offset, starting at offset 0.

**ChangeLog**

Version	Description
5.0.0	Added the ability to return as a different object.

**Examples****Example 20.36. `mysql_fetch_object` example**

```
<?php
mysql_connect("hostname", "user", "password");
mysql_select_db("mydb");
$result = mysql_query("select * from mytable");
while ($row = mysql_fetch_object($result)) {
    echo $row->user_id;
    echo $row->fullname;
}
mysql_free_result($result);
?>
```

**Example 20.37. `mysql_fetch_object` example**

```
<?php
class foo {
    public $name;
}

mysql_connect("hostname", "user", "password");
mysql_select_db("mydb");

$result = mysql_query("select name from mytable limit 1");
$obj = mysql_fetch_object($result, 'foo');
var_dump($obj);
?>
```

**Notes****Performance**

Speed-wise, the function is identical to `mysql_fetch_array`, and almost as quick as `mysql_fetch_row` (the difference is insignificant).

**Note**

`mysql_fetch_object` is similar to `mysql_fetch_array`, with one difference - an object is returned, instead

of an array. Indirectly, that means that you can only access the data by the field names, and not by their offsets (numbers are illegal property names).

#### Note

Field names returned by this function are *case-sensitive*.

#### Note

This function sets NULL fields to the PHP `NULL` value.

#### See Also

`mysql_fetch_array`  
`mysql_fetch_assoc`  
`mysql_fetch_row`  
`mysql_data_seek`  
`mysql_query`

### 20.11.1.4.19. `mysql_fetch_row`

Copyright 1997-2008 the PHP Documentation Group.

- `mysql_fetch_row`

Get a result row as an enumerated array

#### Description

```
array mysql_fetch_row(resource result);
```

Returns a numerical array that corresponds to the fetched row and moves the internal data pointer ahead.

#### Parameters

*result* The result resource that is being evaluated. This result comes from a call to `mysql_query`.

#### Return Values

Returns an numerical array of strings that corresponds to the fetched row, or `FALSE` if there are no more rows.

`mysql_fetch_row` fetches one row of data from the result associated with the specified result identifier. The row is returned as an array. Each result column is stored in an array offset, starting at offset 0.

#### Examples

#### Example 20.38. Fetching one row with `mysql_fetch_row`

```
<?php
$result = mysql_query("SELECT id,email FROM people WHERE id = '42'");
if (!$result) {
    echo 'Could not run query: ' . mysql_error();
    exit;
}
$row = mysql_fetch_row($result);

echo $row[0]; // 42
echo $row[1]; // the email value
?>
```

#### Notes

**Note**

This function sets NULL fields to the PHP `NULL` value.

**See Also**

`mysql_fetch_array`  
`mysql_fetch_assoc`  
`mysql_fetch_object`  
`mysql_data_seek`  
`mysql_fetch_lengths`  
`mysql_result`

**20.11.1.4.20. `mysql_field_flags`**

Copyright 1997-2008 the PHP Documentation Group.

- `mysql_field_flags`

Get the flags associated with the specified field in a result

**Description**

```
string mysql_field_flags(resource result,
                        int field_offset);
```

`mysql_field_flags` returns the field flags of the specified field. The flags are reported as a single word per flag separated by a single space, so that you can split the returned value using `explode`.

**Parameters**

<code>result</code>	The result resource that is being evaluated. This result comes from a call to <code>mysql_query</code> .
<code>field_offset</code>	The numerical field offset. The <code>field_offset</code> starts at 0. If <code>field_offset</code> does not exist, an error of level <code>E_WARNING</code> is also issued.

**Return Values**

Returns a string of flags associated with the result, or `FALSE` on failure.

The following flags are reported, if your version of MySQL is current enough to support them: `"not_null"`, `"primary_key"`, `"unique_key"`, `"multiple_key"`, `"blob"`, `"unsigned"`, `"zerofill"`, `"binary"`, `"enum"`, `"auto_increment"` and `"timestamp"`.

**Examples****Example 20.39. A `mysql_field_flags` example**

```
<?php
$result = mysql_query("SELECT id,email FROM people WHERE id = '42'");
if (!$result) {
    echo 'Could not run query: ' . mysql_error();
    exit;
}
$flags = mysql_field_flags($result, 0);

echo $flags;
print_r(explode(' ', $flags));
?>
```

The above example will output something similar to:

```
not_null primary_key auto_increment
Array
(
    [0] => not_null
    [1] => primary_key
    [2] => auto_increment
)
```

**Notes****Note**

For backward compatibility, the following deprecated alias may be used: `mysql_fieldflags`

**See Also**

`mysql_field_type`  
`mysql_field_len`

**20.11.1.4.21. `mysql_field_len`**

Copyright 1997-2008 the PHP Documentation Group.

- `mysql_field_len`

Returns the length of the specified field

**Description**

```
int mysql_field_len(resource result,
                    int field_offset);
```

`mysql_field_len` returns the length of the specified field.

**Parameters**

<code>result</code>	The result resource that is being evaluated. This result comes from a call to <code>mysql_query</code> .
<code>field_offset</code>	The numerical field offset. The <code>field_offset</code> starts at 0. If <code>field_offset</code> does not exist, an error of level <code>E_WARNING</code> is also issued.

**Return Values**

The length of the specified field index on success, or `FALSE` on failure.

**Examples****Example 20.40. `mysql_field_len` example**

```
<?php
$result = mysql_query("SELECT id,email FROM people WHERE id = '42'");
if (!$result) {
    echo 'Could not run query: ' . mysql_error();
    exit;
}

// Will get the length of the id field as specified in the database
// schema.
$length = mysql_field_len($result, 0);
echo $length;
?>
```



**Notes****Note**

For backward compatibility, the following deprecated alias may be used: `mysql_fieldlen`

**See Also**

`mysql_fetch_lengths`  
`strlen`

**20.11.1.4.22. `mysql_field_name`**

Copyright 1997-2008 the PHP Documentation Group.

- `mysql_field_name`

Get the name of the specified field in a result

**Description**

```
string mysql_field_name(resource result,
                       int field_offset);
```

`mysql_field_name` returns the name of the specified field index.

**Parameters**

<code>result</code>	The result resource that is being evaluated. This result comes from a call to <code>mysql_query</code> .
<code>field_offset</code>	The numerical field offset. The <code>field_offset</code> starts at 0. If <code>field_offset</code> does not exist, an error of level <code>E_WARNING</code> is also issued.

**Return Values**

The name of the specified field index on success, or `FALSE` on failure.

**Examples****Example 20.41. `mysql_field_name` example**

```
<?php
/* The users table consists of three fields:
 * user_id
 * username
 * password.
 */
$link = @mysql_connect('localhost', 'mysql_user', 'mysql_password');
if (!$link) {
    die('Could not connect to MySQL server: ' . mysql_error());
}
$dbname = 'mydb';
$db_selected = mysql_select_db($dbname, $link);
if (!$db_selected) {
    die("Could not set $dbname: " . mysql_error());
}
$res = mysql_query('select * from users', $link);

echo mysql_field_name($res, 0) . "\n";
echo mysql_field_name($res, 2);
?>
```

The above example will output:

```
user_id
password
```

**Notes****Note**

Field names returned by this function are *case-sensitive*.

**Note**

For backward compatibility, the following deprecated alias may be used: `mysql_fieldname`

**See Also**

```
mysql_field_type
mysql_field_len
```

**20.11.1.4.23. `mysql_field_seek`**

Copyright 1997-2008 the PHP Documentation Group.

- `mysql_field_seek`

Set result pointer to a specified field offset

**Description**

```
bool mysql_field_seek(resource result,
                    int field_offset);
```

Seeks to the specified field offset. If the next call to `mysql_fetch_field` doesn't include a field offset, the field offset specified in `mysql_field_seek` will be returned.

**Parameters**

<code>result</code>	The result resource that is being evaluated. This result comes from a call to <code>mysql_query</code> .
<code>field_offset</code>	The numerical field offset. The <code>field_offset</code> starts at 0. If <code>field_offset</code> does not exist, an error of level <code>E_WARNING</code> is also issued.

**Return Values**

Returns `TRUE` on success or `FALSE` on failure.

**See Also**

```
mysql_fetch_field
```

**20.11.1.4.24. `mysql_field_table`**

Copyright 1997-2008 the PHP Documentation Group.

- `mysql_field_table`

Get name of the table the specified field is in

**Description**

```
string mysql_field_table(resource result,
                        int field_offset);
```

Returns the name of the table that the specified field is in.

### Parameters

*result* The result resource that is being evaluated. This result comes from a call to `mysql_query`.

*field\_offset* The numerical field offset. The *field\_offset* starts at 0. If *field\_offset* does not exist, an error of level `E_WARNING` is also issued.

### Return Values

The name of the table on success.

### Examples

#### Example 20.42. A `mysql_field_table` example

```
<?php
$query = "SELECT account.*, country.* FROM account, country WHERE country.name = 'Portugal' AND account.country_id = c";

// get the result from the DB
$result = mysql_query($query);

// Lists the table name and then the field name
for ($i = 0; $i < mysql_num_fields($result); ++$i) {
    $table = mysql_field_table($result, $i);
    $field = mysql_field_name($result, $i);

    echo "$table: $field\n";
}
?>
```

### Notes

#### Note

For backward compatibility, the following deprecated alias may be used: `mysql_fieldtable`

### See Also

[mysql\\_list\\_tables](#)

#### 20.11.1.4.25. `mysql_field_type`

Copyright 1997-2008 the PHP Documentation Group.

- [mysql\\_field\\_type](#)

Get the type of the specified field in a result

### Description

```
string mysql_field_type(resource result,
                        int field_offset);
```

`mysql_field_type` is similar to the `mysql_field_name` function. The arguments are identical, but the field type is returned instead.

## Parameters

<code>result</code>	The result resource that is being evaluated. This result comes from a call to <code>mysql_query</code> .
<code>field_offset</code>	The numerical field offset. The <code>field_offset</code> starts at 0. If <code>field_offset</code> does not exist, an error of level <code>E_WARNING</code> is also issued.

## Return Values

The returned field type will be one of "int", "real", "string", "blob", and others as detailed in the [MySQL documentation](#).

## Examples

### Example 20.43. `mysql_field_type` example

```
<?php
mysql_connect("localhost", "mysql_username", "mysql_password");
mysql_select_db("mysql");
$result = mysql_query("SELECT * FROM func");
$fields = mysql_num_fields($result);
$rows = mysql_num_rows($result);
$table = mysql_field_table($result, 0);
echo "Your '" . $table . "' table has " . $fields . " fields and " . $rows . " record(s)\n";
echo "The table has the following fields:\n";
for ($i=0; $i < $fields; $i++) {
    $type = mysql_field_type($result, $i);
    $name = mysql_field_name($result, $i);
    $len = mysql_field_len($result, $i);
    $flags = mysql_field_flags($result, $i);
    echo $type . " " . $name . " " . $len . " " . $flags . "\n";
}
mysql_free_result($result);
mysql_close();
?>
```

The above example will output something similar to:

```
Your 'func' table has 4 fields and 1 record(s)
The table has the following fields:
string name 64 not_null primary_key binary
int ret 1 not_null
string dl 128 not_null
string type 9 not_null enum
```

## Notes

### Note

For backward compatibility, the following deprecated alias may be used: `mysql_fieldtype`

## See Also

`mysql_field_name`  
`mysql_field_len`

### 20.11.1.4.26. `mysql_free_result`

Copyright 1997-2008 the PHP Documentation Group.

- `mysql_free_result`

Free result memory

### Description

```
bool mysql_free_result(resource result);
```

`mysql_free_result` will free all memory associated with the result identifier `result`.

`mysql_free_result` only needs to be called if you are concerned about how much memory is being used for queries that return large result sets. All associated result memory is automatically freed at the end of the script's execution.

### Parameters

`result` The result resource that is being evaluated. This result comes from a call to `mysql_query`.

### Return Values

Returns `TRUE` on success or `FALSE` on failure.

If a non-resource is used for the `result`, an error of level `E_WARNING` will be emitted. It's worth noting that `mysql_query` only returns a resource for `SELECT`, `SHOW`, `EXPLAIN`, and `DESCRIBE` queries.

### Examples

#### Example 20.44. A `mysql_free_result` example

```
<?php
$result = mysql_query("SELECT id,email FROM people WHERE id = '42'");
if (!$result) {
    echo 'Could not run query: ' . mysql_error();
    exit;
}
/* Use the result, assuming we're done with it afterwards */
$row = mysql_fetch_assoc($result);

/* Now we free up the result and continue on with our script */
mysql_free_result($result);

echo $row['id'];
echo $row['email'];
?>
```

### Notes

#### Note

For backward compatibility, the following deprecated alias may be used: `mysql_freeresult`

### See Also

`mysql_query`  
`is_resource`

#### 20.11.1.4.27. `mysql_get_client_info`

Copyright 1997-2008 the PHP Documentation Group.

- `mysql_get_client_info`

Get MySQL client info

**Description**

```
string mysql_get_client_info();
```

`mysql_get_client_info` returns a string that represents the client library version.

**Return Values**

The MySQL client version.

**Examples****Example 20.45. `mysql_get_client_info` example**

```
<?php
printf("MySQL client info: %s\n", mysql_get_client_info());
?>
```

The above example will output something similar to:

```
MySQL client info: 3.23.39
```

**See Also**

[mysql\\_get\\_host\\_info](#)  
[mysql\\_get\\_proto\\_info](#)  
[mysql\\_get\\_server\\_info](#)

**20.11.1.4.28. `mysql_get_host_info`**

Copyright 1997-2008 the PHP Documentation Group.

- [mysql\\_get\\_host\\_info](#)  
Get MySQL host info

**Description**

```
string mysql_get_host_info(resource link_identifier);
```

Describes the type of connection in use for the connection, including the server host name.

**Parameters**

*link\_identifier*

The MySQL connection. If the link identifier is not specified, the last link opened by `mysql_connect` is assumed. If no such link is found, it will try to create one as if `mysql_connect` was called with no arguments. If by chance no connection is found or established, an `E_WARNING` level error is generated.

**Return Values**

Returns a string describing the type of MySQL connection in use for the connection or `FALSE` on failure.

**Examples**

**Example 20.46. `mysql_get_host_info` example**

```
<?php
$link = mysql_connect('localhost', 'mysql_user', 'mysql_password');
if (!$link) {
    die('Could not connect: ' . mysql_error());
}
printf("MySQL host info: %s\n", mysql_get_host_info());
?>
```

The above example will output something similar to:

```
MySQL host info: Localhost via UNIX socket
```

**See Also**

[mysql\\_get\\_client\\_info](#)  
[mysql\\_get\\_proto\\_info](#)  
[mysql\\_get\\_server\\_info](#)

**20.11.1.4.29. `mysql_get_proto_info`**

Copyright 1997-2008 the PHP Documentation Group.

- [mysql\\_get\\_proto\\_info](#)  
Get MySQL protocol info

**Description**

```
int mysql_get_proto_info(resource link_identifier);
```

Retrieves the MySQL protocol.

**Parameters**

*link\_identifier*

The MySQL connection. If the link identifier is not specified, the last link opened by [mysql\\_connect](#) is assumed. If no such link is found, it will try to create one as if [mysql\\_connect](#) was called with no arguments. If by chance no connection is found or established, an `E_WARNING` level error is generated.

**Return Values**

Returns the MySQL protocol on success, or `FALSE` on failure.

**Examples****Example 20.47. `mysql_get_proto_info` example**

```
<?php
$link = mysql_connect('localhost', 'mysql_user', 'mysql_password');
if (!$link) {
    die('Could not connect: ' . mysql_error());
}
printf("MySQL protocol version: %s\n", mysql_get_proto_info());
```

```
?>
```

The above example will output something similar to:

```
MySQL protocol version: 10
```

### See Also

```
mysql_get_client_info
mysql_get_host_info
mysql_get_server_info
```

#### 20.11.1.4.30. `mysql_get_server_info`

Copyright 1997-2008 the PHP Documentation Group.

- `mysql_get_server_info`

Get MySQL server info

### Description

```
string mysql_get_server_info(resource link_identifier);
```

Retrieves the MySQL server version.

### Parameters

*link\_identifier*

The MySQL connection. If the link identifier is not specified, the last link opened by `mysql_connect` is assumed. If no such link is found, it will try to create one as if `mysql_connect` was called with no arguments. If by chance no connection is found or established, an `E_WARNING` level error is generated.

### Return Values

Returns the MySQL server version on success, or `FALSE` on failure.

### Examples

#### Example 20.48. `mysql_get_server_info` example

```
<?php
$link = mysql_connect('localhost', 'mysql_user', 'mysql_password');
if (!$link) {
    die('Could not connect: ' . mysql_error());
}
printf("MySQL server version: %s\n", mysql_get_server_info());
?>
```

The above example will output something similar to:

```
MySQL server version: 4.0.1-alpha
```



**See Also**

```
mysql_get_client_info
mysql_get_host_info
mysql_get_proto_info
phpversion
```

**20.11.1.4.31. mysql\_info**

Copyright 1997-2008 the PHP Documentation Group.

- `mysql_info`

Get information about the most recent query

**Description**

```
string mysql_info(resource link_identifier);
```

Returns detailed information about the last query.

**Parameters**

*link\_identifier* The MySQL connection. If the link identifier is not specified, the last link opened by `mysql_connect` is assumed. If no such link is found, it will try to create one as if `mysql_connect` was called with no arguments. If by chance no connection is found or established, an `E_WARNING` level error is generated.

**Return Values**

Returns information about the statement on success, or `FALSE` on failure. See the example below for which statements provide information, and what the returned value may look like. Statements that are not listed will return `FALSE`.

**Examples****Example 20.49. Relevant MySQL Statements**

Statements that return string values. The numbers are only for illustrating purpose; their values will correspond to the query.

```
INSERT INTO ... SELECT ...
String format: Records: 23 Duplicates: 0 Warnings: 0
INSERT INTO ... VALUES (...),(...),(...)...
String format: Records: 37 Duplicates: 0 Warnings: 0
LOAD DATA INFILE ...
String format: Records: 42 Deleted: 0 Skipped: 0 Warnings: 0
ALTER TABLE
String format: Records: 60 Duplicates: 0 Warnings: 0
UPDATE
String format: Rows matched: 65 Changed: 65 Warnings: 0
```

**Notes****Note**

`mysql_info` returns a non-`FALSE` value for the `INSERT ... VALUES` statement only if multiple value lists are specified in the statement.

**See Also**

[mysql\\_affected\\_rows](#)  
[mysql\\_insert\\_id](#)  
[mysql\\_stat](#)

**20.11.1.4.32. mysql\_insert\_id**

Copyright 1997-2008 the PHP Documentation Group.

- [mysql\\_insert\\_id](#)

Get the ID generated from the previous INSERT operation

**Description**

```
int mysql_insert_id(resource link_identifier);
```

Retrieves the ID generated for an AUTO\_INCREMENT column by the previous INSERT query.

**Parameters**

*link\_identifier*

The MySQL connection. If the link identifier is not specified, the last link opened by [mysql\\_connect](#) is assumed. If no such link is found, it will try to create one as if [mysql\\_connect](#) was called with no arguments. If by chance no connection is found or established, an [E\\_WARNING](#) level error is generated.

**Return Values**

The ID generated for an AUTO\_INCREMENT column by the previous INSERT query on success, [0](#) if the previous query does not generate an AUTO\_INCREMENT value, or [FALSE](#) if no MySQL connection was established.

**Examples****Example 20.50. mysql\_insert\_id example**

```
<?php
$link = mysql_connect('localhost', 'mysql_user', 'mysql_password');
if (!$link) {
    die('Could not connect: ' . mysql_error());
}
mysql_select_db('mydb');

mysql_query("INSERT INTO mytable (product) values ('kossu')");
printf("Last inserted record has id %d\n", mysql_insert_id());
?>
```

**Notes****Caution**

[mysql\\_insert\\_id](#) converts the return type of the native MySQL C API function [mysql\\_insert\\_id\(\)](#) to a type of [long](#) (named [int](#) in PHP). If your AUTO\_INCREMENT column has a column type of [BIGINT](#), the value returned by [mysql\\_insert\\_id](#) will be incorrect. Instead, use the internal MySQL SQL function [LAST\\_INSERT\\_ID\(\)](#) in an SQL query.

**Note**

Because [mysql\\_insert\\_id](#) acts on the last performed query, be sure to call [mysql\\_insert\\_id](#) immediately after the query that generates the value.

**Note**

The value of the MySQL SQL function `LAST_INSERT_ID()` always contains the most recently generated `AUTO_INCREMENT` value, and is not reset between queries.

**See Also**

`mysql_query`  
`mysql_info`

**20.11.1.4.33. `mysql_list_dbs`**

Copyright 1997-2008 the PHP Documentation Group.

- `mysql_list_dbs`

List databases available on a MySQL server

**Description**

```
resource mysql_list_dbs(resource link_identifier);
```

Returns a result pointer containing the databases available from the current mysql daemon.

**Parameters**

*link\_identifier*

The MySQL connection. If the link identifier is not specified, the last link opened by `mysql_connect` is assumed. If no such link is found, it will try to create one as if `mysql_connect` was called with no arguments. If by chance no connection is found or established, an `E_WARNING` level error is generated.

**Return Values**

Returns a result pointer resource on success, or `FALSE` on failure. Use the `mysql_tablename` function to traverse this result pointer, or any function for result tables, such as `mysql_fetch_array`.

**Examples****Example 20.51. `mysql_list_dbs` example**

```
<?php
$link = mysql_connect('localhost', 'mysql_user', 'mysql_password');
$db_list = mysql_list_dbs($link);

while ($row = mysql_fetch_object($db_list)) {
    echo $row->Database . "\n";
}
?>
```

The above example will output something similar to:

```
database1
database2
database3
```

**Notes**

**Note**

For backward compatibility, the following deprecated alias may be used: `mysql_listdbs`

**See Also**

`mysql_db_name`  
`mysql_select_db`

**20.11.1.4.34. `mysql_list_fields`**

Copyright 1997-2008 the PHP Documentation Group.

- `mysql_list_fields`

List MySQL table fields

**Description**

```
resource mysql_list_fields(string database_name,
                          string table_name,
                          resource link_identifier);
```

Retrieves information about the given table name.

This function is deprecated. It is preferable to use `mysql_query` to issue a SQL `SHOW COLUMNS FROM table [LIKE 'name']` statement instead.

**Parameters**

<i>database_name</i>	The name of the database that's being queried.
<i>table_name</i>	The name of the table that's being queried.
<i>link_identifier</i>	The MySQL connection. If the link identifier is not specified, the last link opened by <code>mysql_connect</code> is assumed. If no such link is found, it will try to create one as if <code>mysql_connect</code> was called with no arguments. If by chance no connection is found or established, an <code>E_WARNING</code> level error is generated.

**Return Values**

A result pointer resource on success, or `FALSE` on failure.

The returned result can be used with `mysql_field_flags`, `mysql_field_len`, `mysql_field_name` and `mysql_field_type`.

**Examples****Example 20.52. Alternate to deprecated `mysql_list_fields`**

```
<?php
$result = mysql_query("SHOW COLUMNS FROM sometable");
if (!$result) {
    echo 'Could not run query: ' . mysql_error();
    exit;
}
if (mysql_num_rows($result) > 0) {
    while ($row = mysql_fetch_assoc($result)) {
        print_r($row);
    }
}
?>
```

The above example will output something similar to:

```
Array
(
    [Field] => id
    [Type] => int(7)
    [Null] =>
    [Key] => PRI
    [Default] =>
    [Extra] => auto_increment
)
Array
(
    [Field] => email
    [Type] => varchar(100)
    [Null] =>
    [Key] =>
    [Default] =>
    [Extra] =>
)
```

## Notes

### Note

For backward compatibility, the following deprecated alias may be used: `mysql_listfields`

## See Also

`mysql_field_flags`  
`mysql_info`

### 20.11.1.4.35. `mysql_list_processes`

Copyright 1997-2008 the PHP Documentation Group.

- `mysql_list_processes`

List MySQL processes

## Description

```
resource mysql_list_processes(resource link_identifier);
```

Retrieves the current MySQL server threads.

## Parameters

*link\_identifier*

The MySQL connection. If the link identifier is not specified, the last link opened by `mysql_connect` is assumed. If no such link is found, it will try to create one as if `mysql_connect` was called with no arguments. If by chance no connection is found or established, an `E_WARNING` level error is generated.

## Return Values

A result pointer resource on success, or `FALSE` on failure.

## Examples

### Example 20.53. `mysql_list_processes` example

```
<?php
$link = mysql_connect('localhost', 'mysql_user', 'mysql_password');

$result = mysql_list_processes($link);
while ($row = mysql_fetch_assoc($result)){
    printf("%s %s %s %s\n", $row["Id"], $row["Host"], $row["db"],
        $row["Command"], $row["Time"]);
}
mysql_free_result($result);
?>
```

The above example will output something similar to:

```
1 localhost test Processlist 0
4 localhost mysql sleep 5
```

### See Also

[mysql\\_thread\\_id](#)  
[mysql\\_stat](#)

#### 20.11.1.4.36. [mysql\\_list\\_tables](#)

Copyright 1997-2008 the PHP Documentation Group.

- [mysql\\_list\\_tables](#)

List tables in a MySQL database

### Description

```
resource mysql_list_tables(string database,
                           resource link_identifier);
```

Retrieves a list of table names from a MySQL database.

This function is deprecated. It is preferable to use [mysql\\_query](#) to issue a SQL `SHOW TABLES [FROM db_name] [LIKE 'pattern']` statement instead.

### Parameters

<i>database</i>	The name of the database
<i>link_identifier</i>	The MySQL connection. If the link identifier is not specified, the last link opened by <a href="#">mysql_connect</a> is assumed. If no such link is found, it will try to create one as if <a href="#">mysql_connect</a> was called with no arguments. If by chance no connection is found or established, an <code>E_WARNING</code> level error is generated.

### Return Values

A result pointer resource on success, or `FALSE` on failure.

Use the [mysql\\_tablename](#) function to traverse this result pointer, or any function for result tables, such as [mysql\\_fetch\\_array](#).

### ChangeLog

Version	Description
4.3.7	This function became deprecated.

## Examples

### Example 20.54. `mysql_list_tables` alternative example

```

<?php
$dbname = 'mysql_dbname';

if (!mysql_connect('mysql_host', 'mysql_user', 'mysql_password')) {
    echo 'Could not connect to mysql';
    exit;
}

$sql = "SHOW TABLES FROM $dbname";
$result = mysql_query($sql);

if (!$result) {
    echo "DB Error, could not list tables\n";
    echo 'MySQL Error: ' . mysql_error();
    exit;
}

while ($row = mysql_fetch_row($result)) {
    echo "Table: {$row[0]}\n";
}

mysql_free_result($result);
?>

```

## Notes

### Note

For backward compatibility, the following deprecated alias may be used: `mysql_listtables`

## See Also

`mysql_list_dbs`  
`mysql_tablename`

### 20.11.1.4.37. `mysql_num_fields`

Copyright 1997-2008 the PHP Documentation Group.

- `mysql_num_fields`

Get number of fields in result

## Description

```
int mysql_num_fields(resource result);
```

Retrieves the number of fields from a query.

## Parameters

*result*

The result resource that is being evaluated. This result comes from a call to `mysql_query`.

## Return Values

Returns the number of fields in the result set resource on success, or `FALSE` on failure.

## Examples

**Example 20.55. A `mysql_num_fields` example**

```
<?php
$result = mysql_query("SELECT id,email FROM people WHERE id = '42'");
if (!$result) {
    echo 'Could not run query: ' . mysql_error();
    exit;
}

/* returns 2 because id,email === two fields */
echo mysql_num_fields($result);
?>
```

**Notes****Note**

For backward compatibility, the following deprecated alias may be used: `mysql_numfields`

**See Also**

`mysql_select_db`  
`mysql_query`  
`mysql_fetch_field`  
`mysql_num_rows`

**20.11.1.4.38. `mysql_num_rows`**

Copyright 1997-2008 the PHP Documentation Group.

- `mysql_num_rows`

Get number of rows in result

**Description**

```
int mysql_num_rows(resource result);
```

Retrieves the number of rows from a result set. This command is only valid for statements like `SELECT` or `SHOW` that return an actual result set. To retrieve the number of rows affected by a `INSERT`, `UPDATE`, `REPLACE` or `DELETE` query, use `mysql_affected_rows`.

**Parameters**

*result* The result resource that is being evaluated. This result comes from a call to `mysql_query`.

**Return Values**

The number of rows in a result set on success, or `FALSE` on failure.

**Examples****Example 20.56. `mysql_num_rows` example**

```
<?php
$link = mysql_connect("localhost", "mysql_user", "mysql_password");
mysql_select_db("database", $link);

$result = mysql_query("SELECT * FROM table1", $link);
$num_rows = mysql_num_rows($result);
```



```
echo "$num_rows Rows\n";
?>
```

## Notes

### Note

If you use `mysql_unbuffered_query`, `mysql_num_rows` will not return the correct value until all the rows in the result set have been retrieved.

### Note

For backward compatibility, the following deprecated alias may be used: `mysql_numrows`

## See Also

`mysql_affected_rows`  
`mysql_connect`  
`mysql_data_seek`  
`mysql_select_db`  
`mysql_query`

### 20.11.1.4.39. `mysql_pconnect`

Copyright 1997-2008 the PHP Documentation Group.

- `mysql_pconnect`

Open a persistent connection to a MySQL server

## Description

```
resource mysql_pconnect(string server,
                        string username,
                        string password,
                        int client_flags);
```

Establishes a persistent connection to a MySQL server.

`mysql_pconnect` acts very much like `mysql_connect` with two major differences.

First, when connecting, the function would first try to find a (persistent) link that's already open with the same host, username and password. If one is found, an identifier for it will be returned instead of opening a new connection.

Second, the connection to the SQL server will not be closed when the execution of the script ends. Instead, the link will remain open for future use (`mysql_close` will not close links established by `mysql_pconnect`).

This type of link is therefore called 'persistent'.

## Parameters

<code>server</code>	The MySQL server. It can also include a port number. e.g. "hostname:port" or a path to a local socket e.g. ":/path/to/socket" for the localhost.  If the PHP directive <code>mysql.default_host</code> is undefined (default), then the default value is 'localhost:3306'
<code>username</code>	The username. Default value is the name of the user that owns the server process.
<code>password</code>	The password. Default value is an empty password.
<code>client_flags</code>	The <code>client_flags</code> parameter can be a combination of the following constants: 128 (enable <code>LOAD DATA LOCAL</code> handling), <code>MYSQL_CLIENT_SSL</code> ,

`MYSQL_CLIENT_COMPRESS`, `MYSQL_CLIENT_IGNORE_SPACE` or `MYSQL_CLIENT_INTERACTIVE`.

### Return Values

Returns a MySQL persistent link identifier on success, or `FALSE` on failure.

### ChangeLog

Version	Description
4.3.0	Added the <code>client_flags</code> parameter.
3.0.10	Added support for <code>"/path/to/socket"</code> with <code>server</code> .
3.0.0	Added support for <code>":port"</code> with <code>server</code> .

### Notes

#### Note

Note, that these kind of links only work if you are using a module version of PHP. See the [Persistent Database Connections](#) section for more information.

#### Warning

Using persistent connections can require a bit of tuning of your Apache and MySQL configurations to ensure that you do not exceed the number of connections allowed by MySQL.

#### Note

You can suppress the error message on failure by prepending a `@` to the function name.

### See Also

[mysql\\_connect](#)  
[Persistent Database Connections](#)

## 20.11.1.4.40. `mysql_ping`

Copyright 1997-2008 the PHP Documentation Group.

- `mysql_ping`

Ping a server connection or reconnect if there is no connection

### Description

```
bool mysql_ping(resource link_identifier);
```

Checks whether or not the connection to the server is working. If it has gone down, an automatic reconnection is attempted. This function can be used by scripts that remain idle for a long while, to check whether or not the server has closed the connection and reconnect if necessary.

#### Note

Since MySQL 5.0.13, automatic reconnection feature is disabled.

### Parameters

`link_identifier`

The MySQL connection. If the link identifier is not specified, the last link opened by `mysql_connect` is assumed. If no such link is found, it will try to create one as if `mysql_connect` was called with no arguments. If by chance no connection is found or established, an `E_WARNING` level error is generated.

## Return Values

Returns `TRUE` if the connection to the server MySQL server is working, otherwise `FALSE`.

## Examples

### Example 20.57. A `mysql_ping` example

```

<?php
set_time_limit(0);

$conn = mysql_connect('localhost', 'mysqluser', 'mypass');
$db   = mysql_select_db('mydb');

/* Assuming this query will take a long time */
$result = mysql_query($sql);
if (!$result) {
    echo 'Query #1 failed, exiting.';
    exit;
}

/* Make sure the connection is still alive, if not, try to reconnect */
if (!mysql_ping($conn)) {
    echo 'Lost connection, exiting after query #1';
    exit;
}
mysql_free_result($result);

/* So the connection is still alive, let's run another query */
$result2 = mysql_query($sql2);
?>

```

## See Also

[mysql\\_thread\\_id](#)  
[mysql\\_list\\_processes](#)

### 20.11.1.4.41. `mysql_query`

Copyright 1997-2008 the PHP Documentation Group.

- [mysql\\_query](#)

Send a MySQL query

## Description

```

resource mysql_query(string query,
                    resource link_identifier);

```

`mysql_query` sends an unique query (multiple queries are not supported) to the currently active database on the server that's associated with the specified *link\_identifier*.

## Parameters

*query*

A SQL query

The query string should not end with a semicolon.

*link\_identifier*

The MySQL connection. If the link identifier is not specified, the last link opened by `mysql_connect` is assumed. If no such link is found, it will try to create one as if `mysql_connect` was called with no arguments. If by chance no connection is found or established, an `E_WARNING` level error is generated.

## Return Values

For SELECT, SHOW, DESCRIBE, EXPLAIN and other statements returning resultset, `mysql_query` returns a resource on success, or `FALSE` on error.

For other type of SQL statements, INSERT, UPDATE, DELETE, DROP, etc, `mysql_query` returns `TRUE` on success or `FALSE` on error.

The returned result resource should be passed to `mysql_fetch_array`, and other functions for dealing with result tables, to access the returned data.

Use `mysql_num_rows` to find out how many rows were returned for a SELECT statement or `mysql_affected_rows` to find out how many rows were affected by a DELETE, INSERT, REPLACE, or UPDATE statement.

`mysql_query` will also fail and return `FALSE` if the user does not have permission to access the table(s) referenced by the query.

## Examples

### Example 20.58. Invalid Query

The following query is syntactically invalid, so `mysql_query` fails and returns `FALSE`.

```
<?php
$result = mysql_query('SELECT * WHERE 1=1');
if (!$result) {
    die('Invalid query: ' . mysql_error());
}
?>
```

### Example 20.59. Valid Query

The following query is valid, so `mysql_query` returns a resource.

```
<?php
// This could be supplied by a user, for example
$firstname = 'fred';
$lastname = 'fox';

// Formulate Query
// This is the best way to perform a SQL query
// For more examples, see mysql_real_escape_string()
$query = sprintf("SELECT firstname, lastname, address, age FROM friends WHERE firstname='%s' AND lastname='%s'",
    mysql_real_escape_string($firstname),
    mysql_real_escape_string($lastname));

// Perform Query
$result = mysql_query($query);

// Check result
// This shows the actual query sent to MySQL, and the error. Useful for debugging.
if (!$result) {
    $message = 'Invalid query: ' . mysql_error() . "\n";
    $message .= 'Whole query: ' . $query;
    die($message);
}

// Use result
// Attempting to print $result won't allow access to information in the resource
// One of the mysql result functions must be used
// See also mysql_result(), mysql_fetch_array(), mysql_fetch_row(), etc.
while ($row = mysql_fetch_assoc($result)) {
    echo $row['firstname'];
    echo $row['lastname'];
    echo $row['address'];
    echo $row['age'];
}

// Free the resources associated with the result set
// This is done automatically at the end of the script
mysql_free_result($result);
?>
```

**See Also**

[mysql\\_connect](#)  
[mysql\\_error](#)  
[mysql\\_real\\_escape\\_string](#)  
[mysql\\_result](#)  
[mysql\\_fetch\\_assoc](#)  
[mysql\\_unbuffered\\_query](#)

**20.11.1.4.42. mysql\_real\_escape\_string**

Copyright 1997-2008 the PHP Documentation Group.

- [mysql\\_real\\_escape\\_string](#)

Escapes special characters in a string for use in a SQL statement

**Description**

```
string mysql_real_escape_string(string unescaped_string,  
                               resource link_identifier);
```

Escapes special characters in the *unescaped\_string*, taking into account the current character set of the connection so that it is safe to place it in a [mysql\\_query](#). If binary data is to be inserted, this function must be used.

[mysql\\_real\\_escape\\_string](#) calls MySQL's library function `mysql_real_escape_string`, which prepends backslashes to the following characters: `\x00`, `\n`, `\r`, `\`, `'`, `"` and `\x1a`.

This function must always (with few exceptions) be used to make data safe before sending a query to MySQL.

**Parameters**

<i>unescaped_string</i>	The string that is to be escaped.
<i>link_identifier</i>	The MySQL connection. If the link identifier is not specified, the last link opened by <a href="#">mysql_connect</a> is assumed. If no such link is found, it will try to create one as if <a href="#">mysql_connect</a> was called with no arguments. If by chance no connection is found or established, an <code>E_WARNING</code> level error is generated.

**Return Values**

Returns the escaped string, or `FALSE` on error.

**Examples****Example 20.60. Simple [mysql\\_real\\_escape\\_string](#) example**

```
<?php  
// Connect  
$link = mysql_connect('mysql_host', 'mysql_user', 'mysql_password')  
    OR die(mysql_error());  
  
// Query  
$query = sprintf("SELECT * FROM users WHERE user='%s' AND password='%s'",  
                mysql_real_escape_string($user),  
                mysql_real_escape_string($password));  
?>
```

**Example 20.61. An example SQL Injection Attack**

```
<?php
// Query database to check if there are any matching users
$query = "SELECT * FROM users WHERE user='{$_POST['username']}' AND password='{$_POST['password']}'";
mysql_query($query);

// We didn't check $_POST['password'], it could be anything the user wanted! For example:
$_POST['username'] = 'aidan';
$_POST['password'] = "' OR ''='";

// This means the query sent to MySQL would be:
echo $query;
?>
```

The query sent to MySQL:

```
SELECT * FROM users WHERE user='aidan' AND password='' OR ''=''
```

This would allow anyone to log in without a valid password.

### Example 20.62. A "Best Practice" query

Using `mysql_real_escape_string` around each variable prevents SQL Injection. This example demonstrates the "best practice" method for querying a database, independent of the [Magic Quotes](#) setting.

```
<?php
if (isset($_POST['product_name']) && isset($_POST['product_description']) && isset($_POST['user_id'])) {
    // Connect

    $link = mysql_connect('mysql_host', 'mysql_user', 'mysql_password');

    if(!is_resource($link)) {

        echo "Failed to connect to the server\n";
        // ... log the error properly

    } else {

        // Reverse magic_quotes_gpc/magic_quotes_sybase effects on those vars if ON.

        if(get_magic_quotes_gpc()) {
            $product_name = stripslashes($_POST['product_name']);
            $product_description = stripslashes($_POST['product_description']);
        } else {
            $product_name = $_POST['product_name'];
            $product_description = $_POST['product_description'];
        }

        // Make a safe query
        $query = sprintf("INSERT INTO products (`name`, `description`, `user_id`) VALUES ('%s', '%s', %d)",
            mysql_real_escape_string($product_name, $link),
            mysql_real_escape_string($product_description, $link),
            $_POST['user_id']);

        mysql_query($query, $link);

        if (mysql_affected_rows($link) > 0) {
            echo "Product inserted\n";
        }
    }
} else {
    echo "Fill the form properly\n";
}
?>
```

The query will now execute correctly, and SQL Injection attacks will not work.

#### Notes

##### ■ Note

A MySQL connection is required before using `mysql_real_escape_string` otherwise an error of level `E_WARNING` is generated, and `FALSE` is returned. If `link_identifier` isn't defined, the last MySQL connection is used.

#### Note

If `magic_quotes_gpc` is enabled, first apply `stripslashes` to the data. Using this function on data which has already been escaped will escape the data twice.

#### Note

If this function is not used to escape data, the query is vulnerable to [SQL Injection Attacks](#).

#### Note

`mysql_real_escape_string` does not escape `%` and `_`. These are wildcards in MySQL if combined with `LIKE`, `GRANT`, or `REVOKE`.

#### See Also

`mysql_client_encoding`  
`addslashes`  
`stripslashes`  
The `magic_quotes_gpc` directive  
The `magic_quotes_runtime` directive

### 20.11.1.4.43. `mysql_result`

Copyright 1997-2008 the PHP Documentation Group.

- `mysql_result`

Get result data

#### Description

```
string mysql_result(resource result,
                   int row,
                   mixed field);
```

Retrieves the contents of one cell from a MySQL result set.

When working on large result sets, you should consider using one of the functions that fetch an entire row (specified below). As these functions return the contents of multiple cells in one function call, they're MUCH quicker than `mysql_result`. Also, note that specifying a numeric offset for the field argument is much quicker than specifying a fieldname or tablename.fieldname argument.

#### Parameters

<code>result</code>	The result resource that is being evaluated. This result comes from a call to <code>mysql_query</code> .
<code>row</code>	The row number from the result that's being retrieved. Row numbers start at 0.
<code>field</code>	The name or offset of the field being retrieved.  It can be the field's offset, the field's name, or the field's table dot field name (tablename.fieldname). If the column name has been aliased ('select foo as bar from...'), use the alias instead of the column name. If undefined, the first field is retrieved.

#### Return Values

The contents of one cell from a MySQL result set on success, or `FALSE` on failure.

#### Examples

**Example 20.63. `mysql_result` example**

```

<?php
$link = mysql_connect('localhost', 'mysql_user', 'mysql_password');
if (!$link) {
    die('Could not connect: ' . mysql_error());
}
$result = mysql_query('SELECT name FROM work.employee');
if (!$result) {
    die('Could not query:' . mysql_error());
}
echo mysql_result($result, 2); // outputs third employee's name
mysql_close($link);
?>

```

**Notes****Note**

Calls to `mysql_result` should not be mixed with calls to other functions that deal with the result set.

**See Also**

[mysql\\_fetch\\_row](#)  
[mysql\\_fetch\\_array](#)  
[mysql\\_fetch\\_assoc](#)  
[mysql\\_fetch\\_object](#)

**20.11.1.4.44. `mysql_select_db`**

Copyright 1997-2008 the PHP Documentation Group.

- [mysql\\_select\\_db](#)

Select a MySQL database

**Description**

```

bool mysql_select_db(string database_name,
                    resource link_identifier);

```

Sets the current active database on the server that's associated with the specified link identifier. Every subsequent call to `mysql_query` will be made on the active database.

**Parameters**

<i>database_name</i>	The name of the database that is to be selected.
<i>link_identifier</i>	The MySQL connection. If the link identifier is not specified, the last link opened by <code>mysql_connect</code> is assumed. If no such link is found, it will try to create one as if <code>mysql_connect</code> was called with no arguments. If by chance no connection is found or established, an <code>E_WARNING</code> level error is generated.

**Return Values**

Returns `TRUE` on success or `FALSE` on failure.

**Examples****Example 20.64. `mysql_select_db` example**



```

<?php
$link = mysql_connect('localhost', 'mysql_user', 'mysql_password');
if (!$link) {
    die('Not connected : ' . mysql_error());
}

// make foo the current db
$db_selected = mysql_select_db('foo', $link);
if (!$db_selected) {
    die ('Can\'t use foo : ' . mysql_error());
}
?>

```

**Notes****Note**

For backward compatibility, the following deprecated alias may be used: `mysql_selectdb`

**See Also**

`mysql_connect`  
`mysql_pconnect`  
`mysql_query`

**20.11.1.4.45. mysql\_set\_charset**

Copyright 1997-2008 the PHP Documentation Group.

- `mysql_set_charset`

Sets the client character set

**Description**

```

bool mysql_set_charset(string charset,
                      resource link_identifier);

```

Sets the default character set for the current connection.

**Parameters**

*charset*

A valid character set name.

*link\_identifier*

The MySQL connection. If the link identifier is not specified, the last link opened by `mysql_connect` is assumed. If no such link is found, it will try to create one as if `mysql_connect` was called with no arguments. If by chance no connection is found or established, an `E_WARNING` level error is generated.

**Return Values**

Returns `TRUE` on success or `FALSE` on failure.

**Notes****Note**

This function requires MySQL 5.0.7 or later.

**Note**

This is the preferred way to change the charset. Using `mysql_query` to execute `SET NAMES . . .` is not recommended.

**See Also**

[mysql\\_client\\_encoding](#)  
List of character sets that MySQL supports

**20.11.1.4.46. mysql\_stat**

Copyright 1997-2008 the PHP Documentation Group.

- `mysql_stat`

Get current system status

**Description**

```
string mysql_stat(resource link_identifier);
```

`mysql_stat` returns the current server status.

**Parameters**

*link\_identifier* The MySQL connection. If the link identifier is not specified, the last link opened by `mysql_connect` is assumed. If no such link is found, it will try to create one as if `mysql_connect` was called with no arguments. If by chance no connection is found or established, an `E_WARNING` level error is generated.

**Return Values**

Returns a string with the status for uptime, threads, queries, open tables, flush tables and queries per second. For a complete list of other status variables, you have to use the `SHOW STATUS` SQL command. If *link\_identifier* is invalid, `NULL` is returned.

**Examples****Example 20.65. mysql\_stat example**

```
<?php
$link = mysql_connect('localhost', 'mysql_user', 'mysql_password');
$status = explode(' ', mysql_stat($link));
print_r($status);
?>
```

The above example will output something similar to:

```
Array
(
    [0] => Uptime: 5380
    [1] => Threads: 2
    [2] => Questions: 1321299
    [3] => Slow queries: 0
    [4] => Opens: 26
    [5] => Flush tables: 1
    [6] => Open tables: 17
    [7] => Queries per second avg: 245.595
)
```

**Example 20.66. Alternative mysql\_stat example**

```
<?php
$link = mysql_connect('localhost', 'mysql_user', 'mysql_password');
$result = mysql_query('SHOW VARIABLES', $link);
while ($row = mysql_fetch_assoc($result)) {
    echo $row['Variable_name'] . ' = ' . $row['Value'] . "\n";
}
?>
```

The above example will output something similar to:

```
back_log = 50
basedir = /usr/local/
bdb_cache_size = 8388600
bdb_log_buffer_size = 32768
bdb_home = /var/db/mysql/
bdb_max_lock = 10000
bdb_logdir =
bdb_shared_data = OFF
bdb_tmpdir = /var/tmp/
...
```

### See Also

[mysql\\_get\\_server\\_info](#)  
[mysql\\_list\\_processes](#)

#### 20.11.1.4.47. [mysql\\_tablename](#)

Copyright 1997-2008 the PHP Documentation Group.

- [mysql\\_tablename](#)

Get table name of field

### Description

```
string mysql_tablename(resource result,
                       int i);
```

Retrieves the table name from a *result*.

This function deprecated. It is preferable to use [mysql\\_query](#) to issue a SQL `SHOW TABLES [FROM db_name] [LIKE 'pattern']` statement instead.

### Parameters

<i>result</i>	A result pointer resource that's returned from <a href="#">mysql_list_tables</a> .
<i>i</i>	The integer index (row/table number)

### Return Values

The name of the table on success, or `FALSE` on failure.

Use the [mysql\\_tablename](#) function to traverse this result pointer, or any function for result tables, such as [mysql\\_fetch\\_array](#).

### Examples

**Example 20.67. `mysql_tablename` example**

```
<?php
mysql_connect("localhost", "mysql_user", "mysql_password");
$result = mysql_list_tables("mydb");
$num_rows = mysql_num_rows($result);
for ($i = 0; $i < $num_rows; $i++) {
    echo "Table: ", mysql_tablename($result, $i), "\n";
}

mysql_free_result($result);
?>
```

**Notes****Note**

The `mysql_num_rows` function may be used to determine the number of tables in the result pointer.

**See Also**

`mysql_list_tables`  
`mysql_field_table`  
`mysql_db_name`

**20.11.1.4.48. `mysql_thread_id`**

Copyright 1997-2008 the PHP Documentation Group.

- `mysql_thread_id`

Return the current thread ID

**Description**

```
int mysql_thread_id(resource link_identifier);
```

Retrieves the current thread ID. If the connection is lost, and a reconnect with `mysql_ping` is executed, the thread ID will change. This means only retrieve the thread ID when needed.

**Parameters**

*link\_identifier*

The MySQL connection. If the link identifier is not specified, the last link opened by `mysql_connect` is assumed. If no such link is found, it will try to create one as if `mysql_connect` was called with no arguments. If by chance no connection is found or established, an `E_WARNING` level error is generated.

**Return Values**

The thread ID on success, or `FALSE` on failure.

**Examples****Example 20.68. `mysql_thread_id` example**

```
<?php
$link = mysql_connect('localhost', 'mysql_user', 'mysql_password');
$thread_id = mysql_thread_id($link);
if ($thread_id){
    printf("current thread id is %d\n", $thread_id);
}
```

```
?>
```

The above example will output something similar to:

```
current thread id is 73
```

### See Also

[mysql\\_ping](#)  
[mysql\\_list\\_processes](#)

#### 20.11.1.4.49. [mysql\\_unbuffered\\_query](#)

Copyright 1997-2008 the PHP Documentation Group.

- [mysql\\_unbuffered\\_query](#)

Send an SQL query to MySQL, without fetching and buffering the result rows

### Description

```
resource mysql_unbuffered_query(string query,  
                               resource link_identifier);
```

[mysql\\_unbuffered\\_query](#) sends a SQL query *query* to MySQL, without fetching and buffering the result rows automatically, as [mysql\\_query](#) does. On the one hand, this saves a considerable amount of memory with SQL queries that produce large result sets. On the other hand, you can start working on the result set immediately after the first row has been retrieved: you don't have to wait until the complete SQL query has been performed. When using multiple DB-connects, you have to specify the optional parameter *link\_identifier*.

### Parameters

<i>query</i>	A SQL query
<i>link_identifier</i>	The MySQL connection. If the link identifier is not specified, the last link opened by <a href="#">mysql_connect</a> is assumed. If no such link is found, it will try to create one as if <a href="#">mysql_connect</a> was called with no arguments. If by chance no connection is found or established, an <a href="#">E_WARNING</a> level error is generated.

### Return Values

For SELECT, SHOW, DESCRIBE or EXPLAIN statements, [mysql\\_unbuffered\\_query](#) returns a resource on success, or [FALSE](#) on error.

For other type of SQL statements, UPDATE, DELETE, DROP, etc, [mysql\\_unbuffered\\_query](#) returns [TRUE](#) on success or [FALSE](#) on error.

### Notes

#### Note

The benefits of [mysql\\_unbuffered\\_query](#) come at a cost: You cannot use [mysql\\_num\\_rows](#) and [mysql\\_data\\_seek](#) on a result set returned from [mysql\\_unbuffered\\_query](#). You also have to fetch all result rows from an unbuffered SQL query, before you can send a new SQL query to MySQL.

### See Also

`mysql_query`

## 20.11.2. MySQL Improved Extension (`Mysqli`)

Copyright 1997-2008 the PHP Documentation Group.

The `mysqli` extension allows you to access the functionality provided by MySQL 4.1 and above. More information about the MySQL Database server can be found at <http://www.mysql.com/>

An overview of software available for using MySQL from PHP can be found at [Section 20.11.2.2, “Overview”](#)

Documentation for MySQL can be found at <http://dev.mysql.com/doc/>.

Parts of this documentation included from MySQL manual with permissions of MySQL AB.

### 20.11.2.1. Examples

Copyright 1997-2008 the PHP Documentation Group.

All Examples in the MySQLI documentation use the world database from MySQL AB. The world database can be found at <http://dev.mysql.com/get/Downloads/Manual/world.sql.gz/from/pick>

### 20.11.2.2. Overview

Copyright 1997-2008 the PHP Documentation Group.

This section provides an introduction to the options available to you when developing a PHP application that needs to interact with a MySQL database.

*What is an API?*

An Application Programming Interface, or API, defines the classes, methods, functions and variables that your application will need to call in order to carry out its desired task. In the case of PHP applications that need to communicate with databases the necessary APIs are usually exposed via PHP extensions.

APIs can be procedural or object-oriented. With a procedural API you call functions to carry out tasks, with the object-oriented API you instantiate classes and then call methods on the resulting objects. Of the two the latter is usually the preferred interface, as it is more modern and leads to better organised code.

When writing PHP applications that need to connect to the MySQL server there are several API options available. This document discusses what is available and how to select the best solution for your application.

*What is a Connector?*

In the MySQL documentation, the term *connector* refers to a piece of software that allows your application to connect to the MySQL database server. MySQL provides connectors for a variety of languages, including PHP.

If your PHP application needs to communicate with a database server you will need to write PHP code to perform such activities as connecting to the database server, querying the database and other database-related functions. Software is required to provide the API that your PHP application will use, and also handle the communication between your application and the database server, possibly using other intermediate libraries where necessary. This software is known generically as a connector, as it allows your application to *connect* to a database server.

*What is a Driver?*

A driver is a piece of software designed to communicate with a specific type of database server. The driver may also call a library, such as the MySQL Client Library or the MySQL Native Driver. These libraries implement the low-level protocol used to communicate with the MySQL database server.

By way of an example, the [PHP Data Objects \(PDO\)](#) database abstraction layer may use one of several database-specific drivers. One of the drivers it has available is the PDO MYSQL driver, which allows it to interface with the MySQL server.

Sometimes people use the terms connector and driver interchangeably, this can be confusing. In the MySQL-related documentation the term “driver” is reserved for software that provides the database-specific part of a connector package.

*What is an Extension?*

In the PHP documentation you will come across another term - *extension*. The PHP code consists of a core, with optional extensions to the core functionality. PHP's MySQL-related extensions, such as the `mysqli` extension, and the `mysql` extension, are im-

plemented using the PHP extension framework.

An extension typically exposes an API to the PHP programmer, to allow its facilities to be used programmatically. However, some extensions which use the PHP extension framework do not expose an API to the PHP programmer.

The PDO MySQL driver extension, for example, does not expose an API to the PHP programmer, but provides an interface to the PDO layer above it.

The terms API and extension should not be taken to mean the same thing, as an extension may not necessarily expose an API to the programmer.

*What are the main PHP API offerings for using MySQL?*

There are three main API options when considering connecting to a MySQL database server:

- PHP's MySQL Extension
- PHP's mysqli Extension
- PHP Data Objects (PDO)

Each has its own advantages and disadvantages. The following discussion aims to give a brief introduction to the key aspects of each API.

*What is PHP's MySQL Extension?*

This is the original extension designed to allow you to develop PHP applications that interact with a MySQL database. The `mysql` extension provides a procedural interface and is intended for use only with MySQL versions older than 4.1.3. This extension can be used with versions of MySQL 4.1.3 or newer, but not all of the latest MySQL server features will be available.

**Note**

If you are using MySQL versions 4.1.3 or later it is *strongly* recommended that you use the `mysqli` extension instead.

The `mysql` extension source code is located in the PHP extension directory `ext/mysql`.

For further information on the `mysql` extension, see [Section 20.11.1, “MySQL”](#).

*What is PHP's mysqli Extension?*

The `mysqli` extension, or as it is sometimes known, the MySQL *improved* extension, was developed to take advantage of new features found in MySQL systems versions 4.1.3 and newer. The `mysqli` extension is included with PHP versions 5 and later.

The `mysqli` extension has a number of benefits, the key enhancements over the `mysql` extension being:

- Object-oriented interface
- Support for Prepared Statements
- Support for Multiple Statements
- Support for Transactions
- Enhanced debugging capabilities
- Embedded server support

**Note**

If you are using MySQL versions 4.1.3 or later it is *strongly* recommended that you use this extension.

As well as the object-oriented interface the extension also provides a procedural interface.

The `mysqli` extension is built using the PHP extension framework, its source code is located in the directory `ext/mysqli`.

For further information on the `mysqli` extension, see [Section 20.11.2, “MySQL Improved Extension \(mysqli\)”](#).

*What is PDO?*

PHP Data Objects, or PDO, is a database abstraction layer specifically for PHP applications. PDO provides a consistent API for your PHP application regardless of the type of database server your application will connect to. In theory, if you are using the PDO API, you could switch the database server you used, from say Firebird to MySQL, and only need to make minor changes to your PHP code.

Other examples of database abstraction layers include JDBC for Java applications and DBI for Perl.

While PDO has its advantages, such as a clean, simple, portable API, its main disadvantage is that it doesn't allow you to use all of the advanced features that are available in the latest versions of MySQL server. For example, PDO does not allow you to use MySQL's support for Multiple Statements.

PDO is implemented using the PHP extension framework, its source code is located in the directory `ext/pdo`.

For further information on PDO, see the [Section 20.11.3, "MySQL Functions \(PDO\\_MYSQL\)"](#).

*What is the PDO MYSQL driver?*

The PDO MYSQL driver is not an API as such, at least from the PHP programmer's perspective. In fact the PDO MYSQL driver sits in the layer below PDO itself and provides MySQL-specific functionality. The programmer still calls the PDO API, but PDO uses the PDO MYSQL driver to carry out communication with the MySQL server.

The PDO MYSQL driver is one of several available PDO drivers. Other PDO drivers available include those for the Firebird and PostgreSQL database servers.

The PDO MYSQL driver is implemented using the PHP extension framework. Its source code is located in the directory `ext/pdo_mysql`. It does not expose an API to the PHP programmer.

For further information on the PDO MYSQL driver, see [Section 20.11.3, "MySQL Functions \(PDO\\_MYSQL\)"](#).

*What is PHP's MySQL Native Driver?*

In order to communicate with the MySQL database server the `mysql` extension, `mysqli` and the PDO MYSQL driver each use a low-level library that implements the required protocol. In the past, the only available library was the MySQL Client Library, otherwise known as `libmysql`.

However, the interface presented by `libmysql` was not optimized for communication with PHP applications, as `libmysql` was originally designed with C applications in mind. For this reason the MySQL Native Driver, `mysqlnd`, was developed as an alternative to `libmysql` for PHP applications.

The `mysql` extension, the `mysqli` extension and the PDO MySQL driver can each be individually configured to use either `libmysql` or `mysqlnd`. As `mysqlnd` is designed specifically to be utilised in the PHP system it has numerous memory and speed enhancements over `libmysql`. You are strongly encouraged to take advantage of these improvements.

### Note

The MySQL Native Driver can only be used with MySQL server versions 4.1.3 and later.

The MySQL Native Driver is implemented using the PHP extension framework. The source code is located in `ext/mysqlnd`. It does not expose an API to the PHP programmer.

### Comparison of Features

The following table compares the functionality of the three main methods of connecting to MySQL from PHP:

	PHP's <code>mysqli</code> Extension	PDO (Using PDO MySQL Driver and MySQL Native Driver)	PHP's MySQL Extension
PHP version introduced	5.0	5.0	Prior to 3.0
Included with PHP 5.x	yes	yes	Yes
Comes with PHP 6.0	Yes	Yes	Yes
MySQL development status	Active development	Active development as of PHP 5.3	Maintenance only
Recommended by MySQL for new projects	Yes - preferred option	Yes	No
API supports Charsets	Yes	Yes	No
API supports server-side Prepared Statements	Yes	Yes	No



	PHP's <code>mysqli</code> Extension	PDO (Using PDO MySQL Driver and MySQL Native Driver)	PHP's MySQL Extension
API supports client-side Prepared Statements	No	Yes	No
API supports Stored Procedures	Yes	Yes	No
API supports Multiple Statements	Yes	Most	No
Supports all MySQL 4.1+ functionality	Yes	Most	No

### 20.11.2.3. Installing/Configuring

Copyright 1997-2008 the PHP Documentation Group.

#### 20.11.2.3.1. Requirements

Copyright 1997-2008 the PHP Documentation Group.

In order to have these functions available, you must compile PHP with support for the `mysqli` extension.

#### Note

The `mysqli` extension is designed to work with the version 4.1.3 or above of MySQL. For previous versions, please see the [MySQL](#) extension documentation.

#### 20.11.2.3.2. Installation

Copyright 1997-2008 the PHP Documentation Group.

To install the `mysqli` extension for PHP, use the `--with-mysqli=mysql_config_path/mysql_config` configuration option where `mysql_config_path` represents the location of the `mysql_config` program that comes with MySQL versions greater than 4.1.

If you would like to install the `mysql` extension along with the `mysqli` extension you have to use the same client library to avoid any conflicts.

#### 20.11.2.3.2.1. Installation on Windows Systems

Copyright 1997-2008 the PHP Documentation Group.

MySQLi is not enabled by default, so the `php_mysqli.dll` DLL must be enabled inside of `php.ini`. Also, PHP needs access to the MySQL client library. A file named `libmysql.dll` is included in the Windows PHP distribution and in order for PHP to talk to MySQL this file needs to be available to the Windows systems `PATH`. See the FAQ titled "[How do I add my PHP directory to the PATH on Windows](#)" for information on how to do this. Although copying `libmysql.dll` to the Windows system directory also works (because the system directory is by default in the system's `PATH`), it's not recommended.

As with enabling any PHP extension (such as `php_mysqli.dll`), the PHP directive `extension_dir` should be set to the directory where the PHP extensions are located. See also the [Manual Windows Installation Instructions](#). An example `extension_dir` value for PHP 5 is `c:\php\ext`

#### Note

If when starting the web server an error similar to the following occurs: "Unable to load dynamic library '.\php\_mysqli.dll'", this is because `php_mysqli.dll` and/or `libmysql.dll` cannot be found by the system.

#### 20.11.2.3.3. Runtime Configuration

Copyright 1997-2008 the PHP Documentation Group.

The behaviour of these functions is affected by settings in `php.ini`.

**Table 20.7. MySQLi Configuration Options**

Name	Default	Changeable	Changelog
mysqli.max_links	"-1"	PHP_INI_SYSTEM	Available since PHP 5.0.0.
mysqli.default_port	"3306"	PHP_INI_ALL	Available since PHP 5.0.0.
mysqli.default_socket	NULL	PHP_INI_ALL	Available since PHP 5.0.0.
mysqli.default_host	NULL	PHP_INI_ALL	Available since PHP 5.0.0.
mysqli.default_user	NULL	PHP_INI_ALL	Available since PHP 5.0.0.
mysqli.default_pw	NULL	PHP_INI_ALL	Available since PHP 5.0.0.

For further details and definitions of the above `PHP_INI_*` constants, see the chapter on [configuration changes](#).

Here's a short explanation of the configuration directives.

<code>mysqli.max_links</code> integer	The maximum number of MySQL connections per process.
<code>mysqli.default_port</code> string	The default TCP port number to use when connecting to the database server if no other port is specified. If no default is specified, the port will be obtained from the <code>MYSQL_TCP_PORT</code> environment variable, the <code>mysql-tcp</code> entry in <code>/etc/services</code> or the compile-time <code>MYSQL_PORT</code> constant, in that order. Win32 will only use the <code>MYSQL_PORT</code> constant.
<code>mysqli.default_socket</code> string	The default socket name to use when connecting to a local database server if no other socket name is specified.
<code>mysqli.default_host</code> string	The default server host to use when connecting to the database server if no other host is specified. Doesn't apply in <a href="#">safe mode</a> .
<code>mysqli.default_user</code> string	The default user name to use when connecting to the database server if no other name is specified. Doesn't apply in <a href="#">safe mode</a> .
<code>mysqli.default_pw</code> string	The default password to use when connecting to the database server if no other password is specified. Doesn't apply in <a href="#">safe mode</a> .

#### 20.11.2.3.4. Resource Types

Copyright 1997-2008 the PHP Documentation Group.

This extension has no resource types defined.

#### 20.11.2.4. Predefined Constants

Copyright 1997-2008 the PHP Documentation Group.

<code>MYSQLI_READ_DEFAULT_GROUP</code>	Read options from the named group from <code>my.cnf</code> or the file specified with <code>MYSQLI_READ_DEFAULT_FILE</code>
<code>MYSQLI_READ_DEFAULT_FILE</code>	Read options from the named option file instead of from <code>my.cnf</code>
<code>MYSQLI_OPT_CONNECT_TIMEOUT</code>	Connect timeout in seconds
<code>MYSQLI_OPT_LOCAL_INFILE</code>	Enables command <code>LOAD LOCAL INFILE</code>
<code>MYSQLI_INIT_COMMAND</code>	Command to execute when connecting to MySQL server. Will automatically be re-executed when reconnecting.
<code>MYSQLI_CLIENT_SSL</code>	Use SSL (encrypted protocol). This option should not be set by application programs; it is set internally in the MySQL client library
<code>MYSQLI_CLIENT_COMPRESS</code>	Use compression protocol
<code>MYSQLI_CLIENT_INTERACTIVE</code>	Allow <code>interactive_timeout</code> seconds (instead of <code>wait_timeout</code> seconds) of inactivity before closing the connection. The client's session <code>wait_timeout</code> variable will be set to the value of the session <code>interactive_timeout</code> variable.
<code>MYSQLI_CLIENT_IGNORE_SPACE</code>	Allow spaces after function names. Makes all functions names reserved words.

<code>MYSQLI_CLIENT_NO_SCHEMA</code>	Don't allow the <code>db_name.tbl_name.col_name</code> syntax.
<code>MYSQLI_CLIENT_MULTI_QUERIES</code>	Allows multiple semicolon-delimited queries in a single <code>mysqli_query</code> call.
<code>MYSQLI_STORE_RESULT</code>	For using buffered resultsets
<code>MYSQLI_USE_RESULT</code>	For using unbuffered resultsets
<code>MYSQLI_ASSOC</code>	Columns are returned into the array having the fieldname as the array index.
<code>MYSQLI_NUM</code>	Columns are returned into the array having an enumerated index.
<code>MYSQLI_BOTH</code>	Columns are returned into the array having both a numerical index and the fieldname as the associative index.
<code>MYSQLI_NOT_NULL_FLAG</code>	Indicates that a field is defined as <code>NOT NULL</code>
<code>MYSQLI_PRI_KEY_FLAG</code>	Field is part of a primary index
<code>MYSQLI_UNIQUE_KEY_FLAG</code>	Field is part of a unique index.
<code>MYSQLI_MULTIPLE_KEY_FLAG</code>	Field is part of an index.
<code>MYSQLI_BLOB_FLAG</code>	Field is defined as <code>BLOB</code>
<code>MYSQLI_UNSIGNED_FLAG</code>	Field is defined as <code>UNSIGNED</code>
<code>MYSQLI_ZEROFILL_FLAG</code>	Field is defined as <code>ZEROFILL</code>
<code>MYSQLI_AUTO_INCREMENT_FLAG</code>	Field is defined as <code>AUTO_INCREMENT</code>
<code>MYSQLI_TIMESTAMP_FLAG</code>	Field is defined as <code>TIMESTAMP</code>
<code>MYSQLI_SET_FLAG</code>	Field is defined as <code>SET</code>
<code>MYSQLI_NUM_FLAG</code>	Field is defined as <code>NUMERIC</code>
<code>MYSQLI_PART_KEY_FLAG</code>	Field is part of an multi-index
<code>MYSQLI_GROUP_FLAG</code>	Field is part of <code>GROUP BY</code>
<code>MYSQLI_TYPE_DECIMAL</code>	Field is defined as <code>DECIMAL</code>
<code>MYSQLI_TYPE_NEWDECIMAL</code>	Precision math <code>DECIMAL</code> or <code>NUMERIC</code> field (MySQL 5.0.3 and up)
<code>MYSQLI_TYPE_BIT</code>	Field is defined as <code>BIT</code> (MySQL 5.0.3 and up)
<code>MYSQLI_TYPE_TINY</code>	Field is defined as <code>TINYINT</code>
<code>MYSQLI_TYPE_SHORT</code>	Field is defined as <code>SMALLINT</code>
<code>MYSQLI_TYPE_LONG</code>	Field is defined as <code>INT</code>
<code>MYSQLI_TYPE_FLOAT</code>	Field is defined as <code>FLOAT</code>
<code>MYSQLI_TYPE_DOUBLE</code>	Field is defined as <code>DOUBLE</code>
<code>MYSQLI_TYPE_NULL</code>	Field is defined as <code>DEFAULT NULL</code>
<code>MYSQLI_TYPE_TIMESTAMP</code>	Field is defined as <code>TIMESTAMP</code>
<code>MYSQLI_TYPE_LONGLONG</code>	Field is defined as <code>BIGINT</code>
<code>MYSQLI_TYPE_INT24</code>	Field is defined as <code>MEDIUMINT</code>
<code>MYSQLI_TYPE_DATE</code>	Field is defined as <code>DATE</code>
<code>MYSQLI_TYPE_TIME</code>	Field is defined as <code>TIME</code>
<code>MYSQLI_TYPE_DATETIME</code>	Field is defined as <code>DATETIME</code>
<code>MYSQLI_TYPE_YEAR</code>	Field is defined as <code>YEAR</code>

<code>MYSQLI_TYPE_NEWDATE</code>	Field is defined as <code>DATE</code>
<code>MYSQLI_TYPE_ENUM</code>	Field is defined as <code>ENUM</code>
<code>MYSQLI_TYPE_SET</code>	Field is defined as <code>SET</code>
<code>MYSQLI_TYPE_TINY_BLOB</code>	Field is defined as <code>TINYBLOB</code>
<code>MYSQLI_TYPE_MEDIUM_BLOB</code>	Field is defined as <code>MEDIUMBLOB</code>
<code>MYSQLI_TYPE_LONG_BLOB</code>	Field is defined as <code>LOB</code>
<code>MYSQLI_TYPE_BLOB</code>	Field is defined as <code>BLOB</code>
<code>MYSQLI_TYPE_VAR_STRING</code>	Field is defined as <code>VARCHAR</code>
<code>MYSQLI_TYPE_STRING</code>	Field is defined as <code>CHAR</code>
<code>MYSQLI_TYPE_GEOMETRY</code>	Field is defined as <code>GEOMETRY</code>
<code>MYSQLI_NEED_DATA</code>	More data available for bind variable
<code>MYSQLI_NO_DATA</code>	No more data available for bind variable
<code>MYSQLI_DATA_TRUNCATED</code>	Data truncation occurred. Available since PHP 5.1.0 and MySQL 5.0.5.
<code>MYSQLI_ENUM_FLAG</code>	Field is defined as <code>ENUM</code> . Available since PHP 5.3.0.

### 20.11.2.5. The MySQLi Extension Function Summary

Copyright 1997-2008 the PHP Documentation Group.

MySQLi Class			
OOP Interface	Procedural Interface	Alias (Do not use)	Description
<i>Properties</i>			
<code>\$mysqli-&gt;affected_rows</code>	<code>mysqli_affected_rows</code>	N/A	Gets the number of affected rows in a previous MySQL operation
<code>\$mysqli-&gt;connect_errno</code>	<code>mysqli_connect_errno</code>	N/A	Returns the error code from last connect call
<code>\$mysqli-&gt;connect_error</code>	<code>mysqli_connect_error</code>	N/A	Returns a string description of the last connect error
<code>\$mysqli-&gt;errno</code>	<code>mysqli_errno</code>	N/A	Returns the error code for the most recent function call
<code>\$mysqli-&gt;error</code>	<code>mysqli_error</code>	N/A	Returns a string description of the last error
<code>\$mysqli-&gt;field_count</code>	<code>mysqli_field_count</code>	N/A	Returns the number of columns for the most recent query
<code>\$mysqli-&gt;host_info</code>	<code>mysqli_get_host_info</code>	N/A	Returns a string representing the type of connection used
<code>\$mysqli-&gt;protocol_version</code>	<code>mysqli_get_proto_info</code>	N/A	Returns the version of the MySQL protocol used
<code>\$mysqli-&gt;server_info</code>	<code>mysqli_get_server_info</code>	N/A	Returns the version of the MySQL server
<code>\$mysqli-&gt;server_version</code>	<code>mysqli_get_server_version</code>	N/A	Returns the version of the MySQL server as an integer
<code>\$mysqli-&gt;info</code>	<code>mysqli_info</code>	N/A	Retrieves information about the most recently executed query
<code>\$mysqli-&gt;insert_id</code>	<code>mysqli_insert_id</code>	N/A	Returns the auto generated id used in the last query
<code>\$mysqli-&gt;sqlstate</code>	<code>mysqli_sqlstate</code>	N/A	Returns the SQLSTATE error from previous MySQL operation

MySQLi Class			
OOP Interface	Procedural Interface	Alias (Do not use)	Description
<code>\$mysqli-&gt;warning_count</code>	<code>mysqli_warning_count</code>	N/A	Returns the number of warnings from the last query for the given link
<i>Methods</i>			
<code>mysqli-&gt;autocommit</code>	<code>mysqli_autocommit</code>	N/A	Turns on or off auto-committing database modifications
<code>mysqli-&gt;change_user</code>	<code>mysqli_change_user</code>	N/A	Changes the user of the specified database connection
<code>mysqli-&gt;character_set_name</code> , <code>mysqli-&gt;client_encoding</code>	<code>mysqli_character_set_name</code>	<code>mysqli_client_encoding</code>	Returns the default character set for the database connection
<code>mysqli-&gt;close</code>	<code>mysqli_close</code>	N/A	Closes a previously opened database connection
<code>mysqli-&gt;commit</code>	<code>mysqli_commit</code>	N/A	Commits the current transaction
<code>mysqli::__construct</code>	<code>mysqli_connect</code>	N/A	Open a new connection to the MySQL server [Note: static (i.e. class) method]
<code>mysqli-&gt;debug</code>	<code>mysqli_debug</code>	N/A	Performs debugging operations
<code>mysqli-&gt;dump_debug_info</code>	<code>mysqli_dump_debug_info</code>	N/A	Dump debugging information into the log
<code>mysqli-&gt;get_charset</code>	<code>mysqli_get_charset</code>	N/A	Returns a character set object
<code>mysqli-&gt;get_client_info</code>	<code>mysqli_get_client_info</code>	N/A	Returns the MySQL client version as a string
<code>mysqli-&gt;get_client_version</code>	<code>mysqli_get_client_version</code>	N/A	Get MySQL client info
<code>\$mysqli-&gt;get_connection_stats()</code>	<code>mysqli_get_connection_stats()</code>	N/A	NOT DOCUMENTED [mysqli only]
<code>mysqli-&gt;get_server_info</code>	<code>mysqli_get_server_info</code>	N/A	NOT DOCUMENTED
<code>mysqli-&gt;get_warnings</code>	<code>mysqli_get_warnings</code>	N/A	NOT DOCUMENTED
<code>mysqli_init</code>	<code>mysqli_init</code>	N/A	Initializes MySQLi and returns a resource for use with <code>mysqli_real_connect</code> . [Not called on an object, as it returns a <code>\$mysqli</code> object.]
<code>mysqli-&gt;kill</code>	<code>mysqli_kill</code>	N/A	Asks the server to kill a MySQL thread
<code>mysqli-&gt;more_results</code>	<code>mysqli_more_results</code>	N/A	Check if there are any more query results from a multi query
<code>mysqli-&gt;multi_query</code>	<code>mysqli_multi_query</code>	N/A	Performs a query on the database
<code>mysqli-&gt;next_result</code>	<code>mysqli_next_result</code>	N/A	Prepare next result from multi_query
<code>mysqli-&gt;options</code>	<code>mysqli_options</code>	<code>mysqli_set_opt</code>	Set options
<code>mysqli-&gt;ping</code>	<code>mysqli_ping</code>	N/A	Pings a server connection, or tries to reconnect if the connection has gone down
<code>mysqli-&gt;prepare</code>	<code>mysqli_prepare</code>	N/A	Prepare a SQL statement for execution
<code>mysqli-&gt;query</code>	<code>mysqli_query</code>	N/A	Performs a query on the database
<code>mysqli-&gt;real_connect</code>	<code>mysqli_real_connect</code>	N/A	Opens a connection to a mysql server

MySQLi Class			
OOP Interface	Procedural Interface	Alias (Do not use)	Description
<code>mysqli-&gt;real_escape_string</code> , <code>mysqli-&gt;escape_string</code>	<code>mysqli_real_escape_string</code>	<code>mysqli_escape_string</code>	Escapes special characters in a string for use in a SQL statement, taking into account the current charset of the connection
<code>mysqli-&gt;real_query</code>	<code>mysqli_real_query</code>	N/A	Execute an SQL query
<code>mysqli-&gt;rollback</code>	<code>mysqli_rollback</code>	N/A	Rolls back current transaction
<code>mysqli-&gt;select_db</code>	<code>mysqli_select_db</code>	N/A	Selects the default database for database queries
<code>mysqli-&gt;set_charset</code>	<code>mysqli_set_charset</code>	N/A	Sets the default client character set
<code>mysqli-&gt;set_local_infile_default</code>	<code>mysqli_set_local_infile_default</code>	N/A	Unsets user defined handler for load local infile command
<code>mysqli-&gt;set_local_infile_handler</code>	<code>mysqli_set_local_infile_handler</code>	N/A	Set callback function for LOAD DATA LOCAL INFILE command
<code>mysqli-&gt;ssl_set</code>	<code>mysqli_ssl_set</code>	N/A	Used for establishing secure connections using SSL
<code>mysqli-&gt;stat</code>	<code>mysqli_stat</code>	N/A	Gets the current system status
<code>mysqli-&gt;stmt_init</code>	<code>mysqli_stmt_init</code>	N/A	Initializes a statement and returns an object for use with <code>mysqli_stmt_prepare</code>
<code>mysqli-&gt;store_result</code>	<code>mysqli_store_result</code>	N/A	Transfers a result set from the last query
<code>mysqli-&gt;thread_id</code>	<code>mysqli_thread_id</code>	N/A	Returns the thread ID for the current connection
<code>mysqli-&gt;thread_safe</code>	<code>mysqli_thread_safe</code>	N/A	Returns whether thread safety is given or not
<code>mysqli-&gt;use_result</code>	<code>mysqli_use_result</code>	N/A	Initiate a result set retrieval

MySQL_STMT			
OOP Interface	Procedural Interface	Alias (Do not use)	Description
<i>Properties</i>			
<code>\$mysqli_stmt-&gt;affected_rows</code>	<code>mysqli_stmt_affected_rows</code>	N/A	Returns the total number of rows changed, deleted, or inserted by the last executed statement
<code>\$mysqli_stmt-&gt;errno</code>	<code>mysqli_stmt_errno</code>	N/A	Returns the error code for the most recent statement call
<code>\$mysqli_stmt-&gt;error</code>	<code>mysqli_stmt_error</code>	N/A	Returns a string description for last statement error
<code>\$mysqli_stmt-&gt;field_count</code>	<code>mysqli_stmt_field_count</code>	N/A	Returns the number of field in the given statement - not documented
<code>\$mysqli_stmt-&gt;insert_id</code>	<code>mysqli_stmt_insert_id</code>	N/A	Get the ID generated from the previous INSERT operation
<code>\$mysqli_stmt-&gt;num_rows</code>	<code>mysqli_stmt_num_rows</code>	N/A	Return the number of rows in statements result set
<code>\$mysqli_stmt-&gt;param_count</code>	<code>mysqli_stmt_param_count</code>	<code>mysqli_param_count</code>	Returns the number of parameter for the given statement
<code>\$mysqli_stmt-&gt;sqlstate</code>	<code>mysqli_stmt_sqlstate</code>	N/A	Returns SQLSTATE error from previous statement operation
<i>Methods</i>			

<b>MySQL_STMT</b>			
<b>OOP Interface</b>	<b>Procedural Interface</b>	<b>Alias (Do not use)</b>	<b>Description</b>
<code>mysqli_stmt-&gt;attr_get</code>	<code>mysqli_stmt_attr_get</code>	N/A	NOT DOCUMENTED
<code>mysqli_stmt-&gt;attr_set</code>	<code>mysqli_stmt_attr_set</code>	N/A	NOT DOCUMENTED
<code>mysqli_stmt-&gt;bind_param</code>	<code>mysqli_stmt_bind_param</code>	<code>mysqli_bind_param</code>	Binds variables to a prepared statement as parameters
<code>mysqli_stmt-&gt;bind_result</code>	<code>mysqli_stmt_bind_result</code>	<code>mysqli_bind_result</code>	Binds variables to a prepared statement for result storage
<code>mysqli_stmt-&gt;close</code>	<code>mysqli_stmt_close</code>	N/A	Closes a prepared statement
<code>mysqli_stmt-&gt;data_seek</code>	<code>mysqli_stmt_data_seek</code>	N/A	Seeks to an arbitrary row in statement result set
<code>mysqli_stmt-&gt;execute</code>	<code>mysqli_stmt_execute</code>	<code>mysqli_execute</code>	Executes a prepared Query
<code>mysqli_stmt-&gt;fetch</code>	<code>mysqli_stmt_fetch</code>	<code>mysqli_fetch</code>	Fetch results from a prepared statement into the bound variables
<code>mysqli_stmt-&gt;free_result</code>	<code>mysqli_stmt_free_result</code>	N/A	Frees stored result memory for the given statement handle
<code>\$mysqli_stmt-&gt;get_result()</code>	<code>mysqli_stmt_get_result</code>	N/A	NOT DOCUMENTED [mysqli only]
<code>mysqli_stmt-&gt;get_warnings</code>	<code>mysqli_stmt_get_warnings</code>	N/A	NOT DOCUMENTED
<code>\$mysqli_stmt-&gt;more_results()</code>	<code>mysqli_stmt_more_results()</code>	N/A	NOT DOCUMENTED [mysqli only]
<code>\$mysqli_stmt-&gt;next_result()</code>	<code>mysqli_stmt_next_result()</code>	N/A	NOT DOCUMENTED [mysqli only]
<code>mysqli_stmt-&gt;num_rows</code>	<code>mysqli_stmt_num_rows</code>	N/A	NOT DOCUMENTED [see also num_rows property]
<code>mysqli_stmt-&gt;prepare</code>	<code>mysqli_stmt_prepare</code>	N/A	Prepare a SQL statement for execution
<code>mysqli_stmt-&gt;reset</code>	<code>mysqli_stmt_reset</code>	N/A	Resets a prepared statement
<code>mysqli_stmt-&gt;result_metadata</code>	<code>mysqli_stmt_result_metadata</code>	<code>mysqli_get_metadata</code>	Returns result set metadata from a prepared statement
<code>mysqli_stmt-&gt;send_long_data</code>	<code>mysqli_stmt_send_long_data</code>	<code>mysqli_send_long_data</code>	Send data in blocks
<code>mysqli_stmt-&gt;store_result</code>	<code>mysqli_stmt_store_result</code>	N/A	Transfers a result set from a prepared statement

<b>MySQLi_RESULT</b>			
<b>OOP Interface</b>	<b>Procedural Interface</b>	<b>Alias (Do not use)</b>	<b>Description</b>
<i>Properties</i>			
<code>\$mysqli_result-&gt;current_field</code>	<code>mysqli_field_tell</code>	N/A	Get current field offset of a result pointer
<code>\$mysqli_result-&gt;field_count</code>	<code>mysqli_num_fields</code>	N/A	Get the number of fields in a result
<code>\$mysqli_result-&gt;lengths</code>	<code>mysqli_fetch_lengths</code>	N/A	Returns the lengths of the columns of the current row in the result set
<code>\$mysqli_result-&gt;num_rows</code>	<code>mysqli_num_rows</code>	N/A	Gets the number of rows in a result
<i>Methods</i>			
<code>mysqli_result-&gt;data_seek</code>	<code>mysqli_data_seek</code>	N/A	Adjusts the result pointer to an arbitrary row in the result
<code>\$mysqli_result-&gt;fetch_all()</code>	<code>mysqli_fetch_all()</code>	N/A	NOT DOCUMENTED [mysqli only]
<code>mysqli_result-&gt;fetch_</code>	<code>mysqli_fetch_array</code>	N/A	Fetch a result row as an associ-

MySQLi_RESULT			
OOP Interface	Procedural Interface	Alias (Do not use)	Description
<code>array</code>			ative, a numeric array, or both
<code>mysqli_result-&gt;fetch_assoc</code>	<code>mysqli_fetch_assoc</code>	N/A	Fetch a result row as an associative array
<code>mysqli_result-&gt;fetch_field_direct</code>	<code>mysqli_fetch_field_direct</code>	N/A	Fetch meta-data for a single field
<code>mysqli_result-&gt;fetch_field</code>	<code>mysqli_fetch_field</code>	N/A	Returns the next field in the result set
<code>mysqli_result-&gt;fetch_fields</code>	<code>mysqli_fetch_fields</code>	N/A	Returns an array of objects representing the fields in a result set
<code>mysqli_result-&gt;fetch_object</code>	<code>mysqli_fetch_object</code>	N/A	Returns the current row of a result set as an object
<code>mysqli_result-&gt;fetch_row</code>	<code>mysqli_fetch_row</code>	N/A	Get a result row as an enumerated array
<code>mysqli_result-&gt;field_seek</code>	<code>mysqli_field_seek</code>	N/A	Set result pointer to a specified field offset
<code>mysqli_result-&gt;free,</code> <code>mysqli_result-&gt;close,</code> <code>mysqli_result-&gt;free_result</code>	<code>mysqli_free_result</code>	N/A	Frees the memory associated with a result

MySQL_Driver			
OOP Interface	Procedural Interface	Alias (Do not use)	Description
<i>Properties</i>			
N/A			
<i>Methods</i>			
<code>mysqli_driver-&gt;embedded_server_end</code>	<code>mysqli_embedded_server_end</code>	N/A	NOT DOCUMENTED
<code>mysqli_driver-&gt;embedded_server_start</code>	<code>mysqli_embedded_server_start</code>	N/A	NOT DOCUMENTED

**Note**

Alias functions are provided for backward compatibility purposes only. Do not use them in new projects.

**20.11.2.6. The MySQLi class (MySQLi)**

Copyright 1997-2008 the PHP Documentation Group.

Represents a connection between PHP and a MySQL database.

```

MySQLi {
    MySQLi

    Properties

    int affected_rows ;

    string connect_errno ;

    string connect_error ;

    int errno ;

    string error ;

    int field_count ;

```



```
string host_info ;

string protocol_version ;

string server_info ;

int server_version ;

string info ;

int insert_id ;

string sqlstate ;

int thread_id ;

int warning_count ;

Methods

int mysqli_affected_rows(mysqli link);

bool mysqli::autocommit(bool mode);

bool mysqli::change_user(string user,
                          string password,
                          string database);

string mysqli::character_set_name();

bool mysqli::close();

bool mysqli::commit();

int mysqli_connect_errno();

string mysqli_connect_error();

mysqli mysqli_connect(string host,
                      string username,
                      string passwd,
                      string dbname,
                      int port,
                      string socket);

bool mysqli::debug(string message);

bool mysqli::dump_debug_info();

int mysqli_errno(mysqli link);

string mysqli_error(mysqli link);

int mysqli_field_count(mysqli link);

object mysqli::get_charset();

string mysqli::get_client_info();

int mysqli::get_client_version();

string mysqli_get_host_info(mysqli link);
```

```
int mysqli_get_proto_info(mysqli link);

string mysqli_get_server_info(mysqli link);

int mysqli_get_server_version(mysqli link);

object mysqli::get_warnings();

string mysqli_info(mysqli link);

mysqli init();

int mysqli_insert_id(mysqli link);

bool mysqli::kill(int processid);

bool mysqli::more_results();

bool mysqli::multi_query(string query);

bool mysqli::next_result();

bool mysqli::options(int option,
                    mixed value);

bool mysqli::ping();

mysqli_stmt prepare(string query);

mixed mysqli::query(string query,
                   int resultmode);

bool mysqli::real_connect(string host,
                        string username,
                        string passwd,
                        string dbname,
                        int port,
                        string socket,
                        int flags);

string mysqli::escape_string(string escapestr);

bool real_query(string query);

bool mysqli::rollback();

bool mysqli::select_db(string dbname);

bool mysqli::set_charset(string charset);

void mysqli_set_local_infile_default(mysqli link);

bool mysqli_set_local_infile_handler(mysqli link,
                                    callback read_func);

string mysqli_sqlstate(mysqli link);

bool mysqli::ssl_set(string key,
                   string cert,
                   string ca,
                   string capath,
                   string cipher);

string mysqli::stat();
```

```

mysqli_stmt stmt_init();

mysqli_result store_result();

int mysqli_thread_id(mysqli link);

bool mysqli_thread_safe();

mysqli_result use_result();

int mysqli_warning_count(mysqli link);
}

```

### 20.11.2.6.1. `mysqli->affected_rows`, `mysqli_affected_rows`

Copyright 1997-2008 the PHP Documentation Group.

- `mysqli->affected_rows`  
`mysqli_affected_rows`  
Gets the number of affected rows in a previous MySQL operation

#### Description

Object oriented style (property):

```

mysqli {
    int affected_rows ;
}

```

Procedural style:

```
int mysqli_affected_rows(mysqli link);
```

Returns the number of rows affected by the last `INSERT`, `UPDATE`, `REPLACE` or `DELETE` query.

For `SELECT` statements `mysqli_affected_rows` works like `mysqli_num_rows`.

#### Parameters

`link` Procedural style only: A link identifier returned by `mysqli_connect` or `mysqli_init`

#### Return Values

An integer greater than zero indicates the number of rows affected or retrieved. Zero indicates that no records were updated for an `UPDATE` statement, no rows matched the `WHERE` clause in the query or that no query has yet been executed. -1 indicates that the query returned an error.

#### Note

If the number of affected rows is greater than maximal int value, the number of affected rows will be returned as a string.

#### Examples

##### Example 20.69. Object oriented style

```

<?php
$mysqli = new mysqli("localhost", "my_user", "my_password", "world");

```

```

/* check connection */
if (mysqli_connect_errno()) {
    printf("Connect failed: %s\n", mysqli_connect_error());
    exit();
}

/* Insert rows */
$mysqli->query("CREATE TABLE Language SELECT * from CountryLanguage");
printf("Affected rows (INSERT): %d\n", $mysqli->affected_rows);

$mysqli->query("ALTER TABLE Language ADD Status int default 0");

/* update rows */
$mysqli->query("UPDATE Language SET Status=1 WHERE Percentage > 50");
printf("Affected rows (UPDATE): %d\n", $mysqli->affected_rows);

/* delete rows */
$mysqli->query("DELETE FROM Language WHERE Percentage < 50");
printf("Affected rows (DELETE): %d\n", $mysqli->affected_rows);

/* select all rows */
$result = $mysqli->query("SELECT CountryCode FROM Language");
printf("Affected rows (SELECT): %d\n", $mysqli->affected_rows);

$result->close();

/* Delete table Language */
$mysqli->query("DROP TABLE Language");

/* close connection */
$mysqli->close();
?>

```

### Example 20.70. Procedural style

```

<?php
$link = mysqli_connect("localhost", "my_user", "my_password", "world");

if (!$link) {
    printf("Can't connect to localhost. Error: %s\n", mysqli_connect_error());
    exit();
}

/* Insert rows */
mysqli_query($link, "CREATE TABLE Language SELECT * from CountryLanguage");
printf("Affected rows (INSERT): %d\n", mysqli_affected_rows($link));

mysqli_query($link, "ALTER TABLE Language ADD Status int default 0");

/* update rows */
mysqli_query($link, "UPDATE Language SET Status=1 WHERE Percentage > 50");
printf("Affected rows (UPDATE): %d\n", mysqli_affected_rows($link));

/* delete rows */
mysqli_query($link, "DELETE FROM Language WHERE Percentage < 50");
printf("Affected rows (DELETE): %d\n", mysqli_affected_rows($link));

/* select all rows */
$result = mysqli_query($link, "SELECT CountryCode FROM Language");
printf("Affected rows (SELECT): %d\n", mysqli_affected_rows($link));

mysqli_free_result($result);

/* Delete table Language */
mysqli_query($link, "DROP TABLE Language");

/* close connection */
mysqli_close($link);
?>

```

The above example will output:

```

Affected rows (INSERT): 984
Affected rows (UPDATE): 168
Affected rows (DELETE): 815
Affected rows (SELECT): 169

```

**See Also**

`mysqli_num_rows`  
`mysqli_info`

**20.11.2.6.2. `mysqli::autocommit`, `mysqli_autocommit`**

Copyright 1997-2008 the PHP Documentation Group.

- `mysqli::autocommit`  
`mysqli_autocommit`

Turns on or off auto-committing database modifications

**Description**

Object oriented style (method)

```
bool mysqli::autocommit(bool mode);
```

Procedural style:

```
bool mysqli_autocommit(mysqli link,
                        bool mode);
```

Turns on or off auto-commit mode on queries for the database connection.

To determine the current state of autocommit use the SQL command `SELECT @@autocommit`.

**Parameters**

*link* Procedural style only: A link identifier returned by `mysqli_connect` or `mysqli_init`  
*mode* Whether to turn on auto-commit or not.

**Return Values**

Returns `TRUE` on success or `FALSE` on failure.

**Notes****Note**

This function doesn't work with non transactional table types (like MyISAM or ISAM).

**Examples****Example 20.71. Object oriented style**

```
<?php
$mysqli = new mysqli("localhost", "my_user", "my_password", "world");

if (mysqli_connect_errno()) {
    printf("Connect failed: %s\n", mysqli_connect_error());
    exit();
}

/* turn autocommit on */
$mysqli->autocommit(TRUE);

if ($result = $mysqli->query("SELECT @@autocommit")) {
    $row = $result->fetch_row();
    printf("Autocommit is %s\n", $row[0]);
    $result->free();
}

/* close connection */
```

```
$mysqli->close();
?>
```

### Example 20.72. Procedural style

```
<?php
$link = mysqli_connect("localhost", "my_user", "my_password", "world");

if (!$link) {
    printf("Can't connect to localhost. Error: %s\n", mysqli_connect_error());
    exit();
}

/* turn autocommit on */
mysqli_autocommit($link, TRUE);

if ($result = mysqli_query($link, "SELECT @@autocommit")) {
    $row = mysqli_fetch_row($result);
    printf("Autocommit is %s\n", $row[0]);
    mysqli_free_result($result);
}

/* close connection */
mysqli_close($link);
?>
```

The above example will output:

```
Autocommit is 1
```

#### See Also

[mysqli\\_commit](#)  
[mysqli\\_rollback](#)

### 20.11.2.6.3. [mysqli::change\\_user](#), [mysqli\\_change\\_user](#)

Copyright 1997-2008 the PHP Documentation Group.

- [mysqli::change\\_user](#)  
[mysqli\\_change\\_user](#)

Changes the user of the specified database connection

#### Description

Object oriented style (method):

```
bool mysqli::change_user(string user,
                        string password,
                        string database);
```

Procedural style:

```
bool mysqli_change_user(mysqli link,
                        string user,
                        string password,
                        string database);
```

Changes the user of the specified database connection and sets the current database.

In order to successfully change users a valid *username* and *password* parameters must be provided and that user must have sufficient permissions to access the desired database. If for any reason authorization fails, the current user authentication will remain.

### Parameters

<i>link</i>	Procedural style only: A link identifier returned by <code>mysqli_connect</code> or <code>mysqli_init</code>
<i>user</i>	The MySQL user name.
<i>password</i>	The MySQL password.
<i>database</i>	The database to change to.

If desired, the `NULL` value may be passed resulting in only changing the user and not selecting a database. To select a database in this case use the `mysqli_select_db` function.

### Return Values

Returns `TRUE` on success or `FALSE` on failure.

### Notes

#### Note

Using this command will always cause the current database connection to behave as if was a completely new database connection, regardless of if the operation was completed successfully. This reset includes performing a rollback on any active transactions, closing all temporary tables, and unlocking all locked tables.

### Examples

#### Example 20.73. Object oriented style

```
<?php
/* connect database test */
$mysqli = new mysqli("localhost", "my_user", "my_password", "test");

/* check connection */
if (mysqli_connect_errno()) {
    printf("Connect failed: %s\n", mysqli_connect_error());
    exit();
}

/* Set Variable a */
$mysqli->query("SET @a:=1");

/* reset all and select a new database */
$mysqli->change_user("my_user", "my_password", "world");

if ($result = $mysqli->query("SELECT DATABASE()")) {
    $row = $result->fetch_row();
    printf("Default database: %s\n", $row[0]);
    $result->close();
}

if ($result = $mysqli->query("SELECT @a")) {
    $row = $result->fetch_row();
    if ($row[0] === NULL) {
        printf("Value of variable a is NULL\n");
    }
    $result->close();
}

/* close connection */
$mysqli->close();
?>
```

#### Example 20.74. Procedural style

```

<?php
/* connect database test */
$link = mysqli_connect("localhost", "my_user", "my_password", "test");

/* check connection */
if (!$link) {
    printf("Connect failed: %s\n", mysqli_connect_error());
    exit();
}

/* Set Variable a */
mysqli_query($link, "SET @a:=1");

/* reset all and select a new database */
mysqli_change_user($link, "my_user", "my_password", "world");

if ($result = mysqli_query($link, "SELECT DATABASE())) {
    $row = mysqli_fetch_row($result);
    printf("Default database: %s\n", $row[0]);
    mysqli_free_result($result);
}

if ($result = mysqli_query($link, "SELECT @a")) {
    $row = mysqli_fetch_row($result);
    if ($row[0] === NULL) {
        printf("Value of variable a is NULL\n");
    }
    mysqli_free_result($result);
}

/* close connection */
mysqli_close($link);
?>

```

The above example will output:

```

Default database: world
Value of variable a is NULL

```

### See Also

[mysqli\\_connect](#)  
[mysqli\\_select\\_db](#)

#### 20.11.2.6.4. `mysqli::character_set_name`, `mysqli_character_set_name`

Copyright 1997-2008 the PHP Documentation Group.

- [mysqli::character\\_set\\_name](#)  
[mysqli\\_character\\_set\\_name](#)

Returns the default character set for the database connection

### Description

Object oriented style (method):

```
string mysqli::character_set_name();
```

Procedural style:

```
string mysqli_character_set_name(mysqli link);
```

Returns the current character set for the database connection.

### Parameters



[link](#)Procedural style only: A link identifier returned by `mysqli_connect` or `mysqli_init`**Return Values**

The default character set for the current connection

**Examples****Example 20.75. Object oriented style**

```
<?php
/* Open a connection */
$mysqli = new mysqli("localhost", "my_user", "my_password", "world");

/* check connection */
if (mysqli_connect_errno()) {
    printf("Connect failed: %s\n", mysqli_connect_error());
    exit();
}

/* Print current character set */
$charset = $mysqli->character_set_name();
printf ("Current character set is %s\n", $charset);

$mysqli->close();
?>
```

**Example 20.76. Procedural style**

```
<?php
/* Open a connection */
$link = mysqli_connect("localhost", "my_user", "my_password", "world");

/* check connection */
if (!$link) {
    printf("Connect failed: %s\n", mysqli_connect_error());
    exit();
}

/* Print current character set */
$charset = mysqli_character_set_name($link);
printf ("Current character set is %s\n", $charset);

/* close connection */
mysqli_close($link);
?>
```

The above example will output:

```
Current character set is latin1_swedish_ci
```

**See Also**

[mysqli\\_client\\_encoding](#)  
[mysqli\\_real\\_escape\\_string](#)

**20.11.2.6.5. `mysqli::close`, `mysqli_close`**

Copyright 1997-2008 the PHP Documentation Group.

- `mysqli::close`

`mysqli_close`

Closes a previously opened database connection

### Description

Object oriented style (method):

```
bool mysqli::close();
```

Procedural style:

```
bool mysqli_close(mysqli link);
```

Closes a previously opened database connection.

### Parameters

*link*

Procedural style only: A link identifier returned by `mysqli_connect` or `mysqli_init`

### Return Values

Returns `TRUE` on success or `FALSE` on failure.

### See Also

`mysqli_connect`

`mysqli_init`

`mysqli_real_connect`

## 20.11.2.6.6. `mysqli::commit`, `mysqli_commit`

Copyright 1997-2008 the PHP Documentation Group.

- `mysqli::commit`

`mysqli_commit`

Commits the current transaction

### Description

Object oriented style (method)

```
bool mysqli::commit();
```

Procedural style:

```
bool mysqli_commit(mysqli link);
```

Commits the current transaction for the database connection.

### Parameters

*link*

Procedural style only: A link identifier returned by `mysqli_connect` or `mysqli_init`

### Return Values

Returns **TRUE** on success or **FALSE** on failure.

### Examples

#### Example 20.77. Object oriented style

```
<?php
$mysqli = new mysqli("localhost", "my_user", "my_password", "world");

/* check connection */
if (mysqli_connect_errno()) {
    printf("Connect failed: %s\n", mysqli_connect_error());
    exit();
}

$mysqli->query("CREATE TABLE Language LIKE CountryLanguage Type=InnoDB");

/* set autocommit to off */
$mysqli->autocommit(FALSE);

/* Insert some values */
$mysqli->query("INSERT INTO Language VALUES ('DEU', 'Bavarian', 'F', 11.2)");
$mysqli->query("INSERT INTO Language VALUES ('DEU', 'Swabian', 'F', 9.4)");

/* commit transaction */
$mysqli->commit();

/* drop table */
$mysqli->query("DROP TABLE Language");

/* close connection */
$mysqli->close();
?>
```

#### Example 20.78. Procedural style

```
<?php
$link = mysqli_connect("localhost", "my_user", "my_password", "test");

/* check connection */
if (!$link) {
    printf("Connect failed: %s\n", mysqli_connect_error());
    exit();
}

/* set autocommit to off */
mysqli_autocommit($link, FALSE);

mysqli_query($link, "CREATE TABLE Language LIKE CountryLanguage Type=InnoDB");

/* Insert some values */
mysqli_query($link, "INSERT INTO Language VALUES ('DEU', 'Bavarian', 'F', 11.2)");
mysqli_query($link, "INSERT INTO Language VALUES ('DEU', 'Swabian', 'F', 9.4)");

/* commit transaction */
mysqli_commit($link);

/* close connection */
mysqli_close($link);
?>
```

### See Also

[mysqli\\_autocommit](#)  
[mysqli\\_rollback](#)

#### 20.11.2.6.7. [mysqli->connect\\_errno](#), [mysqli\\_connect\\_errno](#)

Copyright 1997-2008 the PHP Documentation Group.

- [mysqli->connect\\_errno](#)

`mysqli_connect_errno`

Returns the error code from last connect call

### Description

```
mysqli {
    string connect_errno ;
}
```

```
int mysqli_connect_errno();
```

Returns the last error code number from the last call to `mysqli_connect`.

### Note

Client error message numbers are listed in the MySQL `errmsg.h` header file, server error message numbers are listed in `mysqld_error.h`. In the MySQL source distribution you can find a complete list of error messages and error numbers in the file `Docs/mysqld_error.txt`.

### Return Values

An error code value for the last call to `mysqli_connect`, if it failed. zero means no error occurred.

### Examples

#### Example 20.79. `mysqli_connect_errno` example

```
<?php
$link = @mysqli_connect("localhost", "nonexisting_user", "");
if (!$link) {
    printf("Can't connect to localhost. Errorcode: %d\n", mysqli_connect_errno());
}
?>
```

### See Also

`mysqli_connect`  
`mysqli_connect_error`  
`mysqli_errno`  
`mysqli_error`  
`mysqli_sqlstate`

#### 20.11.2.6.8. `mysqli->connect_error`, `mysqli_connect_error`

Copyright 1997-2008 the PHP Documentation Group.

- `mysqli->connect_error`

`mysqli_connect_error`

Returns a string description of the last connect error

### Description

```
mysqli {
    string connect_error ;
}
```

```
}

```

```
string mysqli_connect_error();

```

Returns the last error message string from the last call to `mysqli_connect`.

### Return Values

A string that describes the error. An empty string if no error occurred.

### Examples

#### Example 20.80. `mysqli_connect_error` example

```
<?php
$link = @mysqli_connect("localhost", "nonexisting_user", "");
if (!$link) {
    printf("Can't connect to localhost. Error: %s\n", mysqli_connect_error());
}
?>

```

### See Also

`mysqli_connect`  
`mysqli_connect_errno`  
`mysqli_errno`  
`mysqli_error`  
`mysqli_sqlstate`

#### 20.11.2.6.9. `mysqli::__construct`, `mysqli_connect`

Copyright 1997-2008 the PHP Documentation Group.

- `mysqli::__construct`

`mysqli_connect`

Open a new connection to the MySQL server

### Description

Object oriented style (constructor):

```
mysqli::__construct(string host,
                    string username,
                    string passwd,
                    string dbname,
                    int port,
                    string socket);

```

Procedural style

```
mysqli mysqli_connect(string host,
                     string username,
                     string passwd,
                     string dbname,
                     int port,
                     string socket);

```

Opens a connection to the MySQL Server running on.

### Parameters

<i>host</i>	Can be either a host name or an IP address. Passing the <code>NULL</code> value or the string "localhost" to this parameter, the local host is assumed. When possible, pipes will be used instead of the TCP/IP protocol.
<i>username</i>	The MySQL user name.
<i>passwd</i>	If not provided or <code>NULL</code> , the MySQL server will attempt to authenticate the user against those user records which have no password only. This allows one username to be used with different permissions (depending on if a password as provided or not).
<i>dbname</i>	If provided will specify the default database to be used when performing queries.
<i>port</i>	Specifies the port number to attempt to connect to the MySQL server.
<i>socket</i>	Specifies the socket or named pipe that should be used.

**Note**

Specifying the *socket* parameter will not explicitly determine the type of connection to be used when connecting to the MySQL server. How the connection is made to the MySQL database is determined by the *host* parameter.

**Return Values**

Returns a object which represents the connection to a MySQL Server.

**Examples****Example 20.81. Object oriented style**

```
<?php
$mysqli = new mysqli("localhost", "my_user", "my_password", "world");

/* check connection */
if ($mysqli->connect_error) {
    printf("Connect failed: %s\n", mysqli_connect_error());
    exit();
}

printf("Host information: %s\n", $mysqli->host_info);

/* close connection */
$mysqli->close();
?>
```

**Example 20.82. Procedural style**

```
<?php
$link = mysqli_connect("localhost", "my_user", "my_password", "world");

/* check connection */
if (!$link) {
    printf("Connect failed: %s\n", mysqli_connect_error());
    exit();
}

printf("Host information: %s\n", mysqli_get_host_info($link));

/* close connection */
mysqli_close($link);
?>
```

The above example will output:

```
Host information: Localhost via UNIX socket
```

## Notes

### Note

OO syntax only: If a connection fails an object is still returned. To check if the connection failed then use the `mysqli->connect_error` property like in the examples above.

### Note

Error "Can't create TCP/IP socket (10106)" usually means that the `variables_order` configure directive doesn't contain character `E`. On Windows, if the environment is not copied the `SYSTEMROOT` environment variable won't be available and PHP will have problems loading Winsock.

## 20.11.2.6.10. `mysqli::debug`, `mysqli_debug`

Copyright 1997-2008 the PHP Documentation Group.

- `mysqli::debug`

`mysqli_debug`

Performs debugging operations

## Description

Object oriented style (method):

```
bool mysqli::debug(string message);
```

Procedural style:

```
bool mysqli_debug(string message);
```

Performs debugging operations using the Fred Fish debugging library.

## Parameters

*message* A string representing the debugging operation to perform

## Return Values

Returns `TRUE` .

## Notes

### Note

To use the `mysqli_debug` function you must compile the MySQL client library to support debugging.

## Examples

### Example 20.83. Generating a Trace File

```
<?php
/* Create a trace file in '/tmp/client.trace' on the local (client) machine: */
mysqli_debug("d:t:0,/tmp/client.trace");
?>
```

**See Also**

`mysqli_dump_debug_info`  
`mysqli_report`

**20.11.2.6.11. `mysqli::dump_debug_info`, `mysqli_dump_debug_info`**

Copyright 1997-2008 the PHP Documentation Group.

- `mysqli::dump_debug_info`  
`mysqli_dump_debug_info`

Dump debugging information into the log

**Description**

Object oriented style (method):

```
bool mysqli::dump_debug_info();
```

Procedural style:

```
bool mysqli_dump_debug_info(mysqli link);
```

This function is designed to be executed by a user with the SUPER privilege and is used to dump debugging information into the log for the MySQL Server relating to the connection.

**Parameters**

*link* Procedural style only: A link identifier returned by `mysqli_connect` or `mysqli_init`

**Return Values**

Returns `TRUE` on success or `FALSE` on failure.

**See Also**

`mysqli_debug`

**20.11.2.6.12. `mysqli->errno`, `mysqli_errno`**

Copyright 1997-2008 the PHP Documentation Group.

- `mysqli->errno`  
`mysqli_errno`

Returns the error code for the most recent function call

**Description**

Object oriented style (property):

```
mysqli {
    int errno ;
}
```

Procedural style:

```
int mysqli_errno(mysqli link);
```



Returns the last error code for the most recent MySQLi function call that can succeed or fail.

Client error message numbers are listed in the MySQL [errmsg.h](#) header file, server error message numbers are listed in [mysqld\\_error.h](#). In the MySQL source distribution you can find a complete list of error messages and error numbers in the file [Docs/mysqld\\_error.txt](#).

### Parameters

*link* Procedural style only: A link identifier returned by [mysqli\\_connect](#) or [mysqli\\_init](#)

### Return Values

An error code value for the last call, if it failed. zero means no error occurred.

### Examples

#### Example 20.84. Object oriented style

```
<?php
$mysqli = new mysqli("localhost", "my_user", "my_password", "world");

/* check connection */
if (mysqli_connect_errno()) {
    printf("Connect failed: %s\n", mysqli_connect_error());
    exit();
}

if (!$mysqli->query("SET a=1")) {
    printf("Errorcode: %d\n", $mysqli->errno);
}

/* close connection */
$mysqli->close();
?>
```

#### Example 20.85. Procedural style

```
<?php
$link = mysqli_connect("localhost", "my_user", "my_password", "world");

/* check connection */
if (mysqli_connect_errno()) {
    printf("Connect failed: %s\n", mysqli_connect_error());
    exit();
}

if (!mysqli_query($link, "SET a=1")) {
    printf("Errorcode: %d\n", mysqli_errno($link));
}

/* close connection */
mysqli_close($link);
?>
```

The above example will output:

```
Errorcode: 1193
```

### See Also

[mysqli\\_connect\\_errno](#)

```
mysqli_connect_error
mysqli_error
mysqli_sqlstate
```

### 20.11.2.6.13. `mysqli->error`, `mysqli_error`

Copyright 1997-2008 the PHP Documentation Group.

- `mysqli->error`  
`mysqli_error`

Returns a string description of the last error

#### Description

Object oriented style (property):

```
mysqli {
    string error ;
}
```

Procedural style:

```
string mysqli_error(mysqli link);
```

Returns the last error message for the most recent MySQLi function call that can succeed or fail.

#### Parameters

*link* Procedural style only: A link identifier returned by `mysqli_connect` or `mysqli_init`

#### Return Values

A string that describes the error. An empty string if no error occurred.

#### Examples

##### Example 20.86. Object oriented style

```
<?php
$mysqli = new mysqli("localhost", "my_user", "my_password", "world");

/* check connection */
if (mysqli_connect_errno()) {
    printf("Connect failed: %s\n", mysqli_connect_error());
    exit();
}

if (!$mysqli->query("SET a=1")) {
    printf("Errormessage: %s\n", $mysqli->error);
}

/* close connection */
$mysqli->close();
?>
```

##### Example 20.87. Procedural style

```
<?php
$link = mysqli_connect("localhost", "my_user", "my_password", "world");

/* check connection */
if (mysqli_connect_errno()) {
```

```

printf("Connect failed: %s\n", mysqli_connect_error());
exit();
}

if (!mysqli_query($link, "SET a=1")) {
    printf("Errormessage: %s\n", mysqli_error($link));
}

/* close connection */
mysqli_close($link);
?>

```

The above example will output:

```
Errormessage: Unknown system variable 'a'
```

#### See Also

```

mysqli_connect_errno
mysqli_connect_error
mysqli_errno
mysqli_sqlstate

```

#### 20.11.2.6.14. `mysqli->field_count`, `mysqli_field_count`

Copyright 1997-2008 the PHP Documentation Group.

- `mysqli->field_count`
- `mysqli_field_count`

Returns the number of columns for the most recent query

#### Description

Object oriented style (property):

```

mysqli_result {
    int field_count ;
}

```

Procedural style:

```
int mysqli_field_count(mysqli link);
```

Returns the number of columns for the most recent query on the connection represented by the *link* parameter. This function can be useful when using the `mysqli_store_result` function to determine if the query should have produced a non-empty result set or not without knowing the nature of the query.

#### Parameters

*link*

Procedural style only: A link identifier returned by `mysqli_connect` or `mysqli_init`

#### Return Values

An integer representing the number of fields in a result set.

#### Examples

**Example 20.88. Object oriented style**

```

<?php
$link = new mysqli("localhost", "my_user", "my_password", "test");

$link->query( "DROP TABLE IF EXISTS friends");
$link->query( "CREATE TABLE friends (id int, name varchar(20))");

$link->query( "INSERT INTO friends VALUES (1,'Hartmut'), (2, 'Ulf')");

$link->real_query("SELECT * FROM friends");

if ($link->field_count) {
    /* this was a select/show or describe query */
    $result = $link->store_result();

    /* process resultset */
    $row = $result->fetch_row();

    /* free resultset */
    $result->close();
}

/* close connection */
$link->close();
?>

```

**Example 20.89. Procedural style**

```

<?php
$link = mysqli_connect("localhost", "my_user", "my_password", "test");

mysqli_query($link, "DROP TABLE IF EXISTS friends");
mysqli_query($link, "CREATE TABLE friends (id int, name varchar(20))");

mysqli_query($link, "INSERT INTO friends VALUES (1,'Hartmut'), (2, 'Ulf')");

mysqli_real_query($link, "SELECT * FROM friends");

if (mysqli_field_count($link)) {
    /* this was a select/show or describe query */
    $result = mysqli_store_result($link);

    /* process resultset */
    $row = mysqli_fetch_row($result);

    /* free resultset */
    mysqli_free_result($result);
}

/* close connection */
mysqli_close($link);
?>

```

**20.11.2.6.15. `mysqli::get_charset`, `mysqli_get_charset`**

Copyright 1997-2008 the PHP Documentation Group.

- `mysqli::get_charset`

`mysqli_get_charset`

Returns a character set object

**Description**

```
object mysqli::get_charset();
```

```
object mysqli_get_charset(mysqli link);
```

Returns a character set object providing several properties of the current active character set.

### Parameters

*link* Procedural style only: A link identifier returned by `mysqli_connect` or `mysqli_init`

### Return Values

The function returns a character set object with the following properties:

<i>charset</i>	Character set name
<i>collation</i>	Collation name
<i>dir</i>	Directory the charset description was fetched from (?) or "" for builtin character sets
<i>min_length</i>	Minimum character length in bytes
<i>max_length</i>	Maximum character length in bytes
<i>number</i>	Internal character set number
<i>state</i>	Character set status (?)

### Examples

#### Example 20.90. Object oriented style

```
<?php
$db = mysqli_init();
$db->real_connect("localhost","root","","test");
var_dump($db->get_charset());
?>
```

#### Example 20.91. Procedural style

```
<?php
$db = mysqli_init();
mysqli_real_connect($db, "localhost", "root", "", "test");
var_dump(mysqli_get_charset($db));
?>
```

The above example will output:

```
object(stdClass)#2 (7) {
  ["charset"]=>
  string(6) "latin1"
  ["collation"]=>
  string(17) "latin1_swedish_ci"
  ["dir"]=>
  string(0) ""
  ["min_length"]=>
  int(1)
  ["max_length"]=>
  int(1)
  ["number"]=>
  int(8)
  ["state"]=>
  int(801)
}
```

**See Also**

[mysqli\\_characters\\_set\\_name](#)  
[mysqli\\_set\\_charset](#)

**20.11.2.6.16. [mysqli::get\\_client\\_info](#), [mysqli\\_get\\_client\\_info](#)**

Copyright 1997-2008 the PHP Documentation Group.

- [mysqli::get\\_client\\_info](#)  
[mysqli\\_get\\_client\\_info](#)

Returns the MySQL client version as a string

**Description**

```
string mysqli::get_client_info();
```

```
string mysqli_get_client_info();
```

The [mysqli\\_get\\_client\\_info](#) function is used to return a string representing the client version being used in the MySQLi extension.

**Return Values**

A string that represents the MySQL client library version

**Examples****Example 20.92. [mysqli\\_get\\_client\\_info](#)**

```
<?php
/* We don't need a connection to determine
   the version of mysql client library */
printf("Client library version: %s\n", mysqli_get_client_info());
?>
```

**See Also**

[mysqli\\_get\\_client\\_version](#)  
[mysqli\\_get\\_server\\_info](#)  
[mysqli\\_get\\_server\\_version](#)

**20.11.2.6.17. [mysqli::get\\_client\\_version](#), [mysqli\\_get\\_client\\_version](#)**

Copyright 1997-2008 the PHP Documentation Group.

- [mysqli::get\\_client\\_version](#)  
[mysqli\\_get\\_client\\_version](#)

Get MySQL client info

**Description**

```
int mysqli::get_client_version();
```

```
int mysqli_get_client_version();
```

Returns client version number as an integer.

#### Return Values

A number that represents the MySQL client library version in format: `main_version*10000 + minor_version *100 + sub_version`. For example, 4.1.0 is returned as 40100.

This is useful to quickly determine the version of the client library to know if some capability exists.

#### Examples

#### Example 20.93. `mysqli_get_client_version`

```
<?php
/* We don't need a connection to determine
   the version of mysql client library */
printf("Client library version: %d\n", mysqli_get_client_version());
?>
```

#### See Also

[mysqli\\_get\\_client\\_info](#)  
[mysqli\\_get\\_server\\_info](#)  
[mysqli\\_get\\_server\\_version](#)

### 20.11.2.6.18. `mysqli->host_info`, `mysqli_get_host_info`

Copyright 1997-2008 the PHP Documentation Group.

- `mysqli->host_info`  
`mysqli_get_host_info`

Returns a string representing the type of connection used

#### Description

Object oriented style (property):

```
mysqli {
    string host_info ;
}
```

Procdural style:

```
string mysqli_get_host_info(mysqli link);
```

The `mysqli_get_host_info` function returns a string describing the connection represented by the `link` parameter is using (including the server host name).

#### Parameters

`link` Procedural style only: A link identifier returned by `mysqli_connect` or `mysqli_init`

**Return Values**

A character string representing the server hostname and the connection type.

**Examples****Example 20.94. Object oriented style**

```
<?php
$link = new mysqli("localhost", "my_user", "my_password", "world");

/* check connection */
if (mysqli_connect_errno()) {
    printf("Connect failed: %s\n", mysqli_connect_error());
    exit();
}

/* print host information */
printf("Host info: %s\n", $link->host_info);

/* close connection */
$link->close();
?>
```

**Example 20.95. Procedural style**

```
<?php
$link = mysqli_connect("localhost", "my_user", "my_password", "world");

/* check connection */
if (mysqli_connect_errno()) {
    printf("Connect failed: %s\n", mysqli_connect_error());
    exit();
}

/* print host information */
printf("Host info: %s\n", mysqli_get_host_info($link));

/* close connection */
mysqli_close($link);
?>
```

The above example will output:

```
Host info: Localhost via UNIX socket
```

**See Also**

[mysqli\\_get\\_proto\\_info](#)

**20.11.2.6.19. [mysqli->protocol\\_version](#), [mysqli\\_get\\_proto\\_info](#)**

Copyright 1997-2008 the PHP Documentation Group.

- [mysqli->protocol\\_version](#)  
[mysqli\\_get\\_proto\\_info](#)

Returns the version of the MySQL protocol used

**Description**



Object oriented style (property):

```
mysqli {
    string protocol_version ;
}
```

Procedural style:

```
int mysqli_get_proto_info(mysqli link);
```

Returns an integer representing the MySQL protocol version used by the connection represented by the *link* parameter.

### Parameters

*link*

Procedural style only: A link identifier returned by `mysqli_connect` or `mysqli_init`

### Return Values

Returns an integer representing the protocol version.

### Examples

#### Example 20.96. Object oriented style

```
<?php
$mysqli = new mysqli("localhost", "my_user", "my_password");

/* check connection */
if (mysqli_connect_errno()) {
    printf("Connect failed: %s\n", mysqli_connect_error());
    exit();
}

/* print protocol version */
printf("Protocol version: %d\n", $mysqli->protocol_version);

/* close connection */
$mysqli->close();
?>
```

#### Example 20.97. Procedural style

```
<?php
$link = mysqli_connect("localhost", "my_user", "my_password");

/* check connection */
if (mysqli_connect_errno()) {
    printf("Connect failed: %s\n", mysqli_connect_error());
    exit();
}

/* print protocol version */
printf("Protocol version: %d\n", mysqli_get_proto_info($link));

/* close connection */
mysqli_close($link);
?>
```

The above example will output:

```
Protocol version: 10
```

**See Also**[mysqli\\_get\\_host\\_info](#)**20.11.2.6.20. [mysqli->server\\_info](#), [mysqli\\_get\\_server\\_info](#)**

Copyright 1997-2008 the PHP Documentation Group.

- [mysqli->server\\_info](#)  
[mysqli\\_get\\_server\\_info](#)

Returns the version of the MySQL server

**Description**

Object oriented style (property):

```
mysqli {
    string server_info ;
}
```

Procedural style:

```
string mysqli_get_server_info(mysqli link);
```

Returns a string representing the version of the MySQL server that the MySQLi extension is connected to.

**Parameters**[link](#) Procedural style only: A link identifier returned by [mysqli\\_connect](#) or [mysqli\\_init](#)**Return Values**

A character string representing the server version.

**Examples****Example 20.98. Object oriented style**

```
<?php
$mysqli = new mysqli("localhost", "my_user", "my_password");

/* check connection */
if (mysqli_connect_errno()) {
    printf("Connect failed: %s\n", mysqli_connect_error());
    exit();
}

/* print server version */
printf("Server version: %s\n", $mysqli->server_info);

/* close connection */
$mysqli->close();
?>
```

**Example 20.99. Procedural style**

```

<?php
$link = mysqli_connect("localhost", "my_user", "my_password");

/* check connection */
if (mysqli_connect_errno()) {
    printf("Connect failed: %s\n", mysqli_connect_error());
    exit();
}

/* print server version */
printf("Server version: %s\n", mysqli_get_server_info($link));

/* close connection */
mysqli_close($link);
?>

```

The above example will output:

```
Server version: 4.1.2-alpha-debug
```

### See Also

[mysqli\\_get\\_client\\_info](#)  
[mysqli\\_get\\_client\\_version](#)  
[mysqli\\_get\\_server\\_version](#)

#### 20.11.2.6.21. [mysqli->server\\_version](#), [mysqli\\_get\\_server\\_version](#)

Copyright 1997-2008 the PHP Documentation Group.

- [mysqli->server\\_version](#)  
[mysqli\\_get\\_server\\_version](#)

Returns the version of the MySQL server as an integer

### Description

Object oriented style (property):

```

mysqli {
    int server_version ;
}

```

Procedural style:

```
int mysqli_get_server_version(mysqli link);
```

The [mysqli\\_get\\_server\\_version](#) function returns the version of the server connected to (represented by the *link* parameter) as an integer.

### Parameters

*link* Procedural style only: A link identifier returned by [mysqli\\_connect](#) or [mysqli\\_init](#)

### Return Values

An integer representing the server version.

The form of this version number is `main_version * 10000 + minor_version * 100 + sub_version` (i.e. version 4.1.0 is 40100).

## Examples

### Example 20.100. Object oriented style

```
<?php
$mysqli = new mysqli("localhost", "my_user", "my_password");

/* check connection */
if (mysqli_connect_errno()) {
    printf("Connect failed: %s\n", mysqli_connect_error());
    exit();
}

/* print server version */
printf("Server version: %d\n", $mysqli->server_version);

/* close connection */
$mysqli->close();
?>
```

### Example 20.101. Procedural style

```
<?php
$link = mysqli_connect("localhost", "my_user", "my_password");

/* check connection */
if (mysqli_connect_errno()) {
    printf("Connect failed: %s\n", mysqli_connect_error());
    exit();
}

/* print server version */
printf("Server version: %d\n", mysqli_get_server_version($link));

/* close connection */
mysqli_close($link);
?>
```

The above example will output:

```
Server version: 40102
```

## See Also

[mysqli\\_get\\_client\\_info](#)  
[mysqli\\_get\\_client\\_version](#)  
[mysqli\\_get\\_server\\_info](#)

### 20.11.2.6.22. [mysqli::get\\_warnings](#), [mysqli\\_get\\_warnings](#)

Copyright 1997-2008 the PHP Documentation Group.

- [mysqli::get\\_warnings](#)  
[mysqli\\_get\\_warnings](#)

## Description

```
object mysqli::get_warnings();
```

```
object mysqli_get_warnings(mysqli link);
```

### Warning

This function is currently not documented; only its argument list is available.

#### 20.11.2.6.23. `mysqli->info`, `mysqli_info`

Copyright 1997-2008 the PHP Documentation Group.

- `mysqli->info`

`mysqli_info`

Retrieves information about the most recently executed query

#### Description

Object oriented style (property)

```
mysqli {
    string info ;
}
```

Procedural style:

```
string mysqli_info(mysqli link);
```

The `mysqli_info` function returns a string providing information about the last query executed. The nature of this string is provided below:

**Table 20.8. Possible `mysqli_info` return values**

Query type	Example result string
INSERT INTO...SELECT...	Records: 100 Duplicates: 0 Warnings: 0
INSERT INTO...VALUES (...),(...),(...)	Records: 3 Duplicates: 0 Warnings: 0
LOAD DATA INFILE ...	Records: 1 Deleted: 0 Skipped: 0 Warnings: 0
ALTER TABLE ...	Records: 3 Duplicates: 0 Warnings: 0
UPDATE ...	Rows matched: 40 Changed: 40 Warnings: 0

### Note

Queries which do not fall into one of the above formats are not supported. In these situations, `mysqli_info` will return an empty string.

#### Parameters

`link`

Procedural style only: A link identifier returned by `mysqli_connect` or `mysqli_init`

#### Return Values

A character string representing additional information about the most recently executed query.

#### Examples

##### Example 20.102. Object oriented style

```

<?php
$mysqli = new mysqli("localhost", "my_user", "my_password", "world");

/* check connection */
if (mysqli_connect_errno()) {
    printf("Connect failed: %s\n", mysqli_connect_error());
    exit();
}

$mysqli->query("CREATE TEMPORARY TABLE t1 LIKE City");

/* INSERT INTO .. SELECT */
$mysqli->query("INSERT INTO t1 SELECT * FROM City ORDER BY ID LIMIT 150");
printf("%s\n", $mysqli->info);

/* close connection */
$mysqli->close();
?>

```

### Example 20.103. Procedural style

```

<?php
$link = mysqli_connect("localhost", "my_user", "my_password", "world");

/* check connection */
if (mysqli_connect_errno()) {
    printf("Connect failed: %s\n", mysqli_connect_error());
    exit();
}

mysqli_query($link, "CREATE TEMPORARY TABLE t1 LIKE City");

/* INSERT INTO .. SELECT */
mysqli_query($link, "INSERT INTO t1 SELECT * FROM City ORDER BY ID LIMIT 150");
printf("%s\n", mysqli_info($link));

/* close connection */
mysqli_close($link);
?>

```

The above example will output:

```
Records: 150 Duplicates: 0 Warnings: 0
```

### See Also

[mysqli\\_affected\\_rows](#)  
[mysqli\\_warning\\_count](#)  
[mysqli\\_num\\_rows](#)

#### 20.11.2.6.24. [mysqli::init](#), [mysqli\\_init](#)

Copyright 1997-2008 the PHP Documentation Group.

- [mysqli::init](#)  
[mysqli\\_init](#)

Initializes MySQLi and returns a resource for use with [mysqli\\_real\\_connect\(\)](#)

### Description

Object oriented style (method):

```
mysqli_init();
```

Procedural style:

```
mysqli_init();
```

Allocates or initializes a MySQL object suitable for `mysqli_options` and `mysqli_real_connect`.

### Note

Any subsequent calls to any `mysqli` function (except `mysqli_options`) will fail until `mysqli_real_connect` was called.

### Return Values

Returns an object.

### See Also

```
mysqli_options
mysqli_close
mysqli_real_connect
mysqli_connect
```

## 20.11.2.6.25. `mysqli->insert_id`, `mysqli_insert_id`

Copyright 1997-2008 the PHP Documentation Group.

- `mysqli->insert_id`  
`mysqli_insert_id`

Returns the auto generated id used in the last query

### Description

Object oriented style (property):

```
mysqli {
    int insert_id ;
}
```

Procedural style:

```
int mysqli_insert_id(mysqli link);
```

The `mysqli_insert_id` function returns the ID generated by a query on a table with a column having the `AUTO_INCREMENT` attribute. If the last query wasn't an `INSERT` or `UPDATE` statement or if the modified table does not have a column with the `AUTO_INCREMENT` attribute, this function will return zero.

### Note

Performing an `INSERT` or `UPDATE` statement using the `LAST_INSERT_ID()` function will also modify the value returned by the `mysqli_insert_id` function.

### Parameters

*link* Procedural style only: A link identifier returned by `mysqli_connect` or `mysqli_init`

### Return Values

The value of the `AUTO_INCREMENT` field that was updated by the previous query. Returns zero if there was no previous query on

the connection or if the query did not update an `AUTO_INCREMENT` value.

### Note

If the number is greater than maximal int value, `mysqli_insert_id` will return a string.

### Examples

#### Example 20.104. Object oriented style

```
<?php
$mysqli = new mysqli("localhost", "my_user", "my_password", "world");

/* check connection */
if (mysqli_connect_errno()) {
    printf("Connect failed: %s\n", mysqli_connect_error());
    exit();
}

$mysqli->query("CREATE TABLE myCity LIKE City");

$query = "INSERT INTO myCity VALUES (NULL, 'Stuttgart', 'DEU', 'Stuttgart', 617000)";
$mysqli->query($query);

printf ("New Record has id %d.\n", $mysqli->insert_id);

/* drop table */
$mysqli->query("DROP TABLE myCity");

/* close connection */
$mysqli->close();
?>
```

#### Example 20.105. Procedural style

```
<?php
$link = mysqli_connect("localhost", "my_user", "my_password", "world");

/* check connection */
if (mysqli_connect_errno()) {
    printf("Connect failed: %s\n", mysqli_connect_error());
    exit();
}

mysqli_query($link, "CREATE TABLE myCity LIKE City");

$query = "INSERT INTO myCity VALUES (NULL, 'Stuttgart', 'DEU', 'Stuttgart', 617000)";
mysqli_query($link, $query);

printf ("New Record has id %d.\n", mysqli_insert_id($link));

/* drop table */
mysqli_query($link, "DROP TABLE myCity");

/* close connection */
mysqli_close($link);
?>
```

The above example will output:

```
New Record has id 1.
```

#### 20.11.2.6.26. `mysqli::kill`, `mysqli_kill`

Copyright 1997-2008 the PHP Documentation Group.

- `mysqli::kill`



## mysqli\_kill

Asks the server to kill a MySQL thread

### Description

Object oriented style (method)

```
bool mysqli::kill(int processid);
```

Procedural style:

```
bool mysqli_kill(mysqli link,
                 int processid);
```

This function is used to ask the server to kill a MySQL thread specified by the *processid* parameter. This value must be retrieved by calling the *mysqli\_thread\_id* function.

To stop a running query you should use the SQL command `KILL QUERY processid`.

### Parameters

*link* Procedural style only: A link identifier returned by *mysqli\_connect* or *mysqli\_init*

### Return Values

Returns `TRUE` on success or `FALSE` on failure.

### Examples

#### Example 20.106. Object oriented style

```
<?php
$mysqli = new mysqli("localhost", "my_user", "my_password", "world");

/* check connection */
if (mysqli_connect_errno()) {
    printf("Connect failed: %s\n", mysqli_connect_error());
    exit();
}

/* determine our thread id */
$thread_id = $mysqli->thread_id;

/* Kill connection */
$mysqli->kill($thread_id);

/* This should produce an error */
if (!$mysqli->query("CREATE TABLE myCity LIKE City")) {
    printf("Error: %s\n", $mysqli->error);
    exit;
}

/* close connection */
$mysqli->close();
?>
```

#### Example 20.107. Procedural style

```
<?php
$link = mysqli_connect("localhost", "my_user", "my_password", "world");

/* check connection */
if (mysqli_connect_errno()) {
    printf("Connect failed: %s\n", mysqli_connect_error());
    exit();
}
```

```
/* determine our thread id */
$thread_id = mysqli_thread_id($link);

/* Kill connection */
mysqli_kill($link, $thread_id);

/* This should produce an error */
if (!mysqli_query($link, "CREATE TABLE myCity LIKE City")) {
    printf("Error: %s\n", mysqli_error($link));
    exit;
}

/* close connection */
mysqli_close($link);
?>
```

The above example will output:

```
Error: MySQL server has gone away
```

#### See Also

[mysqli\\_thread\\_id](#)

### 20.11.2.6.27. [mysqli::more\\_results](#), [mysqli\\_more\\_results](#)

Copyright 1997-2008 the PHP Documentation Group.

- [mysqli::more\\_results](#)  
[mysqli\\_more\\_results](#)

Check if there are any more query results from a multi query

#### Description

```
bool mysqli::more_results();
```

```
bool mysqli_more_results(mysqli link);
```

Indicates if one or more result sets are available from a previous call to [mysqli\\_multi\\_query](#).

#### Parameters

*link* Procedural style only: A link identifier returned by [mysqli\\_connect](#) or [mysqli\\_init](#)

#### Return Values

Returns [TRUE](#) on success or [FALSE](#) on failure.

#### Examples

See [mysqli\\_multi\\_query](#).

#### See Also

[mysqli\\_multi\\_query](#)  
[mysqli\\_next\\_result](#)  
[mysqli\\_store\\_result](#)  
[mysqli\\_use\\_result](#)

**20.11.2.6.28. `mysqli::multi_query`, `mysqli_multi_query`**

Copyright 1997-2008 the PHP Documentation Group.

- `mysqli::multi_query`  
`mysqli_multi_query`  
Performs a query on the database

**Description**

Object oriented style (method):

```
bool mysqli::multi_query(string query);
```

Procedural style:

```
bool mysqli_multi_query(mysqli link,  
                        string query);
```

Executes one or multiple queries which are concatenated by a semicolon.

To retrieve the resultset from the first query you can use `mysqli_use_result` or `mysqli_store_result`. All subsequent query results can be processed using `mysqli_more_results` and `mysqli_next_result`.**Parameters**

*link* Procedural style only: A link identifier returned by `mysqli_connect` or `mysqli_init`

*query* The query, as a string.

**Return Values**Returns `FALSE` if the first statement failed. To retrieve subsequent errors from other statements you have to call `mysqli_next_result` first.**Examples****Example 20.108. Object oriented style**

```
<?php
$mysqli = new mysqli("localhost", "my_user", "my_password", "world");

/* check connection */
if (mysqli_connect_errno()) {
    printf("Connect failed: %s\n", mysqli_connect_error());
    exit();
}

$query = "SELECT CURRENT_USER();";
$query .= "SELECT Name FROM City ORDER BY ID LIMIT 20, 5";

/* execute multi query */
if ($mysqli->multi_query($query)) {
    do {
        /* store first result set */
        if ($result = $mysqli->store_result()) {
            while ($row = $result->fetch_row()) {
                printf("%s\n", $row[0]);
            }
            $result->free();
        }
        /* print divider */
        if ($mysqli->more_results()) {
            printf("-----\n");
        }
    } while ($mysqli->next_result());
}

/* close connection */
$mysqli->close();
```

```
?>
```

### Example 20.109. Procedural style

```
<?php
$link = mysqli_connect("localhost", "my_user", "my_password", "world");

/* check connection */
if (mysqli_connect_errno()) {
    printf("Connect failed: %s\n", mysqli_connect_error());
    exit();
}

$query = "SELECT CURRENT_USER();";
$query .= "SELECT Name FROM City ORDER BY ID LIMIT 20, 5";

/* execute multi query */
if (mysqli_multi_query($link, $query)) {
    do {
        /* store first result set */
        if ($result = mysqli_store_result($link)) {
            while ($row = mysqli_fetch_row($result)) {
                printf("%s\n", $row[0]);
            }
            mysqli_free_result($result);
        }
        /* print divider */
        if (mysqli_more_results($link)) {
            printf("-----\n");
        }
    } while (mysqli_next_result($link));
}

/* close connection */
mysqli_close($link);
?>
```

The above example will output something similar to:

```
my_user@localhost
-----
Amersfoort
Maastricht
Dordrecht
Leiden
Haarlemmermeer
```

#### See Also

```
mysqli_use_result
mysqli_store_result
mysqli_next_result
mysqli_more_results
```

#### 20.11.2.6.29. `mysqli::next_result`, `mysqli_next_result`

Copyright 1997-2008 the PHP Documentation Group.

- `mysqli::next_result`
- `mysqli_next_result`

Prepare next result from `multi_query`

#### Description

```
bool mysqli::next_result();
```

```
bool mysqli_next_result(mysqli link);
```

Prepares next result set from a previous call to `mysqli_multi_query` which can be retrieved by `mysqli_store_result` or `mysqli_use_result`.

#### Parameters

*link* Procedural style only: A link identifier returned by `mysqli_connect` or `mysqli_init`

#### Return Values

Returns `TRUE` on success or `FALSE` on failure.

#### Examples

See `mysqli_multi_query`.

#### See Also

```
mysqli_multi_query
mysqli_more_results
mysqli_store_result
mysqli_use_result
```

### 20.11.2.6.30. `mysqli::options`, `mysqli_options`

Copyright 1997-2008 the PHP Documentation Group.

- `mysqli::options`

```
mysqli_options
```

Set options

#### Description

Object oriented style (method)

```
bool mysqli::options(int option,
                    mixed value);
```

Procedural style:

```
bool mysqli_options(mysqli link,
                    int option,
                    mixed value);
```

Used to set extra connect options and affect behavior for a connection.

This function may be called multiple times to set several options.

`mysqli_options` should be called after `mysqli_init` and before `mysqli_real_connect`.

#### Parameters

*link* Procedural style only: A link identifier returned by `mysqli_connect` or `mysqli_init`

*option* The option that you want to set. It can be one of the following values:

#### Table 20.9. Valid options

Name	Description
<code>MYSQLI_OPT_CONNECT_TIMEOUT</code>	connection timeout in seconds
<code>MYSQLI_OPT_LOCAL_INFILE</code>	enable/disable use of <code>LOAD LOCAL INFILE</code>
<code>MYSQLI_INIT_COMMAND</code>	command to execute after when connecting to MySQL server
<code>MYSQLI_READ_DEFAULT_FILE</code>	Read options from named option file instead of <code>my.cnf</code>
<code>MYSQLI_READ_DEFAULT_GROUP</code>	Read options from the named group from <code>my.cnf</code> or the file specified with <code>MYSQL_READ_DEFAULT_FILE</code> .

*value*    The value for the option.

### Return Values

Returns `TRUE` on success or `FALSE` on failure.

### Examples

See `mysqli_real_connect`.

### See Also

`mysqli_init`  
`mysqli_real_connect`

## 20.11.2.6.31. `mysqli::ping`, `mysqli_ping`

Copyright 1997-2008 the PHP Documentation Group.

- `mysqli::ping`  
`mysqli_ping`

Pings a server connection, or tries to reconnect if the connection has gone down

### Description

Object oriented style (method):

```
bool mysqli::ping();
```

Procedural style:

```
bool mysqli_ping(mysqli link);
```

Checks whether the connection to the server is working. If it has gone down, and global option `mysqli.reconnect` is enabled an automatic reconnection is attempted.

This function can be used by clients that remain idle for a long while, to check whether the server has closed the connection and reconnect if necessary.

### Parameters

*link*    Procedural style only: A link identifier returned by `mysqli_connect` or `mysqli_init`

### Return Values

Returns `TRUE` on success or `FALSE` on failure.

### Examples

**Example 20.110. Object oriented style**

```
<?php
$mysqli = new mysqli("localhost", "my_user", "my_password", "world");

/* check connection */
if (mysqli_connect_errno()) {
    printf("Connect failed: %s\n", mysqli_connect_error());
    exit();
}

/* check if server is alive */
if ($mysqli->ping()) {
    printf ("Our connection is ok!\n");
} else {
    printf ("Error: %s\n", $mysqli->error);
}

/* close connection */
$mysqli->close();
?>
```

**Example 20.111. Procedural style**

```
<?php
$link = mysqli_connect("localhost", "my_user", "my_password", "world");

/* check connection */
if (mysqli_connect_errno()) {
    printf("Connect failed: %s\n", mysqli_connect_error());
    exit();
}

/* check if server is alive */
if (mysqli_ping($link)) {
    printf ("Our connection is ok!\n");
} else {
    printf ("Error: %s\n", mysqli_error($link));
}

/* close connection */
mysqli_close($link);
?>
```

The above example will output:

```
Our connection is ok!
```

**20.11.2.6.32. `mysqli::prepare`, `mysqli_prepare`**

Copyright 1997-2008 the PHP Documentation Group.

- `mysqli::prepare`  
`mysqli_prepare`

Prepare a SQL statement for execution

**Description**

Object oriented style (method)

```
mysqli_stmt prepare(string query);
```

Procedure style:

```
mysqli_stmt mysqli_prepare(mysqli link,
                           string query);
```

Prepares the SQL query pointed to by the null-terminated string query, and returns a statement handle to be used for further operations on the statement. The query must consist of a single SQL statement.

The parameter markers must be bound to application variables using `mysqli_stmt_bind_param` and/or `mysqli_stmt_bind_result` before executing the statement or fetching rows.

### Parameters

`link` Procedural style only: A link identifier returned by `mysqli_connect` or `mysqli_init`

`query` The query, as a string.

#### Note

You should not add a terminating semicolon or `\g` to the statement.

This parameter can include one or more parameter markers in the SQL statement by embedding question mark (?) characters at the appropriate positions.

#### Note

The markers are legal only in certain places in SQL statements. For example, they are allowed in the `VALUES()` list of an `INSERT` statement (to specify column values for a row), or in a comparison with a column in a `WHERE` clause to specify a comparison value.

However, they are not allowed for identifiers (such as table or column names), in the select list that names the columns to be returned by a `SELECT` statement, or to specify both operands of a binary operator such as the = equal sign. The latter restriction is necessary because it would be impossible to determine the parameter type. It's not allowed to compare marker with `NULL` by `? IS NULL` too. In general, parameters are legal only in Data Manipulation Language (DML) statements, and not in Data Definition Language (DDL) statements.

### Return Values

`mysqli_prepare` returns a statement object or `FALSE` if an error occurred.

### Examples

#### Example 20.112. Object oriented style

```
<?php
mysqli = new mysqli("localhost", "my_user", "my_password", "world");

/* check connection */
if (mysqli_connect_errno()) {
    printf("Connect failed: %s\n", mysqli_connect_error());
    exit();
}

$city = "Amersfoort";

/* create a prepared statement */
if ($stmt = mysqli_prepare("SELECT District FROM City WHERE Name=?")) {

    /* bind parameters for markers */
    $stmt->bind_param("s", $city);

    /* execute query */
    $stmt->execute();

    /* bind result variables */
    $stmt->bind_result($district);

    /* fetch value */
    $stmt->fetch();

    printf("%s is in district %s\n", $city, $district);

    /* close statement */
    $stmt->close();
}
```



```

}
/* close connection */
$mysqli->close();
?>

```

### Example 20.113. Procedural style

```

<?php
$link = mysqli_connect("localhost", "my_user", "my_password", "world");

/* check connection */
if (mysqli_connect_errno()) {
    printf("Connect failed: %s\n", mysqli_connect_error());
    exit();
}

$city = "Amersfoort";

/* create a prepared statement */
if ($stmt = mysqli_prepare($link, "SELECT District FROM City WHERE Name=?")) {

    /* bind parameters for markers */
    mysqli_stmt_bind_param($stmt, "s", $city);

    /* execute query */
    mysqli_stmt_execute($stmt);

    /* bind result variables */
    mysqli_stmt_bind_result($stmt, $district);

    /* fetch value */
    mysqli_stmt_fetch($stmt);

    printf("%s is in district %s\n", $city, $district);

    /* close statement */
    mysqli_stmt_close($stmt);
}

/* close connection */
mysqli_close($link);
?>

```

The above example will output:

```
Amersfoort is in district Utrecht
```

#### See Also

```

mysqli_stmt_execute
mysqli_stmt_fetch
mysqli_stmt_bind_param
mysqli_stmt_bind_result
mysqli_stmt_close

```

#### 20.11.2.6.33. `mysqli::query`, `mysqli_query`

Copyright 1997-2008 the PHP Documentation Group.

- `mysqli::query`
- `mysqli_query`

Performs a query on the database

## Description

Object oriented style (method):

```
mixed mysqli::query(string query,
                    int resultmode);
```

Procedural style:

```
mixed mysqli_query(mysqli link,
                  string query,
                  int resultmode);
```

Performs a *query* against the database.

Functionally, using this function is identical to calling `mysqli_real_query` followed either by `mysqli_use_result` or `mysqli_store_result`.

## Parameters

<i>link</i>	Procedural style only: A link identifier returned by <code>mysqli_connect</code> or <code>mysqli_init</code>
<i>query</i>	The query string.
<i>resultmode</i>	Either the constant <code>MYSQLI_USE_RESULT</code> or <code>MYSQLI_STORE_RESULT</code> depending on the desired behavior. By default, <code>MYSQLI_STORE_RESULT</code> is used.  If you use <code>MYSQLI_USE_RESULT</code> all subsequent calls will return error <code>Commands out of sync</code> unless you call <code>mysqli_free_result</code>

## Return Values

Returns `TRUE` on success or `FALSE` on failure. For `SELECT`, `SHOW`, `DESCRIBE` or `EXPLAIN` `mysqli_query` will return a result object.

## Examples

### Example 20.114. Object oriented style

```
<?php
$mysqli = new mysqli("localhost", "my_user", "my_password", "world");

/* check connection */
if (mysqli_connect_errno()) {
    printf("Connect failed: %s\n", mysqli_connect_error());
    exit();
}

/* Create table doesn't return a resultset */
if ($mysqli->query("CREATE TEMPORARY TABLE myCity LIKE City") === TRUE) {
    printf("Table myCity successfully created.\n");
}

/* Select queries return a resultset */
if ($result = $mysqli->query("SELECT Name FROM City LIMIT 10")) {
    printf("Select returned %d rows.\n", $result->num_rows);

    /* free result set */
    $result->close();
}

/* If we have to retrieve large amount of data we use MYSQLI_USE_RESULT */
if ($result = $mysqli->query("SELECT * FROM City", MYSQLI_USE_RESULT)) {

    /* Note, that we can't execute any functions which interact with the
    server until result set was closed. All calls will return an
    'out of sync' error */
    if (!$mysqli->query("SET @a:='this will not work'")) {
        printf("Error: %s\n", $mysqli->error);
    }
    $result->close();
}

$mysqli->close();
?>
```

**Example 20.115. Procedural style**

```

<?php
$link = mysqli_connect("localhost", "my_user", "my_password", "world");

/* check connection */
if (mysqli_connect_errno()) {
    printf("Connect failed: %s\n", mysqli_connect_error());
    exit();
}

/* Create table doesn't return a resultset */
if (mysqli_query($link, "CREATE TEMPORARY TABLE myCity LIKE City") === TRUE) {
    printf("Table myCity successfully created.\n");
}

/* Select queries return a resultset */
if ($result = mysqli_query($link, "SELECT Name FROM City LIMIT 10")) {
    printf("Select returned %d rows.\n", mysqli_num_rows($result));

    /* free result set */
    mysqli_free_result($result);
}

/* If we have to retrieve large amount of data we use MYSQLI_USE_RESULT */
if ($result = mysqli_query($link, "SELECT * FROM City", MYSQLI_USE_RESULT)) {

    /* Note, that we can't execute any functions which interact with the
    server until result set was closed. All calls will return an
    'out of sync' error */
    if (!mysqli_query($link, "SET @a:='this will not work'")) {
        printf("Error: %s\n", mysqli_error($link));
    }
    mysqli_free_result($result);
}

mysqli_close($link);
?>

```

The above example will output:

```

Table myCity successfully created.
Select returned 10 rows.
Error: Commands out of sync; You can't run this command now

```

**See Also**

[mysqli\\_real\\_query](#)  
[mysqli\\_multi\\_query](#)  
[mysqli\\_free\\_result](#)

**20.11.2.6.34. [mysqli::real\\_connect](#), [mysqli\\_real\\_connect](#)**

Copyright 1997-2008 the PHP Documentation Group.

- [mysqli::real\\_connect](#)  
[mysqli\\_real\\_connect](#)

Opens a connection to a mysql server

**Description**

Object oriented style (method)

```
bool mysqli::real_connect(string host,
                        string username,
                        string passwd,
                        string dbname,
                        int port,
                        string socket,
                        int flags);
```

### Procedural style

```
bool mysqli_real_connect(mysqli link,
                        string host,
                        string username,
                        string passwd,
                        string dbname,
                        int port,
                        string socket,
                        int flags);
```

Establish a connection to a MySQL database engine.

This function differs from `mysqli_connect`:

- `mysqli_real_connect` needs a valid object which has to be created by function `mysqli_init`.
- With function `mysqli_options` you can set various options for connection.
- There is a `flags` parameter.

### Parameters

<code>link</code>	Procedural style only: A link identifier returned by <code>mysqli_connect</code> or <code>mysqli_init</code>
<code>host</code>	Can be either a host name or an IP address. Passing the <code>NULL</code> value or the string "localhost" to this parameter, the local host is assumed. When possible, pipes will be used instead of the TCP/IP protocol.
<code>username</code>	The MySQL user name.
<code>passwd</code>	If provided or <code>NULL</code> , the MySQL server will attempt to authenticate the user against those user records which have no password only. This allows one username to be used with different permissions (depending on if a password as provided or not).
<code>dbname</code>	If provided will specify the default database to be used when performing queries.
<code>port</code>	Specifies the port number to attempt to connect to the MySQL server.
<code>socket</code>	Specifies the socket or named pipe that should be used.

#### Note

Specifying the `socket` parameter will not explicitly determine the type of connection to be used when connecting to the MySQL server. How the connection is made to the MySQL database is determined by the `host` parameter.

`flags` With the parameter `flags` you can set different connection options:

**Table 20.10. Supported flags**

Name	Description
<code>MYSQLI_CLIENT_COMPRESS</code>	Use compression protocol
<code>MYSQLI_CLIENT_FOUND_ROWS</code>	return number of matched rows, not the number of affected rows
<code>MYSQLI_CLIENT_IGNORE_SPACE</code>	Allow spaces after function names. Makes all function names reserved words.
<code>MYSQLI_CLIENT_INTERACTIVE</code>	Allow <code>interactive_timeout</code> seconds (instead of <code>wait_timeout</code> seconds) of inactivity before closing the connection
<code>MYSQLI_CLIENT_SSL</code>	Use SSL (encryption)

**Note**

For security reasons the `MULTI_STATEMENT` flag is not supported in PHP. If you want to execute multiple queries use the `mysqli_multi_query` function.

**Return Values**

Returns `TRUE` on success or `FALSE` on failure.

**Examples****Example 20.116. Object oriented style**

```
<?php
/* create a connection object which is not connected */
$mysqli = mysqli_init();

/* set connection options */
$mysqli->options(MYSQLI_INIT_COMMAND, "SET AUTOCOMMIT=0");
$mysqli->options(MYSQLI_OPT_CONNECT_TIMEOUT, 5);

/* connect to server */
$mysqli->real_connect('localhost', 'my_user', 'my_password', 'world');

/* check connection */
if (mysqli_connect_errno()) {
    printf("Connect failed: %s\n", mysqli_connect_error());
    exit();
}

printf ("Connection: %s\n.", $mysqli->host_info);

$mysqli->close();
?>
```

**Example 20.117. Procedural style**

```
<?php
/* create a connection object which is not connected */
$link = mysqli_init();

/* set connection options */
mysqli_options($link, MYSQLI_INIT_COMMAND, "SET AUTOCOMMIT=0");
mysqli_options($link, MYSQLI_OPT_CONNECT_TIMEOUT, 5);

/* connect to server */
mysqli_real_connect($link, 'localhost', 'my_user', 'my_password', 'world');

/* check connection */
if (mysqli_connect_errno()) {
    printf("Connect failed: %s\n", mysqli_connect_error());
    exit();
}

printf ("Connection: %s\n.", mysqli_get_host_info($link));

mysqli_close($link);
?>
```

The above example will output:

```
Connection: Localhost via UNIX socket
```

**See Also**

[mysqli\\_connect](#)  
[mysqli\\_init](#)  
[mysqli\\_options](#)  
[mysqli\\_ssl\\_set](#)  
[mysqli\\_close](#)

**20.11.2.6.35. [mysqli::real\\_escape\\_string](#), [mysqli\\_real\\_escape\\_string](#)**

Copyright 1997-2008 the PHP Documentation Group.

- [mysqli::real\\_escape\\_string](#)  
[mysqli\\_real\\_escape\\_string](#)

Escapes special characters in a string for use in a SQL statement, taking into account the current charset of the connection

**Description**

Object oriented style (both methods are equivalent):

```
string mysqli::escape_string(string escapestr);
```

```
string real_escape_string(string escapestr);
```

Procedural style:

```
string mysqli_real_escape_string(mysqli link,  
                                string escapestr);
```

This function is used to create a legal SQL string that you can use in an SQL statement. The given string is encoded to an escaped SQL string, taking into account the current character set of the connection.

**Parameters**

<i>link</i>	Procedural style only: A link identifier returned by <a href="#">mysqli_connect</a> or <a href="#">mysqli_init</a>
<i>escapestr</i>	The string to be escaped. Characters encoded are NUL (ASCII 0), \n, \r, \, ', ", and Control-Z.

**Return Values**

Returns an escaped string.

**Examples****Example 20.118. Object oriented style**

```
<?php
$mysqli = new mysqli("localhost", "my_user", "my_password", "world");

/* check connection */
if (mysqli_connect_errno()) {
    printf("Connect failed: %s\n", mysqli_connect_error());
    exit();
}

$mysqli->query("CREATE TEMPORARY TABLE myCity LIKE City");
$city = "'s Hertogenbosch";

/* this query will fail, cause we didn't escape $city */
if (!$mysqli->query("INSERT into myCity (Name) VALUES ('$city')")) {
    printf("Error: %s\n", $mysqli->sqlstate);
}
```

```

$city = $mysqli->real_escape_string($city);

/* this query with escaped $city will work */
if ($mysqli->query("INSERT into myCity (Name) VALUES ('$city')")) {
    printf("%d Row inserted.\n", $mysqli->affected_rows);
}

$mysqli->close();
?>

```

### Example 20.119. Procedural style

```

<?php
$link = mysqli_connect("localhost", "my_user", "my_password", "world");

/* check connection */
if (mysqli_connect_errno()) {
    printf("Connect failed: %s\n", mysqli_connect_error());
    exit();
}

mysqli_query($link, "CREATE TEMPORARY TABLE myCity LIKE City");

$city = "'s Hertogenbosch";

/* this query will fail, cause we didn't escape $city */
if (!mysqli_query($link, "INSERT into myCity (Name) VALUES ('$city')")) {
    printf("Error: %s\n", mysqli_sqlstate($link));
}

$city = mysqli_real_escape_string($link, $city);

/* this query with escaped $city will work */
if (mysqli_query($link, "INSERT into myCity (Name) VALUES ('$city')")) {
    printf("%d Row inserted.\n", mysqli_affected_rows($link));
}

mysqli_close($link);
?>

```

The above example will output:

```

Error: 42000
1 Row inserted.

```

#### See Also

[mysqli\\_character\\_set\\_name](#)

#### 20.11.2.6.36. [mysqli::real\\_query](#), [mysqli\\_real\\_query](#)

Copyright 1997-2008 the PHP Documentation Group.

- [mysqli::real\\_query](#)
- [mysqli\\_real\\_query](#)

Execute an SQL query

#### Description

Object oriented style (method):

```
bool real_query(string query);
```

Procedural style

```
bool mysqli_real_query(mysqli link,
                      string query);
```

Executes a single query against the database whose result can then be retrieved or stored using the `mysqli_store_result` or `mysqli_use_result` functions.

In order to determine if a given query should return a result set or not, see `mysqli_field_count`.

#### Parameters

<code>link</code>	Procedural style only: A link identifier returned by <code>mysqli_connect</code> or <code>mysqli_init</code>
<code>query</code>	The query, as a string.

#### Return Values

Returns `TRUE` on success or `FALSE` on failure.

#### See Also

`mysqli_query`  
`mysqli_store_result`  
`mysqli_use_result`

### 20.11.2.6.37. `mysqli::rollback`, `mysqli_rollback`

Copyright 1997-2008 the PHP Documentation Group.

- `mysqli::rollback`  
`mysqli_rollback`  
 Rolls back current transaction

#### Description

Object oriented style (method):

```
bool mysqli::rollback();
```

Procedural style:

```
bool mysqli_rollback(mysqli link);
```

Rollbacks the current transaction for the database.

#### Parameters

<code>link</code>	Procedural style only: A link identifier returned by <code>mysqli_connect</code> or <code>mysqli_init</code>
-------------------	--

#### Return Values

Returns `TRUE` on success or `FALSE` on failure.

#### Examples

#### Example 20.120. Object oriented style



```

<?php
$mysqli = new mysqli("localhost", "my_user", "my_password", "world");

/* check connection */
if (mysqli_connect_errno()) {
    printf("Connect failed: %s\n", mysqli_connect_error());
    exit();
}

/* disable autocommit */
$mysqli->autocommit(FALSE);

$mysqli->query("CREATE TABLE myCity LIKE City");
$mysqli->query("ALTER TABLE myCity Type=InnoDB");
$mysqli->query("INSERT INTO myCity SELECT * FROM City LIMIT 50");

/* commit insert */
$mysqli->commit();

/* delete all rows */
$mysqli->query("DELETE FROM myCity");

if ($result = $mysqli->query("SELECT COUNT(*) FROM myCity")) {
    $row = $result->fetch_row();
    printf("%d rows in table myCity.\n", $row[0]);
    /* Free result */
    $result->close();
}

/* Rollback */
$mysqli->rollback();

if ($result = $mysqli->query("SELECT COUNT(*) FROM myCity")) {
    $row = $result->fetch_row();
    printf("%d rows in table myCity (after rollback).\n", $row[0]);
    /* Free result */
    $result->close();
}

/* Drop table myCity */
$mysqli->query("DROP TABLE myCity");

$mysqli->close();
?>

```

### Example 20.121. Procedural style

```

<?php
$link = mysqli_connect("localhost", "my_user", "my_password", "world");

/* check connection */
if (mysqli_connect_errno()) {
    printf("Connect failed: %s\n", mysqli_connect_error());
    exit();
}

/* disable autocommit */
mysqli_autocommit($link, FALSE);

mysqli_query($link, "CREATE TABLE myCity LIKE City");
mysqli_query($link, "ALTER TABLE myCity Type=InnoDB");
mysqli_query($link, "INSERT INTO myCity SELECT * FROM City LIMIT 50");

/* commit insert */
mysqli_commit($link);

/* delete all rows */
mysqli_query($link, "DELETE FROM myCity");

if ($result = mysqli_query($link, "SELECT COUNT(*) FROM myCity")) {
    $row = mysqli_fetch_row($result);
    printf("%d rows in table myCity.\n", $row[0]);
    /* Free result */
    mysqli_free_result($result);
}

/* Rollback */
mysqli_rollback($link);

if ($result = mysqli_query($link, "SELECT COUNT(*) FROM myCity")) {
    $row = mysqli_fetch_row($result);
    printf("%d rows in table myCity (after rollback).\n", $row[0]);
    /* Free result */
    mysqli_free_result($result);
}

/* Drop table myCity */
mysqli_query($link, "DROP TABLE myCity");

```

```
mysqli_close($link);
?>
```

The above example will output:

```
0 rows in table myCity.
50 rows in table myCity (after rollback).
```

### See Also

[mysqli\\_commit](#)  
[mysqli\\_autocommit](#)

## 20.11.2.6.38. `mysqli::select_db`, `mysqli_select_db`

Copyright 1997-2008 the PHP Documentation Group.

- [mysqli::select\\_db](#)  
[mysqli\\_select\\_db](#)

Selects the default database for database queries

### Description

Object oriented style (method):

```
bool mysqli::select_db(string dbname);
```

Procedural style:

```
bool mysqli_select_db(mysqli link,
                      string dbname);
```

Selects the default database to be used when performing queries against the database connection.

#### Note

This function should only be used to change the default database for the connection. You can select the default database with 4th parameter in [mysqli\\_connect](#).

### Parameters

<i>link</i>	Procedural style only: A link identifier returned by <a href="#">mysqli_connect</a> or <a href="#">mysqli_init</a>
<i>dbname</i>	The database name.

### Return Values

Returns [TRUE](#) on success or [FALSE](#) on failure.

### Examples

#### Example 20.122. Object oriented style

```

<?php
$mysqli = new mysqli("localhost", "my_user", "my_password", "test");

/* check connection */
if (mysqli_connect_errno()) {
    printf("Connect failed: %s\n", mysqli_connect_error());
    exit();
}

/* return name of current default database */
if ($result = $mysqli->query("SELECT DATABASE()")) {
    $row = $result->fetch_row();
    printf("Default database is %s.\n", $row[0]);
    $result->close();
}

/* change db to world db */
$mysqli->select_db("world");

/* return name of current default database */
if ($result = $mysqli->query("SELECT DATABASE()")) {
    $row = $result->fetch_row();
    printf("Default database is %s.\n", $row[0]);
    $result->close();
}

$mysqli->close();
?>

```

### Example 20.123. Procedural style

```

<?php
$link = mysqli_connect("localhost", "my_user", "my_password", "test");

/* check connection */
if (mysqli_connect_errno()) {
    printf("Connect failed: %s\n", mysqli_connect_error());
    exit();
}

/* return name of current default database */
if ($result = mysqli_query($link, "SELECT DATABASE()")) {
    $row = mysqli_fetch_row($result);
    printf("Default database is %s.\n", $row[0]);
    mysqli_free_result($result);
}

/* change db to world db */
mysqli_select_db($link, "world");

/* return name of current default database */
if ($result = mysqli_query($link, "SELECT DATABASE()")) {
    $row = mysqli_fetch_row($result);
    printf("Default database is %s.\n", $row[0]);
    mysqli_free_result($result);
}

mysqli_close($link);
?>

```

The above example will output:

```

Default database is test.
Default database is world.

```

#### See Also

[mysqli\\_connect](#)  
[mysqli\\_real\\_connect](#)

#### 20.11.2.6.39. [mysqli::set\\_charset](#), [mysqli\\_set\\_charset](#)

Copyright 1997-2008 the PHP Documentation Group.

- `mysqli::set_charset`

`mysqli_set_charset`

Sets the default client character set

## Description

Object oriented style (method):

```
bool mysqli::set_charset(string charset);
```

Procedural style:

```
bool mysqli_set_charset(mysqli link,
                        string charset);
```

Sets the default character set to be used when sending data from and to the database server.

## Parameters

*link* Procedural style only: A link identifier returned by `mysqli_connect` or `mysqli_init`

*charset* The charset to be set as default.

## Return Values

Returns `TRUE` on success or `FALSE` on failure.

## Notes

### Note

To use this function on a Windows platform you need MySQL client library version 4.1.11 or above (for MySQL 5.0 you need 5.0.6 or above).

### Note

This is the preferred way to change the charset. Using `mysqli::query` to execute `SET NAMES ..` is not recommended.

## Examples

### Example 20.124. Object oriented style

```
<?php
$mysqli = new mysqli("localhost", "my_user", "my_password", "test");

/* check connection */
if (mysqli_connect_errno()) {
    printf("Connect failed: %s\n", mysqli_connect_error());
    exit();
}

/* change character set to utf8 */
if (!$mysqli->set_charset("utf8")) {
    printf("Error loading character set utf8: %s\n", $mysqli->error);
} else {
    printf("Current character set: %s\n", $mysqli->character_set_name());
}

$mysqli->close();
?>
```

**Example 20.125. Procedural style**

```

<?php
$link = mysqli_connect('localhost', 'my_user', 'my_password', 'test');

/* check connection */
if (mysqli_connect_errno()) {
    printf("Connect failed: %s\n", mysqli_connect_error());
    exit();
}

/* change character set to utf8 */
if (!mysqli_set_charset($link, "utf8")) {
    printf("Error loading character set utf8: %s\n", mysqli_error($link));
} else {
    printf("Current character set: %s\n", mysqli_character_set_name($link));
}

mysqli_close($link);
?>

```

The above example will output:

```
Current character set: utf8
```

**See Also**

[mysqli\\_character\\_set\\_name](#)  
[mysqli\\_real\\_escape\\_string](#)  
[List of character sets that MySQL supports](#)

**20.11.2.6.40. [mysqli::set\\_local\\_infile\\_default](#), [mysqli\\_set\\_local\\_infile\\_default](#)**

Copyright 1997-2008 the PHP Documentation Group.

- [mysqli::set\\_local\\_infile\\_default](#)  
[mysqli\\_set\\_local\\_infile\\_default](#)  
 Unsets user defined handler for load local infile command

**Description**

```
void mysqli_set_local_infile_default(mysqli link);
```

Deactivates a [LOAD DATA INFILE LOCAL](#) handler previously set with [mysqli\\_set\\_local\\_infile\\_handler](#).

**Parameters**

*link* Procedural style only: A link identifier returned by [mysqli\\_connect](#) or [mysqli\\_init](#)

**Return Values**

No value is returned.

**Examples**

See [mysqli\\_set\\_local\\_infile\\_handler](#) examples

**See Also**

`mysqli_set_local_infile_handler`

### 20.11.2.6.41. `mysqli::set_local_infile_handler`, `mysqli_set_local_infile_handler`

Copyright 1997-2008 the PHP Documentation Group.

- `mysqli::set_local_infile_handler`

`mysqli_set_local_infile_handler`

Set callback function for LOAD DATA LOCAL INFILE command

#### Description

```
bool mysqli_set_local_infile_handler(mysqli link,
                                     callback read_func);
```

Object oriented style (method)

```
mysqli {
    bool set_local_infile_handler(mysqli link,
                                 callback read_func);
}
```

Set callback function for LOAD DATA LOCAL INFILE command

The callback's task is to read input from the file specified in the `LOAD DATA LOCAL INFILE` and to reformat it into the format understood by `LOAD DATA INFILE`.

The returned data needs to match the format specified in the `LOAD DATA`

#### Parameters

<i>link</i>	Procedural style only: A link identifier returned by <code>mysqli_connect</code> or <code>mysqli_init</code>
<i>read_func</i>	A callback function or object method taking the following parameters:
<i>stream</i>	A PHP stream associated with the SQL commands <code>INFILE</code>
<i>&amp;buffer</i>	A string buffer to store the rewritten input into
<i>buflen</i>	The maximum number of characters to be stored in the buffer
<i>&amp;errmsg</i>	If an error occurs you can store an error message in here

The callback function should return the number of characters stored in the *buffer* or a negative value if an error occurred.

#### Return Values

Returns `TRUE` on success or `FALSE` on failure.

#### Examples

##### Example 20.126. Object oriented style

```
<?php
$db = mysqli_init();
$db->real_connect("localhost", "root", "", "test");

function callme($stream, &$buffer, $buflen, &$errmsg)
{
```

```

$buffer = fgets($stream);

echo $buffer;

// convert to upper case and replace "," delimiter with [TAB]
$buffer = strtoupper(str_replace(",","\\t", $buffer));

return strlen($buffer);
}

echo "Input:\\n";

$db->set_local_infile_handler("callme");
$db->query("LOAD DATA LOCAL INFILE 'input.txt' INTO TABLE t1");
$db->set_local_infile_default();

$res = $db->query("SELECT * FROM t1");

echo "\\nResult:\\n";
while ($row = $res->fetch_assoc()) {
    echo join(", ", $row). "\\n";
}
?>

```

### Example 20.127. Procedural style

```

<?php
$db = mysqli_init();
mysqli_real_connect($db, "localhost", "root", "", "test");

function callme($stream, &$buffer, $buflen, &$errmsg)
{
    $buffer = fgets($stream);

    echo $buffer;

    // convert to upper case and replace "," delimiter with [TAB]
    $buffer = strtoupper(str_replace(",","\\t", $buffer));

    return strlen($buffer);
}

echo "Input:\\n";

mysqli_set_local_infile_handler($db, "callme");
mysqli_query($db, "LOAD DATA LOCAL INFILE 'input.txt' INTO TABLE t1");
mysqli_set_local_infile_default($db);

$res = mysqli_query($db, "SELECT * FROM t1");

echo "\\nResult:\\n";
while ($row = mysqli_fetch_assoc($res)) {
    echo join(", ", $row). "\\n";
}
?>

```

The above example will output:

```

Input:
23,foo
42,bar

Output:
23,FOO
42,BAR

```

### See Also

[mysqli\\_set\\_local\\_infile\\_default](#)

## 20.11.2.6.42. `mysqli->sqlstate`, `mysqli_sqlstate`

Copyright 1997-2008 the PHP Documentation Group.

- `mysqli->sqlstate`

`mysqli_sqlstate`

Returns the SQLSTATE error from previous MySQL operation

### Description

Object oriented style (property):

```
mysqli {
    string sqlstate ;
}
```

Procedural style:

```
string mysqli_sqlstate(mysqli link);
```

Returns a string containing the SQLSTATE error code for the last error. The error code consists of five characters. '00000' means no error. The values are specified by ANSI SQL and ODBC. For a list of possible values, see <http://dev.mysql.com/doc/mysql/en/error-handling.html>.

### Note

Note that not all MySQL errors are yet mapped to SQLSTATE's. The value `HY000` (general error) is used for un-mapped errors.

### Parameters

*link*

Procedural style only: A link identifier returned by `mysqli_connect` or `mysqli_init`

### Return Values

Returns a string containing the SQLSTATE error code for the last error. The error code consists of five characters. '00000' means no error.

### Examples

#### Example 20.128. Object oriented style

```
<?php
$mysqli = new mysqli("localhost", "my_user", "my_password", "world");

/* check connection */
if (mysqli_connect_errno()) {
    printf("Connect failed: %s\n", mysqli_connect_error());
    exit();
}

/* Table City already exists, so we should get an error */
if (!$mysqli->query("CREATE TABLE City (ID INT, Name VARCHAR(30))")) {
    printf("Error - SQLSTATE %s.\n", $mysqli->sqlstate);
}

$mysqli->close();
?>
```

#### Example 20.129. Procedural style



```

<?php
$link = mysqli_connect("localhost", "my_user", "my_password", "world");

/* check connection */
if (mysqli_connect_errno()) {
    printf("Connect failed: %s\n", mysqli_connect_error());
    exit();
}

/* Table City already exists, so we should get an error */
if (!mysqli_query($link, "CREATE TABLE City (ID INT, Name VARCHAR(30))")) {
    printf("Error - SQLSTATE %s.\n", mysqli_sqlstate($link));
}

mysqli_close($link);
?>

```

The above example will output:

```
Error - SQLSTATE 42S01.
```

### See Also

[mysqli\\_errno](#)  
[mysqli\\_error](#)

#### 20.11.2.6.43. [mysqli::ssl\\_set](#), [mysqli\\_ssl\\_set](#)

Copyright 1997-2008 the PHP Documentation Group.

- [mysqli::ssl\\_set](#)  
[mysqli\\_ssl\\_set](#)

Used for establishing secure connections using SSL

### Description

Object oriented style (method):

```

bool mysqli::ssl_set(string key,
                    string cert,
                    string ca,
                    string capath,
                    string cipher);

```

Procedural style:

```

bool mysqli_ssl_set(mysqli link,
                    string key,
                    string cert,
                    string ca,
                    string capath,
                    string cipher);

```

Used for establishing secure connections using SSL. It must be called before [mysqli\\_real\\_connect](#). This function does nothing unless OpenSSL support is enabled.

### Parameters

[link](#) Procedural style only: A link identifier returned by [mysqli\\_connect](#) or [mysqli\\_init](#)  
[key](#) The path name to the key file.

<code>cert</code>	The path name to the certificate file.
<code>ca</code>	The path name to the certificate authority file.
<code>capath</code>	The pathname to a directory that contains trusted SSL CA certificates in PEM format.
<code>cipher</code>	A list of allowable ciphers to use for SSL encryption.

Any unused SSL parameters may be given as `NULL`

#### Return Values

This function always returns `TRUE` value. If SSL setup is incorrect `mysqli_real_connect` will return an error when you attempt to connect.

#### See Also

`mysqli_options`  
`mysqli_real_connect`

### 20.11.2.6.44. `mysqli::stat`, `mysqli_stat`

Copyright 1997-2008 the PHP Documentation Group.

- `mysqli::stat`

`mysqli_stat`

Gets the current system status

#### Description

Object oriented style (method):

```
string mysqli::stat();
```

Procedural style:

```
string mysqli_stat(mysqli link);
```

`mysqli_stat` returns a string containing information similar to that provided by the 'mysqladmin status' command. This includes uptime in seconds and the number of running threads, questions, reloads, and open tables.

#### Parameters

`link` Procedural style only: A link identifier returned by `mysqli_connect` or `mysqli_init`

#### Return Values

A string describing the server status. `FALSE` if an error occurred.

#### Examples

##### Example 20.130. Object oriented style

```
<?php
$mysqli = new mysqli("localhost", "my_user", "my_password", "world");

/* check connection */
if (mysqli_connect_errno()) {
    printf("Connect failed: %s\n", mysqli_connect_error());
    exit();
}

printf ("System status: %s\n", $mysqli->stat());
```

```
$mysqli->close();
?>
```

### Example 20.131. Procedural style

```
<?php
$link = mysqli_connect("localhost", "my_user", "my_password", "world");

/* check connection */
if (mysqli_connect_errno()) {
    printf("Connect failed: %s\n", mysqli_connect_error());
    exit();
}

printf("System status: %s\n", mysqli_stat($link));

mysqli_close($link);
?>
```

The above example will output:

```
System status: Uptime: 272  Threads: 1  Questions: 5340  Slow queries: 0
Opens: 13  Flush tables: 1  Open tables: 0  Queries per second avg: 19.632
Memory in use: 8496K  Max memory used: 8560K
```

### See Also

[mysqli\\_get\\_server\\_info](#)

## 20.11.2.6.45. [mysqli::stmt\\_init](#), [mysqli\\_stmt\\_init](#)

Copyright 1997-2008 the PHP Documentation Group.

- [mysqli::stmt\\_init](#)
- [mysqli\\_stmt\\_init](#)

Initializes a statement and returns an object for use with [mysqli\\_stmt\\_prepare](#)

### Description

Object oriented style (property):

```
mysqli {
    mysqli_stmt stmt_init();
}
```

Procedural style :

```
mysqli_stmt mysqli_stmt_init(mysqli link);
```

Allocates and initializes a statement object suitable for [mysqli\\_stmt\\_prepare](#).

### Note

Any subsequent calls to any [mysqli\\_stmt](#) function will fail until [mysqli\\_stmt\\_prepare](#) was called.

**Parameters**

*link* Procedural style only: A link identifier returned by `mysqli_connect` or `mysqli_init`

**Return Values**

Returns an object.

**See Also**

`mysqli_stmt_prepare`

**20.11.2.6.46. `mysqli::store_result`, `mysqli_store_result`**

Copyright 1997-2008 the PHP Documentation Group.

- `mysqli::store_result`  
`mysqli_store_result`

Transfers a result set from the last query

**Description**

Object oriented style (method):

```
mysqli_result store_result();
```

Procedural style:

```
mysqli_result mysqli_store_result(mysqli link);
```

Transfers the result set from the last query on the database connection represented by the *link* parameter to be used with the `mysqli_data_seek` function.

**Parameters**

*link* Procedural style only: A link identifier returned by `mysqli_connect` or `mysqli_init`

**Return Values**

Returns a buffered result object or `FALSE` if an error occurred.

**Note**

`mysqli_store_result` returns `FALSE` in case the query didn't return a result set (if the query was, for example an INSERT statement). This function also returns `FALSE` if the reading of the result set failed. You can check if you have got an error by checking if `mysqli_error` doesn't return an empty string, if `mysqli_errno` returns a non zero value, or if `mysqli_field_count` returns a non zero value. Also possible reason for this function returning `FALSE` after successful call to `mysqli_query` can be too large result set (memory for it cannot be allocated). If `mysqli_field_count` returns a non-zero value, the statement should have produced a non-empty result set.

**Notes****Note**

Although it is always good practice to free the memory used by the result of a query using the `mysqli_free_result` function, when transferring large result sets using the `mysqli_store_result` this becomes particularly important.

**Examples**

See `mysqli_multi_query`.

#### See Also

`mysqli_real_query`  
`mysqli_use_result`

### 20.11.2.6.47. `mysqli::thread_id`, `mysqli_thread_id`

Copyright 1997-2008 the PHP Documentation Group.

- `mysqli::thread_id`  
`mysqli_thread_id`

Returns the thread ID for the current connection

#### Description

Object oriented style (property):

```
mysqli {
    int thread_id ;
}
```

Procedural style:

```
int mysqli_thread_id(mysqli link);
```

The `mysqli_thread_id` function returns the thread ID for the current connection which can then be killed using the `mysqli_kill` function. If the connection is lost and you reconnect with `mysqli_ping`, the thread ID will be other. Therefore you should get the thread ID only when you need it.

#### Note

The thread ID is assigned on a connection-by-connection basis. Hence, if the connection is broken and then re-established a new thread ID will be assigned.

To kill a running query you can use the SQL command `KILL QUERY processid`.

#### Parameters

`link` Procedural style only: A link identifier returned by `mysqli_connect` or `mysqli_init`

#### Return Values

Returns the Thread ID for the current connection.

#### Examples

##### Example 20.132. Object oriented style

```
<?php
$mysqli = new mysqli("localhost", "my_user", "my_password", "world");

/* check connection */
if (mysqli_connect_errno()) {
    printf("Connect failed: %s\n", mysqli_connect_error());
    exit();
}

/* determine our thread id */
$thread_id = $mysqli->thread_id;

/* Kill connection */
```

```

$mysqli->kill($thread_id);

/* This should produce an error */
if (!$mysqli->query("CREATE TABLE myCity LIKE City")) {
    printf("Error: %s\n", $mysqli->error);
    exit;
}

/* close connection */
$mysqli->close();
?>

```

### Example 20.133. Procedural style

```

<?php
$link = mysqli_connect("localhost", "my_user", "my_password", "world");

/* check connection */
if (mysqli_connect_errno()) {
    printf("Connect failed: %s\n", mysqli_connect_error());
    exit();
}

/* determine our thread id */
$thread_id = mysqli_thread_id($link);

/* Kill connection */
mysqli_kill($link, $thread_id);

/* This should produce an error */
if (!$mysqli->query($link, "CREATE TABLE myCity LIKE City")) {
    printf("Error: %s\n", mysqli_error($link));
    exit;
}

/* close connection */
mysqli_close($link);
?>

```

The above example will output:

```
Error: MySQL server has gone away
```

### See Also

[mysqli\\_kill](#)

#### 20.11.2.6.48. [mysqli::thread\\_safe](#), [mysqli\\_thread\\_safe](#)

Copyright 1997-2008 the PHP Documentation Group.

- [mysqli::thread\\_safe](#)
- [mysqli\\_thread\\_safe](#)

Returns whether thread safety is given or not

### Description

Procedural style:

```
bool mysqli_thread_safe();
```

Tells whether the client library is compiled as thread-safe.

**Return Values**

`TRUE` if the client library is thread-safe, otherwise `FALSE`.

**20.11.2.6.49. `mysqli::use_result`, `mysqli_use_result`**

Copyright 1997-2008 the PHP Documentation Group.

- `mysqli::use_result`  
`mysqli_use_result`

Initiate a result set retrieval

**Description**

Object oriented style (method):

```
mysqli_result use_result();
```

Procedural style:

```
mysqli_result mysqli_use_result(mysqli link);
```

Used to initiate the retrieval of a result set from the last query executed using the `mysqli_real_query` function on the database connection.

Either this or the `mysqli_store_result` function must be called before the results of a query can be retrieved, and one or the other must be called to prevent the next query on that database connection from failing.

**Note**

The `mysqli_use_result` function does not transfer the entire result set from the database and hence cannot be used functions such as `mysqli_data_seek` to move to a particular row within the set. To use this functionality, the result set must be stored using `mysqli_store_result`. One should not use `mysqli_use_result` if a lot of processing on the client side is performed, since this will tie up the server and prevent other threads from updating any tables from which the data is being fetched.

**Return Values**

Returns an unbuffered result object or `FALSE` if an error occurred.

**Examples****Example 20.134. Object oriented style**

```
<?php
$mysqli = new mysqli("localhost", "my_user", "my_password", "world");

/* check connection */
if (mysqli_connect_errno()) {
    printf("Connect failed: %s\n", mysqli_connect_error());
    exit();
}

$query = "SELECT CURRENT_USER()";
$query .= "SELECT Name FROM City ORDER BY ID LIMIT 20, 5";

/* execute multi query */
if ($mysqli->multi_query($query)) {
    do {
        /* store first result set */
        if ($result = $mysqli->use_result()) {
            while ($row = $result->fetch_row()) {
                printf("%s\n", $row[0]);
            }
            $result->close();
        }
        /* print divider */
        if ($mysqli->more_results()) {
            printf("-----\n");
        }
    } while ($mysqli->next_result());
}
```

```

/* close connection */
mysqli->close();
?>

```

### Example 20.135. Procedural style

```

<?php
$link = mysqli_connect("localhost", "my_user", "my_password", "world");

/* check connection */
if (mysqli_connect_errno()) {
    printf("Connect failed: %s\n", mysqli_connect_error());
    exit();
}

$query = "SELECT CURRENT_USER()";
$query .= "SELECT Name FROM City ORDER BY ID LIMIT 20, 5";

/* execute multi query */
if (mysqli_multi_query($link, $query)) {
    do {
        /* store first result set */
        if ($result = mysqli_use_result($link)) {
            while ($row = mysqli_fetch_row($result)) {
                printf("%s\n", $row[0]);
            }
            mysqli_free_result($result);
        }
        /* print divider */
        if (mysqli_more_results($link)) {
            printf("-----\n");
        }
    } while (mysqli_next_result($link));
}

/* close connection */
mysqli_close($link);
?>

```

The above example will output:

```

my_user@localhost
-----
Amersfoort
Maastricht
Dordrecht
Leiden
Haarlemmermeer

```

#### See Also

[mysqli\\_real\\_query](#)  
[mysqli\\_store\\_result](#)

#### 20.11.2.6.50. `mysqli::warning_count`, `mysqli_warning_count`

Copyright 1997-2008 the PHP Documentation Group.

- [mysqli::warning\\_count](#)  
[mysqli\\_warning\\_count](#)

Returns the number of warnings from the last query for the given link

#### Description



Object oriented style (property):

```
mysqli {
    int warning_count ;
}
```

Procedural style:

```
int mysqli_warning_count(mysqli link);
```

Returns the number of warnings from the last query in the connection.

### Note

For retrieving warning messages you can use the SQL command `SHOW WARNINGS [limit row_count]`.

### Parameters

*link* Procedural style only: A link identifier returned by `mysqli_connect` or `mysqli_init`

### Return Values

Number of warnings or zero if there are no warnings.

### Examples

#### Example 20.136. Object oriented style

```
<?php
$mysqli = new mysqli("localhost", "my_user", "my_password", "world");

/* check connection */
if (mysqli_connect_errno()) {
    printf("Connect failed: %s\n", mysqli_connect_error());
    exit();
}

$mysqli->query("CREATE TABLE myCity LIKE City");

/* a remarkable city in Wales */
$query = "INSERT INTO myCity (CountryCode, Name) VALUES('GBR',
'Llanfairpwllgwyngyllgogerychwyrndrobwlllandysiliogogoch)";
$mysqli->query($query);

if ($mysqli->warning_count) {
    if ($result = $mysqli->query("SHOW WARNINGS")) {
        $row = $result->fetch_row();
        printf("%s (%d): %s\n", $row[0], $row[1], $row[2]);
        $result->close();
    }
}

/* close connection */
$mysqli->close();
?>
```

#### Example 20.137. Procedural style

```
<?php
$link = mysqli_connect("localhost", "my_user", "my_password", "world");

/* check connection */
if (mysqli_connect_errno()) {
    printf("Connect failed: %s\n", mysqli_connect_error());
    exit();
}

mysqli_query($link, "CREATE TABLE myCity LIKE City");
```

```

/* a remarkable long city name in Wales */
$query = "INSERT INTO myCity (CountryCode, Name) VALUES('GBR',
    'Llanfairpwllgwyngyllgogerychwyrndrobwllllantysiliogogoch')";

mysqli_query($link, $query);

if (mysqli_warning_count($link)) {
    if ($result = mysqli_query($link, "SHOW WARNINGS")) {
        $row = mysqli_fetch_row($result);
        printf("%s (%d): %s\n", $row[0], $row[1], $row[2]);
        mysqli_free_result($result);
    }
}

/* close connection */
mysqli_close($link);
?>

```

The above example will output:

```
Warning (1264): Data truncated for column 'Name' at row 1
```

#### See Also

[mysqli\\_errno](#)  
[mysqli\\_error](#)  
[mysqli\\_sqlstate](#)

### 20.11.2.7. The MySQLi\_STMT class ([MySQLi\\_STMT](#))

Copyright 1997-2008 the PHP Documentation Group.

Represents a prepared statement.

```

MySQLi_STMT {
    MySQLi_STMT

    Properties

    int affected_rows ;

    int errno ;

    string error ;

    int field_count ;

    int insert_id ;

    int num_rows ;

    int param_count ;

    string sqlstate ;

    Methods

    int mysqli_stmt_affected_rows(mysqli_stmt stmt);

    int mysqli_stmt::attr_get(int attr);

    bool mysqli_stmt::attr_set(int attr,
                               int mode);

```

```

bool mysqli_stmt::bind_param(string types,
                             mixed var1,
                             mixed ...);

bool mysqli_stmt::bind_result(mixed var1,
                              mixed ...);

bool mysqli_stmt::close();

void mysqli_stmt::data_seek(int offset);

int mysqli_stmt_errno(mysqli_stmt stmt);

string mysqli_stmt_error(mysqli_stmt stmt);

bool mysqli_stmt::execute();

bool mysqli_stmt::fetch();

int mysqli_stmt_field_count(mysqli_stmt stmt);

void mysqli_stmt::free_result();

object mysqli_stmt::get_warnings(mysqli_stmt stmt);

mixed mysqli_stmt_insert_id(mysqli_stmt stmt);

int mysqli_stmt_num_rows(mysqli_stmt stmt);

int mysqli_stmt_param_count(mysqli_stmt stmt);

mixed mysqli_stmt::prepare(string query);

bool mysqli_stmt::reset();

mysqli_result mysqli_stmt::result_metadata();

bool mysqli_stmt::send_long_data(int param_nr,
                                 string data);

string mysqli_stmt_sqlstate(mysqli_stmt stmt);

bool mysqli_stmt::store_result();
}

```

#### 20.11.2.7.1. `mysqli_stmt->affected_rows`, `mysqli_stmt_affected_rows`

Copyright 1997-2008 the PHP Documentation Group.

- `mysqli_stmt->affected_rows`  
`mysqli_stmt_affected_rows`

Returns the total number of rows changed, deleted, or inserted by the last executed statement

##### Description

Object oriented style (property):

```
mysqli_stmt {
```

```
int affected_rows ;
}
```

Procedural style :

```
int mysqli_stmt_affected_rows(mysqli_stmt stmt);
```

Returns the number of rows affected by [INSERT](#), [UPDATE](#), or [DELETE](#) query.

This function only works with queries which update a table. In order to get the number of rows from a [SELECT](#) query, use [mysqli\\_stmt\\_num\\_rows](#) instead.

### Parameters

*stmt* Procedural style only: A statement identifier returned by [mysqli\\_stmt\\_init](#).

### Return Values

An integer greater than zero indicates the number of rows affected or retrieved. Zero indicates that no records were updated for an [UPDATE](#)/[DELETE](#) statement, no rows matched the [WHERE](#) clause in the query or that no query has yet been executed. -1 indicates that the query has returned an error. NULL indicates an invalid argument was supplied to the function.

#### Note

If the number of affected rows is greater than maximal PHP int value, the number of affected rows will be returned as a string value.

### Examples

#### Example 20.138. Object oriented style

```
<?php
$link = new mysqli("localhost", "my_user", "my_password", "world");

/* check connection */
if (mysqli_connect_errno()) {
    printf("Connect failed: %s\n", mysqli_connect_error());
    exit();
}

/* create temp table */
$link->query("CREATE TEMPORARY TABLE myCountry LIKE Country");

$query = "INSERT INTO myCountry SELECT * FROM Country WHERE Code LIKE ?";

/* prepare statement */
if ($stmt = $link->prepare($query)) {

    /* Bind variable for placeholder */
    $code = 'A%';
    $stmt->bind_param("s", $code);

    /* execute statement */
    $stmt->execute();

    printf("rows inserted: %d\n", $stmt->affected_rows);

    /* close statement */
    $stmt->close();
}

/* close connection */
$link->close();
?>
```

#### Example 20.139. Procedural style

```
<?php
$link = mysqli_connect("localhost", "my_user", "my_password", "world");
```

```

/* check connection */
if (mysqli_connect_errno()) {
    printf("Connect failed: %s\n", mysqli_connect_error());
    exit();
}

/* create temp table */
mysqli_query($link, "CREATE TEMPORARY TABLE myCountry LIKE Country");

$query = "INSERT INTO myCountry SELECT * FROM Country WHERE Code LIKE ?";

/* prepare statement */
if ($stmt = mysqli_prepare($link, $query)) {

    /* Bind variable for placeholder */
    $code = 'A%';
    mysqli_stmt_bind_param($stmt, "s", $code);

    /* execute statement */
    mysqli_stmt_execute($stmt);

    printf("rows inserted: %d\n", mysqli_stmt_affected_rows($stmt));

    /* close statement */
    mysqli_stmt_close($stmt);
}

/* close connection */
mysqli_close($link);
?>

```

The above example will output:

```
rows inserted: 17
```

### See Also

[mysqli\\_stmt\\_num\\_rows](#)  
[mysqli\\_prepare](#)

#### 20.11.2.7.2. [mysqli\\_stmt::attr\\_get](#), [mysqli\\_stmt\\_attr\\_get](#)

Copyright 1997-2008 the PHP Documentation Group.

- [mysqli\\_stmt::attr\\_get](#)  
[mysqli\\_stmt\\_attr\\_get](#)

Used to get the current value of a statement attribute

### Description

Object oriented style (method):

```
int mysqli_stmt::attr_get(int attr);
```

Procedural style:

```
int mysqli_stmt_attr_get(mysqli_stmt stmt,
int attr);
```

Gets the current value of a statement attribute.

### Parameters

*stmt* Procedural style only: A statement identifier returned by `mysqli_stmt_init`.

*attr* The attribute that you want to get.

### Return Values

Returns `FALSE` if the attribute is not found, otherwise returns the value of the attribute.

### 20.11.2.7.3. `mysqli_stmt::attr_set`, `mysqli_stmt_attr_set`

Copyright 1997-2008 the PHP Documentation Group.

- `mysqli_stmt::attr_set`

`mysqli_stmt_attr_set`

Used to modify the behavior of a prepared statement

### Description

Object oriented style (method):

```
bool mysqli_stmt::attr_set(int attr,
                          int mode);
```

Procedural style:

```
bool mysqli_stmt_attr_set(mysqli_stmt stmt,
                          int attr,
                          int mode);
```

Used to modify the behavior of a prepared statement. This function may be called multiple times to set several attributes.

### Parameters

*stmt* Procedural style only: A statement identifier returned by `mysqli_stmt_init`.

*attr* The attribute that you want to set. It can have one of the following values:

**Table 20.11. Attribute values**

Character	Description
<code>MYSQLI_STMT_ATTR_UPDATE_MAX_LENGTH</code>	If set to 1, causes <code>mysqli_stmt_store_result</code> to update the metadata <code>MYSQL_FIELD-&gt;max_length</code> value.
<code>MYSQLI_STMT_ATTR_CURSOR_TYPE</code>	Type of cursor to open for statement when <code>mysqli_stmt_execute</code> is invoked. <i>mode</i> can be <code>MYSQLI_CURSOR_TYPE_NO_CURSOR</code> (the default) or <code>MYSQLI_CURSOR_TYPE_READ_ONLY</code> .
<code>MYSQLI_STMT_ATTR_PREFETCH_ROWS</code>	Number of rows to fetch from server at a time when using a cursor. <i>mode</i> can be in the range from 1 to the maximum value of unsigned long. The default is 1.

If you use the `MYSQLI_STMT_ATTR_CURSOR_TYPE` option with `MYSQLI_CURSOR_TYPE_READ_ONLY`, a cursor is opened for the statement when you invoke `mysqli_stmt_execute`. If there is already an open cursor from a previous `mysqli_stmt_execute` call, it closes the cursor before opening a new one. `mysqli_stmt_reset` also closes any open cursor before preparing the statement for re-execution. `mysqli_stmt_free_result` closes any open cursor.

If you open a cursor for a prepared statement, `mysqli_stmt_store_result` is unnecessary.

*mode* The value to assign to the attribute.

#### 20.11.2.7.4. `mysqli_stmt::bind_param`, `mysqli_stmt_bind_param`

Copyright 1997-2008 the PHP Documentation Group.

- `mysqli_stmt::bind_param`

`mysqli_stmt_bind_param`

Binds variables to a prepared statement as parameters

##### Description

Object oriented style (method):

```
bool mysqli_stmt::bind_param(string types,
                             mixed var1,
                             mixed ...);
```

Procedural style:

```
bool mysqli_stmt_bind_param(mysqli_stmt stmt,
                             string types,
                             mixed var1,
                             mixed ...);
```

Bind variables for the parameter markers in the SQL statement that was passed to `mysqli_prepare`.

##### Note

If data size of a variable exceeds max. allowed packet size (`max_allowed_packet`), you have to specify `b` in `types` and use `mysqli_stmt_send_long_data` to send the data in packets.

##### Parameters

`stmt` Procedural style only: A statement identifier returned by `mysqli_stmt_init`.

`types` A string that contains one or more characters which specify the types for the corresponding bind variables:

**Table 20.12. Type specification chars**

Character	Description
i	corresponding variable has type integer
d	corresponding variable has type double
s	corresponding variable has type string
b	corresponding variable is a blob and will be sent in packets

`var1` The number of variables and length of string `types` must match the parameters in the statement.

##### Return Values

Returns `TRUE` on success or `FALSE` on failure.

##### Examples

##### Example 20.140. Object oriented style

```
<?php
$mysqli = new mysqli('localhost', 'my_user', 'my_password', 'world');

/* check connection */
if (mysqli_connect_errno()) {
```

```

    printf("Connect failed: %s\n", mysqli_connect_error());
    exit();
}

$stmt = $mysqli->prepare("INSERT INTO CountryLanguage VALUES (?, ?, ?, ?)");
$stmt->bind_param('sssd', $code, $language, $official, $percent);

$code = 'DEU';
$language = 'Bavarian';
$official = "F";
$percent = 11.2;

/* execute prepared statement */
$stmt->execute();

printf("%d Row inserted.\n", $stmt->affected_rows);

/* close statement and connection */
$stmt->close();

/* Clean up table CountryLanguage */
$mysqli->query("DELETE FROM CountryLanguage WHERE Language='Bavarian'");
printf("%d Row deleted.\n", $mysqli->affected_rows);

/* close connection */
$mysqli->close();
?>

```

### Example 20.141. Procedural style

```

<?php
$link = mysqli_connect('localhost', 'my_user', 'my_password', 'world');

/* check connection */
if (!$link) {
    printf("Connect failed: %s\n", mysqli_connect_error());
    exit();
}

$stmt = mysqli_prepare($link, "INSERT INTO CountryLanguage VALUES (?, ?, ?, ?)");
mysqli_stmt_bind_param($stmt, 'sssd', $code, $language, $official, $percent);

$code = 'DEU';
$language = 'Bavarian';
$official = "F";
$percent = 11.2;

/* execute prepared statement */
mysqli_stmt_execute($stmt);

printf("%d Row inserted.\n", mysqli_stmt_affected_rows($stmt));

/* close statement and connection */
mysqli_stmt_close($stmt);

/* Clean up table CountryLanguage */
mysqli_query($link, "DELETE FROM CountryLanguage WHERE Language='Bavarian'");
printf("%d Row deleted.\n", mysqli_affected_rows($link));

/* close connection */
mysqli_close($link);
?>

```

The above example will output:

```

1 Row inserted.
1 Row deleted.

```

### See Also

[mysqli\\_stmt\\_bind\\_result](#)  
[mysqli\\_stmt\\_execute](#)  
[mysqli\\_stmt\\_fetch](#)



```
mysqli_prepare
mysqli_stmt_send_long_data
mysqli_stmt_errno
mysqli_stmt_error
```

### 20.11.2.7.5. `mysqli_stmt::bind_result`, `mysqli_stmt_bind_result`

Copyright 1997-2008 the PHP Documentation Group.

- `mysqli_stmt::bind_result`  
`mysqli_stmt_bind_result`

Binds variables to a prepared statement for result storage

#### Description

Object oriented style (method):

```
bool mysqli_stmt::bind_result(mixed var1,
                             mixed ...);
```

Procedural style:

```
bool mysqli_stmt_bind_result(mysqli_stmt stmt,
                             mixed var1,
                             mixed ...);
```

Binds columns in the result set to variables.

When `mysqli_stmt_fetch` is called to fetch data, the MySQL client/server protocol places the data for the bound columns into the specified variables `var1`, ...

#### Note

Note that all columns must be bound after `mysqli_stmt_execute` and prior to calling `mysqli_stmt_fetch`. Depending on column types bound variables can silently change to the corresponding PHP type.

A column can be bound or rebound at any time, even after a result set has been partially retrieved. The new binding takes effect the next time `mysqli_stmt_fetch` is called.

#### Parameters

`stmt` Procedural style only: A statement identifier returned by `mysqli_stmt_init`.  
`var1` The variable to be bound.

#### Return Values

Returns `TRUE` on success or `FALSE` on failure.

#### Examples

#### Example 20.142. Object oriented style

```
<?php
mysqli = new mysqli("localhost", "my_user", "my_password", "world");

if (mysqli_connect_errno()) {
    printf("Connect failed: %s\n", mysqli_connect_error());
    exit();
}

/* prepare statement */
if ($stmt = $mysqli->prepare("SELECT Code, Name FROM Country ORDER BY Name LIMIT 5")) {
    $stmt->execute();

    /* bind variables to prepared statement */
    $stmt->bind_result($col1, $col2);
```

```

/* fetch values */
while ($stmt->fetch()) {
    printf("%s %s\n", $col1, $col2);
}

/* close statement */
$stmt->close();
}
/* close connection */
mysqli->close();
?>

```

### Example 20.143. Procedural style

```

<?php
$link = mysqli_connect("localhost", "my_user", "my_password", "world");

/* check connection */
if (!$link) {
    printf("Connect failed: %s\n", mysqli_connect_error());
    exit();
}

/* prepare statement */
if ($stmt = mysqli_prepare($link, "SELECT Code, Name FROM Country ORDER BY Name LIMIT 5")) {
    mysqli_stmt_execute($stmt);

    /* bind variables to prepared statement */
    mysqli_stmt_bind_result($stmt, $col1, $col2);

    /* fetch values */
    while (mysqli_stmt_fetch($stmt)) {
        printf("%s %s\n", $col1, $col2);
    }

    /* close statement */
    mysqli_stmt_close($stmt);
}

/* close connection */
mysqli_close($link);
?>

```

The above example will output:

```

AFG Afghanistan
ALB Albania
DZA Algeria
ASM American Samoa
AND Andorra

```

#### See Also

[mysqli\\_stmt\\_bind\\_param](#)  
[mysqli\\_stmt\\_execute](#)  
[mysqli\\_stmt\\_fetch](#)  
[mysqli\\_prepare](#)  
[mysqli\\_stmt\\_prepare](#)  
[mysqli\\_stmt\\_init](#)  
[mysqli\\_stmt\\_errno](#)  
[mysqli\\_stmt\\_error](#)

#### 20.11.2.7.6. [mysqli\\_stmt::close](#), [mysqli\\_stmt\\_close](#)

Copyright 1997-2008 the PHP Documentation Group.

- `mysqli_stmt::close`  
`mysqli_stmt_close`  
Closes a prepared statement

### Description

Object oriented style (method):

```
bool mysqli_stmt::close();
```

Procedural style:

```
bool mysqli_stmt_close(mysqli_stmt stmt);
```

Closes a prepared statement. `mysqli_stmt_close` also deallocates the statement handle. If the current statement has pending or unread results, this function cancels them so that the next query can be executed.

### Parameters

*stmt* Procedural style only: A statement identifier returned by `mysqli_stmt_init`.

### Return Values

Returns `TRUE` on success or `FALSE` on failure.

### See Also

`mysqli_prepare`

## 20.11.2.7.7. `mysqli_stmt::data_seek`, `mysqli_stmt_data_seek`

Copyright 1997-2008 the PHP Documentation Group.

- `mysqli_stmt::data_seek`  
`mysqli_stmt_data_seek`  
Seeks to an arbitrary row in statement result set

### Description

Object oriented style (method):

```
void mysqli_stmt::data_seek(int offset);
```

Procedural style:

```
void mysqli_stmt_data_seek(mysqli_stmt stmt,  
int offset);
```

Seeks to an arbitrary result pointer in the statement result set.

`mysqli_stmt_store_result` must be called prior to `mysqli_stmt_data_seek`.

### Parameters

*stmt* Procedural style only: A statement identifier returned by `mysqli_stmt_init`.

*offset* Must be between zero and the total number of rows minus one (`mysqli_stmt_num_rows - 1`).

**Return Values**

No value is returned.

**Examples****Example 20.144. Object oriented style**

```
<?php
/* Open a connection */
$mysqli = new mysqli("localhost", "my_user", "my_password", "world");

/* check connection */
if (mysqli_connect_errno()) {
    printf("Connect failed: %s\n", mysqli_connect_error());
    exit();
}

$query = "SELECT Name, CountryCode FROM City ORDER BY Name";
if ($stmt = $mysqli->prepare($query)) {

    /* execute query */
    $stmt->execute();

    /* bind result variables */
    $stmt->bind_result($name, $code);

    /* store result */
    $stmt->store_result();

    /* seek to row no. 400 */
    $stmt->data_seek(399);

    /* fetch values */
    $stmt->fetch();

    printf ("City: %s Countrycode: %s\n", $name, $code);

    /* close statement */
    $stmt->close();
}

/* close connection */
$mysqli->close();
?>
```

**Example 20.145. Procedural style**

```
<?php
/* Open a connection */
$link = mysqli_connect("localhost", "my_user", "my_password", "world");

/* check connection */
if (mysqli_connect_errno()) {
    printf("Connect failed: %s\n", mysqli_connect_error());
    exit();
}

$query = "SELECT Name, CountryCode FROM City ORDER BY Name";
if ($stmt = mysqli_prepare($link, $query)) {

    /* execute query */
    mysqli_stmt_execute($stmt);

    /* bind result variables */
    mysqli_stmt_bind_result($stmt, $name, $code);

    /* store result */
    mysqli_stmt_store_result($stmt);

    /* seek to row no. 400 */
    mysqli_stmt_data_seek($stmt, 399);

    /* fetch values */
    mysqli_stmt_fetch($stmt);

    printf ("City: %s Countrycode: %s\n", $name, $code);

    /* close statement */
    mysqli_stmt_close($stmt);
}

/* close connection */
```

```
mysqli_close($link);
?>
```

The above example will output:

```
City: Benin City Countrycode: NGA
```

### See Also

[mysqli\\_prepare](#)

#### 20.11.2.7.8. [mysqli\\_stmt->errno](#), [mysqli\\_stmt\\_errno](#)

Copyright 1997-2008 the PHP Documentation Group.

- [mysqli\\_stmt->errno](#)
- [mysqli\\_stmt\\_errno](#)

Returns the error code for the most recent statement call

### Description

Object oriented style (property):

```
mysqli_stmt {
    int errno ;
}
```

Procedural style :

```
int mysqli_stmt_errno(mysqli_stmt stmt);
```

Returns the error code for the most recently invoked statement function that can succeed or fail.

Client error message numbers are listed in the MySQL [errmsg.h](#) header file, server error message numbers are listed in [mysqld\\_error.h](#). In the MySQL source distribution you can find a complete list of error messages and error numbers in the file [Docs/mysqld\\_error.txt](#).

### Parameters

*stmt* Procedural style only: A statement identifier returned by [mysqli\\_stmt\\_init](#).

### Return Values

An error code value. Zero means no error occurred.

### Examples

#### Example 20.146. Object oriented style

```
<?php
/* Open a connection */
$mysqli = new mysqli("localhost", "my_user", "my_password", "world");
/* check connection */
```

```

if (mysqli_connect_errno()) {
    printf("Connect failed: %s\n", mysqli_connect_error());
    exit();
}

$mysqli->query("CREATE TABLE myCountry LIKE Country");
$mysqli->query("INSERT INTO myCountry SELECT * FROM Country");

$query = "SELECT Name, Code FROM myCountry ORDER BY Name";
if ($stmt = $mysqli->prepare($query)) {
    /* drop table */
    $mysqli->query("DROP TABLE myCountry");

    /* execute query */
    $stmt->execute();

    printf("Error: %d.\n", $stmt->errno);

    /* close statement */
    $stmt->close();
}

/* close connection */
$mysqli->close();
?>

```

### Example 20.147. Procedural style

```

<?php
/* Open a connection */
$link = mysqli_connect("localhost", "my_user", "my_password", "world");

/* check connection */
if (mysqli_connect_errno()) {
    printf("Connect failed: %s\n", mysqli_connect_error());
    exit();
}

mysqli_query($link, "CREATE TABLE myCountry LIKE Country");
mysqli_query($link, "INSERT INTO myCountry SELECT * FROM Country");

$query = "SELECT Name, Code FROM myCountry ORDER BY Name";
if ($stmt = mysqli_prepare($link, $query)) {
    /* drop table */
    mysqli_query($link, "DROP TABLE myCountry");

    /* execute query */
    mysqli_stmt_execute($stmt);

    printf("Error: %d.\n", mysqli_stmt_errno($stmt));

    /* close statement */
    mysqli_stmt_close($stmt);
}

/* close connection */
mysqli_close($link);
?>

```

The above example will output:

```
Error: 1146.
```

### See Also

[mysqli\\_stmt\\_error](#)  
[mysqli\\_stmt\\_sqlstate](#)

**20.11.2.7.9. `mysqli_stmt->error`, `mysqli_stmt_error`**

Copyright 1997-2008 the PHP Documentation Group.

- `mysqli_stmt->error`  
`mysqli_stmt_error`

Returns a string description for last statement error

**Description**

Object oriented style (property):

```
mysqli_stmt {
    string error ;
}
```

Procedural style:

```
string mysqli_stmt_error(mysqli_stmt stmt);
```

Returns a containing the error message for the most recently invoked statement function that can succeed or fail.

**Parameters**

*stmt*

Procedural style only: A statement identifier returned by `mysqli_stmt_init`.

**Return Values**

A string that describes the error. An empty string if no error occurred.

**Examples****Example 20.148. Object oriented style**

```
<?php
/* Open a connection */
$mysqli = new mysqli("localhost", "my_user", "my_password", "world");

/* check connection */
if (mysqli_connect_errno()) {
    printf("Connect failed: %s\n", mysqli_connect_error());
    exit();
}

$mysqli->query("CREATE TABLE myCountry LIKE Country");
$mysqli->query("INSERT INTO myCountry SELECT * FROM Country");

$query = "SELECT Name, Code FROM myCountry ORDER BY Name";
if ($stmt = $mysqli->prepare($query)) {

    /* drop table */
    $mysqli->query("DROP TABLE myCountry");

    /* execute query */
    $stmt->execute();

    printf("Error: %s.\n", $stmt->error);

    /* close statement */
    $stmt->close();
}

/* close connection */
$mysqli->close();
?>
```

**Example 20.149. Procedural style**

```

<?php
/* Open a connection */
$link = mysqli_connect("localhost", "my_user", "my_password", "world");

/* check connection */
if (mysqli_connect_errno()) {
    printf("Connect failed: %s\n", mysqli_connect_error());
    exit();
}

mysqli_query($link, "CREATE TABLE myCountry LIKE Country");
mysqli_query($link, "INSERT INTO myCountry SELECT * FROM Country");

$query = "SELECT Name, Code FROM myCountry ORDER BY Name";
if ($stmt = mysqli_prepare($link, $query)) {

    /* drop table */
    mysqli_query($link, "DROP TABLE myCountry");

    /* execute query */
    mysqli_stmt_execute($stmt);

    printf("Error: %s.\n", mysqli_stmt_error($stmt));

    /* close statement */
    mysqli_stmt_close($stmt);
}

/* close connection */
mysqli_close($link);
?>

```

The above example will output:

```
Error: Table 'world.myCountry' doesn't exist.
```

**See Also**

[mysqli\\_stmt\\_errno](#)  
[mysqli\\_stmt\\_sqlstate](#)

**20.11.2.7.10. [mysqli\\_stmt->execute](#), [mysqli\\_stmt\\_execute](#)**

Copyright 1997-2008 the PHP Documentation Group.

- [mysqli\\_stmt->execute](#)  
[mysqli\\_stmt\\_execute](#)

Executes a prepared Query

**Description**

Object oriented style (method):

```
bool mysqli_stmt::execute();
```

Procedural style:

```
bool mysqli_stmt_execute(mysqli_stmt $stmt);
```

Executes a query that has been previously prepared using the [mysqli\\_prepare](#) function. When executed any parameter markers which exist will automatically be replaced with the appropriate data.



If the statement is `UPDATE`, `DELETE`, or `INSERT`, the total number of affected rows can be determined by using the `mysqli_stmt_affected_rows` function. Likewise, if the query yields a result set the `mysqli_stmt_fetch` function is used.

### Note

When using `mysqli_stmt_execute`, the `mysqli_stmt_fetch` function must be used to fetch the data prior to performing any additional queries.

### Parameters

*stmt*

Procedural style only: A statement identifier returned by `mysqli_stmt_init`.

### Return Values

Returns `TRUE` on success or `FALSE` on failure.

### Examples

#### Example 20.150. Object oriented style

```
<?php
$mysqli = new mysqli("localhost", "my_user", "my_password", "world");

/* check connection */
if (mysqli_connect_errno()) {
    printf("Connect failed: %s\n", mysqli_connect_error());
    exit();
}

$mysqli->query("CREATE TABLE myCity LIKE City");

/* Prepare an insert statement */
$query = "INSERT INTO myCity (Name, CountryCode, District) VALUES (?, ?, ?)";
$stmt = $mysqli->prepare($query);

$stmt->bind_param("sss", $val1, $val2, $val3);

$val1 = 'Stuttgart';
$val2 = 'DEU';
$val3 = 'Baden-Wuerttemberg';

/* Execute the statement */
$stmt->execute();

$val1 = 'Bordeaux';
$val2 = 'FRA';
$val3 = 'Aquitaine';

/* Execute the statement */
$stmt->execute();

/* close statement */
$stmt->close();

/* retrieve all rows from myCity */
$query = "SELECT Name, CountryCode, District FROM myCity";
if ($result = $mysqli->query($query)) {
    while ($row = $result->fetch_row()) {
        printf("%s (%s,%s)\n", $row[0], $row[1], $row[2]);
    }
    /* free result set */
    $result->close();
}

/* remove table */
$mysqli->query("DROP TABLE myCity");

/* close connection */
$mysqli->close();
?>
```

#### Example 20.151. Procedural style

```

<?php
$link = mysqli_connect("localhost", "my_user", "my_password", "world");

/* check connection */
if (mysqli_connect_errno()) {
    printf("Connect failed: %s\n", mysqli_connect_error());
    exit();
}

mysqli_query($link, "CREATE TABLE myCity LIKE City");

/* Prepare an insert statement */
$query = "INSERT INTO myCity (Name, CountryCode, District) VALUES (?, ?, ?)";
$stmt = mysqli_prepare($link, $query);

mysqli_stmt_bind_param($stmt, "sss", $val1, $val2, $val3);

$val1 = 'Stuttgart';
$val2 = 'DEU';
$val3 = 'Baden-Wuerttemberg';

/* Execute the statement */
mysqli_stmt_execute($stmt);

$val1 = 'Bordeaux';
$val2 = 'FRA';
$val3 = 'Aquitaine';

/* Execute the statement */
mysqli_stmt_execute($stmt);

/* close statement */
mysqli_stmt_close($stmt);

/* retrieve all rows from myCity */
$query = "SELECT Name, CountryCode, District FROM myCity";
if ($result = mysqli_query($link, $query)) {
    while ($row = mysqli_fetch_row($result)) {
        printf("%s (%s,%s)\n", $row[0], $row[1], $row[2]);
    }
    /* free result set */
    mysqli_free_result($result);
}

/* remove table */
mysqli_query($link, "DROP TABLE myCity");

/* close connection */
mysqli_close($link);
?>

```

The above example will output:

```

Stuttgart (DEU,Baden-Wuerttemberg)
Bordeaux (FRA,Aquitaine)

```

## See Also

[mysqli\\_prepare](#)  
[mysqli\\_stmt\\_bind\\_param](#)

### 20.11.2.7.11. [mysqli\\_stmt::fetch](#), [mysqli\\_stmt\\_fetch](#)

Copyright 1997-2008 the PHP Documentation Group.

- [mysqli\\_stmt::fetch](#)  
[mysqli\\_stmt\\_fetch](#)

Fetch results from a prepared statement into the bound variables

## Description

Object oriented style (method):

```
bool mysqli_stmt::fetch();
```

Procedural style:

```
bool mysqli_stmt_fetch(mysqli_stmt stmt);
```

Fetch the result from a prepared statement into the variables bound by `mysqli_stmt_bind_result`.

#### Note

Note that all columns must be bound by the application before calling `mysqli_stmt_fetch`.

#### Note

Data are transferred unbuffered without calling `mysqli_stmt_store_result` which can decrease performance (but reduces memory cost).

#### Parameters

`stmt` Procedural style only: A statement identifier returned by `mysqli_stmt_init`.

#### Return Values

**Table 20.13. Return Values**

Value	Description
TRUE	Success. Data has been fetched
FALSE	Error occurred
NULL	No more rows/data exists or data truncation occurred

#### Examples

##### Example 20.152. Object oriented style

```
<?php
$mysqli = new mysqli("localhost", "my_user", "my_password", "world");

/* check connection */
if (mysqli_connect_errno()) {
    printf("Connect failed: %s\n", mysqli_connect_error());
    exit();
}

$query = "SELECT Name, CountryCode FROM City ORDER by ID DESC LIMIT 150,5";

if ($stmt = $mysqli->prepare($query)) {

    /* execute statement */
    $stmt->execute();

    /* bind result variables */
    $stmt->bind_result($name, $code);

    /* fetch values */
    while ($stmt->fetch()) {
        printf ("%s (%s)\n", $name, $code);
    }

    /* close statement */
    $stmt->close();
}

/* close connection */
$mysqli->close();
?>
```

**Example 20.153. Procedural style**

```

<?php
$link = mysqli_connect("localhost", "my_user", "my_password", "world");

/* check connection */
if (mysqli_connect_errno()) {
    printf("Connect failed: %s\n", mysqli_connect_error());
    exit();
}

$query = "SELECT Name, CountryCode FROM City ORDER by ID DESC LIMIT 150,5";
if ($stmt = mysqli_prepare($link, $query)) {

    /* execute statement */
    mysqli_stmt_execute($stmt);

    /* bind result variables */
    mysqli_stmt_bind_result($stmt, $name, $code);

    /* fetch values */
    while (mysqli_stmt_fetch($stmt)) {
        printf ("%s (%s)\n", $name, $code);
    }

    /* close statement */
    mysqli_stmt_close($stmt);
}

/* close connection */
mysqli_close($link);
?>

```

The above example will output:

```

Rockford (USA)
Tallahassee (USA)
Salinas (USA)
Santa Clarita (USA)
Springfield (USA)

```

**See Also**

```

mysqli_prepare
mysqli_stmt_errno
mysqli_stmt_error
mysqli_stmt_bind_result

```

**20.11.2.7.12. [mysqli\\_stmt->field\\_count](#), [mysqli\\_stmt\\_field\\_count](#)**

Copyright 1997-2008 the PHP Documentation Group.

- [mysqli\\_stmt->field\\_count](#)  
[mysqli\\_stmt\\_field\\_count](#)

Returns the number of field in the given statement

**Description**

```

mysqli_stmt {
    int field_count ;
}

```

```

int mysqli_stmt_field_count(mysqli_stmt stmt);

```

**Warning**

This function is currently not documented; only its argument list is available.

**20.11.2.7.13. `stmt::free_result`, `mysqli_stmt_free_result`**

Copyright 1997-2008 the PHP Documentation Group.

- `stmt::free_result`  
`mysqli_stmt_free_result`

Frees stored result memory for the given statement handle

**Description**

Object oriented style (method):

```
void mysqli_stmt::free_result();
```

Procedural style:

```
void mysqli_stmt_free_result(mysqli_stmt stmt);
```

Frees the result memory associated with the statement, which was allocated by `mysqli_stmt_store_result`.

**Parameters**

*stmt* Procedural style only: A statement identifier returned by `mysqli_stmt_init`.

**Return Values**

No value is returned.

**See Also**

`mysqli_stmt_store_result`

**20.11.2.7.14. `mysqli_stmt::get_warnings`, `mysqli_stmt_get_warnings`**

Copyright 1997-2008 the PHP Documentation Group.

- `mysqli_stmt::get_warnings`  
`mysqli_stmt_get_warnings`

**Description**

```
object mysqli_stmt::get_warnings(mysqli_stmt stmt);
```

```
object mysqli_stmt_get_warnings(mysqli_stmt stmt);
```

**Warning**

This function is currently not documented; only its argument list is available.

**20.11.2.7.15. `mysqli_stmt->insert_id`, `mysqli_stmt_insert_id`**

Copyright 1997-2008 the PHP Documentation Group.

- `mysqli_stmt->insert_id`

`mysqli_stmt_insert_id`

Get the ID generated from the previous INSERT operation

#### Description

```
mysqli_stmt {  
    int insert_id ;  
}
```

```
mixed mysqli_stmt_insert_id(mysqli_stmt stmt);
```

#### Warning

This function is currently not documented; only its argument list is available.

### 20.11.2.7.16. `mysqli_stmt::num_rows`, `mysqli_stmt_num_rows`

Copyright 1997-2008 the PHP Documentation Group.

- `mysqli_stmt::num_rows`

`mysqli_stmt_num_rows`

Return the number of rows in statements result set

#### Description

Object oriented style (property):

```
mysqli_stmt {  
    int num_rows ;  
}
```

Procedural style :

```
int mysqli_stmt_num_rows(mysqli_stmt stmt);
```

Returns the number of rows in the result set. The use of `mysqli_stmt_num_rows` depends on whether or not you used `mysqli_stmt_store_result` to buffer the entire result set in the statement handle.

If you use `mysqli_stmt_store_result`, `mysqli_stmt_num_rows` may be called immediately.

#### Parameters

*stmt* Procedural style only: A statement identifier returned by `mysqli_stmt_init`.

#### Return Values

An integer representing the number of rows in result set.

#### Examples

##### Example 20.154. Object oriented style

```
<?php  
/* Open a connection */  
$mysqli = new mysqli("localhost", "my_user", "my_password", "world");  
/* check connection */
```

```

if (mysqli_connect_errno()) {
    printf("Connect failed: %s\n", mysqli_connect_error());
    exit();
}

$query = "SELECT Name, CountryCode FROM City ORDER BY Name LIMIT 20";
if ($stmt = $mysqli->prepare($query)) {

    /* execute query */
    $stmt->execute();

    /* store result */
    $stmt->store_result();

    printf("Number of rows: %d.\n", $stmt->num_rows);

    /* close statement */
    $stmt->close();
}

/* close connection */
$mysqli->close();
?>

```

### Example 20.155. Procedural style

```

<?php
/* Open a connection */
$link = mysqli_connect("localhost", "my_user", "my_password", "world");

/* check connection */
if (mysqli_connect_errno()) {
    printf("Connect failed: %s\n", mysqli_connect_error());
    exit();
}

$query = "SELECT Name, CountryCode FROM City ORDER BY Name LIMIT 20";
if ($stmt = mysqli_prepare($link, $query)) {

    /* execute query */
    mysqli_stmt_execute($stmt);

    /* store result */
    mysqli_stmt_store_result($stmt);

    printf("Number of rows: %d.\n", mysqli_stmt_num_rows($stmt));

    /* close statement */
    mysqli_stmt_close($stmt);
}

/* close connection */
mysqli_close($link);
?>

```

The above example will output:

```

Number of rows: 20.

```

#### See Also

[mysqli\\_stmt\\_affected\\_rows](#)  
[mysqli\\_prepare](#)  
[mysqli\\_stmt\\_store\\_result](#)

#### 20.11.2.7.17. [mysqli\\_stmt->param\\_count](#), [mysqli\\_stmt\\_param\\_count](#)

Copyright 1997-2008 the PHP Documentation Group.

- `mysqli_stmt->param_count`

`mysqli_stmt_param_count`

Returns the number of parameter for the given statement

### Description

Object oriented style (property):

```
mysqli_stmt {
    int param_count ;
}
```

Procedural style:

```
int mysqli_stmt_param_count(mysqli_stmt stmt);
```

Returns the number of parameter markers present in the prepared statement.

### Parameters

*stmt*

Procedural style only: A statement identifier returned by `mysqli_stmt_init`.

### Return Values

Returns an integer representing the number of parameters.

### Examples

#### Example 20.156. Object oriented style

```
<?php
$mysqli = new mysqli("localhost", "my_user", "my_password", "world");

/* check connection */
if (mysqli_connect_errno()) {
    printf("Connect failed: %s\n", mysqli_connect_error());
    exit();
}

if ($stmt = $mysqli->prepare("SELECT Name FROM Country WHERE Name=? OR Code=?")) {
    $marker = $stmt->param_count;
    printf("Statement has %d markers.\n", $marker);

    /* close statement */
    $stmt->close();
}

/* close connection */
$mysqli->close();
?>
```

#### Example 20.157. Procedural style

```
<?php
$link = mysqli_connect("localhost", "my_user", "my_password", "world");

/* check connection */
if (mysqli_connect_errno()) {
    printf("Connect failed: %s\n", mysqli_connect_error());
    exit();
}

if ($stmt = mysqli_prepare($link, "SELECT Name FROM Country WHERE Name=? OR Code=?")) {
```



```

$marker = mysqli_stmt_param_count($stmt);
printf("Statement has %d markers.\n", $marker);

/* close statement */
mysqli_stmt_close($stmt);
}

/* close connection */
mysqli_close($link);
?>

```

The above example will output:

```
Statement has 2 markers.
```

### See Also

[mysqli\\_prepare](#)

#### 20.11.2.7.18. [mysqli\\_stmt::prepare](#), [mysqli\\_stmt\\_prepare](#)

Copyright 1997-2008 the PHP Documentation Group.

- [mysqli\\_stmt::prepare](#)  
[mysqli\\_stmt\\_prepare](#)

Prepare a SQL statement for execution

### Description

Object oriented style (method)

```
mixed mysqli_stmt::prepare(string query);
```

Procedure style:

```
bool mysqli_stmt_prepare(mysqli_stmt stmt,
string query);
```

Prepares the SQL query pointed to by the null-terminated string query.

The parameter markers must be bound to application variables using [mysqli\\_stmt\\_bind\\_param](#) and/or [mysqli\\_stmt\\_bind\\_result](#) before executing the statement or fetching rows.

### Parameters

*stmt*

Procedural style only: A statement identifier returned by [mysqli\\_stmt\\_init](#).

*query*

The query, as a string. It must consist of a single SQL statement.

You can include one or more parameter markers in the SQL statement by embedding question mark (?) characters at the appropriate positions.

#### Note

You should not add a terminating semicolon or `\g` to the statement.

#### Note

The markers are legal only in certain places in SQL statements. For example, they are allowed in the VALUES() list of an INSERT statement (to specify column values for a row), or in a comparison with a column in a WHERE clause to specify a comparison value.

However, they are not allowed for identifiers (such as table or column names), in the select list that names the columns to be returned by a SELECT statement), or to specify both operands of a binary operator such as the = equal sign. The latter restriction is necessary because it would be impossible to determine the parameter type. In general, parameters are legal only in Data Manipulation Language (DML) statements, and not in Data Definition Language (DDL) statements.

### Return Values

Returns **TRUE** on success or **FALSE** on failure.

### Examples

#### Example 20.158. Object oriented style

```
<?php
$mysqli = new mysqli("localhost", "my_user", "my_password", "world");

/* check connection */
if (mysqli_connect_errno()) {
    printf("Connect failed: %s\n", mysqli_connect_error());
    exit();
}

$city = "Amersfoort";

/* create a prepared statement */
$stmt = $mysqli->stmt_init();
if ($stmt->prepare("SELECT District FROM City WHERE Name=?") {

    /* bind parameters for markers */
    $stmt->bind_param("s", $city);

    /* execute query */
    $stmt->execute();

    /* bind result variables */
    $stmt->bind_result($district);

    /* fetch value */
    $stmt->fetch();

    printf("%s is in district %s\n", $city, $district);

    /* close statement */
    $stmt->close();
}

/* close connection */
$mysqli->close();
?>
```

#### Example 20.159. Procedural style

```
<?php
$link = mysqli_connect("localhost", "my_user", "my_password", "world");

/* check connection */
if (mysqli_connect_errno()) {
    printf("Connect failed: %s\n", mysqli_connect_error());
    exit();
}

$city = "Amersfoort";

/* create a prepared statement */
$stmt = mysqli_stmt_init($link);
if (mysqli_stmt_prepare($stmt, 'SELECT District FROM City WHERE Name=?') {

    /* bind parameters for markers */
    mysqli_stmt_bind_param($stmt, "s", $city);

    /* execute query */
    mysqli_stmt_execute($stmt);
```

```

/* bind result variables */
mysqli_stmt_bind_result($stmt, $district);

/* fetch value */
mysqli_stmt_fetch($stmt);

printf("%s is in district %s\n", $city, $district);

/* close statement */
mysqli_stmt_close($stmt);
}

/* close connection */
mysqli_close($link);
?>

```

The above example will output:

```
Amersfoort is in district Utrecht
```

#### See Also

[mysqli\\_stmt\\_init](#), [mysqli\\_stmt\\_execute](#), [mysqli\\_stmt\\_fetch](#), [mysqli\\_stmt\\_bind\\_param](#), [mysqli\\_stmt\\_bind\\_result](#) [mysqli\\_stmt\\_close](#).

#### 20.11.2.7.19. [mysqli\\_stmt::reset](#), [mysqli\\_stmt\\_reset](#)

Copyright 1997-2008 the PHP Documentation Group.

- [mysqli\\_stmt::reset](#)

[mysqli\\_stmt\\_reset](#)

Resets a prepared statement

#### Description

Object oriented style (method):

```
bool mysqli_stmt::reset();
```

Procedural style:

```
bool mysqli_stmt_reset(mysqli_stmt stmt);
```

Resets a prepared statement on client and server to state after prepare.

For now this is mainly used to reset data sent with [mysqli\\_stmt\\_send\\_long\\_data](#).

To prepare a statement with another query use function [mysqli\\_stmt\\_prepare](#).

#### Parameters

*stmt*

Procedural style only: A statement identifier returned by [mysqli\\_stmt\\_init](#).

#### Return Values

Returns [TRUE](#) on success or [FALSE](#) on failure.

#### See Also

`mysqli_prepare`

### 20.11.2.7.20. `mysqli_stmt::result_metadata`, `mysqli_stmt_result_metadata`

Copyright 1997-2008 the PHP Documentation Group.

- `mysqli_stmt::result_metadata`  
`mysqli_stmt_result_metadata`

Returns result set metadata from a prepared statement

#### Description

Object oriented style (method):

```
mysqli_result mysqli_stmt::result_metadata();
```

Procedural style:

```
mysqli_result mysqli_stmt_result_metadata(mysqli_stmt stmt);
```

If a statement passed to `mysqli_prepare` is one that produces a result set, `mysqli_stmt_result_metadata` returns the result object that can be used to process the meta information such as total number of fields and individual field information.

#### Note

This result set pointer can be passed as an argument to any of the field-based functions that process result set metadata, such as:

- `mysqli_num_fields`
- `mysqli_fetch_field`
- `mysqli_fetch_field_direct`
- `mysqli_fetch_fields`
- `mysqli_field_count`
- `mysqli_field_seek`
- `mysqli_field_tell`
- `mysqli_free_result`

The result set structure should be freed when you are done with it, which you can do by passing it to `mysqli_free_result`

#### Note

The result set returned by `mysqli_stmt_result_metadata` contains only metadata. It does not contain any row results. The rows are obtained by using the statement handle with `mysqli_stmt_fetch`.

#### Parameters

*stmt*

Procedural style only: A statement identifier returned by `mysqli_stmt_init`.

#### Return Values

Returns a result object or `FALSE` if an error occurred.

#### Examples

**Example 20.160. Object oriented style**

```

<?php
$mysqli = new mysqli("localhost", "my_user", "my_password", "test");

$mysqli->query("DROP TABLE IF EXISTS friends");
$mysqli->query("CREATE TABLE friends (id int, name varchar(20))");

$mysqli->query("INSERT INTO friends VALUES (1,'Hartmut'), (2, 'Ulf')");

$stmt = $mysqli->prepare("SELECT id, name FROM friends");
$stmt->execute();

/* get resultset for metadata */
$result = $stmt->result_metadata();

/* retrieve field information from metadata result set */
$field = $result->fetch_field();

printf("Fieldname: %s\n", $field->name);

/* close resultset */
$result->close();

/* close connection */
$mysqli->close();
?>

```

**Example 20.161. Procedural style**

```

<?php
$link = mysqli_connect("localhost", "my_user", "my_password", "test");

mysqli_query($link, "DROP TABLE IF EXISTS friends");
mysqli_query($link, "CREATE TABLE friends (id int, name varchar(20))");

mysqli_query($link, "INSERT INTO friends VALUES (1,'Hartmut'), (2, 'Ulf')");

$stmt = mysqli_prepare($link, "SELECT id, name FROM friends");
mysqli_stmt_execute($stmt);

/* get resultset for metadata */
$result = mysqli_stmt_result_metadata($stmt);

/* retrieve field information from metadata result set */
$field = mysqli_fetch_field($result);

printf("Fieldname: %s\n", $field->name);

/* close resultset */
mysqli_free_result($result);

/* close connection */
mysqli_close($link);
?>

```

**See Also**

[mysqli\\_prepare](#)  
[mysqli\\_free\\_result](#)

**20.11.2.7.21. [mysqli\\_stmt::send\\_long\\_data](#), [mysqli\\_stmt\\_send\\_long\\_data](#)**

Copyright 1997-2008 the PHP Documentation Group.

- [mysqli\\_stmt::send\\_long\\_data](#)  
[mysqli\\_stmt\\_send\\_long\\_data](#)

Send data in blocks

## Description

Object oriented style (method)

```
bool mysqli_stmt::send_long_data(int param_nr,  
                                string data);
```

Procedural style:

```
bool mysqli_stmt_send_long_data(mysqli_stmt stmt,  
                                int param_nr,  
                                string data);
```

Allows to send parameter data to the server in pieces (or chunks), e.g. if the size of a blob exceeds the size of [max\\_allowed\\_packet](#). This function can be called multiple times to send the parts of a character or binary data value for a column, which must be one of the TEXT or BLOB datatypes.

## Parameters

<i>stmt</i>	Procedural style only: A statement identifier returned by <a href="#">mysqli_stmt_init</a> .
<i>param_nr</i>	Indicates which parameter to associate the data with. Parameters are numbered beginning with 0.
<i>data</i>	A string containing data to be sent.

## Return Values

Returns [TRUE](#) on success or [FALSE](#) on failure.

## Examples

### Example 20.162. Object oriented style

```
<?php  
$stmt = $mysqli->prepare("INSERT INTO messages (message) VALUES (?)");  
$null = NULL;  
$stmt->bind_param("b", $null);  
$fp = fopen("messages.txt", "r");  
while (!feof($fp)) {  
    $stmt->send_long_data(0, fread($fp, 8192));  
}  
fclose($fp);  
$stmt->execute();  
?>
```

## See Also

[mysqli\\_prepare](#)  
[mysqli\\_stmt\\_bind\\_param](#)

### 20.11.2.7.22. [mysqli\\_stmt::sqlstate](#), [mysqli\\_stmt\\_sqlstate](#)

Copyright 1997-2008 the PHP Documentation Group.

- [mysqli\\_stmt::sqlstate](#)  
[mysqli\\_stmt\\_sqlstate](#)

Returns SQLSTATE error from previous statement operation

## Description

Object oriented style (property):

```
mysqli_stmt {
    string sqlstate ;
}
```

Procedural style:

```
string mysqli_stmt_sqlstate(mysqli_stmt stmt);
```

Returns a string containing the SQLSTATE error code for the most recently invoked prepared statement function that can succeed or fail. The error code consists of five characters. '00000' means no error. The values are specified by ANSI SQL and ODBC. For a list of possible values, see <http://dev.mysql.com/doc/mysql/en/error-handling.html>.

### Parameters

*stmt* Procedural style only: A statement identifier returned by `mysqli_stmt_init`.

### Return Values

Returns a string containing the SQLSTATE error code for the last error. The error code consists of five characters. '00000' means no error.

### Notes

#### Note

Note that not all MySQL errors are yet mapped to SQLSTATE's. The value `HY000` (general error) is used for un-mapped errors.

### Examples

#### Example 20.163. Object oriented style

```
<?php
/* Open a connection */
$mysqli = new mysqli("localhost", "my_user", "my_password", "world");

/* check connection */
if (mysqli_connect_errno()) {
    printf("Connect failed: %s\n", mysqli_connect_error());
    exit();
}

$mysqli->query("CREATE TABLE myCountry LIKE Country");
$mysqli->query("INSERT INTO myCountry SELECT * FROM Country");

$query = "SELECT Name, Code FROM myCountry ORDER BY Name";
if ($stmt = $mysqli->prepare($query)) {

    /* drop table */
    $mysqli->query("DROP TABLE myCountry");

    /* execute query */
    $stmt->execute();

    printf("Error: %s.\n", $stmt->sqlstate);

    /* close statement */
    $stmt->close();
}

/* close connection */
$mysqli->close();
?>
```

#### Example 20.164. Procedural style

```

<?php
/* Open a connection */
$link = mysqli_connect("localhost", "my_user", "my_password", "world");

/* check connection */
if (mysqli_connect_errno()) {
    printf("Connect failed: %s\n", mysqli_connect_error());
    exit();
}

mysqli_query($link, "CREATE TABLE myCountry LIKE Country");
mysqli_query($link, "INSERT INTO myCountry SELECT * FROM Country");

$query = "SELECT Name, Code FROM myCountry ORDER BY Name";
if ($stmt = mysqli_prepare($link, $query)) {

    /* drop table */
    mysqli_query($link, "DROP TABLE myCountry");

    /* execute query */
    mysqli_stmt_execute($stmt);

    printf("Error: %s.\n", mysqli_stmt_sqlstate($stmt));

    /* close statement */
    mysqli_stmt_close($stmt);
}

/* close connection */
mysqli_close($link);
?>

```

The above example will output:

```
Error: 42S02.
```

#### See Also

[mysqli\\_stmt\\_errno](#)  
[mysqli\\_stmt\\_error](#)

### 20.11.2.7.23. [mysqli\\_stmt::store\\_result](#), [mysqli\\_stmt\\_store\\_result](#)

Copyright 1997-2008 the PHP Documentation Group.

- [mysqli\\_stmt::store\\_result](#)  
[mysqli\\_stmt\\_store\\_result](#)

Transfers a result set from a prepared statement

#### Description

Object oriented style (method):

```
bool mysqli_stmt::store_result();
```

Procedural style:

```
bool mysqli_stmt_store_result(mysqli_stmt $stmt);
```

You must call [mysqli\\_stmt\\_store\\_result](#) for every query that successfully produces a result set ([SELECT](#), [SHOW](#), [DESCRIBE](#), [EXPLAIN](#)), and only if you want to buffer the complete result set by the client, so that the subsequent [mysqli\\_stmt\\_fetch](#) call returns buffered data.

#### Note



It is unnecessary to call `mysqli_stmt_store_result` for other queries, but if you do, it will not harm or cause any notable performance in all cases. You can detect whether the query produced a result set by checking if `mysqli_stmt_result_metadata` returns NULL.

### Parameters

*stmt* Procedural style only: A statement identifier returned by `mysqli_stmt_init`.

### Return Values

Returns `TRUE` on success or `FALSE` on failure.

### Examples

#### Example 20.165. Object oriented style

```
<?php
/* Open a connection */
$mysqli = new mysqli("localhost", "my_user", "my_password", "world");

/* check connection */
if (mysqli_connect_errno()) {
    printf("Connect failed: %s\n", mysqli_connect_error());
    exit();
}

$query = "SELECT Name, CountryCode FROM City ORDER BY Name LIMIT 20";
if ($stmt = $mysqli->prepare($query)) {

    /* execute query */
    $stmt->execute();

    /* store result */
    $stmt->store_result();

    printf("Number of rows: %d.\n", $stmt->num_rows);

    /* free result */
    $stmt->free_result();

    /* close statement */
    $stmt->close();
}

/* close connection */
$mysqli->close();
?>
```

#### Example 20.166. Procedural style

```
<?php
/* Open a connection */
$link = mysqli_connect("localhost", "my_user", "my_password", "world");

/* check connection */
if (mysqli_connect_errno()) {
    printf("Connect failed: %s\n", mysqli_connect_error());
    exit();
}

$query = "SELECT Name, CountryCode FROM City ORDER BY Name LIMIT 20";
if ($stmt = mysqli_prepare($link, $query)) {

    /* execute query */
    mysqli_stmt_execute($stmt);

    /* store result */
    mysqli_stmt_store_result($stmt);

    printf("Number of rows: %d.\n", mysqli_stmt_num_rows($stmt));

    /* free result */
    mysqli_stmt_free_result($stmt);

    /* close statement */
    mysqli_stmt_close($stmt);
}
```

```
}  
/* close connection */  
mysqli_close($link);  
?>
```

The above example will output:

```
Number of rows: 20.
```

### See Also

[mysqli\\_prepare](#)  
[mysqli\\_stmt\\_result\\_metadata](#)  
[mysqli\\_stmt\\_fetch](#)

## 20.11.2.8. The MySQLi\_Result class ([MySQLi\\_Result](#))

Copyright 1997-2008 the PHP Documentation Group.

Represents the result set obtained from a query against the database.

```
MySQLi_Result {  
    MySQLi_Result  
  
    Properties  
  
    int current_field ;  
  
    int field_count ;  
  
    array lengths ;  
  
    int num_rows ;  
  
Methods  
  
    int mysqli_field_tell(mysqli_result result);  
  
    bool mysqli_result::data_seek(int offset);  
  
    mixed mysqli_result::fetch_all(int resulttype);  
  
    mixed mysqli_result::fetch_array(int resulttype);  
  
    array mysqli_result::fetch_assoc();  
  
    object mysqli_result::fetch_field_direct(int fieldnr);  
  
    object mysqli_result::fetch_field();  
  
    array mysqli_result::fetch_fields();  
  
    object mysqli_result::fetch_object(string class_name,  
                                       array params);  
  
    mixed mysqli_result::fetch_row();  
  
    int mysqli_num_fields(mysqli_result result);
```

```

bool mysqli_result::field_seek(int fieldnr);

void mysqli_result::free();

array mysqli_fetch_lengths(mysqli_result result);

int mysqli_num_rows(mysqli_result result);
}

```

### 20.11.2.8.1. `mysqli_result->current_field`, `mysqli_field_tell`

Copyright 1997-2008 the PHP Documentation Group.

- `mysqli_result->current_field`  
`mysqli_field_tell`  
Get current field offset of a result pointer

#### Description

Object oriented style (property):

```

mysqli_result {
    int current_field ;
}

```

Procedural style:

```
int mysqli_field_tell(mysqli_result result);
```

Returns the position of the field cursor used for the last `mysqli_fetch_field` call. This value can be used as an argument to `mysqli_field_seek`.

#### Parameters

*result* Procedural style only: A result set identifier returned by `mysqli_query`, `mysqli_store_result` or `mysqli_use_result`.

#### Return Values

Returns current offset of field cursor.

#### Examples

##### Example 20.167. Object oriented style

```

<?php
$mysqli = new mysqli("localhost", "my_user", "my_password", "world");

/* check connection */
if (mysqli_connect_errno()) {
    printf("Connect failed: %s\n", mysqli_connect_error());
    exit();
}

$query = "SELECT Name, SurfaceArea from Country ORDER BY Code LIMIT 5";

if ($result = $mysqli->query($query)) {
    /* Get field information for all columns */
    while ($finfo = $result->fetch_field()) {
        /* get fieldpointer offset */
        $currentfield = $result->current_field;
    }
}

```

```

        printf("Column %d:\n", $currentfield);
        printf("Name:      %s\n", $finfo->name);
        printf("Table:     %s\n", $finfo->table);
        printf("max. Len:  %d\n", $finfo->max_length);
        printf("Flags:    %d\n", $finfo->flags);
        printf("Type:     %d\n\n", $finfo->type);
    }
    $result->close();
}

/* close connection */
mysqli->close();
?>

```

### Example 20.168. Procedural style

```

<?php
$link = mysqli_connect("localhost", "my_user", "my_password", "world");

/* check connection */
if (mysqli_connect_errno()) {
    printf("Connect failed: %s\n", mysqli_connect_error());
    exit();
}

$query = "SELECT Name, SurfaceArea from Country ORDER BY Code LIMIT 5";

if ($result = mysqli_query($link, $query)) {

    /* Get field information for all fields */
    while ($finfo = mysqli_fetch_field($result)) {

        /* get fieldpointer offset */
        $currentfield = mysqli_field_tell($result);

        printf("Column %d:\n", $currentfield);
        printf("Name:      %s\n", $finfo->name);
        printf("Table:     %s\n", $finfo->table);
        printf("max. Len:  %d\n", $finfo->max_length);
        printf("Flags:    %d\n", $finfo->flags);
        printf("Type:     %d\n\n", $finfo->type);
    }
    mysqli_free_result($result);
}

/* close connection */
mysqli_close($link);
?>

```

The above example will output:

```

Column 1:
Name:     Name
Table:    Country
max. Len: 11
Flags:    1
Type:     254

Column 2:
Name:     SurfaceArea
Table:    Country
max. Len: 10
Flags:    32769
Type:     4

```

### See Also

[mysqli\\_fetch\\_field](#)  
[mysqli\\_field\\_seek](#)

## 20.11.2.8.2. `mysqli_result::data_seek`, `mysqli_data_seek`

Copyright 1997-2008 the PHP Documentation Group.

- `mysqli_result::data_seek`

`mysqli_data_seek`

Adjusts the result pointer to an arbitrary row in the result

### Description

Object oriented style (method):

```
bool mysqli_result::data_seek(int offset);
```

Procedural style:

```
bool mysqli_data_seek(mysqli_result result,
                      int offset);
```

The `mysqli_data_seek` function seeks to an arbitrary result pointer specified by the *offset* in the result set.

### Parameters

<i>result</i>	Procedural style only: A result set identifier returned by <code>mysqli_query</code> , <code>mysqli_store_result</code> or <code>mysqli_use_result</code> .
<i>offset</i>	The field offset. Must be between zero and the total number of rows minus one ( <code>0(mysqli_num_rows - 1)</code> ).

### Return Values

Returns `TRUE` on success or `FALSE` on failure.

### Notes

#### Note

This function can only be used with buffered results attained from the use of the `mysqli_store_result` or `mysqli_query` functions.

### Examples

#### Example 20.169. Object oriented style

```
<?php
/* Open a connection */
$mysqli = new mysqli("localhost", "my_user", "my_password", "world");

/* check connection */
if (mysqli_connect_errno()) {
    printf("Connect failed: %s\n", mysqli_connect_error());
    exit();
}

$query = "SELECT Name, CountryCode FROM City ORDER BY Name";
if ($result = $mysqli->query($query)) {

    /* seek to row no. 400 */
    $result->data_seek(399);

    /* fetch row */
    $row = $result->fetch_row();

    printf("City: %s Countrycode: %s\n", $row[0], $row[1]);

    /* free result set*/
    $result->close();
}
```

```

/* close connection */
mysqli->close();
?>

```

### Example 20.170. Procedural style

```

<?php
/* Open a connection */
$link = mysqli_connect("localhost", "my_user", "my_password", "world");

/* check connection */
if (!$link) {
    printf("Connect failed: %s\n", mysqli_connect_error());
    exit();
}

$query = "SELECT Name, CountryCode FROM City ORDER BY Name";

if ($result = mysqli_query($link, $query)) {

    /* seek to row no. 400 */
    mysqli_data_seek($result, 399);

    /* fetch row */
    $row = mysqli_fetch_row($result);

    printf ("City: %s Countrycode: %s\n", $row[0], $row[1]);

    /* free result set*/
    mysqli_free_result($result);
}

/* close connection */
mysqli_close($link);
?>

```

The above example will output:

```

City: Benin City Countrycode: NGA

```

#### See Also

```

mysqli_store_result
mysqli_fetch_row
mysqli_fetch_array
mysqli_fetch_assoc
mysqli_fetch_object
mysqli_query
mysqli_num_rows

```

#### 20.11.2.8.3. [mysqli\\_result::fetch\\_all](#), [mysqli\\_fetch\\_all](#)

Copyright 1997-2008 the PHP Documentation Group.

- [mysqli\\_result::fetch\\_all](#)
- [mysqli\\_fetch\\_all](#)

Fetches all result rows as an associative array, a numeric array, or both

#### Description

Object oriented style (method):

```
mixed mysqli_result::fetch_all(int resulttype);
```

Procedural style:

```
mixed mysqli_fetch_all(mysqli_result result,
    int resulttype);
```

Available only with `mysqlnd`.

#### Parameters

<code>result</code>	Procedural style only: A result set identifier returned by <code>mysqli_query</code> , <code>mysqli_store_result</code> or <code>mysqli_use_result</code> .
<code>resulttype</code>	This optional parameter is a constant indicating what type of array should be produced from the current row data. The possible values for this parameter are the constants <code>MYSQLI_ASSOC</code> , <code>MYSQLI_NUM</code> , or <code>MYSQLI_BOTH</code> . Defaults to <code>MYSQLI_NUM</code> .

#### Return Values

Returns an array of associative or numeric arrays holding result rows.

#### See Also

`mysqli_fetch_array`  
`mysqli_query`

### 20.11.2.8.4. `mysqli_result::fetch_array`, `mysqli_fetch_array`

Copyright 1997-2008 the PHP Documentation Group.

- `mysqli_result::fetch_array`  
`mysqli_fetch_array`  
Fetch a result row as an associative, a numeric array, or both

#### Description

Object oriented style (method):

```
mixed mysqli_result::fetch_array(int resulttype);
```

Procedural style:

```
mixed mysqli_fetch_array(mysqli_result result,
    int resulttype);
```

Returns an array that corresponds to the fetched row or `NULL` if there are no more rows for the resultset represented by the `result` parameter.

`mysqli_fetch_array` is an extended version of the `mysqli_fetch_row` function. In addition to storing the data in the numeric indices of the result array, the `mysqli_fetch_array` function can also store the data in associative indices, using the field names of the result set as keys.

#### Note

Field names returned by this function are *case-sensitive*.

#### Note

This function sets `NULL` fields to the PHP `NULL` value.

If two or more columns of the result have the same field names, the last column will take precedence and overwrite the earlier data.

In order to access multiple columns with the same name, the numerically indexed version of the row must be used.

### Parameters

<i>result</i>	Procedural style only: A result set identifier returned by <code>mysqli_query</code> , <code>mysqli_store_result</code> or <code>mysqli_use_result</code> .
<i>resulttype</i>	This optional parameter is a constant indicating what type of array should be produced from the current row data. The possible values for this parameter are the constants <code>MYSQLI_ASSOC</code> , <code>MYSQLI_NUM</code> , or <code>MYSQLI_BOTH</code> . Defaults to <code>MYSQLI_BOTH</code> .  By using the <code>MYSQLI_ASSOC</code> constant this function will behave identically to the <code>mysqli_fetch_assoc</code> , while <code>MYSQLI_NUM</code> will behave identically to the <code>mysqli_fetch_row</code> function. The final option <code>MYSQLI_BOTH</code> will create a single array with the attributes of both.

### Return Values

Returns an array of strings that corresponds to the fetched row or `NULL` if there are no more rows in resultset.

### Examples

#### Example 20.171. Object oriented style

```
<?php
$mysqli = new mysqli("localhost", "my_user", "my_password", "world");

/* check connection */
if (mysqli_connect_errno()) {
    printf("Connect failed: %s\n", mysqli_connect_error());
    exit();
}

$query = "SELECT Name, CountryCode FROM City ORDER by ID LIMIT 3";
$result = $mysqli->query($query);

/* numeric array */
$row = $result->fetch_array(MYSQLI_NUM);
printf ("%s (%s)\n", $row[0], $row[1]);

/* associative array */
$row = $result->fetch_array(MYSQLI_ASSOC);
printf ("%s (%s)\n", $row["Name"], $row["CountryCode"]);

/* associative and numeric array */
$row = $result->fetch_array(MYSQLI_BOTH);
printf ("%s (%s)\n", $row[0], $row["CountryCode"]);

/* free result set */
$result->close();

/* close connection */
$mysqli->close();
?>
```

#### Example 20.172. Procedural style

```
<?php
$link = mysqli_connect("localhost", "my_user", "my_password", "world");

/* check connection */
if (mysqli_connect_errno()) {
    printf("Connect failed: %s\n", mysqli_connect_error());
    exit();
}

$query = "SELECT Name, CountryCode FROM City ORDER by ID LIMIT 3";
$result = mysqli_query($link, $query);

/* numeric array */
$row = mysqli_fetch_array($result, MYSQLI_NUM);
printf ("%s (%s)\n", $row[0], $row[1]);
```



```

/* associative array */
$row = mysqli_fetch_array($result, MYSQLI_ASSOC);
printf ("%s (%s)\n", $row["Name"], $row["CountryCode"]);

/* associative and numeric array */
$row = mysqli_fetch_array($result, MYSQLI_BOTH);
printf ("%s (%s)\n", $row[0], $row["CountryCode"]);

/* free result set */
mysqli_free_result($result);

/* close connection */
mysqli_close($link);
?>

```

The above example will output:

```

Kabul (AFG)
Qandahar (AFG)
Herat (AFG)

```

#### See Also

[mysqli\\_fetch\\_assoc](#)  
[mysqli\\_fetch\\_row](#)  
[mysqli\\_fetch\\_object](#)  
[mysqli\\_query](#)  
[mysqli\\_data\\_seek](#)

### 20.11.2.8.5. `mysqli_result::fetch_assoc`, `mysqli_fetch_assoc`

Copyright 1997-2008 the PHP Documentation Group.

- `mysqli_result::fetch_assoc`  
`mysqli_fetch_assoc`  
Fetch a result row as an associative array

#### Description

Object oriented style (method):

```
array mysqli_result::fetch_assoc();
```

Procedural style:

```
array mysqli_fetch_assoc(mysqli_result result);
```

Returns an associative array that corresponds to the fetched row or `NULL` if there are no more rows.

#### Note

Field names returned by this function are *case-sensitive*.

#### Note

This function sets `NULL` fields to the PHP `NULL` value.

#### Parameters

*result*

Procedural style only: A result set identifier returned by `mysqli_query`,

`mysqli_store_result` or `mysqli_use_result`.

## Return Values

Returns an associative array of strings representing the fetched row in the result set, where each key in the array represents the name of one of the result set's columns or `NULL` if there are no more rows in resultset.

If two or more columns of the result have the same field names, the last column will take precedence. To access the other column(s) of the same name, you either need to access the result with numeric indices by using `mysqli_fetch_row` or add alias names.

## Examples

### Example 20.173. Object oriented style

```
<?php
$mysqli = new mysqli("localhost", "my_user", "my_password", "world");

/* check connection */
if (mysqli_connect_errno()) {
    printf("Connect failed: %s\n", mysqli_connect_error());
    exit();
}

$query = "SELECT Name, CountryCode FROM City ORDER by ID DESC LIMIT 50,5";

if ($result = $mysqli->query($query)) {

    /* fetch associative array */
    while ($row = $result->fetch_assoc()) {
        printf ("%s (%s)\n", $row["Name"], $row["CountryCode"]);
    }

    /* free result set */
    $result->close();
}

/* close connection */
$mysqli->close();
?>
```

### Example 20.174. Procedural style

```
<?php
$link = mysqli_connect("localhost", "my_user", "my_password", "world");

/* check connection */
if (mysqli_connect_errno()) {
    printf("Connect failed: %s\n", mysqli_connect_error());
    exit();
}

$query = "SELECT Name, CountryCode FROM City ORDER by ID DESC LIMIT 50,5";

if ($result = mysqli_query($link, $query)) {

    /* fetch associative array */
    while ($row = mysqli_fetch_assoc($result)) {
        printf ("%s (%s)\n", $row["Name"], $row["CountryCode"]);
    }

    /* free result set */
    mysqli_free_result($result);
}

/* close connection */
mysqli_close($link);
?>
```

The above example will output:

```
Pueblo (USA)
Arvada (USA)
Cape Coral (USA)
Green Bay (USA)
Santa Clara (USA)
```

**See Also**

```
mysqli_fetch_array
mysqli_fetch_row
mysqli_fetch_object
mysqli_query
mysqli_data_seek
```

**20.11.2.8.6. `mysqli_result::fetch_field_direct`, `mysqli_fetch_field_direct`**

Copyright 1997-2008 the PHP Documentation Group.

- `mysqli_result::fetch_field_direct`

```
mysqli_fetch_field_direct
```

Fetch meta-data for a single field

**Description**

Object oriented style (method):

```
object mysqli_result::fetch_field_direct(int fieldnr);
```

Procedural style:

```
object mysqli_fetch_field_direct(mysqli_result result,
                                int fieldnr);
```

Returns an object which contains field definition informations from specified resultset.

**Parameters**

*result* Procedural style only: A result set identifier returned by `mysqli_query`, `mysqli_store_result` or `mysqli_use_result`.

*fieldnr* The field number. This value must be in the range from 0 to `number of fields - 1`.

**Return Values**

Returns an object which contains field definition information or `FALSE` if no field information for specified `fieldnr` is available.

**Table 20.14. Object attributes**

Attribute	Description
name	The name of the column
orgname	Original column name if an alias was specified
table	The name of the table this field belongs to (if not calculated)
orgtable	Original table name if an alias was specified
def	The default value for this field, represented as a string
max_length	The maximum width of the field for the result set.
length	The width of the field, as specified in the tabl definition.

Attribute	Description
charsetnr	The character set number for the field.
flags	An integer representing the bit-flags for the field.
type	The data type used for this field
decimals	The number of decimals used (for integer fields)

## Examples

### Example 20.175. Object oriented style

```
<?php
$mysqli = new mysqli("localhost", "my_user", "my_password", "world");

/* check connection */
if (mysqli_connect_errno()) {
    printf("Connect failed: %s\n", mysqli_connect_error());
    exit();
}

$query = "SELECT Name, SurfaceArea from Country ORDER BY Name LIMIT 5";

if ($result = $mysqli->query($query)) {

    /* Get field information for column 'SurfaceArea' */
    $finfo = $result->fetch_field_direct(1);

    printf("Name:      %s\n", $finfo->name);
    printf("Table:      %s\n", $finfo->table);
    printf("max. Len: %d\n", $finfo->max_length);
    printf("Flags:       %d\n", $finfo->flags);
    printf("Type:        %d\n", $finfo->type);

    $result->close();
}

/* close connection */
$mysqli->close();
?>
```

### Example 20.176. Procedural style

```
<?php
$link = mysqli_connect("localhost", "my_user", "my_password", "world");

/* check connection */
if (mysqli_connect_errno()) {
    printf("Connect failed: %s\n", mysqli_connect_error());
    exit();
}

$query = "SELECT Name, SurfaceArea from Country ORDER BY Name LIMIT 5";

if ($result = mysqli_query($link, $query)) {

    /* Get field information for column 'SurfaceArea' */
    $finfo = mysqli_fetch_field_direct($result, 1);

    printf("Name:      %s\n", $finfo->name);
    printf("Table:      %s\n", $finfo->table);
    printf("max. Len: %d\n", $finfo->max_length);
    printf("Flags:       %d\n", $finfo->flags);
    printf("Type:        %d\n", $finfo->type);

    mysqli_free_result($result);
}

/* close connection */
mysqli_close($link);
?>
```

The above example will output:

```
Name:      SurfaceArea
Table:    Country
max. Len: 10
Flags:    32769
Type:     4
```

**See Also**

```
mysqli_num_fields
mysqli_fetch_field
mysqli_fetch_fields
```

**20.11.2.8.7. `mysqli_result::fetch_field`, `mysqli_fetch_field`**

Copyright 1997-2008 the PHP Documentation Group.

- `mysqli_result::fetch_field`  
`mysqli_fetch_field`

Returns the next field in the result set

**Description**

Object oriented style (method):

```
object mysqli_result::fetch_field();
```

Procedural style:

```
object mysqli_fetch_field(mysqli_result result);
```

Returns the definition of one column of a result set as an object. Call this function repeatedly to retrieve information about all columns in the result set.

**Parameters**

*result* Procedural style only: A result set identifier returned by `mysqli_query`, `mysqli_store_result` or `mysqli_use_result`.

**Return Values**

Returns an object which contains field definition information or `FALSE` if no field information is available.

**Table 20.15. Object properties**

Property	Description
name	The name of the column
orgname	Original column name if an alias was specified
table	The name of the table this field belongs to (if not calculated)
orgtable	Original table name if an alias was specified
def	The default value for this field, represented as a string
max_length	The maximum width of the field for the result set.
length	The width of the field, as specified in the table definition.
charsetnr	The character set number for the field.
flags	An integer representing the bit-flags for the field.

Property	Description
type	The data type used for this field
decimals	The number of decimals used (for integer fields)

## Examples

### Example 20.177. Object oriented style

```
<?php
$mysqli = new mysqli("localhost", "my_user", "my_password", "world");

/* check connection */
if (mysqli_connect_errno()) {
    printf("Connect failed: %s\n", mysqli_connect_error());
    exit();
}

$query = "SELECT Name, SurfaceArea from Country ORDER BY Code LIMIT 5";
if ($result = $mysqli->query($query)) {

    /* Get field information for all columns */
    while ($finfo = $result->fetch_field()) {

        printf("Name:      %s\n", $finfo->name);
        printf("Table:     %s\n", $finfo->table);
        printf("max. Len:  %d\n", $finfo->max_length);
        printf("Flags:      %d\n", $finfo->flags);
        printf("Type:       %d\n\n", $finfo->type);
    }
    $result->close();
}

/* close connection */
$mysqli->close();
?>
```

### Example 20.178. Procedural style

```
<?php
$link = mysqli_connect("localhost", "my_user", "my_password", "world");

/* check connection */
if (mysqli_connect_errno()) {
    printf("Connect failed: %s\n", mysqli_connect_error());
    exit();
}

$query = "SELECT Name, SurfaceArea from Country ORDER BY Code LIMIT 5";
if ($result = mysqli_query($link, $query)) {

    /* Get field information for all fields */
    while ($finfo = mysqli_fetch_field($result)) {

        printf("Name:      %s\n", $finfo->name);
        printf("Table:     %s\n", $finfo->table);
        printf("max. Len:  %d\n", $finfo->max_length);
        printf("Flags:      %d\n", $finfo->flags);
        printf("Type:       %d\n\n", $finfo->type);
    }
    mysqli_free_result($result);
}

/* close connection */
mysqli_close($link);
?>
```

The above example will output:

```
Name:      Name
Table:     Country
max. Len:  11
```

```

Flags: 1
Type: 254

Name: SurfaceArea
Table: Country
max. Len: 10
Flags: 32769
Type: 4

```

**See Also**

```

mysqli_num_fields
mysqli_fetch_field_direct
mysqli_fetch_fields
mysqli_field_seek

```

**20.11.2.8.8. `mysqli_result::fetch_fields`, `mysqli_fetch_fields`**

Copyright 1997-2008 the PHP Documentation Group.

- `mysqli_result::fetch_fields`

```
mysqli_fetch_fields
```

Returns an array of objects representing the fields in a result set

**Description**

Object oriented style (method):

```
array mysqli_result::fetch_fields();
```

Procedural Style:

```
array mysqli_fetch_fields(mysqli_result result);
```

This function serves an identical purpose to the `mysqli_fetch_field` function with the single difference that, instead of returning one object at a time for each field, the columns are returned as an array of objects.

**Parameters**

*result* Procedural style only: A result set identifier returned by `mysqli_query`, `mysqli_store_result` or `mysqli_use_result`.

**Return Values**

Returns an array of objects which contains field definition information or `FALSE` if no field information is available.

**Table 20.16. Object properties**

Property	Description
name	The name of the column
orgname	Original column name if an alias was specified
table	The name of the table this field belongs to (if not calculated)
orgtable	Original table name if an alias was specified
def	The default value for this field, represented as a string
max_length	The maximum width of the field for the result set.
length	The width of the field, as specified in the table definition.

Property	Description
charsetnr	The character set number for the field.
flags	An integer representing the bit-flags for the field.
type	The data type used for this field
decimals	The number of decimals used (for integer fields)

## Examples

### Example 20.179. Object oriented style

```
<?php
$mysqli = new mysqli("localhost", "my_user", "my_password", "world");

/* check connection */
if (mysqli_connect_errno()) {
    printf("Connect failed: %s\n", mysqli_connect_error());
    exit();
}

$query = "SELECT Name, SurfaceArea from Country ORDER BY Code LIMIT 5";

if ($result = $mysqli->query($query)) {

    /* Get field information for all columns */
    $finfo = $result->fetch_fields();

    foreach ($finfo as $val) {
        printf("Name:      %s\n", $val->name);
        printf("Table:     %s\n", $val->table);
        printf("max. Len:  %d\n", $val->max_length);
        printf("Flags:    %d\n", $val->flags);
        printf("Type:     %d\n\n", $val->type);
    }
    $result->close();
}

/* close connection */
$mysqli->close();
?>
```

### Example 20.180. Procedural style

```
<?php
$link = mysqli_connect("localhost", "my_user", "my_password", "world");

/* check connection */
if (mysqli_connect_errno()) {
    printf("Connect failed: %s\n", mysqli_connect_error());
    exit();
}

$query = "SELECT Name, SurfaceArea from Country ORDER BY Code LIMIT 5";

if ($result = mysqli_query($link, $query)) {

    /* Get field information for all columns */
    $finfo = mysqli_fetch_fields($result);

    foreach ($finfo as $val) {
        printf("Name:      %s\n", $val->name);
        printf("Table:     %s\n", $val->table);
        printf("max. Len:  %d\n", $val->max_length);
        printf("Flags:    %d\n", $val->flags);
        printf("Type:     %d\n\n", $val->type);
    }
    mysqli_free_result($result);
}

/* close connection */
mysqli_close($link);
?>
```

The above example will output:



```

Name:      Name
Table:    Country
max. Len: 11
Flags:    1
Type:     254

Name:      SurfaceArea
Table:    Country
max. Len: 10
Flags:    32769
Type:     4

```

**See Also**

[mysqli\\_num\\_fields](#)  
[mysqli\\_fetch\\_field\\_direct](#)  
[mysqli\\_fetch\\_field](#)

**20.11.2.8.9. [mysqli\\_result::fetch\\_object](#), [mysqli\\_fetch\\_object](#)**

Copyright 1997-2008 the PHP Documentation Group.

- [mysqli\\_result::fetch\\_object](#)  
[mysqli\\_fetch\\_object](#)

Returns the current row of a result set as an object

**Description**

Object oriented style (method):

```
object mysqli_result::fetch_object(string class_name,
                                  array params);
```

Procedural style:

```
object mysqli_fetch_object(mysqli_result result,
                           string class_name,
                           array params);
```

The [mysqli\\_fetch\\_object](#) will return the current row result set as an object where the attributes of the object represent the names of the fields found within the result set.

**Parameters**

- |                   |  |
|-------------------|--|
| <i>result</i>     | Procedural style only: A result set identifier returned by <a href="#">mysqli_query</a> , <a href="#">mysqli_store_result</a> or <a href="#">mysqli_use_result</a> . |
| <i>class_name</i> | The name of the class to instantiate, set the properties of and return. If not specified, a <a href="#">stdClass</a> object is returned.                             |
| <i>params</i>     | An optional array of parameters to pass to the constructor for <i>class_name</i> objects.  |

**Return Values**

Returns an object with string properties that corresponds to the fetched row or [NULL](#) if there are no more rows in resultset.

**Note**

Field names returned by this function are *case-sensitive*.

**Note**

This function sets NULL fields to the PHP `NULL` value.

**ChangeLog**

Version	Description
5.0.0	Added the ability to return as a different object.

**Examples****Example 20.181. Object oriented style**

```
<?php
$mysqli = new mysqli("localhost", "my_user", "my_password", "world");

/* check connection */
if (mysqli_connect_errno()) {
    printf("Connect failed: %s\n", mysqli_connect_error());
    exit();
}

$query = "SELECT Name, CountryCode FROM City ORDER by ID DESC LIMIT 50,5";

if ($result = $mysqli->query($query)) {

    /* fetch object array */
    while ($obj = $result->fetch_object()) {
        printf ("%s (%s)\n", $obj->Name, $obj->CountryCode);
    }

    /* free result set */
    $result->close();
}

/* close connection */
$mysqli->close();
?>
```

**Example 20.182. Procedural style**

```
<?php
$link = mysqli_connect("localhost", "my_user", "my_password", "world");

/* check connection */
if (mysqli_connect_errno()) {
    printf("Connect failed: %s\n", mysqli_connect_error());
    exit();
}

$query = "SELECT Name, CountryCode FROM City ORDER by ID DESC LIMIT 50,5";

if ($result = mysqli_query($link, $query)) {

    /* fetch associative array */
    while ($obj = mysqli_fetch_object($result)) {
        printf ("%s (%s)\n", $obj->Name, $obj->CountryCode);
    }

    /* free result set */
    mysqli_free_result($result);
}

/* close connection */
mysqli_close($link);
?>
```

The above example will output:

```
Pueblo (USA)
Arvada (USA)
Cape Coral (USA)
Green Bay (USA)
Santa Clara (USA)
```

**See Also**

```
mysqli_fetch_array
mysqli_fetch_assoc
mysqli_fetch_row
mysqli_query
mysqli_data_seek
```

**20.11.2.8.10. `mysqli_result::fetch_row`, `mysqli_fetch_row`**

Copyright 1997-2008 the PHP Documentation Group.

- `mysqli_result::fetch_row`

```
mysqli_fetch_row
```

Get a result row as an enumerated array

**Description**

Object oriented style (method):

```
mixed mysqli_result::fetch_row();
```

Procedural style:

```
mixed mysqli_fetch_row(mysqli_result result);
```

Fetches one row of data from the result set and returns it as an enumerated array, where each column is stored in an array offset starting from 0 (zero). Each subsequent call to this function will return the next row within the result set, or `NULL` if there are no more rows.

**Parameters**

*result* Procedural style only: A result set identifier returned by `mysqli_query`, `mysqli_store_result` or `mysqli_use_result`.

**Return Values**

`mysqli_fetch_row` returns an array of strings that corresponds to the fetched row or `NULL` if there are no more rows in result set.

**Note**

This function sets NULL fields to the PHP `NULL` value.

**Examples****Example 20.183. Object oriented style**

```
<?php
$mysqli = new mysqli("localhost", "my_user", "my_password", "world");

/* check connection */
if (mysqli_connect_errno()) {
    printf("Connect failed: %s\n", mysqli_connect_error());
    exit();
}
```

```

}
$query = "SELECT Name, CountryCode FROM City ORDER by ID DESC LIMIT 50,5";
if ($result = $mysqli->query($query)) {
    /* fetch object array */
    while ($row = $result->fetch_row()) {
        printf ("%s (%s)\n", $row[0], $row[1]);
    }
    /* free result set */
    $result->close();
}
/* close connection */
$mysqli->close();
?>

```

### Example 20.184. Procedural style

```

<?php
$link = mysqli_connect("localhost", "my_user", "my_password", "world");
/* check connection */
if (mysqli_connect_errno()) {
    printf("Connect failed: %s\n", mysqli_connect_error());
    exit();
}
$query = "SELECT Name, CountryCode FROM City ORDER by ID DESC LIMIT 50,5";
if ($result = mysqli_query($link, $query)) {
    /* fetch associative array */
    while ($row = mysqli_fetch_row($result)) {
        printf ("%s (%s)\n", $row[0], $row[1]);
    }
    /* free result set */
    mysqli_free_result($result);
}
/* close connection */
mysqli_close($link);
?>

```

The above example will output:

```

Pueblo (USA)
Arvada (USA)
Cape Coral (USA)
Green Bay (USA)
Santa Clara (USA)

```

### See Also

[mysqli\\_fetch\\_array](#)  
[mysqli\\_fetch\\_assoc](#)  
[mysqli\\_fetch\\_object](#)  
[mysqli\\_query](#)  
[mysqli\\_data\\_seek](#)

#### 20.11.2.8.11. [mysqli\\_result->field\\_count](#), [mysqli\\_num\\_fields](#)

Copyright 1997-2008 the PHP Documentation Group.

- [mysqli\\_result->field\\_count](#)

`mysqli_num_fields`

Get the number of fields in a result

**Description**

Object oriented style (property):

```
mysqli_result {
    int field_count ;
}
```

Procedural style:

```
int mysqli_num_fields(mysqli_result result);
```

Returns the number of fields from specified result set.

**Parameters**

`result` Procedural style only: A result set identifier returned by `mysqli_query`, `mysqli_store_result` or `mysqli_use_result`.

**Return Values**

The number of fields from a result set.

**Examples****Example 20.185. Object oriented style**

```
<?php
$link = new mysqli("localhost", "my_user", "my_password", "world");

/* check connection */
if (mysqli_connect_errno()) {
    printf("Connect failed: %s\n", mysqli_connect_error());
    exit();
}

if ($result = $link->query("SELECT * FROM City ORDER BY ID LIMIT 1")) {

    /* determine number of fields in result set */
    $field_cnt = $result->field_count;

    printf("Result set has %d fields.\n", $field_cnt);

    /* close result set */
    $result->close();
}

/* close connection */
$link->close();
?>
```

**Example 20.186. Procedural style**

```
<?php
$link = mysqli_connect("localhost", "my_user", "my_password", "world");

/* check connection */
if (mysqli_connect_errno()) {
    printf("Connect failed: %s\n", mysqli_connect_error());
    exit();
}
```

```

if ($result = mysqli_query($link, "SELECT * FROM City ORDER BY ID LIMIT 1")) {
    /* determine number of fields in result set */
    $field_cnt = mysqli_num_fields($result);

    printf("Result set has %d fields.\n", $field_cnt);

    /* close result set */
    mysqli_free_result($result);
}

/* close connection */
mysqli_close($link);
?>

```

The above example will output:

```
Result set has 5 fields.
```

### See Also

[mysqli\\_fetch\\_field](#)

## 20.11.2.8.12. [mysqli\\_result::field\\_seek](#), [mysqli\\_field\\_seek](#)

Copyright 1997-2008 the PHP Documentation Group.

- [mysqli\\_result::field\\_seek](#)

[mysqli\\_field\\_seek](#)

Set result pointer to a specified field offset

### Description

Object oriented style (method):

```
bool mysqli_result::field_seek(int fieldnr);
```

Procedural style:

```
bool mysqli_field_seek(mysqli_result result,
                       int fieldnr);
```

Sets the field cursor to the given offset. The next call to [mysqli\\_fetch\\_field](#) will retrieve the field definition of the column associated with that offset.

#### Note

To seek to the beginning of a row, pass an offset value of zero.

### Parameters

*result* Procedural style only: A result set identifier returned by [mysqli\\_query](#), [mysqli\\_store\\_result](#) or [mysqli\\_use\\_result](#).

*fieldnr* The field number. This value must be in the range from 0 to `number of fields - 1`.

### Return Values

Returns [TRUE](#) on success or [FALSE](#) on failure.

## Examples

### Example 20.187. Object oriented style

```
<?php
$mysqli = new mysqli("localhost", "my_user", "my_password", "world");

/* check connection */
if (mysqli_connect_errno()) {
    printf("Connect failed: %s\n", mysqli_connect_error());
    exit();
}

$query = "SELECT Name, SurfaceArea from Country ORDER BY Code LIMIT 5";
if ($result = $mysqli->query($query)) {

    /* Get field information for 2nd column */
    $result->field_seek(1);
    $finfo = $result->fetch_field();

    printf("Name:      %s\n", $finfo->name);
    printf("Table:     %s\n", $finfo->table);
    printf("max. Len:  %d\n", $finfo->max_length);
    printf("Flags:     %d\n", $finfo->flags);
    printf("Type:      %d\n\n", $finfo->type);

    $result->close();
}

/* close connection */
$mysqli->close();
?>
```

### Example 20.188. Procedural style

```
<?php
$link = mysqli_connect("localhost", "my_user", "my_password", "world");

/* check connection */
if (mysqli_connect_errno()) {
    printf("Connect failed: %s\n", mysqli_connect_error());
    exit();
}

$query = "SELECT Name, SurfaceArea from Country ORDER BY Code LIMIT 5";
if ($result = mysqli_query($link, $query)) {

    /* Get field information for 2nd column */
    mysqli_field_seek($result, 1);
    $finfo = mysqli_fetch_field($result);

    printf("Name:      %s\n", $finfo->name);
    printf("Table:     %s\n", $finfo->table);
    printf("max. Len:  %d\n", $finfo->max_length);
    printf("Flags:     %d\n", $finfo->flags);
    printf("Type:      %d\n\n", $finfo->type);

    mysqli_free_result($result);
}

/* close connection */
mysqli_close($link);
?>
```

The above example will output:

```
Name:      SurfaceArea
Table:     Country
max. Len:  10
Flags:     32769
Type:      4
```

**See Also**

[mysqli\\_fetch\\_field](#)

**20.11.2.8.13. [mysqli\\_result::free](#), [mysqli\\_free\\_result](#)**

Copyright 1997-2008 the PHP Documentation Group.

- [mysqli\\_result::free](#)  
[mysqli\\_free\\_result](#)

Frees the memory associated with a result

**Description**

Object oriented style (all methods are equivalent):

```
void mysqli_result::free();
```

```
void mysqli_result::close();
```

```
void mysqli_result::free_result();
```

Procedural style:

```
void mysqli_free_result(mysqli_result result);
```

Frees the memory associated with the result.

**Note**

You should always free your result with [mysqli\\_free\\_result](#), when your result object is not needed anymore.

**Parameters**

[result](#) Procedural style only: A result set identifier returned by [mysqli\\_query](#), [mysqli\\_store\\_result](#) or [mysqli\\_use\\_result](#).

**Return Values**

No value is returned.

**See Also**

[mysqli\\_query](#)  
[mysqli\\_stmt\\_store\\_result](#)  
[mysqli\\_store\\_result](#)  
[mysqli\\_use\\_result](#)

**20.11.2.8.14. [mysqli\\_result->lengths](#), [mysqli\\_fetch\\_lengths](#)**

Copyright 1997-2008 the PHP Documentation Group.

- [mysqli\\_result->lengths](#)  
[mysqli\\_fetch\\_lengths](#)

Returns the lengths of the columns of the current row in the result set



## Description

Object oriented style (property):

```
mysqli_result {
    array lengths ;
}
```

Procedural style:

```
array mysqli_fetch_lengths(mysqli_result result);
```

The `mysqli_fetch_lengths` function returns an array containing the lengths of every column of the current row within the result set.

## Parameters

*result* Procedural style only: A result set identifier returned by `mysqli_query`, `mysqli_store_result` or `mysqli_use_result`.

## Return Values

An array of integers representing the size of each column (not including any terminating null characters). `FALSE` if an error occurred.

`mysqli_fetch_lengths` is valid only for the current row of the result set. It returns `FALSE` if you call it before calling `mysqli_fetch_row/array/object` or after retrieving all rows in the result.

## Examples

### Example 20.189. Object oriented style

```
<?php
$link = new mysqli("localhost", "my_user", "my_password", "world");

/* check connection */
if (mysqli_connect_errno()) {
    printf("Connect failed: %s\n", mysqli_connect_error());
    exit();
}

$query = "SELECT * from Country ORDER BY Code LIMIT 1";
if ($result = $mysqli->query($query)) {
    $row = $result->fetch_row();

    /* display column lengths */
    foreach ($result->lengths as $i => $val) {
        printf("Field %2d has Length %2d\n", $i+1, $val);
    }
    $result->close();
}

/* close connection */
$link->close();
?>
```

### Example 20.190. Procedural style

```
<?php
$link = mysqli_connect("localhost", "my_user", "my_password", "world");

/* check connection */
if (mysqli_connect_errno()) {
    printf("Connect failed: %s\n", mysqli_connect_error());
    exit();
}
```

```

$query = "SELECT * from Country ORDER BY Code LIMIT 1";
if ($result = mysqli_query($link, $query)) {
    $row = mysqli_fetch_row($result);

    /* display column lengths */
    foreach (mysqli_fetch_lengths($result) as $i => $val) {
        printf("Field %2d has Length %2d\n", $i+1, $val);
    }
    mysqli_free_result($result);
}

/* close connection */
mysqli_close($link);
?>

```

The above example will output:

```

Field 1 has Length 3
Field 2 has Length 5
Field 3 has Length 13
Field 4 has Length 9
Field 5 has Length 6
Field 6 has Length 1
Field 7 has Length 6
Field 8 has Length 4
Field 9 has Length 6
Field 10 has Length 6
Field 11 has Length 5
Field 12 has Length 44
Field 13 has Length 7
Field 14 has Length 3
Field 15 has Length 2

```

### 20.11.2.8.15. `mysqli_result->num_rows`, `mysqli_num_rows`

Copyright 1997-2008 the PHP Documentation Group.

- `mysqli_result->num_rows`  
`mysqli_num_rows`

Gets the number of rows in a result

#### Description

Object oriented style (property):

```

mysqli_result {
    int num_rows ;
}

```

Procedural style:

```

int mysqli_num_rows(mysqli_result result);

```

Returns the number of rows in the result set.

The use of `mysqli_num_rows` depends on whether you use buffered or unbuffered result sets. In case you use unbuffered result-sets `mysqli_num_rows` will not correct the correct number of rows until all the rows in the result have been retrieved.

#### Parameters

*result*

Procedural style only: A result set identifier returned by `mysqli_query`, `mysqli_store_result` or `mysqli_use_result`.

**Return Values**

Returns number of rows in the result set.

**Note**

If the number of rows is greater than maximal int value, the number will be returned as a string.

**Examples****Example 20.191. Object oriented style**

```
<?php
$mysqli = new mysqli("localhost", "my_user", "my_password", "world");

/* check connection */
if (mysqli_connect_errno()) {
    printf("Connect failed: %s\n", mysqli_connect_error());
    exit();
}

if ($result = $mysqli->query("SELECT Code, Name FROM Country ORDER BY Name")) {

    /* determine number of rows result set */
    $row_cnt = $result->num_rows;

    printf("Result set has %d rows.\n", $row_cnt);

    /* close result set */
    $result->close();
}

/* close connection */
$mysqli->close();
?>
```

**Example 20.192. Procedural style**

```
<?php
$link = mysqli_connect("localhost", "my_user", "my_password", "world");

/* check connection */
if (mysqli_connect_errno()) {
    printf("Connect failed: %s\n", mysqli_connect_error());
    exit();
}

if ($result = mysqli_query($link, "SELECT Code, Name FROM Country ORDER BY Name")) {

    /* determine number of rows result set */
    $row_cnt = mysqli_num_rows($result);

    printf("Result set has %d rows.\n", $row_cnt);

    /* close result set */
    mysqli_free_result($result);
}

/* close connection */
mysqli_close($link);
?>
```

The above example will output:

```
Result set has 239 rows.
```

**See Also**

[mysqli\\_affected\\_rows](#)  
[mysqli\\_store\\_result](#)  
[mysqli\\_use\\_result](#)  
[mysqli\\_query](#)

**20.11.2.9. The MySQLi\_Driver class (MySQLi\_Driver)**

Copyright 1997-2008 the PHP Documentation Group.

MySQLi Driver.

```

MySQLi_Driver {
    MySQLi_Driver

        Properties

    public readonly string client_info ;

    public readonly string client_version ;

    public readonly string driver_version ;

    public readonly string embedded ;

    public bool reconnect ;

    public int report-mode ;

    Methods

    void mysqli_driver::embedded_server_end();

    bool mysqli_driver::embedded_server_start(bool start,
                                              array arguments,
                                              array groups);
}

```

<code>client_info</code>	The Client API header version
<code>client_version</code>	The Client version
<code>driver_version</code>	The MySQLi Driver version
<code>embedded</code>	Whether MySQLi Embedded support is enabled
<code>reconnect</code>	Allow or prevent reconnect (see the <code>mysqli.reconnect</code> INI directive)
<code>report_mode</code>	Set to <code>MYSQLI_REPORT_STRICT</code> to throw Exceptions for errors

**20.11.2.9.1. mysqli\_driver::embedded\_server\_end, mysqli\_embedded\_server\_end**

Copyright 1997-2008 the PHP Documentation Group.

- `mysqli_driver::embedded_server_end`  
`mysqli_embedded_server_end`  
 Stop embedded server

**Description**

```
void mysqli_driver::embedded_server_end();
```

```
void mysqli_embedded_server_end();
```

### Warning

This function is currently not documented; only its argument list is available.

#### 20.11.2.9.2. `mysqli_driver::embedded_server_start`, `mysqli_embedded_server_start`

Copyright 1997-2008 the PHP Documentation Group.

- `mysqli_driver::embedded_server_start`  
`mysqli_embedded_server_start`

Initialize and start embedded server

### Description

```
bool mysqli_driver::embedded_server_start(bool start,
                                          array arguments,
                                          array groups);
```

```
bool mysqli_embedded_server_start(bool start,
                                   array arguments,
                                   array groups);
```

### Warning

This function is currently not documented; only its argument list is available.

#### 20.11.2.10. Aliases and deprecated Mysqli Functions

Copyright 1997-2008 the PHP Documentation Group.

##### 20.11.2.10.1. `mysqli_bind_param`

Copyright 1997-2008 the PHP Documentation Group.

- `mysqli_bind_param`  
Alias for `mysqli_stmt_bind_param`

### Description

This function is an alias of `mysqli_stmt_bind_param`.

### Notes

### Note

`mysqli_bind_param` is deprecated and will be removed.

### See Also

`mysqli_stmt_bind_param`

##### 20.11.2.10.2. `mysqli_bind_result`

Copyright 1997-2008 the PHP Documentation Group.

- `mysqli_bind_result`  
Alias for `mysqli_stmt_bind_result`

**Description**

This function is an alias of `mysqli_stmt_bind_result`.

**Notes****Note**

`mysqli_bind_result` is deprecated and will be removed.

**See Also**

`mysqli_stmt_bind_result`

**20.11.2.10.3. `mysqli_client_encoding`**

Copyright 1997-2008 the PHP Documentation Group.

- `mysqli_client_encoding`  
Alias of `mysqli_character_set_name`

**Description**

This function is an alias of `mysqli_character_set_name`.

**See Also**

`mysqli_real_escape_string`

**20.11.2.10.4. `mysqli_disable_reads_from_master`, `mysqli->disable_reads_from_master`**

Copyright 1997-2008 the PHP Documentation Group.

- `mysqli_disable_reads_from_master`  
`mysqli->disable_reads_from_master`  
Disable reads from master

**Description**

Procedural style:

```
bool mysqli_disable_reads_from_master(mysqli link);
```

Object oriented style (method):

```
mysqli {  
    void disable_reads_from_master();  
}
```

**Warning**

This function is currently not documented; only its argument list is available.

**Warning**

This function has been *DEPRECATED* and *REMOVED* as of PHP 5.3.0.

**20.11.2.10.5. `mysqli_disable_rpl_parse`**

Copyright 1997-2008 the PHP Documentation Group.

---

- `mysqli_disable_rpl_parse`

Disable RPL parse

#### Description

```
bool mysqli_disable_rpl_parse(mysqli link);
```

##### Warning

This function is currently not documented; only its argument list is available.

##### Warning

This function has been *DEPRECATED* and *REMOVED* as of PHP 5.3.0.

#### 20.11.2.10.6. `mysqli_enable_reads_from_master`

[Copyright 1997-2008 the PHP Documentation Group.](#)

- `mysqli_enable_reads_from_master`

Enable reads from master

#### Description

```
bool mysqli_enable_reads_from_master(mysqli link);
```

##### Warning

This function is currently not documented; only its argument list is available.

##### Warning

This function has been *DEPRECATED* and *REMOVED* as of PHP 5.3.0.

#### 20.11.2.10.7. `mysqli_enable_rpl_parse`

[Copyright 1997-2008 the PHP Documentation Group.](#)

- `mysqli_enable_rpl_parse`

Enable RPL parse

#### Description

```
bool mysqli_enable_rpl_parse(mysqli link);
```

##### Warning

This function is currently not documented; only its argument list is available.

##### Warning

This function has been *DEPRECATED* and *REMOVED* as of PHP 5.3.0.

#### 20.11.2.10.8. `mysqli_escape_string`

[Copyright 1997-2008 the PHP Documentation Group.](#)

- `mysqli_escape_string`

Alias of `mysqli_real_escape_string`

**Description**

This function is an alias of `mysqli_real_escape_string`.

**See Also**

`mysqli_real_escape_string`

**20.11.2.10.9. `mysqli_execute`**

Copyright 1997-2008 the PHP Documentation Group.

- `mysqli_execute`

Alias for `mysqli_stmt_execute`

**Description**

This function is an alias of `mysqli_stmt_execute`.

**Notes****Note**

`mysqli_execute` is deprecated and will be removed.

**See Also**

`mysqli_stmt_execute`

**20.11.2.10.10. `mysqli_fetch`**

Copyright 1997-2008 the PHP Documentation Group.

- `mysqli_fetch`

Alias for `mysqli_stmt_fetch`

**Description**

This function is an alias of `mysqli_stmt_fetch`.

**Notes****Note**

`mysqli_fetch` is deprecated and will be removed.

**See Also**

`mysqli_stmt_fetch`

**20.11.2.10.11. `mysqli_get_metadata`**

Copyright 1997-2008 the PHP Documentation Group.

- `mysqli_get_metadata`

Alias for `mysqli_stmt_result_metadata`

**Description**

This function is an alias of `mysqli_stmt_result_metadata`.



**Notes****Note**

`mysqli_get_metadata` is deprecated and will be removed.

**See Also**

`mysqli_stmt_result_metadata`

**20.11.2.10.12. `mysqli_master_query`**

Copyright 1997-2008 the PHP Documentation Group.

- `mysqli_master_query`

Enforce execution of a query on the master in a master/slave setup

**Description**

```
bool mysqli_master_query(mysqli link,  
                        string query);
```

**Warning**

This function is currently not documented; only its argument list is available.

**Warning**

This function has been *DEPRECATED* and *REMOVED* as of PHP 5.3.0.

**20.11.2.10.13. `mysqli_param_count`**

Copyright 1997-2008 the PHP Documentation Group.

- `mysqli_param_count`

Alias for `mysqli_stmt_param_count`

**Description**

This function is an alias of `mysqli_stmt_param_count`.

**Notes****Note**

`mysqli_param_count` is deprecated and will be removed.

**See Also**

`mysqli_stmt_param_count`

**20.11.2.10.14. `mysqli_report`**

Copyright 1997-2008 the PHP Documentation Group.

- `mysqli_report`

Enables or disables internal report functions

**Description**

```
bool mysqli_report(int flags);
```

`mysqli_report` is a powerful function to improve your queries and code during development and testing phase. Depending on the flags it reports errors from `mysqli` function calls or queries which don't use an index (or use a bad index).

### Parameters

*flags*

**Table 20.17. Supported flags**

Name	Description
<code>MYSQLI_REPORT_OFF</code>	Turns reporting off
<code>MYSQLI_REPORT_ERROR</code>	Report errors from <code>mysqli</code> function calls
<code>MYSQLI_REPORT_STRICT</code>	Report warnings from <code>mysqli</code> function calls
<code>MYSQLI_REPORT_INDEX</code>	Report if no index or bad index was used in a query
<code>MYSQLI_REPORT_ALL</code>	Set all options (report all)

### Return Values

Returns `TRUE` on success or `FALSE` on failure.

### Examples

#### Example 20.193. Object oriented style

```
<?php
/* activate reporting */
mysqli_report(MYSQLI_REPORT_ALL);

$mysqli = new mysqli("localhost", "my_user", "my_password", "world");

/* check connection */
if (mysqli_connect_errno()) {
    printf("Connect failed: %s\n", mysqli_connect_error());
    exit();
}

/* this query should report an error */
$result = $mysqli->query("SELECT Name FROM Nonexistingtable WHERE population > 50000");

/* this query should report a warning */
$result = $mysqli->query("SELECT Name FROM City WHERE population > 50000");
$result->close();

$mysqli->close();
?>
```

### See Also

[mysqli\\_debug](#)  
[mysqli\\_dump\\_debug\\_info](#)

#### 20.11.2.10.15. `mysqli_rpl_parse_enabled`

Copyright 1997-2008 the PHP Documentation Group.

- `mysqli_rpl_parse_enabled`

Check if RPL parse is enabled

**Description**

```
int mysqli_rpl_parse_enabled(mysqli link);
```

**Warning**

This function is currently not documented; only its argument list is available.

**Warning**

This function has been *DEPRECATED* and *REMOVED* as of PHP 5.3.0.

**20.11.2.10.16. [mysqli\\_rpl\\_probe](#)**

Copyright 1997-2008 the PHP Documentation Group.

- [mysqli\\_rpl\\_probe](#)

RPL probe

**Description**

```
bool mysqli_rpl_probe(mysqli link);
```

**Warning**

This function is currently not documented; only its argument list is available.

**Warning**

This function has been *DEPRECATED* and *REMOVED* as of PHP 5.3.0.

**20.11.2.10.17. [mysqli\\_rpl\\_query\\_type](#), [mysqli->rpl\\_query\\_type](#)**

Copyright 1997-2008 the PHP Documentation Group.

- [mysqli\\_rpl\\_query\\_type](#)

[mysqli->rpl\\_query\\_type](#)

Returns RPL query type

**Description**

Procedural style:

```
int mysqli_rpl_query_type(mysqli link,
                          string query);
```

Object oriented style (method)

```
mysqli {
    int rpl_query_type(string query);
}
```

Returns [MYSQLI\\_RPL\\_MASTER](#) , [MYSQLI\\_RPL\\_SLAVE](#) or [MYSQLI\\_RPL\\_ADMIN](#) depending on a query type. [INSERT](#), [UPDATE](#) and similar are *master* queries, [SELECT](#) is *slave*, and [FLUSH](#), [REPAIR](#) and similar are *admin*.

**Warning**

This function is currently not documented; only its argument list is available.

**Warning**

This function has been *DEPRECATED* and *REMOVED* as of PHP 5.3.0.

#### 20.11.2.10.18. `mysqli_send_long_data`

Copyright 1997-2008 the PHP Documentation Group.

- `mysqli_send_long_data`  
Alias for `mysqli_stmt_send_long_data`

##### Description

This function is an alias of `mysqli_stmt_send_long_data`.

##### Notes

##### Note

`mysqli_send_long_data` is deprecated and will be removed.

##### See Also

`mysqli_stmt_send_long_data`

#### 20.11.2.10.19. `mysqli_send_query`, `mysqli->send_query`

Copyright 1997-2008 the PHP Documentation Group.

- `mysqli_send_query`  
`mysqli->send_query`  
Send the query and return

##### Description

Procedural style:

```
bool mysqli_send_query(mysqli link,  
                       string query);
```

Object oriented style (method)

```
mysqli {  
    bool send_query(string query);  
}
```

##### Warning

This function is currently not documented; only its argument list is available.

##### Warning

This function has been *DEPRECATED* and *REMOVED* as of PHP 5.3.0.

#### 20.11.2.10.20. `mysqli_set_opt`

Copyright 1997-2008 the PHP Documentation Group.

- `mysqli_set_opt`  
Alias of `mysqli_options`

**Description**

This function is an alias of `mysqli_options`.

**20.11.2.10.21. `mysqli_slave_query`**

Copyright 1997-2008 the PHP Documentation Group.

- `mysqli_slave_query`

Force execution of a query on a slave in a master/slave setup

**Description**

```
bool mysqli_slave_query(mysqli link,
                        string query);
```

**Warning**

This function is currently not documented; only its argument list is available.

**Warning**

This function has been *DEPRECATED* and *REMOVED* as of PHP 5.3.0.

**20.11.3. MySQL Functions (PDO\_MYSQL)**

Copyright 1997-2008 the PHP Documentation Group.

PDO\_MYSQL is a driver that implements the [PHP Data Objects \(PDO\) interface](#) to enable access from PHP to MySQL 3.x, 4.x and 5.x databases.

PDO\_MYSQL will take advantage of native prepared statement support present in MySQL 4.1 and higher. If you're using an older version of the mysql client libraries, PDO will emulate them for you.

**Warning**

Beware: Some MySQL table types (storage engines) do not support transactions. When writing transactional database code using a table type that does not support transactions, MySQL will pretend that a transaction was initiated successfully. In addition, any DDL queries issued will implicitly commit any pending transactions.

The constants below are defined by this driver, and will only be available when the extension has been either compiled into PHP or dynamically loaded at runtime. In addition, these driver-specific constants should only be used if you are using this driver. Using mysql-specific attributes with the postgres driver may result in unexpected behaviour. `PDO::getAttribute` may be used to obtain the `PDO_ATTR_DRIVER_NAME` attribute to check the driver, if your code can run against multiple drivers.

`PDO::MYSQL_ATTR_USE_BUFFERED_QUERY` (integer) If this attribute is set to `TRUE` on a `PDOStatement`, the MySQL driver will use the buffered versions of the MySQL API. If you're writing portable code, you should use `PDOStatement::fetchAll` instead.

**Example 20.194. Forcing queries to be buffered in mysql**

```
<?php
if ($db->getAttribute(PDO::ATTR_DRIVER_NAME) == 'mysql') {
    $stmt = $db->prepare('select * from foo',
        array(PDO::MYSQL_ATTR_USE_BUFFERED_QUERY => true));
} else {
    die("my application only works with mysql; I should use \$stmt->fetchAll() instead");
}
?>
```

`PDO::MYSQL_ATTR_LOCAL_INFILE` (integer) Enable `LOAD LOCAL INFILE`.

<code>PDO::MYSQL_ATTR_INIT_COMMAND</code> (integer)	Command to execute when connecting to the MySQL server. Will automatically be re-executed when reconnecting.
<code>PDO::MYSQL_ATTR_READ_DEFAULT_FILE</code> (integer)	Read options from the named option file instead of from <code>my.cnf</code> .
<code>PDO::MYSQL_ATTR_READ_DEFAULT_GROUP</code> (integer)	Read options from the named group from <code>my.cnf</code> or the file specified with <code>MYSQL_READ_DEFAULT_FILE</code> .
<code>PDO::MYSQL_ATTR_MAX_BUFFER_SIZE</code> (integer)	Maximum buffer size. Defaults to 1 MiB.
<code>PDO::MYSQL_ATTR_DIRECT_QUERY</code> (integer)	Perform direct queries, don't use prepared statements.

### 20.11.3.1. PDO\_MYSQL DSN

Copyright 1997-2008 the PHP Documentation Group.

- `PDO_MYSQL DSN`

Connecting to MySQL databases

#### Description

The `PDO_MYSQL` Data Source Name (DSN) is composed of the following elements:

DSN prefix	The DSN prefix is <code>mysql:</code> .
<code>host</code>	The hostname on which the database server resides.
<code>port</code>	The port number where the database server is listening.
<code>dbname</code>	The name of the database.
<code>unix_socket</code>	The MySQL Unix socket (shouldn't be used with <code>host</code> or <code>port</code> ).

#### Examples

#### Example 20.195. PDO\_MYSQL DSN examples

The following example shows a `PDO_MYSQL` DSN for connecting to MySQL databases:

```
mysql:host=localhost;dbname=testdb
```

More complete examples:

```
mysql:host=localhost;port=3307;dbname=testdb
mysql:unix_socket=/tmp/mysql.sock;dbname=testdb
```

### 20.11.4. Connector/PHP

The MySQL Connector/PHP is a version of the `mysql` and `mysql_i` extensions for PHP optimized for the Windows operating system. Later versions of the main PHP `mysql/mysql_i` drivers are compatible with Windows and a separate, Windows specific driver is no longer required.

For PHP for all platforms, including Windows, you should use the `mysql` or `mysql_i` extensions shipped with the PHP sources. See [Section 20.11, "MySQL PHP API"](#).

### 20.11.5. Common Problems with MySQL and PHP

- **Error: Maximum Execution Time Exceeded:** This is a PHP limit; go into the `php.ini` file and set the maximum execution time up from 30 seconds to something higher, as needed. It is also not a bad idea to double the RAM allowed per script to 16MB instead of 8MB.
- **Fatal error: Call to unsupported or undefined function mysql\_connect() in ...:** This means that your PHP version isn't compiled with MySQL support. You can either compile a dynamic MySQL module and load it into PHP or recompile PHP with built-in MySQL support. This process is described in detail in the PHP manual.
- **Error: Undefined reference to 'uncompress':** This means that the client library is compiled with support for a compressed client/server protocol. The fix is to add `-lz` last when linking with `-lmysqlclient`.
- **Error: Client does not support authentication protocol:** This is most often encountered when trying to use the older `mysql` extension with MySQL 4.1.1 and later. Possible solutions are: downgrade to MySQL 4.0; switch to PHP 5 and the newer `mysqli` extension; or configure the MySQL server with `--old-passwords`. (See [Section B.1.2.4](#), “Client does not support authentication protocol”, for more information.)

Those with PHP4 legacy code can make use of a compatibility layer for the old and new MySQL libraries, such as this one: <http://www.coggeshall.org/oss/mysq2i>.

## 20.11.6. Enabling Both `mysql` and `mysqli` in PHP

If you're experiencing problems with enabling both the `mysql` and the `mysqli` extension when building PHP on Linux yourself, you should try the following procedure.

1. Configure PHP like this:

```
./configure --with-mysqli=/usr/bin/mysql_config --with-mysql=/usr
```

2. Edit the `Makefile` and search for a line that starts with `EXTRA_LIBS`. It might look like this (all on one line):

```
EXTRA_LIBS = -lcrypt -lcrypt -lmysqlclient -lz -lresolv -lm -ldl -lnsl  
-lxml2 -lz -lm -lxml2 -lz -lm -lmysqlclient -lz -lcrypt -lnsl -lm  
-lxml2 -lz -lm -lcrypt -lxml2 -lz -lm -lcrypt
```

Remove all duplicates, so that the line looks like this (all on one line):

```
EXTRA_LIBS = -lcrypt -lcrypt -lmysqlclient -lz -lresolv -lm -ldl -lnsl  
-lxml2
```

3. Build and install PHP:

```
make  
make install
```

### MySQL Enterprise

MySQL Enterprise subscribers will find more information about the `mysqli` extension in the Knowledge Base articles found at [mysqli](#). Access to the MySQL Knowledge Base collection of articles is one of the advantages of subscribing to MySQL Enterprise. For more information, see <http://www.mysql.com/products/enterprise/advisors.html>.

## 20.12. MySQL Perl API

The Perl `DBI` module provides a generic interface for database access. You can write a DBI script that works with many different database engines without change. To use DBI, you must install the `DBI` module, as well as a DataBase Driver (DBD) module for each type of server you want to access. For MySQL, this driver is the `DBD: :mysql` module.

Perl DBI is the recommended Perl interface. It replaces an older interface called `mysqlperl`, which should be considered obsolete.

Installation instructions for Perl DBI support are given in [Section 2.15](#), “Perl Installation Notes”.

DBI information is available at the command line, online, or in printed form:

- Once you have the `DBI` and `DBD: :mysql` modules installed, you can get information about them at the command line with the `perldoc` command:

```
shell> perldoc DBI
shell> perldoc DBI:FAQ
shell> perldoc DBD:mysql
```

You can also use [pod2man](#), [pod2html](#), and so forth to translate this information into other formats.

- For online information about Perl DBI, visit the DBI Web site, <http://dbi.perl.org/>. That site hosts a general DBI mailing list. Sun Microsystems, Inc. hosts a list specifically about `DBD:mysql`; see [Section 1.5.1, “MySQL Mailing Lists”](#).
- For printed information, the official DBI book is *Programming the Perl DBI* (Alligator Descartes and Tim Bunce, O'Reilly & Associates, 2000). Information about the book is available at the DBI Web site, <http://dbi.perl.org/>.

For information that focuses specifically on using DBI with MySQL, see *MySQL and Perl for the Web* (Paul DuBois, New Riders, 2001). This book's Web site is <http://www.kitebird.com/mysql-perl/>.

## 20.13. MySQL C++ API

`MySQL++` is a MySQL API for C++. Warren Young has taken over this project. More information can be found at <http://tangentsoft.net/mysql++/doc>.

### MySQL Enterprise

MySQL Enterprise subscribers will find more information about using C++ with the MySQL API in the MySQL Knowledge Base articles found at [C++](#). Access to the MySQL Knowledge Base collection of articles is one of the advantages of subscribing to MySQL Enterprise. For more information, see <http://www.mysql.com/products/enterprise/advisors.html>.

## 20.14. MySQL Python API

`MySQLdb` provides MySQL support for Python, compliant with the Python DB API version 2.0. It can be found at <http://sourceforge.net/projects/mysql-python/>.

### MySQL Enterprise

MySQL Enterprise subscribers will find more information about using Python with the MySQL API in the MySQL Knowledge Base articles found at [Python](#). Access to the MySQL Knowledge Base collection of articles is one of the advantages of subscribing to MySQL Enterprise. For more information, see <http://www.mysql.com/products/enterprise/advisors.html>.

## 20.15. MySQL Ruby APIs

Two APIs available for Ruby programmers. The MySQL/Ruby API is based on the `libmysql` API library. The Ruby/MySQL API is written to use the native MySQL network protocol (a native driver).

For more information on Ruby, see [Ruby Programming Language](#).

For information on installing and using the MySQL/Ruby API, see [Section 20.15.1, “The MySQL/Ruby API”](#).

For information on installing and using the Ruby/MySQL API, see [Section 20.15.2, “The Ruby/MySQL API”](#).

### 20.15.1. The MySQL/Ruby API

The MySQL/Ruby module provides access to MySQL databases using Ruby through `libmysql`.

For information on installing the module, and the functions exposed, see [MySQL/Ruby](#).

### 20.15.2. The Ruby/MySQL API

The Ruby/MySQL module provides access to MySQL databases using Ruby through a native driver interface using the MySQL network protocol.

For information on installing the module, and the functions exposed, see [Ruby/MySQL](#).

## 20.16. MySQL Tcl API

`MySQLtcl` is a simple API for accessing a MySQL database server from the Tcl programming language. It can be found at <http://www.xdobry.de/mysqltcl/>.



## 20.17. MySQL Eiffel Wrapper

Eiffel MySQL is an interface to the MySQL database server using the Eiffel programming language, written by Michael Ravits. It can be found at <http://efsa.sourceforge.net/archive/ravits/mysql.htm>.

---

# Chapter 21. Extending MySQL

## 21.1. MySQL Internals

This chapter describes a lot of things that you need to know when working on the MySQL code. If you plan to contribute to MySQL development, want to have access to the bleeding-edge versions of the code, or just want to keep track of development, follow the instructions in [Section 2.10.3, “Installing from the Development Source Tree”](#). If you are interested in MySQL internals, you should also subscribe to our `internals` mailing list. This list has relatively low traffic. For details on how to subscribe, please see [Section 1.5.1, “MySQL Mailing Lists”](#). All developers at MySQL AB are on the `internals` list and we help other people who are working on the MySQL code. Feel free to use this list both to ask questions about the code and to send patches that you would like to contribute to the MySQL project!

### 21.1.1. MySQL Threads

The MySQL server creates the following threads:

- Connection manager threads handle client connection requests on the network interfaces that the server listens to. On all platforms, one manager thread handles TCP/IP connection requests. On Unix, this manager thread also handles Unix socket file connection requests. On Windows, a manager thread handles shared-memory connection requests, and another handles named-pipe connection requests. The server does not create threads to handle interfaces that it does not listen to. For example, a Windows server that does not have support for named-pipe connections enabled does not create a thread to handle them.
- Connection manager threads associate each client connection with a thread dedicated to it that handles authentication and request processing for that connection. Manager threads create a new thread when necessary but try to avoid doing so by consulting the thread cache first to see whether it contains a thread that can be used for the connection. When a connection ends, its thread is returned to the thread cache if the cache is not full.

For information about tuning the parameters that control thread resources, see [Section 7.5.7, “How MySQL Uses Threads for Client Connections”](#).

- On a master replication server, connections from slave servers are handled like client connections: There is one thread per connected slave.
- On a slave replication server, an I/O thread is started to connect to the master server and read updates from it. An SQL thread is started to apply updates read from the master. These two threads run independently and can be started and stopped independently.
- A signal thread handles all signals. This thread also normally handles alarms and calls `process_alarm()` to force timeouts on connections that have been idle too long.
- If `InnoDB` is used, there will be 4 additional threads by default. Those are file I/O threads, controlled by the `innodb_file_io_threads` parameter. See [Section 13.6.3, “InnoDB Startup Options and System Variables”](#).
- If `mysqld` is compiled with `-DUSE_ALARM_THREAD`, a dedicated thread that handles alarms is created. This is only used on some systems where there are problems with `sigwait()` or if you want to use the `thr_alarm()` code in your application without a dedicated signal handling thread.
- If the server is started with the `--flush_time=val` option, a dedicated thread is created to flush all tables every `val` seconds.
- Each table for which `INSERT DELAYED` statements are issued gets its own thread. See [Section 12.2.5.2, “INSERT DELAYED Syntax”](#).
- If the event scheduler is active, there is one thread for the scheduler, and a thread for each event currently running. See [Section 18.4.1, “Event Scheduler Overview”](#).

`mysqladmin processlist` only shows the connection, `INSERT DELAYED`, replication, and event threads.

#### MySQL Enterprise

For expert advice on thread management subscribe to the MySQL Enterprise Monitor. For more information, see <http://www.mysql.com/products/enterprise/advisors.html>.

### 21.1.2. MySQL Test Suite

The test system that is included in Unix source and binary distributions makes it possible for users and developers to perform regression tests on the MySQL code. These tests can be run on Unix.

You can also write your own test cases. For information about the MySQL Test Framework, including system requirements, see the manual available at <http://dev.mysql.com/doc/>.

The current set of test cases doesn't test everything in MySQL, but it should catch most obvious bugs in the SQL processing code, operating system or library issues, and is quite thorough in testing replication. Our goal is to have the tests cover 100% of the code. We welcome contributions to our test suite. You may especially want to contribute tests that examine the functionality critical to your system because this ensures that all future MySQL releases work well with your applications.

The test system consists of a test language interpreter (`mysqltest`), a Perl script to run all tests (`mysql-test-run.pl`), the actual test cases written in a special test language, and their expected results. To run the test suite on your system after a build, type `make test` from the source root directory, or change location to the `mysql-test` directory and type `./mysql-test-run.pl`. If you have installed a binary distribution, change location to the `mysql-test` directory under the installation root directory (for example, `/usr/local/mysql/mysql-test`), and run `./mysql-test-run.pl`. All tests should succeed. If any do not, feel free to try to find out why and report the problem if it indicates a bug in MySQL. See [Section 1.6, “How to Report Bugs or Problems”](#).

If one test fails, you should run `mysql-test-run.pl` with the `--force` option to check whether any other tests fail.

If you have a copy of `mysqld` running on the machine where you want to run the test suite, you do not have to stop it, as long as it is not using ports `9306` or `9307`. If either of those ports is taken, you should set the `MTR_BUILD_THREAD` environment variable to an appropriate value, and the test suite will use a different set of ports for master, slave, NDB, and Instance Manager). For example:

```
shell> export MTR_BUILD_THREAD=31
shell> ./mysql-test-run.pl [options] [test_name]
```

In the `mysql-test` directory, you can run an individual test case with `./mysql-test-run.pl test_name`.

If you have a question about the test suite, or have a test case to contribute, send an email message to the MySQL [internals](#) mailing list. See [Section 1.5.1, “MySQL Mailing Lists”](#). This list does not accept attachments, so you should FTP all the relevant files to: <ftp://ftp.mysql.com/pub/mysql/upload/>

## 21.2. The MySQL Plugin Interface

MySQL 5.1 and up supports a plugin API that allows the loading and unloading of server components at runtime, without restarting the server. The components supported by this operation include, but are not limited to, full-text parser plugins, storage-engines and server extensions. In MySQL 5.1, the storage engines can be included in the server as `opplugins`.

Full-text parser plugins can be used to replace or augment the built-in full-text parser. For example, a plugin can parse text into words using rules that differ from those used by the built-in parser. This can be useful if you need to parse text with characteristics different from those expected by the built-in parser.

The plugin interface is intended as the successor to the older user-defined function (UDF) interface. The plugin interface eventually will include an API for creating UDFs, and it is intended this plugin UDF API will replace the older non-plugin UDF API. After that point, it will be possible for UDFs to be revised for use as plugin UDFs so that they can take advantage of the better security and versioning capabilities of the plugin API. Eventually, support for the older UDF API will be phased out.

The plugin interface requires the `plugin` table in the `mysql` database. This table is created as part of the MySQL installation process. If you are upgrading from a version older than MySQL 5.1, you should run the `mysql_upgrade` command to create this table. See [Section 4.4.8, “mysql\\_upgrade — Check Tables for MySQL Upgrade”](#).

For more information on the Plugin API and how it can be used with storage engines, see [MySQL Internals: Custom Engine](#).

### 21.2.1. Characteristics of the Plugin Interface

In some respects, the plugin API is similar to the older user-defined function (UDF) API that it supersedes, but the plugin API has several advantages over the older interface:

- The plugin framework is extendable to accommodate different kinds of plugins.

Some aspects of the plugin API are common to all types of plugins, but the API also allows for type-specific interface elements so that different types of plugins can be created. A plugin with one purpose can have an interface most appropriate to its own requirements and not the requirements of some other plugin type.

Although only the interface for full-text parser plugins is implemented currently, others can be added, such as an interface for UDF plugins.

- The plugin API includes versioning information.

The version information included in the plugin API enables a plugin library and each plugin that it contains to be self-identifying with respect to the API version that was used to build the library. If the API changes over time, the version numbers will change, but a server can examine a given plugin library's version information to determine whether it supports the plugins in the library.

There are two types of version numbers. The first is the version for the general plugin framework itself. Each plugin library includes this kind of version number. The second type of version applies to individual plugins. Each specific type of plugin has a version for its interface, so each plugin in a library has a type-specific version number. For example, library containing a full-text parsing plugin has a general plugin API version number, and the plugin has a version number specific to the full-text plugin interface.

- Plugin security is improved relative to the UDF interface.

The older interface for writing non-plugin UDFs allowed libraries to be loaded from any directory searched by the system's dynamic linker, and the symbols that identified the UDF library were relatively non-specific. The newer rules are more strict. A plugin library must be installed in a specific dedicated directory for which the location is controlled by the server and cannot be changed at runtime. Also, the library must contain specific symbols that identify it as a plugin library. The server will not load something as a plugin if it was not built as a plugin.

The newer plugin interface eliminates the security issues of the older UDF interface. When a UDF plugin type is implemented, that will allow non-plugin UDFs to be brought into the plugin framework and the older interface to be phased out.

The plugin implementation includes the following components:

Source files (the locations given indicate where the files are found in a MySQL source distribution):

- `include/mysql/plugin.h` exposes the public plugin API. This file should be examined by anyone who wants to write a plugin library.
- `sql/sql_plugin.h` and `sql/sql_plugin.cc` comprise the internal plugin implementation. These files need not be consulted by plugin writers. They may be of interest for those who want to know more about how the server handles plugins.

System table:

- The `plugin` table in the `mysql` database lists each installed plugin and is required for plugin use. For new MySQL installations, this table is created during the installation process. If you are upgrading from a version older than MySQL 5.1, you should run `mysql_upgrade` to update your system tables and create the `plugin` table (see [Section 4.4.8](#), “`mysql_upgrade` — Check Tables for MySQL Upgrade”).

SQL statements:

- `INSTALL PLUGIN` registers a plugin in the `plugin` table and loads the plugin code.
- `UNINSTALL PLUGIN` unregisters a plugin from the `plugin` table and unloads the plugin code.
- The `WITH PARSER` clause for full-text index creation associates a full-text parser plugin with a given `FULLTEXT` index.
- `SHOW PLUGINS` displays information about known plugins. The `PLUGINS` table in `INFORMATION_SCHEMA` also contains plugin information.

System variable:

- `plugin_dir` indicates the location of the directory where all plugins must be installed. The value of this variable can be specified at server startup with a `--plugin_dir=path` option.

## 21.2.2. Full-Text Parser Plugins

MySQL has a built-in parser that it uses by default for full-text operations (parsing text to be indexed, or parsing a query string to determine the terms to be used for a search). For full-text processing, “parsing” means extracting words from text or a query string based on rules that define which character sequences make up a word and where word boundaries lie.

When parsing for indexing purposes, the parser passes each word to the server, which adds it to a full-text index. When parsing a query string, the parser passes each word to the server, which accumulates the words for use in a search.

The parsing properties of the built-in full-text parser are described in [Section 11.8, “Full-Text Search Functions”](#). These properties include rules for determining how to extract words from text. The parser is influenced by certain system variables such as `ft_min_word_len` and `ft_max_word_len` that cause words shorter or longer to be excluded, and by the stopword list that identifies common words to be ignored.

The plugin API enables you to provide a full-text parser of your own so that you have control over the basic duties of a parser. A parser plugin can operate in either of two roles:

- The plugin can replace the built-in parser. In this role, the plugin reads the input to be parsed, splits it up into words, and passes the words to the server (either for indexing or for word accumulation).

One reason to use a parser this way is that you need to use different rules from those of the built-in parser for determining how to split up input into words. For example, the built-in parser considers the text “case-sensitive” to consist of two words “case” and “sensitive,” whereas an application might need to treat the text as a single word.

- The plugin can act in conjunction with the built-in parser by serving as a front end for it. In this role, the plugin extracts text from the input and passes the text to the parser, which splits up the text into words using its normal parsing rules. In particular, this parsing will be affected by the `ft_***` system variables and the stopword list.

One reason to use a parser this way is that you need to index content such as PDF documents, XML documents, or `.doc` files. The built-in parser is not intended for those types of input but a plugin can pull out the text from these input sources and pass it to the built-in parser.

It is also possible for a parser plugin to operate in both roles. That is, it could extract text from non-plaintext input (the front end role), and also parse the text into words (thus replacing the built-in parser).

A full-text plugin is associated with full-text indexes on a per-index basis. That is, when you install a parser plugin initially, that does not cause it to be used for any full-text operations. It simply becomes available. For example, a full-text parser plugin becomes available to be named in a `WITH PARSE` clause when creating individual `FULLTEXT` indexes. To create such an index at table-creation time, do this:

```
CREATE TABLE t
(
  doc CHAR(255),
  FULLTEXT INDEX (doc) WITH PARSE my_parser
);
```

Or you can add the index after the table has been created:

```
ALTER TABLE t ADD FULLTEXT INDEX (doc) WITH PARSE my_parser;
```

The only SQL change for associating the parser with the index is the `WITH PARSE` clause. Searches are specified as before, with no changes needed for queries.

When you associate a parser plugin with a `FULLTEXT` index, the plugin is required for using the index. If the parser plugin is dropped, any index associated with it becomes unusable. Any attempt to use it a table for which a plugin is not available results in an error, although `DROP TABLE` is still possible.

## 21.2.3. Writing Plugins

This section describes the general and type-specific parts of the plugin API. It also provides a step-by-step guide to creating a plugin library. For example plugin source code, see the `plugin/fulltext` directory of a MySQL source distribution.

You can write plugins in C or C++ (or another language that can use C calling conventions). Plugins are loaded and unloaded dynamically, so your operating system must support dynamic loading and you must have compiled `mysqld` dynamically (not statically).

A plugin contains code that becomes part of the running server, so when you write a plugin, you are bound by any and all constraints that otherwise apply to writing server code. For example, you may have problems if you attempt to use functions from the `libstdc++` library. These constraints may change in future versions of the server, so it is possible that server upgrades will require revisions to plugins that were originally written for older servers. For information about these constraints, see [Section 2.10.2, “Typical configure Options”](#), and [Section 2.10.4, “Dealing with Problems Compiling MySQL”](#).

### 21.2.3.1. General Plugin Structures and Functions

Every plugin must have a general plugin declaration. The declaration corresponds to the `st_mysql_plugin` structure in the `plugin.h` file:

```
struct st_mysql_plugin
{
    int type;           /* the plugin type (a MYSQL_XXX_PLUGIN value) */
    void *info;        /* pointer to type-specific plugin descriptor */
    const char *name;  /* plugin name */
    const char *author; /* plugin author (for SHOW PLUGINS) */
    const char *descr; /* general descriptive text (for SHOW PLUGINS ) */
    int license;       /* the plugin license (PLUGIN_LICENSE_XXX) */
    int (*init)(void *); /* the function to invoke when plugin is loaded */
    int (*deinit)(void *); /* the function to invoke when plugin is unloaded */
    unsigned int version; /* plugin version (for SHOW PLUGINS) */
    struct st_mysql_show_var *status_vars;
    void * __reserved1; /* placeholder for system variables */
    void * __reserved2; /* placeholder for config options */
};
```

The `st_mysql_plugin` structure is common to every type of plugin. Its members should be filled in as follows:

- `type`

The plugin type. This must be one of the plugin-type values from `plugin.h`. For a full-text parser plugin, the `type` value is `MYSQL_FTPARSER_PLUGIN`.

- `info`

A pointer to the descriptor for the plugin. Unlike the general plugin declaration structure, this descriptor's structure depends on the particular type of plugin. Each descriptor has a version number that indicates the API version for that type of plugin, plus any other members needed. The descriptor for full-text plugins is described in [Section 21.2.3.2, “Type-Specific Plugin Structures and Functions”](#).

- `name`

The plugin name. This is the name that will be listed in the `plugin` table and by which you refer to the plugin in SQL statements such as `INSTALL PLUGIN` and `UNINSTALL PLUGIN`.

- `author`

The plugin author. This can be whatever you like.

- `descr`

A general description of the plugin. This can be whatever you like.

- `license`

The plugin license type. The value can be one of `PLUGIN_LICENSE_PROPRIETARY`, `PLUGIN_LICENSE_GPL`, or `PLUGIN_LICENSE_BSD`.

- `init`

A once-only initialization function. This is executed when the plugin is loaded, which happens for `INSTALL PLUGIN` or, for plugins listed in the `plugin` table, at server startup. The function takes no arguments. It returns zero for success and nonzero for failure. If an `init` function is unneeded for a plugin, it can be specified as 0.

- `deinit`

A once-only deinitialization function. This is executed when the plugin is unloaded, which happens for `UNINSTALL PLUGIN` or, for plugins listed in the `plugin` table, at server shutdown. The function takes no arguments. It returns zero for success and nonzero for failure. If a `deinit` function is unneeded for a plugin, it can be specified as 0.

- `version`

The plugin version number. When the plugin is installed, this value can be retrieved from the `INFORMATION_SCHEMA.PLUGINS` table. The value includes major and minor numbers. If you write the value as a hex constant, the format is `0xMMNN`, where `MM` and `NN` are the major and minor numbers, respectively. For example, `0x0302` represents version 3.2.

- `status_vars`

A pointer to a structure for status variables associated with the plugin, or 0 if there are no such variables. When the plugin is installed, these variables are displayed in the output of the `SHOW STATUS` statement.

- `__reserved1`, `__reserved2`

These are placeholders for the future. Currently, they should be set to `NULL`.

The `init` and `deinit` functions in the general plugin declaration are invoked only when loading and unloading the plugin. They have nothing to do with use of the plugin such as happens when an SQL statement causes the plugin to be invoked.

The `status_vars` member, if not 0, points to an array of `st_mysql_show_var` structures, each of which describes one status variable, followed by a structure with all members set to 0. The `st_mysql_show_var` structure has this definition:

```
struct st_mysql_show_var {
    const char *name;
    char *value;
    enum enum_mysql_show_type type;
};
```

When the plugin is installed, the plugin name and the `name` value are joined with an underscore to form the name displayed by `SHOW STATUS`.

The following table shows the allowable status variable `type` values and what the corresponding variable should be.

Type	Meaning
<code>SHOW_BOOL</code>	Pointer to a boolean variable
<code>SHOW_INT</code>	Pointer to an integer variable
<code>SHOW_LONG</code>	Pointer to a long integer variable
<code>SHOW_LONGLONG</code>	Pointer to a longlong integer variable
<code>SHOW_CHAR</code>	A string
<code>SHOW_CHAR_PTR</code>	Pointer to a string
<code>SHOW_ARRAY</code>	Pointer to another <code>st_mysql_show_var</code> array
<code>SHOW_FUNC</code>	Pointer to a function

For the `SHOW_FUNC` type, the function is called and fills in its `out` parameter, which then provides information about the variable to be displayed. The function has this signature:

```
#define SHOW_VAR_FUNC_BUFF_SIZE 1024
typedef int (*mysql_show_var_func) (void *thd,
    struct st_mysql_show_var *out,
    char *buf);
```

Plugins should consider the `thd` parameter to be read only.

### 21.2.3.2. Type-Specific Plugin Structures and Functions

In the `st_mysql_plugin` structure that defines a plugin's general declaration, the `info` member points to a type-specific plugin descriptor. For a full-text parser plugin, the descriptor corresponds to the `st_mysql_ftparser` structure in the `plugin.h` file:

```
struct st_mysql_ftparser
{
    int interface_version;
    int (*parse)(MYSQL_FTPARSER_PARAM *param);
    int (*init)(MYSQL_FTPARSER_PARAM *param);
    int (*deinit)(MYSQL_FTPARSER_PARAM *param);
};
```

As shown by the structure definition, the descriptor has a version number (`MYSQL_FTPARSER_INTERFACE_VERSION` for full-text parser plugins) and contains pointers to three functions. The `init` and `deinit` members should point to a function or be set to 0 if the function is not needed. The `parse` member must point to the function that performs the parsing.

A full-text parser plugin is used in two different contexts, indexing and searching. In both contexts, the server calls the initialization and deinitialization functions at the beginning and end of processing each SQL statement that causes the plugin to be invoked. However, during statement processing, the server calls the main parsing function in context-specific fashion:

- For indexing, the server calls the parser for each column value to be indexed.
- For searching, the server calls the parser to parse the search string. The parser might also be called for rows processed by the

statement. In natural language mode, there is no need for the server to call the parser. For boolean mode phrase searches or natural language searches with query expansion, the parser is used to parse column values for information that is not in the index. Also, if a boolean mode search is done for a column that has no `FULLTEXT` index, the built-in parser will be called. (Plugins are associated with specific indexes. If there is no index, no plugin is used.)

Note that the plugin declaration in the plugin library descriptor has initialization and deinitialization functions, and so does the plugin descriptor to which it points. These pairs of functions have different purposes and are invoked for different reasons:

- For the plugin declaration in the plugin library descriptor, the initialization and deinitialization functions are invoked when the plugin is loaded and unloaded.
- For the plugin descriptor, the initialization and deinitialization functions are invoked per SQL statement for which the plugin is used.

Each interface function named in the plugin descriptor should return zero for success or nonzero for failure, and each of them receives an argument that points to a `MYSQL_FTPARSER_PARAM` structure containing the parsing context. The structure has this definition:

```
typedef struct st_mysql_ftparser_param
{
    int (*mysql_parse)(struct st_mysql_ftparser_param *,
                     char *doc, int doc_len);
    int (*mysql_add_word)(struct st_mysql_ftparser_param *,
                        char *word, int word_len,
                        MYSQL_FTPARSER_BOOLEAN_INFO *boolean_info);
    void *ftparser_state;
    void *mysql_ftparam;
    struct charset_info_st *cs;
    char *doc;
    int length;
    int flags;
    enum enum_ftparser_mode mode;
} MYSQL_FTPARSER_PARAM;
```

### Note

The definition shown is current as of MySQL 5.1.12. It is incompatible with versions of MySQL 5.1 older than 5.1.12.

The structure members are used as follows:

- `mysql_parse`

A pointer to a callback function that invokes the server's built-in parser. Use this callback when the plugin acts as a front end to the built-in parser. That is, when the plugin parsing function is called, it should process the input to extract the text and pass the text to the `mysql_parse` callback.

The first parameter for this callback function should be the `param` value itself:

```
param->mysql_parse(param, ...);
```

A front end plugin can extract text and pass it all at once to the built-in parser, or it can extract and pass text to the built-in parser a piece at a time. However, in this case, the built-in parser treats the pieces of text as though there are implicit word breaks between them.

- `mysql_add_word`

A pointer to a callback function that adds a word to a full-text index or to the list of search terms. Use this callback when the parser plugin replaces the built-in parser. That is, when the plugin parsing function is called, it should parse the input into words and invoke the `mysql_add_word` callback for each word.

The first parameter for this callback function should be the `param` value itself:

```
param->mysql_add_word(param, ...);
```

- `ftparser_state`

This is a generic pointer. The plugin can set it to point to information to be used internally for its own purposes.

- `mysql_ftparam`



This is set by the server. It is passed as the first argument to the `mysql_parse` or `mysql_add_word` callback.

- `cs`

A pointer to information about the character set of the text, or 0 if no information is available.

- `doc`

A pointer to the text to be parsed.

- `length`

The length of the text to be parsed, in bytes.

- `flags`

Parser flags. This is zero if there are no special flags. Currently, the only nonzero flag is `MYSQL_FTFLAGS_NEED_COPY`, which means that `mysql_add_word()` must save a copy of the word (that is, it cannot use a pointer to the word because the word is in a buffer that will be overwritten.) This member was added in MySQL 5.1.12.

This flag might be set or reset by MySQL before calling the parser plugin, by the parser plugin itself, or by the `mysql_parse()` function.

- `mode`

The parsing mode. This value will be one of the following constants:

- `MYSQL_FTPARSER_SIMPLE_MODE`

Parse in fast and simple mode, which is used for indexing and for natural language queries. The parser should pass to the server only those words that should be indexed. If the parser uses length limits or a stopword list to determine which words to ignore, it should not pass such words to the server.

- `MYSQL_FTPARSER_WITH_STOPWORDS`

Parse in stopword mode. This is used in boolean searches for phrase matching. The parser should pass all words to the server, even stopwords or words that are outside any normal length limits.

- `MYSQL_FTPARSER_FULL_BOOLEAN_INFO`

Parse in boolean mode. This is used for parsing boolean query strings. The parser should recognize not only words but also boolean-mode operators and pass them to the server as tokens via the `mysql_add_word` callback. To tell the server what kind of token is being passed, the plugin needs to fill in a `MYSQL_FTPARSER_BOOLEAN_INFO` structure and pass a pointer to it.

If the parser is called in boolean mode, the `param->mode` value will be `MYSQL_FTPARSER_FULL_BOOLEAN_INFO`. The `MYSQL_FTPARSER_BOOLEAN_INFO` structure that the parser uses for passing token information to the server looks like this:

```
typedef struct st_mysql_ftparser_boolean_info
{
    enum enum_ft_token_type type;
    int yesno;
    int weight_adjust;
    bool wasign;
    bool trunc;
    /* These are parser state and must be removed. */
    byte prev;
    byte *quot;
} MYSQL_FTPARSER_BOOLEAN_INFO;
```

The parser should fill in the structure members as follows:

- `type`

The token type. This should be one of values shown in the following table.

Type	Meaning
<code>FT_TOKEN_EOF</code>	End of data
<code>FT_TOKEN_WORD</code>	A regular word

<code>FT_TOKEN_LEFT_PAREN</code>	The beginning of a group or subexpression
<code>FT_TOKEN_RIGHT_PAREN</code>	The end of a group or subexpression
<code>FT_TOKEN_STOPWORD</code>	A stopword

- `yesno`

Whether the word must be present for a match to occur. 0 means that the word is optional but increases the match relevance if it is present. Values larger than 0 mean that the word must be present. Values smaller than 0 mean that the word must not be present.

- `weight_adjust`

A weighting factor that determines how much a match for the word counts. It can be used to increase or decrease the word's importance in relevance calculations. A value of zero indicates no weight adjustment. Values greater than or less than zero mean higher or lower weight, respectively. The examples at [Section 11.8.2, “Boolean Full-Text Searches”](#), that use the `<` and `>` operators illustrate how weighting works.

- `wasign`

The sign of the weighting factor. A negative value acts like the `~` boolean-search operator, which causes the word's contribution to the relevance to be negative.

- `trunc`

Whether matching should be done as if the boolean-mode `*` truncation operator had been given.

Plugins should not use the `prev` and `quot` members of the `MYSQL_FTPARSER_BOOLEAN_INFO` structure.

### 21.2.3.3. Creating a Plugin Library

This section provides a step-by-step procedure for creating a plugin library. It shows how to develop a library that contains a full-text parsing plugin named `simple_parser`. This plugin performs parsing based on simpler rules than those used by the MySQL built-in full-text parser: Words are non-empty runs of whitespace characters.

Each plugin library has the following contents:

- A plugin library descriptor that indicates the version number of the general plugin API that the library uses and that contains a general declaration for each plugin in the library.
- Each plugin general declaration contains information that is common to all types of plugin: A value that indicates the plugin type; the plugin name, author, description, and license type; and pointers to the initialization and deinitialization functions that the server invokes when it loads and unloads the plugin.
- The plugin general declaration also contains a pointer to a type-specific plugin descriptor. The structure of these descriptors can vary from one plugin type to another, because each type of plugin can have its own API. A plugin descriptor contains a type-specific API version number and pointers to the functions that are needed to implement that plugin type. For example, a full-text parser plugin has initialization and deinitialization functions, and a main parsing function. The server invokes these functions when it uses the plugin to parse text.
- The plugin library contains the interface functions that are referenced by the library descriptor and by the plugin descriptors.

The easiest way to follow the instructions in this section is to use the source code in the `plugin/fulltext` directory of a MySQL source distribution. The instructions assume that you make a copy of that directory and use it to build the plugin library. To make a copy of the directory, use the following commands, which assume that the MySQL source tree is in a directory named `mysql-5.1` under your current directory:

```
shell> mkdir fulltext_plugin
shell> cp mysql-5.1/plugin/fulltext/* fulltext_plugin
```

After copying the source files, use the following procedure to create a plugin library:

1. Change location into the `fulltext_plugin` directory:

```
shell> cd fulltext_plugin
```

- The plugin source file should include the header files that the plugin library needs. The `plugin.h` file is required, and the library might require other files as well. For example:

```
#include <stdlib.h>
#include <ctype.h>
#include <mysql/plugin.h>
```

- Set up the plugin library file descriptor.

Every plugin library must include a library descriptor that must define two symbols:

- `_mysql_plugin_interface_version` specifies the version number of the general plugin framework. This is given by the `MYSQL_PLUGIN_INTERFACE_VERSION` symbol, which is defined in the `plugin.h` file.
- `_mysql_plugin_declarations` defines an array of plugin declarations, terminated by a declaration with all members set to 0. Each declaration is an instance of the `st_mysql_plugin` structure (also defined in `plugin.h`). There must be one of these for each plugin in the library.

If the server does not find these two symbols in a library, it does not accept it as a legal plugin library and rejects it with an error. This prevents use of a library for plugin purposes unless it was built specifically as a plugin library.

The standard (and most convenient) way to define the two required symbols is by using the `mysql_declare_plugin` and `mysql_declare_plugin_end` macros from the `plugin.h` file:

```
mysql_declare_plugin
... one or more plugin declarations here ...
mysql_declare_plugin_end;
```

For example, the library descriptor for a library that contains a single plugin named `simple_parser` looks like this:

```
mysql_declare_plugin
{
    MYSQL_FTPARSER_PLUGIN,      /* type */
    &simple_parser_descriptor,   /* descriptor */
    "simple_parser",            /* name */
    "MySQL AB",                /* author */
    "Simple Full-Text Parser", /* description */
    PLUGIN_LICENSE_GPL,        /* plugin license */
    simple_parser_plugin_init,  /* init function (when loaded) */
    simple_parser_plugin_deinit, /* deinit function (when unloaded) */
    0x0001,                    /* version */
    simple_status               /* status variables */
}
mysql_declare_plugin_end;
```

For a full-text parser plugin, the type must be `MYSQL_FTPARSER_PLUGIN`. This is the value that identifies the plugin as being legal for use in a `WITH PARSER` clause when creating a `FULLTEXT` index. (No other plugin type is legal for this clause.)

The `mysql_declare_plugin` and `mysql_declare_plugin_end` macros are defined in `plugin.h` like this:

```
#ifndef MYSQL_DYNAMIC_PLUGIN
#define __MYSQL_DECLARE_PLUGIN(NAME, VERSION, PSIZE, DECLS) \
int VERSION= MYSQL_PLUGIN_INTERFACE_VERSION; \
int PSIZE= sizeof(struct st_mysql_plugin); \
struct st_mysql_plugin DECLS[]= {
#else
#define __MYSQL_DECLARE_PLUGIN(NAME, VERSION, PSIZE, DECLS) \
int _mysql_plugin_interface_version= MYSQL_PLUGIN_INTERFACE_VERSION; \
int _mysql_sizeof_struct_st_plugin= sizeof(struct st_mysql_plugin); \
struct st_mysql_plugin _mysql_plugin_declarations[]= {
#endif

#define mysql_declare_plugin(NAME) \
__MYSQL_DECLARE_PLUGIN(NAME, \
    builtin_ ## NAME ## _plugin_interface_version, \
    builtin_ ## NAME ## _sizeof_struct_st_plugin, \
    builtin_ ## NAME ## _plugin)

#define mysql_declare_plugin_end ,{0,0,0,0,0,0,0,0,0}
```

One point to note about those definitions is that the `_mysql_plugin_interface_version` symbol is defined only if the `MYSQL_DYNAMIC_PLUGIN` symbol is defined. This means that you'll need to provide `-DMYSQL_DYNAMIC_PLUGIN` as part of the compilation command when you build the plugin.

When the macros are used as just shown, they expand to the following code, which defines both of the required symbols (`_mysql_plugin_interface_version` and `_mysql_plugin_declarations`):

```

int _mysql_plugin_interface_version = MYSQL_PLUGIN_INTERFACE_VERSION;
struct st_mysql_plugin _mysql_plugin_declarations[] = {
{
    MYSQL_FTPARSER_PLUGIN,      /* type */
    &simple_parser_descriptor,  /* descriptor */
    "simple_parser",            /* name */
    "MySQL AB",                /* author */
    "Simple Full-Text Parser", /* description */
    PLUGIN_LICENSE_GPL,        /* plugin license */
    simple_parser_plugin_init, /* init function (when loaded) */
    simple_parser_plugin_deinit, /* deinit function (when unloaded) */
    0x0001,                    /* version */
    simple_status               /* status variables */
}
, {0,0,0,0,0,0,0,0}
};
    
```

The preceding example declares a single plugin in the library descriptor, but it is possible to declare multiple plugins. List the declarations one after the other between `mysql_declare_plugin` and `mysql_declare_plugin_end`, separated by commas.

MySQL plugins can be written in C or C++ (or another language that can use C calling conventions). One feature of C++ is that you can use non-constant variables to initialize global structures. However, if you write a C++ plugin, you should not use this feature. Members of structures such as the `st_mysql_plugin` structure should be initialized with constant variables. See the discussion at the end of this section that describes some legal and illegal initializers for plugins.

#### 4. Set up the plugin descriptor.

Each plugin declaration in the library descriptor points to a type-specific descriptor for the corresponding plugin. In the `simple_parser` declaration, that descriptor is indicated by `&simple_parser_descriptor`. The descriptor specifies the version number for the full-text plugin interface (as given by `MYSQL_FTPARSER_INTERFACE_VERSION`), and the plugin's parsing, initialization, and deinitialization functions:

```

static struct st_mysql_ftparser simple_parser_descriptor =
{
    MYSQL_FTPARSER_INTERFACE_VERSION, /* interface version */
    simple_parser_parse,              /* parsing function */
    simple_parser_init,               /* parser init function */
    simple_parser_deinit              /* parser deinit function */
};
    
```

#### 5. Set up the plugin interface functions.

The general plugin declaration in the library descriptor names the initialization and deinitialization functions that the server should invoke when it loads and unloads the plugin. For `simple_parser`, these functions do nothing but return zero to indicate that they succeeded:

```

static int simple_parser_plugin_init(void)
{
    return(0);
}

static int simple_parser_plugin_deinit(void)
{
    return(0);
}
    
```

Because those functions do not actually do anything, you could omit them and specify 0 for each of them in the plugin declaration.

The type-specific plugin descriptor for `simple_parser` names the initialization, deinitialization, and parsing functions that the server invokes when the plugin is used. For `simple_parser`, the initialization and deinitialization functions do nothing:

```

static int simple_parser_init(MYSQL_FTPARSER_PARAM *param)
{
    return(0);
}

static int simple_parser_deinit(MYSQL_FTPARSER_PARAM *param)
{
    return(0);
}
    
```

Here too, because those functions do nothing, you could omit them and specify 0 for each of them in the plugin descriptor.

The main parsing function, `simple_parser_parse()`, acts as a replacement for the built-in full-text parser, so it needs to split text into words and pass each word to the server. The parsing function's first argument is a pointer to a structure that contains the parsing context. This structure has a `doc` member that points to the text to be parsed, and a `length` member that in-

dicates how long the text is. The simple parsing done by the plugin considers non-empty runs of whitespace characters to be words, so it identifies words like this:

```
static int simple_parser_parse(MYSQL_FTPARSER_PARAM *param)
{
    char *end, *start, *docend= param->doc + param->length;

    for (end= start= param->doc;; end++)
    {
        if (end == docend)
        {
            if (end > start)
                add_word(param, start, end - start);
            break;
        }
        else if (isspace(*end))
        {
            if (end > start)
                add_word(param, start, end - start);
            start= end + 1;
        }
    }
    return(0);
}
```

As the parser finds each word, it invokes a function `add_word()` to pass the word to the server. `add_word()` is a helper function only; it is not part of the plugin interface. The parser passes the parsing context pointer to `add_word()`, as well as a pointer to the word and a length value:

```
static void add_word(MYSQL_FTPARSER_PARAM *param, char *word, size_t len)
{
    MYSQL_FTPARSER_BOOLEAN_INFO bool_info=
        { FT_TOKEN_WORD, 0, 0, 0, 0, ' ', 0 };
    param->mysql_add_word(param, word, len, &bool_info);
}
```

For boolean-mode parsing, `add_word()` fills in the members of the `bool_info` structure as described in [Section 21.2.3.2, “Type-Specific Plugin Structures and Functions”](#).

6. Set up the status variables, if there are any. For the `simple_parser` plugin, the following status variable array sets up one status variable with a value that is static text, and another with a value that is stored in a long integer variable:

```
long number_of_calls= 0;
struct st_mysql_show_var simple_status[]=
{
    {"static", (char *)"just a static text", SHOW_CHAR},
    {"called", (char *)&number_of_calls, SHOW_LONG},
    {0,0,0}
};
```

When the plugin is installed, the plugin name and the `name` value are joined with an underscore to form the name displayed by `SHOW STATUS`. For the array just shown, the resulting status variable names are `simple_parser_static` and `simple_parser_called`. This convention means that you can easily display the variables for a plugin using its name:

```
mysql> SHOW STATUS LIKE 'simple_parser%';
+-----+-----+
| Variable_name | Value |
+-----+-----+
| simple_parser_static | just a static text |
| simple_parser_called | 0 |
+-----+-----+
```

7. Compile the plugin library as a shared library and install it in the plugin directory.

### Note

As mentioned earlier, be sure to specify `-DMYSQL_DYNAMIC_PLUGIN` as part of the compilation command when you build the plugin.

The procedure for compiling shared objects varies from system to system. If you build your library using the GNU autotools, `libtool` should be able to generate the correct compilation commands for your system. If the library is named `mypluglib`, you should end up with a shared object file that has a name something like `libmypluglib.so`. (The file name might have a different extension on your system.)

To use the autotools, you'll need to make a few changes to the configuration files at this point to enable the plugin to be compiled and installed. Assume that your MySQL distribution is installed at a base directory of `/usr/local/mysql` and that its header files are located in the `include` directory under the base directory.

Edit `Makefile.am`, which should look something like this:

```
#Makefile.am example for a plugin
pkglibdir=$(libdir)/mysql
INCLUDES= -I$(top_builddir)/include -I$(top_srcdir)/include
#noinst_LTLIBRARIES= mypluglib.la
pkglib_LTLIBRARIES= mypluglib.la
mypluglib_la_SOURCES= plugin_example.c
mypluglib_la_LDFLAGS= -module -rpath $(pkglibdir)
mypluglib_la_CFLAGS= -DMYSQL_DYNAMIC_PLUGIN
```

The `mypluglib_la_CFLAGS` line takes care of passing the `-DMYSQL_DYNAMIC_PLUGIN` flag to the compilation command.

Adjust the `INCLUDES` line to specify the path name to the installed MySQL header files. Edit it to look like this:

```
INCLUDES= -I/usr/local/mysql/include
```

Make sure that the `noinst_LTLIBRARIES` line is commented out or remove it. Make sure that the `pkglib_LTLIBRARIES` line is not commented out; it enables the `make install` command.

Set up the files needed for the `configure` command, invoke it, and run `make`:

```
shell> autoreconf --force --install --symlink
shell> ./configure --prefix=/usr/local/mysql
shell> make
```

The `--prefix` option to `configure` indicates the MySQL base directory under which the plugin should be installed. You can see what value to use for this option with `SHOW VARIABLES`:

```
mysql> SHOW VARIABLES LIKE 'basedir';
+-----+-----+
| Variable_name | Value                               |
+-----+-----+
| base          | /usr/local/mysql                   |
+-----+-----+
```

The location of the plugin directory where you should install the library is given by the `plugin_dir` system variable. For example:

```
mysql> SHOW VARIABLES LIKE 'plugin_dir';
+-----+-----+
| Variable_name | Value                               |
+-----+-----+
| plugin_dir    | /usr/local/mysql/lib/mysql/plugin  |
+-----+-----+
```

To install the plugin library, use `make`:

```
shell> make install
```

Verify that `make install` installed the plugin library in the proper directory. After installing it, make sure that the library permissions allow it to be executed by the server.

8. Register the plugin with the server.

The `INSTALL PLUGIN` statement causes the server to list the plugin in the `plugin` table and to load the plugin code from the library file. Use that statement to register `simple_parser` with the server, and then verify that the plugin is listed in the `plugin` table:

```
mysql> INSTALL PLUGIN simple_parser SONAME 'libmypluglib.so';
Query OK, 0 rows affected (0.00 sec)

mysql> SELECT * FROM mysql.plugin;
+-----+-----+
| name          | dl                               |
+-----+-----+
| simple_parser | libmypluglib.so                 |
+-----+-----+
1 row in set (0.00 sec)
```

9. Try the plugin.

Create a table that contains a string column and associate the parser plugin with a `FULLTEXT` index on the column:

```
mysql> CREATE TABLE t (c VARCHAR(255),
-> FULLTEXT (c) WITH PARSER simple_parser);
Query OK, 0 rows affected (0.01 sec)
```

Insert some text into the table and try some searches. These should verify that the parser plugin treats all non-whitespace characters as word characters:

```
mysql> INSERT INTO t VALUES
-> ('latin1_general_cs is a case-sensitive collation'),
-> ('I\'d like a case of oranges'),
-> ('this is sensitive information'),
-> ('another row'),
-> ('yet another row');
Query OK, 5 rows affected (0.02 sec)
Records: 5 Duplicates: 0 Warnings: 0
```

```
mysql> SELECT c FROM t;
+-----+
| c |
+-----+
| latin1_general_cs is a case-sensitive collation |
| I'd like a case of oranges |
| this is sensitive information |
| another row |
| yet another row |
+-----+
5 rows in set (0.00 sec)
```

```
mysql> SELECT MATCH(c) AGAINST('case') FROM t;
+-----+
| MATCH(c) AGAINST('case') |
+-----+
| 0 |
| 1.2968142032623 |
| 0 |
| 0 |
| 0 |
+-----+
5 rows in set (0.00 sec)
```

```
mysql> SELECT MATCH(c) AGAINST('sensitive') FROM t;
+-----+
| MATCH(c) AGAINST('sensitive') |
+-----+
| 0 |
| 1.3253291845322 |
| 0 |
| 0 |
+-----+
5 rows in set (0.01 sec)
```

```
mysql> SELECT MATCH(c) AGAINST('case-sensitive') FROM t;
+-----+
| MATCH(c) AGAINST('case-sensitive') |
+-----+
| 1.3109166622162 |
| 0 |
| 0 |
| 0 |
| 0 |
+-----+
5 rows in set (0.01 sec)
```

```
mysql> SELECT MATCH(c) AGAINST('I\'d') FROM t;
+-----+
| MATCH(c) AGAINST('I\'d') |
+-----+
| 0 |
| 1.2968142032623 |
| 0 |
| 0 |
| 0 |
+-----+
5 rows in set (0.01 sec)
```

Note how neither “case” nor “insensitive” match “case-insensitive” the way that they would for the built-in parser.

MySQL plugins can be written in C or C++ (or another language that can use C calling conventions). One feature of C++ is that you can use non-constant variables to initialize global structures. However, if you write a C++ plugin, you should not use this feature. Members of structures such as the `st_mysql_plugin` structure should be initialized with constant variables. The `simple_parser` descriptor shown earlier is allowable in a C++ plugin because it satisfies that requirement:

```
mysql_declare_plugin
{
    MYSQL_FTPARSER_PLUGIN, /* type */
    &simple_parser_descriptor, /* descriptor */
    "simple_parser", /* name */
}
```

```

"MySQL AB",          /* author          */
"Simple Full-Text Parser", /* description    */
PLUGIN_LICENSE_GPL, /* plugin license */
simple_parser_plugin_init, /* init function (when loaded) */
simple_parser_plugin_deinit, /* deinit function (when unloaded) */
0x0001,             /* version        */
simple_status        /* status variables */
}
mysql_declare_plugin_end;

```

Here is another valid way to write the descriptor. It uses constant variables to indicate the plugin name, author, and description:

```

const char *simple_parser_name = "simple_parser";
const char *simple_parser_author = "MySQL AB";
const char *simple_parser_description = "Simple Full-Text Parser";

mysql_declare_plugin
{
    MYSQL_FTPARSER_PLUGIN, /* type          */
    &simple_parser_descriptor, /* descriptor    */
    simple_parser_name, /* name          */
    simple_parser_author, /* author        */
    simple_parser_description, /* description   */
    PLUGIN_LICENSE_GPL, /* plugin license */
    simple_parser_plugin_init, /* init function (when loaded) */
    simple_parser_plugin_deinit, /* deinit function (when unloaded) */
    0x0001, /* version        */
    simple_status /* status variables */
}
mysql_declare_plugin_end;

```

However, the following descriptor is invalid. It uses structure members to indicate the plugin name, author, and description, but structures are not considered constant initializers in C++:

```

typedef struct
{
    const char *name;
    const char *author;
    const char *description;
} plugin_info;

plugin_info parser_info = {
    "simple_parser",
    "MySQL AB",
    "Simple Full-Text Parser"
};

mysql_declare_plugin
{
    MYSQL_FTPARSER_PLUGIN, /* type          */
    &simple_parser_descriptor, /* descriptor    */
    parser_info.name, /* name          */
    parser_info.author, /* author        */
    parser_info.description, /* description   */
    PLUGIN_LICENSE_GPL, /* plugin license */
    simple_parser_plugin_init, /* init function (when loaded) */
    simple_parser_plugin_deinit, /* deinit function (when unloaded) */
    0x0001, /* version        */
    simple_status /* status variables */
}
mysql_declare_plugin_end;

```

## 21.3. Adding New Functions to MySQL

There are three ways to add new functions to MySQL:

- You can add functions through the user-defined function (UDF) interface. User-defined functions are compiled as object files and then added to and removed from the server dynamically using the `CREATE FUNCTION` and `DROP FUNCTION` statements. See [Section 12.5.3.1, “CREATE FUNCTION Syntax”](#).
- You can add functions as native (built-in) MySQL functions. Native functions are compiled into the `mysqld` server and become available on a permanent basis.
- Another way to add functions is by creating stored functions. These are written using SQL statements rather than by compiling object code. The syntax for writing stored functions is not covered here. See [Section 18.2, “Using Stored Routines \(Procedures and Functions\)”](#).

Each method of creating compiled functions has advantages and disadvantages:



- If you write user-defined functions, you must install object files in addition to the server itself. If you compile your function into the server, you don't need to do that.
- Native functions require you to modify a source distribution. UDFs do not. You can add UDFs to a binary MySQL distribution. No access to MySQL source is necessary.
- If you upgrade your MySQL distribution, you can continue to use your previously installed UDFs, unless you upgrade to a newer version for which the UDF interface changes. For native functions, you must repeat your modifications each time you upgrade.

Whichever method you use to add new functions, they can be invoked in SQL statements just like native functions such as `ABS()` or `SOUNDEX()`.

See [Section 8.2.4, “Function Name Parsing and Resolution”](#), for the rules describing how the server interprets references to different kinds of functions.

The following sections describe features of the UDF interface, provide instructions for writing UDFs, discuss security precautions that MySQL takes to prevent UDF misuse, and describe how to add native MySQL functions.

For example source code that illustrates how to write UDFs, take a look at the `sql/udf_example.c` file that is provided in MySQL source distributions.

### 21.3.1. Features of the User-Defined Function Interface

The MySQL interface for user-defined functions provides the following features and capabilities:

- Functions can return string, integer, or real values and can accept arguments of those same types.
- You can define simple functions that operate on a single row at a time, or aggregate functions that operate on groups of rows.
- Information is provided to functions that enables them to check the number, types, and names of the arguments passed to them.
- You can tell MySQL to coerce arguments to a given type before passing them to a function.
- You can indicate that a function returns `NULL` or that an error occurred.

### 21.3.2. Adding a New User-Defined Function

For the UDF mechanism to work, functions must be written in C or C++ and your operating system must support dynamic loading. The MySQL source distribution includes a file `sql/udf_example.c` that defines 5 new functions. Consult this file to see how UDF calling conventions work. UDF-related symbols and data structures are defined in the `include/mysql_com.h` header file. (You need not include this header file directly because it is included by `mysql.h`.)

A UDF contains code that becomes part of the running server, so when you write a UDF, you are bound by any and all constraints that otherwise apply to writing server code. For example, you may have problems if you attempt to use functions from the `libc++` library. These constraints may change in future versions of the server, so it is possible that server upgrades will require revisions to UDFs that were originally written for older servers. For information about these constraints, see [Section 2.10.2, “Typical configure Options”](#), and [Section 2.10.4, “Dealing with Problems Compiling MySQL”](#).

To be able to use UDFs, you need to link `mysqld` dynamically. Don't configure MySQL using `-with-mysqld-ldflags=-all-static`. If you want to use a UDF that needs to access symbols from `mysqld` (for example, the `metaphone` function in `sql/udf_example.c` that uses `default_charset_info`), you must link the program with `-rdynamic` (see `man dlopen`). If you plan to use UDFs, the rule of thumb is to configure MySQL with `-with-mysqld-ldflags=-rdynamic` unless you have a very good reason not to.

For each function that you want to use in SQL statements, you should define corresponding C (or C++) functions. In the following discussion, the name “xxx” is used for an example function name. To distinguish between SQL and C/C++ usage, `XXX()` (uppercase) indicates an SQL function call, and `xxx()` (lowercase) indicates a C/C++ function call.

The C/C++ functions that you write to implement the interface for `XXX()` are:

- `xxx()` (required)

The main function. This is where the function result is computed. The correspondence between the SQL function data type and the return type of your C/C++ function is shown here.

SQL Type	C/C++ Type
STRING	char *
INTEGER	long long
REAL	double

It is also possible to declare a `DECIMAL` function, but currently the value is returned as a string, so you should write the UDF as though it were a `STRING` function. `ROW` functions are not implemented.

- `xxx_init()` (optional)

The initialization function for `xxx()`. It can be used for the following purposes:

- To check the number of arguments to `XXX()`.
- To check that the arguments are of a required type or, alternatively, to tell MySQL to coerce arguments to the types you want when the main function is called.
- To allocate any memory required by the main function.
- To specify the maximum length of the result.
- To specify (for `REAL` functions) the maximum number of decimal places in the result.
- To specify whether the result can be `NULL`.

- `xxx_deinit()` (optional)

The deinitialization function for `xxx()`. It should deallocate any memory allocated by the initialization function.

When an SQL statement invokes `XXX()`, MySQL calls the initialization function `xxx_init()` to let it perform any required setup, such as argument checking or memory allocation. If `xxx_init()` returns an error, MySQL aborts the SQL statement with an error message and does not call the main or deinitialization functions. Otherwise, MySQL calls the main function `xxx()` once for each row. After all rows have been processed, MySQL calls the deinitialization function `xxx_deinit()` so that it can perform any required cleanup.

For aggregate functions that work like `SUM()`, you must also provide the following functions:

- `xxx_clear()`

Reset the current aggregate value but do not insert the argument as the initial aggregate value for a new group.

- `xxx_add()`

Add the argument to the current aggregate value.

MySQL handles aggregate UDFs as follows:

1. Call `xxx_init()` to let the aggregate function allocate any memory it needs for storing results.
2. Sort the table according to the `GROUP BY` expression.
3. Call `xxx_clear()` for the first row in each new group.
4. Call `xxx_add()` for each row that belongs in the same group.
5. Call `xxx()` to get the result for the aggregate when the group changes or after the last row has been processed.
6. Repeat 3-5 until all rows has been processed
7. Call `xxx_deinit()` to let the UDF free any memory it has allocated.

All functions must be thread-safe. This includes not just the main function, but the initialization and deinitialization functions as well, and also the additional functions required by aggregate functions. A consequence of this requirement is that you are not al-

lowed to allocate any global or static variables that change! If you need memory, you should allocate it in `xxx_init()` and free it in `xxx_deinit()`.

### 21.3.2.1. UDF Calling Sequences for Simple Functions

This section describes the different functions that you need to define when you create a simple UDF. [Section 21.3.2, “Adding a New User-Defined Function”](#), describes the order in which MySQL calls these functions.

The main `xxx()` function should be declared as shown in this section. Note that the return type and parameters differ, depending on whether you declare the SQL function `XXX()` to return `STRING`, `INTEGER`, or `REAL` in the `CREATE FUNCTION` statement:

For `STRING` functions:

```
char *xxx(UDF_INIT *initid, UDF_ARGS *args,
         char *result, unsigned long *length,
         char *is_null, char *error);
```

For `INTEGER` functions:

```
long long xxx(UDF_INIT *initid, UDF_ARGS *args,
             char *is_null, char *error);
```

For `REAL` functions:

```
double xxx(UDF_INIT *initid, UDF_ARGS *args,
          char *is_null, char *error);
```

`DECIMAL` functions return string values and should be declared the same way as `STRING` functions. `ROW` functions are not implemented.

The initialization and deinitialization functions are declared like this:

```
my_bool xxx_init(UDF_INIT *initid, UDF_ARGS *args, char *message);
void xxx_deinit(UDF_INIT *initid);
```

The `initid` parameter is passed to all three functions. It points to a `UDF_INIT` structure that is used to communicate information between functions. The `UDF_INIT` structure members follow. The initialization function should fill in any members that it wishes to change. (To use the default for a member, leave it unchanged.)

- `my_bool maybe_null`

`xxx_init()` should set `maybe_null` to 1 if `xxx()` can return `NULL`. The default value is 1 if any of the arguments are declared `maybe_null`.

- `unsigned int decimals`

The number of decimal digits to the right of the decimal point. The default value is the maximum number of decimal digits in the arguments passed to the main function. For example, if the function is passed `1.34`, `1.345`, and `1.3`, the default would be 3, because `1.345` has 3 decimal digits.

For arguments that have no fixed number of decimals, the `decimals` value is set to 31, which is 1 more than the maximum number of decimals allowed for the `DECIMAL`, `FLOAT`, and `DOUBLE` data types.

A `decimals` value of 31 is used for arguments in cases such as a `FLOAT` or `DOUBLE` column declared without an explicit number of decimals (for example, `FLOAT` rather than `FLOAT(10,3)`) and for floating-point constants such as `1345E-3`. It is also used for string and other non-number arguments that might be converted within the function to numeric form.

The value to which the `decimals` member is initialized is only a default. It can be changed within the function to reflect the actual calculation performed. The default is determined such that the largest number of decimals of the arguments is used. If the number of decimals is 31 for even one of the arguments, that is the value used for `decimals`.

- `unsigned int max_length`

The maximum length of the result. The default `max_length` value differs depending on the result type of the function. For string functions, the default is the length of the longest argument. For integer functions, the default is 21 digits. For real functions, the default is 13 plus the number of decimal digits indicated by `initid->decimals`. (For numeric functions, the length includes any sign or decimal point characters.)

If you want to return a blob value, you can set `max_length` to 65KB or 16MB. This memory is not allocated, but the value is

used to decide which data type to use if there is a need to temporarily store the data.

- `char *ptr`

A pointer that the function can use for its own purposes. For example, functions can use `initid->ptr` to communicate allocated memory among themselves. `xxx_init()` should allocate the memory and assign it to this pointer:

```
initid->ptr = allocated_memory;
```

In `xxx()` and `xxx_deinit()`, refer to `initid->ptr` to use or deallocate the memory.

- `my_bool const_item`

`xxx_init()` should set `const_item` to 1 if `xxx()` always returns the same value and to 0 otherwise.

### 21.3.2.2. UDF Calling Sequences for Aggregate Functions

This section describes the different functions that you need to define when you create an aggregate UDF. [Section 21.3.2, “Adding a New User-Defined Function”](#), describes the order in which MySQL calls these functions.

- `xxx_reset()`

This function is called when MySQL finds the first row in a new group. It should reset any internal summary variables and then use the given `UDF_ARGS` argument as the first value in your internal summary value for the group. Declare `xxx_reset()` as follows:

```
void xxx_reset(UDF_INIT *initid, UDF_ARGS *args,
              char *is_null, char *error);
```

`xxx_reset()` is not needed or used in MySQL 5.1, in which the UDF interface uses `xxx_clear()` instead. However, you can define both `xxx_reset()` and `xxx_clear()` if you want to have your UDF work with older versions of the server. (If you do include both functions, the `xxx_reset()` function in many cases can be implemented internally by calling `xxx_clear()` to reset all variables, and then calling `xxx_add()` to add the `UDF_ARGS` argument as the first value in the group.)

- `xxx_clear()`

This function is called when MySQL needs to reset the summary results. It is called at the beginning for each new group but can also be called to reset the values for a query where there were no matching rows. Declare `xxx_clear()` as follows:

```
void xxx_clear(UDF_INIT *initid, char *is_null, char *error);
```

`is_null` is set to point to `CHAR(0)` before calling `xxx_clear()`.

If something went wrong, you can store a value in the variable to which the `error` argument points. `error` points to a single-byte variable, not to a string buffer.

`xxx_clear()` is required by MySQL 5.1.

- `xxx_add()`

This function is called for all rows that belong to the same group. You should use it to add the value in the `UDF_ARGS` argument to your internal summary variable.

```
void xxx_add(UDF_INIT *initid, UDF_ARGS *args,
            char *is_null, char *error);
```

The `xxx()` function for an aggregate UDF should be declared the same way as for a non-aggregate UDF. See [Section 21.3.2.1, “UDF Calling Sequences for Simple Functions”](#).

For an aggregate UDF, MySQL calls the `xxx()` function after all rows in the group have been processed. You should normally never access its `UDF_ARGS` argument here but instead return a value based on your internal summary variables.

Return value handling in `xxx()` should be done the same way as for a non-aggregate UDF. See [Section 21.3.2.4, “UDF Return Values and Error Handling”](#).

The `xxx_reset()` and `xxx_add()` functions handle their `UDF_ARGS` argument the same way as functions for non-aggregate

UDFs. See [Section 21.3.2.3, “UDF Argument Processing”](#).

The pointer arguments to `is_null` and `error` are the same for all calls to `xxx_reset()`, `xxx_clear()`, `xxx_add()` and `xxx()`. You can use this to remember that you got an error or whether the `xxx()` function should return `NULL`. You should not store a string into `*error`! `error` points to a single-byte variable, not to a string buffer.

`*is_null` is reset for each group (before calling `xxx_clear()`). `*error` is never reset.

If `*is_null` or `*error` are set when `xxx()` returns, MySQL returns `NULL` as the result for the group function.

### 21.3.2.3. UDF Argument Processing

The `args` parameter points to a `UDF_ARGS` structure that has the members listed here:

- `unsigned int arg_count`

The number of arguments. Check this value in the initialization function if you require your function to be called with a particular number of arguments. For example:

```
if (args->arg_count != 2)
{
    strcpy(message, "XXX() requires two arguments");
    return 1;
}
```

For other `UDF_ARGS` member values that are arrays, array references are zero-based. That is, refer to array members using index values from 0 to `args->arg_count - 1`.

- `enum Item_result *arg_type`

A pointer to an array containing the types for each argument. The possible type values are `STRING_RESULT`, `INT_RESULT`, `REAL_RESULT`, and `DECIMAL_RESULT`.

To make sure that arguments are of a given type and return an error if they are not, check the `arg_type` array in the initialization function. For example:

```
if (args->arg_type[0] != STRING_RESULT ||
    args->arg_type[1] != INT_RESULT)
{
    strcpy(message, "XXX() requires a string and an integer");
    return 1;
}
```

Arguments of type `DECIMAL_RESULT` are passed as strings, so you should handle them the same way as `STRING_RESULT` values.

As an alternative to requiring your function's arguments to be of particular types, you can use the initialization function to set the `arg_type` elements to the types you want. This causes MySQL to coerce arguments to those types for each call to `xxx()`. For example, to specify that the first two arguments should be coerced to string and integer, respectively, do this in `xxx_init()`:

```
args->arg_type[0] = STRING_RESULT;
args->arg_type[1] = INT_RESULT;
```

Exact-value decimal arguments such as `1.3` or `DECIMAL` column values are passed with a type of `DECIMAL_RESULT`. However, the values are passed as strings. If you want to receive a number, use the initialization function to specify that the argument should be coerced to a `REAL_RESULT` value:

```
args->arg_type[2] = REAL_RESULT;
```

- `char **args`

`args->args` communicates information to the initialization function about the general nature of the arguments passed to your function. For a constant argument `i`, `args->args[i]` points to the argument value. (See below for instructions on how to access the value properly.) For a non-constant argument, `args->args[i]` is 0. A constant argument is an expression that uses only constants, such as `3` or `4*7-2` or `SIN(3.14)`. A non-constant argument is an expression that refers to values that may change from row to row, such as column names or functions that are called with non-constant arguments.

For each invocation of the main function, `args->args` contains the actual arguments that are passed for the row currently being processed.

If argument `i` represents `NULL`, `args->args[i]` is a null pointer (0). If the argument is not `NULL`, functions can refer to it

as follows:

- An argument of type `STRING_RESULT` is given as a string pointer plus a length, to allow handling of binary data or data of arbitrary length. The string contents are available as `args->args[i]` and the string length is `args->lengths[i]`. Do not assume that the string is null-terminated.
- For an argument of type `INT_RESULT`, you must cast `args->args[i]` to a `long long` value:

```
long long int_val;
int_val = *((long long*) args->args[i]);
```

- For an argument of type `REAL_RESULT`, you must cast `args->args[i]` to a `double` value:

```
double real_val;
real_val = *((double*) args->args[i]);
```

- For an argument of type `DECIMAL_RESULT`, the value is passed as a string and should be handled like a `STRING_RESULT` value.
- `ROW_RESULT` arguments are not implemented.
- `unsigned long *lengths`

For the initialization function, the `lengths` array indicates the maximum string length for each argument. You should not change these. For each invocation of the main function, `lengths` contains the actual lengths of any string arguments that are passed for the row currently being processed. For arguments of types `INT_RESULT` or `REAL_RESULT`, `lengths` still contains the maximum length of the argument (as for the initialization function).

- `char *maybe_null`

For the initialization function, the `maybe_null` array indicates for each argument whether the argument value might be null (0 if no, 1 if yes).

- `char **attributes`

`args->attributes` communicates information about the names of the UDF arguments. For argument `i`, the attribute name is available as a string in `args->attributes[i]` and the attribute length is `args->attribute_lengths[i]`. Do not assume that the string is null-terminated.

By default, the name of a UDF argument is the text of the expression used to specify the argument. For UDFs, an argument may also have an optional `[AS] alias_name` clause, in which case the argument name is `alias_name`. The `attributes` value for each argument thus depends on whether an alias was given.

Suppose that a UDF `my_udf()` is invoked as follows:

```
SELECT my_udf(expr1, expr2 AS alias1, expr3 alias2);
```

In this case, the `attributes` and `attribute_lengths` arrays will have these values:

```
args->attributes[0] = "expr1"
args->attribute_lengths[0] = 5

args->attributes[1] = "alias1"
args->attribute_lengths[1] = 6

args->attributes[2] = "alias2"
args->attribute_lengths[2] = 6
```

- `unsigned long *attribute_lengths`

The `attribute_lengths` array indicates the length of each argument name.

### 21.3.2.4. UDF Return Values and Error Handling

The initialization function should return `0` if no error occurred and `1` otherwise. If an error occurs, `xxx_init()` should store a null-terminated error message in the `message` parameter. The message is returned to the client. The message buffer is `MYSQL_ERRMSG_SIZE` characters long, but you should try to keep the message to less than 80 characters so that it fits the width of a standard terminal screen.

The return value of the main function `xxx()` is the function value, for `long long` and `double` functions. A string function should return a pointer to the result and set `*length` to the length (in bytes) of the return value. For example:

```
memcpy(result, "result string", 13);
*length = 13;
```

MySQL passes a buffer to the `xxx()` function via the `result` parameter. This buffer is sufficiently long to hold 255 characters, which can be multi-byte characters. The `xxx()` function can store the result in this buffer if it fits, in which case the return value should be a pointer to the buffer. If the function stores the result in a different buffer, it should return a pointer to that buffer.

If your string function does not use the supplied buffer (for example, if it needs to return a string longer than 255 characters), you must allocate the space for your own buffer with `malloc()` in your `xxx_init()` function or your `xxx()` function and free it in your `xxx_deinit()` function. You can store the allocated memory in the `ptr` slot in the `UDF_INIT` structure for reuse by future `xxx()` calls. See Section 21.3.2.1, “UDF Calling Sequences for Simple Functions”.

To indicate a return value of `NULL` in the main function, set `*is_null` to 1:

```
*is_null = 1;
```

To indicate an error return in the main function, set `*error` to 1:

```
*error = 1;
```

If `xxx()` sets `*error` to 1 for any row, the function value is `NULL` for the current row and for any subsequent rows processed by the statement in which `XXX()` was invoked. (`xxx()` is not even called for subsequent rows.)

### 21.3.2.5. Compiling and Installing User-Defined Functions

Files implementing UDFs must be compiled and installed on the host where the server runs. This process is described below for the example UDF file `sql/udf_example.c` that is included in the MySQL source distribution.

The immediately following instructions are for Unix. Instructions for Windows are given later in this section.

The `udf_example.c` file contains the following functions:

- `metaphon()` returns a metaphon string of the string argument. This is something like a soundex string, but it is more tuned for English.
- `myfunc_double()` returns the sum of the ASCII values of the characters in its arguments, divided by the sum of the length of its arguments.
- `myfunc_int()` returns the sum of the length of its arguments.
- `sequence([const int])` returns a sequence starting from the given number or 1 if no number has been given.
- `lookup()` returns the IP number for a host name.
- `reverse_lookup()` returns the host name for an IP number. The function may be called either with a single string argument of the form `'xxx.xxx.xxx.xxx'` or with four numbers.

A dynamically loadable file should be compiled as a sharable object file, using a command something like this:

```
shell> gcc -shared -o udf_example.so udf_example.c
```

If you are using `gcc` with `configure` and `libtool` (which is how MySQL is configured), you should be able to create `udf_example.so` with a simpler command:

```
shell> make udf_example.la
```

After you compile a shared object containing UDFs, you must install it and tell MySQL about it. Compiling a shared object from `udf_example.c` using `gcc` directly produces a file named `udf_example.so`. Compiling the shared object using `make` produces a file named something like `udf_example.so.0.0.0` in the `.libs` directory (the exact name may vary from platform to platform). Copy the shared object to the server's plugin directory and name it `udf_example.so`. This directory is given by the value of the `plugin_dir` system variable.

#### Note

This is a change in MySQL 5.1. For earlier versions of MySQL, the shared object can be located in any directory that is searched by your system's dynamic linker.



On some systems, the `ldconfig` program that configures the dynamic linker does not recognize a shared object unless its name begins with `lib`. In this case you should rename a file such as `udf_example.so` to `libudf_example.so`.

On Windows, you can compile user-defined functions by using the following procedure:

1. You need to obtain the Bazaar source repository for MySQL 5.1. See [Section 2.10.3, “Installing from the Development Source Tree”](#).
2. You must obtain the CMake build utility from <http://www.cmake.org>. (Version 2.4.2 or later is required).
3. In the source repository, look in the `sql` directory. There are files named `udf_example.def` and `udf_example.c` there. Copy both files from this directory to your working directory.
4. Create a CMake `makefile` (`CMakeLists.txt`) with these contents:

```
PROJECT(udf_example)

# Path for MySQL include directory
INCLUDE_DIRECTORIES("c:/mysql/include")

ADD_DEFINITIONS("-DHAVE_DLOPEN")
ADD_LIBRARY(udf_example MODULE udf_example.c udf_example.def)
TARGET_LINK_LIBRARIES(udf_example wsock32)
```

5. Create the VC project and solution files:

```
cmake -G "<Generator>"
```

Invoking `cmake --help` shows you a list of valid Generators.

6. Create `udf_example.dll`:

```
devenv udf_example.sln /build Release
```

After the shared object file has been installed, notify `mysqld` about the new functions with these statements:

```
mysql> CREATE FUNCTION metaphon RETURNS STRING SONAME 'udf_example.dll';
mysql> CREATE FUNCTION myfunc_double RETURNS REAL SONAME 'udf_example.dll';
mysql> CREATE FUNCTION myfunc_int RETURNS INTEGER SONAME 'udf_example.dll';
mysql> CREATE FUNCTION sequence RETURNS INTEGER SONAME 'udf_example.dll';
mysql> CREATE FUNCTION lookup RETURNS STRING SONAME 'udf_example.dll';
mysql> CREATE FUNCTION reverse_lookup
-> RETURNS STRING SONAME 'udf_example.dll';
mysql> CREATE AGGREGATE FUNCTION avgcost
-> RETURNS REAL SONAME 'udf_example.dll';
```

Functions can be deleted using `DROP FUNCTION`:

```
mysql> DROP FUNCTION metaphon;
mysql> DROP FUNCTION myfunc_double;
mysql> DROP FUNCTION myfunc_int;
mysql> DROP FUNCTION sequence;
mysql> DROP FUNCTION lookup;
mysql> DROP FUNCTION reverse_lookup;
mysql> DROP FUNCTION avgcost;
```

The `CREATE FUNCTION` and `DROP FUNCTION` statements update the `func` system table in the `mysql` database. The function's name, type and shared library name are saved in the table. You must have the `INSERT` and `DELETE` privileges for the `mysql` database to create and drop functions.

You should not use `CREATE FUNCTION` to add a function that has previously been created. If you need to reinstall a function, you should remove it with `DROP FUNCTION` and then reinstall it with `CREATE FUNCTION`. You would need to do this, for example, if you recompile a new version of your function, so that `mysqld` gets the new version. Otherwise, the server continues to use the old version.

An active function is one that has been loaded with `CREATE FUNCTION` and not removed with `DROP FUNCTION`. All active functions are reloaded each time the server starts, unless you start `mysqld` with the `--skip-grant-tables` option. In this case, UDF initialization is skipped and UDFs are unavailable.

If the new function will be referred to in statements that will be replicated to slave servers, you must ensure that every slave server also has the function available. Otherwise, replication will fail on the slaves when they attempt to invoke the function.



### 21.3.2.6. User-Defined Function Security Precautions

MySQL takes the following measures to prevent misuse of user-defined functions.

You must have the `INSERT` privilege to be able to use `CREATE FUNCTION` and the `DELETE` privilege to be able to use `DROP FUNCTION`. This is necessary because these statements add and delete rows from the `mysql.func` table.

UDFs should have at least one symbol defined in addition to the `xxx` symbol that corresponds to the main `xxx()` function. These auxiliary symbols correspond to the `xxx_init()`, `xxx_deinit()`, `xxx_reset()`, `xxx_clear()`, and `xxx_add()` functions. `mysqld` also supports an `--allow-suspicious-udfs` option that controls whether UDFs that have only an `xxx` symbol can be loaded. By default, the option is off, to prevent attempts at loading functions from shared object files other than those containing legitimate UDFs. If you have older UDFs that contain only the `xxx` symbol and that cannot be recompiled to include an auxiliary symbol, it may be necessary to specify the `--allow-suspicious-udfs` option. Otherwise, you should avoid enabling this capability.

UDF object files cannot be placed in arbitrary directories. They must be located in the server's plugin directory. This directory is given by the value of the `plugin_dir` system variable.

#### Note

This is a change in MySQL 5.1. For earlier versions of MySQL, the shared object can be located in any directory that is searched by your system's dynamic linker.

### 21.3.3. Adding a New Native Function

To add a new native MySQL function, use the procedure described here, which requires that you use a source distribution. You cannot add native functions to a binary distribution because it is necessary to modify MySQL source code and compile MySQL from the modified source. If you migrate to another version of MySQL (for example, when a new version is released), you must repeat the procedure with the new version.

If the new native function will be referred to in statements that will be replicated to slave servers, you must ensure that every slave server also has the function available. Otherwise, replication will fail on the slaves when they attempt to invoke the function.

To add a new native function, follow these steps to modify source files in the `sql` directory. For MySQL 5.1, the first two steps apply only as of 5.1.13. For older versions, see the instructions in the corresponding section of the MySQL 5.0 manual.

1. Create a subclass for the function in `item_create.cc`:
  - If the function takes a fixed number of arguments, create a subclass of `Create_func_arg0`, `Create_func_arg1`, `Create_func_arg2`, or `Create_func_arg3`, respectively, depending on whether the function takes zero, one, two, or three arguments. For examples, see the `Create_func_uuid`, `Create_func_abs`, `Create_func_pow`, and `Create_func_lpad` classes.
  - If the function takes a variable number of arguments, create a subclass of `Create_native_func`. For an example, see `Create_func_concat`.
2. To provide a name by which the function can be referred to in SQL statements, register the name in `item_create.cc` by adding a line to this array:

```
static Native_func_registry func_array[]
```

You can register several names for the same function. For example, see the lines for `"LCASE"` and `"LOWER"`, which are aliases for `Create_func_lcase`.

3. In `item_func.h`, declare a class inheriting from `Item_num_func` or `Item_str_func`, depending on whether your function returns a number or a string.
4. In `item_func.cc`, add one of the following declarations, depending on whether you are defining a numeric or string function:

```
double Item_func_newname::val()
longlong Item_func_newname::val_int()
String *Item_func_newname::Str(String *str)
```

If you inherit your object from any of the standard items (like `Item_num_func`), you probably only have to define one of these functions and let the parent object take care of the other functions. For example, the `Item_str_func` class defines a `val()` function that executes `atof()` on the value returned by `::str()`.

5. If the function is non-deterministic, include the following statement in the item constructor to indicate that function results

should not be cached:

```
current_thd->lex->safe_to_cache_query=0;
```

A function is non-deterministic if, given fixed values for its arguments, it can return different results for different invocations.

6. You should probably also define the following object function:

```
void Item_func_newname::fix_length_and_dec()
```

This function should at least calculate `max_length` based on the given arguments. `max_length` is the maximum number of characters the function may return. This function should also set `maybe_null = 0` if the main function can't return a `NULL` value. The function can check whether any of the function arguments can return `NULL` by checking the arguments' `maybe_null` variable. Look at `Item_func_mod::fix_length_and_dec` for a typical example of how to do this.

All functions must be thread-safe. In other words, do not use any global or static variables in the functions without protecting them with mutexes.

If you want to return `NULL` from `::val()`, `::val_int()`, or `::str()`, you should set `null_value` to 1 and return 0.

For `::str()` object functions, there are additional considerations to be aware of:

- The `String *str` argument provides a string buffer that may be used to hold the result. (For more information about the `String` type, take a look at the `sql_string.h` file.)
- The `::str()` function should return the string that holds the result, or `(char*) 0` if the result is `NULL`.
- All current string functions try to avoid allocating any memory unless absolutely necessary!

## 21.4. Adding New Procedures to MySQL

In MySQL, you can define a procedure in C++ that can access and modify the data in a query before it is sent to the client. The modification can be done on a row-by-row or `GROUP BY` level.

We have created an example procedure to show you what can be done.

Additionally, we recommend that you take a look at `mysqlua`. With this you can use the LUA language to load a procedure at runtime into `mysqld`.

### 21.4.1. PROCEDURE ANALYSE

```
analyse([max_elements[,max_memory]])
```

This procedure is defined in the `sql/sql_analyse.cc` file. It examines the result from a query and returns an analysis of the results that suggests optimal data types for each column. To obtain this analysis, append `PROCEDURE ANALYSE` to the end of a `SELECT` statement:

```
SELECT ... FROM ... WHERE ... PROCEDURE ANALYSE([max_elements,[max_memory]])
```

For example:

```
SELECT col1, col2 FROM table1 PROCEDURE ANALYSE(10, 2000);
```

The results show some statistics for the values returned by the query, and propose an optimal data type for the columns. This can be helpful for checking your existing tables, or after importing new data. You may need to try different settings for the arguments so that `PROCEDURE ANALYSE()` does not suggest the `ENUM` data type when it is not appropriate.

The arguments are optional and are used as follows:

- `max_elements` (default 256) is the maximum number of distinct values that `analyse` notices per column. This is used by `analyse` to check whether the optimal data type should be of type `ENUM`; if there are more than `max_elements` distinct values, then `ENUM` is not a suggested type.
- `max_memory` (default 8192) is the maximum amount of memory that `analyse` should allocate per column while trying to

find all distinct values.

## 21.4.2. Writing a Procedure

For the moment, the only documentation for this is the source.

You can find all information about procedures by examining the following files:

- `sql/sql_analyse.cc`
- `sql/procedure.h`
- `sql/procedure.cc`
- `sql/sql_select.cc`

## 21.5. Debugging and Porting MySQL

This appendix helps you port MySQL to other operating systems. Do check the list of currently supported operating systems first. See [Section 2.1.1, “Operating Systems Supported by MySQL Community Server”](#). If you have created a new port of MySQL, please let us know so that we can list it here and on our Web site (<http://www.mysql.com/>), recommending it to other users.

Note: If you create a new port of MySQL, you are free to copy and distribute it under the GPL license, but it does not make you a copyright holder of MySQL.

A working POSIX thread library is needed for the server. On Solaris 2.5 we use Sun PThreads (the native thread support in 2.4 and earlier versions is not good enough), on Linux we use LinuxThreads by Xavier Leroy, <[Xavier.Leroy@inria.fr](mailto:Xavier.Leroy@inria.fr)>.

The hard part of porting to a new Unix variant without good native thread support is probably to port MIT-pthreads. See [mit-pthreads/README](#) and Programming POSIX Threads (<http://www.humanfactor.com/pthreads/>).

Up to MySQL 4.0.2, the MySQL distribution included a patched version of Chris Provenzano's Pthreads from MIT (see the MIT Pthreads Web page at <http://www.mit.edu/afs/sipb/project/pthreads/> and a programming introduction at [http://www.mit.edu:8001/people/proven/IAP\\_2000/](http://www.mit.edu:8001/people/proven/IAP_2000/)). These can be used for some operating systems that do not have POSIX threads. See [Section 2.10.5, “MIT-pthreads Notes”](#).

It is also possible to use another user level thread package named FSU Pthreads (see <http://moss.csc.ncsu.edu/~mueller/pthreads/>). This implementation is being used for the SCO port.

See the `thr_lock.c` and `thr_alarm.c` programs in the `mysys` directory for some tests/examples of these problems.

Both the server and the client need a working C++ compiler. We use `gcc` on many platforms. Other compilers that are known to work are SPARCworks, Sun Forte, Irix `cc`, HP-UX `aCC`, IBM AIX `x1C_r`, Intel `ecc/icc` and Compaq `cxx`.

### Important

If you are trying to build MySQL 5.1 with `icc` on the IA64 platform, and need support for MySQL Cluster, you should first ensure that you are using `icc` version 9.1.043 or later. (For details, see [Bug#21875](#).)

To compile only the client use `./configure --without-server`.

There is currently no support for only compiling the server, nor is it likely to be added unless someone has a good reason for it.

If you want/need to change any `Makefile` or the configure script you also need GNU Automake and Autoconf. See [Section 2.10.3, “Installing from the Development Source Tree”](#).

All steps needed to remake everything from the most basic files.

```
/bin/rm */.deps/*.P
/bin/rm -f config.cache
aclocal
autoheader
aclocal
automake
autoconf
./configure --with-debug=full --prefix='your installation directory'

# The makefiles generated above need GNU make 3.75 or newer.
# (called gmake below)
gmake clean all install init-db
```

If you run into problems with a new port, you may have to do some debugging of MySQL! See [Section 21.5.1, “Debugging a MySQL Server”](#).

### Note

Before you start debugging `mysqld`, first get the test programs `mysys/thr_alarm` and `mysys/thr_lock` to work. This ensures that your thread installation has even a remote chance to work!

## 21.5.1. Debugging a MySQL Server

If you are using some functionality that is very new in MySQL, you can try to run `mysqld` with the `--skip-new` (which disables all new, potentially unsafe functionality) or with `--safe-mode` which disables a lot of optimization that may cause problems. See [Section B.1.4.2, “What to Do If MySQL Keeps Crashing”](#).

If `mysqld` doesn't want to start, you should verify that you don't have any `my.cnf` files that interfere with your setup! You can check your `my.cnf` arguments with `mysqld --print-defaults` and avoid using them by starting with `mysqld --no-defaults ...`.

If `mysqld` starts to eat up CPU or memory or if it “hangs,” you can use `mysqladmin processlist status` to find out if someone is executing a query that takes a long time. It may be a good idea to run `mysqladmin -i10 processlist status` in some window if you are experiencing performance problems or problems when new clients can't connect.

The command `mysqladmin debug` dumps some information about locks in use, used memory and query usage to the MySQL log file. This may help solve some problems. This command also provides some useful information even if you haven't compiled MySQL for debugging!

If the problem is that some tables are getting slower and slower you should try to optimize the table with `OPTIMIZE TABLE` or `myisamchk`. See [Chapter 5, \*MySQL Server Administration\*](#). You should also check the slow queries with `EXPLAIN`.

You should also read the OS-specific section in this manual for problems that may be unique to your environment. See [Section 2.13, “Operating System-Specific Notes”](#).

### 21.5.1.1. Compiling MySQL for Debugging

If you have some very specific problem, you can always try to debug MySQL. To do this you must configure MySQL with the `--with-debug` or the `--with-debug=full` option. You can check whether MySQL was compiled with debugging by doing: `mysqld --help`. If the `--debug` flag is listed with the options then you have debugging enabled. `mysqladmin ver` also lists the `mysqld` version as `mysql ... --debug` in this case.

If you are using `gcc`, the recommended `configure` line is:

```
CC=gcc CFLAGS="-O2" CXX=gcc CXXFLAGS="-O2 -felide-constructors \
-fno-exceptions -fno-rtti" ./configure --prefix=/usr/local/mysql \
--with-debug --with-extra-charsets=complex
```

This avoids problems with the `libstdc++` library and with C++ exceptions (many compilers have problems with C++ exceptions in threaded code) and compile a MySQL version with support for all character sets.

If you suspect a memory overrun error, you can configure MySQL with `--with-debug=full`, which installs a memory allocation (`SAFEMALLOC`) checker. However, running with `SAFEMALLOC` is quite slow, so if you get performance problems you should start `mysqld` with the `--skip-safemalloc` option. This disables the memory overrun checks for each call to `malloc()` and `free()`.

If `mysqld` stops crashing when you compile it with `--with-debug`, you probably have found a compiler bug or a timing bug within MySQL. In this case, you can try to add `-g` to the `CFLAGS` and `CXXFLAGS` variables above and not use `--with-debug`. If `mysqld` dies, you can at least attach to it with `gdb` or use `gdb` on the core file to find out what happened.

When you configure MySQL for debugging you automatically enable a lot of extra safety check functions that monitor the health of `mysqld`. If they find something “unexpected,” an entry is written to `stderr`, which `mysqld_safe` directs to the error log! This also means that if you are having some unexpected problems with MySQL and are using a source distribution, the first thing you should do is to configure MySQL for debugging! (The second thing is to send mail to a MySQL mailing list and ask for help. See [Section 1.5.1, “MySQL Mailing Lists”](#). If you believe that you have found a bug, please use the instructions at [Section 1.6, “How to Report Bugs or Problems”](#)).

In the Windows MySQL distribution, `mysqld.exe` is by default compiled with support for trace files.

### 21.5.1.2. Creating Trace Files

If the `mysqld` server doesn't start or if you can cause it to crash quickly, you can try to create a trace file to find the problem.

To do this, you must have a `mysqld` that has been compiled with debugging support. You can check this by executing `mysqld -V`. If the version number ends with `-debug`, it is compiled with support for trace files. (On Windows, the debugging server is named `mysqld-debug` rather than `mysqld` as of MySQL 4.1.)

Start the `mysqld` server with a trace log in `/tmp/mysqld.trace` on Unix or `C:\mysqld.trace` on Windows:

```
shell> mysqld --debug
```

On Windows, you should also use the `--standalone` flag to not start `mysqld` as a service. In a console window, use this command:

```
C:\> mysqld-debug --debug --standalone
```

After this, you can use the `mysql.exe` command-line tool in a second console window to reproduce the problem. You can stop the `mysqld` server with `mysqladmin shutdown`.

Note that the trace file become **very big!** If you want to generate a smaller trace file, you can use debugging options something like this:

```
mysqld --debug=d,info,error,query,general,where:0,/tmp/mysqld.trace
```

This only prints information with the most interesting tags to the trace file.

If you make a bug report about this, please only send the lines from the trace file to the appropriate mailing list where something seems to go wrong! If you can't locate the wrong place, you can ftp the trace file, together with a full bug report, to <ftp://ftp.mysql.com/pub/mysql/upload/> so that a MySQL developer can take a look at it.

The trace file is made with the **DBUG** package by Fred Fish. See [Section 21.5.3, "The DBUG Package"](#).

### 21.5.1.3. Using `pdb` to create a Windows crashdump

Starting with MySQL 5.1.12 the Program Database files (extension `pdb`) are included in the Noinstall distribution of MySQL. These files provide information for debugging your MySQL installation in the event of a problem.

The PDB file contains more detailed information about `mysqld` and other tools that enables more detailed trace and dump files to be created. You can use these with Dr Watson, `WinDbg` and Visual Studio to debug `mysqld`.

For more information on PDB files, see [Microsoft Knowledge Base Article 121366](#). For more information on the debugging options available, see [Debugging Tools for Windows](#).

Dr Watson is installed with all Windows distributions, but if you have installed Windows development tools, Dr Watson may have been replaced with `WinDbg`, the debugger included with Visual Studio, or the debugging tools provided with Borland or Delphi.

To generate a crash file using Dr Watson, follow these steps:

1. Start Dr Watson by running `drwtsn32.exe` interactively using the `-i` option:

```
C:\> drwtsn32 -i
```

2. Set the **LOG FILE PATH** to the directory where you want to store trace files.
3. Make sure **DUMP ALL THREAD CONTEXTS** and **APPEND TO EXISTING LOG FILE**.
4. Uncheck **DUMP SYMBOL TABLE**, **VISUAL NOTIFICATION**, **SOUND NOTIFICATION** and **CREATE CRASH DUMP FILE**.
5. Set the **NUMBER OF INSTRUCTIONS** to a suitable value to capture enough calls in the stacktrace. A value of at 25 should be enough.

Note that the file generated can be very large.

### 21.5.1.4. Debugging `mysqld` under `gdb`

On most systems you can also start `mysqld` from `gdb` to get more information if `mysqld` crashes.

With some older `gdb` versions on Linux you must use `run --one-thread` if you want to be able to debug `mysqld` threads. In this case, you can only have one thread active at a time. We recommend you to upgrade to `gdb 5.1` ASAP as thread debugging works much better with this version!

NPTL threads (the new thread library on Linux) may cause problems while running `mysqld` under `gdb`. Some symptoms are:

- `mysqld` hangs during startup (before it writes `ready for connections`).
- `mysqld` crashes during a `pthread_mutex_lock()` or `pthread_mutex_unlock()` call.

In this case, you should set the following environment variable in the shell before starting `gdb`:

```
LD_ASSUME_KERNEL=2.4.1
export LD_ASSUME_KERNEL
```

When running `mysqld` under `gdb`, you should disable the stack trace with `--skip-stack-trace` to be able to catch segfaults within `gdb`.

In MySQL 4.0.14 and above you should use the `--gdb` option to `mysqld`. This installs an interrupt handler for `SIGINT` (needed to stop `mysqld` with `^C` to set breakpoints) and disable stack tracing and core file handling.

It is very hard to debug MySQL under `gdb` if you do a lot of new connections the whole time as `gdb` doesn't free the memory for old threads. You can avoid this problem by starting `mysqld` with `thread_cache_size` set to a value equal to `max_connections + 1`. In most cases just using `--thread_cache_size=5` helps a lot!

If you want to get a core dump on Linux if `mysqld` dies with a `SIGSEGV` signal, you can start `mysqld` with the `--core-file` option. This core file can be used to make a backtrace that may help you find out why `mysqld` died:

```
shell> gdb mysqld core
gdb> backtrace full
gdb> quit
```

See [Section B.1.4.2, “What to Do If MySQL Keeps Crashing”](#).

If you are using `gdb` 4.17.x or above on Linux, you should install a `.gdb` file, with the following information, in your current directory:

```
set print sevenbit off
handle SIGUSR1 nostop noprint
handle SIGUSR2 nostop noprint
handle SIGWAITING nostop noprint
handle SIGLWP nostop noprint
handle SIGPIPE nostop
handle SIGALRM nostop
handle SIGHUP nostop
handle SIGTERM nostop noprint
```

If you have problems debugging threads with `gdb`, you should download `gdb` 5.x and try this instead. The new `gdb` version has very improved thread handling!

Here is an example how to debug `mysqld`:

```
shell> gdb /usr/local/libexec/mysqld
gdb> run
...
backtrace full # Do this when mysqld crashes
```

Include the above output in a bug report, which you can file using the instructions in [Section 1.6, “How to Report Bugs or Problems”](#).

If `mysqld` hangs you can try to use some system tools like `strace` or `/usr/proc/bin/pstack` to examine where `mysqld` has hung.

```
strace /tmp/log libexec/mysqld
```

If you are using the Perl `DBI` interface, you can turn on debugging information by using the `trace` method or by setting the `DBI_TRACE` environment variable.

### 21.5.1.5. Using a Stack Trace

On some operating systems, the error log contains a stack trace if `mysqld` dies unexpectedly. You can use this to find out where (and maybe why) `mysqld` died. See [Section 5.2.2, “The Error Log”](#). To get a stack trace, you must not compile `mysqld` with the `-fomit-frame-pointer` option to `gcc`. See [Section 21.5.1.1, “Compiling MySQL for Debugging”](#).

A stack trace in the error log looks something like this:

```
mysqld got signal 11;
Attempting backtrace. You can use the following information
to find out where mysqld died. If you see no messages after
this, something went terribly wrong...

stack_bottom = 0x41fd0110 thread_stack 0x40000
mysqld(my_print_stacktrace+0x32)[0x9da402]
mysqld(handle_segfault+0x28a)[0x6648e9]
/lib/libpthread.so.0[0x7f1a5af000f0]
/lib/libc.so.6(strcmp+0x2)[0x7f1a5a10f0f2]
mysqld(_Z21check_change_passwordP3THDPKcS2_Pcj+0x7c)[0x7412cb]
mysqld(_ZN16set_var_password5checkEP3THD+0xd0)[0x688354]
mysqld(_Z17sql_set_variablesP3THDP4ListI12set_var_baseE+0x68)[0x688494]
mysqld(_Z21mysql_execute_commandP3THD+0x41a0)[0x67a170]
mysqld(_Z11mysql_parseP3THDPKcjPS2_+0x282)[0x67f0ad]
mysqld(_Z16dispatch_command19enum_server_commandP3THDPcj+0xbb7)[0x67fdf8]
mysqld(_Z10do_commandP3THD+0x24d)[0x6811b6]
mysqld(handle_one_connection+0x11c)[0x66e05e]
```

If resolution of function names for the trace fails, the trace contains less information:

```
mysqld got signal 11;
Attempting backtrace. You can use the following information
to find out where mysqld died. If you see no messages after
this, something went terribly wrong...

stack_bottom = 0x41fd0110 thread_stack 0x40000
[0x9da402]
[0x6648e9]
[0x7f1a5af000f0]
[0x7f1a5a10f0f2]
[0x7412cb]
[0x688354]
[0x688494]
[0x67a170]
[0x67f0ad]
[0x67fdf8]
[0x6811b6]
[0x66e05e]
```

In the latter case, you can use the [resolve\\_stack\\_dump](#) utility to determine where `mysqld` died by using the following procedure:

1. Copy the numbers from the stack trace to a file, for example `mysqld.stack`. The numbers should not include the surrounding square brackets:

```
0x9da402
0x6648e9
0x7f1a5af000f0
0x7f1a5a10f0f2
0x7412cb
0x688354
0x688494
0x67a170
0x67f0ad
0x67fdf8
0x6811b6
0x66e05e
```

2. Make a symbol file for the `mysqld` server:

```
shell> nm -n libexec/mysqld > /tmp/mysqld.sym
```

If `mysqld` is not linked statically, use the following command instead:

```
shell> nm -D -n libexec/mysqld > /tmp/mysqld.sym
```

If you want to decode C++ symbols, use the `--demangle`, if available, to `nm`. If your version of `nm` does not have this option, you will need to use the `c++filt` command after the stack dump has been produced to demangle the C++ names.

3. Execute the following command:

```
shell> resolve_stack_dump -s /tmp/mysqld.sym -n mysqld.stack
```

If you were not able to include demangled C++ names in your symbol file, process the `resolve_stack_dump` output using `c++filt`:

```
shell> resolve_stack_dump -s /tmp/mysqld.sym -n mysqld.stack | c++filt
```



This prints out where `mysqld` died. If that does not help you find out why `mysqld` died, you should create a bug report and include the output from the preceding command with the bug report.

However, in most cases it does not help us to have just a stack trace to find the reason for the problem. To be able to locate the bug or provide a workaround, in most cases we need to know the statement that killed `mysqld` and preferably a test case so that we can repeat the problem! See [Section 1.6, “How to Report Bugs or Problems”](#).

### 21.5.1.6. Using Server Logs to Find Causes of Errors in `mysqld`

Note that before starting `mysqld` with the general query log enabled, you should check all your tables with `myisamchk`. See [Chapter 5, \*MySQL Server Administration\*](#).

If `mysqld` dies or hangs, you should start `mysqld` with the general query log enabled. See [Section 5.2.3, “The General Query Log”](#). When `mysqld` dies again, you can examine the end of the log file for the query that killed `mysqld`.

If you use the default general query log file, the log is stored in the database directory as `host_name.log`. In most cases it is the last query in the log file that killed `mysqld`, but if possible you should verify this by restarting `mysqld` and executing the found query from the `mysql` command-line tools. If this works, you should also test all complicated queries that didn't complete.

You can also try the command `EXPLAIN` on all `SELECT` statements that takes a long time to ensure that `mysqld` is using indexes properly. See [Section 12.3.2, “EXPLAIN Syntax”](#).

You can find the queries that take a long time to execute by starting `mysqld` with the slow query log enabled. See [Section 5.2.5, “The Slow Query Log”](#).

If you find the text `mysqld restarted` in the error log file (normally named `hostname.err`) you probably have found a query that causes `mysqld` to fail. If this happens, you should check all your tables with `myisamchk` (see [Chapter 5, \*MySQL Server Administration\*](#)), and test the queries in the MySQL log files to see whether one fails. If you find such a query, try first upgrading to the newest MySQL version. If this doesn't help and you can't find anything in the `mysql` mail archive, you should report the bug to a MySQL mailing list. The mailing lists are described at <http://lists.mysql.com/>, which also has links to online list archives.

If you have started `mysqld` with `--myisam-recover`, MySQL automatically checks and tries to repair `MyISAM` tables if they are marked as 'not closed properly' or 'crashed'. If this happens, MySQL writes an entry in the `hostname.err` file `'Warning: Checking table ...'` which is followed by `Warning: Repairing table` if the table needs to be repaired. If you get a lot of these errors, without `mysqld` having died unexpectedly just before, then something is wrong and needs to be investigated further. See [Section 5.1.2, “Server Command Options”](#).

It is not a good sign if `mysqld` did die unexpectedly, but in this case, you should not investigate the `Checking table...` messages, but instead try to find out why `mysqld` died.

### 21.5.1.7. Making a Test Case If You Experience Table Corruption

If you get corrupted tables or if `mysqld` always fails after some update commands, you can test whether this bug is reproducible by doing the following:

- Take down the MySQL daemon (with `mysqladmin shutdown`).
- Make a backup of the tables (to guard against the very unlikely case that the repair does something bad).
- Check all tables with `myisamchk -s database/*.MYI`. Repair any wrong tables with `myisamchk -r database/table.MYI`.
- Make a second backup of the tables.
- Remove (or move away) any old log files from the MySQL data directory if you need more space.
- Start `mysqld` with the binary log enabled. If you want to find a query that crashes `mysqld`, you should start the server with both the general query log enabled as well. See [Section 5.2.3, “The General Query Log”](#), and [Section 5.2.4, “The Binary Log”](#).
- When you have gotten a crashed table, stop the `mysqld server`.
- Restore the backup.
- Restart the `mysqld` server **without** the binary log enabled.
- Re-execute the commands with `mysqlbinlog binary-log-file | mysql`. The binary log is saved in the MySQL database directory with the name `hostname-bin.NNNNNN`.



- If the tables are corrupted again or you can get `mysqld` to die with the above command, you have found reproducible bug that should be easy to fix! FTP the tables and the binary log to <ftp://ftp.mysql.com/pub/mysql/upload/> and report it in our bugs database using the instructions given in Section 1.6, “How to Report Bugs or Problems”. (Please note that the `/pub/mysql/upload/` FTP directory is not listable, so you'll not see what you've uploaded in your FTP client.) If you are a support customer, you can use the MySQL Customer Support Center <https://support.mysql.com/> to alert the MySQL team about the problem and have it fixed as soon as possible.

You can also use the script `mysql_find_rows` to just execute some of the update statements if you want to narrow down the problem.

## 21.5.2. Debugging a MySQL Client

To be able to debug a MySQL client with the integrated debug package, you should configure MySQL with `--with-debug` or `--with-debug=full`. See Section 2.10.2, “Typical configure Options”.

Before running a client, you should set the `MYSQL_DEBUG` environment variable:

```
shell> MYSQL_DEBUG=d:t:O,/tmp/client.trace
shell> export MYSQL_DEBUG
```

This causes clients to generate a trace file in `/tmp/client.trace`.

If you have problems with your own client code, you should attempt to connect to the server and run your query using a client that is known to work. Do this by running `mysql` in debugging mode (assuming that you have compiled MySQL with debugging on):

```
shell> mysql --debug=d:t:O,/tmp/client.trace
```

This provides useful information in case you mail a bug report. See Section 1.6, “How to Report Bugs or Problems”.

If your client crashes at some 'legal' looking code, you should check that your `mysql.h` include file matches your MySQL library file. A very common mistake is to use an old `mysql.h` file from an old MySQL installation with new MySQL library.

## 21.5.3. The DBUG Package

The MySQL server and most MySQL clients are compiled with the DBUG package originally created by Fred Fish. When you have configured MySQL for debugging, this package makes it possible to get a trace file of what the program is debugging. See Section 21.5.1.2, “Creating Trace Files”.

This section summarizes the argument values that you can specify in debug options on the command line for MySQL programs that have been built with debugging support. For more information about programming with the DBUG package, see the DBUG manual in the `dbug` directory of MySQL source distributions. It is best to use a recent distribution to get the most updated DBUG manual.

You use the debug package by invoking a program with the `--debug="..."` or the `-#...` option.

Most MySQL programs have a default debug string that is used if you don't specify an option to `--debug`. The default trace file is usually `/tmp/program_name.trace` on Unix and `\program_name.trace` on Windows.

The debug control string is a sequence of colon-separated fields as follows:

```
<field_1>:<field_2>:...:<field_N>
```

Each field consists of a mandatory flag character followed by an optional “,” and comma-separated list of modifiers:

```
flag[,modifier,modifier,...,modifier]
```

The following table shows the currently recognized flag characters.

Flag	Description
d	Enable output from DBUG_<N> macros for the current state. May be followed by a list of keywords which selects output only for the DBUG macros with that keyword. An empty list of keywords implies output for all macros.
D	Delay after each debugger output line. The argument is the number of tenths of seconds to delay, subject to machine capabilities. For example, <code>-#D, 20</code> specifies a delay of two seconds.
f	Limit debugging, tracing, and profiling to the list of named functions. Note that a null list disables all functions. The appropriate <code>d</code> or <code>t</code> flags must still be given; this flag only limits their actions if they are enabled.
F	Identify the source file name for each line of debug or trace output.

<b>i</b>	Identify the process with the PID or thread ID for each line of debug or trace output.
<b>g</b>	Enable profiling. Create a file called <code>dbugmon.out</code> containing information that can be used to profile the program. May be followed by a list of keywords that select profiling only for the functions in that list. A null list implies that all functions are considered.
<b>L</b>	Identify the source file line number for each line of debug or trace output.
<b>n</b>	Print the current function nesting depth for each line of debug or trace output.
<b>N</b>	Number each line of debug output.
<b>o</b>	Redirect the debugger output stream to the specified file. The default output is <code>stderr</code> .
<b>O</b>	Like <code>o</code> , but the file is really flushed between each write. When needed, the file is closed and reopened between each write.
<b>p</b>	Limit debugger actions to specified processes. A process must be identified with the <code>DEBUG_PROCESS</code> macro and match one in the list for debugger actions to occur.
<b>P</b>	Print the current process name for each line of debug or trace output.
<b>r</b>	When pushing a new state, do not inherit the previous state's function nesting level. Useful when the output is to start at the left margin.
<b>S</b>	Do function <code>_sanity(_file_, _line_)</code> at each debugged function until <code>_sanity()</code> returns something that differs from 0. (Mostly used with <code>safemalloc</code> to find memory leaks)
<b>t</b>	Enable function call/exit trace lines. May be followed by a list (containing only one modifier) giving a numeric maximum trace level, beyond which no output occurs for either debugging or tracing macros. The default is a compile time option.

Some examples of debug control strings that might appear on a shell command line (the `-#` is typically used to introduce a control string to an application program) are:

```
-#d:t
-#d:f,main,subr1:F:L:t,20
-#d,input,output,files:n
-#d:t:i:0,\\mysqld.trace
```

In MySQL, common tags to print (with the `d` option) are `enter`, `exit`, `error`, `warning`, `info`, and `loop`.

## 21.5.4. Comments about RTS Threads

I have tried to use the RTS thread packages with MySQL but stumbled on the following problems:

They use old versions of many POSIX calls and it is very tedious to make wrappers for all functions. I am inclined to think that it would be easier to change the thread libraries to the newest POSIX specification.

Some wrappers are currently written. See `mysys/my_pthread.c` for more info.

At least the following should be changed:

`pthread_get_specific` should use one argument. `sigwait` should take two arguments. A lot of functions (at least `pthread_cond_wait`, `pthread_cond_timedwait()`) should return the error code on error. Now they return `-1` and set `errno`.

Another problem is that user-level threads use the `ALRM` signal and this aborts a lot of functions (`read`, `write`, `open`...). MySQL should do a retry on interrupt on all of these but it is not that easy to verify it.

The biggest unsolved problem is the following:

To get thread-level alarms I changed `mysys/thr_alarm.c` to wait between alarms with `pthread_cond_timedwait()`, but this aborts with error `EINTR`. I tried to debug the thread library as to why this happens, but couldn't find any easy solution.

If someone wants to try MySQL with RTS threads I suggest the following:

- Change functions MySQL uses from the thread library to POSIX. This shouldn't take that long.
- Compile all libraries with the `-DHAVE_rts_threads`.
- Compile `thr_alarm`.
- If there are some small differences in the implementation, they may be fixed by changing `my_pthread.h` and `my_pthread.c`.

- Run `thr_alarm`. If it runs without any “warning,” “error,” or aborted messages, you are on the right track. Here is a successful run on Solaris:

```

Main thread: 1
Thread 0 (5) started
Thread: 5 Waiting
process_alarm
Thread 1 (6) started
Thread: 6 Waiting
process_alarm
process_alarm
thread_alarm
Thread: 6 Slept for 1 (1) sec
Thread: 6 Waiting
process_alarm
process_alarm
thread_alarm
Thread: 6 Slept for 2 (2) sec
Thread: 6 Simulation of no alarm needed
Thread: 6 Slept for 0 (3) sec
Thread: 6 Waiting
process_alarm
process_alarm
thread_alarm
Thread: 6 Slept for 4 (4) sec
Thread: 6 Waiting
process_alarm
thread_alarm
Thread: 5 Slept for 10 (10) sec
Thread: 5 Waiting
process_alarm
process_alarm
thread_alarm
Thread: 6 Slept for 5 (5) sec
Thread: 6 Waiting
process_alarm
process_alarm
...
thread_alarm
Thread: 5 Slept for 0 (1) sec
end

```

## 21.5.5. Differences Between Thread Packages

MySQL is very dependent on the thread package used. So when choosing a good platform for MySQL, the thread package is very important.

There are at least three types of thread packages:

- User threads in a single process. Thread switching is managed with alarms and the threads library manages all non-thread-safe functions with locks. Read, write and select operations are usually managed with a thread-specific select that switches to another thread if the running threads have to wait for data. If the user thread packages are integrated in the standard libs (FreeBSD and BSDI threads) the thread package requires less overhead than thread packages that have to map all unsafe calls (MIT-pthreads, FSU Pthreads and RTS threads). In some environments (for example, SCO), all system calls are thread-safe so the mapping can be done very easily (FSU Pthreads on SCO). Downside: All mapped calls take a little time and it is quite tricky to be able to handle all situations. There are usually also some system calls that are not handled by the thread package (like MIT-pthreads and sockets). Thread scheduling isn't always optimal.
- User threads in separate processes. Thread switching is done by the kernel and all data are shared between threads. The thread package manages the standard thread calls to allow sharing data between threads. LinuxThreads is using this method. Downside: Lots of processes. Thread creating is slow. If one thread dies the rest are usually left hanging and you must kill them all before restarting. Thread switching is somewhat expensive.
- Kernel threads. Thread switching is handled by the thread library or the kernel and is very fast. Everything is done in one process, but on some systems, `ps` may show the different threads. If one thread aborts, the whole process aborts. Most system calls are thread-safe and should require very little overhead. Solaris, HP-UX, AIX and OSF/1 have kernel threads.

In some systems kernel threads are managed by integrating user level threads in the system libraries. In such cases, the thread switching can only be done by the thread library and the kernel isn't really “thread aware.”

---

# Appendix A. MySQL 5.1 Frequently Asked Questions

## A.1. MySQL 5.1 FAQ — General

### Questions

- [22.1.1](#): Which version of MySQL is production-ready (GA)?
- [22.1.2](#): Can MySQL 5.1 do subqueries?
- [22.1.3](#): Can MySQL 5.1 perform multiple-table inserts, updates, and deletes?
- [22.1.4](#): Does MySQL 5.1 have a Query Cache? Does it work on Server, Instance or Database?
- [22.1.5](#): Does MySQL 5.1 have Sequences?
- [22.1.6](#): Does MySQL 5.1 have a `NOW( )` function with fractions of seconds?
- [22.1.7](#): Does MySQL 5.1 work with multi-core processors?
- [22.1.8](#): Is there a hot backup tool for MyISAM like InnoDB Hot Backup?
- [22.1.9](#): Have there been there any improvements in error reporting when foreign keys fail? Does MySQL now report which column and reference failed?
- [22.1.10](#): Can MySQL 5.1 perform ACID transactions?

### Questions and Answers

#### 22.1.1: Which version of MySQL is production-ready (GA)?

Currently, both MySQL 5.0 and MySQL 5.1 are supported for production use.

MySQL 5.0 achieved General Availability (GA) status with MySQL 5.0.15, which was released for production use on 19 October 2005.

MySQL 5.1 achieved General Availability (GA) status with MySQL 5.1.30, which was released for production use on 14 November 2008.

Development work on MySQL 5.4 has started; currently, MySQL 5.4 is in beta status.

Development work on MySQL 6.0 has started; currently, MySQL 6.0 is in alpha status.

#### 22.1.2: Can MySQL 5.1 do subqueries?

Yes. See [Section 12.2.9](#), “Subquery Syntax”.

#### 22.1.3: Can MySQL 5.1 perform multiple-table inserts, updates, and deletes?

Yes. For the syntax required to perform multiple-table updates, see [Section 12.2.11](#), “UPDATE Syntax”; for that required to perform multiple-table deletes, see [Section 12.2.2](#), “DELETE Syntax”.

A multiple-table insert can be accomplished using a trigger whose `FOR EACH ROW` clause contains multiple `INSERT` statements within a `BEGIN . . . END` block. See [Section 18.3](#), “Using Triggers”.

#### 22.1.4: Does MySQL 5.1 have a Query Cache? Does it work on Server, Instance or Database?

Yes. The query cache operates on the server level, caching complete result sets matched with the original query string. If an exactly identical query is made (which often happens, particularly in web applications), no parsing or execution is necessary; the result is sent directly from the cache. Various tuning options are available. See [Section 7.5.5](#), “The MySQL Query Cache”.

#### 22.1.5: Does MySQL 5.1 have Sequences?

No. However, MySQL has an `AUTO_INCREMENT` system, which in MySQL 5.1 can also handle inserts in a multi-master replication setup. With the `auto_increment_increment` and `auto_increment_offset` system variables, you can set each server to generate auto-increment values that don't conflict with other servers. The `auto_increment_increment` value should be greater than the number of servers, and each server should have a unique offset.

**22.1.6: Does MySQL 5.1 have a `NOW()` function with fractions of seconds?**

No. This is on the MySQL roadmap as a “rolling feature”. This means that it is not a flagship feature, but will be implemented, development time permitting. Specific customer demand may change this scheduling.

However, MySQL does parse time strings with a fractional component. See [Section 10.3.2, “The `TIME` Type”](#).

**22.1.7: Does MySQL 5.1 work with multi-core processors?**

Yes. MySQL is fully multi-threaded, and will make use of multiple CPUs, provided that the operating system supports them.

**22.1.8: Is there a hot backup tool for MyISAM like InnoDB Hot Backup?**

This is currently under development for a future MySQL release.

**22.1.9: Have there been any improvements in error reporting when foreign keys fail? Does MySQL now report which column and reference failed?**

The foreign key support in [InnoDB](#) has seen improvements in each major version of MySQL. Foreign key support generic to all storage engines is scheduled for MySQL 6.x; this should resolve any inadequacies in the current storage engine specific implementation.

**22.1.10: Can MySQL 5.1 perform ACID transactions?**

Yes. All current MySQL versions support transactions. The [InnoDB](#) storage engine offers full ACID transactions with row-level locking, multi-versioning, non-locking repeatable reads, and all four SQL standard isolation levels.

The [NDB](#) storage engine supports the [READ COMMITTED](#) transaction isolation level only.

## A.2. MySQL 5.1 FAQ — Storage Engines

### Questions

- [22.2.1](#): Where can I obtain complete documentation for MySQL storage engines and the pluggable storage engine architecture?
- [22.2.2](#): Are there any new storage engines in MySQL 5.1?
- [22.2.3](#): Have any storage engines been removed in MySQL 5.1?
- [22.2.4](#): What are the unique benefits of the [ARCHIVE](#) storage engine?
- [22.2.5](#): Do the new features in MySQL 5.1 apply to all storage engines?

### Questions and Answers

**22.2.1: Where can I obtain complete documentation for MySQL storage engines and the pluggable storage engine architecture?**

See [Chapter 13, \*Storage Engines\*](#). That chapter contains information about all MySQL storage engines except for the [NDB](#) storage engine used for MySQL Cluster; [NDB](#) is covered in [MySQL Cluster NDB 6.X/7.X](#).

**MySQL Enterprise**

For expert advice about the storage engine(s) most suitable to your circumstances subscribe to the MySQL Enterprise Monitor. For more information, see <http://www.mysql.com/products/enterprise/advisors.html>.

**22.2.2: Are there any new storage engines in MySQL 5.1?**

Yes, the [IBMDB2I](#) storage engine is included in the IBM i5/OS (TAR packages) and IBM i5/OS (SAVF packages). Also, there have been significant improvements in existing storage engines, in particular for the [NDB](#) storage engine that forms the basis for MySQL Cluster.

The Falcon storage engine is available in MySQL 6.0. See [MySQL 6.0 Reference Manual](#).

**22.2.3: Have any storage engines been removed in MySQL 5.1?**

Yes. MySQL 5.1 no longer supports the [BDB](#) storage engine. Any existing [BDB](#) tables should be converted to another storage engine before upgrading to MySQL 5.1.

**22.2.4: What are the unique benefits of the [ARCHIVE](#) storage engine?**

The [ARCHIVE](#) storage engine is ideally suited for storing large amounts of data without indexes; it has a very small footprint, and performs selects using table scans. See [Section 13.11](#), “[The ARCHIVE Storage Engine](#)”, for details.

#### **22.2.5: Do the new features in MySQL 5.1 apply to all storage engines?**

The general new features such as views, stored procedures, triggers, [INFORMATION\\_SCHEMA](#), precision math ([DECIMAL](#) column type), and the [BIT](#) column type, apply to all storage engines. There are also additions and changes for specific storage engines.

## **A.3. MySQL 5.1 FAQ — Server SQL Mode**

### **Questions**

- [22.3.1](#): What are server SQL modes?
- [22.3.2](#): How many server SQL modes are there?
- [22.3.3](#): How do you determine the server SQL mode?
- [22.3.4](#): Is the mode dependent on the database or connection?
- [22.3.5](#): Can the rules for strict mode be extended?
- [22.3.6](#): Does strict mode impact performance?
- [22.3.7](#): What is the default server SQL mode when My SQL 5.1 is installed?

### **Questions and Answers**

#### **22.3.1: What are server SQL modes?**

Server SQL modes define what SQL syntax MySQL should support and what kind of data validation checks it should perform. This makes it easier to use MySQL in different environments and to use MySQL together with other database servers. The MySQL Server apply these modes individually to different clients. For more information, see [Section 5.1.7](#), “[Server SQL Modes](#)”.

#### **22.3.2: How many server SQL modes are there?**

Each mode can be independently switched on and off. See [Section 5.1.7](#), “[Server SQL Modes](#)”, for a complete list of available modes.

#### **22.3.3: How do you determine the server SQL mode?**

You can set the default SQL mode (for `mysqld` startup) with the `--sql-mode` option. Using the statement `SET [GLOBAL|SESSION] sql_mode='modes'`, you can change the settings from within a connection, either locally to the connection, or to take effect globally. You can retrieve the current mode by issuing a `SELECT @@sql_mode` statement.

#### **22.3.4: Is the mode dependent on the database or connection?**

A mode is not linked to a particular database. Modes can be set locally to the session (connection), or globally for the server. you can change these settings using `SET [GLOBAL|SESSION] sql_mode='modes'`.

#### **22.3.5: Can the rules for strict mode be extended?**

When we refer to *strict mode*, we mean a mode where at least one of the modes [TRADITIONAL](#), [STRICT\\_TRANS\\_TABLES](#), or [STRICT\\_ALL\\_TABLES](#) is enabled. Options can be combined, so you can add additional restrictions to a mode. See [Section 5.1.7](#), “[Server SQL Modes](#)”, for more information.

#### **22.3.6: Does strict mode impact performance?**

The intensive validation of input data that some settings requires more time than if the validation is not done. While the performance impact is not that great, if you do not require such validation (perhaps your application already handles all of this), then MySQL gives you the option of leaving strict mode disabled. However — if you do require it — strict mode can provide such validation.

#### **22.3.7: What is the default server SQL mode when My SQL 5.1 is installed?**

By default, no special modes are enabled. See [Section 5.1.7](#), “[Server SQL Modes](#)”, for information about all available modes and MySQL's default behavior.

## A.4. MySQL 5.1 FAQ — Stored Procedures and Functions

### Questions

- [22.4.1](#): Does MySQL 5.1 support stored procedures and functions?
- [22.4.2](#): Where can I find documentation for MySQL stored procedures and stored functions?
- [22.4.3](#): Is there a discussion forum for MySQL stored procedures?
- [22.4.4](#): Where can I find the ANSI SQL 2003 specification for stored procedures?
- [22.4.5](#): How do you manage stored routines?
- [22.4.6](#): Is there a way to view all stored procedures and stored functions in a given database?
- [22.4.7](#): Where are stored procedures stored?
- [22.4.8](#): Is it possible to group stored procedures or stored functions into packages?
- [22.4.9](#): Can a stored procedure call another stored procedure?
- [22.4.10](#): Can a stored procedure call a trigger?
- [22.4.11](#): Can a stored procedure access tables?
- [22.4.12](#): Do stored procedures have a statement for raising application errors?
- [22.4.13](#): Do stored procedures provide exception handling?
- [22.4.14](#): Can MySQL 5.1 stored routines return result sets?
- [22.4.15](#): Is `WITH RECOMPILE` supported for stored procedures?
- [22.4.16](#): Is there a MySQL equivalent to using `mod_plsql` as a gateway on Apache to talk directly to a stored procedure in the database?
- [22.4.17](#): Can I pass an array as input to a stored procedure?
- [22.4.18](#): Can I pass a cursor as an `IN` parameter to a stored procedure?
- [22.4.19](#): Can I return a cursor as an `OUT` parameter from a stored procedure?
- [22.4.20](#): Can I print out a variable's value within a stored routine for debugging purposes?
- [22.4.21](#): Can I commit or roll back transactions inside a stored procedure?
- [22.4.22](#): Do MySQL 5.1 stored procedures and functions work with replication?
- [22.4.23](#): Are stored procedures and functions created on a master server replicated to a slave?
- [22.4.24](#): How are actions that take place inside stored procedures and functions replicated?
- [22.4.25](#): Are there special security requirements for using stored procedures and functions together with replication?
- [22.4.26](#): What limitations exist for replicating stored procedure and function actions?
- [22.4.27](#): Do the preceding limitations affect MySQL's ability to do point-in-time recovery?
- [22.4.28](#): What is being done to correct the aforementioned limitations?

### Questions and Answers

#### **22.4.1: Does MySQL 5.1 support stored procedures and functions?**

Yes. MySQL 5.1 supports two types of stored routines — stored procedures and stored functions.

#### **22.4.2: Where can I find documentation for MySQL stored procedures and stored functions?**

See [Section 18.2, “Using Stored Routines \(Procedures and Functions\)”](#).



**22.4.3: Is there a discussion forum for MySQL stored procedures?**

Yes. See <http://forums.mysql.com/list.php?98>.

**22.4.4: Where can I find the ANSI SQL 2003 specification for stored procedures?**

Unfortunately, the official specifications are not freely available (ANSI makes them available for purchase). However, there are books — such as *SQL-99 Complete, Really* by Peter Gulutzan and Trudy Pelzer — which give a comprehensive overview of the standard, including coverage of stored procedures.

**22.4.5: How do you manage stored routines?**

It is always good practice to use a clear naming scheme for your stored routines. You can manage stored procedures with `CREATE [FUNCTION|PROCEDURE]`, `ALTER [FUNCTION|PROCEDURE]`, `DROP [FUNCTION|PROCEDURE]`, and `SHOW CREATE [FUNCTION|PROCEDURE]`. You can obtain information about existing stored procedures using the `ROUTINES` table in the `INFORMATION_SCHEMA` database (see [Section 19.14](#), “The `INFORMATION_SCHEMA` `ROUTINES` Table”).

**22.4.6: Is there a way to view all stored procedures and stored functions in a given database?**

Yes. For a database named `dbname`, use this query on the `INFORMATION_SCHEMA.ROUTINES` table:

```
SELECT ROUTINE_TYPE, ROUTINE_NAME
FROM INFORMATION_SCHEMA.ROUTINES
WHERE ROUTINE_SCHEMA= 'dbname' ;
```

For more information, see [Section 19.14](#), “The `INFORMATION_SCHEMA` `ROUTINES` Table”.

The body of a stored routine can be viewed using `SHOW CREATE FUNCTION` (for a stored function) or `SHOW CREATE PROCEDURE` (for a stored procedure). See [Section 12.5.5.11](#), “`SHOW CREATE PROCEDURE` Syntax”, for more information.

**22.4.7: Where are stored procedures stored?**

In the `proc` table of the `mysql` system database. However, you should not access the tables in the system database directly. Instead, use `SHOW CREATE FUNCTION` to obtain information about stored functions, and `SHOW CREATE PROCEDURE` to obtain information about stored procedures. See [Section 12.5.5.11](#), “`SHOW CREATE PROCEDURE` Syntax”, for more information about these statements.

You can also query the `ROUTINES` table in the `INFORMATION_SCHEMA` database — see [Section 19.14](#), “The `INFORMATION_SCHEMA` `ROUTINES` Table”, for information about this table.

**22.4.8: Is it possible to group stored procedures or stored functions into packages?**

No. This is not supported in MySQL 5.1.

**22.4.9: Can a stored procedure call another stored procedure?**

Yes.

**22.4.10: Can a stored procedure call a trigger?**

A stored procedure can execute an SQL statement, such as an `UPDATE`, that causes a trigger to activate.

**22.4.11: Can a stored procedure access tables?**

Yes. A stored procedure can access one or more tables as required.

**22.4.12: Do stored procedures have a statement for raising application errors?**

Not in MySQL 5.1. The SQL standard `SIGNAL` and `RESIGNAL` statements are implemented in MySQL 6.0.

**22.4.13: Do stored procedures provide exception handling?**

MySQL implements `HANDLER` definitions according to the SQL standard. See [Section 12.8.4.2](#), “`DECLARE` for `Handlers`”, for details.

**22.4.14: Can MySQL 5.1 stored routines return result sets?**

*Stored procedures* can, but stored functions cannot. If you perform an ordinary `SELECT` inside a stored procedure, the result set is returned directly to the client. You need to use the MySQL 4.1 (or above) client-server protocol for this to work. This means that — for instance — in PHP, you need to use the `mysqli` extension rather than the old `mysql` extension.

**22.4.15: Is `WITH RECOMPILE` supported for stored procedures?**



Not in MySQL 5.1.

**22.4.16: Is there a MySQL equivalent to using `mod_plsql` as a gateway on Apache to talk directly to a stored procedure in the database?**

There is no equivalent in MySQL 5.1.

**22.4.17: Can I pass an array as input to a stored procedure?**

Not in MySQL 5.1.

**22.4.18: Can I pass a cursor as an `IN` parameter to a stored procedure?**

In MySQL 5.1, cursors are available inside stored procedures only.

**22.4.19: Can I return a cursor as an `OUT` parameter from a stored procedure?**

In MySQL 5.1, cursors are available inside stored procedures only. However, if you do not open a cursor on a `SELECT`, the result will be sent directly to the client. You can also `SELECT INTO` variables. See [Section 12.2.8, “SELECT Syntax”](#).

**22.4.20: Can I print out a variable's value within a stored routine for debugging purposes?**

Yes, you can do this in a *stored procedure*, but not in a stored function. If you perform an ordinary `SELECT` inside a stored procedure, the result set is returned directly to the client. You will need to use the MySQL 4.1 (or above) client-server protocol for this to work. This means that — for instance — in PHP, you need to use the `mysqli` extension rather than the old `mysql` extension.

**22.4.21: Can I commit or roll back transactions inside a stored procedure?**

Yes. However, you cannot perform transactional operations within a stored function.

**22.4.22: Do MySQL 5.1 stored procedures and functions work with replication?**

Yes, standard actions carried out in stored procedures and functions are replicated from a master MySQL server to a slave server. There are a few limitations that are described in detail in [Section 18.6, “Binary Logging of Stored Programs”](#).

**22.4.23: Are stored procedures and functions created on a master server replicated to a slave?**

Yes, creation of stored procedures and functions carried out through normal DDL statements on a master server are replicated to a slave, so the objects will exist on both servers. `ALTER` and `DROP` statements for stored procedures and functions are also replicated.

**22.4.24: How are actions that take place inside stored procedures and functions replicated?**

MySQL records each DML event that occurs in a stored procedure and replicates those individual actions to a slave server. The actual calls made to execute stored procedures are not replicated.

Stored functions that change data are logged as function invocations, not as the DML events that occur inside each function.

**22.4.25: Are there special security requirements for using stored procedures and functions together with replication?**

Yes. Because a slave server has authority to execute any statement read from a master's binary log, special security constraints exist for using stored functions with replication. If replication or binary logging in general (for the purpose of point-in-time recovery) is active, then MySQL DBAs have two security options open to them:

1. Any user wishing to create stored functions must be granted the `SUPER` privilege.
2. Alternatively, a DBA can set the `log_bin_trust_function_creators` system variable to 1, which enables anyone with the standard `CREATE ROUTINE` privilege to create stored functions.

**22.4.26: What limitations exist for replicating stored procedure and function actions?**

Non-deterministic (random) or time-based actions embedded in stored procedures may not replicate properly. By their very nature, randomly produced results are not predictable and cannot be exactly reproduced, and therefore, random actions replicated to a slave will not mirror those performed on a master. Note that declaring stored functions to be `DETERMINISTIC` or setting the `log_bin_trust_function_creators` system variable to 0 will not allow random-valued operations to be invoked.

In addition, time-based actions cannot be reproduced on a slave because the timing of such actions in a stored procedure is not reproducible through the binary log used for replication. It records only DML events and does not factor in timing constraints.

Finally, non-transactional tables for which errors occur during large DML actions (such as bulk inserts) may experience replication issues in that a master may be partially updated from DML activity, but no updates are done to the slave because of the errors that

occurred. A workaround is for a function's DML actions to be carried out with the `IGNORE` keyword so that updates on the master that cause errors are ignored and updates that do not cause errors are replicated to the slave.

#### **22.4.27: Do the preceding limitations affect MySQL's ability to do point-in-time recovery?**

The same limitations that affect replication do affect point-in-time recovery.

#### **22.4.28: What is being done to correct the aforementioned limitations?**

As of MySQL 5.1.5, you can choose either statement-based replication or row-based replication. The original replication implementation is based on statement-based binary logging. Row-based binary logging resolves the limitations mentioned earlier.

Beginning with MySQL 5.1.8, *mixed* replication is also available (by starting the server with `--binlog-format=mixed`). This hybrid, “smart” form of replication “knows” whether statement-level replication can safely be used, or row-level replication is required.

For additional information, see [Section 16.1.2, “Replication Formats”](#).

## **A.5. MySQL 5.1 FAQ — Triggers**

### **Questions**

- [22.5.1](#): Where can I find the documentation for MySQL 5.1 triggers?
- [22.5.2](#): Is there a discussion forum for MySQL Triggers?
- [22.5.3](#): Does MySQL 5.1 have statement-level or row-level triggers?
- [22.5.4](#): Are there any default triggers?
- [22.5.5](#): How are triggers managed in MySQL?
- [22.5.6](#): Is there a way to view all triggers in a given database?
- [22.5.7](#): Where are triggers stored?
- [22.5.8](#): Can a trigger call a stored procedure?
- [22.5.9](#): Can triggers access tables?
- [22.5.10](#): Can triggers call an external application through a UDF?
- [22.5.11](#): Is it possible for a trigger to update tables on a remote server?
- [22.5.12](#): Do triggers work with replication?
- [22.5.13](#): How are actions carried out through triggers on a master replicated to a slave?

### **Questions and Answers**

#### **22.5.1: Where can I find the documentation for MySQL 5.1 triggers?**

See [Section 18.3, “Using Triggers”](#).

#### **22.5.2: Is there a discussion forum for MySQL Triggers?**

Yes. It is available at <http://forums.mysql.com/list.php?99>.

#### **22.5.3: Does MySQL 5.1 have statement-level or row-level triggers?**

In MySQL 5.1, all triggers are `FOR EACH ROW` — that is, the trigger is activated for each row that is inserted, updated, or deleted. MySQL 5.1 does not support triggers using `FOR EACH STATEMENT`.

#### **22.5.4: Are there any default triggers?**

Not explicitly. MySQL does have specific special behavior for some `TIMESTAMP` columns, as well as for columns which are defined using `AUTO_INCREMENT`.

#### **22.5.5: How are triggers managed in MySQL?**

In MySQL 5.1, triggers can be created using the `CREATE TRIGGER` statement, and dropped using `DROP TRIGGER`. See [Section 12.1.19, “CREATE TRIGGER Syntax”](#), and [Section 12.1.30, “DROP TRIGGER Syntax”](#), for more about these statements.

Information about triggers can be obtained by querying the `INFORMATION_SCHEMA.TRIGGERS` table. See [Section 19.16, “The INFORMATION\\_SCHEMA TRIGGERS Table”](#).

#### 22.5.6: Is there a way to view all triggers in a given database?

Yes. You can obtain a listing of all triggers defined on database `dbname` using a query on the `INFORMATION_SCHEMA.TRIGGERS` table such as the one shown here:

```
SELECT TRIGGER_NAME, EVENT_MANIPULATION, EVENT_OBJECT_TABLE, ACTION_STATEMENT
FROM INFORMATION_SCHEMA.TRIGGERS
WHERE TRIGGER_SCHEMA='dbname';
```

For more information about this table, see [Section 19.16, “The INFORMATION\\_SCHEMA TRIGGERS Table”](#).

You can also use the `SHOW TRIGGERS` statement, which is specific to MySQL. See [Section 12.5.5.40, “SHOW TRIGGERS Syntax”](#).

#### 22.5.7: Where are triggers stored?

Triggers for a table are currently stored in `.TRG` files, with one such file one per table.

#### 22.5.8: Can a trigger call a stored procedure?

Yes.

#### 22.5.9: Can triggers access tables?

A trigger can access both old and new data in its own table. A trigger can also affect other tables, but it is not permitted to modify a table that is already being used (for reading or writing) by the statement that invoked the function or trigger.

#### 22.5.10: Can triggers call an external application through a UDF?

Yes. For example, a trigger could invoke the `sys_exec()` UDF available at MySQL Forge here: <http://forge.mysql.com/projects/project.php?id=211>

#### 22.5.11: Is it possible for a trigger to update tables on a remote server?

Yes. A table on a remote server could be updated using the `FEDERATED` storage engine. (See [Section 13.10, “The FEDERATED Storage Engine”](#)).

#### 22.5.12: Do triggers work with replication?

Yes. However, the way in which they work depends whether you are using MySQL's “classic” statement-based replication available in all versions of MySQL, or the row-based replication format introduced in MySQL 5.1.

When using statement-based replication, triggers on the slave are executed by statements that are executed on the master (and replicated to the slave).

When using row-based replication, triggers are not executed on the slave due to statements that were run on the master and then replicated to the slave. Instead, when using row-based replication, the changes caused by executing the trigger on the master are applied on the slave.

For more information, see [Section 16.3.1.26, “Replication and Triggers”](#).

#### 22.5.13: How are actions carried out through triggers on a master replicated to a slave?

Again, this depends on whether you are using statement-based or row-based replication.

**Statement-based replication.** First, the triggers that exist on a master must be re-created on the slave server. Once this is done, the replication flow works as any other standard DML statement that participates in replication. For example, consider a table `EMP` that has an `AFTER` insert trigger, which exists on a master MySQL server. The same `EMP` table and `AFTER` insert trigger exist on the slave server as well. The replication flow would be:

1. An `INSERT` statement is made to `EMP`.
2. The `AFTER` trigger on `EMP` activates.
3. The `INSERT` statement is written to the binary log.

4. The replication slave picks up the `INSERT` statement to `EMP` and executes it.
5. The `AFTER` trigger on `EMP` that exists on the slave activates.

**Row-based replication.** When you use row-based replication, the changes caused by executing the trigger on the master are applied on the slave. However, the triggers themselves are not actually executed on the slave under row-based replication. This is because, if both the master and the slave applied the changes from the master and — in addition — the trigger causing these changes were applied on the slave, the changes would in effect be applied twice on the slave, leading to different data on the master and the slave.

In most cases, the outcome is the same for both row-based and statement-based replication. However, if you use different triggers on the master and slave, you cannot use row-based replication. (This is because the row-based format replicates the changes made by triggers executing on the master to the slaves, rather than the statements that caused the triggers to execute, and the corresponding triggers on the slave are not executed.) Instead, any statements causing such triggers to be executed must be replicated using statement-based replication.

For more information, see [Section 16.3.1.26, “Replication and Triggers”](#).

## A.6. MySQL 5.1 FAQ — Views

### Questions

- [22.6.1](#): Where can I find documentation covering MySQL Views?
- [22.6.2](#): Is there a discussion forum for MySQL Views?
- [22.6.3](#): What happens to a view if an underlying table is dropped or renamed?
- [22.6.4](#): Does MySQL 5.1 have table snapshots?
- [22.6.5](#): Does MySQL 5.1 have materialized views?
- [22.6.6](#): Can you insert into views that are based on joins?

### Questions and Answers

#### 22.6.1: Where can I find documentation covering MySQL Views?

See [Section 18.5, “Using Views”](#).

#### 22.6.2: Is there a discussion forum for MySQL Views?

Yes. See <http://forums.mysql.com/list.php?100>

#### 22.6.3: What happens to a view if an underlying table is dropped or renamed?

After a view has been created, it is possible to drop or alter a table or view to which the definition refers. To check a view definition for problems of this kind, use the `CHECK TABLE` statement. (See [Section 12.5.2.3, “CHECK TABLE Syntax”](#).)

#### 22.6.4: Does MySQL 5.1 have table snapshots?

No.

#### 22.6.5: Does MySQL 5.1 have materialized views?

No.

#### 22.6.6: Can you insert into views that are based on joins?

It is possible, provided that your `INSERT` statement has a column list that makes it clear there is only one table involved.

You *cannot* insert into multiple tables with a single insert on a view.

## A.7. MySQL 5.0 FAQ — `INFORMATION_SCHEMA`

### Questions

---

- [22.7.1](#): Where can I find documentation for the MySQL `INFORMATION_SCHEMA` database?
- [22.7.2](#): Is there a discussion forum for `INFORMATION_SCHEMA`?
- [22.7.3](#): Where can I find the ANSI SQL 2003 specification for `INFORMATION_SCHEMA`?
- [22.7.4](#): What is the difference between the Oracle Data Dictionary and MySQL's `INFORMATION_SCHEMA`?
- [22.7.5](#): Can I add to or otherwise modify the tables found in the `INFORMATION_SCHEMA` database?

### Questions and Answers

#### 22.7.1: Where can I find documentation for the MySQL `INFORMATION_SCHEMA` database?

See [Chapter 19, `INFORMATION\_SCHEMA` Tables](#)

#### 22.7.2: Is there a discussion forum for `INFORMATION_SCHEMA`?

See <http://forums.mysql.com/list.php?101>.

#### 22.7.3: Where can I find the ANSI SQL 2003 specification for `INFORMATION_SCHEMA`?

Unfortunately, the official specifications are not freely available. (ANSI makes them available for purchase.) However, there are books available — such as *SQL-99 Complete, Really* by Peter Gulutzan and Trudy Pelzer — which give a comprehensive overview of the standard, including `INFORMATION_SCHEMA`.

#### 22.7.4: What is the difference between the Oracle Data Dictionary and MySQL's `INFORMATION_SCHEMA`?

Both Oracle and MySQL provide metadata in tables. However, Oracle and MySQL use different table names and column names. MySQL's implementation is more similar to those found in DB2 and SQL Server, which also support `INFORMATION_SCHEMA` as defined in the SQL standard.

#### 22.7.5: Can I add to or otherwise modify the tables found in the `INFORMATION_SCHEMA` database?

No. Since applications may rely on a certain standard structure, this should not be modified. For this reason, *we cannot support bugs or other issues which result from modifying `INFORMATION_SCHEMA` tables or data.*

## A.8. MySQL 5.1 FAQ — Migration

### Questions

- [22.8.1](#): Where can I find information on how to migrate from MySQL 5.0 to MySQL 5.1?
- [22.8.2](#): How has storage engine (table type) support changed in MySQL 5.1 from previous versions?

### Questions and Answers

#### 22.8.1: Where can I find information on how to migrate from MySQL 5.0 to MySQL 5.1?

For detailed upgrade information, see [Section 2.12.1, “Upgrading MySQL”](#). We recommend that you do not skip a major version when upgrading, but rather complete the process in steps, upgrading from one major version to the next in each step. This may seem more complicated, but it will you save time and trouble — if you encounter problems during the upgrade, their origin will be easier to identify, either by you or — if you have a MySQL Network subscription — by MySQL support.

#### 22.8.2: How has storage engine (table type) support changed in MySQL 5.1 from previous versions?

Storage engine support has changed as follows:

- Support for `ISAM` tables was removed in MySQL 5.0 and you should now use the `MyISAM` storage engine in place of `ISAM`. To convert a table `tblname` from `ISAM` to `MyISAM`, simply issue a statement such as this one:

```
ALTER TABLE tblname ENGINE=MYISAM;
```

- Internal `RAID` for `MyISAM` tables was also removed in MySQL 5.0. This was formerly used to allow large tables in file systems that did not support file sizes greater than 2GB. All modern file systems allow for larger tables; in addition, there are now other solutions such as `MERGE` tables and views.

- The `VARCHAR` column type now retains trailing spaces in all storage engines.
- `MEMORY` tables (formerly known as `HEAP` tables) can also contain `VARCHAR` columns.

## A.9. MySQL 5.1 FAQ — Security

### Questions

- [22.9.1](#): Where can I find documentation that addresses security issues for MySQL?
- [22.9.2](#): Does MySQL 5.1 have native support for SSL?
- [22.9.3](#): Is SSL support be built into MySQL binaries, or must I recompile the binary myself to enable it?
- [22.9.4](#): Does MySQL 5.1 have built-in authentication against LDAP directories?
- [22.9.5](#): Does MySQL 5.1 include support for Roles Based Access Control (RBAC)?

### Questions and Answers

#### 22.9.1: Where can I find documentation that addresses security issues for MySQL?

The best place to start is [Section 5.3, “General Security Issues”](#).

Other portions of the MySQL Documentation which you may find useful with regard to specific security concerns include the following:

- [Section 5.3.1, “General Security Guidelines”](#).
- [Section 5.3.2, “Making MySQL Secure Against Attackers”](#).
- [Section B.1.4.1, “How to Reset the Root Password”](#).
- [Section 5.3.5, “How to Run MySQL as a Normal User”](#).
- [Section 21.3.2.6, “User-Defined Function Security Precautions”](#).
- [Section 5.3.3, “Security-Related `mysqld` Options”](#).
- [Section 5.3.4, “Security Issues with `LOAD DATA LOCAL`”](#).
- [Section 2.11, “Post-Installation Setup and Testing”](#).
- [Section 2.13.1.11, “SELinux Notes”](#).
- [Section 5.5.7.1, “Basic SSL Concepts”](#).

#### MySQL Enterprise

The MySQL Enterprise Monitor enforces best practices for maximizing the security of your servers. For more information, see <http://www.mysql.com/products/enterprise/advisors.html>.

#### 22.9.2: Does MySQL 5.1 have native support for SSL?

Most 5.1 binaries have support for SSL connections between the client and server. We can't currently build with the new YaSSL library everywhere, as it is still quite new and does not compile on all platforms yet. See [Section 5.5.7, “Using SSL for Secure Connections”](#).

You can also tunnel a connection via SSH, if (for instance) if the client application doesn't support SSL connections. For an example, see [Section 5.5.8, “Connecting to MySQL Remotely from Windows with SSH”](#).

#### 22.9.3: Is SSL support be built into MySQL binaries, or must I recompile the binary myself to enable it?

Most 5.1 binaries have SSL enabled for client-server connections that are secured, authenticated, or both. However, the YaSSL library currently does not compile on all platforms. See [Section 5.5.7, “Using SSL for Secure Connections”](#), for a complete listing of supported and unsupported platforms.

**22.9.4: Does MySQL 5.1 have built-in authentication against LDAP directories?**

No. Support for external authentication methods is on the MySQL roadmap as a “rolling feature”, which means that we plan to implement it in the future, but we have not yet determined when this will be done.

**22.9.5: Does MySQL 5.1 include support for Roles Based Access Control (RBAC)?**

No. Support for roles is on the MySQL roadmap as a “rolling feature”, which means that we plan to implement it in the future, but we have not yet determined when this will be done.

## A.10. MySQL 5.1 FAQ — MySQL Cluster

In the following section, we answer questions that are frequently asked about MySQL Cluster and the `NDBCLUSTER` storage engine.

### Questions

- [22.10.1](#): Which versions of the MySQL software support Cluster? Do I have to compile from source?
- [22.10.2](#): What happened to MySQL Cluster NDB 6.4?
- [22.10.3](#): What do “NDB” and “NDBCLUSTER” mean?
- [22.10.4](#): What is the difference between using MySQL Cluster *vs* using MySQL replication?
- [22.10.5](#): Do I need to do any special networking to run MySQL Cluster? How do computers in a cluster communicate?
- [22.10.6](#): How many computers do I need to run a MySQL Cluster, and why?
- [22.10.7](#): What do the different computers do in a MySQL Cluster?
- [22.10.8](#): When I run the `SHOW` command in the MySQL Cluster management client, I see a line of output that looks like this:  

```
id=2 @10.100.10.32 (Version: 5.1.34-ndb-6.3.26, Nodegroup: 0, Master)
```

What is a “master node”, and what does it do? How do I configure a node so that it is the master?
- [22.10.9](#): With which operating systems can I use Cluster?
- [22.10.10](#): What are the hardware requirements for running MySQL Cluster?
- [22.10.11](#): How much RAM do I need to use MySQL Cluster? Is it possible to use disk memory at all?
- [22.10.12](#): What file systems can I use with MySQL Cluster? What about network file systems or network shares?
- [22.10.13](#): Can I run MySQL Cluster nodes inside virtual machines (such as those created by VirtualBox, VMWare, Parallels, or Xen)?
- [22.10.14](#): I am trying to populate a MySQL Cluster database. The loading process terminates prematurely and I get an error message like this one: `ERROR 1114: THE TABLE 'MY_CLUSTER_TABLE' IS FULL` Why is this happening?
- [22.10.15](#): MySQL Cluster uses TCP/IP. Does this mean that I can run it over the Internet, with one or more nodes in remote locations?
- [22.10.16](#): Do I have to learn a new programming or query language to use MySQL Cluster?
- [22.10.17](#): How do I find out what an error or warning message means when using MySQL Cluster?
- [22.10.18](#): Is MySQL Cluster transaction-safe? What isolation levels are supported?
- [22.10.19](#): What storage engines are supported by MySQL Cluster?
- [22.10.20](#): In the event of a catastrophic failure — say, for instance, the whole city loses power *and* my UPS fails — would I lose all my data?
- [22.10.21](#): Is it possible to use `FULLTEXT` indexes with MySQL Cluster?
- [22.10.22](#): Can I run multiple nodes on a single computer?
- [22.10.23](#): Can I add data nodes to a MySQL Cluster without restarting it?



- [22.10.24](#): Are there any limitations that I should be aware of when using MySQL Cluster?
- [22.10.25](#): How do I import an existing MySQL database into a MySQL Cluster?
- [22.10.26](#): How do cluster nodes communicate with one another?
- [22.10.27](#): What is an *arbiter*?
- [22.10.28](#): What data types are supported by MySQL Cluster?
- [22.10.29](#): How do I start and stop MySQL Cluster?
- [22.10.30](#): What happens to MySQL Cluster data when the cluster is shut down?
- [22.10.31](#): Is it a good idea to have more than one management node for a MySQL Cluster?
- [22.10.32](#): Can I mix different kinds of hardware and operating systems in one MySQL Cluster?
- [22.10.33](#): Can I run two data nodes on a single host? Two SQL nodes?
- [22.10.34](#): Can I use host names with MySQL Cluster?
- [22.10.35](#): Does MySQL Cluster support IPv6?
- [22.10.36](#): How do I handle MySQL users in a MySQL Cluster having multiple MySQL servers?
- [22.10.37](#): How do I continue to send queries in the event that one of the SQL nodes fails?

## Questions and Answers

### 22.10.1: Which versions of the MySQL software support Cluster? Do I have to compile from source?

Beginning with MySQL 5.1.24, MySQL Cluster is no longer supported in standard MySQL Server 5.1 releases. Instead, MySQL Cluster is now released as a separate product. Currently, two MySQL Cluster release series are available:

- **MySQL Cluster NDB 6.2.** This series is Generally Available (GA) and can be used in production. However, MySQL Cluster NDB 6.3 is also now available as GA, so you are encouraged to upgrade existing deployments and to use MySQL Cluster NDB 6.3 for new MySQL Cluster deployments. The latest MySQL Cluster NDB 6.2 sources and binaries can be obtained from <http://dev.mysql.com/downloads/cluster6.2.html>.
- **MySQL Cluster NDB 6.3.** This series is now Generally Available (GA) for use in production. The latest MySQL Cluster NDB 6.3 sources and binaries can be obtained from <http://dev.mysql.com/downloads/cluster>.
- **MySQL Cluster NDB 7.0.** This series is now in Beta development phase. It is not yet certified for use in production, but is available if you wish to preview and test new features. The latest MySQL Cluster NDB 7.0 sources can be obtained from <http://dev.mysql.com/downloads/cluster>.

We encourage you to use MySQL Cluster NDB 6.3 for new MySQL Cluster deployments, and to upgrade to this release series if you are using a previous version of MySQL with clustering support. For an overview of improvements in MySQL Cluster NDB 6.3, see [Features Added in MySQL Cluster NDB 6.3](#).

For information about new features and other improvements made in MySQL Cluster NDB 7.0, see [Features Added in MySQL Cluster NDB 7.0](#).

You can determine whether your MySQL Server has `NDBCLUSTER` support using either of the statements `SHOW VARIABLES LIKE 'have_%%'` or `SHOW ENGINES`.

### 22.10.2: What happened to MySQL Cluster NDB 6.4?

Because of the number and impact of new features introduced into MySQL Cluster following the General Availability of MySQL Cluster NDB 6.3, it was decided that the following release series represented a “major” new release series rather than a “minor” one, and should be known as MySQL Cluster 7.0.

The earliest development versions of MySQL Cluster NDB 7.0 were originally designated “MySQL Cluster 6.4”, and the first four releases in this series were identified as MySQL Cluster NDB 6.4.0 through NDB 6.4.3. MySQL Cluster NDB 7.0.4 is the fifth MySQL Cluster NDB 7.0 release; it is the successor to MySQL Cluster NDB 6.4.3.

For more information about MySQL Cluster NDB 7.0, see [Features Added in MySQL Cluster NDB 7.0](#), and [Changes in MySQL Cluster NDB 7.0](#).



**22.10.3: What do “NDB” and “NDBCLUSTER” mean?**

“NDB” stands for “Network Database”. `NDB` and `NDBCLUSTER` are both names for the storage engine that enables clustering support in MySQL. Either name is equally correct; both names appear in our documentation, and either name can be used in the `ENGINE` option of a `CREATE TABLE` statement for creating a MySQL Cluster table.

**22.10.4: What is the difference between using MySQL Cluster vs using MySQL replication?**

In traditional MySQL replication, a master MySQL server updates one or more slaves. Transactions are committed sequentially, and a slow transaction can cause the slave to lag behind the master. This means that if the master fails, it is possible that the slave might not have recorded the last few transactions. If a transaction-safe engine such as `InnoDB` is being used, a transaction will either be complete on the slave or not applied at all, but replication does not guarantee that all data on the master and the slave will be consistent at all times. In MySQL Cluster, all data nodes are kept in synchrony, and a transaction committed by any one data node is committed for all data nodes. In the event of a data node failure, all remaining data nodes remain in a consistent state.

In short, whereas standard MySQL replication is *asynchronous*, MySQL Cluster is *synchronous*.

We have implemented (asynchronous) replication for MySQL Cluster in MySQL 5.1 and MySQL Cluster NDB 6.x. *MySQL Cluster Replication* (also sometimes known as “geo-replication”) includes the capability to replicate both between two MySQL Clusters, and from a MySQL Cluster to a non-Cluster MySQL server. See [MySQL Cluster Replication](#), for more information.

**22.10.5: Do I need to do any special networking to run MySQL Cluster? How do computers in a cluster communicate?**

MySQL Cluster is intended to be used in a high-bandwidth environment, with computers connecting via TCP/IP. Its performance depends directly upon the connection speed between the cluster's computers. The minimum connectivity requirements for MySQL Cluster include a typical 100-megabit Ethernet network or the equivalent. We recommend you use gigabit Ethernet whenever available.

The faster SCI protocol is also supported, but requires special hardware. See [Using High-Speed Interconnects with MySQL Cluster](#), for more information about SCI.

**22.10.6: How many computers do I need to run a MySQL Cluster, and why?**

A minimum of three computers is required to run a viable cluster. However, the minimum **recommended** number of computers in a MySQL Cluster is four: one each to run the management and SQL nodes, and two computers to serve as data nodes. The purpose of the two data nodes is to provide redundancy; the management node must run on a separate machine to guarantee continued arbitration services in the event that one of the data nodes fails.

To provide increased throughput and high availability, you should use multiple SQL nodes (MySQL Servers connected to the cluster). It is also possible (although not strictly necessary) to run multiple management servers.

**22.10.7: What do the different computers do in a MySQL Cluster?**

A MySQL Cluster has both a physical and logical organization, with computers being the physical elements. The logical or functional elements of a cluster are referred to as *nodes*, and a computer housing a cluster node is sometimes referred to as a *cluster host*. There are three types of nodes, each corresponding to a specific role within the cluster. These are:

- **Management node.** This node provides management services for the cluster as a whole, including startup, shutdown, backups, and configuration data for the other nodes. The management node server is implemented as the application `ndb_mgmd`; the management client used to control MySQL Cluster is `ndb_mgm`.
- **Data node.** This type of node stores and replicates data. Data node functionality is handled by instances of the `NDB` data node process `ndbd`.
- **SQL node.** This is simply an instance of MySQL Server (`mysqld`) that is built with support for the `NDBCLUSTER` storage engine and started with the `--ndb-cluster` option to enable the engine and the `--ndb-connectstring` option to enable it to connect to a MySQL Cluster management server. For more about these options, see [mysqld Command Options for MySQL Cluster](#).

**Note**

An *API node* is any application that makes direct use of Cluster data nodes for data storage and retrieval. An SQL node can thus be considered a type of API node that uses a MySQL Server to provide an SQL interface to the Cluster. You can write such applications (that do not depend on a MySQL Server) using the NDB API, which supplies a direct, object-oriented transaction and scanning interface to MySQL Cluster data; see [The NDB API](#), for more information.

**22.10.8: When I run the `SHOW` command in the MySQL Cluster management client, I see a line of output that looks like this:**

```
id=2 @10.100.10.32 (Version: 5.1.34-ndb-6.3.26, Nodegroup: 0, Master)
```

### What is a “master node”, and what does it do? How do I configure a node so that it is the master?

The simplest answer is, “It's not something you can control, and it's nothing that you need to worry about in any case, unless you're a software engineer writing or analyzing the MySQL Cluster source code”.

If you don't find that answer satisfactory, here's a longer and more technical version:

A number of mechanisms in MySQL Cluster require distributed coordination among the data nodes. These distributed algorithms and protocols include global checkpointing, DDL (schema) changes, and node restart handling. To make this coordination simpler, the data nodes “elect” one of their number to be a “master”. There is no user-facing mechanism for influencing this selection, which is completely automatic; the fact that it *is* automatic is a key part of MySQL Cluster's internal architecture.

When a node acts as a master for any of these mechanisms, it is usually the point of coordination for the activity, and the other nodes act as “servants”, carrying out their parts of the activity as directed by the master. If the node acting as master fails, then the remaining nodes elect a new master. Tasks in progress that were being coordinated by the old master may either fail or be continued by the new master, depending on the actual mechanism involved.

It is possible for some of these different mechanisms and protocols to have different master nodes, but in general the same master is chosen for all of them. The node indicated as the master in the output of `SHOW` in the management client is actually the `DICT` master (see [The DBDICT Block](#), in the *MySQL Cluster API Developer Guide*, for more information), responsible for coordinating DDL and metadata activity.

MySQL Cluster is designed in such a way that the choice of master has no discernable effect outside the cluster itself. For example, the current master does not have significantly higher CPU or resource usage than the other data nodes, and failure of the master should not have a significantly different impact on the cluster than the failure of any other data node.

### 22.10.9: With which operating systems can I use Cluster?

MySQL Cluster is supported on most Unix-like operating systems, including Linux, Mac OS X, Solaris, and HP-UX. Beginning with MySQL Cluster NDB 6.4, it is also possible to run MySQL Cluster on Windows platforms. We are continuing to work on providing MySQL Cluster support for additional platforms; eventually we intend to offer MySQL Cluster on all platforms for which MySQL itself is supported.

For more detailed information concerning the level of support which is offered for MySQL Cluster on various operating system versions, OS distributions, and hardware platforms, please refer to <http://www.mysql.com/support/supportedplatforms/cluster.html>.

### 22.10.10: What are the hardware requirements for running MySQL Cluster?

MySQL Cluster should run on any platform for which `NDBCLUSTER`-enabled binaries are available. For data nodes, faster CPUs and more memory are likely to improve performance, and 64-bit CPUs are likely to be more effective than 32-bit processors. There must be sufficient memory on machines used for data nodes to hold each node's share of the database (see *How much RAM do I Need?* for more information). Nodes can communicate via a standard TCP/IP network and hardware. For SCI support, special networking hardware is required (see [Using High-Speed Interconnects with MySQL Cluster](#)).

### 22.10.11: How much RAM do I need to use MySQL Cluster? Is it possible to use disk memory at all?

In MySQL 5.0 and earlier, MySQL Cluster was in-memory only. This meant that all table data (including indexes) was stored in RAM. If your data took up 1 GB of space and you wanted to replicate it once in the cluster, you needed 2 GB of memory to do so (1 GB per replica). This was in addition to the memory required by the operating system and any applications running on the cluster computers. This is still true of in-memory tables.

If a data node's memory usage exceeds what is available in RAM, then the system will attempt to use swap space up to the limit set for `DataMemory`. However, this will at best result in severely degraded performance, and may cause the node to be dropped due to slow response time (missed heartbeats). We do not recommend on relying on disk swapping in a production environment for this reason. In any case, once the `DataMemory` limit is reached, any operations requiring additional memory (such as inserts) will fail.

`NDBCLUSTER` in MySQL Cluster NDB 6.x includes support for Disk Data, which helps to alleviate these issues. See [MySQL Cluster Disk Data Tables](#), for more information.

You can use the following formula for obtaining a rough estimate of how much RAM is needed for each data node in the cluster:

```
(SizeofDatabase × NumberOfReplicas × 1.1 ) / NumberOfDataNodes
```

To calculate the memory requirements more exactly requires determining, for each table in the cluster database, the storage space required per row (see [Section 10.5, “Data Type Storage Requirements”](#), for details), and multiplying this by the number of rows. You must also remember to account for any column indexes as follows:

- Each primary key or hash index created for an `NDBCLUSTER` table requires 21–25 bytes per record. These indexes use `In-`

[dexMemory](#).

- Each ordered index requires 10 bytes storage per record, using [DataMemory](#).
- Creating a primary key or unique index also creates an ordered index, unless this index is created with `USING HASH`. In other words:
  - A primary key or unique index on a Cluster table normally takes up 31 to 35 bytes per record.
  - However, if the primary key or unique index is created with `USING HASH`, then it requires only 21 to 25 bytes per record.

Note that creating MySQL Cluster tables with `USING HASH` for all primary keys and unique indexes will generally cause table updates to run more quickly — in some cases by as much as 20 to 30 percent faster than updates on tables where `USING HASH` was not used in creating primary and unique keys. This is due to the fact that less memory is required (because no ordered indexes are created), and that less CPU must be utilized (because fewer indexes must be read and possibly updated). However, it also means that queries that could otherwise use range scans must be satisfied by other means, which can result in slower selects.

When calculating Cluster memory requirements, you may find useful the `ndb_size.pl` utility which is available in recent MySQL 5.1 releases. This Perl script connects to a current (non-Cluster) MySQL database and creates a report on how much space that database would require if it used the `NDBCLUSTER` storage engine. For more information, see `ndb_size.pl`.

It is especially important to keep in mind that *every MySQL Cluster table must have a primary key*. The `NDB` storage engine creates a primary key automatically if none is defined, and this primary key is created without `USING HASH`.

To determine how much memory is being used for storage of Cluster indexes at any given time, you can check the Cluster log for the warnings which are written to it when 80% of available [DataMemory](#) or [IndexMemory](#) is in use, and again when use reaches 85%, 90%, and so on. Beginning with MySQL Cluster NDB 6.2.3 and 6.3.0, you can use the `REPORT MemoryUsage` command in the cluster management client to obtain a real-time report of the amount of memory used to store MySQL Cluster data and indexes. For more information about this command, see

#### **22.10.12: What file systems can I use with MySQL Cluster? What about network file systems or network shares?**

Generally, any file system that is native to the host operating system should work well with MySQL Cluster. If you find that a given file system works particularly well (or not so especially well) with MySQL Cluster, we invite you to discuss your findings in the [MySQL Cluster Forums](#).

For Windows, we recommend that you use `NTFS` file systems for MySQL Cluster, just as we do for standard MySQL. We do not test MySQL Cluster with `FAT` or `VFAT` file systems. Because of this, we do not recommend their use with MySQL or MySQL Cluster.

MySQL Cluster is implemented as a shared-nothing solution; the idea behind this is that the failure of a single piece of hardware should not cause the failure of multiple cluster nodes, or possibly even the failure of the cluster as a whole. For this reason, the use of network shares or network file systems is not supported for MySQL Cluster. This also applies to shared storage devices such as SANs.

#### **22.10.13: Can I run MySQL Cluster nodes inside virtual machines (such as those created by VirtualBox, VMWare, Parallels, or Xen)?**

This is possible but not recommended for a production environment.

We have found that running MySQL Cluster processes inside a virtual machine can give rise to issues with timing and disk subsystems that have a strong negative impact on the operation of the cluster. The behavior of the cluster is often unpredictable in these cases.

If an issue can be reproduced outside the virtual environment, then we may be able to provide assistance. Otherwise, we cannot support it at this time.

#### **22.10.14: I am trying to populate a MySQL Cluster database. The loading process terminates prematurely and I get an error message like this one: `ERROR 1114: THE TABLE 'MY_CLUSTER_TABLE' IS FULL` Why is this happening?**

The cause is very likely to be that your setup does not provide sufficient RAM for all table data and all indexes, *including the primary key required by the `NDB` storage engine and automatically created in the event that the table definition does not include the definition of a primary key*.

It is also worth noting that all data nodes should have the same amount of RAM, since no data node in a cluster can use more memory than the least amount available to any individual data node. For example, if there are four computers hosting Cluster data nodes, and three of these have 3GB of RAM available to store Cluster data while the remaining data node has only 1GB RAM, then each data node can devote at most 1GB to MySQL Cluster data and indexes.

#### **22.10.15: MySQL Cluster uses TCP/IP. Does this mean that I can run it over the Internet, with one or more nodes in remote**

**locations?**

It is *very* unlikely that a cluster would perform reliably under such conditions, as MySQL Cluster was designed and implemented with the assumption that it would be run under conditions guaranteeing dedicated high-speed connectivity such as that found in a LAN setting using 100 Mbps or gigabit Ethernet — preferably the latter. We neither test nor warrant its performance using anything slower than this.

In addition, it is *extremely* important to keep in mind that communications between the nodes in a MySQL Cluster are not secure; they are neither encrypted nor safeguarded by any other protective mechanism. The most secure configuration for a cluster is in a private network behind a firewall, with no direct access to any Cluster data or management nodes from outside. (For SQL nodes, you should take the same precautions as you would with any other instance of the MySQL server.) For more information, see [MySQL Cluster Security Issues](#).

**22.10.16: Do I have to learn a new programming or query language to use MySQL Cluster?**

No. Although some specialized commands are used to manage and configure the cluster itself, only standard (My)SQL queries and commands are required for the following operations:

- Creating, altering, and dropping tables (including Disk Data tables and related objects)
- Inserting, updating, and deleting table data
- Creating, changing, and dropping primary and unique indexes

Some specialized configuration parameters and files are required to set up a MySQL Cluster — see [MySQL Cluster Configuration Files](#), for information about these.

A few simple commands are used in the MySQL Cluster management client (`ndb_mgm`) for tasks such as starting and stopping cluster nodes. See [Commands in the MySQL Cluster Management Client](#).

**22.10.17: How do I find out what an error or warning message means when using MySQL Cluster?**

There are two ways in which this can be done:

- From within the `mysql` client, use `SHOW ERRORS` or `SHOW WARNINGS` immediately upon being notified of the error or warning condition. Errors and warnings also be displayed in MySQL Query Browser.
- From a system shell prompt, use `perror --ndb error_code`.

**22.10.18: Is MySQL Cluster transaction-safe? What isolation levels are supported?**

*Yes:* For tables created with the `NDBCLUSTER` storage engine, transactions are supported. Currently, MySQL Cluster supports only the `READ COMMITTED` transaction isolation level.

**22.10.19: What storage engines are supported by MySQL Cluster?**

Clustering with MySQL is supported only by the `NDBCLUSTER` storage engine (also called `NDB`). That is, in order for a table to be shared between nodes in a MySQL Cluster, the table must be created using `ENGINE=NDBCLUSTER` (or the equivalent option `ENGINE=NDB`).

It is possible to create tables using other storage engines (such as `MyISAM` or `InnoDB`) on a MySQL server being used with a MySQL Cluster, but these non-`NDBCLUSTER` tables do *not* participate in clustering; such a table is strictly local to the individual MySQL server instance on which it is created.

**22.10.20: In the event of a catastrophic failure — say, for instance, the whole city loses power and my UPS fails — would I lose all my data?**

All committed transactions are logged. Therefore, although it is possible that some data could be lost in the event of a catastrophe, this should be quite limited. Data loss can be further reduced by minimizing the number of operations per transaction. (It is not a good idea to perform large numbers of operations per transaction in any case.)

**22.10.21: Is it possible to use `FULLTEXT` indexes with MySQL Cluster?**

`FULLTEXT` indexing is not supported by any storage engine other than `MyISAM`. We are working to add this capability to MySQL Cluster tables in a future release.

**22.10.22: Can I run multiple nodes on a single computer?**

It is possible but not always advisable. One of the chief reasons to run a cluster is to provide redundancy. To obtain the full benefits of this redundancy, each node should reside on a separate machine. If you place multiple nodes on a single machine and that machine fails, you lose all of those nodes. For this reason, if you do run multiple data nodes on a single machine, it is *extremely* important that they be set up in such a way that the failure of this machine does not cause the loss of all the data nodes in a given node group.

Given that MySQL Cluster can be run on commodity hardware loaded with a low-cost (or even no-cost) operating system, the expense of an extra machine or two is well worth it to safeguard mission-critical data. It also worth noting that the requirements for a cluster host running a management node are minimal. This task can be accomplished with a 200 MHz Pentium CPU and sufficient RAM for the operating system plus a small amount of overhead for the `ndb_mgmd` and `ndb_mgm` processes.

It is acceptable to run multiple cluster data nodes on a single host that has multiple CPUs, cores, or both. Beginning with MySQL Cluster NDB 6.4, there is also a special multi-threaded version of the data node binary intended for use on such systems. For more information, see [ndbmt.d](#).

It is also possible in some cases to run data nodes and SQL nodes concurrently on the same machine; how well such an arrangement performs is dependent on a number of factors such as number of cores and CPUs as well as the amount of disk and memory available to the data node and SQL node processes, and you must take these factors into account when planning such a configuration.

#### **22.10.23: Can I add data nodes to a MySQL Cluster without restarting it?**

Beginning with MySQL Cluster NDB 6.4, it is possible to add new data nodes to a running MySQL Cluster without taking it offline. For more information, see [Adding MySQL Cluster Data Nodes Online](#).

For other types of MySQL Cluster nodes, a rolling restart is all that is required (see [Performing a Rolling Restart of a MySQL Cluster](#)).

In MySQL Cluster NDB 6.3 and earlier, it was not possible to add new data nodes without shutting down and restarting the MySQL Cluster.

#### **22.10.24: Are there any limitations that I should be aware of when using MySQL Cluster?**

Limitations on [NDB](#) tables in MySQL 5.1 (including MySQL Cluster NDB 6.x) include the following:

- Temporary tables are not supported; a `CREATE TEMPORARY TABLE` statement using `ENGINE=NDB` or `ENGINE=NDBCLUSTER` fails with an error.
- The only types of user-defined partitioning supported for `NDBCLUSTER` tables are `KEY` and `LINEAR KEY`. (Beginning with MySQL 5.1.12, attempting to create an `NDB` table using any other partitioning type fails with an error.)
- `FULLTEXT` indexes and index prefixes are not supported. Only complete columns may be indexed.
- Spatial indexes are not supported (although spatial columns can be used). See [Section 11.13, “Spatial Extensions”](#).
- Prior to MySQL Cluster NDB 6.3.19, the `NDBCLUSTER` storage engine did not support partial transactions or partial rollbacks of transactions. Beginning with MySQL Cluster NDB 6.3.19, this limitation has been removed, and the behavior of `NDBCLUSTER` is now in line with that of other transactional storage engines (such as `InnoDB`) that can roll back individual statements.
- The maximum number of attributes allowed per table is 128, and attribute names cannot be any longer than 31 characters. For each table, the maximum combined length of the table and database names is 122 characters.
- The maximum size for a table row is 8 kilobytes, not counting `BLOB` values. There is no set limit for the number of rows per table. Table size limits depend on a number of factors, in particular on the amount of RAM available to each data node.
- The `NDBCLUSTER` engine does not support foreign key constraints. As with `MyISAM` tables, if these are specified in a `CREATE TABLE` or `ALTER TABLE` statement, they are ignored.

For a complete listing of limitations in MySQL Cluster, see [Known Limitations of MySQL Cluster](#).

#### **22.10.25: How do I import an existing MySQL database into a MySQL Cluster?**

You can import databases into MySQL Cluster much as you would with any other version of MySQL. Other than the limitations mentioned elsewhere in this FAQ, the only other special requirement is that any tables to be included in the cluster must use the `NDB` storage engine. This means that the tables must be created with `ENGINE=NDB` or `ENGINE=NDBCLUSTER`.

It is also possible to convert existing tables using other storage engines to `NDBCLUSTER` using one or more `ALTER TABLE` statement. However, the definition of the table must be compatible with the `NDBCLUSTER` storage engine prior to making the conver-



sion.

See [Known Limitations of MySQL Cluster](#), for details.

#### 22.10.26: How do cluster nodes communicate with one another?

Cluster nodes can communicate via any of three different transport mechanisms: TCP/IP, SHM (shared memory), and SCI (Scalable Coherent Interface). Where available, SHM is used by default between nodes residing on the same cluster host; however, this is considered experimental. SCI is a high-speed (1 gigabit per second and higher), high-availability protocol used in building scalable multi-processor systems; it requires special hardware and drivers. See [Using High-Speed Interconnects with MySQL Cluster](#), for more about using SCI as a transport mechanism for MySQL Cluster.

#### 22.10.27: What is an *arbiter*?

If one or more nodes in a cluster fail, it is possible that not all cluster nodes will be able to “see” one another. In fact, it is possible that two sets of nodes might become isolated from one another in a network partitioning, also known as a “split brain” scenario. This type of situation is undesirable because each set of nodes tries to behave as though it is the entire cluster.

When cluster nodes go down, there are two possibilities. If more than 50% of the remaining nodes can communicate with each other, we have what is sometimes called a “majority rules” situation, and this set of nodes is considered to be the cluster. The arbiter comes into play when there is an even number of nodes: in such cases, the set of nodes to which the arbiter belongs is considered to be the cluster, and nodes not belonging to this set are shut down.

The preceding information is somewhat simplified. A more complete explanation taking into account node groups follows:

When all nodes in at least one node group are alive, network partitioning is not an issue, because no one portion of the cluster can form a functional cluster. The real problem arises when no single node group has all its nodes alive, in which case network partitioning (the “split-brain” scenario) becomes possible. Then an arbiter is required. All cluster nodes recognize the same node as the arbiter, which is normally the management server; however, it is possible to configure any of the MySQL Servers in the cluster to act as the arbiter instead. The arbiter accepts the first set of cluster nodes to contact it, and tells the remaining set to shut down. Arbiter selection is controlled by the `ArbitrationRank` configuration parameter for MySQL Server and management server nodes. (See [Defining a MySQL Cluster Management Server](#), for details.)

The role of arbiter does not in and of itself impose any heavy demands upon the host so designated, and thus the arbiter host does not need to be particularly fast or to have extra memory especially for this purpose.

#### 22.10.28: What data types are supported by MySQL Cluster?

MySQL Cluster NDB 6.x, supports all of the usual MySQL data types, including those associated with MySQL’s spatial extensions; however, the `NDBCLUSTER` storage engine does not support spatial indexes. (Spatial indexes are supported only by `MyISAM`; see [Section 11.13, “Spatial Extensions”](#), for more information.) In addition, there are some differences with regard to indexes when used with `NDBCLUSTER` tables.

##### Note

MySQL Cluster Disk Data tables (that is, tables created with `TABLESPACE ... STORAGE DISK ENGINE=NDBCLUSTER`) have only fixed-width rows. This means that (for example) each Disk Data table record containing a `VARCHAR(255)` column requires space for 255 characters (as required for the character set and collation being used for the table), regardless of the actual number of characters stored therein.

See [Known Limitations of MySQL Cluster](#), for more information about these issues.

#### 22.10.29: How do I start and stop MySQL Cluster?

It is necessary to start each node in the cluster separately, in the following order:

1. Start the management node, using the `ndb_mgmd` command.

You must include the `-f` or `--config-file` option to tell the management node where its configuration file can be found. Beginning with MySQL Cluster NDB 6.4, the management server must also know where it is to keep its configuration cache.

2. Start each data node with the `ndbd` command. (Beginning with MySQL Cluster NDB 6.4, the `ndbmt` command can be used on computers with multiple CPUs, multiple cores, or both.)

Each data node must be started with the `-c` or `--connect-string` option so that the data node knows how to connect to the management server.

3. Start each MySQL Server (SQL node) using your preferred startup script, such as `mysqld_safe`.

Each MySQL Server must be started with the `--ndbcluster` and `--ndb-connectstring` options. These options cause `mysqld` to enable `NDBCLUSTER` storage engine support and how to connect to the management server.

Each of these commands must be run from a system shell on the machine housing the affected node. (You do not have to be physically present at the machine — a remote login shell can be used for this purpose.) You can verify that the cluster is running by starting the NDB management client `ndb_mgm` on the machine housing the management node and issuing the `SHOW` or `ALL STATUS` command.

To shut down a running cluster, issue the command `SHUTDOWN` in the management client. Alternatively, you may enter the following command in a system shell:

```
shell> ndb_mgm -e "SHUTDOWN"
```

(The quotation marks are optional; in addition, the `SHUTDOWN` command is not case-sensitive.)

Either of these commands causes the `ndb_mgm`, `ndb_mgm`, and any `ndbd` processes to terminate gracefully. MySQL servers running as Cluster SQL nodes can be stopped using `mysqladmin shutdown`.

For more information, see [Commands in the MySQL Cluster Management Client](#), and [Safe Shutdown and Restart of MySQL Cluster](#).

### **22.10.30: What happens to MySQL Cluster data when the cluster is shut down?**

The data that was held in memory by the MySQL Cluster data nodes is written to disk, and is reloaded into memory the next time that the cluster is started.

### **22.10.31: Is it a good idea to have more than one management node for a MySQL Cluster?**

It can be helpful as a fail-safe. Only one management node controls the cluster at any given time, but it is possible to configure one management node as primary, and one or more additional management nodes to take over in the event that the primary management node fails.

See [MySQL Cluster Configuration Files](#), for information on how to configure MySQL Cluster management nodes.

### **22.10.32: Can I mix different kinds of hardware and operating systems in one MySQL Cluster?**

Yes, as long as all machines and operating systems have the same “endianness” (all big-endian or all little-endian). We are working to overcome this limitation in a future MySQL Cluster release.

It is also possible to use software from different MySQL Cluster releases on different nodes. However, we support this only as part of a rolling upgrade procedure (see [Performing a Rolling Restart of a MySQL Cluster](#)).

### **22.10.33: Can I run two data nodes on a single host? Two SQL nodes?**

Yes, it is possible to do this. In the case of multiple data nodes, it is advisable (but not required) for each node to use a different data directory. If you want to run multiple SQL nodes on one machine, each instance of `mysqld` must use a different TCP/IP port. However, running more than one cluster node of a given type per machine is generally not encouraged or supported for production use.

We also advise against running data nodes and SQL nodes together on the same host, since the `ndbd` and `mysqld` processes may compete for memory.

### **22.10.34: Can I use host names with MySQL Cluster?**

Yes, it is possible to use DNS and DHCP for cluster hosts. However, if your application requires “five nines” availability, we recommend using fixed (numeric) IP addresses. Making communication between Cluster hosts dependent on services such as DNS and DHCP introduces additional potential points of failure.

### **22.10.35: Does MySQL Cluster support IPv6?**

Beginning with MySQL Cluster NDB 6.4, IPv6 is supported for connections between SQL nodes (MySQL servers). However, connections between all other types of nodes must use IPv4.

In practical terms, this means that you can use IPv6 for replication between MySQL Clusters, but connections between nodes in the same MySQL Cluster must use IPv4. For more information, see [Known Issues in MySQL Cluster Replication](#).

### **22.10.36: How do I handle MySQL users in a MySQL Cluster having multiple MySQL servers?**

MySQL user accounts and privileges are not automatically propagated between different MySQL servers accessing the same MySQL Cluster. Therefore, you must make sure that these are copied between the SQL nodes yourself. You can do this manually, or automate the task with scripts.

#### **Warning**

Do not attempt to work around this issue by converting the MySQL system tables to use the `NDBCLUSTER` storage engine. Only the `MyISAM` storage engine is supported for these tables.

### 22.10.37: How do I continue to send queries in the event that one of the SQL nodes fails?

MySQL Cluster does not provide any sort of automatic failover between SQL nodes. Your application must be prepared to handle any loss of SQL nodes and to fail over between them.

## A.11. MySQL 5.1 FAQ — MySQL Chinese, Japanese, and Korean Character Sets

This set of Frequently Asked Questions derives from the experience of MySQL's Support and Development groups in handling many inquiries about CJK (Chinese-Japanese-Korean) issues.

### Questions

- [22.11.1](#): What CJK character sets are available in MySQL?
- [22.11.2](#): I have inserted CJK characters into my table. Why does `SELECT` display them as “?” characters?
- [22.11.3](#): What problems should I be aware of when working with the Big5 Chinese character set?
- [22.11.4](#): Why do Japanese character set conversions fail?
- [22.11.5](#): What should I do if I want to convert SJIS 81CA to cp932?
- [22.11.6](#): How does MySQL represent the Yen (¥) sign?
- [22.11.7](#): Do MySQL plan to make a separate character set where 5C is the Yen sign, as at least one other major DBMS does?
- [22.11.8](#): Of what issues should I be aware when working with Korean character sets in MySQL?
- [22.11.9](#): Why do I get `DATA TRUNCATED` error messages?
- [22.11.10](#): Why does my GUI front end or browser not display CJK characters correctly in my application using Access, PHP, or another API?
- [22.11.11](#): I've upgraded to MySQL 5.1. How can I revert to behavior like that in MySQL 4.0 with regard to character sets?
- [22.11.12](#): Why do some `LIKE` and `FULLTEXT` searches with CJK characters fail?
- [22.11.13](#): How do I know whether character `X` is available in all character sets?
- [22.11.14](#): Why don't CJK strings sort correctly in Unicode? (I)
- [22.11.15](#): Why don't CJK strings sort correctly in Unicode? (II)
- [22.11.16](#): Why are my supplementary characters rejected by MySQL?
- [22.11.17](#): Shouldn't it be “CJKV”?
- [22.11.18](#): Does MySQL allow CJK characters to be used in database and table names?
- [22.11.19](#): Where can I find translations of the MySQL Manual into Chinese, Japanese, and Korean?
- [22.11.20](#): Where can I get help with CJK and related issues in MySQL?

### Questions and Answers

#### 22.11.1: What CJK character sets are available in MySQL?

The list of CJK character sets may vary depending on your MySQL version. For example, the `eurjpm` character set was not supported prior to MySQL 5.0.3. However, since the name of the applicable language appears in the `DESCRIPTION` column for every entry in the `INFORMATION_SCHEMA.CHARACTER_SETS` table, you can obtain a current list of all the non-Unicode CJK character sets using this query:

```
mysql> SELECT CHARACTER_SET_NAME, DESCRIPTION
-> FROM INFORMATION_SCHEMA.CHARACTER_SETS
-> WHERE DESCRIPTION LIKE '%Chinese%'
```



```

-> OR DESCRIPTION LIKE '%Japanese%'
-> OR DESCRIPTION LIKE '%Korean%'
-> ORDER BY CHARACTER_SET_NAME;

```

CHARACTER_SET_NAME	DESCRIPTION
big5	Big5 Traditional Chinese
cp932	SJIS for Windows Japanese
euc_jpms	UJIS for Windows Japanese
euckr	EUC-KR Korean
gb2312	GB2312 Simplified Chinese
gbk	GBK Simplified Chinese
sjis	Shift-JIS Japanese
ujis	EUC-JP Japanese

8 rows in set (0.01 sec)

(See [Section 19.9, “The INFORMATION\\_SCHEMA CHARACTER\\_SETS Table”](#), for more information.)

MySQL supports the two common variants of the *GB* (*Guojia Biaozhun*, or *National Standard*, or *Simplified Chinese*) character sets which are official in the People's Republic of China: `gb2312` and `gbk`. Sometimes people try to insert `gbk` characters into `gb2312`, and it works most of the time because `gbk` is a superset of `gb2312` — but eventually they try to insert a rarer Chinese character and it doesn't work. (See [Bug#16072](#) for an example).

Here, we try to clarify exactly what characters are legitimate in `gb2312` or `gbk`, with reference to the official documents. Please check these references before reporting `gb2312` or `gbk` bugs.

- For a complete listing of the `gb2312` characters, ordered according to the `gb2312_chinese_ci` collation: [gb2312](#)
- MySQL's `gbk` is in reality “Microsoft code page 936”. This differs from the official `gbk` for characters `A1A4` (middle dot), `A1AA` (em dash), `A6E0–A6F5`, and `A8BB–A8C0`. For a listing of the differences, see <http://recode.progiciels-bpi.ca/showfile.html?name=dist/libiconv/gbk.h>.
- For a listing of `gbk`/Unicode mappings, see <http://www.unicode.org/Public/MAPPINGS/VENDORS/MICSFT/WINDOWS/CP936.TXT>.
- For MySQL's listing of `gbk` characters, see [gbk](#).

### 22.11.2: I have inserted CJK characters into my table. Why does `SELECT` display them as “?” characters?

This problem is usually due to a setting in MySQL that doesn't match the settings for the application program or the operating system. Here are some common steps for correcting these types of issues:

- *Be certain of what MySQL version you are using.*

Use the statement `SELECT VERSION()`; to determine this.

- *Make sure that the database is actually using the desired character set.*

People often think that the client character set is always the same as either the server character set or the character set used for display purposes. However, both of these are false assumptions. You can make sure by checking the result of `SHOW CREATE TABLE tablename` or — better — yet by using this statement:

```

SELECT character_set_name, collation_name
FROM information_schema.columns
WHERE table_schema = your_database_name
AND table_name = your_table_name
AND column_name = your_column_name;

```

- *Determine the hexadecimal value of the character or characters that are not being displayed correctly.*

You can obtain this information for a column `column_name` in the table `table_name` using the following query:

```

SELECT HEX(column_name)
FROM table_name;

```

`3F` is the encoding for the `?` character; this means that `?` is the character actually stored in the column. This most often happens because of a problem converting a particular character from your client character set to the target character set.

- *Make sure that a round trip possible — that is, when you select `literal` (or `_introducer hexadecimal-value`), you obtain `literal` as a result.*

For example, the Japanese *Katakana* character *Pe* (ペ) exists in all CJK character sets, and has the code point value (hexadecimal coding) `0x30da`. To test a round trip for this character, use this query:

```
SELECT 'ㄹ' AS `ㄹ`; /* or SELECT _ucs2 0x30da; */
```

If the result is not also ㄹ, then the round trip has failed.

For bug reports regarding such failures, we might ask you to follow up with `SELECT HEX('ㄹ');`. Then we can determine whether the client encoding is correct.

- *Make sure that the problem is not with the browser or other application, rather than with MySQL.*

Use the `mysql` client program (on Windows: `mysql.exe`) to accomplish this task. If `mysql` displays correctly but your application doesn't, then your problem is probably due to system settings.

To find out what your settings are, use the `SHOW VARIABLES` statement, whose output should resemble what is shown here:

```
mysql> SHOW VARIABLES LIKE 'char%';
+-----+-----+
| Variable_name | Value |
+-----+-----+
| character_set_client | utf8 |
| character_set_connection | utf8 |
| character_set_database | latin1 |
| character_set_filesystem | binary |
| character_set_results | utf8 |
| character_set_server | latin1 |
| character_set_system | utf8 |
| character_sets_dir | /usr/local/mysql/share/mysqlCharsets/ |
+-----+-----+
8 rows in set (0.03 sec)
```

These are typical character-set settings for an international-oriented client (notice the use of `utf8` Unicode) connected to a server in the West (`latin1` is a West Europe character set and a default for MySQL).

Although Unicode (usually the `utf8` variant on Unix, and the `ucs2` variant on Windows) is preferable to Latin, it is often not what your operating system utilities support best. Many Windows users find that a Microsoft character set, such as `cp932` for Japanese Windows, is suitable.

If you cannot control the server settings, and you have no idea what your underlying computer is, then try changing to a common character set for the country that you're in (`euckr` = Korea; `gb2312` or `gbk` = People's Republic of China; `big5` = Taiwan; `sjis`, `ujis`, `cp932`, or `eucjpms` = Japan; `ucs2` or `utf8` = anywhere). Usually it is necessary to change only the client and connection and results settings. There is a simple statement which changes all three at once: `SET NAMES`. For example:

```
SET NAMES 'big5';
```

Once the setting is correct, you can make it permanent by editing `my.cnf` or `my.ini`. For example you might add lines looking like these:

```
[mysqld]
character-set-server=big5
[client]
default-character-set=big5
```

It is also possible that there are issues with the API configuration setting being used in your application; see *Why does my GUI front end or browser not display CJK characters correctly...?* for more information.

### 22.11.3: What problems should I be aware of when working with the Big5 Chinese character set?

MySQL supports the Big5 character set which is common in Hong Kong and Taiwan (Republic of China). MySQL's `big5` is in reality Microsoft code page 950, which is very similar to the original `big5` character set. We changed to this character set starting with MySQL version 4.1.16 / 5.0.16 (as a result of [Bug#12476](#)). For example, the following statements work in current versions of MySQL, but not in old versions:

```
mysql> CREATE TABLE big5 (BIG5 CHAR(1) CHARACTER SET BIG5);
Query OK, 0 rows affected (0.13 sec)

mysql> INSERT INTO big5 VALUES (0xf9dc);
Query OK, 1 row affected (0.00 sec)

mysql> SELECT * FROM big5;
+-----+
| big5 |
+-----+
| 嫻 |
+-----+
1 row in set (0.02 sec)
```

A feature request for adding `HKSCS` extensions has been filed. People who need this extension may find the suggested patch for

[Bug#13577](#) to be of interest.

#### 22.11.4: Why do Japanese character set conversions fail?

MySQL supports the `sjis`, `ujis`, `cp932`, and `ujis` character sets, as well as Unicode. A common need is to convert between character sets. For example, there might be a Unix server (typically with `sjis` or `ujis`) and a Windows client (typically with `cp932`).

In the following conversion table, the `ucs2` column represents the source, and the `sjis`, `cp932`, `ujis`, and `ujis` columns represent the destinations — that is, the last 4 columns provide the hexadecimal result when we use `CONVERT(ucs2)` or we assign a `ucs2` column containing the value to an `sjis`, `cp932`, `ujis`, or `ujis` column.

Character Name	ucs2	sjis	cp932	ujis	ujis
BROKEN BAR	00A6	3F	3F	8FA2C3	3F
FULLWIDTH BROKEN BAR	FFE4	3F	FA55	3F	8FA2
YEN SIGN	00A5	3F	3F	20	3F
FULLWIDTH YEN SIGN	FFE5	818F	818F	A1EF	3F
TILDE	007E	7E	7E	7E	7E
OVERLINE	203E	3F	3F	20	3F
HORIZONTAL BAR	2015	815C	815C	A1BD	A1BD
EM DASH	2014	3F	3F	3F	3F
REVERSE SOLIDUS	005C	815F	5C	5C	5C
FULLWIDTH ""	FF3C	3F	815F	3F	A1C0
WAVE DASH	301C	8160	3F	A1C1	3F
FULLWIDTH TILDE	FF5E	3F	8160	3F	A1C1
DOUBLE VERTICAL LINE	2016	8161	3F	A1C2	3F
PARALLEL TO	2225	3F	8161	3F	A1C2
MINUS SIGN	2212	817C	3F	A1DD	3F
FULLWIDTH HYPHEN-MINUS	FF0D	3F	817C	3F	A1DD
CENT SIGN	00A2	8191	3F	A1F1	3F
FULLWIDTH CENT SIGN	FFE0	3F	8191	3F	A1F1
POUND SIGN	00A3	8192	3F	A1F2	3F
FULLWIDTH POUND SIGN	FFE1	3F	8192	3F	A1F2
NOT SIGN	00AC	81CA	3F	A2CC	3F
FULLWIDTH NOT SIGN	FFE2	3F	81CA	3F	A2CC

Now consider the following portion of the table.

	ucs2	sjis	cp932
NOT SIGN	00AC	81CA	3F
FULLWIDTH NOT SIGN	FFE2	3F	81CA

This means that MySQL converts the `NOT SIGN` (Unicode `U+00AC`) to `sjis` code point `0x81CA` and to `cp932` code point `3F`. (`3F` is the question mark (“?”) — this is what is always used when the conversion cannot be performed.

#### 22.11.5: What should I do if I want to convert SJIS 81CA to cp932?

Our answer is: “?”. There are serious complaints about this: many people would prefer a “loose” conversion, so that `81CA` (`NOT SIGN`) in `sjis` becomes `81CA` (`FULLWIDTH NOT SIGN`) in `cp932`. We are considering a change to this behavior.

#### 22.11.6: How does MySQL represent the Yen (¥) sign?

A problem arises because some versions of Japanese character sets (both `sjis` and `ujis`) treat `5C` as a *reverse solidus* (`\` — also known as a backslash), and others treat it as a yen sign (¥).

MySQL follows only one version of the JIS (Japanese Industrial Standards) standard description. In MySQL, `5C` is always the *reverse solidus* (`\`).

#### 22.11.7: Do MySQL plan to make a separate character set where 5C is the Yen sign, as at least one other major DBMS does?

This is one possible solution to the Yen sign issue; however, this will not happen in MySQL 5.1 or 6.0.

### 22.11.8: Of what issues should I be aware when working with Korean character sets in MySQL?

In theory, while there have been several versions of the `euckr` (*Extended Unix Code Korea*) character set, only one problem has been noted.

We use the “ASCII” variant of EUC-KR, in which the code point `0x5c` is REVERSE SOLIDUS, that is `\`, instead of the “KS-Roman” variant of EUC-KR, in which the code point `0x5c` is `₩` (`₩`). This means that you cannot convert Unicode `U+20A9` to `euckr`:

```
mysql> SELECT
->     CONVERT('₩' USING euckr) AS euckr,
->     HEX(CONVERT('₩' USING euckr)) AS hexeuckr;
+-----+-----+
| euckr | hexeuckr |
+-----+-----+
| ?     | 3F       |
+-----+-----+
1 row in set (0.00 sec)
```

MySQL's graphic Korean chart is here: [euckr](#).

### 22.11.9: Why do I get `DATA TRUNCATED` error messages?

For illustration, we'll create a table with one Unicode (`ucs2`) column and one Chinese (`gb2312`) column.

```
mysql> CREATE TABLE ch
->     (ucs2 CHAR(3) CHARACTER SET ucs2,
->     gb2312 CHAR(3) CHARACTER SET gb2312);
Query OK, 0 rows affected (0.05 sec)
```

We'll try to place the rare character `ㄹ` in both columns.

```
mysql> INSERT INTO ch VALUES ('AㄹB','AㄹB');
Query OK, 1 row affected, 1 warning (0.00 sec)
```

Ah, there is a warning. Use the following statement to see what it is:

```
mysql> SHOW WARNINGS;
+-----+-----+-----+
| Level | Code | Message
+-----+-----+-----+
| Warning | 1265 | Data truncated for column 'gb2312' at row 1
+-----+-----+-----+
1 row in set (0.00 sec)
```

So it is a warning about the `gb2312` column only.

```
mysql> SELECT ucs2,HEX(ucs2),gb2312,HEX(gb2312) FROM ch;
+-----+-----+-----+-----+
| ucs2 | HEX(ucs2) | gb2312 | HEX(gb2312) |
+-----+-----+-----+-----+
| AㄹB | 00416C4C0042 | A?B | 413F42 |
+-----+-----+-----+-----+
1 row in set (0.00 sec)
```

There are several things that need explanation here.

1. The fact that it is a “warning” rather than an “error” is characteristic of MySQL. We like to try to do what we can, to get the best fit, rather than give up.
2. The `ㄹ` character isn't in the `gb2312` character set. We described that problem earlier.
3. Admittedly the message is misleading. We didn't “truncate” in this case, we replaced with a question mark. We've had a complaint about this message (See [Bug#9337](#)). But until we come up with something better, just accept that error/warning code 2165 can mean a variety of things.
4. With `SQL_MODE=TRADITIONAL`, there would be an error message, but instead of error 2165 you would see: `ERROR 1406 (22001): Data too long for column 'gb2312' at row 1`.

### 22.11.10: Why does my GUI front end or browser not display CJK characters correctly in my application using Access, PHP, or another API?

Obtain a direct connection to the server using the `mysql` client (Windows: `mysql.exe`), and try the same query there. If `mysql` responds correctly, then the trouble may be that your application interface requires initialization. Use `mysql` to tell you what character set or sets it uses with the statement `SHOW VARIABLES LIKE 'char%'`. If you are using Access, then you are most likely connecting with MyODBC. In this case, you should check [Section 20.1.4](#), “Connector/ODBC Configuration”. If, for in-

stance, you use `big5`, you would enter `SET NAMES 'big5'`. (Note that no `;` is required in this case). If you are using ASP, you might need to add `SET NAMES` in the code. Here is an example that has worked in the past:

```
<%
Session.CodePage=0
Dim strConnection
Dim Conn
strConnection="driver={MySQL ODBC 3.51 Driver};server=server;uid=username;" \
& "pwd=password;database=database;stmt=SET NAMES 'big5';"
Set Conn = Server.CreateObject("ADODB.Connection")
Conn.Open strConnection
%>
```

In much the same way, if you are using any character set other than `latin1` with Connector/NET, then you must specify the character set in the connection string. See [Section 20.2.4.2, “Connecting to MySQL Using Connector/NET”](#), for more information.

If you are using PHP, try this:

```
<?php
$link = mysql_connect($host, $usr, $pwd);

mysql_select_db($db);

if( mysql_error() ) { print "Database ERROR: " . mysql_error(); }
mysql_query("SET NAMES 'utf8'", $link);
?>
```

In this case, we used `SET NAMES` to change `character_set_client` and `character_set_connection` and `character_set_results`.

We encourage the use of the newer `mysqli` extension, rather than `mysql`. Using `mysqli`, the previous example could be rewritten as shown here:

```
<?php
$link = new mysqli($host, $usr, $pwd, $db);

if( mysqli_connect_errno() )
{
    printf("Connect failed: %s\n", mysqli_connect_error());
    exit();
}

$link->query("SET NAMES 'utf8'");
?>
```

Another issue often encountered in PHP applications has to do with assumptions made by the browser. Sometimes adding or changing a `<meta>` tag suffices to correct the problem: for example, to insure that the user agent interprets page content as `UTF-8`, you should include `<meta http-equiv="Content-Type" content="text/html; charset=utf-8">` in the `<head>` of the HTML page.

If you are using Connector/J, see [Section 20.4.4.4, “Using Character Sets and Unicode”](#).

### 22.11.11: I've upgraded to MySQL 5.1. How can I revert to behavior like that in MySQL 4.0 with regard to character sets?

In MySQL Version 4.0, there was a single “global” character set for both server and client, and the decision as to which character to use was made by the server administrator. This changed starting with MySQL Version 4.1. What happens now is a “handshake”, as described in [Section 9.1.4, “Connection Character Sets and Collations”](#):

When a client connects, it sends to the server the name of the character set that it wants to use. The server uses the name to set the `character_set_client`, `character_set_results`, and `character_set_connection` system variables. In effect, the server performs a `SET NAMES` operation using the character set name.

The effect of this is that you cannot control the client character set by starting `mysqld` with `-character-set-server=utf8`. However, some of our Asian customers have said that they prefer the MySQL 4.0 behavior. To make it possible to retain this behavior, we added a `mysqld` switch, `--character-set-client-handshake`, which can be turned off with `--skip-character-set-client-handshake`. If you start `mysqld` with `-skip-character-set-client-handshake`, then, when a client connects, it sends to the server the name of the character set that it wants to use — however, *the server ignores this request from the client*.

By way of example, suppose that your favorite server character set is `latin1` (unlikely in a CJK area, but this is the default value). Suppose further that the client uses `utf8` because this is what the client's operating system supports. Now, start the server with `latin1` as its default character set:

```
mysqld --character-set-server=latin1
```

And then start the client with the default character set `utf8`:

```
mysql --default-character-set=utf8
```

The current settings can be seen by viewing the output of `SHOW VARIABLES`:

```
mysql> SHOW VARIABLES LIKE 'char%';
+-----+-----+
| Variable_name | Value |
+-----+-----+
| character_set_client | utf8 |
| character_set_connection | utf8 |
| character_set_database | latin1 |
| character_set_filesystem | binary |
| character_set_results | utf8 |
| character_set_server | latin1 |
| character_set_system | utf8 |
| character_sets_dir | /usr/local/mysql/share/mysqlCharsets/ |
+-----+-----+
8 rows in set (0.01 sec)
```

Now stop the client, and then stop the server using `mysqldadmin`. Then start the server again, but this time tell it to skip the handshake like so:

```
mysqld --character-set-server=utf8 --skip-character-set-client-handshake
```

Start the client with `utf8` once again as the default character set, then display the current settings:

```
mysql> SHOW VARIABLES LIKE 'char%';
+-----+-----+
| Variable_name | Value |
+-----+-----+
| character_set_client | latin1 |
| character_set_connection | latin1 |
| character_set_database | latin1 |
| character_set_filesystem | binary |
| character_set_results | latin1 |
| character_set_server | latin1 |
| character_set_system | utf8 |
| character_sets_dir | /usr/local/mysql/share/mysqlCharsets/ |
+-----+-----+
8 rows in set (0.01 sec)
```

As you can see by comparing the differing results from `SHOW VARIABLES`, the server ignores the client's initial settings if the `--skip-character-set-client-handshake` is used.

#### 22.11.12: Why do some `LIKE` and `FULLTEXT` searches with CJK characters fail?

There is a very simple problem with `LIKE` searches on `BINARY` and `BLOB` columns: we need to know the end of a character. With multi-byte character sets, different characters might have different octet lengths. For example, in `utf8`, `A` requires one byte but `Æ` requires three bytes, as shown here:

```
+-----+-----+
| OCTET_LENGTH(_utf8 'A') | OCTET_LENGTH(_utf8 'Æ') |
+-----+-----+
| 1 | 3 |
+-----+-----+
1 row in set (0.00 sec)
```

If we don't know where the first character ends, then we don't know where the second character begins, in which case even very simple searches such as `LIKE '_A%'` fail. The solution is to use a regular CJK character set in the first place, or to convert to a CJK character set before comparing.

This is one reason why MySQL cannot allow encodings of non-existent characters. If it is not strict about rejecting bad input, then it has no way of knowing where characters end.

For `FULLTEXT` searches, we need to know where words begin and end. With Western languages, this is rarely a problem because most (if not all) of these use an easy-to-identify word boundary — the space character. However, this is not usually the case with Asian writing. We could use arbitrary halfway measures, like assuming that all Han characters represent words, or (for Japanese) depending on changes from Katakana to Hiragana due to grammatical endings. However, the only sure solution requires a comprehensive word list, which means that we would have to include a dictionary in the server for each Asian language supported. This is simply not feasible.

#### 22.11.13: How do I know whether character `X` is available in all character sets?

The majority of simplified Chinese and basic non-halfwidth Japanese *Kana* characters appear in all CJK character sets. This stored procedure accepts a `UCS-2` Unicode character, converts it to all other character sets, and displays the results in hexadecimal.

```
DELIMITER //
CREATE PROCEDURE p_convert(ucs2_char CHAR(1) CHARACTER SET ucs2)
BEGIN
CREATE TABLE tj
(ucs2 CHAR(1) character set ucs2,
utf8 CHAR(1) character set utf8,
big5 CHAR(1) character set big5,
cp932 CHAR(1) character set cp932,
eucjpms CHAR(1) character set eucjpms,
euckr CHAR(1) character set euckr,
gb2312 CHAR(1) character set gb2312,
```

```

gbk CHAR(1) character set gbk,
sjis CHAR(1) character set sjis,
ujis CHAR(1) character set ujis);

INSERT INTO tj (ucs2) VALUES (ucs2_char);

UPDATE tj SET utf8=ucs2,
             big5=ucs2,
             cp932=ucs2,
             eucjpms=ucs2,
             euckr=ucs2,
             gb2312=ucs2,
             gbk=ucs2,
             sjis=ucs2,
             ujis=ucs2;

/* If there is a conversion problem, UPDATE will produce a warning. */

SELECT hex(ucs2) AS ucs2,
       hex(utf8) AS utf8,
       hex(big5) AS big5,
       hex(cp932) AS cp932,
       hex(eucjpms) AS eucjpms,
       hex(euckr) AS euckr,
       hex(gb2312) AS gb2312,
       hex(gbk) AS gbk,
       hex(sjis) AS sjis,
       hex(ujis) AS ujis
FROM tj;

DROP TABLE tj;

END//

```

The input can be any single `ucs2` character, or it can be the code point value (hexadecimal representation) of that character. For example, from Unicode's list of `ucs2` encodings and names (<http://www.unicode.org/Public/UNIDATA/UnicodeData.txt>), we know that the *Katakana* character *Pe* appears in all CJK character sets, and that its code point value is `0x30da`. If we use this value as the argument to `p_convert()`, the result is as shown here:

```

mysql> CALL p_convert(0x30da)//
+-----+-----+-----+-----+-----+-----+-----+-----+-----+-----+
| ucs2 | utf8 | big5 | cp932 | eucjpms | euckr | gb2312 | gbk | sjis | ujis |
+-----+-----+-----+-----+-----+-----+-----+-----+-----+-----+
| 30DA | E3839A | C772 | 8379 | A5DA | ABDA | A5DA | A5DA | 8379 | A5DA |
+-----+-----+-----+-----+-----+-----+-----+-----+-----+-----+
1 row in set (0.04 sec)

```

Since none of the column values is `3F` — that is, the question mark character (?) — we know that every conversion worked.

#### 22.11.14: Why don't CJK strings sort correctly in Unicode? (I)

Sometimes people observe that the result of a `utf8_unicode_ci` or `ucs2_unicode_ci` search, or of an `ORDER BY` sort is not what they think a native would expect. Although we never rule out the possibility that there is a bug, we have found in the past that many people do not read correctly the standard table of weights for the Unicode Collation Algorithm. MySQL uses the table found at <http://www.unicode.org/Public/UCA/4.0.0/allkeys-4.0.0.txt>. This is not the first table you will find by navigating from the [unicode.org](http://www.unicode.org) home page, because MySQL uses the older 4.0.0 “allkeys” table, rather than the more recent 4.1.0 table. This is because we are very wary about changing ordering which affects indexes, lest we bring about situations such as that reported in [Bug#16526](#), illustrated as follows:

```

mysql< CREATE TABLE tj (s1 CHAR(1) CHARACTER SET utf8 COLLATE utf8_unicode_ci);
Query OK, 0 rows affected (0.05 sec)

mysql> INSERT INTO tj VALUES ('が'),('か');
Query OK, 2 rows affected (0.00 sec)
Records: 2 Duplicates: 0 Warnings: 0

mysql> SELECT * FROM tj WHERE s1 = 'か';
+-----+
| s1 |
+-----+
| が |
| か |
+-----+
2 rows in set (0.00 sec)

```

The character in the first result row is not the one that we searched for. Why did MySQL retrieve it? First we look for the Unicode code point value, which is possible by reading the hexadecimal number for the `ucs2` version of the characters:

```

mysql> SELECT s1, HEX(CONVERT(s1 USING ucs2)) FROM tj;
+-----+-----+
| s1 | HEX(CONVERT(s1 USING ucs2)) |
+-----+-----+
| が | 304C |
| か | 304B |
+-----+-----+
2 rows in set (0.03 sec)

```

Now we search for `304B` and `304C` in the `4.0.0 allkeys` table, and find these lines:



```
304B ; [.1E57.0020.000E.304B] # HIRAGANA LETTER KA
304C ; [.1E57.0020.000E.304B][.0000.0140.0002.3099] # HIRAGANA LETTER GA; QOCM
```

The official Unicode names (following the “#” mark) tell us the Japanese syllabary (Hiragana), the informal classification (letter, digit, or punctuation mark), and the Western identifier (*KA* or *GA*, which happen to be voiced and unvoiced components of the same letter pair). More importantly, the *primary weight* (the first hexadecimal number inside the square brackets) is `1E57` on both lines. For comparisons in both searching and sorting, MySQL pays attention to the primary weight only, ignoring all the other numbers. This means that we are sorting `が` and `カ` correctly according to the Unicode specification. If we wanted to distinguish them, we'd have to use a non-UCA (Unicode Collation Algorithm) collation (`utf8_bin` or `utf8_general_ci`), or to compare the `HEX()` values, or use `ORDER BY CONVERT(s1 USING sjis)`. Being correct “according to Unicode” isn't enough, of course: the person who submitted the bug was equally correct. We plan to add another collation for Japanese according to the JIS X 4061 standard, in which voiced/unvoiced letter pairs like *KA/GA* are distinguishable for ordering purposes.

### 22.11.15: Why don't CJK strings sort correctly in Unicode? (II)

If you are using Unicode (`ucs2` or `utf8`), and you know what the Unicode sort order is (see [Section A.11, “MySQL 5.1 FAQ — MySQL Chinese, Japanese, and Korean Character Sets”](#)), but MySQL still seems to sort your table incorrectly, then you should first verify the table character set:

```
mysql> SHOW CREATE TABLE t\G
***** 1. row *****
Table: t
Create Table: CREATE TABLE `t` (
  `s1` char(1) CHARACTER SET ucs2 DEFAULT NULL
) ENGINE=MyISAM DEFAULT CHARSET=latin1
1 row in set (0.00 sec)
```

Since the character set appears to be correct, let's see what information the `INFORMATION_SCHEMA.COLUMNS` table can provide about this column:

```
mysql> SELECT COLUMN_NAME, CHARACTER_SET_NAME, COLLATION_NAME
-> FROM INFORMATION_SCHEMA.COLUMNS
-> WHERE COLUMN_NAME = 's1'
-> AND TABLE_NAME = 't';
+-----+-----+-----+
| COLUMN_NAME | CHARACTER_SET_NAME | COLLATION_NAME |
+-----+-----+-----+
| s1          | ucs2              | ucs2_general_ci |
+-----+-----+-----+
1 row in set (0.01 sec)
```

(See [Section 19.3, “The INFORMATION\\_SCHEMA COLUMNS Table”](#), for more information.)

You can see that the collation is `ucs2_general_ci` instead of `ucs2_unicode_ci`. The reason why this is so can be found using `SHOW CHARSET`, as shown here:

```
mysql> SHOW CHARSET LIKE 'ucs2%';
+-----+-----+-----+-----+
| Charset | Description | Default collation | Maxlen |
+-----+-----+-----+-----+
| ucs2    | UCS-2 Unicode | ucs2_general_ci   | 2      |
+-----+-----+-----+-----+
1 row in set (0.00 sec)
```

For `ucs2` and `utf8`, the default collation is “general”. To specify a Unicode collation, use `COLLATE ucs2_unicode_ci`.

### 22.11.16: Why are my supplementary characters rejected by MySQL?

Before MySQL 6.0.4, MySQL does not support supplementary characters — that is, characters which need more than 3 bytes — for `UTF-8`. We support only what Unicode calls the *Basic Multilingual Plane / Plane 0*. Only a few very rare Han characters are supplementary; support for them is uncommon. This has led to reports such as that found in [Bug#12600](#), which we rejected as “not a bug”. With `utf8`, we must truncate an input string when we encounter bytes that we don't understand. Otherwise, we wouldn't know how long the bad multi-byte character is.

One possible workaround is to use `ucs2` instead of `utf8`, in which case the “bad” characters are changed to question marks; however, no truncation takes place. You can also change the data type to `BLOB` or `BINARY`, which perform no validity checking.

As of MySQL 6.0.4, Unicode support is extended to include supplementary characters by means of additional Unicode character sets: `utf16`, `utf32`, and 4-byte `utf8`. These character sets support supplementary Unicode characters outside the Basic Multilingual Plane (BMP).

### 22.11.17: Shouldn't it be “CJKV”?

No. The term “CJKV” (*Chinese Japanese Korean Vietnamese*) refers to Vietnamese character sets which contain Han (originally Chinese) characters. MySQL has no plan to support the old Vietnamese script using Han characters. MySQL does of course support the modern Vietnamese script with Western characters.

[Bug#4745](#) is a request for a specialized Vietnamese collation, which we might add in the future if there is sufficient demand for it.



**22.11.18: Does MySQL allow CJK characters to be used in database and table names?**

This issue is fixed in MySQL 5.1, by automatically rewriting the names of the corresponding directories and files.

For example, if you create a database named 精 on a server whose operating system does not support CJK in directory names, MySQL creates a directory named @0w@00a5@00ae. which is just a fancy way of encoding E6A5AE — that is, the Unicode hexadecimal representation for the 精 character. However, if you run a `SHOW DATABASES` statement, you can see that the database is listed as 精.

**22.11.19: Where can I find translations of the MySQL Manual into Chinese, Japanese, and Korean?**

A Simplified Chinese version of the Manual, current for MySQL 5.1.12, can be found at <http://dev.mysql.com/doc/>. The Japanese translation of the MySQL 4.1 manual can be downloaded from <http://dev.mysql.com/doc/>.

**22.11.20: Where can I get help with CJK and related issues in MySQL?**

The following resources are available:

- A listing of MySQL user groups can be found at <http://dev.mysql.com/user-groups/>.
- You can contact a sales engineer at the MySQL KK Japan office using any of the following:

```
Tel: +81(0)3-5326-3133
Fax: +81(0)3-5326-3001
Email: dsaito@mysql.com
```

- View feature requests relating to character set issues at <http://tinyurl.com/y6xcuf>.
- Visit the MySQL [Character Sets, Collation, Unicode Forum](#). We are also in the process of adding foreign-language forums at <http://forums.mysql.com/>.

## A.12. MySQL 5.1 FAQ — Connectors & APIs

For common questions, issues, and answers relating to the MySQL Connectors and other APIs, see the following areas of the Manual:

- [Section 20.10.10, “Common Questions and Problems When Using the C API”](#)
- [Section 20.11.5, “Common Problems with MySQL and PHP”](#)
- [Section 20.1.7, “Connector/ODBC Notes and Tips”](#)
- [Section 20.2.4, “Connector/NET Programming”](#)
- [Section 20.4.5, “Connector/J Notes and Tips”](#)
- [Section 20.5.6, “Connector/MXJ Notes and Tips”](#)

## A.13. MySQL 5.1 FAQ — Replication

For answers to common queries and question regarding Replication within MySQL, see [Section 16.3.4, “Replication FAQ”](#).

## A.14. MySQL 5.1 FAQ — MySQL, DRBD, and Heartbeat

### A.14.1. Distributed Replicated Block Device (DRBD)

In the following section, we provide answers to questions that are most frequently asked about Distributed Replicated Block Device (DRBD).

#### Questions

- [22.14.1.1: What is DRBD?](#)
- [22.14.1.2: What are “Block Devices”?](#)

- [22.14.1.3](#): How is DRBD licensed?
- [22.14.1.4](#): Where can I download DRBD?
- [22.14.1.5](#): If I find a bug in DRBD, to whom do I submit the issue?
- [22.14.1.6](#): Where can I get more technical and business information concerning MySQL and DRBD?

### Questions and Answers

#### 22.14.1.1: What is DRBD?

DRBD is an acronym for Distributed Replicated Block Device. DRBD is an open source Linux kernel block device which leverages synchronous replication to achieve a consistent view of data between two systems, typically an Active and Passive system. DRBD currently supports all the major flavors of Linux and comes bundled in several major Linux distributions. The DRBD project is maintained by [LINBIT](#).

#### 22.14.1.2: What are “Block Devices”?

A *block device* is the type of device used to represent storage in the Linux Kernel. All physical disk devices present a block device interface. Additionally, virtual disk systems like LVM or DRBD present a block device interface. In this way, the file system or other software that might want to access a disk device can be used with any number of real or virtual devices without having to know anything about their underlying implementation details.

#### 22.14.1.3: How is DRBD licensed?

DRBD is licensed under the GPL.

#### 22.14.1.4: Where can I download DRBD?

Please see <http://www.drbd.org/download/packages/>.

#### 22.14.1.5: If I find a bug in DRBD, to whom do I submit the issue?

Bug reports should be submitted to the DRBD mailing list. Please see <http://lists.linbit.com/>.

#### 22.14.1.6: Where can I get more technical and business information concerning MySQL and DRBD?

Please visit <http://mysql.com/drbd/>.

## A.14.2. Linux Heartbeat

In the following section, we provide answers to questions that are most frequently asked about Linux Heartbeat.

### Questions

- [22.14.2.1](#): What is Linux Heartbeat?
- [22.14.2.2](#): How is Linux Heartbeat licensed?
- [22.14.2.3](#): Where can I download Linux Heartbeat?
- [22.14.2.4](#): If I find a bug with Linux Heartbeat, to whom do I submit the issue?

### Questions and Answers

#### 22.14.2.1: What is Linux Heartbeat?

The Linux-HA project (<http://www.linux-ha.org/>) offers a high availability solution commonly referred to as Linux Heartbeat. Linux Heartbeat ships as part of several Linux distributions, as well as within several embedded high availability systems. This solution can also be used for other applications besides databases servers, such as mail servers, web servers, file servers, and DNS servers.

Linux Heartbeat implements a heartbeat-protocol. A heartbeat-protocol means that messages are sent at regular intervals between two or more nodes. If a message is not received from a node within a given interval, then it is assumed the node has failed and some type of failover or recovery action is required. Linux Heartbeat is typically configured to send these heartbeat messages over standard Ethernet interfaces, but it does also support other methods, such as serial-line links.

**22.14.2.2: How is Linux Heartbeat licensed?**

Linux Heartbeat is licensed under the GPL.

**22.14.2.3: Where can I download Linux Heartbeat?**

Please see <http://linux-ha.org/download/index.html>.

**22.14.2.4: If I find a bug with Linux Heartbeat, to whom do I submit the issue?**

Bug reports should be submitted to <http://www.linux-ha.org/ClusterResourceManager/BugReports>.

## A.14.3. DRBD Architecture

In the following section, we provide answers to questions that are most frequently asked about DRBD Architecture.

### Questions

- [22.14.3.1: Is an Active/Active option available for MySQL with DRBD?](#)
- [22.14.3.2: What MySQL storage engines are supported with DRBD?](#)
- [22.14.3.3: How long does a failover take?](#)
- [22.14.3.4: How long does it take to resynchronize data after a failure?](#)
- [22.14.3.5: Are there any situations where you shouldn't use DRBD?](#)
- [22.14.3.6: Are there any limitations to DRBD?](#)
- [22.14.3.7: Where can I find more information on sample architectures?](#)

### Questions and Answers

**22.14.3.1: Is an Active/Active option available for MySQL with DRBD?**

Currently, MySQL does not support Active/Active configurations using DRBD “out of the box”.

**22.14.3.2: What MySQL storage engines are supported with DRBD?**

All of the MySQL transactional storage engines are supported by DRBD, including InnoDB and Falcon. For archived or read-only data, MyISAM or Archive can also be used.

**22.14.3.3: How long does a failover take?**

Failover time is dependent on many things, some of which are configurable. After activating the passive host, MySQL will have to start and run a normal recovery process. If the InnoDB log files have been configured to a large size and there was heavy write traffic, this may take a reasonably long period of time. However, under normal circumstances, failover tends to take less than a minute.

**22.14.3.4: How long does it take to resynchronize data after a failure?**

Resynchronization time depends on how long the two machines are out of communication and how much data was written during that period of time. Resynchronization time is a function of data to be synced, network speed and disk speed. DRBD maintains a bitmap of changed blocks on the primary machine, so only those blocks that have changed will need to be transferred.

**22.14.3.5: Are there any situations where you shouldn't use DRBD?**

See [When Not To Use DRBD](#).

**22.14.3.6: Are there any limitations to DRBD?**

See [DRBD limitations \(or are they?\)](#).

**22.14.3.7: Where can I find more information on sample architectures?**

For an example of a Heartbeat R1-compatible resource configuration involving a MySQL database backed by DRBD, see [DRBD User's Guide](#).

For an example of the same DRBD-backed configuration for a MySQL database in a Heartbeat CRM cluster, see [DRBD User's Guide](#).

## A.14.4. DRBD and MySQL Replication

In the following section, we provide answers to questions that are most frequently asked about MySQL Replication Scale-out.

### Questions

- [22.14.4.1](#): What is the difference between MySQL Cluster and DRBD?
- [22.14.4.2](#): What is the difference between MySQL Replication and DRBD?
- [22.14.4.3](#): How can I combine MySQL Replication scale-out with DRBD?

### Questions and Answers

#### 22.14.4.1: What is the difference between MySQL Cluster and DRBD?

Both MySQL Cluster and DRBD replicate data synchronously. MySQL Cluster leverages a shared-nothing storage architecture in which the cluster can be architected beyond an Active/Passive configuration. DRBD operates at a much lower level within the “stack”, at the disk I/O level. For a comparison of various high availability features between these two options, please refer to [Chapter 14, High Availability and Scalability](#).

#### 22.14.4.2: What is the difference between MySQL Replication and DRBD?

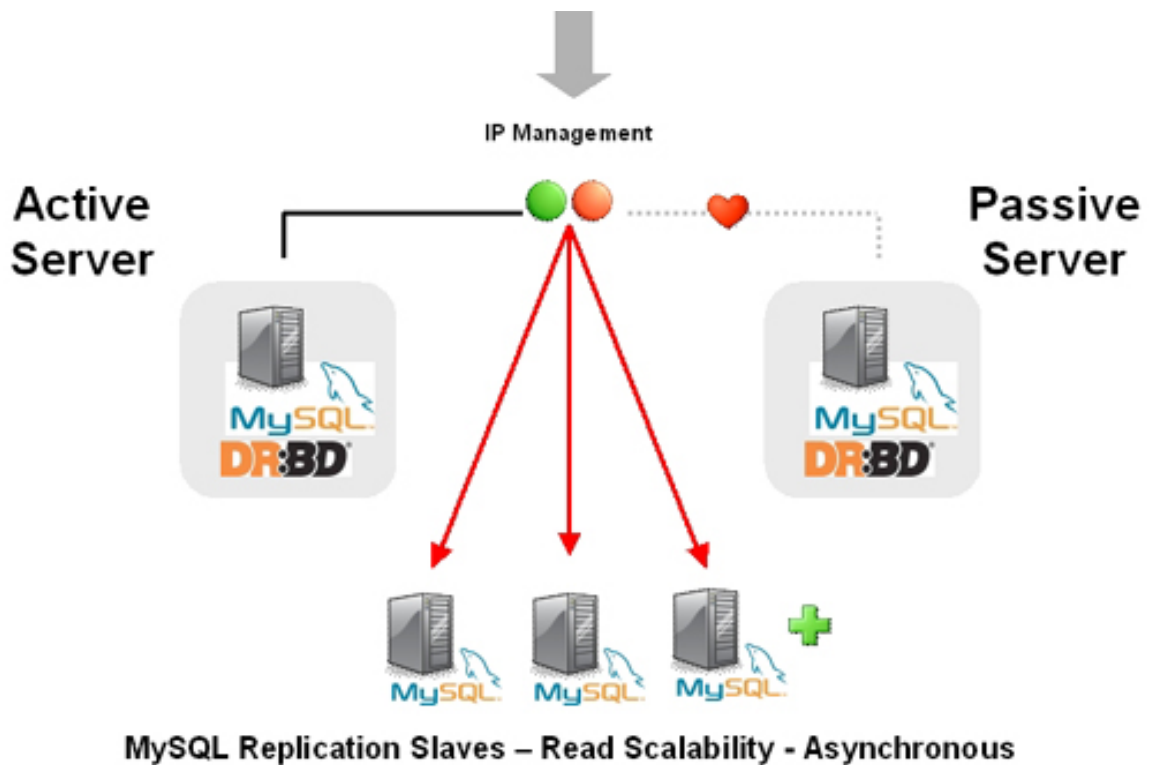
MySQL Replication replicates data asynchronously while DRBD replicates data synchronously. Also, MySQL Replication replicates MySQL statements, while DRBD replicates the underlying block device that stores the MySQL data files. For a comparison of various high availability features between these two options, please refer to the high availability comparison grid, [Chapter 14, High Availability and Scalability](#).

#### 22.14.4.3: How can I combine MySQL Replication scale-out with DRBD?

MySQL Replication is typically deployed in a Master to many Slaves configuration. In this configuration, having many Slaves provides read scalability. DRBD is used to provide high-availability for the Master MySQL Server in an Active/Passive configuration. This provides for automatic failover, safeguards against data loss, and automatically synchronizes the failed MySQL Master after a failover.

The most likely scenario in which MySQL Replication scale-out can be leveraged with DRBD is in the form of attaching replicated MySQL “read-slaves” off of the Active-Master MySQL Server, shown in [Figure A.1, “Active-Master MySQL server”](#). Since DRBD replicates an entire block device, master information such as the binary logs are also replicated. In this way, all of the slaves can attach to the Virtual IP Address managed by Linux Heartbeat. In the event of a failure, the asynchronous nature of MySQL Replication allows the slaves to continue with the new Active machine as their master with no intervention needed.

### Figure A.1. Active-Master MySQL server



## A.14.5. DRBD and File Systems

In the following section, we provide answers to questions that are most frequently asked about DRBD and file systems.

### Questions

- [22.14.5.1](#): Can XFS be used with DRBD?

### Questions and Answers

#### 22.14.5.1: Can XFS be used with DRBD?

Yes. XFS uses dynamic block size, thus DRBD 0.7 or later is needed.

## A.14.6. DRBD and LVM

In the following section, we provide answers to questions that are most frequently asked about DRBD and LVM.

### Questions

- [22.14.6.1](#): Can I use DRBD on top of LVM?
- [22.14.6.2](#): Can I use LVM on top of DRBD?
- [22.14.6.3](#): Can I use DRBD on top of LVM while at the same time running LVM on top of that DRBD?

### Questions and Answers

#### 22.14.6.1: Can I use DRBD on top of LVM?

Yes, DRBD supports on-line resizing. If you enlarge your logical volume that acts as a backing device for DRBD, you can enlarge DRBD itself too, and of course your file system if it supports resizing.

#### 22.14.6.2: Can I use LVM on top of DRBD?

Yes, you can use DRBD as a Physical Volume (PV) for LVM. Depending on the default LVM configuration shipped with your dis-

tribution, you may need to add the `/dev/drbd*` device files to the `filter` option in your `lvm.conf` so LVM scans your DRBDs for PV signatures.

#### **22.14.6.3: Can I use DRBD on top of LVM while at the same time running LVM on top of that DRBD?**

This requires careful tuning of your LVM configuration to avoid duplicate PV scans, but yes, it is possible.

### **A.14.7. DRBD and Virtualization**

In the following section, we provide answers to questions that are most frequently asked about DRBD and virtualization.

#### **Questions**

- [22.14.7.1: Can I use DRBD with OpenVZ?](#)
- [22.14.7.2: Can I use DRBD with Xen and/or KVM?](#)

#### **Questions and Answers**

##### **22.14.7.1: Can I use DRBD with OpenVZ?**

See [http://wiki.openvz.org/HA\\_cluster\\_with\\_DRBD\\_and\\_Heartbeat](http://wiki.openvz.org/HA_cluster_with_DRBD_and_Heartbeat).

##### **22.14.7.2: Can I use DRBD with Xen and/or KVM?**

Yes. If you are looking for professional consultancy or expert commercial support for Xen- or KVM-based virtualization clusters with DRBD, contact LINBIT (<http://www.linbit.com>).

### **A.14.8. DRBD and Security**

In the following section, we provide answers to questions that are most frequently asked about DRBD and security.

#### **Questions**

- [22.14.8.1: Can I encrypt/compress the exchanged data?](#)
- [22.14.8.2: Does DRBD do mutual node authentication?](#)

#### **Questions and Answers**

##### **22.14.8.1: Can I encrypt/compress the exchanged data?**

Yes. But there is no option within DRBD to allow for this. You'll need to leverage a VPN and the network layer should do the rest.

##### **22.14.8.2: Does DRBD do mutual node authentication?**

Yes, starting with DRBD 8 shared-secret mutual node authentication is supported.

### **A.14.9. DRBD and System Requirements**

In the following section, we provide answers to questions that are most frequently asked about DRBD and System Requirements.

#### **Questions**

- [22.14.9.1: What other packages besides DRBD are required?](#)
- [22.14.9.2: How many machines are required to set up DRBD?](#)
- [22.14.9.3: Does DRBD only run on Linux?](#)

#### **Questions and Answers**

##### **22.14.9.1: What other packages besides DRBD are required?**

When using pre-built binary packages, none except a matching kernel, plus packages for `glibc` and your favorite shell. When

compiling DRBD from source additional prerequisite packages may be required. They include but are not limited to:

- glib-devel
- openssl
- devel
- libgcrypt-devel
- glib2-devel
- pkgconfig
- ncurses-devel
- rpm-build
- rpm-devel
- redhat-rpm-config
- gcc
- gcc-c++
- bison
- flex
- gnutls-devel
- lm\_sensors-devel
- net-snmp-devel
- python-devel
- bzip2-devel
- libselinux-devel
- perl-DBI
- libnet

Pre-built x86 and x86\_64 packages for specific kernel versions are available with a support subscription from LINBIT. Please note that if the kernel is upgraded, DRBD must be as well.

#### **22.14.9.2: How many machines are required to set up DRBD?**

Two machines are required to achieve the minimum degree of high availability. Although at any one given point in time one will be primary and one will be secondary, it is better to consider the machines as part of a mirrored pair without a “natural” primary machine.

#### **22.14.9.3: Does DRBD only run on Linux?**

DRBD is a Linux Kernel Module, and can work with many popular Linux distributions. DRBD is currently not available for non-Linux operating systems.

## **A.14.10. DRBD and Support and Consulting**

In the following section, we provide answers to questions that are most frequently asked about DRBD and resources.

### **Questions**

- [22.14.10.1](#): Does MySQL offer professional consulting to help with designing a DRBD system?
- [22.14.10.2](#): Does MySQL offer support for DRBD and Linux Heartbeat from MySQL?

- [22.14.10.3](#): Are pre-built binaries or RPMs available?
- [22.14.10.4](#): Does MySQL have documentation to help me with the installation and configuration of DRBD and Linux Heartbeat?
- [22.14.10.5](#): Is there a dedicated discussion forum for MySQL High-Availability?
- [22.14.10.6](#): Where can I get more information about MySQL for DRBD?

### Questions and Answers

#### **22.14.10.1: Does MySQL offer professional consulting to help with designing a DRBD system?**

Yes. MySQL offers consulting for the design, installation, configuration, and monitoring of high availability DRBD. For more information concerning a High Availability Jumpstart, please see: <http://www.mysql.com/consulting/packaged/scaleout.html>.

#### **22.14.10.2: Does MySQL offer support for DRBD and Linux Heartbeat from MySQL?**

Yes. Support for DRBD and Linux Heartbeat is available with an add-on subscription to MySQL Enterprise called “DRBD for MySQL”. For more information about support options for DRBD see: <http://mysql.com/products/enterprise/features.html>.

For the list of supported Linux distributions, please see: <http://www.mysql.com/support/supportedplatforms/enterprise.html>.

#### **Note**

DRBD is only available on Linux. DRBD is not available on Windows, MacOS, Solaris, HP-UX, AIX, FreeBSD, or other non-Linux platforms.

#### **22.14.10.3: Are pre-built binaries or RPMs available?**

Yes. “DRBD for MySQL” is an add-on subscription to MySQL Enterprise, which provides pre-built binaries for DRBD. For more information, see: <http://mysql.com/products/enterprise/features.html>.

#### **22.14.10.4: Does MySQL have documentation to help me with the installation and configuration of DRBD and Linux Heartbeat?**

For MySQL-specific DRBD documentation, see [Section 14.1, “Using MySQL with DRBD”](#).

For general DRBD documentation, see [DRBD User's Guide](#).

#### **22.14.10.5: Is there a dedicated discussion forum for MySQL High-Availability?**

Yes, <http://forums.mysql.com/list.php?144>.

#### **22.14.10.6: Where can I get more information about MySQL for DRBD?**

For more information about MySQL for DRBD, including a technical white paper please see: [DRBD for MySQL High Availability](#).



---

# Appendix B. Errors, Error Codes, and Common Problems

This appendix lists common problems and errors that may occur and potential resolutions, in addition to listing the errors that may appear when you call MySQL from any host language. The first section covers problems and resolutions. Detailed information on errors is provided; The first list displays server error messages. The second list displays client program messages.

## MySQL Enterprise

The MySQL Enterprise Monitor provides a “Virtual DBA” to assist with problem solving. For more information, see <http://www.mysql.com/products/enterprise/advisors.html>.

## B.1. Problems and Common Errors

This section lists some common problems and error messages that you may encounter. It describes how to determine the causes of the problems and what to do to solve them.

### B.1.1. How to Determine What Is Causing a Problem

When you run into a problem, the first thing you should do is to find out which program or piece of equipment is causing it:

- If you have one of the following symptoms, then it is probably a hardware problems (such as memory, motherboard, CPU, or hard disk) or kernel problem:
  - The keyboard doesn't work. This can normally be checked by pressing the Caps Lock key. If the Caps Lock light doesn't change, you have to replace your keyboard. (Before doing this, you should try to restart your computer and check all cables to the keyboard.)
  - The mouse pointer doesn't move.
  - The machine doesn't answer to a remote machine's pings.
  - Other programs that are not related to MySQL don't behave correctly.
  - Your system restarted unexpectedly. (A faulty user-level program should never be able to take down your system.)

In this case, you should start by checking all your cables and run some diagnostic tool to check your hardware! You should also check whether there are any patches, updates, or service packs for your operating system that could likely solve your problem. Check also that all your libraries (such as `glibc`) are up to date.

It is always good to use a machine with ECC memory to discover memory problems early.

- If your keyboard is locked up, you may be able to recover by logging in to your machine from another machine and executing `kbd_mode -a`.
- Please examine your system log file (`/var/log/messages` or similar) for reasons for your problem. If you think the problem is in MySQL, you should also examine MySQL's log files. See [Section 5.2, “MySQL Server Logs”](#).
- If you don't think you have hardware problems, you should try to find out which program is causing problems. Try using `top`, `ps`, Task Manager, or some similar program, to check which program is taking all CPU or is locking the machine.
- Use `top`, `df`, or a similar program to check whether you are out of memory, disk space, file descriptors, or some other critical resource.
- If the problem is some runaway process, you can always try to kill it. If it doesn't want to die, there is probably a bug in the operating system.

If after you have examined all other possibilities and you have concluded that the MySQL server or a MySQL client is causing the problem, it is time to create a bug report for our mailing list or our support team. In the bug report, try to give a very detailed description of how the system is behaving and what you think is happening. You should also state why you think that MySQL is causing the problem. Take into consideration all the situations in this chapter. State any problems exactly how they appear when you examine your system. Use the “copy and paste” method for any output and error messages from programs and log files.

Try to describe in detail which program is not working and all symptoms you see. We have in the past received many bug reports that state only “the system doesn't work.” This doesn't provide us with any information about what could be the problem.

If a program fails, it is always useful to know the following information:

- Has the program in question made a segmentation fault (did it dump core)?
- Is the program taking up all available CPU time? Check with `top`. Let the program run for a while, it may simply be evaluating something computationally intensive.
- If the `mysqld` server is causing problems, can you get any response from it with `mysqladmin -u root ping` or `mysqladmin -u root processlist`?
- What does a client program say when you try to connect to the MySQL server? (Try with `mysql`, for example.) Does the client jam? Do you get any output from the program?

When sending a bug report, you should follow the outline described in [Section 1.6, “How to Report Bugs or Problems”](#).

## B.1.2. Common Errors When Using MySQL Programs

This section lists some errors that users frequently encounter when running MySQL programs. Although the problems show up when you try to run client programs, the solutions to many of the problems involves changing the configuration of the MySQL server.

### B.1.2.1. Access denied

An `Access denied` error can have many causes. Often the problem is related to the MySQL accounts that the server allows client programs to use when connecting. See [Section 5.4, “The MySQL Access Privilege System”](#), and [Section 5.4.7, “Causes of Access-Denied Errors”](#).

### B.1.2.2. Can't connect to [local] MySQL server

A MySQL client on Unix can connect to the `mysqld` server in two different ways: By using a Unix socket file to connect through a file in the file system (default `/tmp/mysql.sock`), or by using TCP/IP, which connects through a port number. A Unix socket file connection is faster than TCP/IP, but can be used only when connecting to a server on the same computer. A Unix socket file is used if you don't specify a host name or if you specify the special host name `localhost`.

If the MySQL server is running on Windows, you can connect via TCP/IP. If the server is started with the `-enable-named-pipe` option, you can also connect with named pipes if you run the client on the host where the server is running. The name of the named pipe is `MySQL` by default. If you don't give a host name when connecting to `mysqld`, a MySQL client first tries to connect to the named pipe. If that doesn't work, it connects to the TCP/IP port. You can force the use of named pipes on Windows by using `.` as the host name.

The error (2002) `Can't connect to ...` normally means that there is no MySQL server running on the system or that you are using an incorrect Unix socket file name or TCP/IP port number when trying to connect to the server. You should also check that the TCP/IP port you are using has not been blocked by a firewall or port blocking service.

The error (2003) `Can't connect to MySQL server on 'server' (10061)` indicates that the network connection has been refused. You should check that there is a MySQL server running, that it has network connections enabled, and that the network port you specified is the one configured on the server.

Start by checking whether there is a process named `mysqld` running on your server host. (Use `ps xa | grep mysqld` on Unix or the Task Manager on Windows.) If there is no such process, you should start the server. See [Section 2.11.2.3, “Starting and Troubleshooting the MySQL Server”](#).

If a `mysqld` process is running, you can check it by trying the following commands. The port number or Unix socket file name might be different in your setup. `host_ip` represents the IP number of the machine where the server is running.

```
shell> mysqladmin version
shell> mysqladmin variables
shell> mysqladmin -h `hostname` version variables
shell> mysqladmin -h `hostname` --port=3306 version
shell> mysqladmin -h host_ip version
shell> mysqladmin --protocol=SOCKET --socket=/tmp/mysql.sock version
```

Note the use of backticks rather than forward quotes with the `hostname` command; these cause the output of `hostname` (that is, the current host name) to be substituted into the `mysqladmin` command. If you have no `hostname` command or are running on Windows, you can manually type the host name of your machine (without backticks) following the `-h` option. You can also try `-h 127.0.0.1` to connect with TCP/IP to the local host.

Make sure that the server has not been configured to ignore network connections or (if you are attempting to connect remotely) that it has not been configured to listen only locally on its network interfaces. If the server was started with `--skip-networking`, it will not accept TCP/IP connections at all. If the server was started with `--bind-address=127.0.0.1`, it will listen for TCP/IP connections only locally on the loopback interface and will not accept remote connections.

Check to make sure that there is no firewall blocking access to MySQL. Your firewall may be configured on the basis of the application being executed, or the port number used by MySQL for communication (3306 by default). Under Linux or Unix, check your IP tables (or similar) configuration to ensure that the port has not been blocked. Under Windows, applications such as ZoneAlarm or the Windows XP personal firewall may need to be configured not to block the MySQL port.

Here are some reasons the `Can't connect to local MySQL server` error might occur:

- `mysqld` is not running on the local host. Check your operating system's process list to ensure the `mysqld` process is present.
- You're running a MySQL server on Windows with many TCP/IP connections to it. If you're experiencing that quite often your clients get that error, you can find a workaround here: [Section B.1.2.2.1, "Connection to MySQL Server Failing on Windows"](#).
- You are running on a system that uses MIT-pthreads. If you are running on a system that doesn't have native threads, `mysqld` uses the MIT-pthreads package. See [Section 2.1.1, "Operating Systems Supported by MySQL Community Server"](#). However, not all MIT-pthreads versions support Unix socket files. On a system without socket file support, you must always specify the host name explicitly when connecting to the server. Try using this command to check the connection to the server:

```
shell> mysqladmin -h `hostname` version
```

- Someone has removed the Unix socket file that `mysqld` uses (`/tmp/mysql.sock` by default). For example, you might have a `cron` job that removes old files from the `/tmp` directory. You can always run `mysqladmin version` to check whether the Unix socket file that `mysqladmin` is trying to use really exists. The fix in this case is to change the `cron` job to not remove `mysql.sock` or to place the socket file somewhere else. See [Section B.1.4.5, "How to Protect or Change the MySQL Unix Socket File"](#).
- You have started the `mysqld` server with the `--socket=/path/to/socket` option, but forgotten to tell client programs the new name of the socket file. If you change the socket path name for the server, you must also notify the MySQL clients. You can do this by providing the same `--socket` option when you run client programs. You also need to ensure that clients have permission to access the `mysql.sock` file. To find out where the socket file is, you can do:

```
shell> netstat -ln | grep mysql
```

See [Section B.1.4.5, "How to Protect or Change the MySQL Unix Socket File"](#).

- You are using Linux and one server thread has died (dumped core). In this case, you must kill the other `mysqld` threads (for example, with `kill` or with the `mysql_zap` script) before you can restart the MySQL server. See [Section B.1.4.2, "What to Do If MySQL Keeps Crashing"](#).
- The server or client program might not have the proper access privileges for the directory that holds the Unix socket file or the socket file itself. In this case, you must either change the access privileges for the directory or socket file so that the server and clients can access them, or restart `mysqld` with a `--socket` option that specifies a socket file name in a directory where the server can create it and where client programs can access it.

If you get the error message `Can't connect to MySQL server on some_host`, you can try the following things to find out what the problem is:

- Check whether the server is running on that host by executing `telnet some_host 3306` and pressing the Enter key a couple of times. (3306 is the default MySQL port number. Change the value if your server is listening to a different port.) If there is a MySQL server running and listening to the port, you should get a response that includes the server's version number. If you get an error such as `telnet: Unable to connect to remote host: Connection refused`, then there is no server running on the given port.
- If the server is running on the local host, try using `mysqladmin -h localhost variables` to connect using the Unix socket file. Verify the TCP/IP port number that the server is configured to listen to (it is the value of the `port` variable.)
- If you are running under Linux and Security-Enhanced Linux (SELinux) is enabled, make sure you have disabled SELinux protection for the `mysqld` process.

### B.1.2.2.1. Connection to MySQL Server Failing on Windows

When you're running a MySQL server on Windows with many TCP/IP connections to it, and you're experiencing that quite often your clients get a `Can't connect to MySQL server` error, the reason might be that Windows doesn't allow for enough ephemeral (short-lived) ports to serve those connections.

By default, Windows allows 5000 ephemeral (short-lived) TCP ports to the user. After any port is closed it will remain in a

`TIME_WAIT` status for 120 seconds. This status allows the connection to be reused at a much lower cost than reinitializing a brand new connection. However, the port will not be available again until this time expires.

With a small stack of available TCP ports (5000) and a high number of TCP ports being open and closed over a short period of time along with the `TIME_WAIT` status you have a good chance for running out of ports. There are two ways to address this problem:

- Reduce the number of TCP ports consumed quickly by investigating connection pooling or persistent connections where possible
- Tune some settings in the Windows registry (see below)

**IMPORTANT: The following procedure involves modifying the Windows registry. Before you modify the registry, make sure to back it up and make sure that you understand how to restore the registry if a problem occurs. For information about how to back up, restore, and edit the registry, view the following article in the Microsoft Knowledge Base: <http://support.microsoft.com/kb/256986/EN-US/>.**

1. Start Registry Editor (`Regedt32.exe`).
2. Locate the following key in the registry:

```
HKEY_LOCAL_MACHINE\SYSTEM\CurrentControlSet\Services\Tcpip\Parameters
```

3. On the `Edit` menu, click `Add Value`, and then add the following registry value:

```
Value Name: MaxUserPort
Data Type: REG_DWORD
Value: 65534
```

This sets the number of ephemeral ports available to any user. The valid range is between 5000 and 65534 (decimal). The default value is 0x1388 (5000 decimal).

4. On the `Edit` menu, click `Add Value`, and then add the following registry value:

```
Value Name: TcpTimedWaitDelay
Data Type: REG_DWORD
Value: 30
```

This sets the number of seconds to hold a TCP port connection in `TIME_WAIT` state before closing. The valid range is between 0 (zero) and 300 (decimal). The default value is 0x78 (120 decimal).

5. Quit Registry Editor.
6. Reboot the machine.

Note: Undoing the above should be as simple as deleting the registry entries you've created.

### B.1.2.3. Lost connection to MySQL server

There are three likely causes for this error message.

Usually it indicates network connectivity trouble and you should check the condition of your network if this error occurs frequently. If the error message includes “during query,” this is probably the case you are experiencing.

Sometimes the “during query” form happens when millions of rows are being sent as part of one or more queries. If you know that this is happening, you should try increasing `net_read_timeout` from its default of 30 seconds to 60 seconds or longer, sufficient for the data transfer to complete.

More rarely, it can happen when the client is attempting the initial connection to the server. In this case, if your `connect_timeout` value is set to only a few seconds, you may be able to resolve the problem by increasing it to ten seconds, perhaps more if you have a very long distance or slow connection. You can determine whether you are experiencing this more uncommon cause by using `SHOW GLOBAL STATUS LIKE 'Aborted_connects'`. It will increase by one for each initial connection attempt that the server aborts. You may see “reading authorization packet” as part of the error message; if so, that also suggests that this is the solution that you need.

If the cause is none of those just described, you may be experiencing a problem with `BLOB` values that are larger than `max_allowed_packet`, which can cause this error with some clients. Sometime you may see “packet too large” as part of the error message, and that confirms that you need to increase `max_allowed_packet`.

### B.1.2.4. Client does not support authentication protocol

MySQL 5.1 uses an authentication protocol based on a password hashing algorithm that is incompatible with that used by older (pre-4.1) clients. If you upgrade the server from 4.0, attempts to connect to it with an older client may fail with the following message:

```
shell> mysql
Client does not support authentication protocol requested
by server; consider upgrading MySQL client
```

To solve this problem, you should use one of the following approaches:

- Upgrade all client programs to use a 4.1.1 or newer client library.
- When connecting to the server with a pre-4.1 client program, use an account that still has a pre-4.1-style password.
- Reset the password to pre-4.1 style for each user that needs to use a pre-4.1 client program. This can be done using the `SET PASSWORD` statement and the `OLD_PASSWORD()` function:

```
mysql> SET PASSWORD FOR
-> 'some_user'@'some_host' = OLD_PASSWORD('newpwd');
```

Alternatively, use `UPDATE` and `FLUSH PRIVILEGES`:

```
mysql> UPDATE mysql.user SET Password = OLD_PASSWORD('newpwd')
-> WHERE Host = 'some_host' AND User = 'some_user';
mysql> FLUSH PRIVILEGES;
```

Substitute the password you want to use for “`newpwd`” in the preceding examples. MySQL cannot tell you what the original password was, so you’ll need to pick a new one.

- Tell the server to use the older password hashing algorithm:
  1. Start `mysqld` with the `--old-passwords` option.
  2. Assign an old-format password to each account that has had its password updated to the longer 4.1 format. You can identify these accounts with the following query:

```
mysql> SELECT Host, User, Password FROM mysql.user
-> WHERE LENGTH>Password) > 16;
```

For each account record displayed by the query, use the `Host` and `User` values and assign a password using the `OLD_PASSWORD()` function and either `SET PASSWORD` or `UPDATE`, as described earlier.

#### Note

In older versions of PHP, the `mysql` extension does not support the authentication protocol in MySQL 4.1.1 and higher. This is true regardless of the PHP version being used. If you wish to use the `mysql` extension with MySQL 4.1 or newer, you may need to follow one of the options discussed above for configuring MySQL to work with old clients. The `mysqli` extension (stands for “MySQL, Improved”; added in PHP 5) is compatible with the improved password hashing employed in MySQL 4.1 and higher, and no special configuration of MySQL need be done to use this MySQL client library. For more information about the `mysqli` extension, see <http://php.net/mysqli>.

It may also be possible to compile the older `mysql` extension against the new MySQL client library. This is beyond the scope of this Manual; consult the PHP documentation for more information. You also be able to obtain assistance with these issues in our [MySQL with PHP forum](#).

For additional background on password hashing and authentication, see [Section 5.5.6.3, “Password Hashing in MySQL”](#).

### B.1.2.5. Password Fails When Entered Interactively

MySQL client programs prompt for a password when invoked with a `--password` or `-p` option that has no following password value:

```
shell> mysql -u user_name -p
Enter password:
```

On some systems, you may find that your password works when specified in an option file or on the command line, but not when

you enter it interactively at the `Enter password:` prompt. This occurs when the library provided by the system to read passwords limits password values to a small number of characters (typically eight). That is a problem with the system library, not with MySQL. To work around it, change your MySQL password to a value that is eight or fewer characters long, or put your password in an option file.

### B.1.2.6. Host '`host_name`' is blocked

If you get the following error, it means that `mysqld` has received many connect requests from the host '`host_name`' that have been interrupted in the middle:

```
Host 'host_name' is blocked because of many connection errors.
Unblock with 'mysqladmin flush-hosts'
```

The number of interrupted connect requests allowed is determined by the value of the `max_connect_errors` system variable. After `max_connect_errors` failed requests, `mysqld` assumes that something is wrong (for example, that someone is trying to break in), and blocks the host from further connections until you execute a `mysqladmin flush-hosts` command or issue a `FLUSH HOSTS` statement. See [Section 5.1.3, “Server System Variables”](#).

By default, `mysqld` blocks a host after 10 connection errors. You can adjust the value by starting the server like this:

```
shell> mysqld_safe --max_connect_errors=10000 &
```

If you get this error message for a given host, you should first verify that there isn't anything wrong with TCP/IP connections from that host. If you are having network problems, it does you no good to increase the value of the `max_connect_errors` variable.

### B.1.2.7. Too many connections

If you get a `Too many connections` error when you try to connect to the `mysqld` server, this means that all available connections are in use by other clients.

The number of connections allowed is controlled by the `max_connections` system variable. Beginning with MySQL 5.1.15, its default value is 151 to improve performance when MySQL is used with the Apache Web server. (Previously, the default was 100.) If you need to support more connections, you should set a larger value for this variable.

#### MySQL Enterprise

Subscribers to the MySQL Enterprise Monitor receive advice on dynamically configuring the `max_connections` variable — avoiding failed connection attempts. For more information, see <http://www.mysql.com/products/enterprise/advisors.html>.

`mysqld` actually allows `max_connections+1` clients to connect. The extra connection is reserved for use by accounts that have the `SUPER` privilege. By granting the `SUPER` privilege to administrators and not to normal users (who should not need it), an administrator can connect to the server and use `SHOW PROCESSLIST` to diagnose problems even if the maximum number of unprivileged clients are connected. See [Section 12.5.5.31, “SHOW PROCESSLIST Syntax”](#).

The maximum number of connections MySQL can support depends on the quality of the thread library on a given platform. Linux or Solaris should be able to support 500-1000 simultaneous connections, depending on how much RAM you have and what your clients are doing. Static Linux binaries provided by Sun Microsystems, Inc. can support up to 4000 connections.

### B.1.2.8. Out of memory

If you issue a query using the `mysql` client program and receive an error like the following one, it means that `mysql` does not have enough memory to store the entire query result:

```
mysql: Out of memory at line 42, 'malloc.c'
mysql: needed 8136 byte (8k), memory in use: 12481367 bytes (12189k)
ERROR 2008: MySQL client ran out of memory
```

To remedy the problem, first check whether your query is correct. Is it reasonable that it should return so many rows? If not, correct the query and try again. Otherwise, you can invoke `mysql` with the `--quick` option. This causes it to use the `mysql_use_result()` C API function to retrieve the result set, which places less of a load on the client (but more on the server).

### B.1.2.9. MySQL server has gone away

This section also covers the related `Lost connection to server during query` error.

The most common reason for the `MySQL server has gone away` error is that the server timed out and closed the connection. In this case, you normally get one of the following error codes (which one you get is operating system-dependent).



Error Code	Description
<code>CR_SERVER_GONE_ERROR</code>	The client couldn't send a question to the server.
<code>CR_SERVER_LOST</code>	The client didn't get an error when writing to the server, but it didn't get a full answer (or any answer) to the question.

By default, the server closes the connection after eight hours if nothing has happened. You can change the time limit by setting the `wait_timeout` variable when you start `mysqld`. See [Section 5.1.3, “Server System Variables”](#).

If you have a script, you just have to issue the query again for the client to do an automatic reconnection. This assumes that you have automatic reconnection in the client enabled (which is the default for the `mysql` command-line client).

Some other common reasons for the `MySQL server has gone away` error are:

- You (or the db administrator) has killed the running thread with a `KILL` statement or a `mysqladmin kill` command.
- You tried to run a query after closing the connection to the server. This indicates a logic error in the application that should be corrected.
- A client application running on a different host does not have the necessary privileges to connect to the MySQL server from that host.
- You got a timeout from the TCP/IP connection on the client side. This may happen if you have been using the commands: `mysql_options(..., MYSQL_OPT_READ_TIMEOUT, ...)` or `mysql_options(..., MYSQL_OPT_WRITE_TIMEOUT, ...)`. In this case increasing the timeout may help solve the problem.
- You have encountered a timeout on the server side and the automatic reconnection in the client is disabled (the `reconnect` flag in the `MYSQL` structure is equal to 0).
- You are using a Windows client and the server had dropped the connection (probably because `wait_timeout` expired) before the command was issued.

The problem on Windows is that in some cases MySQL doesn't get an error from the OS when writing to the TCP/IP connection to the server, but instead gets the error when trying to read the answer from the connection.

Prior to MySQL 5.1.8, even if the `reconnect` flag in the `MYSQL` structure is equal to 1, MySQL does not automatically reconnect and re-issue the query as it doesn't know if the server did get the original query or not.

The solution to this is to either do a `mysql_ping()` on the connection if there has been a long time since the last query (this is what `MyODBC` does) or set `wait_timeout` on the `mysqld` server so high that it in practice never times out.

- You can also get these errors if you send a query to the server that is incorrect or too large. If `mysqld` receives a packet that is too large or out of order, it assumes that something has gone wrong with the client and closes the connection. If you need big queries (for example, if you are working with big `BLOB` columns), you can increase the query limit by setting the server's `max_allowed_packet` variable, which has a default value of 1MB. You may also need to increase the maximum packet size on the client end. More information on setting the packet size is given in [Section B.1.2.10, “Packet too large”](#).

An `INSERT` or `REPLACE` statement that inserts a great many rows can also cause these sorts of errors. Either one of these statements sends a single request to the server irrespective of the number of rows to be inserted; thus, you can often avoid the error by reducing the number of rows sent per `INSERT` or `REPLACE`.

- You also get a lost connection if you are sending a packet 16MB or larger if your client is older than 4.0.8 and your server is 4.0.8 and above, or the other way around.
- It is also possible to see this error if host name lookups fail (for example, if the DNS server on which your server or network relies goes down). This is because MySQL is dependent on the host system for name resolution, but has no way of knowing whether it is working — from MySQL's point of view the problem is indistinguishable from any other network timeout.

You may also see the `MySQL server has gone away` error if MySQL is started with the `--skip-networking` option.

Another networking issue that can cause this error occurs if the MySQL port (default 3306) is blocked by your firewall, thus preventing any connections at all to the MySQL server.

- You can also encounter this error with applications that fork child processes, all of which try to use the same connection to the MySQL server. This can be avoided by using a separate connection for each child process.
- You have encountered a bug where the server died while executing the query.

You can check whether the MySQL server died and restarted by executing `mysqladmin version` and examining the server's uptime. If the client connection was broken because `mysqld` crashed and restarted, you should concentrate on finding the reason for the crash. Start by checking whether issuing the query again kills the server again. See [Section B.1.4.2, “What to Do If MySQL Keeps Crashing”](#).

You can get more information about the lost connections by starting `mysqld` with the `--log-warnings=2` option. This logs some of the disconnected errors in the `hostname.err` file. See [Section 5.2.2, “The Error Log”](#).

If you want to create a bug report regarding this problem, be sure that you include the following information:

- Indicate whether the MySQL server died. You can find information about this in the server error log. See [Section B.1.4.2, “What to Do If MySQL Keeps Crashing”](#).
- If a specific query kills `mysqld` and the tables involved were checked with `CHECK TABLE` before you ran the query, can you provide a reproducible test case? See [MySQL Internals: Porting](#).
- What is the value of the `wait_timeout` system variable in the MySQL server? (`mysqladmin variables` gives you the value of this variable.)
- Have you tried to run `mysqld` with the general query log enabled to determine whether the problem query appears in the log? (See [Section 5.2.3, “The General Query Log”](#).)

See also [Section B.1.2.11, “Communication Errors and Aborted Connections”](#), and [Section 1.6, “How to Report Bugs or Problems”](#).

### B.1.2.10. Packet too large

A communication packet is a single SQL statement sent to the MySQL server, a single row that is sent to the client, or a binary log event sent from a master replication server to a slave.

The largest possible packet that can be transmitted to or from a MySQL 5.1 server or client is 1GB.

When a MySQL client or the `mysqld` server receives a packet bigger than `max_allowed_packet` bytes, it issues a `Packet too large` error and closes the connection. With some clients, you may also get a `Lost connection to MySQL server during query` error if the communication packet is too large.

Both the client and the server have their own `max_allowed_packet` variable, so if you want to handle big packets, you must increase this variable both in the client and in the server.

If you are using the `mysql` client program, its default `max_allowed_packet` variable is 16MB. To set a larger value, start `mysql` like this:

```
shell> mysql --max_allowed_packet=32M
```

That sets the packet size to 32MB.

The server's default `max_allowed_packet` value is 1MB. You can increase this if the server needs to handle big queries (for example, if you are working with big BLOB columns). For example, to set the variable to 16MB, start the server like this:

```
shell> mysqld --max_allowed_packet=16M
```

You can also use an option file to set `max_allowed_packet`. For example, to set the size for the server to 16MB, add the following lines in an option file:

```
[mysqld]
max_allowed_packet=16M
```

It is safe to increase the value of this variable because the extra memory is allocated only when needed. For example, `mysqld` allocates more memory only when you issue a long query or when `mysqld` must return a large result row. The small default value of the variable is a precaution to catch incorrect packets between the client and server and also to ensure that you do not run out of memory by using large packets accidentally.

You can also get strange problems with large packets if you are using large BLOB values but have not given `mysqld` access to enough memory to handle the query. If you suspect this is the case, try adding `ulimit -d 256000` to the beginning of the `mysqld_safe` script and restarting `mysqld`.

### B.1.2.11. Communication Errors and Aborted Connections



The server error log can be a useful source of information about connection problems. See [Section 5.2.2, “The Error Log”](#). If you start the server with the `--log-warnings` option, you might find messages like this in your error log:

```
010301 14:38:23 Aborted connection 854 to db: 'users' user: 'josh'
```

If a client successfully connects but later disconnects improperly or is terminated, the server increments the `Aborted_clients` status variable, and logs an `ABORTED CONNECTION` message to the error log. The cause can be any of the following:

- The client program did not call `mysql_close()` before exiting.
- The client had been sleeping more than `wait_timeout` or `interactive_timeout` seconds without issuing any requests to the server. See [Section 5.1.3, “Server System Variables”](#).
- The client program ended abruptly in the middle of a data transfer.

If a client is unable even to connect, the server increments the `Aborted_connects` status variable. Unsuccessful connect attempts can occur for the following reasons:

- A client doesn't have privileges to connect to a database.
- A client uses an incorrect password.
- A connection packet doesn't contain the right information.
- It takes more than `connect_timeout` seconds to get a connect packet. See [Section 5.1.3, “Server System Variables”](#).

If these kinds of things happen, it might indicate that someone is trying to break into your server! Messages for these types of problems are logged to the general query log if it is enabled.

#### MySQL Enterprise

For reasons of security and performance the advisors provided by the MySQL Enterprise Monitor pay special attention to the `Aborted_connects` status variable. For more information, see <http://www.mysql.com/products/enterprise/advisors.html>.

Other reasons for problems with aborted clients or aborted connections:

- Use of Ethernet protocol with Linux, both half and full duplex. Many Linux Ethernet drivers have this bug. You should test for this bug by transferring a huge file via FTP between the client and server machines. If a transfer goes in burst-pause-burst-pause mode, you are experiencing a Linux duplex syndrome. The only solution is switching the duplex mode for both your network card and hub/switch to either full duplex or to half duplex and testing the results to determine the best setting.
- Some problem with the thread library that causes interrupts on reads.
- Badly configured TCP/IP.
- Faulty Ethernets, hubs, switches, cables, and so forth. This can be diagnosed properly only by replacing hardware.
- The `max_allowed_packet` variable value is too small or queries require more memory than you have allocated for `mysqld`. See [Section B.1.2.10, “Packet too large”](#).

See also [Section B.1.2.9, “MySQL server has gone away”](#).

### B.1.2.12. The table is full

The effective maximum table size for MySQL databases is usually determined by operating system constraints on file sizes, not by MySQL internal limits. The following table lists some examples of operating system file-size limits. This is only a rough guide and is not intended to be definitive. For the most up-to-date information, be sure to check the documentation specific to your operating system.

Operating System	File-size Limit
Win32 w/ FAT/FAT32	2GB/4GB
Win32 w/ NTFS	2TB (possibly larger)
Linux 2.2-Intel 32-bit	2GB (LFS: 4GB)

Linux 2.4+	(using ext3 file system) 4TB
Solaris 9/10	16TB
MacOS X w/ HFS+	2TB
NetWare w/NSS file system	8TB

Windows users, please note that FAT and VFAT (FAT32) are *not* considered suitable for production use with MySQL. Use NTFS instead.

On Linux 2.2, you can get [MyISAM](#) tables larger than 2GB in size by using the Large File Support (LFS) patch for the ext2 file system. Most current Linux distributions are based on kernel 2.4 or higher and include all the required LFS patches. On Linux 2.4, patches also exist for ReiserFS to get support for big files (up to 2TB). With JFS and XFS, petabyte and larger files are possible on Linux.

For a detailed overview about LFS in Linux, have a look at Andreas Jaeger's *Large File Support in Linux* page at [http://www.suse.de/~aj/linux\\_lfs.html](http://www.suse.de/~aj/linux_lfs.html).

If you do encounter a full-table error, there are several reasons why it might have occurred:

- The [InnoDB](#) storage engine maintains [InnoDB](#) tables within a tablespace that can be created from several files. This allows a table to exceed the maximum individual file size. The tablespace can include raw disk partitions, which allows extremely large tables. The maximum tablespace size is 64TB.

If you are using [InnoDB](#) tables and run out of room in the [InnoDB](#) tablespace. In this case, the solution is to extend the [InnoDB](#) tablespace. See [Section 13.6.5, “Adding, Removing, or Resizing InnoDB Data and Log Files”](#).

- You are using [MyISAM](#) tables on an operating system that supports files only up to 2GB in size and you have hit this limit for the data file or index file.
- You are using a [MyISAM](#) table and the space required for the table exceeds what is allowed by the internal pointer size. [MyISAM](#) allows data and index files to grow up to 256TB by default, but this limit can be changed up to the maximum allowable size of 65,536TB ( $256^7 - 1$  bytes).

If you need a [MyISAM](#) table that is larger than the default limit and your operating system supports large files, the [CREATE TABLE](#) statement supports [AVG\\_ROW\\_LENGTH](#) and [MAX\\_ROWS](#) options. See [Section 12.1.17, “CREATE TABLE Syntax”](#). The server uses these options to determine how large a table to allow.

If the pointer size is too small for an existing table, you can change the options with [ALTER TABLE](#) to increase a table's maximum allowable size. See [Section 12.1.7, “ALTER TABLE Syntax”](#).

```
ALTER TABLE tbl_name MAX_ROWS=1000000000 AVG_ROW_LENGTH=nnn;
```

You have to specify [AVG\\_ROW\\_LENGTH](#) only for tables with [BLOB](#) or [TEXT](#) columns; in this case, MySQL can't optimize the space required based only on the number of rows.

To change the default size limit for [MyISAM](#) tables, set the [mysam\\_data\\_pointer\\_size](#), which sets the number of bytes used for internal row pointers. The value is used to set the pointer size for new tables if you do not specify the [MAX\\_ROWS](#) option. The value of [mysam\\_data\\_pointer\\_size](#) can be from 2 to 7. A value of 4 allows tables up to 4GB; a value of 6 allows tables up to 256TB.

You can check the maximum data and index sizes by using this statement:

```
SHOW TABLE STATUS FROM db_name LIKE 'tbl_name';
```

You also can use [mysamchk -dv /path/to/table-index-file](#). See [Section 12.5.5, “SHOW Syntax”](#), or [Section 4.6.3, “mysamchk — MyISAM Table-Maintenance Utility”](#).

Other ways to work around file-size limits for [MyISAM](#) tables are as follows:

- If your large table is read only, you can use [mysampack](#) to compress it. [mysampack](#) usually compresses a table by at least 50%, so you can have, in effect, much bigger tables. [mysampack](#) also can merge multiple tables into a single table. See [Section 4.6.5, “mysampack — Generate Compressed, Read-Only MyISAM Tables”](#).
- MySQL includes a [MERGE](#) library that allows you to handle a collection of [MyISAM](#) tables that have identical structure as a single [MERGE](#) table. See [Section 13.7, “The MERGE Storage Engine”](#).
- You are using the [NDB](#) storage engine, in which case you need to increase the values for the [DataMemory](#) and [In-](#)

`dexMemory` configuration parameters in your `config.ini` file. See [MySQL Cluster Data Node Configuration Parameters](#).

- You are using the `MEMORY (HEAP)` storage engine; in this case you need to increase the value of the `max_heap_table_size` system variable. See [Section 5.1.3, “Server System Variables”](#).

### B.1.2.13. Can't create/write to file

If you get an error of the following type for some queries, it means that MySQL cannot create a temporary file for the result set in the temporary directory:

```
Can't create/write to file '\sqla3fe_0.ism'.
```

The preceding error is a typical message for Windows; the Unix message is similar.

One fix is to start `mysqld` with the `--tmpdir` option or to add the option to the `[mysqld]` section of your option file. For example, to specify a directory of `C:\temp`, use these lines:

```
[mysqld]
tmpdir=C:/temp
```

The `C:\temp` directory must exist and have sufficient space for the MySQL server to write to. See [Section 4.2.3.2, “Using Option Files”](#).

Another cause of this error can be permissions issues. Make sure that the MySQL server can write to the `tmpdir` directory.

Check also the error code that you get with `pererror`. One reason the server cannot write to a table is that the file system is full:

```
shell> pererror 28
OS error code 28: No space left on device
```

If you get an error of the following type during startup, it indicates that the file system and/or directory used for storing data files is write protected. Providing the write error is to a test file, This error is not serious and can be safely ignored.

```
Can't create test file /usr/local/mysql/data/master.lower-test
```

### B.1.2.14. Commands out of sync

If you get `Commands out of sync; you can't run this command now` in your client code, you are calling client functions in the wrong order.

This can happen, for example, if you are using `mysql_use_result()` and try to execute a new query before you have called `mysql_free_result()`. It can also happen if you try to execute two queries that return data without calling `mysql_use_result()` or `mysql_store_result()` in between.

### B.1.2.15. Ignoring user

If you get the following error, it means that when `mysqld` was started or when it reloaded the grant tables, it found an account in the `user` table that had an invalid password.

```
Found wrong password for user 'some_user'@'some_host'; ignoring user
```

As a result, the account is simply ignored by the permission system.

The following list indicates possible causes of and fixes for this problem:

- You may be running a new version of `mysqld` with an old `user` table. You can check this by executing `mysqlshow mysql user` to see whether the `Password` column is shorter than 16 characters. If so, you can correct this condition by running the `scripts/add_long_password` script.
- The account has an old password (eight characters long). Update the account in the `user` table to have a new password.
- You have specified a password in the `user` table without using the `PASSWORD()` function. Use `mysql` to update the account in the `user` table with a new password, making sure to use the `PASSWORD()` function:

```
mysql> UPDATE user SET Password=PASSWORD('newpwd')
-> WHERE User='some_user' AND Host='some_host';
```

### B.1.2.16. Table '*tbl\_name*' doesn't exist

If you get either of the following errors, it usually means that no table exists in the default database with the given name:

```
Table 'tbl_name' doesn't exist
Can't find file: 'tbl_name' (errno: 2)
```

In some cases, it may be that the table does exist but that you are referring to it incorrectly:

- Because MySQL uses directories and files to store databases and tables, database and table names are case sensitive if they are located on a file system that has case-sensitive file names.
- Even for file systems that are not case sensitive, such as on Windows, all references to a given table within a query must use the same lettercase.

You can check which tables are in the default database with `SHOW TABLES`. See [Section 12.5.5, “SHOW Syntax”](#).

### B.1.2.17. Can't initialize character set

You might see an error like this if you have character set problems:

```
MySQL Connection Failed: Can't initialize character set charset_name
```

This error can have any of the following causes:

- The character set is a multi-byte character set and you have no support for the character set in the client. In this case, you need to recompile the client by running `configure` with the `--with-charset=charset_name` or `role="configure"--with-extra-charsets=charset_name` option. See [Section 2.10.2, “Typical configure Options”](#).

All standard MySQL binaries are compiled with `--with-extra-charsets=complex`, which enables support for all multi-byte character sets. See [Section 9.2, “The Character Set Used for Data and Sorting”](#).

- The character set is a simple character set that is not compiled into `mysqld`, and the character set definition files are not in the place where the client expects to find them.

In this case, you need to use one of the following methods to solve the problem:

- Recompile the client with support for the character set. See [Section 2.10.2, “Typical configure Options”](#).
- Specify to the client the directory where the character set definition files are located. For many clients, you can do this with the `--character-sets-dir` option.
- Copy the character definition files to the path where the client expects them to be.

### B.1.2.18. '*FILE*' NOT FOUND and Similar Errors

If you get `ERROR '...' not found (errno: 23), Can't open file: ... (errno: 24)`, or any other error with `errno 23` or `errno 24` from MySQL, it means that you haven't allocated enough file descriptors for the MySQL server. You can use the `pererror` utility to get a description of what the error number means:

```
shell> pererror 23
OS error code 23: File table overflow
shell> pererror 24
OS error code 24: Too many open files
shell> pererror 11
OS error code 11: Resource temporarily unavailable
```

The problem here is that `mysqld` is trying to keep open too many files simultaneously. You can either tell `mysqld` not to open so many files at once or increase the number of file descriptors available to `mysqld`.

To tell `mysqld` to keep open fewer files at a time, you can make the table cache smaller by reducing the value of the `table_open_cache` system variable (the default value is 64). Reducing the value of `max_connections` also reduces the number of open files (the default value is 100).

To change the number of file descriptors available to `mysqld`, you can use the `--open-files-limit` option to `mysqld_safe` or set the `open_files_limit` system variable. See [Section 5.1.3, “Server System Variables”](#). The easiest way

to set these values is to add an option to your option file. See [Section 4.2.3.2, “Using Option Files”](#). If you have an old version of `mysqld` that doesn't support setting the open files limit, you can edit the `mysqld_safe` script. There is a commented-out line `ulimit -n 256` in the script. You can remove the “#” character to uncomment this line, and change the number `256` to set the number of file descriptors to be made available to `mysqld`.

`--open-files-limit` and `ulimit` can increase the number of file descriptors, but only up to the limit imposed by the operating system. There is also a “hard” limit that can be overridden only if you start `mysqld_safe` or `mysqld` as `root` (just remember that you also need to start the server with the `--user` option in this case so that it does not continue to run as `root` after it starts up). If you need to increase the operating system limit on the number of file descriptors available to each process, consult the documentation for your system.

### Note

If you run the `tcsh` shell, `ulimit` does not work! `tcsh` also reports incorrect values when you ask for the current limits. In this case, you should start `mysqld_safe` using `sh`.

## B.1.2.19. Table-Corruption Issues

If you have started `mysqld` with `--myisam-recover`, MySQL automatically checks and tries to repair MyISAM tables if they are marked as 'not closed properly' or 'crashed'. If this happens, MySQL writes an entry in the `hostname.err` file 'Warning: Checking table ...' which is followed by 'Warning: Repairing table' if the table needs to be repaired. If you get a lot of these errors, without `mysqld` having died unexpectedly just before, then something is wrong and needs to be investigated further.

See also [Section 5.1.2, “Server Command Options”](#), and [Section 21.5.1.7, “Making a Test Case If You Experience Table Corruption”](#).

## B.1.3. Installation-Related Issues

### B.1.3.1. Problems Linking to the MySQL Client Library

When you are linking an application program to use the MySQL client library, you might get undefined reference errors for symbols that start with `mysql_`, such as those shown here:

```
/tmp/ccFKsdPa.o: In function `main':
/tmp/ccFKsdPa.o(.text+0xb): undefined reference to `mysql_init'
/tmp/ccFKsdPa.o(.text+0x31): undefined reference to `mysql_real_connect'
/tmp/ccFKsdPa.o(.text+0x57): undefined reference to `mysql_real_connect'
/tmp/ccFKsdPa.o(.text+0x69): undefined reference to `mysql_error'
/tmp/ccFKsdPa.o(.text+0x9a): undefined reference to `mysql_close'
```

You should be able to solve this problem by adding `-Ldir_path -lmysqlclient` at the end of your link command, where `dir_path` represents the path name of the directory where the client library is located. To determine the correct directory, try this command:

```
shell> mysql_config --libs
```

The output from `mysql_config` might indicate other libraries that should be specified on the link command as well.

If you get `undefined reference` errors for the `uncompress` or `compress` function, add `-lz` to the end of your link command and try again.

If you get `undefined reference` errors for a function that should exist on your system, such as `connect`, check the manual page for the function in question to determine which libraries you should add to the link command.

You might get `undefined reference` errors such as the following for functions that don't exist on your system:

```
mF_format.o(.text+0x201): undefined reference to `__lxstat'
```

This usually means that your MySQL client library was compiled on a system that is not 100% compatible with yours. In this case, you should download the latest MySQL source distribution and compile MySQL yourself. See [Section 2.10, “MySQL Installation Using a Source Distribution”](#).

You might get undefined reference errors at runtime when you try to execute a MySQL program. If these errors specify symbols that start with `mysql_` or indicate that the `mysqlclient` library can't be found, it means that your system can't find the shared `libmysqlclient.so` library. The fix for this is to tell your system to search for shared libraries where the library is located. Use whichever of the following methods is appropriate for your system:

- Add the path to the directory where `libmysqlclient.so` is located to the `LD_LIBRARY_PATH` environment variable.

- Add the path to the directory where `libmysqlclient.so` is located to the `LD_LIBRARY` environment variable.
- Copy `libmysqlclient.so` to some directory that is searched by your system, such as `/lib`, and update the shared library information by executing `ldconfig`.

Another way to solve this problem is by linking your program statically with the `-static` option, or by removing the dynamic MySQL libraries before linking your code. Before trying the second method, you should be sure that no other programs are using the dynamic libraries.

### B.1.3.2. Problems with File Permissions

If you have problems with file permissions, the `UMASK` environment variable might be set incorrectly when `mysqld` starts. For example, MySQL might issue the following error message when you create a table:

```
ERROR: Can't find file: 'path/with/filename.frm' (Errcode: 13)
```

The default `UMASK` value is `0660`. You can change this behavior by starting `mysqld_safe` as follows:

```
shell> UMASK=384 # = 600 in octal
shell> export UMASK
shell> mysqld_safe &
```

By default, MySQL creates database directories with an access permission value of `0700`. You can modify this behavior by setting the `UMASK_DIR` variable. If you set its value, new directories are created with the combined `UMASK` and `UMASK_DIR` values. For example, if you want to give group access to all new directories, you can do this:

```
shell> UMASK_DIR=504 # = 770 in octal
shell> export UMASK_DIR
shell> mysqld_safe &
```

MySQL assumes that the value for `UMASK` or `UMASK_DIR` is in octal if it starts with a zero.

See [Section 2.14, “Environment Variables”](#).

## B.1.4. Administration-Related Issues

### B.1.4.1. How to Reset the Root Password

If you have never set a `root` password for MySQL, the server does not require a password at all for connecting as `root`. However, it is recommended to set a password for each account. See [Section 5.3.1, “General Security Guidelines”](#).

If you set a `root` password previously, but have forgotten what it was, you can set a new password. The next two sections show procedures for Windows and Unix systems, respectively.

#### B.1.4.1.1. Resetting the Root Password on Windows Systems

Use the following procedure for resetting the password for any MySQL `root` accounts on Windows:

1. Log on to your system as Administrator.
2. Stop the MySQL server if it is running. For a server that is running as a Windows service, go to the Services manager:

```
Start Menu -> Control Panel -> Administrative Tools -> Services
```

Then find the MySQL service in the list, and stop it.

If your server is not running as a service, you may need to use the Task Manager to force it to stop.

3. Create a text file and place the following statements in it. Replace the password with the password that you want to use.

```
UPDATE mysql.user SET Password=PASSWORD('MyNewPass') WHERE User='root';
FLUSH PRIVILEGES;
```

The `UPDATE` and `FLUSH` statements each must be written on a single line. The `UPDATE` statement resets the password for all existing `root` accounts, and the `FLUSH` statement tells the server to reload the grant tables into memory.

4. Save the file. For this example, the file will be named `C:\mysql-init.txt`.

5. Open a console window to get to the command prompt:

```
Start Menu -> Run -> cmd
```

6. Start the MySQL server with the special `--init-file` option:

```
C:\> C:\mysql\bin\mysqld --init-file=C:\mysql-init.txt
```

If you installed MySQL to a location other than `C:\mysql`, adjust the command accordingly.

The server executes the contents of the file named by the `--init-file` option at startup, changing each `root` account password.

You can also add the `--console` option to the command if you want server output to appear in the console window rather than in a log file.

If you installed MySQL using the MySQL Installation Wizard, you may need to specify a `--defaults-file` option:

```
C:\> "C:\Program Files\MySQL\MySQL Server 5.1\bin\mysqld.exe"
--defaults-file="C:\Program Files\MySQL\MySQL Server 5.1\my.ini"
--init-file=C:\mysql-init.txt
```

The appropriate `--defaults-file` setting can be found using the Services Manager:

```
Start Menu -> Control Panel -> Administrative Tools -> Services
```

Find the MySQL service in the list, right-click on it, and choose the `Properties` option. The `Path to executable` field contains the `--defaults-file` setting.

7. After the server has started successfully, delete `C:\mysql-init.txt`.
8. Stop the MySQL server, then restart it in normal mode again. If you run the server as a service, start it from the Windows Services window. If you start the server manually, use whatever command you normally use.

You should now be able to connect to MySQL as `root` using the new password.

### B.1.4.1.2. Resetting the Root Password on Unix Systems

#### MySQL Enterprise

For expert advice on security-related issues, subscribe to the MySQL Enterprise Monitor. For more information, see <http://www.mysql.com/products/enterprise/advisors.html>.

Use the following procedure for resetting the password for any MySQL `root` accounts on Unix. The instructions assume that you will start the server so that it runs using the Unix login account that you normally use for running the server. For example, if you run the server using the `mysql` login account, you should log in as `mysql` before using the instructions. (Alternatively, you can log in as `root`, but in this case you *must* start `mysqld` with the `--user=mysql` option. If you start the server as `root` without using `--user=mysql`, the server may create `root`-owned files in the data directory, such as log files, and these may cause permission-related problems for future server startups. If that happens, you will need to either change the ownership of the files to `mysql` or remove them.)

1. Log on to your system as the Unix `mysql` user that the `mysqld` server runs as.
2. Locate the `.pid` file that contains the server's process ID. The exact location and name of this file depend on your distribution, host name, and configuration. Common locations are `/var/lib/mysql/`, `/var/run/mysqld/`, and `/usr/local/mysql/data/`. Generally, the file name has an extension of `.pid` and begins with either `mysqld` or your system's host name.

You can stop the MySQL server by sending a normal `kill` (not `kill -9`) to the `mysqld` process, using the path name of the `.pid` file in the following command:

```
shell> kill `cat /mysql-data-directory/host_name.pid`
```

Note the use of backticks rather than forward quotes with the `cat` command; these cause the output of `cat` to be substituted into the `kill` command.

3. Create a text file and place the following statements in it. Replace the password with the password that you want to use.

```
UPDATE mysql.user SET Password=PASSWORD('MyNewPass') WHERE User='root';
```



```
FLUSH PRIVILEGES;
```

The `UPDATE` and `FLUSH` statements each must be written on a single line. The `UPDATE` statement resets the password for all existing `root` accounts, and the `FLUSH` statement tells the server to reload the grant tables into memory.

4. Save the file. For this example, the file will be named `/home/me/mysql-init`. The file contains the password, so it should not be saved where it can be read by other users.
5. Start the MySQL server with the special `--init-file` option:

```
shell> mysqld_safe --init-file=/home/me/mysql-init &
```

The server executes the contents of the file named by the `--init-file` option at startup, changing each `root` account password.

6. After the server has started successfully, delete `/home/me/mysql-init`.

You should now be able to connect to MySQL as `root` using the new password.

Alternatively, on any platform, you can set the new password using the `mysql` client (but this approach is less secure):

1. Stop `mysqld` and restart it with the `--skip-grant-tables` option.
2. Connect to the `mysqld` server with this command:

```
shell> mysql
```

3. Issue the following statements in the `mysql` client. Replace the password with the password that you want to use.

```
mysql> UPDATE mysql.user SET Password=PASSWORD('MyNewPass')
-> WHERE User='root';
mysql> FLUSH PRIVILEGES;
```

You should now be able to connect to MySQL as `root` using the new password.

### B.1.4.2. What to Do If MySQL Keeps Crashing

Each MySQL version is tested on many platforms before it is released. This doesn't mean that there are no bugs in MySQL, but if there are bugs, they should be very few and can be hard to find. If you have a problem, it always helps if you try to find out exactly what crashes your system, because you have a much better chance of getting the problem fixed quickly.

First, you should try to find out whether the problem is that the `mysqld` server dies or whether your problem has to do with your client. You can check how long your `mysqld` server has been up by executing `mysqladmin version`. If `mysqld` has died and restarted, you may find the reason by looking in the server's error log. See [Section 5.2.2, "The Error Log"](#).

On some systems, you can find in the error log a stack trace of where `mysqld` died that you can resolve with the `resolve_stack_dump` program. See [MySQL Internals: Porting](#). Note that the variable values written in the error log may not always be 100% correct.

Many server crashes are caused by corrupted data files or index files. MySQL updates the files on disk with the `write()` system call after every SQL statement and before the client is notified about the result. (This is not true if you are running with `--delay-key-write`, in which case data files are written but not index files.) This means that data file contents are safe even if `mysqld` crashes, because the operating system ensures that the unflushed data is written to disk. You can force MySQL to flush everything to disk after every SQL statement by starting `mysqld` with the `--flush` option.

The preceding means that normally you should not get corrupted tables unless one of the following happens:

- The MySQL server or the server host was killed in the middle of an update.
- You have found a bug in `mysqld` that caused it to die in the middle of an update.
- Some external program is manipulating data files or index files at the same time as `mysqld` without locking the table properly.
- You are running many `mysqld` servers using the same data directory on a system that doesn't support good file system locks (normally handled by the `lockd` lock manager), or you are running multiple servers with external locking disabled.



- You have a crashed data file or index file that contains very corrupt data that confused `mysqld`.
- You have found a bug in the data storage code. This isn't likely, but it is at least possible. In this case, you can try to change the storage engine to another engine by using `ALTER TABLE` on a repaired copy of the table.

Because it is very difficult to know why something is crashing, first try to check whether things that work for others crash for you. Please try the following things:

- Stop the `mysqld` server with `mysqladmin shutdown`, run `myisamchk --silent --force */*.MYI` from the data directory to check all MyISAM tables, and restart `mysqld`. This ensures that you are running from a clean state. See [Chapter 5, MySQL Server Administration](#).
- Start `mysqld` with the general query log enabled (see [Section 5.2.3, “The General Query Log”](#)). Then try to determine from the information written to the log whether some specific query kills the server. About 95% of all bugs are related to a particular query. Normally, this is one of the last queries in the log file just before the server restarts. See [Section 5.2.3, “The General Query Log”](#). If you can repeatedly kill MySQL with a specific query, even when you have checked all tables just before issuing it, then you have been able to locate the bug and should submit a bug report for it. See [Section 1.6, “How to Report Bugs or Problems”](#).
- Try to make a test case that we can use to repeat the problem. See [MySQL Internals: Porting](#).
- Try running the tests in the `mysql-test` directory and the MySQL benchmarks. See [Section 21.1.2, “MySQL Test Suite”](#). They should test MySQL rather well. You can also add code to the benchmarks that simulates your application. The benchmarks can be found in the `sql-bench` directory in a source distribution or, for a binary distribution, in the `sql-bench` directory under your MySQL installation directory.
- Try the `fork_big.pl` script. (It is located in the `tests` directory of source distributions.)
- If you configure MySQL for debugging, it is much easier to gather information about possible errors if something goes wrong. Configuring MySQL for debugging causes a safe memory allocator to be included that can find some errors. It also provides a lot of output about what is happening. Reconfigure MySQL with the `--with-debug` or `--with-debug=full` option to [configure](#) and then recompile. See [MySQL Internals: Porting](#).
- Make sure that you have applied the latest patches for your operating system.
- Use the `--skip-external-locking` option to `mysqld`. On some systems, the `lockd` lock manager does not work properly; the `--skip-external-locking` option tells `mysqld` not to use external locking. (This means that you cannot run two `mysqld` servers on the same data directory and that you must be careful if you use `myisamchk`. Nevertheless, it may be instructive to try the option as a test.)
- Have you tried `mysqladmin -u root processlist` when `mysqld` appears to be running but not responding? Sometimes `mysqld` is not comatose even though you might think so. The problem may be that all connections are in use, or there may be some internal lock problem. `mysqladmin -u root processlist` usually is able to make a connection even in these cases, and can provide useful information about the current number of connections and their status.
- Run the command `mysqladmin -i 5 status` or `mysqladmin -i 5 -r status` in a separate window to produce statistics while you run your other queries.
- Try the following:
  1. Start `mysqld` from `gdb` (or another debugger). See [MySQL Internals: Porting](#).
  2. Run your test scripts.
  3. Print the backtrace and the local variables at the three lowest levels. In `gdb`, you can do this with the following commands when `mysqld` has crashed inside `gdb`:

```
backtrace
info local
up
info local
up
info local
```

With `gdb`, you can also examine which threads exist with `info threads` and switch to a specific thread with `thread N`, where `N` is the thread ID.

- Try to simulate your application with a Perl script to force MySQL to crash or misbehave.
- Send a normal bug report. See [Section 1.6, “How to Report Bugs or Problems”](#). Be even more detailed than usual. Because

MySQL works for many people, it may be that the crash results from something that exists only on your computer (for example, an error that is related to your particular system libraries).

- If you have a problem with tables containing dynamic-length rows and you are using only `VARCHAR` columns (not `BLOB` or `TEXT` columns), you can try to change all `VARCHAR` to `CHAR` with `ALTER TABLE`. This forces MySQL to use fixed-size rows. Fixed-size rows take a little extra space, but are much more tolerant to corruption.

The current dynamic row code has been in use for several years with very few problems, but dynamic-length rows are by nature more prone to errors, so it may be a good idea to try this strategy to see whether it helps.

- Do not rule out your server hardware when diagnosing problems. Defective hardware can be the cause of data corruption. Particular attention should be paid to your memory and disk subsystems when troubleshooting hardware.

### B.1.4.3. How MySQL Handles a Full Disk

This section describes how MySQL responds to disk-full errors (such as “no space left on device”), and to quota-exceeded errors (such as “write failed” or “user block limit reached”).

This section is relevant for writes to `MyISAM` tables. It also applies for writes to binary log files and binary log index file, except that references to “row” and “record” should be understood to mean “event.”

When a disk-full condition occurs, MySQL does the following:

- It checks once every minute to see whether there is enough space to write the current row. If there is enough space, it continues as if nothing had happened.
- Every 10 minutes it writes an entry to the log file, warning about the disk-full condition.

To alleviate the problem, you can take the following actions:

- To continue, you only have to free enough disk space to insert all records.
- To abort the thread, you must use `mysqladmin kill`. The thread is aborted the next time it checks the disk (in one minute).
- Other threads might be waiting for the table that caused the disk-full condition. If you have several “locked” threads, killing the one thread that is waiting on the disk-full condition allows the other threads to continue.

Exceptions to the preceding behavior are when you use `REPAIR TABLE` or `OPTIMIZE TABLE` or when the indexes are created in a batch after `LOAD DATA INFILE` or after an `ALTER TABLE` statement. All of these statements may create large temporary files that, if left to themselves, would cause big problems for the rest of the system. If the disk becomes full while MySQL is doing any of these operations, it removes the big temporary files and mark the table as crashed. The exception is that for `ALTER TABLE`, the old table is left unchanged.

#### MySQL Enterprise

For early notification of possible problems with your MySQL configuration subscribe to the MySQL Enterprise Monitor. For more information, see <http://www.mysql.com/products/enterprise/advisors.html>.

### B.1.4.4. Where MySQL Stores Temporary Files

MySQL uses the value of the `TMPDIR` environment variable as the path name of the directory in which to store temporary files. If you don't have `TMPDIR` set, MySQL uses the system default, which is normally `/tmp`, `/var/tmp`, or `/usr/tmp`. If the file system containing your temporary file directory is too small, you can use the `--tmpdir` option to `mysqld` to specify a directory in a file system where you have enough space.

In MySQL 5.1, the `--tmpdir` option can be set to a list of several paths that are used in round-robin fashion. Paths should be separated by colon characters (“:”) on Unix and semicolon characters (“;”) on Windows, NetWare, and OS/2.

#### Note

To spread the load effectively, these paths should be located on different *physical* disks, not different partitions of the same disk.

If the MySQL server is acting as a replication slave, you should not set `--tmpdir` to point to a directory on a memory-based file system or to a directory that is cleared when the server host restarts. A replication slave needs some of its temporary files to survive a machine restart so that it can replicate temporary tables or `LOAD DATA INFILE` operations. If files in the temporary file direct-

ory are lost when the server restarts, replication fails.

MySQL creates all temporary files as hidden files. This ensures that the temporary files are removed if `mysqld` is terminated. The disadvantage of using hidden files is that you do not see a big temporary file that fills up the file system in which the temporary file directory is located.

#### MySQL Enterprise

Advisors provided by the MySQL Enterprise Monitor automatically detect excessive temporary table storage to disk. For more information, see <http://www.mysql.com/products/enterprise/advisors.html>.

When sorting (`ORDER BY` or `GROUP BY`), MySQL normally uses one or two temporary files. The maximum disk space required is determined by the following expression:

```
(length of what is sorted + sizeof(row pointer))
* number of matched rows
* 2
```

The row pointer size is usually four bytes, but may grow in the future for really big tables.

For some `SELECT` queries, MySQL also creates temporary SQL tables. These are not hidden and have names of the form `SQL_*`.

`ALTER TABLE` creates a temporary table in the same directory as the original table.

### B.1.4.5. How to Protect or Change the MySQL Unix Socket File

The default location for the Unix socket file that the server uses for communication with local clients is `/tmp/mysql.sock`. (For some distribution formats, the directory might be different, such as `/var/lib/mysql` for RPMs.)

On some versions of Unix, anyone can delete files in the `/tmp` directory or other similar directories used for temporary files. If the socket file is located in such a directory on your system, this might cause problems.

On most versions of Unix, you can protect your `/tmp` directory so that files can be deleted only by their owners or the superuser (`root`). To do this, set the `sticky` bit on the `/tmp` directory by logging in as `root` and using the following command:

```
shell> chmod +t /tmp
```

You can check whether the `sticky` bit is set by executing `ls -ld /tmp`. If the last permission character is `t`, the bit is set.

Another approach is to change the place where the server creates the Unix socket file. If you do this, you should also let client programs know the new location of the file. You can specify the file location in several ways:

- Specify the path in a global or local option file. For example, put the following lines in `/etc/my.cnf`:

```
[mysqld]
socket=/path/to/socket

[client]
socket=/path/to/socket
```

See Section 4.2.3.2, “Using Option Files”.

- Specify a `--socket` option on the command line to `mysqld_safe` and when you run client programs.
- Set the `MYSQL_UNIX_PORT` environment variable to the path of the Unix socket file.
- Recompile MySQL from source to use a different default Unix socket file location. Define the path to the file with the `--with-unix-socket-path` option when you run `configure`. See Section 2.10.2, “Typical configure Options”.

You can test whether the new socket location works by attempting to connect to the server with this command:

```
shell> mysqladmin --socket=/path/to/socket version
```

### B.1.4.6. Time Zone Problems

If you have a problem with `SELECT NOW()` returning values in UTC and not your local time, you have to tell the server your current time zone. The same applies if `UNIX_TIMESTAMP()` returns the wrong value. This should be done for the environment in which the server runs; for example, in `mysqld_safe` or `mysql.server`. See Section 2.14, “Environment Variables”.

You can set the time zone for the server with the `--timezone=timezone_name` option to `mysqld_safe`. You can also set it

by setting the `TZ` environment variable before you start `mysqld`.

The allowable values for `--timezone` or `TZ` are system-dependent. Consult your operating system documentation to see what values are acceptable.

## B.1.5. Query-Related Issues

### B.1.5.1. Case Sensitivity in String Searches

For nonbinary strings (`CHAR`, `VARCHAR`, `TEXT`), string searches use the collation of the comparison operands. For binary strings (`BINARY`, `VARBINARY`, `BLOB`), comparisons use the numeric values of the bytes in the operands; this means that for alphabetic characters, comparisons will be case sensitive.

A comparison between a nonbinary string and binary string is treated as a comparison of binary strings.

Simple comparison operations (`>=`, `>`, `=`, `<`, `<=`, sorting, and grouping) are based on each character's "sort value." Characters with the same sort value are treated as the same character. For example, if "e" and "é" have the same sort value in a given collation, they compare as equal.

The default character set and collation are `latin1` and `latin1_swedish_ci`, so nonbinary string comparisons are case insensitive by default. This means that if you search with `col_name LIKE 'a%'`, you get all column values that start with `A` or `a`. To make this search case sensitive, make sure that one of the operands has a case sensitive or binary collation. For example, if you are comparing a column and a string that both have the `latin1` character set, you can use the `COLLATE` operator to cause either operand to have the `latin1_general_cs` or `latin1_bin` collation:

```
col_name COLLATE latin1_general_cs LIKE 'a%'
col_name LIKE 'a%' COLLATE latin1_general_cs
col_name COLLATE latin1_bin LIKE 'a%'
col_name LIKE 'a%' COLLATE latin1_bin
```

If you want a column always to be treated in case-sensitive fashion, declare it with a case sensitive or binary collation. See [Section 12.1.17, "CREATE TABLE Syntax"](#).

To cause a case-sensitive comparison of nonbinary strings to be case insensitive, use `COLLATE` to name a case-insensitive collation. The strings in the following example normally are case sensitive, but `COLLATE` changes the comparison to be case insensitive:

```
mysql> SET @s1 = 'MySQL' COLLATE latin1_bin,
->      @s2 = 'mysql' COLLATE latin1_bin;
mysql> SELECT @s1 = @s2;
+-----+
| @s1 = @s2 |
+-----+
|          0 |
+-----+
mysql> SELECT @s1 COLLATE latin1_swedish_ci = @s2;
+-----+
| @s1 COLLATE latin1_swedish_ci = @s2 |
+-----+
|                                  1 |
+-----+
```

A binary string is case sensitive in comparisons. To compare the string as case insensitive, convert it to a nonbinary string and use `COLLATE` to name a case-insensitive collation:

```
mysql> SET @s = BINARY 'MySQL';
mysql> SELECT @s = 'mysql';
+-----+
| @s = 'mysql' |
+-----+
|          0 |
+-----+
mysql> SELECT CONVERT(@s USING latin1) COLLATE latin1_swedish_ci = 'mysql';
+-----+
| CONVERT(@s USING latin1) COLLATE latin1_swedish_ci = 'mysql' |
+-----+
|                                  1 |
+-----+
```

To determine whether a value will compare as a nonbinary or binary string, use the `COLLATION()` function. This example shows that `VERSION()` returns a string that has a case-insensitive collation, so comparisons are case insensitive:

```
mysql> SELECT COLLATION(VERSION());
+-----+
| COLLATION(VERSION()) |
+-----+
| utf8_general_ci     |
+-----+
```

For binary strings, the collation value is `binary`, so comparisons will be case sensitive. One context in which you will see `binary` is for compression and encryption functions, which return binary strings as a general rule: string:

```
mysql> SELECT COLLATION(ENCRYPT('x')), COLLATION(SHA1('x'));
+-----+-----+
| COLLATION(ENCRYPT('x')) | COLLATION(SHA1('x')) |
+-----+-----+
| binary                 | binary                 |
+-----+-----+
```

### B.1.5.2. Problems Using `DATE` Columns

The format of a `DATE` value is `'YYYY-MM-DD'`. According to standard SQL, no other format is allowed. You should use this format in `UPDATE` expressions and in the `WHERE` clause of `SELECT` statements. For example:

```
mysql> SELECT * FROM tbl_name WHERE date >= '2003-05-05';
```

As a convenience, MySQL automatically converts a date to a number if the date is used in a numeric context (and vice versa). It is also smart enough to allow a “relaxed” string form when updating and in a `WHERE` clause that compares a date to a `TIMESTAMP`, `DATE`, or `DATETIME` column. (“Relaxed form” means that any punctuation character may be used as the separator between parts. For example, `'2004-08-15'` and `'2004#08#15'` are equivalent.) MySQL can also convert a string containing no separators (such as `'20040815'`), provided it makes sense as a date.

When you compare a `DATE`, `TIME`, `DATETIME`, or `TIMESTAMP` to a constant string with the `<`, `<=`, `=`, `>=`, `>`, or `BETWEEN` operators, MySQL normally converts the string to an internal long integer for faster comparison (and also for a bit more “relaxed” string checking). However, this conversion is subject to the following exceptions:

- When you compare two columns
- When you compare a `DATE`, `TIME`, `DATETIME`, or `TIMESTAMP` column to an expression
- When you use any other comparison method than those just listed, such as `IN` or `STRCMP()`.

For these exceptional cases, the comparison is done by converting the objects to strings and performing a string comparison.

To keep things safe, assume that strings are compared as strings and use the appropriate string functions if you want to compare a temporal value to a string.

The special date `'0000-00-00'` can be stored and retrieved as `'0000-00-00'`. When using a `'0000-00-00'` date through MyODBC, it is automatically converted to `NULL` in MyODBC 2.50.12 and above, because ODBC can't handle this kind of date.

Because MySQL performs the conversions described above, the following statements work:

```
mysql> INSERT INTO tbl_name (idate) VALUES (19970505);
mysql> INSERT INTO tbl_name (idate) VALUES ('19970505');
mysql> INSERT INTO tbl_name (idate) VALUES ('97-05-05');
mysql> INSERT INTO tbl_name (idate) VALUES ('1997.05.05');
mysql> INSERT INTO tbl_name (idate) VALUES ('1997 05 05');
mysql> INSERT INTO tbl_name (idate) VALUES ('0000-00-00');

mysql> SELECT idate FROM tbl_name WHERE idate >= '1997-05-05';
mysql> SELECT idate FROM tbl_name WHERE idate >= 19970505;
mysql> SELECT MOD(idate,100) FROM tbl_name WHERE idate >= 19970505;
mysql> SELECT idate FROM tbl_name WHERE idate >= '19970505';
```

However, the following does not work:

```
mysql> SELECT idate FROM tbl_name WHERE STRCMP(idate,'20030505')=0;
```

`STRCMP()` is a string function, so it converts `idate` to a string in `'YYYY-MM-DD'` format and performs a string comparison. It does not convert `'20030505'` to the date `'2003-05-05'` and perform a date comparison.

If you are using the `ALLOW_INVALID_DATES` SQL mode, MySQL allows you to store dates that are given only limited checking: MySQL requires only that the day is in the range from 1 to 31 and the month is in the range from 1 to 12.

This makes MySQL very convenient for Web applications where you obtain year, month, and day in three different fields and you want to store exactly what the user inserted (without date validation).

If you are not using the `NO_ZERO_IN_DATE` SQL mode, the day or month part can be zero. This is convenient if you want to store a birthdate in a `DATE` column and you know only part of the date.

If you are not using the `NO_ZERO_DATE` SQL mode, MySQL also allows you to store `'0000-00-00'` as a “dummy date.” This is in some cases more convenient than using `NULL` values.

If the date cannot be converted to any reasonable value, a `0` is stored in the `DATE` column, which is retrieved as `'0000-00-00'`. This is both a speed and a convenience issue. We believe that the database server's responsibility is to retrieve the same date you stored (even if the data was not logically correct in all cases). We think it is up to the application and not the server to check the dates.

If you want MySQL to check all dates and accept only legal dates (unless overridden by `IGNORE`), you should set `sql_mode` to `"NO_ZERO_IN_DATE,NO_ZERO_DATE"`.

### B.1.5.3. Problems with `NULL` Values

The concept of the `NULL` value is a common source of confusion for newcomers to SQL, who often think that `NULL` is the same thing as an empty string `' '`. This is not the case. For example, the following statements are completely different:

```
mysql> INSERT INTO my_table (phone) VALUES (NULL);
mysql> INSERT INTO my_table (phone) VALUES ('');
```

Both statements insert a value into the `phone` column, but the first inserts a `NULL` value and the second inserts an empty string. The meaning of the first can be regarded as “phone number is not known” and the meaning of the second can be regarded as “the person is known to have no phone, and thus no phone number.”

To help with `NULL` handling, you can use the `IS NULL` and `IS NOT NULL` operators and the `IFNULL()` function.

In SQL, the `NULL` value is never true in comparison to any other value, even `NULL`. An expression that contains `NULL` always produces a `NULL` value unless otherwise indicated in the documentation for the operators and functions involved in the expression. All columns in the following example return `NULL`:

```
mysql> SELECT NULL, 1+NULL, CONCAT('Invisible',NULL);
```

If you want to search for column values that are `NULL`, you cannot use an `expr = NULL` test. The following statement returns no rows, because `expr = NULL` is never true for any expression:

```
mysql> SELECT * FROM my_table WHERE phone = NULL;
```

To look for `NULL` values, you must use the `IS NULL` test. The following statements show how to find the `NULL` phone number and the empty phone number:

```
mysql> SELECT * FROM my_table WHERE phone IS NULL;
mysql> SELECT * FROM my_table WHERE phone = '';
```

See [Section 3.3.4.6, “Working with `NULL` Values”](#), for additional information and examples.

You can add an index on a column that can have `NULL` values if you are using the `MyISAM`, `InnoDB`, or `MEMORY` storage engine. Otherwise, you must declare an indexed column `NOT NULL`, and you cannot insert `NULL` into the column.

When reading data with `LOAD DATA INFILE`, empty or missing columns are updated with `' '`. If you want a `NULL` value in a column, you should use `\N` in the data file. The literal word “`NULL`” may also be used under some circumstances. See [Section 12.2.6, “LOAD DATA INFILE Syntax”](#).

When using `DISTINCT`, `GROUP BY`, or `ORDER BY`, all `NULL` values are regarded as equal.

When using `ORDER BY`, `NULL` values are presented first, or last if you specify `DESC` to sort in descending order.

Aggregate (summary) functions such as `COUNT()`, `MIN()`, and `SUM()` ignore `NULL` values. The exception to this is `COUNT(*)`, which counts rows and not individual column values. For example, the following statement produces two counts. The first is a count of the number of rows in the table, and the second is a count of the number of non-`NULL` values in the `age` column:

```
mysql> SELECT COUNT(*), COUNT(age) FROM person;
```

For some data types, MySQL handles `NULL` values specially. If you insert `NULL` into a `TIMESTAMP` column, the current date and time is inserted. If you insert `NULL` into an integer or floating-point column that has the `AUTO_INCREMENT` attribute, the next number in the sequence is inserted.

### B.1.5.4. Problems with Column Aliases

You can use an alias to refer to a column in `GROUP BY`, `ORDER BY`, or `HAVING` clauses. Aliases can also be used to give columns better names:

```
SELECT SQRT(a*b) AS root FROM tbl_name GROUP BY root HAVING root > 0;
SELECT id, COUNT(*) AS cnt FROM tbl_name GROUP BY id HAVING cnt > 0;
SELECT id AS 'Customer identity' FROM tbl_name;
```

Standard SQL doesn't allow you to refer to a column alias in a `WHERE` clause. This restriction is imposed because when the `WHERE` code is executed, the column value may not yet be determined. For example, the following query is illegal:

```
SELECT id, COUNT(*) AS cnt FROM tbl_name WHERE cnt > 0 GROUP BY id;
```

The `WHERE` statement is executed to determine which rows should be included in the `GROUP BY` part, whereas `HAVING` is used to decide which rows from the result set should be used.

### B.1.5.5. Rollback Failure for Non-Transactional Tables

If you receive the following message when trying to perform a `ROLLBACK`, it means that one or more of the tables you used in the transaction do not support transactions:

```
Warning: Some non-transactional changed tables couldn't be rolled back
```

These non-transactional tables are not affected by the `ROLLBACK` statement.

If you were not deliberately mixing transactional and non-transactional tables within the transaction, the most likely cause for this message is that a table you thought was transactional actually is not. This can happen if you try to create a table using a transactional storage engine that is not supported by your `mysqld` server (or that was disabled with a startup option). If `mysqld` doesn't support a storage engine, it instead creates the table as a `MyISAM` table, which is non-transactional.

You can check the storage engine for a table by using either of these statements:

```
SHOW TABLE STATUS LIKE 'tbl_name';
SHOW CREATE TABLE tbl_name;
```

See [Section 12.5.5.38, “SHOW TABLE STATUS Syntax”](#), and [Section 12.5.5.12, “SHOW CREATE TABLE Syntax”](#).

You can check which storage engines your `mysqld` server supports by using this statement:

```
SHOW ENGINES;
```

You can also use the following statement, and check the value of the variable that is associated with the storage engine in which you are interested:

```
SHOW VARIABLES LIKE 'have_%';
```

For example, to determine whether the `InnoDB` storage engine is available, check the value of the `have_innodb` variable.

See [Section 12.5.5.17, “SHOW ENGINES Syntax”](#), and [Section 12.5.5.41, “SHOW VARIABLES Syntax”](#).

#### MySQL Enterprise

Ensure that your data is adequately protected by subscribing to the MySQL Enterprise Monitor. For more information, see <http://www.mysql.com/products/enterprise/advisors.html>.

### B.1.5.6. Deleting Rows from Related Tables

If the total length of the `DELETE` statement for `related_table` is more than 1MB (the default value of the `max_allowed_packet` system variable), you should split it into smaller parts and execute multiple `DELETE` statements. You probably get the fastest `DELETE` by specifying only 100 to 1,000 `related_column` values per statement if the `related_column` is indexed. If the `related_column` isn't indexed, the speed is independent of the number of arguments in the `IN` clause.

### B.1.5.7. Solving Problems with No Matching Rows

If you have a complicated query that uses many tables but that doesn't return any rows, you should use the following procedure to find out what is wrong:

1. Test the query with `EXPLAIN` to check whether you can find something that is obviously wrong. See [Section 12.3.2, “EXPLAIN Syntax”](#).
2. Select only those columns that are used in the `WHERE` clause.



3. Remove one table at a time from the query until it returns some rows. If the tables are large, it is a good idea to use `LIMIT 10` with the query.
4. Issue a `SELECT` for the column that should have matched a row against the table that was last removed from the query.
5. If you are comparing `FLOAT` or `DOUBLE` columns with numbers that have decimals, you can't use equality (`=`) comparisons. This problem is common in most computer languages because not all floating-point values can be stored with exact precision. In some cases, changing the `FLOAT` to a `DOUBLE` fixes this. See [Section B.1.5.8, “Problems with Floating-Point Comparisons”](#).
6. If you still can't figure out what is wrong, create a minimal test that can be run with `mysql test < query.sql` that shows your problems. You can create a test file by dumping the tables with `mysqldump --quick db_name tbl_name_1 ... tbl_name_n > query.sql`. Open the file in an editor, remove some insert lines (if there are more than needed to demonstrate the problem), and add your `SELECT` statement at the end of the file.

Verify that the test file demonstrates the problem by executing these commands:

```
shell> mysqladmin create test2
shell> mysql test2 < query.sql
```

Attach the test file to a bug report, which you can file using the instructions in [Section 1.6, “How to Report Bugs or Problems”](#).

### B.1.5.8. Problems with Floating-Point Comparisons

Floating-point numbers sometimes cause confusion because they are approximate. That is, they are not stored as exact values inside computer architecture. What you can see on the screen usually is not the exact value of the number. The `FLOAT` and `DOUBLE` data types are such. For `DECIMAL` columns, MySQL performs operations with a precision of 65 decimal digits, which should solve most common inaccuracy problems.

The following example demonstrates the problem using `DOUBLE`. It shows that are calculations that are done using floating-point operations are subject to floating-point error.

```
mysql> CREATE TABLE t1 (i INT, d1 DOUBLE, d2 DOUBLE);
mysql> INSERT INTO t1 VALUES (1, 101.40, 21.40), (1, -80.00, 0.00),
-> (2, 0.00, 0.00), (2, -13.20, 0.00), (2, 59.60, 46.40),
-> (2, 30.40, 30.40), (3, 37.00, 7.40), (3, -29.60, 0.00),
-> (4, 60.00, 15.40), (4, -10.60, 0.00), (4, -34.00, 0.00),
-> (5, 33.00, 0.00), (5, -25.80, 0.00), (5, 0.00, 7.20),
-> (6, 0.00, 0.00), (6, -51.40, 0.00);

mysql> SELECT i, SUM(d1) AS a, SUM(d2) AS b
-> FROM t1 GROUP BY i HAVING a <> b;
```

i	a	b
1	21.4	21.4
2	76.8	76.8
3	7.4	7.4
4	15.4	15.4
5	7.2	7.2
6	-51.4	0

The result is correct. Although the first five records look like they should not satisfy the comparison (the values of `a` and `b` do not appear to be different), they may do so because the difference between the numbers shows up around the tenth decimal or so, depending on factors such as computer architecture or the compiler version or optimization level. For example, different CPUs may evaluate floating-point numbers differently.

If columns `d1` and `d2` had been defined as `DECIMAL` rather than `DOUBLE`, the result of the `SELECT` query would have contained only one row — the last one shown above.

The correct way to do floating-point number comparison is to first decide on an acceptable tolerance for differences between the numbers and then do the comparison against the tolerance value. For example, if we agree that floating-point numbers should be regarded the same if they are same within a precision of one in ten thousand (0.0001), the comparison should be written to find differences larger than the tolerance value:

```
mysql> SELECT i, SUM(d1) AS a, SUM(d2) AS b FROM t1
-> GROUP BY i HAVING ABS(a - b) > 0.0001;

+-----+-----+-----+
| i | a | b |
+-----+-----+-----+
| 6 | -51.4 | 0 |
+-----+-----+-----+
1 row in set (0.00 sec)
```



Conversely, to get rows where the numbers are the same, the test should find differences within the tolerance value:

```
mysql> SELECT i, SUM(d1) AS a, SUM(d2) AS b FROM t1
-> GROUP BY i HAVING ABS(a - b) <= 0.0001;
+----+-----+-----+
| i  | a     | b     |
+----+-----+-----+
| 1  | 21.4  | 21.4  |
| 2  | 76.8  | 76.8  |
| 3  | 7.4   | 7.4   |
| 4  | 15.4  | 15.4  |
| 5  | 7.2   | 7.2   |
+----+-----+-----+
5 rows in set (0.03 sec)
```

## B.1.6. Optimizer-Related Issues

MySQL uses a cost-based optimizer to determine the best way to resolve a query. In many cases, MySQL can calculate the best possible query plan, but sometimes MySQL doesn't have enough information about the data at hand and has to make "educated" guesses about the data.

For the cases when MySQL does not do the "right" thing, tools that you have available to help MySQL are:

- Use the `EXPLAIN` statement to get information about how MySQL processes a query. To use it, just add the keyword `EXPLAIN` to the front of your `SELECT` statement:

```
mysql> EXPLAIN SELECT * FROM t1, t2 WHERE t1.i = t2.i;
```

`EXPLAIN` is discussed in more detail in [Section 12.3.2, "EXPLAIN Syntax"](#).

- Use `ANALYZE TABLE tbl_name` to update the key distributions for the scanned table. See [Section 12.5.2.1, "ANALYZE TABLE Syntax"](#).
- Use `FORCE INDEX` for the scanned table to tell MySQL that table scans are very expensive compared to using the given index:

```
SELECT * FROM t1, t2 FORCE INDEX (index_for_column)
WHERE t1.col_name=t2.col_name;
```

`USE INDEX` and `IGNORE INDEX` may also be useful. See [Section 12.2.8.2, "Index Hint Syntax"](#).

- Global and table-level `STRAIGHT_JOIN`. See [Section 12.2.8, "SELECT Syntax"](#).
- You can tune global or thread-specific system variables. For example, start `mysqld` with the `-max-seeks-for-key=1000` option or use `SET max_seeks_for_key=1000` to tell the optimizer to assume that no key scan causes more than 1,000 key seeks. See [Section 5.1.3, "Server System Variables"](#).

### MySQL Enterprise

For expert advice on configuring MySQL servers for optimal performance, subscribe to the MySQL Enterprise Monitor. For more information, see <http://www.mysql.com/products/enterprise/advisors.html>.

## B.1.7. Table Definition-Related Issues

### B.1.7.1. Problems with `ALTER TABLE`

`ALTER TABLE` changes a table to the current character set. If you get a duplicate-key error during `ALTER TABLE`, the cause is either that the new character sets maps two keys to the same value or that the table is corrupted. In the latter case, you should run `REPAIR TABLE` on the table.

If `ALTER TABLE` dies with the following error, the problem may be that MySQL crashed during an earlier `ALTER TABLE` operation and there is an old table named `A-xxx` or `B-xxx` lying around:

```
Error on rename of './database/name.frm'
to './database/B-xxx.frm' (Errcode: 17)
```

In this case, go to the MySQL data directory and delete all files that have names starting with `A-` or `B-`. (You may want to move them elsewhere instead of deleting them.)

`ALTER TABLE` works in the following way:

- Create a new table named `A-xxx` with the requested structural changes.
- Copy all rows from the original table to `A-xxx`.
- Rename the original table to `B-xxx`.
- Rename `A-xxx` to your original table name.
- Delete `B-xxx`.

If something goes wrong with the renaming operation, MySQL tries to undo the changes. If something goes seriously wrong (although this shouldn't happen), MySQL may leave the old table as `B-xxx`. A simple rename of the table files at the system level should get your data back.

If you use `ALTER TABLE` on a transactional table or if you are using Windows or OS/2, `ALTER TABLE` unlocks the table if you had done a `LOCK TABLE` on it. This is done because `InnoDB` and these operating systems cannot drop a table that is in use.

### B.1.7.2. How to Change the Order of Columns in a Table

First, consider whether you really need to change the column order in a table. The whole point of SQL is to abstract the application from the data storage format. You should always specify the order in which you wish to retrieve your data. The first of the following statements returns columns in the order `col_name1, col_name2, col_name3`, whereas the second returns them in the order `col_name1, col_name3, col_name2`:

```
mysql> SELECT col_name1, col_name2, col_name3 FROM tbl_name;
mysql> SELECT col_name1, col_name3, col_name2 FROM tbl_name;
```

If you decide to change the order of table columns anyway, you can do so as follows:

1. Create a new table with the columns in the new order.
2. Execute this statement:

```
mysql> INSERT INTO new_table
-> SELECT columns-in-new-order FROM old_table;
```

3. Drop or rename `old_table`.
4. Rename the new table to the original name:

```
mysql> ALTER TABLE new_table RENAME old_table;
```

`SELECT *` is quite suitable for testing queries. However, in an application, you should *never* rely on using `SELECT *` and retrieving the columns based on their position. The order and position in which columns are returned does not remain the same if you add, move, or delete columns. A simple change to your table structure could cause your application to fail.

### B.1.7.3. TEMPORARY Table Problems

The following list indicates limitations on the use of `TEMPORARY` tables:

- A `TEMPORARY` table can only be of type `MEMORY`, `MyISAM`, `MERGE`, or `InnoDB`.

Temporary tables are not supported for MySQL Cluster.

- You cannot refer to a `TEMPORARY` table more than once in the same query. For example, the following does not work:

```
mysql> SELECT * FROM temp_table, temp_table AS t2;
ERROR 1137: Can't reopen table: 'temp_table'
```

This error also occurs if you refer to a temporary table multiple times in a stored function under different aliases, even if the references occur in different statements within the function.

- The `SHOW TABLES` statement does not list `TEMPORARY` tables.
- You cannot use `RENAME` to rename a `TEMPORARY` table. However, you can use `ALTER TABLE` instead:

```
mysql> ALTER TABLE orig_name RENAME new_name;
```

- There are known issues in using temporary tables with replication. See [Section 16.3.1, “Replication Features and Issues”](#), for more information.

## B.1.8. Known Issues in MySQL

This section is a list of the known issues in recent versions of MySQL.

For information about platform-specific issues, see the installation and porting instructions in [Section 2.13, “Operating System-Specific Notes”](#), and [MySQL Internals: Porting](#).

### B.1.8.1. Open Issues in MySQL

The following problems are known and fixing them is a high priority:

#### C API

- [Bug#40552](#): Race condition around default\_directories in load\_defaults()
  - **Target fix:** 5.1
- [Bug#26077](#): 'reap' command fetches first command issued by send, not the most recent
  - **Target fix:** 5.1
- [Bug#43560](#): client crashes in mysql\_stmt\_execute/mysql\_stmt\_close after connection loss
  - **Target fix:** 5.1
- [Bug#42675](#): Dangling pointer leads to a client crash (mysys/my\_error.c patch enclosed)
  - **Target fix:** 5.1
- [Bug#27475](#): mysql\_fetch\_field do **NOT** report correctly certain field types
  - **Target fix:** 5.1
- [Bug#43397](#): mysql headers redefine pthread\_mutex\_init unnecessarily
  - **Target fix:** 5.1

#### Client

- [Bug#35934](#): mysql\_upgrade calls mysqlcheck with insufficient parameters
  - **Target fix:** 5.1
- [Bug#34129](#): mysqldumpslow does not aggregate times
  - **Target fix:** 5.1
- [Bug#39852](#): bug in mysql\_setpermission
  - **Target fix:** 5.1
- [Bug#44278](#): mysqlhotcopy unable to backup schema with a hyphen in its name
  - **Target fix:** 5.1
- [Bug#40395](#): mysqladmin -i delay extended-status does not iterate with -r
  - **Target fix:** 5.1
- [Bug#42941](#): --database paramater to mysqlbinlog fails with RBR

- **Target fix:** 5.1
- [Bug#34861](#): mysqldump with --tab gives weird output for triggers.
  - **Target fix:** 5.1
- [Bug#36391](#): mysqlbinlog creates invalid charset statements
  - **Target fix:** 5.1

## Server

- [Bug#42640](#): mysqld crashes when unsafe statements are executed (`STRICT_TRANS_TABLES` mode)
  - **Target fix:** 5.1.35
- [Bug#42610](#): Dynamic plugin broken in 5.1.31
  - **Target fix:** 5.1.33
- [Bug#44521](#): Prepared Statement: `CALL p()` - crashes: ``! thd->main_da.is_sent'` failed et.al.
  - **Target fix:** 5.1
- [Bug#41078](#): With `CURSOR_TYPE_READ_ONLY` `mysql_stmt_fetch()` returns short string value.
  - **Target fix:** 5.1
- [Bug#41004](#): `events_scheduling` times out sporadically on pushbuild
  - **Target fix:** 5.1
- [Bug#35068](#): Assertion fails when reading from `i_s.tables` and there is incorrect merge table
  - **Target fix:** 5.1
- [Bug#38883](#): `thd_security_context` is not thread safe, crashes?
  - **Target fix:** 5.1
- [Bug#38941](#): fast mutexes in MySQL 5.1 have mutex contention when calling `random()`
  - **Target fix:** 5.1
- [Bug#40877](#): multi statement execution fails in 5.1.30
  - **Target fix:** 5.1
- [Bug#39494](#): please support >4GB `key_buffer_size` on windows
  - **Target fix:** 5.1
- [Bug#31616](#): `div_precision_increment` description looks wrong
  - **Target fix:** 5.1
- [Bug#43354](#): Use key hint can crash server in explain extended query
  - **Target fix:** 5.1
- [Bug#40757](#): server crash after failed plugin/engine initialization
  - **Target fix:** 5.1
- [Bug#40536](#): `SELECT` is blocked by `INSERT DELAYED` waiting on upgrading lock, even with `low_pri`
  - **Target fix:** 5.1
- [Bug#43827](#): Server closes connections and restarts

- **Target fix:** 5.1
- [Bug#22891](#): session level max\_allowed\_packet can be set but is ignored
  - **Target fix:** 5.1
- [Bug#40949](#): Debug version of MySQL server crashes when run `OPTIMIZE` on compressed table.
  - **Target fix:** 5.1
- [Bug#41030](#): Wrong meta data (incorrect fieldlen)
  - **Target fix:** 5.1
- [Bug#42563](#): Message tells me to repair table though Storage Engine doesn't allow me to.
  - **Target fix:** 5.1

#### Server: Archive

- [Bug#37719](#): Crash if rename Archive table to same name with different case and then select
  - **Target fix:** 5.1
- [Bug#32880](#): Repairing Archive table fails with internal error 144
  - **Target fix:** 5.1

#### Server: CSV

- [Bug#41441](#): repair csv table crashes debug server
  - **Target fix:** 5.1.31

#### Server: Charsets

- [Bug#33094](#): Error in upgrading from 5.0 to 5.1 when table contains triggers
  - **Target fix:** 5.1.31
- [Bug#41385](#): Crash when attempting to repair a #mysql50# upgraded table with triggers.
  - **Target fix:** 5.1.31
- [Bug#40053](#): 'check table .. for upgrade' doesn't detect collation change made in 5.1.24-rc
  - **Already fixed in:** 5.1.30
- [Bug#32831](#): libmysql should be built with all charsets
  - **Target fix:** 5.1
- [Bug#41084](#): full-text index added to custom `UCA` collation not working
  - **Target fix:** 5.1
- [Bug#45012](#): `my_like_range_cp932` generates invalid string
  - **Target fix:** 5.1
- [Bug#43593](#): dump/backup/restore/upgrade tools fails
  - **Target fix:** 5.1

#### Server: Compiling

- [Bug#42524](#): Function `pthread_setschedprio()` is defined but seems broken on i5/OS `PASE`
  - **Target fix:** 5.1.32
- [Bug#26760](#): SSL support missing from 5.1.15-0 x86\_64 Client Programs?
  - **Target fix:** 5.1.31
- [Bug#43715](#): Link errors when trying to link `mysql_embedded.exe`
  - **Target fix:** 5.1
- [Bug#43449](#): Undefined symbol `__1cG__CrunMex_rethrow_q6F_v_` when compiling using Sun Studio
  - **Target fix:** 5.1
- [Bug#42872](#): In MySQL 5.1.31, unrecognized `--with-innodb`, `--with-partition`, `--with-federated`
  - **Target fix:** 5.1
- [Bug#39996](#): 5.1 fails to compile on Windows 32-bit with VS2005
  - **Target fix:** 5.1
- [Bug#45113](#): `mysql_config` returns incorrect path if built with prefix `!= execprefix`
  - **Target fix:** 5.1
- [Bug#25404](#): `mysql_config` need several issues corrected
  - **Target fix:** 5.1
- [Bug#38364](#): `gen_lex_hash` segmentation fault in debug build
  - **Target fix:** 5.1
- [Bug#42733](#): type-punning warnings when compiling MySQL with `-O2/-O3 -Wall` and `gcc 4.x`
  - **Target fix:** 5.1
- [Bug#39102](#): `valgrind` build does not compile in `realpath`, which make `DATA/INDEX DIR` fail
  - **Target fix:** 5.1
- [Bug#39802](#): On Windows, 32-bit `time_t` should be enforced
  - **Target fix:** 5.1
- [Bug#31506](#): detection of function's availability is wrong in `configure.in`
  - **Target fix:** 5.1
- [Bug#38697](#): `utf8_general_cs` cannot be used with Windows?
  - **Target fix:** 5.1
- [Bug#39279](#): `mysqld` Linux-ia64 binary depends on two versions of `libunwind`
  - **Target fix:** 5.1
- [Bug#42071](#): Obsoleted `configure` options were still used in the official compiling.
  - **Target fix:** 5.1
- [Bug#39571](#): `abi_check`: Does not create all prerequisites
  - **Target fix:** 5.1
- [Bug#42141](#): Compiler crash in `"mf_format.c"` when optimizing for 64 bit
  - **Target fix:** 5.1

- [Bug#42721](#): configure.in invokes 'nm' directly
  - **Target fix:** 5.1
- [Bug#39288](#): MySQL Embedded server (libmysqld.a) is built without -fPIC flag
  - **Target fix:** 5.1

#### Server: Config Wizard

- [Bug#42386](#): MySQL .msi installer does not start configuration wizard on Vista when prompted
  - **Target fix:** 5.1.33
- [Bug#43282](#): Change installation path. mysql.exe not found
  - **Target fix:** 5.1
- [Bug#37294](#): Windows .msi - 'Repair' option doesn't back out as expected
  - **Target fix:** 5.1
- [Bug#42388](#): MySQL .msi uninstall process is an 'Unidentified Program' on Vista
  - **Target fix:** 5.1
- [Bug#44428](#): Cannot recreate instance after clean install (apply security settings fails)
  - **Target fix:** 5.1
- [Bug#38723](#): MySQL Configuration Wizard on Vista unreadable
  - **Target fix:** 5.1

#### Server: DB2SE for IBM i

- [Bug#45197](#): cp1250 character set with IBMDB2I generates 2027 error
  - **Target fix:** 5.1
- [Bug#44856](#): IBMDB2I gives misleading 2504 error
  - **Target fix:** 5.1
- [Bug#44337](#): Select query using index merge fails with MCH3601
  - **Target fix:** 5.1
- [Bug#44022](#): `CREATE TABLE` sometimes fails silently for IBMDB2I engine
  - **Target fix:** 5.1
- [Bug#44811](#): Tests with utf8 charset fail with ibmdb2i on 64bit MySQL
  - **Target fix:** 5.1

#### Server: DB2SE for iOS

- [Bug#44025](#): Some schema names longer than 8 characters not supported by IBMDB2I
  - **Target fix:** 5.1
- [Bug#44020](#): Unicode Swedish collations not working with IBMDB2I
  - **Target fix:** 5.1

**Server: DDL**

- [Bug#37016](#): `TRUNCATE TABLE` removes some rows but not all
  - **Target fix:** 5.1.31
- [Bug#23113](#): Different behavior on altering `ENUM` fields between 5.0 and 5.1
  - **Already fixed in:** 5.1.30
- [Bug#39372](#): "Smart" `ALTER TABLE` not so smart after all.
  - **Target fix:** 5.1
- [Bug#41465](#): confusing error message when comment is too long
  - **Target fix:** 5.1
- [Bug#39200](#): optimize table does not recognize `ROW_FORMAT=COMPRESSED`
  - **Target fix:** 5.1
- [Bug#40886](#): `ALTER TABLE` statements appear to randomly fail on Mac OS 10.4
  - **Target fix:** 5.1
- [Bug#42226](#): `ALTER DATABASE` returns `OK` even when there are errors
  - **Target fix:** 5.1
- [Bug#40277](#): `SHOW CREATE VIEW` returns invalid `SQL`
  - **Target fix:** 5.1
- [Bug#35796](#): `SHOW CREATE TABLE` and default value for `BIT` field
  - **Target fix:** 5.1
- [Bug#41041](#): Obsolete debug code can be used to crash server
  - **Target fix:** 5.1

**Server: DML**

- [Bug#39920](#): MySQL cannot deal with Leap Second expression in string literal.
  - **Target fix:** 5.0.74
- [Bug#44743](#): Join in combination with concat does not always work
  - **Target fix:** 5.1
- [Bug#41156](#): List of derived tables acts like a chain of mutually-nested subqueries
  - **Target fix:** 5.1
- [Bug#40384](#): Gap in auto\_increment sequence when inserts fire a trigger
  - **Target fix:** 5.1
- [Bug#41371](#): Select returns 1 row with condition "col is not null and col is null"
  - **Target fix:** 5.1
- [Bug#45168](#): assertion with `convert()` and empty set value
  - **Target fix:** 5.1
- [Bug#33717](#): `INSERT...(default)` fails for enum. Crashes `CSV` tables, loads spaces for `MyISAM`



- **Target fix:** 5.1
- [Bug#38693](#): leaked memory with blobs!
  - **Target fix:** 5.1
- [Bug#44306](#): Assertion fail on duplicate key error in 'INSERT ... SELECT' statements
  - **Target fix:** 5.1
- [Bug#33844](#): Server crashes when client dies during `LOAD DATA INFILE`
  - **Target fix:** 5.1
- [Bug#40745](#): Error during `WHERE` clause calculation in `UPDATE` leads to an assertion failure
  - **Target fix:** 5.1
- [Bug#43385](#): Cannot `ALTER DATABASE ... UPGRADE DATA DIRECTORY NAME` when Views exist
  - **Target fix:** 5.1
- [Bug#40127](#): Multiple table `DELETE IGNORE` hangs on foreign key constraint violation on 5.0
  - **Target fix:** 5.1

#### Server: Errors

- [Bug#41121](#): "Statement is not safe to log in statement format" is prints table name only
  - **Target fix:** 5.1
- [Bug#41077](#): Warning contains wrong future version
  - **Target fix:** 5.1

#### Server: FTS

- [Bug#39746](#): Debug flag breaks struct definition (server crash)
  - **Target fix:** 5.1
- [Bug#28234](#): global/session scope - documentation vs implementation
  - **Target fix:** 5.1
- [Bug#42907](#): Multi-term boolean fulltext query containing a single quote fails in 5.1.x
  - **Target fix:** 5.1
- [Bug#39640](#): `ftb_query_add_word` does not recognise `MYSQL_FTFLAGS_NEED_COPY`
  - **Target fix:** 5.1

#### Server: GIS

- [Bug#31435](#): `ha_innodb.cc:3983: ulint convert_search_mode_to_innbase(ha_rkey_function): Asse`
  - **Target fix:** 5.1

#### Server: General

- [Bug#43748](#): crash when non-super user tries to kill the replication threads

- **Target fix:** 5.1.34
- [Bug#41456](#): `SET PASSWORD` hates `CURRENT_USER()`
  - **Target fix:** 5.1.31
- [Bug#41363](#): crash of `mysqld` on windows with aggregate in case
  - **Target fix:** 5.1.31
- [Bug#40104](#): regression with table names?
  - **Target fix:** 5.1
- [Bug#10206](#): InnoDB: Transaction requiring `Max_BinLog_Cache_size > 4GB` always rollback.
  - **Target fix:** 5.1
- [Bug#37284](#): Crash in `Field_string::type()`
  - **Target fix:** 5.1
- [Bug#41710](#): MySQL 5.1.30 crashes on the latest OpenSolaris 10
  - **Target fix:** 5.1
- [Bug#30261](#): "`mysqld --help`" no longer possible for root
  - **Target fix:** 5.1
- [Bug#38477](#): `my_pthread_setprio` can change dispatch class on Solaris, not just priority
  - **Target fix:** 5.1
- [Bug#44367](#): valgrind warnings with `find_in_set()` functions
  - **Target fix:** 5.1
- [Bug#38249](#): `innodb_log_arch_dir` still in support files
  - **Target fix:** 5.1
- [Bug#45195](#): valgrind warnings about uninitialized values in `store_record_in_cache()`
  - **Target fix:** 5.1
- [Bug#44664](#): valgrind warning for `COMMIT_AND_CHAIN` and `ROLLBACK_AND_CHAIN`
  - **Target fix:** 5.1
- [Bug#39265](#): `SQL_MODE OLD_NOT_NULL_CHECK_BEHAVIOUR` for backward compatibility
  - **Target fix:** 5.1
- [Bug#43962](#): "Packets out of order" calling a `SHOW TABLE STATUS`
  - **Target fix:** 5.1
- [Bug#34043](#): Server loops excessively in `_checkchunk()` when `safemalloc` is enabled
  - **Target fix:** 5.1
- [Bug#42158](#): leak: `SSL_get_peer_certificate()` doesn't have matching `X509_free()`
  - **Target fix:** 5.1
- [Bug#36751](#): Segmentation fault in `ctype-bin.c:308`; Linux 86\_64, `with-max-indexes=128`
  - **Target fix:** 5.1
- [Bug#40862](#): `main.subselect_notembedded` test case fails

- **Target fix:** 5.1
- [Bug#42957](#): no results from select where .. (col=col and col=col) or ... (false expression)
  - **Target fix:** 5.1
- [Bug#44358](#): valgrind errors with decode() function
  - **Target fix:** 5.1
- [Bug#40915](#): Events takes mutex in wrong order which can easily lead to deadlocks
  - **Target fix:** 5.1
- [Bug#44736](#): mySQLd\_safe's my\_which() is broken and doesn't find 'logger'
  - **Target fix:** 5.1
- [Bug#44638](#): mySQL\_upgrade, mySQLcheck output instance unclear
  - **Target fix:** 5.1
- [Bug#44365](#): valgrind warnings with encrypt() function
  - **Target fix:** 5.1
- [Bug#42146](#): DATETIME fractional seconds parse error
  - **Target fix:** 5.1
- [Bug#39178](#): Server crash in YaSSL with non-RSA-requesting client if server uses RSA key
  - **Target fix:** 5.1
- [Bug#44164](#): TL\_WRITE has no description in lock\_descriptions[]
  - **Target fix:** 5.1
- [Bug#40657](#): assertion with out of range variables and traditional sql\_mode
  - **Target fix:** 5.1
- [Bug#41612](#): resolve\_stack\_dump does not decode 5.1 stack trace
  - **Target fix:** 5.1

**Server: I\_S**

- [Bug#39541](#): CHECK TABLE on information\_schema myisam tables produces error
  - **Target fix:** 5.0.74
- [Bug#39955](#): SELECT on INFORMATION\_SCHEMA.GLOBAL\_VARIABLES takes too long
  - **Target fix:** 5.1
- [Bug#35275](#): INFORMATION\_SCHEMA.TABLES.CREATE\_OPTIONS omits KEY\_BLOCK\_SIZE
  - **Target fix:** 5.1
- [Bug#38918](#): selecting from information\_schema.columns is disproportionately slow
  - **Target fix:** 5.1
- [Bug#42758](#): INFORMATION\_SCHEMA.COLUMNS is inconsistent
  - **Target fix:** 5.1
- [Bug#38909](#): CREATE\_OPTIONS in information\_schema produces wrong results

- **Target fix:** 5.1
- [Bug#35789](#): wrong datatypes for collation and charset columns in [EVENTS](#), [ROUTINES](#), [TRIGGERS](#)
  - **Target fix:** 5.1

**Server: InnoDB**

- [Bug#39320](#): assert btr/btr0pcur.c line 217 -innodb\_locks\_unsafe\_for\_binlog or read committed
  - **Target fix:** 5.1.35
- [Bug#40386](#): Not flushing query cache after truncate
  - **Target fix:** 5.1.31
- [Bug#40360](#): Binlog related errors with binlog off
  - **Already fixed in:** 5.1.30
- [Bug#42400](#): InnoDB autoinc code can't handle floating-point columns
  - **Target fix:** 5.1
- [Bug#39438](#): Testcase for [Bug#39436](#) crashes on 5.1 in `fil_space_get_latch`
  - **Target fix:** 5.1
- [Bug#42101](#): Race condition in `innodb_commit_concurrency`
  - **Target fix:** 5.1
- [Bug#36169](#): create innodb compressed table with too large row size crashed
  - **Target fix:** 5.1
- [Bug#45097](#): Hang during recovery, redo logs for doublewrite buffer pages
  - **Target fix:** 5.1
- [Bug#44320](#): InnoDB: missing `DB_ROLL_PTR` in Table Monitor `COLUMNS` output
  - **Target fix:** 5.1
- [Bug#42152](#): Race condition in `lock_is_table_exclusive()`
  - **Target fix:** 5.1
- [Bug#39830](#): Table autoinc value not updated on first insert
  - **Target fix:** 5.1
- [Bug#38231](#): InnoDB crash in `lock_reset_all_on_table()` on `TRUNCATE + LOCK / UNLOCK`
  - **Target fix:** 5.1
- [Bug#38189](#): `innodb_stats_on_metadata` missing
  - **Target fix:** 5.1
- [Bug#44030](#): Error: (1500) Couldn't read the `MAX(ID)` autoinc value from the index (`PRIMARY`)
  - **Target fix:** 5.1
- [Bug#36411](#): "Failed to read auto-increment value from storage engine" in 5.1.24 auto-inc
  - **Target fix:** 5.1
- [Bug#43203](#): Overflow from auto incrementing causes server segv

- **Target fix:** 5.1
- [Bug#40369](#): `dtype_get_sql_null_size()` returns 0 or 1, not the size
  - **Target fix:** 5.1
- [Bug#39793](#): Foreign keys not constructed when column has a '#' in a comment or default value
  - **Target fix:** 5.1
- [Bug#42075](#): `dict_load_indexes` failure in `dict_load_table` will corrupt the dictionary cache
  - **Target fix:** 5.1
- [Bug#43660](#): `SHOW INDEXES/ANALYZE` does **NOT** update cardinality for indexes of InnoDB table
  - **Target fix:** 5.1
- [Bug#39648](#): Replication failure on `RBR` + InnoDB + 2 bit fields + `LIMIT` + no `PK`
  - **Target fix:** 5.1
- [Bug#42279](#): Race condition in `btr_search_drop_page_hash_when_freed()`
  - **Target fix:** 5.1
- [Bug#37885](#): `row_search_for_mysql` may gap lock unnecessarily with `SQL` comments in query
  - **Target fix:** 5.1
- [Bug#35498](#): Cannot get table `test/table1` auto-incrementer value in `::info`
  - **Target fix:** 5.1
- [Bug#42714](#): `AUTO_INCREMENT` errors in 5.1.31
  - **Target fix:** 5.1
- [Bug#41671](#): Semi-consistent read does not unlock rows in `READ COMMITTED` mode
  - **Target fix:** 5.1
- [Bug#32430](#): 'show innodb status' causes errors Invalid (old?) table or database name in logs
  - **Target fix:** 5.1

**Server: InnoDB Plugin**

- [Bug#37788](#): InnoDB Plugin: `AUTO_INCREMENT` wrong for compressed tables
  - **Target fix:** 5.1

**Server: Installing**

- [Bug#17270](#): mysql client tool could not find `../share/charsets` folder and fails.
  - **Target fix:** 5.1
- [Bug#41828](#): `mysql_install_db` misses `mysqld` options when using `--basedir`
  - **Target fix:** 5.1
- [Bug#41313](#): network administrator does not have `TRIGGER` and `EVENT` privileges
  - **Target fix:** 5.1
- [Bug#41998](#): Solaris 10 postinstall script fails to copy from wrong dir

- **Target fix:** 5.1

#### Server: Locking

- [Bug#41348](#): `INSERT INTO tbl SELECT * FROM temp_tbl` overwrites locking type of temp table
  - **Target fix:** 5.1.31
- [Bug#45066](#): `FLUSH TABLES WITH READ LOCK` deadlocks against `LOCK TABLE`
  - **Target fix:** 5.1
- [Bug#41110](#): crash with handler command when used concurrently with alter table
  - **Target fix:** 5.1
- [Bug#41140](#): Failure of replication on triggered insert if `innodb_autoinc_lock_mode > 0`
  - **Target fix:** 5.1
- [Bug#44672](#): Assertion failed: `thd->transaction.xid_state.xid.is_null()`
  - **Target fix:** 5.1
- [Bug#39843](#): `DELETE` requires write access to table in subquery in where clause
  - **Target fix:** 5.1
- [Bug#33278](#): `ANALYZE TABLE` in InnoDB holds exclusive locks on subsequent execution
  - **Target fix:** 5.1

#### Server: Logging

- [Bug#43885](#): `main.variables-big` fails because of warnings within the server log
  - **Target fix:** 5.1
- [Bug#37132](#): Logging to `slow_log` table fails with very slow queries
  - **Target fix:** 5.1
- [Bug#40281](#): partitioning the general log table crashes the server
  - **Target fix:** 5.1

#### Server: Memory

- [Bug#39886](#): Table full for `MEMORY` table is not written into error log
  - **Target fix:** 5.1

#### Server: Merge

- [Bug#40675](#): MySQL 5.1 crash with index merge algorithm and Merge tables
  - **Target fix:** 5.1.33
- [Bug#36171](#): `CREATE TEMPORARY TABLE` and `MERGE` engine
  - **Target fix:** 5.1
- [Bug#41305](#): server crashes when inserting duplicate row into a merge table

- **Target fix:** 5.1
- [Bug#44040](#): MySQL allows creating a `MERGE` table upon VIEWS but crashes when using it
  - **Target fix:** 5.1
- [Bug#41941](#): Failed `OPTIMIZE TABLE` is logged to binary log for `MERGE` engine
  - **Target fix:** 5.1
- [Bug#41212](#): crash after race condition between merge table and table\_cache evictions
  - **Target fix:** 5.1

**Server: MyISAM**

- [Bug#41574](#): `REPAIR TABLE`: crashes for compressed tables
  - **Target fix:** 5.1.31
- [Bug#40321](#): ha\_myisam::info could update rec\_per\_key incorrectly
  - **Target fix:** 5.1
- [Bug#40634](#): table scan temporary table is 4x slower due to mmap instead of caching
  - **Target fix:** 5.1
- [Bug#35111](#): Truncate a MyISAM partitioned table does not reset the auto\_increment value.
  - **Target fix:** 5.1
- [Bug#38848](#): myisam\_use\_mmap causes widespread myisam corruption on windows
  - **Target fix:** 5.1
- [Bug#37756](#): enabling fulltext indexes with myisam\_repair\_threads > 1 causes crash
  - **Target fix:** 5.1
- [Bug#43940](#): 64-bit windows myisamchk doesn't support key\_buffer\_size > 4G
  - **Target fix:** 5.1
- [Bug#37631](#): Incorrect key file for table after upgrading from 5.0 to 5.1
  - **Target fix:** 5.1
- [Bug#40827](#): Killing insert-select to MyISAM can cause table corruption
  - **Target fix:** 5.1

**Server: Optimizer**

- [Bug#37362](#): Crash in do\_field\_eq
  - **Target fix:** 5.1.36
- [Bug#34773](#): query with explain extended and derived table / other table crashes server
  - **Target fix:** 5.1.31
- [Bug#38842](#): Fix for 25951 seems incorrect
  - **Target fix:** 5.0.74
- [Bug#37742](#): `HA_EXTRA_KEYREAD` flag is set when key contains only prefix of requested column

- **Target fix:** 5.1
- [Bug#28554](#): Optimizer wrongly prefers index for (col = value) over (PK <= value)
  - **Target fix:** 5.1
- [Bug#44886](#): SIGSEGV in test\_if\_skip\_sort\_order() - uninitialized variable used as subscript
  - **Target fix:** 5.1
- [Bug#41543](#): Assertion `m\_status == DA\_ERROR' failed in Diagnostics\_area::sql\_errno
  - **Target fix:** 5.1
- [Bug#37936](#): ASSERT\_COLUMN\_MARKED\_FOR\_WRITE in Field\_datetime::store , Field\_varstring::store
  - **Target fix:** 5.1
- [Bug#37822](#): Correlated subquery with IN and IS UNKNOWN provides wrong result
  - **Target fix:** 5.1
- [Bug#36259](#): Optimizing with ORDER BY
  - **Target fix:** 5.1
- [Bug#31399](#): Wrong query result when doing join buffering over BIT fields
  - **Target fix:** 5.1
- [Bug#39433](#): poor optimized query
  - **Target fix:** 5.1

#### Server: Options

- [Bug#43835](#): SHOW VARIABLES does not include 0 for slave\_skip\_errors
  - **Target fix:** 5.1

#### Server: Packaging

- [Bug#43153](#): Version comment is too long
  - **Target fix:** 5.1.34
- [Bug#40845](#): Win inst shows screens with wrong naming "MySQL Monitoring and Advisory Service"
  - **Target fix:** 5.1.31
- [Bug#41838](#): shared-compat packages missing for Enterprise 5.1 builds
  - **Target fix:** 5.1.31
- [Bug#34025](#): mysql\_config is not returning -ldl lib flag needed when using embedded server
  - **Target fix:** 5.1.31
- [Bug#39074](#): Binaries do not work on Solaris 10 older than U5
  - **Already fixed in:** 5.1.30
- [Bug#31143](#): mysqlslap.exe (and other) missing in windows install packages
  - **Target fix:** 5.1
- [Bug#43918](#): Generated version string is too long for the binlog



- **Target fix:** 5.1
- [Bug#44496](#): No "MySQL Manual" in Install-Package
  - **Target fix:** 5.1
- [Bug#39641](#): mysql\_config --plugindir links to /usr/local/mysql/lib/plugin in tar.gz packages
  - **Target fix:** 5.1
- [Bug#39443](#): .pdb-files not delivered with 5.1.28
  - **Target fix:** 5.1
- [Bug#41577](#): improper value in example config file
  - **Target fix:** 5.1
- [Bug#44353](#): build-v9.bat is missing in source archive
  - **Target fix:** 5.1
- [Bug#41189](#): No debug symbols in 5.1.30 build for Mac OS X (mysql-5.1.30-osx10.5-x86.dmg)
  - **Target fix:** 5.1
- [Bug#37697](#): make\_binary\_distribution places files in wrong path
  - **Target fix:** 5.1

#### Server: Parser

- [Bug#39559](#): dump of stored procedures / functions with C-style comment can't be read back
  - **Target fix:** 5.1
- [Bug#45010](#): invalid memory reads during parsing some strange statements
  - **Target fix:** 5.1
- [Bug#25250](#): alter table allows simultaneous drop/add foreign keys
  - **Target fix:** 5.1
- [Bug#38159](#): Function parsing problem generates misleading error message
  - **Target fix:** 5.1
- [Bug#43746](#): YACC return wrong query string when parse 'load data infile' sql statement
  - **Target fix:** 5.1

#### Server: Partition

- [Bug#40954](#): Crash in MyISAM index code with concurrency test using partitioned tables
  - The crash is observed with queries of the form "SELECT \* FROM part\_table WHERE a < const ORDER BY a" or "SELECT \* FROM part\_table WHERE a <> ORDER BY a" where a is an indexed column used as the partition key. The crash can be avoided by 'limiting' the where clause with a very low value as in: "SELECT \* FROM part\_table WHERE a < const AND a > -1000 ORDER BY a" or "SELECT \* FROM part\_table WHERE a <> AND a > -1000 ORDER BY a"
    - **Target fix:** 5.1.31
- [Bug#39434](#): ALTER TABLE CHECK/OPTIMIZE/ANALYZE PARTITION work on non-partitioned table
  - **Target fix:** 5.1.31

- [Bug#14326](#): No formatting of `SHOW CREATE TABLE` output
  - **Target fix:** 5.1.31
- [Bug#37721](#): `ORDER BY` when `WHERE` contains non-partitioned index column
  - **Target fix:** 5.1.31
- [Bug#40176](#): Combination of event, trigger and partitioning breaks auto increment
  - **Target fix:** 5.1.31
- [Bug#40494](#): `MYSQL` server crashes on range access with partitioning and order by
  - **Already fixed in:** 5.1.30
- [Bug#40972](#): Partition pruning can lead to crash for bad dates
  - **Target fix:** 5.1
- [Bug#40515](#): Query on a partitioned table does not return 'lock wait timeout exceeded'
  - **Target fix:** 5.1
- [Bug#42849](#): innodb crash with varying `time_zone` on partitioned timestamp primary key
  - **Target fix:** 5.1
- [Bug#40389](#): `REORGANIZE PARTITION` crashes when only using one partition
  - **Target fix:** 5.1
- [Bug#44821](#): select distinct on partitioned table returns wrong results
  - **Target fix:** 5.1
- [Bug#44653](#): Server crash noticed when executing random queries with partitions.
  - **Target fix:** 5.1
- [Bug#36001](#): Partitions: spelling and using some error messages
  - **Target fix:** 5.1
- [Bug#36312](#): InnoDB `DATA_FREE` BUG?
  - **Target fix:** 5.1
- [Bug#37453](#): Dropping/creating index on partitioned table with InnoDB Plugin locks table
  - **Target fix:** 5.1
- [Bug#42944](#): partition not pruned correctly
  - **Target fix:** 5.1
- [Bug#39084](#): Getting intermittent errors with statement-based binary logging
  - **Target fix:** 5.1
- [Bug#38719](#): Partitioning returns a different error code for a duplicate key error
  - **Target fix:** 5.1
- [Bug#30102](#): rename table does corrupt tables with partition files on failure
  - **Target fix:** 5.1

**Server: Privileges**

- [Bug#37191](#): Failed assertion in `CREATE VIEW`
  - **Target fix:** 5.1
- [Bug#30305](#): Create routine in wrong context in `SHOW PRIVILEGES`
  - **Target fix:** 5.1

#### Server: Query Cache

- [Bug#43758](#): Query cache can lock up threads in 'freeing items' state
  - **Target fix:** 5.1.36
- [Bug#43861](#): `main.query_cache_28249` fails sporadically
  - **Target fix:** 5.1
- [Bug#41098](#): Query Cache returns wrong result with concurrent insert
  - **Target fix:** 5.1

#### Server: RBR

- [Bug#42977](#): RBR logs for rows with more than 250 column results in corrupt binlog.
  - **Target fix:** 5.1.34
- [Bug#41986](#): Replication slave does not pick up proper `AUTO_INCREMENT` value for InnoDB tables
  - **Target fix:** 5.1.31
- [Bug#40221](#): Replication failure on RBR + UPDATE the primary key
  - **Target fix:** 5.1.31
- [Bug#40004](#): Replication failure with no PK + no indexes
  - **Already fixed in:** 5.1.30
- [Bug#39934](#): Slave stops for engine that only support row-based logging
  - **Target fix:** 5.1
- [Bug#40278](#): Replication failure on RBR + MyISAM + SAVEPOINTS
  - **Target fix:** 5.1
- [Bug#39701](#): Mixed binlog format does not switch to row mode on `LOAD_FILE`
  - **Target fix:** 5.1
- [Bug#31502](#): 5.1.20 -> 5.1.22 Slave crashes if it gets an event w/ data for non-existent column
  - **Target fix:** 5.1
- [Bug#45243](#): crash on win in sql thread `clear_tables_to_lock()` -> `free()`
  - **Target fix:** 5.1
- [Bug#38230](#): Differences between master and slave after UPDATE or DELETE with LIMIT with pk
  - **Target fix:** 5.1
- [Bug#39753](#): Replication failure on MIXED + bit + myisam + no PK
  - **Target fix:** 5.1

- [Bug#42914](#): non-updated blob columns are included in [RBR](#) binlog record.
  - **Target fix:** 5.1
- [Bug#42749](#): infinite loop writing to row based binlog - processlist shows "freeing items"
  - **Target fix:** 5.1

#### Server: Replication

- [Bug#40116](#): Uncommitted changes are replicated and stay on slave after rollback on master
  - **Target fix:** 5.1.31
- [Bug#40482](#): server/mysqlbinlog crashes when reading invalid Incident\_log\_event
  - **Target fix:** 5.1
- [Bug#43579](#): mysql\_upgrade tries to alter log tables on replicated database
  - **Target fix:** 5.1
- [Bug#42851](#): Spurious "Statement is not safe to log in statement format." warnings
  - **Target fix:** 5.1
- [Bug#45242](#): crash on win in mysql\_close() -> free()
  - **Target fix:** 5.1
- [Bug#41980](#): [SBL](#), [INSERT .. SELECT .. LIMIT = ERROR](#), even when @@SQL\_LOG\_BIN is 0 !
  - **Target fix:** 5.1
- [Bug#40796](#): Crash due to heap corruption in rpl.rpl\_extraColmaster\_myisam
  - **Target fix:** 5.1
- [Bug#34739](#): unexpected binlog file name when --log-bin is set to a directory name
  - **Target fix:** 5.1
- [Bug#38174](#): secure-file-priv breaks [LOAD DATA INFILE](#) replication in statement mode
  - **Target fix:** 5.1
- [Bug#35583](#): mysqlbinlog replay fails with [ERROR 1146](#) when temp tables are used
  - **Target fix:** 5.1
- [Bug#40013](#): mixed replication: row based format could lead to stale tmp tables on the slave
  - **Target fix:** 5.1
- [Bug#44179](#): reset slave crashes in my\_error when reset\_logs returns non-zero
  - **Target fix:** 5.1
- [Bug#36763](#): [TRUNCATE TABLE](#) fails to replicate when stmt-based binlogging is not supported.
  - **Target fix:** 5.1
- [Bug#34628](#): [LOAD DATA CONCURRENT INFILE](#) drops [CONCURRENT](#) in binary log
  - **Target fix:** 5.1
- [Bug#38934](#): slave slave until does not work with --replicate-same-server-id
  - **Target fix:** 5.1

- [Bug#41948](#): Query\_log\_event constructor needlessly contorted
  - **Target fix:** 5.1
- [Bug#44181](#): `CHANGE MASTER` complains Could not initialize master info
  - **Target fix:** 5.1
- [Bug#34541](#): mysqlbinlog prints 'set;' in stm mode after changing autocommit mode
  - **Target fix:** 5.1
- [Bug#39526](#): sql\_mode not retained in binary log for `CREATE PROCEDURE`
  - **Target fix:** 5.1
- [Bug#31240](#): load data infile replication between (4.0 or 4.1) and 5.1 fails
  - **Target fix:** 5.1
- [Bug#38205](#): Row-based Replication (RBR) causes inconsistencies: `HA_ERR_FOUND_DUPP_KEY`
  - **Target fix:** 5.1
- [Bug#45238](#): `rpl_slave_skip`, `rpl_change_master` failed (lost connection) for `STOP SLAVE`
  - **Target fix:** 5.1
- [Bug#44442](#): Incident events are silent in mysqlbinlog output
  - **Target fix:** 5.1
- [Bug#22504](#): load data infile sql statement in replication architecture get error
  - **Target fix:** 5.1
- [Bug#42861](#): Assigning invalid directories to `--slave-load-tmpdir` crashes the slave
  - **Target fix:** 5.1
- [Bug#42829](#): binlogging enabled for all schemas regardless of `binlog-db-db` / `binlog-ignore-db`
  - **Target fix:** 5.1
- [Bug#41166](#): stored function requires "deterministic" if `binlog_format` is "statement"
  - **Target fix:** 5.1
- [Bug#39393](#): `slave-skip-errors` does not work when using `ROW` based replication
  - **Target fix:** 5.1
- [Bug#44270](#): `RESET SLAVE` does not reset `Last_IO_Error` or `Last_IO_Errno`
  - **Target fix:** 5.1
- [Bug#42415](#): `UPDATE` with `LIMIT` clause unsafe for statement format even when `ORDER BY PK`
  - **Target fix:** 5.1
- [Bug#44331](#): Restore of database with events produces warning in replication
  - **Target fix:** 5.1
- [Bug#32228](#): A disk full makes binary log corrupt.
  - **Target fix:** 5.1
- [Bug#41961](#): Some `log_event` types do not skip post-header when reading
  - **Target fix:** 5.1

- [Bug#45214](#): `get_master_version_and_clock` does not report error when queries fail
  - **Target fix:** 5.1
- [Bug#38197](#): Errors in `@@init_slave` not visible in 'show slave status'
  - **Target fix:** 5.1

#### Server: SE API

- [Bug#38338](#): `REPLACE` causes `last_insert_id()` to return an incorrect value
  - **Target fix:** 5.1

#### Server: SP

- [Bug#42188](#): crash and/or memory corruption with user variables in trigger
  - **Target fix:** 5.1.32
- [Bug#38066](#): Events log 'note' level messages by default in the error log
  - **Target fix:** 5.1.31
- [Bug#40770](#): Server Crash when running with triggers including variable settings (`rpl_sys`)
  - The crash is observed when the trigger/SP assigns values to user variables. The crash can be avoided by using local variables instead of user variables in the trigger/SP code.
  - **Target fix:** 5.1.31
- [Bug#43884](#): `SP` + filename param as `TEXT` + `LOAD_FILE` inside, causes valgrind warnings in `PB`
  - **Target fix:** 5.1
- [Bug#41726](#): upgrade from 5.0 to 5.1.30 crashes if you didn't run `mysql_upgrade`
  - **Target fix:** 5.1
- [Bug#43587](#): Putting `event_scheduler=1` in init `SQL` file crashes `mysqld`
  - **Target fix:** 5.1
- [Bug#36540](#): `CREATE EVENT` and `ALTER EVENT` statements fail with large `server_id`
  - **Target fix:** 5.1
- [Bug#45235](#): 5.1 does not support 5.0-only syntax triggers in any way
  - **Target fix:** 5.1

#### Server: Types

- [Bug#42014](#): Crash, `name_const` with collate
  - **Target fix:** 5.1.32
- [Bug#35558](#): Wrong server metadata blows up the client
  - **Target fix:** 5.1

#### Server: Views

- [Bug#40825](#): Error 1356 while selecting from a view with a "`HAVING`" clause though query works

- **Target fix:** 5.1

#### Server: XML

- [Bug#43183](#): ExtractValue() brings result list in missorder
  - **Target fix:** 5.1.36 5.0
- [Bug#42495](#): updatexml: Assertion failed: xpath->context, file .\item\_xmlfunc.cc, line 2507
  - **Target fix:** 5.1.32
- [Bug#38227](#): `EXTRACTVALUE` doesn't work with `DTD` declarations
  - **Target fix:** 5.1

#### Tests: Replication

- [Bug#43913](#): rpl\_cross\_version can't pass on conflicts complainig clash with --slave-load-tm
  - **Target fix:** 5.1

#### Tests: Server

- [Bug#42383](#): main.innodb\_bug39438: Can't create table 'test.bug39438'
  - **Target fix:** 5.1

#### libmysqld

- [Bug#44091](#): libmysqld gets stuck waiting on mutex on initialization
  - **Target fix:** 5.1.35
- [Bug#43706](#): libmysqld segfaults when re-intialised
  - **Target fix:** 5.1
- [Bug#43733](#): Select on processlist let the embedded server crash (concurrent\_innodb\_safelog)
  - **Target fix:** 5.1
- [Bug#38293](#): Libmysqld crash in mysql\_library\_init if language file missing
  - **Target fix:** 5.1
- [Bug#39289](#): libmysqld.a calls exit() upon error
  - **Target fix:** 5.1
- [Bug#37995](#): Error message truncation in test "innodb" in embedded mode
  - **Target fix:** 5.1
- [Bug#34517](#): `SHOW GLOBAL STATUS` does not work properly in embedded server.
  - **Target fix:** 5.1
- [Bug#38522](#): 5 seconds delay when closing application using embedded server
  - **Target fix:** 5.1

## B.1.8.2. Additional Known Issues

The following problems are also known and fixing them is also a high priority:

- MySQL Cluster fails to recover from an out-of-disk failure when using disk data. ([Bug#17614](#))
- Subquery optimization for `IN` is not as effective as for `=`.
- Even if you use `lower_case_table_names=2` (which enables MySQL to remember the case used for databases and table names), MySQL does not remember the case used for database names for the function `DATABASE()` or within the various logs (on case-insensitive systems).
- Dropping a `FOREIGN KEY` constraint doesn't work in replication because the constraint may have another name on the slave.
- `REPLACE` (and `LOAD DATA` with the `REPLACE` option) does not trigger `ON DELETE CASCADE`.
- `DISTINCT` with `ORDER BY` doesn't work inside `GROUP_CONCAT()` if you don't use all and only those columns that are in the `DISTINCT` list.
- If one user has a long-running transaction and another user drops a table that is updated in the transaction, there is small chance that the binary log may contain the `DROP TABLE` command before the table is used in the transaction itself. We plan to fix this by having the `DROP TABLE` command wait until the table is not being used in any transaction.
- When inserting a big integer value (between  $2^{63}$  and  $2^{64}-1$ ) into a decimal or string column, it is inserted as a negative value because the number is evaluated in a signed integer context.
- `FLUSH TABLES WITH READ LOCK` does not block `COMMIT` if the server is running without binary logging, which may cause a problem (of consistency between tables) when doing a full backup.
- `ANALYZE TABLE`, `OPTIMIZE TABLE`, and `REPAIR TABLE` may cause problems on tables for which you are using `INSERT DELAYED`.
- Performing `LOCK TABLE ...` and `FLUSH TABLES ...` doesn't guarantee that there isn't a half-finished transaction in progress on the table.
- Replication uses query-level logging: The master writes the executed queries to the binary log. This is a very fast, compact, and efficient logging method that works perfectly in most cases.

It is possible for the data on the master and slave to become different if a query is designed in such a way that the data modification is non-deterministic (generally not a recommended practice, even outside of replication).

For example:

- `CREATE ... SELECT` or `INSERT ... SELECT` statements that insert zero or `NULL` values into an `AUTO_INCREMENT` column.
- `DELETE` if you are deleting rows from a table that has foreign keys with `ON DELETE CASCADE` properties.
- `REPLACE ... SELECT`, `INSERT IGNORE ... SELECT` if you have duplicate key values in the inserted data.

**If and only if the preceding queries have no `ORDER BY` clause guaranteeing a deterministic order.**

For example, for `INSERT ... SELECT` with no `ORDER BY`, the `SELECT` may return rows in a different order (which results in a row having different ranks, hence getting a different number in the `AUTO_INCREMENT` column), depending on the choices made by the optimizers on the master and slave.

A query is optimized differently on the master and slave only if:

- The table is stored using a different storage engine on the master than on the slave. (It is possible to use different storage engines on the master and slave. For example, you can use `InnoDB` on the master, but `MyISAM` on the slave if the slave has less available disk space.)
- MySQL buffer sizes (`key_buffer_size`, and so on) are different on the master and slave.
- The master and slave run different MySQL versions, and the optimizer code differs between these versions.

This problem may also affect database restoration using `mysqlbinlog|mysql`.

The easiest way to avoid this problem is to add an `ORDER BY` clause to the aforementioned non-deterministic queries to ensure that the rows are always stored or modified in the same order.



In future MySQL versions, we will automatically add an `ORDER BY` clause when needed.

The following issues are known and will be fixed in due time:

- Log file names are based on the server host name (if you don't specify a file name with the startup option). You have to use options such as `--log-bin=old_host_name-bin` if you change your host name to something else. Another option is to rename the old files to reflect your host name change (if these are binary logs, you need to edit the binary log index file and fix the binlog names there as well). See [Section 5.1.2, “Server Command Options”](#).
- `mysqlbinlog` does not delete temporary files left after a `LOAD DATA INFILE` command. See [Section 4.6.7, “mysqlbinlog — Utility for Processing Binary Log Files”](#).
- `RENAME` doesn't work with `TEMPORARY` tables or tables used in a `MERGE` table.
- Due to the way table format (`.frm`) files are stored, you cannot use character 255 (`CHAR(255)`) in table names, column names, or enumerations. This is scheduled to be fixed in version 5.1 when we implement new table definition format files.
- When using `SET CHARACTER SET`, you can't use translated characters in database, table, and column names.
- You can't use “\_” or “%” with `ESCAPE` in `LIKE ... ESCAPE`.
- You cannot build the server in another directory when using MIT-pthreads. Because this requires changes to MIT-pthreads, we are not likely to fix this. See [Section 2.10.5, “MIT-pthreads Notes”](#).
- `BLOB` and `TEXT` values can't reliably be used in `GROUP BY`, `ORDER BY` or `DISTINCT`. Only the first `max_sort_length` bytes are used when comparing `BLOB` values in these cases. The default value of `max_sort_length` is 1024 and can be changed at server startup time or at runtime.
- Numeric calculations are done with `BIGINT` or `DOUBLE` (both are normally 64 bits long). Which precision you get depends on the function. The general rule is that bit functions are performed with `BIGINT` precision, `IF()` and `ELT()` with `BIGINT` or `DOUBLE` precision, and the rest with `DOUBLE` precision. You should try to avoid using unsigned long long values if they resolve to be larger than 63 bits (9223372036854775807) for anything other than bit fields.
- You can have up to 255 `ENUM` and `SET` columns in one table.
- In `MIN()`, `MAX()`, and other aggregate functions, MySQL currently compares `ENUM` and `SET` columns by their string value rather than by the string's relative position in the set.
- `mysqld_safe` redirects all messages from `mysqld` to the `mysqld` log. One problem with this is that if you execute `mysqladmin refresh` to close and reopen the log, `stdout` and `stderr` are still redirected to the old log. If you use the general query log extensively, you should edit `mysqld_safe` to log to `host_name.err` instead of `host_name.log` so that you can easily reclaim the space for the old log by deleting it and executing `mysqladmin refresh`.
- In an `UPDATE` statement, columns are updated from left to right. If you refer to an updated column, you get the updated value instead of the original value. For example, the following statement increments `KEY` by 2, not 1:
 

```
mysql> UPDATE tbl_name SET KEY=KEY+1,KEY=KEY+1;
```
- You can refer to multiple temporary tables in the same query, but you cannot refer to any given temporary table more than once. For example, the following doesn't work:
 

```
mysql> SELECT * FROM temp_table, temp_table AS t2;
ERROR 1137: Can't reopen table: 'temp_table'
```
- The optimizer may handle `DISTINCT` differently when you are using “hidden” columns in a join than when you are not. In a join, hidden columns are counted as part of the result (even if they are not shown), whereas in normal queries, hidden columns don't participate in the `DISTINCT` comparison. We will probably change this in the future to never compare the hidden columns when executing `DISTINCT`.

An example of this is:

```
SELECT DISTINCT mp3id FROM band_downloads
WHERE userid = 9 ORDER BY id DESC;
```

and

```
SELECT DISTINCT band_downloads.mp3id
FROM band_downloads,band_mp3
```

```
WHERE band_downloads.userid = 9
AND band_mp3.id = band_downloads.mp3id
ORDER BY band_downloads.id DESC;
```

In the second case, using MySQL Server 3.23.x, you may get two identical rows in the result set (because the values in the hidden `id` column may differ).

Note that this happens only for queries where that do not have the `ORDER BY` columns in the result.

- If you execute a `PROCEDURE` on a query that returns an empty set, in some cases the `PROCEDURE` does not transform the columns.
- Creation of a table of type `MERGE` doesn't check whether the underlying tables are compatible types.
- If you use `ALTER TABLE` to add a `UNIQUE` index to a table used in a `MERGE` table and then add a normal index on the `MERGE` table, the key order is different for the tables if there was an old, non-`UNIQUE` key in the table. This is because `ALTER TABLE` puts `UNIQUE` indexes before normal indexes to be able to detect duplicate keys as early as possible.

## B.2. Types of Error Values

When an error occurs in MySQL, the server returns two types of error values:

- A MySQL-specific error code. This value is numeric. It is not portable to other database systems.
- An SQLSTATE value. The value is a five-character string (for example, `'42S02'`). The values are specified by ANSI SQL and ODBC and are more standardized.

When an error occurs, you can access the MySQL error code, the SQLSTATE value, and a string containing an error message using C API functions:

- MySQL error code: Call `mysql_errno()`
- SQLSTATE value: Call `mysql_sqlstate()`
- Error message: Call `mysql_error()`

For prepared statements, the corresponding error functions are `mysql_stmt_errno()`, `mysql_stmt_sqlstate()`, and `mysql_stmt_error()`. All error functions are described in [Section 20.10, “MySQL C API”](#).

The first two characters of an SQLSTATE value indicate the error class:

- `'00'` indicates success.
- `'01'` indicates a warning.
- `'02'` indicates “not found.” These values are relevant only within the context of cursors and are used to control what happens when a cursor reaches the end of a data set.
- Other values indicate an exception.

## B.3. Server Error Codes and Messages

MySQL programs have access to several types of error information when the server returns an error. For example, the `mysql` client program displays errors using the following format:

```
shell> SELECT * FROM no_such_table;
ERROR 1146 (42S02): Table 'test.no_such_table' doesn't exist
```

The message displayed contains three types of information:

- A numeric error code (`1146`). This number is MySQL-specific and is not portable to other database systems.

- A five-character SQLSTATE value ('42S02'). The values are specified by ANSI SQL and ODBC and are more standardized. Not all MySQL error numbers are mapped to SQLSTATE error codes. The value 'HY000' (general error) is used for unmapped errors.
- A string that provides a textual description of the error.

Server error information comes from the following source files. For details about the way that error information is defined, see the MySQL Internals manual, available at <http://dev.mysql.com/doc/>.

- Error message information is listed in the `share/errmsg.txt` file. `%d` and `%s` represent numbers and strings, respectively, that are substituted into the Message values when they are displayed.
- The Error values listed in `share/errmsg.txt` are used to generate the definitions in the `include/mysqld_error.h` and `include/mysqld_ename.h` MySQL source files.
- The SQLSTATE values listed in `share/errmsg.txt` are used to generate the definitions in the `include/sql_state.h` MySQL source file.

Because updates are frequent, it is possible that those files will contain additional error information not listed here.

- Error: 1000 SQLSTATE: HY000 (ER\_HASHCHK)  
Message: hashchk
- Error: 1001 SQLSTATE: HY000 (ER\_NISAMCHK)  
Message: isamchk
- Error: 1002 SQLSTATE: HY000 (ER\_NO)  
Message: NO
- Error: 1003 SQLSTATE: HY000 (ER\_YES)  
Message: YES
- Error: 1004 SQLSTATE: HY000 (ER\_CANT\_CREATE\_FILE)  
Message: Can't create file '%s' (errno: %d)
- Error: 1005 SQLSTATE: HY000 (ER\_CANT\_CREATE\_TABLE)  
Message: Can't create table '%s' (errno: %d)
- Error: 1006 SQLSTATE: HY000 (ER\_CANT\_CREATE\_DB)  
Message: Can't create database '%s' (errno: %d)
- Error: 1007 SQLSTATE: HY000 (ER\_DB\_CREATE\_EXISTS)  
Message: Can't create database '%s'; database exists
- Error: 1008 SQLSTATE: HY000 (ER\_DB\_DROP\_EXISTS)  
Message: Can't drop database '%s'; database doesn't exist
- Error: 1009 SQLSTATE: HY000 (ER\_DB\_DROP\_DELETE)  
Message: Error dropping database (can't delete '%s', errno: %d)
- Error: 1010 SQLSTATE: HY000 (ER\_DB\_DROP\_RMDIR)  
Message: Error dropping database (can't rmdir '%s', errno: %d)
- Error: 1011 SQLSTATE: HY000 (ER\_CANT\_DELETE\_FILE)  
Message: Error on delete of '%s' (errno: %d)

- Error: 1012 SQLSTATE: HY000 ([ER\\_CANT\\_FIND\\_SYSTEM\\_REC](#))  
Message: Can't read record in system table
- Error: 1013 SQLSTATE: HY000 ([ER\\_CANT\\_GET\\_STAT](#))  
Message: Can't get status of '%s' (errno: %d)
- Error: 1014 SQLSTATE: HY000 ([ER\\_CANT\\_GET\\_WD](#))  
Message: Can't get working directory (errno: %d)
- Error: 1015 SQLSTATE: HY000 ([ER\\_CANT\\_LOCK](#))  
Message: Can't lock file (errno: %d)
- Error: 1016 SQLSTATE: HY000 ([ER\\_CANT\\_OPEN\\_FILE](#))  
Message: Can't open file: '%s' (errno: %d)
- Error: 1017 SQLSTATE: HY000 ([ER\\_FILE\\_NOT\\_FOUND](#))  
Message: Can't find file: '%s' (errno: %d)
- Error: 1018 SQLSTATE: HY000 ([ER\\_CANT\\_READ\\_DIR](#))  
Message: Can't read dir of '%s' (errno: %d)
- Error: 1019 SQLSTATE: HY000 ([ER\\_CANT\\_SET\\_WD](#))  
Message: Can't change dir to '%s' (errno: %d)
- Error: 1020 SQLSTATE: HY000 ([ER\\_CHECKREAD](#))  
Message: Record has changed since last read in table '%s'
- Error: 1021 SQLSTATE: HY000 ([ER\\_DISK\\_FULL](#))  
Message: Disk full (%s); waiting for someone to free some space...
- Error: 1022 SQLSTATE: 23000 ([ER\\_DUP\\_KEY](#))  
Message: Can't write; duplicate key in table '%s'
- Error: 1023 SQLSTATE: HY000 ([ER\\_ERROR\\_ON\\_CLOSE](#))  
Message: Error on close of '%s' (errno: %d)
- Error: 1024 SQLSTATE: HY000 ([ER\\_ERROR\\_ON\\_READ](#))  
Message: Error reading file '%s' (errno: %d)
- Error: 1025 SQLSTATE: HY000 ([ER\\_ERROR\\_ON\\_RENAME](#))  
Message: Error on rename of '%s' to '%s' (errno: %d)
- Error: 1026 SQLSTATE: HY000 ([ER\\_ERROR\\_ON\\_WRITE](#))  
Message: Error writing file '%s' (errno: %d)
- Error: 1027 SQLSTATE: HY000 ([ER\\_FILE\\_USED](#))  
Message: '%s' is locked against change
- Error: 1028 SQLSTATE: HY000 ([ER\\_FILSORT\\_ABORT](#))  
Message: Sort aborted
- Error: 1029 SQLSTATE: HY000 ([ER\\_FORM\\_NOT\\_FOUND](#))  
Message: View '%s' doesn't exist for '%s'

- Error: [1030](#) SQLSTATE: [HY000](#) ([ER\\_GET\\_ERRNO](#))  
 Message: Got error %d from storage engine
- Error: [1031](#) SQLSTATE: [HY000](#) ([ER\\_ILLEGAL HA](#))  
 Message: Table storage engine for '%s' doesn't have this option
- Error: [1032](#) SQLSTATE: [HY000](#) ([ER\\_KEY\\_NOT\\_FOUND](#))  
 Message: Can't find record in '%s'
- Error: [1033](#) SQLSTATE: [HY000](#) ([ER\\_NOT\\_FORM\\_FILE](#))  
 Message: Incorrect information in file: '%s'
- Error: [1034](#) SQLSTATE: [HY000](#) ([ER\\_NOT\\_KEYFILE](#))  
 Message: Incorrect key file for table '%s'; try to repair it
- Error: [1035](#) SQLSTATE: [HY000](#) ([ER\\_OLD\\_KEYFILE](#))  
 Message: Old key file for table '%s'; repair it!
- Error: [1036](#) SQLSTATE: [HY000](#) ([ER\\_OPEN\\_AS\\_READONLY](#))  
 Message: Table '%s' is read only
- Error: [1037](#) SQLSTATE: [HY001](#) ([ER\\_OUTOFMEMORY](#))  
 Message: Out of memory; restart server and try again (needed %d bytes)
- Error: [1038](#) SQLSTATE: [HY001](#) ([ER\\_OUT\\_OF\\_SORTMEMORY](#))  
 Message: Out of sort memory; increase server sort buffer size
- Error: [1039](#) SQLSTATE: [HY000](#) ([ER\\_UNEXPECTED\\_EOF](#))  
 Message: Unexpected EOF found when reading file '%s' (errno: %d)
- Error: [1040](#) SQLSTATE: [08004](#) ([ER\\_CON\\_COUNT\\_ERROR](#))  
 Message: Too many connections
- Error: [1041](#) SQLSTATE: [HY000](#) ([ER\\_OUT\\_OF\\_RESOURCES](#))  
 Message: Out of memory; check if mysqld or some other process uses all available memory; if not, you may have to use 'ulimit' to allow mysqld to use more memory or you can add more swap space
- Error: [1042](#) SQLSTATE: [08S01](#) ([ER\\_BAD\\_HOST\\_ERROR](#))  
 Message: Can't get hostname for your address
- Error: [1043](#) SQLSTATE: [08S01](#) ([ER\\_HANDSHAKE\\_ERROR](#))  
 Message: Bad handshake
- Error: [1044](#) SQLSTATE: [42000](#) ([ER\\_DBACCESS\\_DENIED\\_ERROR](#))  
 Message: Access denied for user '%s'@'%s' to database '%s'
- Error: [1045](#) SQLSTATE: [28000](#) ([ER\\_ACCESS\\_DENIED\\_ERROR](#))  
 Message: Access denied for user '%s'@'%s' (using password: %s)
- Error: [1046](#) SQLSTATE: [3D000](#) ([ER\\_NO\\_DB\\_ERROR](#))  
 Message: No database selected
- Error: [1047](#) SQLSTATE: [08S01](#) ([ER\\_UNKNOWN\\_COM\\_ERROR](#))  
 Message: Unknown command

- Error: 1048 SQLSTATE: 23000 ([ER\\_BAD\\_NULL\\_ERROR](#))  
Message: Column '%s' cannot be null
- Error: 1049 SQLSTATE: 42000 ([ER\\_BAD\\_DB\\_ERROR](#))  
Message: Unknown database '%s'
- Error: 1050 SQLSTATE: 42S01 ([ER\\_TABLE\\_EXISTS\\_ERROR](#))  
Message: Table '%s' already exists
- Error: 1051 SQLSTATE: 42S02 ([ER\\_BAD\\_TABLE\\_ERROR](#))  
Message: Unknown table '%s'
- Error: 1052 SQLSTATE: 23000 ([ER\\_NON\\_UNIQ\\_ERROR](#))  
Message: Column '%s' in %s is ambiguous
- Error: 1053 SQLSTATE: 08S01 ([ER\\_SERVER\\_SHUTDOWN](#))  
Message: Server shutdown in progress
- Error: 1054 SQLSTATE: 42S22 ([ER\\_BAD\\_FIELD\\_ERROR](#))  
Message: Unknown column '%s' in '%s'
- Error: 1055 SQLSTATE: 42000 ([ER\\_WRONG\\_FIELD\\_WITH\\_GROUP](#))  
Message: '%s' isn't in GROUP BY
- Error: 1056 SQLSTATE: 42000 ([ER\\_WRONG\\_GROUP\\_FIELD](#))  
Message: Can't group on '%s'
- Error: 1057 SQLSTATE: 42000 ([ER\\_WRONG\\_SUM\\_SELECT](#))  
Message: Statement has sum functions and columns in same statement
- Error: 1058 SQLSTATE: 21S01 ([ER\\_WRONG\\_VALUE\\_COUNT](#))  
Message: Column count doesn't match value count
- Error: 1059 SQLSTATE: 42000 ([ER\\_TOO\\_LONG\\_IDENT](#))  
Message: Identifier name '%s' is too long
- Error: 1060 SQLSTATE: 42S21 ([ER\\_DUP\\_FIELDNAME](#))  
Message: Duplicate column name '%s'
- Error: 1061 SQLSTATE: 42000 ([ER\\_DUP\\_KEYNAME](#))  
Message: Duplicate key name '%s'
- Error: 1062 SQLSTATE: 23000 ([ER\\_DUP\\_ENTRY](#))  
Message: Duplicate entry '%s' for key %d
- Error: 1063 SQLSTATE: 42000 ([ER\\_WRONG\\_FIELD\\_SPEC](#))  
Message: Incorrect column specifier for column '%s'
- Error: 1064 SQLSTATE: 42000 ([ER\\_PARSE\\_ERROR](#))  
Message: %s near '%s' at line %d
- Error: 1065 SQLSTATE: 42000 ([ER\\_EMPTY\\_QUERY](#))  
Message: Query was empty

- Error: 1066 SQLSTATE: 42000 ([ER\\_NONUNIQ\\_TABLE](#))  
Message: Not unique table/alias: '%s'
- Error: 1067 SQLSTATE: 42000 ([ER\\_INVALID\\_DEFAULT](#))  
Message: Invalid default value for '%s'
- Error: 1068 SQLSTATE: 42000 ([ER\\_MULTIPLE\\_PRI\\_KEY](#))  
Message: Multiple primary key defined
- Error: 1069 SQLSTATE: 42000 ([ER\\_TOO\\_MANY\\_KEYS](#))  
Message: Too many keys specified; max %d keys allowed
- Error: 1070 SQLSTATE: 42000 ([ER\\_TOO\\_MANY\\_KEY\\_PARTS](#))  
Message: Too many key parts specified; max %d parts allowed
- Error: 1071 SQLSTATE: 42000 ([ER\\_TOO\\_LONG\\_KEY](#))  
Message: Specified key was too long; max key length is %d bytes
- Error: 1072 SQLSTATE: 42000 ([ER\\_KEY\\_COLUMN\\_DOES\\_NOT\\_EXISTS](#))  
Message: Key column '%s' doesn't exist in table
- Error: 1073 SQLSTATE: 42000 ([ER\\_BLOB\\_USED\\_AS\\_KEY](#))  
Message: BLOB column '%s' can't be used in key specification with the used table type
- Error: 1074 SQLSTATE: 42000 ([ER\\_TOO\\_BIG\\_FIELDLENGTH](#))  
Message: Column length too big for column '%s' (max = %lu); use BLOB or TEXT instead
- Error: 1075 SQLSTATE: 42000 ([ER\\_WRONG\\_AUTO\\_KEY](#))  
Message: Incorrect table definition; there can be only one auto column and it must be defined as a key
- Error: 1076 SQLSTATE: HY000 ([ER\\_READY](#))  
Message: %s: ready for connections. Version: '%s' socket: '%s' port: %d
- Error: 1077 SQLSTATE: HY000 ([ER\\_NORMAL\\_SHUTDOWN](#))  
Message: %s: Normal shutdown
- Error: 1078 SQLSTATE: HY000 ([ER\\_GOT\\_SIGNAL](#))  
Message: %s: Got signal %d. Aborting!
- Error: 1079 SQLSTATE: HY000 ([ER\\_SHUTDOWN\\_COMPLETE](#))  
Message: %s: Shutdown complete
- Error: 1080 SQLSTATE: 08S01 ([ER\\_FORCING\\_CLOSE](#))  
Message: %s: Forcing close of thread %ld user: '%s'
- Error: 1081 SQLSTATE: 08S01 ([ER\\_IPSOCK\\_ERROR](#))  
Message: Can't create IP socket
- Error: 1082 SQLSTATE: 42S12 ([ER\\_NO\\_SUCH\\_INDEX](#))  
Message: Table '%s' has no index like the one used in CREATE INDEX; recreate the table
- Error: 1083 SQLSTATE: 42000 ([ER\\_WRONG\\_FIELD\\_TERMINATORS](#))  
Message: Field separator argument is not what is expected; check the manual

- Error: 1084 SQLSTATE: 42000 ([ER\\_BLOBS\\_AND\\_NO\\_TERMINATED](#))  
 Message: You can't use fixed rowlength with BLOBs; please use 'fields terminated by'
- Error: 1085 SQLSTATE: HY000 ([ER\\_TEXTFILE\\_NOT\\_READABLE](#))  
 Message: The file '%s' must be in the database directory or be readable by all
- Error: 1086 SQLSTATE: HY000 ([ER\\_FILE\\_EXISTS\\_ERROR](#))  
 Message: File '%s' already exists
- Error: 1087 SQLSTATE: HY000 ([ER\\_LOAD\\_INFO](#))  
 Message: Records: %ld Deleted: %ld Skipped: %ld Warnings: %ld
- Error: 1088 SQLSTATE: HY000 ([ER\\_ALTER\\_INFO](#))  
 Message: Records: %ld Duplicates: %ld
- Error: 1089 SQLSTATE: HY000 ([ER\\_WRONG\\_SUB\\_KEY](#))  
 Message: Incorrect prefix key; the used key part isn't a string, the used length is longer than the key part, or the storage engine doesn't support unique prefix keys
- Error: 1090 SQLSTATE: 42000 ([ER\\_CANT\\_REMOVE\\_ALL\\_FIELDS](#))  
 Message: You can't delete all columns with ALTER TABLE; use DROP TABLE instead
- Error: 1091 SQLSTATE: 42000 ([ER\\_CANT\\_DROP\\_FIELD\\_OR\\_KEY](#))  
 Message: Can't DROP '%s'; check that column/key exists
- Error: 1092 SQLSTATE: HY000 ([ER\\_INSERT\\_INFO](#))  
 Message: Records: %ld Duplicates: %ld Warnings: %ld
- Error: 1093 SQLSTATE: HY000 ([ER\\_UPDATE\\_TABLE\\_USED](#))  
 Message: You can't specify target table '%s' for update in FROM clause
- Error: 1094 SQLSTATE: HY000 ([ER\\_NO\\_SUCH\\_THREAD](#))  
 Message: Unknown thread id: %lu
- Error: 1095 SQLSTATE: HY000 ([ER\\_KILL\\_DENIED\\_ERROR](#))  
 Message: You are not owner of thread %lu
- Error: 1096 SQLSTATE: HY000 ([ER\\_NO\\_TABLES\\_USED](#))  
 Message: No tables used
- Error: 1097 SQLSTATE: HY000 ([ER\\_TOO\\_BIG\\_SET](#))  
 Message: Too many strings for column %s and SET
- Error: 1098 SQLSTATE: HY000 ([ER\\_NO\\_UNIQUE\\_LOGFILE](#))  
 Message: Can't generate a unique log-filename %s.(1-999)
- Error: 1099 SQLSTATE: HY000 ([ER\\_TABLE\\_NOT\\_LOCKED\\_FOR\\_WRITE](#))  
 Message: Table '%s' was locked with a READ lock and can't be updated
- Error: 1100 SQLSTATE: HY000 ([ER\\_TABLE\\_NOT\\_LOCKED](#))  
 Message: Table '%s' was not locked with LOCK TABLES
- Error: 1101 SQLSTATE: 42000 ([ER\\_BLOB\\_CANT\\_HAVE\\_DEFAULT](#))  
 Message: BLOB/TEXT column '%s' can't have a default value



- Error: [1102 SQLSTATE: 42000 \(ER\\_WRONG\\_DB\\_NAME\)](#)  
 Message: Incorrect database name '%s'
- Error: [1103 SQLSTATE: 42000 \(ER\\_WRONG\\_TABLE\\_NAME\)](#)  
 Message: Incorrect table name '%s'
- Error: [1104 SQLSTATE: 42000 \(ER\\_TOO\\_BIG\\_SELECT\)](#)  
 Message: The SELECT would examine more than MAX\_JOIN\_SIZE rows; check your WHERE and use SET SQL\_BIG\_SELECTS=1 or SET SQL\_MAX\_JOIN\_SIZE=# if the SELECT is okay
- Error: [1105 SQLSTATE: HY000 \(ER\\_UNKNOWN\\_ERROR\)](#)  
 Message: Unknown error
- Error: [1106 SQLSTATE: 42000 \(ER\\_UNKNOWN\\_PROCEDURE\)](#)  
 Message: Unknown procedure '%s'
- Error: [1107 SQLSTATE: 42000 \(ER\\_WRONG\\_PARAMCOUNT\\_TO\\_PROCEDURE\)](#)  
 Message: Incorrect parameter count to procedure '%s'
- Error: [1108 SQLSTATE: HY000 \(ER\\_WRONG\\_PARAMETERS\\_TO\\_PROCEDURE\)](#)  
 Message: Incorrect parameters to procedure '%s'
- Error: [1109 SQLSTATE: 42S02 \(ER\\_UNKNOWN\\_TABLE\)](#)  
 Message: Unknown table '%s' in %s
- Error: [1110 SQLSTATE: 42000 \(ER\\_FIELD\\_SPECIFIED\\_TWICE\)](#)  
 Message: Column '%s' specified twice
- Error: [1111 SQLSTATE: HY000 \(ER\\_INVALID\\_GROUP\\_FUNC\\_USE\)](#)  
 Message: Invalid use of group function
- Error: [1112 SQLSTATE: 42000 \(ER\\_UNSUPPORTED\\_EXTENSION\)](#)  
 Message: Table '%s' uses an extension that doesn't exist in this MySQL version
- Error: [1113 SQLSTATE: 42000 \(ER\\_TABLE\\_MUST\\_HAVE\\_COLUMNS\)](#)  
 Message: A table must have at least 1 column
- Error: [1114 SQLSTATE: HY000 \(ER\\_RECORD\\_FILE\\_FULL\)](#)  
 Message: The table '%s' is full
- Error: [1115 SQLSTATE: 42000 \(ER\\_UNKNOWN\\_CHARACTER\\_SET\)](#)  
 Message: Unknown character set: '%s'
- Error: [1116 SQLSTATE: HY000 \(ER\\_TOO\\_MANY\\_TABLES\)](#)  
 Message: Too many tables; MySQL can only use %d tables in a join
- Error: [1117 SQLSTATE: HY000 \(ER\\_TOO\\_MANY\\_FIELDS\)](#)  
 Message: Too many columns
- Error: [1118 SQLSTATE: 42000 \(ER\\_TOO\\_BIG\\_ROWSIZE\)](#)  
 Message: Row size too large. The maximum row size for the used table type, not counting BLOBs, is %ld. You have to change some columns to TEXT or BLOBs
- Error: [1119 SQLSTATE: HY000 \(ER\\_STACK\\_OVERRUN\)](#)

Message: Thread stack overrun: Used: %ld of a %ld stack. Use 'mysqld -O thread\_stack=#' to specify a bigger stack if needed

- Error: 1120 SQLSTATE: 42000 ([ER\\_WRONG\\_OUTER\\_JOIN](#))

Message: Cross dependency found in OUTER JOIN; examine your ON conditions

- Error: 1121 SQLSTATE: 42000 ([ER\\_NULL\\_COLUMN\\_IN\\_INDEX](#))

Message: Table handler doesn't support NULL in given index. Please change column '%s' to be NOT NULL or use another handler

- Error: 1122 SQLSTATE: HY000 ([ER\\_CANT\\_FIND\\_UDF](#))

Message: Can't load function '%s'

- Error: 1123 SQLSTATE: HY000 ([ER\\_CANT\\_INITIALIZE\\_UDF](#))

Message: Can't initialize function '%s'; %s

- Error: 1124 SQLSTATE: HY000 ([ER\\_UDF\\_NO\\_PATHS](#))

Message: No paths allowed for shared library

- Error: 1125 SQLSTATE: HY000 ([ER\\_UDF\\_EXISTS](#))

Message: Function '%s' already exists

- Error: 1126 SQLSTATE: HY000 ([ER\\_CANT\\_OPEN\\_LIBRARY](#))

Message: Can't open shared library '%s' (errno: %d %s)

- Error: 1127 SQLSTATE: HY000 ([ER\\_CANT\\_FIND\\_DL\\_ENTRY](#))

Message: Can't find symbol '%s' in library

- Error: 1128 SQLSTATE: HY000 ([ER\\_FUNCTION\\_NOT\\_DEFINED](#))

Message: Function '%s' is not defined

- Error: 1129 SQLSTATE: HY000 ([ER\\_HOST\\_IS\\_BLOCKED](#))

Message: Host '%s' is blocked because of many connection errors; unblock with 'mysqladmin flush-hosts'

- Error: 1130 SQLSTATE: HY000 ([ER\\_HOST\\_NOT\\_PRIVILEGED](#))

Message: Host '%s' is not allowed to connect to this MySQL server

- Error: 1131 SQLSTATE: 42000 ([ER\\_PASSWORD\\_ANONYMOUS\\_USER](#))

Message: You are using MySQL as an anonymous user and anonymous users are not allowed to change passwords

- Error: 1132 SQLSTATE: 42000 ([ER\\_PASSWORD\\_NOT\\_ALLOWED](#))

Message: You must have privileges to update tables in the mysql database to be able to change passwords for others

- Error: 1133 SQLSTATE: 42000 ([ER\\_PASSWORD\\_NO\\_MATCH](#))

Message: Can't find any matching row in the user table

- Error: 1134 SQLSTATE: HY000 ([ER\\_UPDATE\\_INFO](#))

Message: Rows matched: %ld Changed: %ld Warnings: %ld

- Error: 1135 SQLSTATE: HY000 ([ER\\_CANT\\_CREATE\\_THREAD](#))

Message: Can't create a new thread (errno %d); if you are not out of available memory, you can consult the manual for a possible OS-dependent bug

- Error: 1136 SQLSTATE: 21S01 ([ER\\_WRONG\\_VALUE\\_COUNT\\_ON\\_ROW](#))

Message: Column count doesn't match value count at row %ld

- Error: 1137 SQLSTATE: HY000 ([ER\\_CANT\\_REOPEN\\_TABLE](#))  
Message: Can't reopen table: '%s'
- Error: 1138 SQLSTATE: 22004 ([ER\\_INVALID\\_USE\\_OF\\_NULL](#))  
Message: Invalid use of NULL value
- Error: 1139 SQLSTATE: 42000 ([ER\\_REGEX\\_ERROR](#))  
Message: Got error '%s' from regexp
- Error: 1140 SQLSTATE: 42000 ([ER\\_MIX\\_OF\\_GROUP\\_FUNC\\_AND\\_FIELDS](#))  
Message: Mixing of GROUP columns (MIN(),MAX(),COUNT(),...) with no GROUP columns is illegal if there is no GROUP BY clause
- Error: 1141 SQLSTATE: 42000 ([ER\\_NONEXISTING\\_GRANT](#))  
Message: There is no such grant defined for user '%s' on host '%s'
- Error: 1142 SQLSTATE: 42000 ([ER\\_TABLEACCESS\\_DENIED\\_ERROR](#))  
Message: %s command denied to user '%s'@'%s' for table '%s'
- Error: 1143 SQLSTATE: 42000 ([ER\\_COLUMNACCESS\\_DENIED\\_ERROR](#))  
Message: %s command denied to user '%s'@'%s' for column '%s' in table '%s'
- Error: 1144 SQLSTATE: 42000 ([ER\\_ILLEGAL\\_GRANT\\_FOR\\_TABLE](#))  
Message: Illegal GRANT/REVOKE command; please consult the manual to see which privileges can be used
- Error: 1145 SQLSTATE: 42000 ([ER\\_GRANT\\_WRONG\\_HOST\\_OR\\_USER](#))  
Message: The host or user argument to GRANT is too long
- Error: 1146 SQLSTATE: 42S02 ([ER\\_NO\\_SUCH\\_TABLE](#))  
Message: Table '%s.%s' doesn't exist
- Error: 1147 SQLSTATE: 42000 ([ER\\_NONEXISTING\\_TABLE\\_GRANT](#))  
Message: There is no such grant defined for user '%s' on host '%s' on table '%s'
- Error: 1148 SQLSTATE: 42000 ([ER\\_NOT\\_ALLOWED\\_COMMAND](#))  
Message: The used command is not allowed with this MySQL version
- Error: 1149 SQLSTATE: 42000 ([ER\\_SYNTAX\\_ERROR](#))  
Message: You have an error in your SQL syntax; check the manual that corresponds to your MySQL server version for the right syntax to use
- Error: 1150 SQLSTATE: HY000 ([ER\\_DELAYED\\_CANT\\_CHANGE\\_LOCK](#))  
Message: Delayed insert thread couldn't get requested lock for table %s
- Error: 1151 SQLSTATE: HY000 ([ER\\_TOO\\_MANY\\_DELAYED\\_THREADS](#))  
Message: Too many delayed threads in use
- Error: 1152 SQLSTATE: 08S01 ([ER\\_ABORTING\\_CONNECTION](#))  
Message: Aborted connection %ld to db: '%s' user: '%s' (%s)
- Error: 1153 SQLSTATE: 08S01 ([ER\\_NET\\_PACKET\\_TOO\\_LARGE](#))  
Message: Got a packet bigger than 'max\_allowed\_packet' bytes
- Error: 1154 SQLSTATE: 08S01 ([ER\\_NET\\_READ\\_ERROR\\_FROM\\_PIPE](#))

- Message: Got a read error from the connection pipe

  - Error: 1155 SQLSTATE: 08S01 ([ER\\_NET\\_FCNTL\\_ERROR](#))

Message: Got an error from fcntl()

  - Error: 1156 SQLSTATE: 08S01 ([ER\\_NET\\_PACKETS\\_OUT\\_OF\\_ORDER](#))

Message: Got packets out of order

  - Error: 1157 SQLSTATE: 08S01 ([ER\\_NET\\_UNCOMPRESS\\_ERROR](#))

Message: Couldn't uncompress communication packet

  - Error: 1158 SQLSTATE: 08S01 ([ER\\_NET\\_READ\\_ERROR](#))

Message: Got an error reading communication packets

  - Error: 1159 SQLSTATE: 08S01 ([ER\\_NET\\_READ\\_INTERRUPTED](#))

Message: Got timeout reading communication packets

  - Error: 1160 SQLSTATE: 08S01 ([ER\\_NET\\_ERROR\\_ON\\_WRITE](#))

Message: Got an error writing communication packets

  - Error: 1161 SQLSTATE: 08S01 ([ER\\_NET\\_WRITE\\_INTERRUPTED](#))

Message: Got timeout writing communication packets

  - Error: 1162 SQLSTATE: 42000 ([ER\\_TOO\\_LONG\\_STRING](#))

Message: Result string is longer than 'max\_allowed\_packet' bytes

  - Error: 1163 SQLSTATE: 42000 ([ER\\_TABLE\\_CANT\\_HANDLE\\_BLOB](#))

Message: The used table type doesn't support BLOB/TEXT columns

  - Error: 1164 SQLSTATE: 42000 ([ER\\_TABLE\\_CANT\\_HANDLE\\_AUTO\\_INCREMENT](#))

Message: The used table type doesn't support AUTO\_INCREMENT columns

  - Error: 1165 SQLSTATE: HY000 ([ER\\_DELAYED\\_INSERT\\_TABLE\\_LOCKED](#))

Message: INSERT DELAYED can't be used with table '%s' because it is locked with LOCK TABLES

  - Error: 1166 SQLSTATE: 42000 ([ER\\_WRONG\\_COLUMN\\_NAME](#))

Message: Incorrect column name '%s'

  - Error: 1167 SQLSTATE: 42000 ([ER\\_WRONG\\_KEY\\_COLUMN](#))

Message: The used storage engine can't index column '%s'

  - Error: 1168 SQLSTATE: HY000 ([ER\\_WRONG\\_MRG\\_TABLE](#))

Message: Unable to open underlying table which is differently defined or of non-MyISAM type or doesn't exist

  - Error: 1169 SQLSTATE: 23000 ([ER\\_DUP\\_UNIQUE](#))

Message: Can't write, because of unique constraint, to table '%s'

  - Error: 1170 SQLSTATE: 42000 ([ER\\_BLOB\\_KEY\\_WITHOUT\\_LENGTH](#))

Message: BLOB/TEXT column '%s' used in key specification without a key length

  - Error: 1171 SQLSTATE: 42000 ([ER\\_PRIMARY\\_CANT\\_HAVE\\_NULL](#))

Message: All parts of a PRIMARY KEY must be NOT NULL; if you need NULL in a key, use UNIQUE instead

  - Error: 1172 SQLSTATE: 42000 ([ER\\_TOO\\_MANY\\_ROWS](#))

Message: Result consisted of more than one row

- Error: 1173 SQLSTATE: 42000 ([ER\\_REQUIRES\\_PRIMARY\\_KEY](#))

Message: This table type requires a primary key

- Error: 1174 SQLSTATE: HY000 ([ER\\_NO\\_RAID\\_COMPILED](#))

Message: This version of MySQL is not compiled with RAID support

- Error: 1175 SQLSTATE: HY000 ([ER\\_UPDATE\\_WITHOUT\\_KEY\\_IN\\_SAFE\\_MODE](#))

Message: You are using safe update mode and you tried to update a table without a WHERE that uses a KEY column

- Error: 1176 SQLSTATE: 42000 ([ER\\_KEY\\_DOES\\_NOT\\_EXISTS](#))

Message: Key '%s' doesn't exist in table '%s'

- Error: 1177 SQLSTATE: 42000 ([ER\\_CHECK\\_NO\\_SUCH\\_TABLE](#))

Message: Can't open table

- Error: 1178 SQLSTATE: 42000 ([ER\\_CHECK\\_NOT\\_IMPLEMENTED](#))

Message: The storage engine for the table doesn't support %s

- Error: 1179 SQLSTATE: 25000 ([ER\\_CANT\\_DO\\_THIS\\_DURING\\_AN\\_TRANSACTION](#))

Message: You are not allowed to execute this command in a transaction

- Error: 1180 SQLSTATE: HY000 ([ER\\_ERROR\\_DURING\\_COMMIT](#))

Message: Got error %d during COMMIT

- Error: 1181 SQLSTATE: HY000 ([ER\\_ERROR\\_DURING\\_ROLLBACK](#))

Message: Got error %d during ROLLBACK

- Error: 1182 SQLSTATE: HY000 ([ER\\_ERROR\\_DURING\\_FLUSH\\_LOGS](#))

Message: Got error %d during FLUSH\_LOGS

- Error: 1183 SQLSTATE: HY000 ([ER\\_ERROR\\_DURING\\_CHECKPOINT](#))

Message: Got error %d during CHECKPOINT

- Error: 1184 SQLSTATE: 08S01 ([ER\\_NEW\\_ABORTING\\_CONNECTION](#))

Message: Aborted connection %ld to db: '%s' user: '%s' host: '%s' (%s)

- Error: 1185 SQLSTATE: HY000 ([ER\\_DUMP\\_NOT\\_IMPLEMENTED](#))

Message: The storage engine for the table does not support binary table dump

- Error: 1186 SQLSTATE: HY000 ([ER\\_FLUSH\\_MASTER\\_BINLOG\\_CLOSED](#))

Message: Binlog closed, cannot RESET MASTER

- Error: 1187 SQLSTATE: HY000 ([ER\\_INDEX\\_REBUILD](#))

Message: Failed rebuilding the index of dumped table '%s'

- Error: 1188 SQLSTATE: HY000 ([ER\\_MASTER](#))

Message: Error from master: '%s'

- Error: 1189 SQLSTATE: 08S01 ([ER\\_MASTER\\_NET\\_READ](#))

Message: Net error reading from master

- Error: 1190 SQLSTATE: 08S01 ([ER\\_MASTER\\_NET\\_WRITE](#))

- Message: Net error writing to master
- Error: 1191 SQLSTATE: HY000 ([ER\\_FT\\_MATCHING\\_KEY\\_NOT\\_FOUND](#))  
Message: Can't find FULLTEXT index matching the column list
- Error: 1192 SQLSTATE: HY000 ([ER\\_LOCK\\_OR\\_ACTIVE\\_TRANSACTION](#))  
Message: Can't execute the given command because you have active locked tables or an active transaction
- Error: 1193 SQLSTATE: HY000 ([ER\\_UNKNOWN\\_SYSTEM\\_VARIABLE](#))  
Message: Unknown system variable '%s'
- Error: 1194 SQLSTATE: HY000 ([ER\\_CRASHED\\_ON\\_USAGE](#))  
Message: Table '%s' is marked as crashed and should be repaired
- Error: 1195 SQLSTATE: HY000 ([ER\\_CRASHED\\_ON\\_REPAIR](#))  
Message: Table '%s' is marked as crashed and last (automatic?) repair failed
- Error: 1196 SQLSTATE: HY000 ([ER\\_WARNING\\_NOT\\_COMPLETE\\_ROLLBACK](#))  
Message: Some non-transactional changed tables couldn't be rolled back
- Error: 1197 SQLSTATE: HY000 ([ER\\_TRANS\\_CACHE\\_FULL](#))  
Message: Multi-statement transaction required more than 'max\_binlog\_cache\_size' bytes of storage; increase this mysqld variable and try again
- Error: 1198 SQLSTATE: HY000 ([ER\\_SLAVE\\_MUST\\_STOP](#))  
Message: This operation cannot be performed with a running slave; run STOP SLAVE first
- Error: 1199 SQLSTATE: HY000 ([ER\\_SLAVE\\_NOT\\_RUNNING](#))  
Message: This operation requires a running slave; configure slave and do START SLAVE
- Error: 1200 SQLSTATE: HY000 ([ER\\_BAD\\_SLAVE](#))  
Message: The server is not configured as slave; fix in config file or with CHANGE MASTER TO
- Error: 1201 SQLSTATE: HY000 ([ER\\_MASTER\\_INFO](#))  
Message: Could not initialize master info structure; more error messages can be found in the MySQL error log
- Error: 1202 SQLSTATE: HY000 ([ER\\_SLAVE\\_THREAD](#))  
Message: Could not create slave thread; check system resources
- Error: 1203 SQLSTATE: 42000 ([ER\\_TOO\\_MANY\\_USER\\_CONNECTIONS](#))  
Message: User %s already has more than 'max\_user\_connections' active connections
- Error: 1204 SQLSTATE: HY000 ([ER\\_SET\\_CONSTANTS\\_ONLY](#))  
Message: You may only use constant expressions with SET
- Error: 1205 SQLSTATE: HY000 ([ER\\_LOCK\\_WAIT\\_TIMEOUT](#))  
Message: Lock wait timeout exceeded; try restarting transaction
- Error: 1206 SQLSTATE: HY000 ([ER\\_LOCK\\_TABLE\\_FULL](#))  
Message: The total number of locks exceeds the lock table size
- Error: 1207 SQLSTATE: 25000 ([ER\\_READ\\_ONLY\\_TRANSACTION](#))  
Message: Update locks cannot be acquired during a READ UNCOMMITTED transaction

- Error: 1208 SQLSTATE: HY000 ([ER\\_DROP\\_DB\\_WITH\\_READ\\_LOCK](#))  
Message: DROP DATABASE not allowed while thread is holding global read lock
- Error: 1209 SQLSTATE: HY000 ([ER\\_CREATE\\_DB\\_WITH\\_READ\\_LOCK](#))  
Message: CREATE DATABASE not allowed while thread is holding global read lock
- Error: 1210 SQLSTATE: HY000 ([ER\\_WRONG\\_ARGUMENTS](#))  
Message: Incorrect arguments to %s
- Error: 1211 SQLSTATE: 42000 ([ER\\_NO\\_PERMISSION\\_TO\\_CREATE\\_USER](#))  
Message: '%s'@'%s' is not allowed to create new users
- Error: 1212 SQLSTATE: HY000 ([ER\\_UNION\\_TABLES\\_IN\\_DIFFERENT\\_DIR](#))  
Message: Incorrect table definition; all MERGE tables must be in the same database
- Error: 1213 SQLSTATE: 40001 ([ER\\_LOCK\\_DEADLOCK](#))  
Message: Deadlock found when trying to get lock; try restarting transaction
- Error: 1214 SQLSTATE: HY000 ([ER\\_TABLE\\_CANT\\_HANDLE\\_FT](#))  
Message: The used table type doesn't support FULLTEXT indexes
- Error: 1215 SQLSTATE: HY000 ([ER\\_CANNOT\\_ADD\\_FOREIGN](#))  
Message: Cannot add foreign key constraint
- Error: 1216 SQLSTATE: 23000 ([ER\\_NO\\_REFERENCED\\_ROW](#))  
Message: Cannot add or update a child row: a foreign key constraint fails
- Error: 1217 SQLSTATE: 23000 ([ER\\_ROW\\_IS\\_REFERENCED](#))  
Message: Cannot delete or update a parent row: a foreign key constraint fails
- Error: 1218 SQLSTATE: 08S01 ([ER\\_CONNECT\\_TO\\_MASTER](#))  
Message: Error connecting to master: %s
- Error: 1219 SQLSTATE: HY000 ([ER\\_QUERY\\_ON\\_MASTER](#))  
Message: Error running query on master: %s
- Error: 1220 SQLSTATE: HY000 ([ER\\_ERROR\\_WHEN\\_EXECUTING\\_COMMAND](#))  
Message: Error when executing command %s: %s
- Error: 1221 SQLSTATE: HY000 ([ER\\_WRONG\\_USAGE](#))  
Message: Incorrect usage of %s and %s
- Error: 1222 SQLSTATE: 21000 ([ER\\_WRONG\\_NUMBER\\_OF\\_COLUMNS\\_IN\\_SELECT](#))  
Message: The used SELECT statements have a different number of columns
- Error: 1223 SQLSTATE: HY000 ([ER\\_CANT\\_UPDATE\\_WITH\\_READLOCK](#))  
Message: Can't execute the query because you have a conflicting read lock
- Error: 1224 SQLSTATE: HY000 ([ER\\_MIXING\\_NOT\\_ALLOWED](#))  
Message: Mixing of transactional and non-transactional tables is disabled
- Error: 1225 SQLSTATE: HY000 ([ER\\_DUP\\_ARGUMENT](#))  
Message: Option '%s' used twice in statement

- Error: [1226 SQLSTATE: 42000 \(ER\\_USER\\_LIMIT\\_REACHED\)](#)  
Message: User '%s' has exceeded the '%s' resource (current value: %ld)
- Error: [1227 SQLSTATE: 42000 \(ER\\_SPECIFIC\\_ACCESS\\_DENIED\\_ERROR\)](#)  
Message: Access denied; you need the %s privilege for this operation
- Error: [1228 SQLSTATE: HY000 \(ER\\_LOCAL\\_VARIABLE\)](#)  
Message: Variable '%s' is a SESSION variable and can't be used with SET GLOBAL
- Error: [1229 SQLSTATE: HY000 \(ER\\_GLOBAL\\_VARIABLE\)](#)  
Message: Variable '%s' is a GLOBAL variable and should be set with SET GLOBAL
- Error: [1230 SQLSTATE: 42000 \(ER\\_NO\\_DEFAULT\)](#)  
Message: Variable '%s' doesn't have a default value
- Error: [1231 SQLSTATE: 42000 \(ER\\_WRONG\\_VALUE\\_FOR\\_VAR\)](#)  
Message: Variable '%s' can't be set to the value of '%s'
- Error: [1232 SQLSTATE: 42000 \(ER\\_WRONG\\_TYPE\\_FOR\\_VAR\)](#)  
Message: Incorrect argument type to variable '%s'
- Error: [1233 SQLSTATE: HY000 \(ER\\_VAR\\_CANT\\_BE\\_READ\)](#)  
Message: Variable '%s' can only be set, not read
- Error: [1234 SQLSTATE: 42000 \(ER\\_CANT\\_USE\\_OPTION\\_HERE\)](#)  
Message: Incorrect usage/placement of '%s'
- Error: [1235 SQLSTATE: 42000 \(ER\\_NOT\\_SUPPORTED\\_YET\)](#)  
Message: This version of MySQL doesn't yet support '%s'
- Error: [1236 SQLSTATE: HY000 \(ER\\_MASTER\\_FATAL\\_ERROR\\_READING\\_BINLOG\)](#)  
Message: Got fatal error %d: '%s' from master when reading data from binary log
- Error: [1237 SQLSTATE: HY000 \(ER\\_SLAVE\\_IGNORED\\_TABLE\)](#)  
Message: Slave SQL thread ignored the query because of replicate-\*table rules
- Error: [1238 SQLSTATE: HY000 \(ER\\_INCORRECT\\_GLOBAL\\_LOCAL\\_VAR\)](#)  
Message: Variable '%s' is a %s variable
- Error: [1239 SQLSTATE: 42000 \(ER\\_WRONG\\_FK\\_DEF\)](#)  
Message: Incorrect foreign key definition for '%s': %s
- Error: [1240 SQLSTATE: HY000 \(ER\\_KEY\\_REF\\_DO\\_NOT\\_MATCH\\_TABLE\\_REF\)](#)  
Message: Key reference and table reference don't match
- Error: [1241 SQLSTATE: 21000 \(ER\\_OPERAND\\_COLUMNS\)](#)  
Message: Operand should contain %d column(s)
- Error: [1242 SQLSTATE: 21000 \(ER\\_SUBQUERY\\_NO\\_1\\_ROW\)](#)  
Message: Subquery returns more than 1 row
- Error: [1243 SQLSTATE: HY000 \(ER\\_UNKNOWN\\_STMT\\_HANDLER\)](#)  
Message: Unknown prepared statement handler (%.\*s) given to %s



- Error: [1244](#) SQLSTATE: [HY000](#) ([ER\\_CORRUPT\\_HELP\\_DB](#))  
Message: Help database is corrupt or does not exist
- Error: [1245](#) SQLSTATE: [HY000](#) ([ER\\_CYCLIC\\_REFERENCE](#))  
Message: Cyclic reference on subqueries
- Error: [1246](#) SQLSTATE: [HY000](#) ([ER\\_AUTO\\_CONVERT](#))  
Message: Converting column '%s' from %s to %s
- Error: [1247](#) SQLSTATE: [42S22](#) ([ER\\_ILLEGAL\\_REFERENCE](#))  
Message: Reference '%s' not supported (%s)
- Error: [1248](#) SQLSTATE: [42000](#) ([ER\\_DERIVED\\_MUST\\_HAVE\\_ALIAS](#))  
Message: Every derived table must have its own alias
- Error: [1249](#) SQLSTATE: [01000](#) ([ER\\_SELECT\\_REDUCED](#))  
Message: Select %u was reduced during optimization
- Error: [1250](#) SQLSTATE: [42000](#) ([ER\\_TABLENAME\\_NOT\\_ALLOWED\\_HERE](#))  
Message: Table '%s' from one of the SELECTs cannot be used in %s
- Error: [1251](#) SQLSTATE: [08004](#) ([ER\\_NOT\\_SUPPORTED\\_AUTH\\_MODE](#))  
Message: Client does not support authentication protocol requested by server; consider upgrading MySQL client
- Error: [1252](#) SQLSTATE: [42000](#) ([ER\\_SPATIAL\\_CANT\\_HAVE\\_NULL](#))  
Message: All parts of a SPATIAL index must be NOT NULL
- Error: [1253](#) SQLSTATE: [42000](#) ([ER\\_COLLATION\\_CHARSET\\_MISMATCH](#))  
Message: COLLATION '%s' is not valid for CHARACTER SET '%s'
- Error: [1254](#) SQLSTATE: [HY000](#) ([ER\\_SLAVE\\_WAS\\_RUNNING](#))  
Message: Slave is already running
- Error: [1255](#) SQLSTATE: [HY000](#) ([ER\\_SLAVE\\_WAS\\_NOT\\_RUNNING](#))  
Message: Slave already has been stopped
- Error: [1256](#) SQLSTATE: [HY000](#) ([ER\\_TOO\\_BIG\\_FOR\\_UNCOMPRESS](#))  
Message: Uncompressed data size too large; the maximum size is %d (probably, length of uncompressed data was corrupted)
- Error: [1257](#) SQLSTATE: [HY000](#) ([ER\\_ZLIB\\_Z\\_MEM\\_ERROR](#))  
Message: ZLIB: Not enough memory
- Error: [1258](#) SQLSTATE: [HY000](#) ([ER\\_ZLIB\\_Z\\_BUF\\_ERROR](#))  
Message: ZLIB: Not enough room in the output buffer (probably, length of uncompressed data was corrupted)
- Error: [1259](#) SQLSTATE: [HY000](#) ([ER\\_ZLIB\\_Z\\_DATA\\_ERROR](#))  
Message: ZLIB: Input data corrupted
- Error: [1260](#) SQLSTATE: [HY000](#) ([ER\\_CUT\\_VALUE\\_GROUP\\_CONCAT](#))  
Message: %d line(s) were cut by GROUP\_CONCAT()
- Error: [1261](#) SQLSTATE: [01000](#) ([ER\\_WARN\\_TOO\\_FEW\\_RECORDS](#))  
Message: Row %ld doesn't contain data for all columns

- Error: [1262 SQLSTATE: 01000 \(ER\\_WARN\\_TOO\\_MANY\\_RECORDS\)](#)  
Message: Row %ld was truncated; it contained more data than there were input columns
- Error: [1263 SQLSTATE: 22004 \(ER\\_WARN\\_NULL\\_TO\\_NOTNULL\)](#)  
Message: Column set to default value; NULL supplied to NOT NULL column '%s' at row %ld
- Error: [1264 SQLSTATE: 22003 \(ER\\_WARN\\_DATA\\_OUT\\_OF\\_RANGE\)](#)  
Message: Out of range value for column '%s' at row %ld
- Error: [1265 SQLSTATE: 01000 \(WARN\\_DATA\\_TRUNCATED\)](#)  
Message: Data truncated for column '%s' at row %ld
- Error: [1266 SQLSTATE: HY000 \(ER\\_WARN\\_USING\\_OTHER\\_HANDLER\)](#)  
Message: Using storage engine %s for table '%s'
- Error: [1267 SQLSTATE: HY000 \(ER\\_CANT\\_AGGREGATE\\_2COLLATIONS\)](#)  
Message: Illegal mix of collations (%s,%s) and (%s,%s) for operation '%s'
- Error: [1268 SQLSTATE: HY000 \(ER\\_DROP\\_USER\)](#)  
Message: Cannot drop one or more of the requested users
- Error: [1269 SQLSTATE: HY000 \(ER\\_REVOKE\\_GRANTS\)](#)  
Message: Can't revoke all privileges for one or more of the requested users
- Error: [1270 SQLSTATE: HY000 \(ER\\_CANT\\_AGGREGATE\\_3COLLATIONS\)](#)  
Message: Illegal mix of collations (%s,%s), (%s,%s), (%s,%s) for operation '%s'
- Error: [1271 SQLSTATE: HY000 \(ER\\_CANT\\_AGGREGATE\\_NCOLLATIONS\)](#)  
Message: Illegal mix of collations for operation '%s'
- Error: [1272 SQLSTATE: HY000 \(ER\\_VARIABLE\\_IS\\_NOT\\_STRUCT\)](#)  
Message: Variable '%s' is not a variable component (can't be used as XXXX.variable\_name)
- Error: [1273 SQLSTATE: HY000 \(ER\\_UNKNOWN\\_COLLATION\)](#)  
Message: Unknown collation: '%s'
- Error: [1274 SQLSTATE: HY000 \(ER\\_SLAVE\\_IGNORED\\_SSL\\_PARAMS\)](#)  
Message: SSL parameters in CHANGE MASTER are ignored because this MySQL slave was compiled without SSL support; they can be used later if MySQL slave with SSL is started
- Error: [1275 SQLSTATE: HY000 \(ER\\_SERVER\\_IS\\_IN\\_SECURE\\_AUTH\\_MODE\)](#)  
Message: Server is running in --secure-auth mode, but '%s'@'%s' has a password in the old format; please change the password to the new format
- Error: [1276 SQLSTATE: HY000 \(ER\\_WARN\\_FIELD\\_RESOLVED\)](#)  
Message: Field or reference '%s%s%s%s%s' of SELECT #%d was resolved in SELECT #%d
- Error: [1277 SQLSTATE: HY000 \(ER\\_BAD\\_SLAVE\\_UNTIL\\_COND\)](#)  
Message: Incorrect parameter or combination of parameters for START SLAVE UNTIL
- Error: [1278 SQLSTATE: HY000 \(ER\\_MISSING\\_SKIP\\_SLAVE\)](#)  
Message: It is recommended to use --skip-slave-start when doing step-by-step replication with START SLAVE UNTIL; otherwise, you will get problems if you get an unexpected slave's mysqld restart
- Error: [1279 SQLSTATE: HY000 \(ER\\_UNTIL\\_COND\\_IGNORED\)](#)

- Message: SQL thread is not to be started so UNTIL options are ignored
- Error: 1280 SQLSTATE: 42000 ([ER\\_WRONG\\_NAME\\_FOR\\_INDEX](#))

Message: Incorrect index name '%s'
- Error: 1281 SQLSTATE: 42000 ([ER\\_WRONG\\_NAME\\_FOR\\_CATALOG](#))

Message: Incorrect catalog name '%s'
- Error: 1282 SQLSTATE: HY000 ([ER\\_WARN\\_QC\\_RESIZE](#))

Message: Query cache failed to set size %lu; new query cache size is %lu
- Error: 1283 SQLSTATE: HY000 ([ER\\_BAD\\_FT\\_COLUMN](#))

Message: Column '%s' cannot be part of FULLTEXT index
- Error: 1284 SQLSTATE: HY000 ([ER\\_UNKNOWN\\_KEY\\_CACHE](#))

Message: Unknown key cache '%s'
- Error: 1285 SQLSTATE: HY000 ([ER\\_WARN\\_HOSTNAME\\_WONT\\_WORK](#))

Message: MySQL is started in --skip-name-resolve mode; you must restart it without this switch for this grant to work
- Error: 1286 SQLSTATE: 42000 ([ER\\_UNKNOWN\\_STORAGE\\_ENGINE](#))

Message: Unknown table engine '%s'
- Error: 1287 SQLSTATE: HY000 ([ER\\_WARN\\_DEPRECATED\\_SYNTAX](#))

Message: '%s' is deprecated; use '%s' instead
- Error: 1288 SQLSTATE: HY000 ([ER\\_NON\\_UPDATABLE\\_TABLE](#))

Message: The target table %s of the %s is not updatable
- Error: 1289 SQLSTATE: HY000 ([ER\\_FEATURE\\_DISABLED](#))

Message: The '%s' feature is disabled; you need MySQL built with '%s' to have it working
- Error: 1290 SQLSTATE: HY000 ([ER\\_OPTION\\_PREVENTS\\_STATEMENT](#))

Message: The MySQL server is running with the %s option so it cannot execute this statement
- Error: 1291 SQLSTATE: HY000 ([ER\\_DUPLICATED\\_VALUE\\_IN\\_TYPE](#))

Message: Column '%s' has duplicated value '%s' in %s
- Error: 1292 SQLSTATE: 22007 ([ER\\_TRUNCATED\\_WRONG\\_VALUE](#))

Message: Truncated incorrect %s value: '%s'
- Error: 1293 SQLSTATE: HY000 ([ER\\_TOO\\_MUCH\\_AUTO\\_TIMESTAMP\\_COLS](#))

Message: Incorrect table definition; there can be only one TIMESTAMP column with CURRENT\_TIMESTAMP in DEFAULT or ON UPDATE clause
- Error: 1294 SQLSTATE: HY000 ([ER\\_INVALID\\_ON\\_UPDATE](#))

Message: Invalid ON UPDATE clause for '%s' column
- Error: 1295 SQLSTATE: HY000 ([ER\\_UNSUPPORTED\\_PS](#))

Message: This command is not supported in the prepared statement protocol yet
- Error: 1296 SQLSTATE: HY000 ([ER\\_GET\\_ERRMSG](#))

Message: Got error %d '%s' from %s

- Error: [1297](#) SQLSTATE: [HY000](#) ([ER\\_GET\\_TEMPORARY\\_ERRMSG](#))  
 Message: Got temporary error %d '%s' from %s
- Error: [1298](#) SQLSTATE: [HY000](#) ([ER\\_UNKNOWN\\_TIME\\_ZONE](#))  
 Message: Unknown or incorrect time zone: '%s'
- Error: [1299](#) SQLSTATE: [HY000](#) ([ER\\_WARN\\_INVALID\\_TIMESTAMP](#))  
 Message: Invalid TIMESTAMP value in column '%s' at row %ld
- Error: [1300](#) SQLSTATE: [HY000](#) ([ER\\_INVALID\\_CHARACTER\\_STRING](#))  
 Message: Invalid %s character string: '%s'
- Error: [1301](#) SQLSTATE: [HY000](#) ([ER\\_WARN\\_ALLOWED\\_PACKET\\_OVERFLOWED](#))  
 Message: Result of %s() was larger than max\_allowed\_packet (%ld) - truncated
- Error: [1302](#) SQLSTATE: [HY000](#) ([ER\\_CONFLICTING\\_DECLARATIONS](#))  
 Message: Conflicting declarations: '%s%s' and '%s%s'
- Error: [1303](#) SQLSTATE: [2F003](#) ([ER\\_SP\\_NO\\_RECURSIVE\\_CREATE](#))  
 Message: Can't create a %s from within another stored routine
- Error: [1304](#) SQLSTATE: [42000](#) ([ER\\_SP\\_ALREADY\\_EXISTS](#))  
 Message: %s %s already exists
- Error: [1305](#) SQLSTATE: [42000](#) ([ER\\_SP\\_DOES\\_NOT\\_EXIST](#))  
 Message: %s %s does not exist
- Error: [1306](#) SQLSTATE: [HY000](#) ([ER\\_SP\\_DROP\\_FAILED](#))  
 Message: Failed to DROP %s %s
- Error: [1307](#) SQLSTATE: [HY000](#) ([ER\\_SP\\_STORE\\_FAILED](#))  
 Message: Failed to CREATE %s %s
- Error: [1308](#) SQLSTATE: [42000](#) ([ER\\_SP\\_LILABEL\\_MISMATCH](#))  
 Message: %s with no matching label: %s
- Error: [1309](#) SQLSTATE: [42000](#) ([ER\\_SP\\_LABEL\\_REDEFINE](#))  
 Message: Redefining label %s
- Error: [1310](#) SQLSTATE: [42000](#) ([ER\\_SP\\_LABEL\\_MISMATCH](#))  
 Message: End-label %s without match
- Error: [1311](#) SQLSTATE: [01000](#) ([ER\\_SP\\_UNINIT\\_VAR](#))  
 Message: Referring to uninitialized variable %s
- Error: [1312](#) SQLSTATE: [0A000](#) ([ER\\_SP\\_BADSELECT](#))  
 Message: PROCEDURE %s can't return a result set in the given context
- Error: [1313](#) SQLSTATE: [42000](#) ([ER\\_SP\\_BADRETURN](#))  
 Message: RETURN is only allowed in a FUNCTION
- Error: [1314](#) SQLSTATE: [0A000](#) ([ER\\_SP\\_BADSTATEMENT](#))  
 Message: %s is not allowed in stored procedures

- Error: 1315 SQLSTATE: 42000 ([ER\\_UPDATE\\_LOG\\_DEPRECATED\\_IGNORED](#))  
 Message: The update log is deprecated and replaced by the binary log; SET SQL\_LOG\_UPDATE has been ignored
- Error: 1316 SQLSTATE: 42000 ([ER\\_UPDATE\\_LOG\\_DEPRECATED\\_TRANSLATED](#))  
 Message: The update log is deprecated and replaced by the binary log; SET SQL\_LOG\_UPDATE has been translated to SET SQL\_LOG\_BIN
- Error: 1317 SQLSTATE: 70100 ([ER\\_QUERY\\_INTERRUPTED](#))  
 Message: Query execution was interrupted
- Error: 1318 SQLSTATE: 42000 ([ER\\_SP\\_WRONG\\_NO\\_OF\\_ARGS](#))  
 Message: Incorrect number of arguments for %s %s; expected %u, got %u
- Error: 1319 SQLSTATE: 42000 ([ER\\_SP\\_COND\\_MISMATCH](#))  
 Message: Undefined CONDITION: %s
- Error: 1320 SQLSTATE: 42000 ([ER\\_SP\\_NORETURN](#))  
 Message: No RETURN found in FUNCTION %s
- Error: 1321 SQLSTATE: 2F005 ([ER\\_SP\\_NORETURNEND](#))  
 Message: FUNCTION %s ended without RETURN
- Error: 1322 SQLSTATE: 42000 ([ER\\_SP\\_BAD\\_CURSOR\\_QUERY](#))  
 Message: Cursor statement must be a SELECT
- Error: 1323 SQLSTATE: 42000 ([ER\\_SP\\_BAD\\_CURSOR\\_SELECT](#))  
 Message: Cursor SELECT must not have INTO
- Error: 1324 SQLSTATE: 42000 ([ER\\_SP\\_CURSOR\\_MISMATCH](#))  
 Message: Undefined CURSOR: %s
- Error: 1325 SQLSTATE: 24000 ([ER\\_SP\\_CURSOR\\_ALREADY\\_OPEN](#))  
 Message: Cursor is already open
- Error: 1326 SQLSTATE: 24000 ([ER\\_SP\\_CURSOR\\_NOT\\_OPEN](#))  
 Message: Cursor is not open
- Error: 1327 SQLSTATE: 42000 ([ER\\_SP\\_UNDECLARED\\_VAR](#))  
 Message: Undeclared variable: %s
- Error: 1328 SQLSTATE: HY000 ([ER\\_SP\\_WRONG\\_NO\\_OF\\_FETCH\\_ARGS](#))  
 Message: Incorrect number of FETCH variables
- Error: 1329 SQLSTATE: 02000 ([ER\\_SP\\_FETCH\\_NO\\_DATA](#))  
 Message: No data - zero rows fetched, selected, or processed
- Error: 1330 SQLSTATE: 42000 ([ER\\_SP\\_DUP\\_PARAM](#))  
 Message: Duplicate parameter: %s
- Error: 1331 SQLSTATE: 42000 ([ER\\_SP\\_DUP\\_VAR](#))  
 Message: Duplicate variable: %s
- Error: 1332 SQLSTATE: 42000 ([ER\\_SP\\_DUP\\_COND](#))  
 Message: Duplicate condition: %s

- Error: 1333 SQLSTATE: 42000 ([ER\\_SP\\_DUP\\_CURS](#))  
 Message: Duplicate cursor: %s
- Error: 1334 SQLSTATE: HY000 ([ER\\_SP\\_CANT\\_ALTER](#))  
 Message: Failed to ALTER %s %s
- Error: 1335 SQLSTATE: 0A000 ([ER\\_SP\\_SUBSELECT\\_NYI](#))  
 Message: Subquery value not supported
- Error: 1336 SQLSTATE: 0A000 ([ER\\_STMT\\_NOT\\_ALLOWED\\_IN\\_SF\\_OR\\_TRG](#))  
 Message: %s is not allowed in stored function or trigger
- Error: 1337 SQLSTATE: 42000 ([ER\\_SP\\_VARCOND\\_AFTER\\_CURSHNDLR](#))  
 Message: Variable or condition declaration after cursor or handler declaration
- Error: 1338 SQLSTATE: 42000 ([ER\\_SP\\_CURSOR\\_AFTER\\_HANDLER](#))  
 Message: Cursor declaration after handler declaration
- Error: 1339 SQLSTATE: 20000 ([ER\\_SP\\_CASE\\_NOT\\_FOUND](#))  
 Message: Case not found for CASE statement
- Error: 1340 SQLSTATE: HY000 ([ER\\_FPARSER\\_TOO\\_BIG\\_FILE](#))  
 Message: Configuration file '%s' is too big
- Error: 1341 SQLSTATE: HY000 ([ER\\_FPARSER\\_BAD\\_HEADER](#))  
 Message: Malformed file type header in file '%s'
- Error: 1342 SQLSTATE: HY000 ([ER\\_FPARSER\\_EOF\\_IN\\_COMMENT](#))  
 Message: Unexpected end of file while parsing comment '%s'
- Error: 1343 SQLSTATE: HY000 ([ER\\_FPARSER\\_ERROR\\_IN\\_PARAMETER](#))  
 Message: Error while parsing parameter '%s' (line: '%s')
- Error: 1344 SQLSTATE: HY000 ([ER\\_FPARSER\\_EOF\\_IN\\_UNKNOWN\\_PARAMETER](#))  
 Message: Unexpected end of file while skipping unknown parameter '%s'
- Error: 1345 SQLSTATE: HY000 ([ER\\_VIEW\\_NO\\_EXPLAIN](#))  
 Message: EXPLAIN/SHOW can not be issued; lacking privileges for underlying table
- Error: 1346 SQLSTATE: HY000 ([ER\\_FRM\\_UNKNOWN\\_TYPE](#))  
 Message: File '%s' has unknown type '%s' in its header
- Error: 1347 SQLSTATE: HY000 ([ER\\_WRONG\\_OBJECT](#))  
 Message: '%s.%s' is not %s
- Error: 1348 SQLSTATE: HY000 ([ER\\_NONUPDATEABLE\\_COLUMN](#))  
 Message: Column '%s' is not updatable
- Error: 1349 SQLSTATE: HY000 ([ER\\_VIEW\\_SELECT\\_DERIVED](#))  
 Message: View's SELECT contains a subquery in the FROM clause
- Error: 1350 SQLSTATE: HY000 ([ER\\_VIEW\\_SELECT\\_CLAUSE](#))  
 Message: View's SELECT contains a '%s' clause

- Error: 1351 SQLSTATE: HY000 ([ER\\_VIEW\\_SELECT\\_VARIABLE](#))  
Message: View's SELECT contains a variable or parameter
- Error: 1352 SQLSTATE: HY000 ([ER\\_VIEW\\_SELECT\\_TMPTABLE](#))  
Message: View's SELECT refers to a temporary table '%s'
- Error: 1353 SQLSTATE: HY000 ([ER\\_VIEW\\_WRONG\\_LIST](#))  
Message: View's SELECT and view's field list have different column counts
- Error: 1354 SQLSTATE: HY000 ([ER\\_WARN\\_VIEW\\_MERGE](#))  
Message: View merge algorithm can't be used here for now (assumed undefined algorithm)
- Error: 1355 SQLSTATE: HY000 ([ER\\_WARN\\_VIEW\\_WITHOUT\\_KEY](#))  
Message: View being updated does not have complete key of underlying table in it
- Error: 1356 SQLSTATE: HY000 ([ER\\_VIEW\\_INVALID](#))  
Message: View '%s.%s' references invalid table(s) or column(s) or function(s) or definer/invoker of view lack rights to use them
- Error: 1357 SQLSTATE: HY000 ([ER\\_SP\\_NO\\_DROP\\_SP](#))  
Message: Can't drop or alter a %s from within another stored routine
- Error: 1358 SQLSTATE: HY000 ([ER\\_SP\\_GOTO\\_IN\\_HNDLR](#))  
Message: GOTO is not allowed in a stored procedure handler
- Error: 1359 SQLSTATE: HY000 ([ER\\_TRG\\_ALREADY\\_EXISTS](#))  
Message: Trigger already exists
- Error: 1360 SQLSTATE: HY000 ([ER\\_TRG\\_DOES\\_NOT\\_EXIST](#))  
Message: Trigger does not exist
- Error: 1361 SQLSTATE: HY000 ([ER\\_TRG\\_ON\\_VIEW\\_OR\\_TEMP\\_TABLE](#))  
Message: Trigger's '%s' is view or temporary table
- Error: 1362 SQLSTATE: HY000 ([ER\\_TRG\\_CANT\\_CHANGE\\_ROW](#))  
Message: Updating of %s row is not allowed in %strigger
- Error: 1363 SQLSTATE: HY000 ([ER\\_TRG\\_NO\\_SUCH\\_ROW\\_IN\\_TRG](#))  
Message: There is no %s row in %s trigger
- Error: 1364 SQLSTATE: HY000 ([ER\\_NO\\_DEFAULT\\_FOR\\_FIELD](#))  
Message: Field '%s' doesn't have a default value
- Error: 1365 SQLSTATE: 22012 ([ER\\_DIVISION\\_BY\\_ZERO](#))  
Message: Division by 0
- Error: 1366 SQLSTATE: HY000 ([ER\\_TRUNCATED\\_WRONG\\_VALUE\\_FOR\\_FIELD](#))  
Message: Incorrect %s value: '%s' for column '%s' at row %ld
- Error: 1367 SQLSTATE: 22007 ([ER\\_ILLEGAL\\_VALUE\\_FOR\\_TYPE](#))  
Message: Illegal %s '%s' value found during parsing
- Error: 1368 SQLSTATE: HY000 ([ER\\_VIEW\\_NONUPD\\_CHECK](#))  
Message: CHECK OPTION on non-updatable view '%s.%s'

- Error: 1369 SQLSTATE: HY000 ([ER\\_VIEW\\_CHECK\\_FAILED](#))  
Message: CHECK OPTION failed '%s.%s'
- Error: 1370 SQLSTATE: 42000 ([ER\\_PROCACCESS\\_DENIED\\_ERROR](#))  
Message: %s command denied to user '%s'@'%s' for routine '%s'
- Error: 1371 SQLSTATE: HY000 ([ER\\_RELAY\\_LOG\\_FAIL](#))  
Message: Failed purging old relay logs: %s
- Error: 1372 SQLSTATE: HY000 ([ER\\_PASSWD\\_LENGTH](#))  
Message: Password hash should be a %d-digit hexadecimal number
- Error: 1373 SQLSTATE: HY000 ([ER\\_UNKNOWN\\_TARGET\\_BINLOG](#))  
Message: Target log not found in binlog index
- Error: 1374 SQLSTATE: HY000 ([ER\\_IO\\_ERR\\_LOG\\_INDEX\\_READ](#))  
Message: I/O error reading log index file
- Error: 1375 SQLSTATE: HY000 ([ER\\_BINLOG\\_PURGE\\_PROHIBITED](#))  
Message: Server configuration does not permit binlog purge
- Error: 1376 SQLSTATE: HY000 ([ER\\_FSEEK\\_FAIL](#))  
Message: Failed on fseek()
- Error: 1377 SQLSTATE: HY000 ([ER\\_BINLOG\\_PURGE\\_FATAL\\_ERR](#))  
Message: Fatal error during log purge
- Error: 1378 SQLSTATE: HY000 ([ER\\_LOG\\_IN\\_USE](#))  
Message: A purgeable log is in use, will not purge
- Error: 1379 SQLSTATE: HY000 ([ER\\_LOG\\_PURGE\\_UNKNOWN\\_ERR](#))  
Message: Unknown error during log purge
- Error: 1380 SQLSTATE: HY000 ([ER\\_RELAY\\_LOG\\_INIT](#))  
Message: Failed initializing relay log position: %s
- Error: 1381 SQLSTATE: HY000 ([ER\\_NO\\_BINARY\\_LOGGING](#))  
Message: You are not using binary logging
- Error: 1382 SQLSTATE: HY000 ([ER\\_RESERVED\\_SYNTAX](#))  
Message: The '%s' syntax is reserved for purposes internal to the MySQL server
- Error: 1383 SQLSTATE: HY000 ([ER\\_WSAS\\_FAILED](#))  
Message: WSASStartup Failed
- Error: 1384 SQLSTATE: HY000 ([ER\\_DIFF\\_GROUPS\\_PROC](#))  
Message: Can't handle procedures with different groups yet
- Error: 1385 SQLSTATE: HY000 ([ER\\_NO\\_GROUP\\_FOR\\_PROC](#))  
Message: Select must have a group with this procedure
- Error: 1386 SQLSTATE: HY000 ([ER\\_ORDER\\_WITH\\_PROC](#))  
Message: Can't use ORDER clause with this procedure



- Error: 1387 SQLSTATE: HY000 ([ER\\_LOGGING\\_PROHIBIT\\_CHANGING\\_OF](#))  
Message: Binary logging and replication forbid changing the global server %s
- Error: 1388 SQLSTATE: HY000 ([ER\\_NO\\_FILE\\_MAPPING](#))  
Message: Can't map file: %s, errno: %d
- Error: 1389 SQLSTATE: HY000 ([ER\\_WRONG\\_MAGIC](#))  
Message: Wrong magic in %s
- Error: 1390 SQLSTATE: HY000 ([ER\\_PS\\_MANY\\_PARAM](#))  
Message: Prepared statement contains too many placeholders
- Error: 1391 SQLSTATE: HY000 ([ER\\_KEY\\_PART\\_0](#))  
Message: Key part '%s' length cannot be 0
- Error: 1392 SQLSTATE: HY000 ([ER\\_VIEW\\_CHECKSUM](#))  
Message: View text checksum failed
- Error: 1393 SQLSTATE: HY000 ([ER\\_VIEW\\_MULTIUPDATE](#))  
Message: Can not modify more than one base table through a join view '%s.%s'
- Error: 1394 SQLSTATE: HY000 ([ER\\_VIEW\\_NO\\_INSERT\\_FIELD\\_LIST](#))  
Message: Can not insert into join view '%s.%s' without fields list
- Error: 1395 SQLSTATE: HY000 ([ER\\_VIEW\\_DELETE\\_MERGE\\_VIEW](#))  
Message: Can not delete from join view '%s.%s'
- Error: 1396 SQLSTATE: HY000 ([ER\\_CANNOT\\_USER](#))  
Message: Operation %s failed for %s
- Error: 1397 SQLSTATE: XAE04 ([ER\\_XAER\\_NOTA](#))  
Message: XAER\_NOTA: Unknown XID
- Error: 1398 SQLSTATE: XAE05 ([ER\\_XAER\\_INVALID](#))  
Message: XAER\_INVALID: Invalid arguments (or unsupported command)
- Error: 1399 SQLSTATE: XAE07 ([ER\\_XAER\\_RMFAIL](#))  
Message: XAER\_RMFAIL: The command cannot be executed when global transaction is in the %s state
- Error: 1400 SQLSTATE: XAE09 ([ER\\_XAER\\_OUTSIDE](#))  
Message: XAER\_OUTSIDE: Some work is done outside global transaction
- Error: 1401 SQLSTATE: XAE03 ([ER\\_XAER\\_RMERR](#))  
Message: XAER\_RMERR: Fatal error occurred in the transaction branch - check your data for consistency
- Error: 1402 SQLSTATE: XA100 ([ER\\_XA\\_RBROLLBACK](#))  
Message: XA\_RBROLLBACK: Transaction branch was rolled back
- Error: 1403 SQLSTATE: 42000 ([ER\\_NONEXISTING\\_PROC\\_GRANT](#))  
Message: There is no such grant defined for user '%s' on host '%s' on routine '%s'
- Error: 1404 SQLSTATE: HY000 ([ER\\_PROC\\_AUTO\\_GRANT\\_FAIL](#))  
Message: Failed to grant EXECUTE and ALTER ROUTINE privileges

- Error: 1405 SQLSTATE: HY000 ([ER\\_PROC\\_AUTO\\_REVOKE\\_FAIL](#))  
 Message: Failed to revoke all privileges to dropped routine
- Error: 1406 SQLSTATE: 22001 ([ER\\_DATA\\_TOO\\_LONG](#))  
 Message: Data too long for column '%s' at row %ld
- Error: 1407 SQLSTATE: 42000 ([ER\\_SP\\_BAD\\_SQLSTATE](#))  
 Message: Bad SQLSTATE: '%s'
- Error: 1408 SQLSTATE: HY000 ([ER\\_STARTUP](#))  
 Message: %s: ready for connections. Version: '%s' socket: '%s' port: %d %s
- Error: 1409 SQLSTATE: HY000 ([ER\\_LOAD\\_FROM\\_FIXED\\_SIZE\\_ROWS\\_TO\\_VAR](#))  
 Message: Can't load value from file with fixed size rows to variable
- Error: 1410 SQLSTATE: 42000 ([ER\\_CANT\\_CREATE\\_USER\\_WITH\\_GRANT](#))  
 Message: You are not allowed to create a user with GRANT
- Error: 1411 SQLSTATE: HY000 ([ER\\_WRONG\\_VALUE\\_FOR\\_TYPE](#))  
 Message: Incorrect %s value: '%s' for function %s
- Error: 1412 SQLSTATE: HY000 ([ER\\_TABLE\\_DEF\\_CHANGED](#))  
 Message: Table definition has changed, please retry transaction
- Error: 1413 SQLSTATE: 42000 ([ER\\_SP\\_DUP\\_HANDLER](#))  
 Message: Duplicate handler declared in the same block
- Error: 1414 SQLSTATE: 42000 ([ER\\_SP\\_NOT\\_VAR\\_ARG](#))  
 Message: OUT or INOUT argument %d for routine %s is not a variable or NEW pseudo-variable in BEFORE trigger
- Error: 1415 SQLSTATE: 0A000 ([ER\\_SP\\_NO\\_RETSET](#))  
 Message: Not allowed to return a result set from a %s
- Error: 1416 SQLSTATE: 22003 ([ER\\_CANT\\_CREATE\\_GEOMETRY\\_OBJECT](#))  
 Message: Cannot get geometry object from data you send to the GEOMETRY field
- Error: 1417 SQLSTATE: HY000 ([ER\\_FAILED\\_ROUTINE\\_BREAK\\_BINLOG](#))  
 Message: A routine failed and has neither NO SQL nor READS SQL DATA in its declaration and binary logging is enabled; if non-transactional tables were updated, the binary log will miss their changes
- Error: 1418 SQLSTATE: HY000 ([ER\\_BINLOG\\_UNSAFE\\_ROUTINE](#))  
 Message: This function has none of DETERMINISTIC, NO SQL, or READS SQL DATA in its declaration and binary logging is enabled (you \*might\* want to use the less safe log\_bin\_trust\_function\_creators variable)
- Error: 1419 SQLSTATE: HY000 ([ER\\_BINLOG\\_CREATE\\_ROUTINE\\_NEED\\_SUPER](#))  
 Message: You do not have the SUPER privilege and binary logging is enabled (you \*might\* want to use the less safe log\_bin\_trust\_function\_creators variable)
- Error: 1420 SQLSTATE: HY000 ([ER\\_EXEC\\_STMT\\_WITH\\_OPEN\\_CURSOR](#))  
 Message: You can't execute a prepared statement which has an open cursor associated with it. Reset the statement to re-execute it.
- Error: 1421 SQLSTATE: HY000 ([ER\\_STMT\\_HAS\\_NO\\_OPEN\\_CURSOR](#))  
 Message: The statement (%lu) has no open cursor.

- Error: 1422 SQLSTATE: HY000 ([ER\\_COMMIT\\_NOT\\_ALLOWED\\_IN\\_SF\\_OR\\_TRG](#))  
Message: Explicit or implicit commit is not allowed in stored function or trigger.
- Error: 1423 SQLSTATE: HY000 ([ER\\_NO\\_DEFAULT\\_FOR\\_VIEW\\_FIELD](#))  
Message: Field of view '%s.%s' underlying table doesn't have a default value
- Error: 1424 SQLSTATE: HY000 ([ER\\_SP\\_NO\\_RECURSION](#))  
Message: Recursive stored functions and triggers are not allowed.
- Error: 1425 SQLSTATE: 42000 ([ER\\_TOO\\_BIG\\_SCALE](#))  
Message: Too big scale %d specified for column '%s'. Maximum is %lu.
- Error: 1426 SQLSTATE: 42000 ([ER\\_TOO\\_BIG\\_PRECISION](#))  
Message: Too big precision %d specified for column '%s'. Maximum is %lu.
- Error: 1427 SQLSTATE: 42000 ([ER\\_M\\_BIGGER\\_THAN\\_D](#))  
Message: For float(M,D), double(M,D) or decimal(M,D), M must be >= D (column '%s').
- Error: 1428 SQLSTATE: HY000 ([ER\\_WRONG\\_LOCK\\_OF\\_SYSTEM\\_TABLE](#))  
Message: You can't combine write-locking of system tables with other tables or lock types
- Error: 1429 SQLSTATE: HY000 ([ER\\_CONNECT\\_TO\\_FOREIGN\\_DATA\\_SOURCE](#))  
Message: Unable to connect to foreign data source: %s
- Error: 1430 SQLSTATE: HY000 ([ER\\_QUERY\\_ON\\_FOREIGN\\_DATA\\_SOURCE](#))  
Message: There was a problem processing the query on the foreign data source. Data source error: %s
- Error: 1431 SQLSTATE: HY000 ([ER\\_FOREIGN\\_DATA\\_SOURCE\\_DOESNT\\_EXIST](#))  
Message: The foreign data source you are trying to reference does not exist. Data source error: %s
- Error: 1432 SQLSTATE: HY000 ([ER\\_FOREIGN\\_DATA\\_STRING\\_INVALID\\_CANT\\_CREATE](#))  
Message: Can't create federated table. The data source connection string '%s' is not in the correct format
- Error: 1433 SQLSTATE: HY000 ([ER\\_FOREIGN\\_DATA\\_STRING\\_INVALID](#))  
Message: The data source connection string '%s' is not in the correct format
- Error: 1434 SQLSTATE: HY000 ([ER\\_CANT\\_CREATE\\_FEDERATED\\_TABLE](#))  
Message: Can't create federated table. Foreign data src error: %s
- Error: 1435 SQLSTATE: HY000 ([ER\\_TRG\\_IN\\_WRONG\\_SCHEMA](#))  
Message: Trigger in wrong schema
- Error: 1436 SQLSTATE: HY000 ([ER\\_STACK\\_OVERRUN\\_NEED\\_MORE](#))  
Message: Thread stack overrun: %ld bytes used of a %ld byte stack, and %ld bytes needed. Use 'mysqld -O thread\_stack=#' to specify a bigger stack.
- Error: 1437 SQLSTATE: 42000 ([ER\\_TOO\\_LONG\\_BODY](#))  
Message: Routine body for '%s' is too long
- Error: 1438 SQLSTATE: HY000 ([ER\\_WARN\\_CANT\\_DROP\\_DEFAULT\\_KEYCACHE](#))  
Message: Cannot drop default keycache
- Error: 1439 SQLSTATE: 42000 ([ER\\_TOO\\_BIG\\_DISPLAYWIDTH](#))  
Message: Display width out of range for column '%s' (max = %lu)

- Error: 1440 SQLSTATE: XAE08 ([ER\\_XAER\\_DUPID](#))  
 Message: XAER\_DUPID: The XID already exists
- Error: 1441 SQLSTATE: 22008 ([ER\\_DATETIME\\_FUNCTION\\_OVERFLOW](#))  
 Message: Datetime function: %s field overflow
- Error: 1442 SQLSTATE: HY000 ([ER\\_CANT\\_UPDATE\\_USED\\_TABLE\\_IN\\_SF\\_OR\\_TRG](#))  
 Message: Can't update table '%s' in stored function/trigger because it is already used by statement which invoked this stored function/trigger.
- Error: 1443 SQLSTATE: HY000 ([ER\\_VIEW\\_PREVENT\\_UPDATE](#))  
 Message: The definition of table '%s' prevents operation %s on table '%s'.
- Error: 1444 SQLSTATE: HY000 ([ER\\_PS\\_NO\\_RECURSION](#))  
 Message: The prepared statement contains a stored routine call that refers to that same statement. It's not allowed to execute a prepared statement in such a recursive manner
- Error: 1445 SQLSTATE: HY000 ([ER\\_SP\\_CANT\\_SET\\_AUTOCOMMIT](#))  
 Message: Not allowed to set autocommit from a stored function or trigger
- Error: 1446 SQLSTATE: HY000 ([ER\\_MALFORMED\\_DEFINER](#))  
 Message: Definer is not fully qualified
- Error: 1447 SQLSTATE: HY000 ([ER\\_VIEW\\_FRM\\_NO\\_USER](#))  
 Message: View '%s'.'%s' has no definer information (old table format). Current user is used as definer. Please recreate the view!
- Error: 1448 SQLSTATE: HY000 ([ER\\_VIEW\\_OTHER\\_USER](#))  
 Message: You need the SUPER privilege for creation view with '%s'@'%s' definer
- Error: 1449 SQLSTATE: HY000 ([ER\\_NO\\_SUCH\\_USER](#))  
 Message: The user specified as a definer ('%s'@'%s') does not exist
- Error: 1450 SQLSTATE: HY000 ([ER\\_FORBID\\_SCHEMA\\_CHANGE](#))  
 Message: Changing schema from '%s' to '%s' is not allowed.
- Error: 1451 SQLSTATE: 23000 ([ER\\_ROW\\_IS\\_REFERENCED\\_2](#))  
 Message: Cannot delete or update a parent row: a foreign key constraint fails (%s)
- Error: 1452 SQLSTATE: 23000 ([ER\\_NO\\_REFERENCED\\_ROW\\_2](#))  
 Message: Cannot add or update a child row: a foreign key constraint fails (%s)
- Error: 1453 SQLSTATE: 42000 ([ER\\_SP\\_BAD\\_VAR\\_SHADOW](#))  
 Message: Variable '%s' must be quoted with `...`, or renamed
- Error: 1454 SQLSTATE: HY000 ([ER\\_TRG\\_NO\\_DEFINER](#))  
 Message: No definer attribute for trigger '%s'.'%s'. The trigger will be activated under the authorization of the invoker, which may have insufficient privileges. Please recreate the trigger.
- Error: 1455 SQLSTATE: HY000 ([ER\\_OLD\\_FILE\\_FORMAT](#))  
 Message: '%s' has an old format, you should re-create the '%s' object(s)
- Error: 1456 SQLSTATE: HY000 ([ER\\_SP\\_RECURSION\\_LIMIT](#))  
 Message: Recursive limit %d (as set by the max\_sp\_recursion\_depth variable) was exceeded for routine %s
- Error: 1457 SQLSTATE: HY000 ([ER\\_SP\\_PROC\\_TABLE\\_CORRUPT](#))

- Message: Failed to load routine %s. The table mysql.proc is missing, corrupt, or contains bad data (internal code %d)

  - Error: 1458 SQLSTATE: 42000 (ER\_SP\_WRONG\_NAME)

Message: Incorrect routine name '%s'

  - Error: 1459 SQLSTATE: HY000 (ER\_TABLE\_NEEDS\_UPGRADE)

Message: Table upgrade required. Please do "REPAIR TABLE `%s`" or dump/reload to fix it!

  - Error: 1460 SQLSTATE: 42000 (ER\_SP\_NO\_AGGREGATE)

Message: AGGREGATE is not supported for stored functions

  - Error: 1461 SQLSTATE: 42000 (ER\_MAX\_PREPARED\_STMT\_COUNT\_REACHED)

Message: Can't create more than max\_prepared\_stmt\_count statements (current value: %lu)

  - Error: 1462 SQLSTATE: HY000 (ER\_VIEW\_RECURSIVE)

Message: `%s`.`%s` contains view recursion

  - Error: 1463 SQLSTATE: 42000 (ER\_NON\_GROUPING\_FIELD\_USED)

Message: non-grouping field '%s' is used in %s clause

  - Error: 1464 SQLSTATE: HY000 (ER\_TABLE\_CANT\_HANDLE\_SPKEYS)

Message: The used table type doesn't support SPATIAL indexes

  - Error: 1465 SQLSTATE: HY000 (ER\_NO\_TRIGGERS\_ON\_SYSTEM\_SCHEMA)

Message: Triggers can not be created on system tables

  - Error: 1466 SQLSTATE: HY000 (ER\_REMOVED\_SPACES)

Message: Leading spaces are removed from name '%s'

  - Error: 1467 SQLSTATE: HY000 (ER\_AUTOINC\_READ\_FAILED)

Message: Failed to read auto-increment value from storage engine

  - Error: 1468 SQLSTATE: HY000 (ER\_USERNAME)

Message: user name

  - Error: 1469 SQLSTATE: HY000 (ER\_HOSTNAME)

Message: host name

  - Error: 1470 SQLSTATE: HY000 (ER\_WRONG\_STRING\_LENGTH)

Message: String '%s' is too long for %s (should be no longer than %d)

  - Error: 1471 SQLSTATE: HY000 (ER\_NON\_INSERTABLE\_TABLE)

Message: The target table %s of the %s is not insertable-into

  - Error: 1472 SQLSTATE: HY000 (ER\_ADMIN\_WRONG\_MRG\_TABLE)

Message: Table '%s' is differently defined or of non-MyISAM type or doesn't exist

  - Error: 1473 SQLSTATE: HY000 (ER\_TOO\_HIGH\_LEVEL\_OF\_NESTING\_FOR\_SELECT)

Message: Too high level of nesting for select

  - Error: 1474 SQLSTATE: HY000 (ER\_NAME\_BECOMES\_EMPTY)

Message: Name '%s' has become "

  - Error: 1475 SQLSTATE: HY000 (ER\_AMBIGUOUS\_FIELD\_TERM)

Message: First character of the FIELDS TERMINATED string is ambiguous; please use non-optional and non-empty FIELDS ENCLOSED BY

- Error: 1476 SQLSTATE: HY000 (ER\_FOREIGN\_SERVER\_EXISTS)  
 Message: The foreign server, %s, you are trying to create already exists.
- Error: 1477 SQLSTATE: HY000 (ER\_FOREIGN\_SERVER\_DOESNT\_EXIST)  
 Message: The foreign server name you are trying to reference does not exist. Data source error: %s
- Error: 1478 SQLSTATE: HY000 (ER\_ILLEGAL\_HA\_CREATE\_OPTION)  
 Message: Table storage engine '%s' does not support the create option '%s'
- Error: 1479 SQLSTATE: HY000 (ER\_PARTITION\_REQUIRES\_VALUES\_ERROR)  
 Message: Syntax error: %s PARTITIONING requires definition of VALUES %s for each partition
- Error: 1480 SQLSTATE: HY000 (ER\_PARTITION\_WRONG\_VALUES\_ERROR)  
 Message: Only %s PARTITIONING can use VALUES %s in partition definition
- Error: 1481 SQLSTATE: HY000 (ER\_PARTITION\_MAXVALUE\_ERROR)  
 Message: MAXVALUE can only be used in last partition definition
- Error: 1482 SQLSTATE: HY000 (ER\_PARTITION\_SUBPARTITION\_ERROR)  
 Message: Subpartitions can only be hash partitions and by key
- Error: 1483 SQLSTATE: HY000 (ER\_PARTITION\_SUBPART\_MIX\_ERROR)  
 Message: Must define subpartitions on all partitions if on one partition
- Error: 1484 SQLSTATE: HY000 (ER\_PARTITION\_WRONG\_NO\_PART\_ERROR)  
 Message: Wrong number of partitions defined, mismatch with previous setting
- Error: 1485 SQLSTATE: HY000 (ER\_PARTITION\_WRONG\_NO\_SUBPART\_ERROR)  
 Message: Wrong number of subpartitions defined, mismatch with previous setting
- Error: 1486 SQLSTATE: HY000 (ER\_CONST\_EXPR\_IN\_PARTITION\_FUNC\_ERROR)  
 Message: Constant/Random expression in (sub)partitioning function is not allowed
- Error: 1487 SQLSTATE: HY000 (ER\_NO\_CONST\_EXPR\_IN\_RANGE\_OR\_LIST\_ERROR)  
 Message: Expression in RANGE/LIST VALUES must be constant
- Error: 1488 SQLSTATE: HY000 (ER\_FIELD\_NOT\_FOUND\_PART\_ERROR)  
 Message: Field in list of fields for partition function not found in table
- Error: 1489 SQLSTATE: HY000 (ER\_LIST\_OF\_FIELDS\_ONLY\_IN\_HASH\_ERROR)  
 Message: List of fields is only allowed in KEY partitions
- Error: 1490 SQLSTATE: HY000 (ER\_INCONSISTENT\_PARTITION\_INFO\_ERROR)  
 Message: The partition info in the frm file is not consistent with what can be written into the frm file
- Error: 1491 SQLSTATE: HY000 (ER\_PARTITION\_FUNC\_NOT\_ALLOWED\_ERROR)  
 Message: The %s function returns the wrong type
- Error: 1492 SQLSTATE: HY000 (ER\_PARTITIONS\_MUST\_BE\_DEFINED\_ERROR)  
 Message: For %s partitions each partition must be defined

- Error: 1493 SQLSTATE: HY000 ([ER\\_RANGE\\_NOT\\_INCREASING\\_ERROR](#))  
 Message: VALUES LESS THAN value must be strictly increasing for each partition
- Error: 1494 SQLSTATE: HY000 ([ER\\_INCONSISTENT\\_TYPE\\_OF\\_FUNCTIONS\\_ERROR](#))  
 Message: VALUES value must be of same type as partition function
- Error: 1495 SQLSTATE: HY000 ([ER\\_MULTIPLE\\_DEF\\_CONST\\_IN\\_LIST\\_PART\\_ERROR](#))  
 Message: Multiple definition of same constant in list partitioning
- Error: 1496 SQLSTATE: HY000 ([ER\\_PARTITION\\_ENTRY\\_ERROR](#))  
 Message: Partitioning can not be used stand-alone in query
- Error: 1497 SQLSTATE: HY000 ([ER\\_MIX\\_HANDLER\\_ERROR](#))  
 Message: The mix of handlers in the partitions is not allowed in this version of MySQL
- Error: 1498 SQLSTATE: HY000 ([ER\\_PARTITION\\_NOT\\_DEFINED\\_ERROR](#))  
 Message: For the partitioned engine it is necessary to define all %s
- Error: 1499 SQLSTATE: HY000 ([ER\\_TOO\\_MANY\\_PARTITIONS\\_ERROR](#))  
 Message: Too many partitions (including subpartitions) were defined
- Error: 1500 SQLSTATE: HY000 ([ER\\_SUBPARTITION\\_ERROR](#))  
 Message: It is only possible to mix RANGE/LIST partitioning with HASH/KEY partitioning for subpartitioning
- Error: 1501 SQLSTATE: HY000 ([ER\\_CANT\\_CREATE\\_HANDLER\\_FILE](#))  
 Message: Failed to create specific handler file
- Error: 1502 SQLSTATE: HY000 ([ER\\_BLOB\\_FIELD\\_IN\\_PART\\_FUNC\\_ERROR](#))  
 Message: A BLOB field is not allowed in partition function
- Error: 1503 SQLSTATE: HY000 ([ER\\_UNIQUE\\_KEY\\_NEED\\_ALL\\_FIELDS\\_IN\\_PF](#))  
 Message: A %s must include all columns in the table's partitioning function
- Error: 1504 SQLSTATE: HY000 ([ER\\_NO\\_PARTS\\_ERROR](#))  
 Message: Number of %s = 0 is not an allowed value
- Error: 1505 SQLSTATE: HY000 ([ER\\_PARTITION\\_MGMT\\_ON\\_NONPARTITIONED](#))  
 Message: Partition management on a not partitioned table is not possible
- Error: 1506 SQLSTATE: HY000 ([ER\\_FOREIGN\\_KEY\\_ON\\_PARTITIONED](#))  
 Message: Foreign key clause is not yet supported in conjunction with partitioning
- Error: 1507 SQLSTATE: HY000 ([ER\\_DROP\\_PARTITION\\_NON\\_EXISTENT](#))  
 Message: Error in list of partitions to %s
- Error: 1508 SQLSTATE: HY000 ([ER\\_DROP\\_LAST\\_PARTITION](#))  
 Message: Cannot remove all partitions, use DROP TABLE instead
- Error: 1509 SQLSTATE: HY000 ([ER\\_COALESCE\\_ONLY\\_ON\\_HASH\\_PARTITION](#))  
 Message: COALESCE PARTITION can only be used on HASH/KEY partitions
- Error: 1510 SQLSTATE: HY000 ([ER\\_REORG\\_HASH\\_ONLY\\_ON\\_SAME\\_NO](#))  
 Message: REORGANIZE PARTITION can only be used to reorganize partitions not to change their numbers

- Error: 1511 SQLSTATE: HY000 ([ER\\_REORG\\_NO\\_PARAM\\_ERROR](#))  
Message: REORGANIZE PARTITION without parameters can only be used on auto-partitioned tables using HASH PARTITIONS
- Error: 1512 SQLSTATE: HY000 ([ER\\_ONLY\\_ON\\_RANGE\\_LIST\\_PARTITION](#))  
Message: %s PARTITION can only be used on RANGE/LIST partitions
- Error: 1513 SQLSTATE: HY000 ([ER\\_ADD\\_PARTITION\\_SUBPART\\_ERROR](#))  
Message: Trying to Add partition(s) with wrong number of subpartitions
- Error: 1514 SQLSTATE: HY000 ([ER\\_ADD\\_PARTITION\\_NO\\_NEW\\_PARTITION](#))  
Message: At least one partition must be added
- Error: 1515 SQLSTATE: HY000 ([ER\\_COALESCE\\_PARTITION\\_NO\\_PARTITION](#))  
Message: At least one partition must be coalesced
- Error: 1516 SQLSTATE: HY000 ([ER\\_REORG\\_PARTITION\\_NOT\\_EXIST](#))  
Message: More partitions to reorganize than there are partitions
- Error: 1517 SQLSTATE: HY000 ([ER\\_SAME\\_NAME\\_PARTITION](#))  
Message: Duplicate partition name %s
- Error: 1518 SQLSTATE: HY000 ([ER\\_NO\\_BINLOG\\_ERROR](#))  
Message: It is not allowed to shut off binlog on this command
- Error: 1519 SQLSTATE: HY000 ([ER\\_CONSECUTIVE\\_REORG\\_PARTITIONS](#))  
Message: When reorganizing a set of partitions they must be in consecutive order
- Error: 1520 SQLSTATE: HY000 ([ER\\_REORG\\_OUTSIDE\\_RANGE](#))  
Message: Reorganize of range partitions cannot change total ranges except for last partition where it can extend the range
- Error: 1521 SQLSTATE: HY000 ([ER\\_PARTITION\\_FUNCTION\\_FAILURE](#))  
Message: Partition function not supported in this version for this handler
- Error: 1522 SQLSTATE: HY000 ([ER\\_PART\\_STATE\\_ERROR](#))  
Message: Partition state cannot be defined from CREATE/ALTER TABLE
- Error: 1523 SQLSTATE: HY000 ([ER\\_LIMITED\\_PART\\_RANGE](#))  
Message: The %s handler only supports 32 bit integers in VALUES
- Error: 1524 SQLSTATE: HY000 ([ER\\_PLUGIN\\_IS\\_NOT\\_LOADED](#))  
Message: Plugin '%s' is not loaded
- Error: 1525 SQLSTATE: HY000 ([ER\\_WRONG\\_VALUE](#))  
Message: Incorrect %s value: '%s'
- Error: 1526 SQLSTATE: HY000 ([ER\\_NO\\_PARTITION\\_FOR\\_GIVEN\\_VALUE](#))  
Message: Table has no partition for value %s
- Error: 1527 SQLSTATE: HY000 ([ER\\_FILEGROUP\\_OPTION\\_ONLY\\_ONCE](#))  
Message: It is not allowed to specify %s more than once
- Error: 1528 SQLSTATE: HY000 ([ER\\_CREATE\\_FILEGROUP\\_FAILED](#))  
Message: Failed to create %s



- Error: 1529 SQLSTATE: HY000 ([ER\\_DROP\\_FILEGROUP\\_FAILED](#))  
Message: Failed to drop %s
- Error: 1530 SQLSTATE: HY000 ([ER\\_TABLESPACE\\_AUTO\\_EXTEND\\_ERROR](#))  
Message: The handler doesn't support autoextend of tablespaces
- Error: 1531 SQLSTATE: HY000 ([ER\\_WRONG\\_SIZE\\_NUMBER](#))  
Message: A size parameter was incorrectly specified, either number or on the form 10M
- Error: 1532 SQLSTATE: HY000 ([ER\\_SIZE\\_OVERFLOW\\_ERROR](#))  
Message: The size number was correct but we don't allow the digit part to be more than 2 billion
- Error: 1533 SQLSTATE: HY000 ([ER\\_ALTER\\_FILEGROUP\\_FAILED](#))  
Message: Failed to alter: %s
- Error: 1534 SQLSTATE: HY000 ([ER\\_BINLOG\\_ROW\\_LOGGING\\_FAILED](#))  
Message: Writing one row to the row-based binary log failed
- Error: 1535 SQLSTATE: HY000 ([ER\\_BINLOG\\_ROW\\_WRONG\\_TABLE\\_DEF](#))  
Message: Table definition on master and slave does not match: %s
- Error: 1536 SQLSTATE: HY000 ([ER\\_BINLOG\\_ROW\\_RBR\\_TO\\_SBR](#))  
Message: Slave running with --log-slave-updates must use row-based binary logging to be able to replicate row-based binary log events
- Error: 1537 SQLSTATE: HY000 ([ER\\_EVENT\\_ALREADY\\_EXISTS](#))  
Message: Event '%s' already exists
- Error: 1538 SQLSTATE: HY000 ([ER\\_EVENT\\_STORE\\_FAILED](#))  
Message: Failed to store event %s. Error code %d from storage engine.
- Error: 1539 SQLSTATE: HY000 ([ER\\_EVENT\\_DOES\\_NOT\\_EXIST](#))  
Message: Unknown event '%s'
- Error: 1540 SQLSTATE: HY000 ([ER\\_EVENT\\_CANT ALTER](#))  
Message: Failed to alter event '%s'
- Error: 1541 SQLSTATE: HY000 ([ER\\_EVENT\\_DROP\\_FAILED](#))  
Message: Failed to drop %s
- Error: 1542 SQLSTATE: HY000 ([ER\\_EVENT\\_INTERVAL\\_NOT\\_POSITIVE\\_OR\\_TOO\\_BIG](#))  
Message: INTERVAL is either not positive or too big
- Error: 1543 SQLSTATE: HY000 ([ER\\_EVENT\\_ENDS\\_BEFORE\\_STARTS](#))  
Message: ENDS is either invalid or before STARTS
- Error: 1544 SQLSTATE: HY000 ([ER\\_EVENT\\_EXEC\\_TIME\\_IN\\_THE\\_PAST](#))  
Message: Event execution time is in the past. Event has been disabled
- Error: 1545 SQLSTATE: HY000 ([ER\\_EVENT\\_OPEN\\_TABLE\\_FAILED](#))  
Message: Failed to open mysql.event
- Error: 1546 SQLSTATE: HY000 ([ER\\_EVENT\\_NEITHER\\_M\\_EXPR\\_NOR\\_M\\_AT](#))  
Message: No datetime expression provided

- Error: 1547 SQLSTATE: HY000 ([ER\\_COL\\_COUNT\\_DOESNT\\_MATCH\\_CORRUPTED](#))  
 Message: Column count of mysql.%s is wrong. Expected %d, found %d. The table is probably corrupted
- Error: 1548 SQLSTATE: HY000 ([ER\\_CANNOT\\_LOAD\\_FROM\\_TABLE](#))  
 Message: Cannot load from mysql.%s. The table is probably corrupted
- Error: 1549 SQLSTATE: HY000 ([ER\\_EVENT\\_CANNOT\\_DELETE](#))  
 Message: Failed to delete the event from mysql.event
- Error: 1550 SQLSTATE: HY000 ([ER\\_EVENT\\_COMPILE\\_ERROR](#))  
 Message: Error during compilation of event's body
- Error: 1551 SQLSTATE: HY000 ([ER\\_EVENT\\_SAME\\_NAME](#))  
 Message: Same old and new event name
- Error: 1552 SQLSTATE: HY000 ([ER\\_EVENT\\_DATA\\_TOO\\_LONG](#))  
 Message: Data for column '%s' too long
- Error: 1553 SQLSTATE: HY000 ([ER\\_DROP\\_INDEX\\_FK](#))  
 Message: Cannot drop index '%s': needed in a foreign key constraint
- Error: 1554 SQLSTATE: HY000 ([ER\\_WARN\\_DEPRECATED\\_SYNTAX\\_WITH\\_VER](#))  
 Message: The syntax '%s' is deprecated and will be removed in MySQL %s. Please use %s instead
- Error: 1555 SQLSTATE: HY000 ([ER\\_CANT\\_WRITE\\_LOCK\\_LOG\\_TABLE](#))  
 Message: You can't write-lock a log table. Only read access is possible
- Error: 1556 SQLSTATE: HY000 ([ER\\_CANT\\_LOCK\\_LOG\\_TABLE](#))  
 Message: You can't use locks with log tables.
- Error: 1557 SQLSTATE: 23000 ([ER\\_FOREIGN\\_DUPLICATE\\_KEY](#))  
 Message: Upholding foreign key constraints for table '%s', entry '%s', key %d would lead to a duplicate entry
- Error: 1558 SQLSTATE: HY000 ([ER\\_COL\\_COUNT\\_DOESNT\\_MATCH\\_PLEASE\\_UPDATE](#))  
 Message: Column count of mysql.%s is wrong. Expected %d, found %d. Created with MySQL %d, now running %d. Please use mysql\_upgrade to fix this error.
- Error: 1559 SQLSTATE: HY000 ([ER\\_TEMP\\_TABLE\\_PREVENTS\\_SWITCH\\_OUT\\_OF\\_RBR](#))  
 Message: Cannot switch out of the row-based binary log format when the session has open temporary tables
- Error: 1560 SQLSTATE: HY000 ([ER\\_STORED\\_FUNCTION\\_PREVENTS\\_SWITCH\\_BINLOG\\_FORMAT](#))  
 Message: Cannot change the binary logging format inside a stored function or trigger
- Error: 1561 SQLSTATE: HY000 ([ER\\_NDB\\_CANT\\_SWITCH\\_BINLOG\\_FORMAT](#))  
 Message: The NDB cluster engine does not support changing the binlog format on the fly yet
- Error: 1562 SQLSTATE: HY000 ([ER\\_PARTITION\\_NO\\_TEMPORARY](#))  
 Message: Cannot create temporary table with partitions
- Error: 1563 SQLSTATE: HY000 ([ER\\_PARTITION\\_CONST\\_DOMAIN\\_ERROR](#))  
 Message: Partition constant is out of partition function domain
- Error: 1564 SQLSTATE: HY000 ([ER\\_PARTITION\\_FUNCTION\\_IS\\_NOT\\_ALLOWED](#))  
 Message: This partition function is not allowed

- Error: 1565 SQLSTATE: HY000 ([ER\\_DDL\\_LOG\\_ERROR](#))  
 Message: Error in DDL log
- Error: 1566 SQLSTATE: HY000 ([ER\\_NULL\\_IN\\_VALUES\\_LESS\\_THAN](#))  
 Message: Not allowed to use NULL value in VALUES LESS THAN
- Error: 1567 SQLSTATE: HY000 ([ER\\_WRONG\\_PARTITION\\_NAME](#))  
 Message: Incorrect partition name
- Error: 1568 SQLSTATE: 25001 ([ER\\_CANT\\_CHANGE\\_TX\\_ISOLATION](#))  
 Message: Transaction isolation level can't be changed while a transaction is in progress
- Error: 1569 SQLSTATE: HY000 ([ER\\_DUP\\_ENTRY\\_AUTOINCREMENT\\_CASE](#))  
 Message: ALTER TABLE causes auto\_increment resequencing, resulting in duplicate entry '%s' for key '%s'
- Error: 1570 SQLSTATE: HY000 ([ER\\_EVENT\\_MODIFY\\_QUEUE\\_ERROR](#))  
 Message: Internal scheduler error %d
- Error: 1571 SQLSTATE: HY000 ([ER\\_EVENT\\_SET\\_VAR\\_ERROR](#))  
 Message: Error during starting/stopping of the scheduler. Error code %u
- Error: 1572 SQLSTATE: HY000 ([ER\\_PARTITION\\_MERGE\\_ERROR](#))  
 Message: Engine cannot be used in partitioned tables
- Error: 1573 SQLSTATE: HY000 ([ER\\_CANT\\_ACTIVATE\\_LOG](#))  
 Message: Cannot activate '%s' log
- Error: 1574 SQLSTATE: HY000 ([ER\\_RBR\\_NOT\\_AVAILABLE](#))  
 Message: The server was not built with row-based replication
- Error: 1575 SQLSTATE: HY000 ([ER\\_BASE64\\_DECODE\\_ERROR](#))  
 Message: Decoding of base64 string failed
- Error: 1576 SQLSTATE: HY000 ([ER\\_EVENT\\_RECURSION\\_FORBIDDEN](#))  
 Message: Recursion of EVENT DDL statements is forbidden when body is present
- Error: 1577 SQLSTATE: HY000 ([ER\\_EVENTS\\_DB\\_ERROR](#))  
 Message: Cannot proceed because system tables used by Event Scheduler were found damaged at server start
- Error: 1578 SQLSTATE: HY000 ([ER\\_ONLY\\_INTEGERS\\_ALLOWED](#))  
 Message: Only integers allowed as number here
- Error: 1579 SQLSTATE: HY000 ([ER\\_UNSUPPORTED\\_LOG\\_ENGINE](#))  
 Message: This storage engine cannot be used for log tables"
- Error: 1580 SQLSTATE: HY000 ([ER\\_BAD\\_LOG\\_STATEMENT](#))  
 Message: You cannot '%s' a log table if logging is enabled
- Error: 1581 SQLSTATE: HY000 ([ER\\_CANT\\_RENAME\\_LOG\\_TABLE](#))  
 Message: Cannot rename '%s'. When logging enabled, rename to/from log table must rename two tables: the log table to an archive table and another table back to '%s'
- Error: 1582 SQLSTATE: 42000 ([ER\\_WRONG\\_PARAMCOUNT\\_TO\\_NATIVE\\_FCT](#))  
 Message: Incorrect parameter count in the call to native function '%s'

- Error: 1583 SQLSTATE: 42000 ([ER\\_WRONG\\_PARAMETERS\\_TO\\_NATIVE\\_FCT](#))  
 Message: Incorrect parameters in the call to native function '%s'
- Error: 1584 SQLSTATE: 42000 ([ER\\_WRONG\\_PARAMETERS\\_TO\\_STORED\\_FCT](#))  
 Message: Incorrect parameters in the call to stored function '%s'
- Error: 1585 SQLSTATE: HY000 ([ER\\_NATIVE\\_FCT\\_NAME\\_COLLISION](#))  
 Message: This function '%s' has the same name as a native function
- Error: 1586 SQLSTATE: 23000 ([ER\\_DUP\\_ENTRY\\_WITH\\_KEY\\_NAME](#))  
 Message: Duplicate entry '%s' for key '%s'
- Error: 1587 SQLSTATE: HY000 ([ER\\_BINLOG\\_PURGE\\_EMFILE](#))  
 Message: Too many files opened, please execute the command again
- Error: 1588 SQLSTATE: HY000 ([ER\\_EVENT\\_CANNOT\\_CREATE\\_IN\\_THE\\_PAST](#))  
 Message: Event execution time is in the past and ON COMPLETION NOT PRESERVE is set. The event was dropped immediately after creation.
- Error: 1589 SQLSTATE: HY000 ([ER\\_EVENT\\_CANNOT\\_ALTER\\_IN\\_THE\\_PAST](#))  
 Message: Event execution time is in the past and ON COMPLETION NOT PRESERVE is set. The event was dropped immediately after creation.
- Error: 1590 SQLSTATE: HY000 ([ER\\_SLAVE\\_INCIDENT](#))  
 Message: The incident %s occurred on the master. Message: %s
- Error: 1591 SQLSTATE: HY000 ([ER\\_NO\\_PARTITION\\_FOR\\_GIVEN\\_VALUE\\_SILENT](#))  
 Message: Table has no partition for some existing values
- Error: 1592 SQLSTATE: HY000 ([ER\\_BINLOG\\_UNSAFE\\_STATEMENT](#))  
 Message: Statement may not be safe to log in statement format.
- Error: 1593 SQLSTATE: HY000 ([ER\\_SLAVE\\_FATAL\\_ERROR](#))  
 Message: Fatal error: %s
- Error: 1594 SQLSTATE: HY000 ([ER\\_SLAVE\\_RELAY\\_LOG\\_READ\\_FAILURE](#))  
 Message: Relay log read failure: %s
- Error: 1595 SQLSTATE: HY000 ([ER\\_SLAVE\\_RELAY\\_LOG\\_WRITE\\_FAILURE](#))  
 Message: Relay log write failure: %s
- Error: 1596 SQLSTATE: HY000 ([ER\\_SLAVE\\_CREATE\\_EVENT\\_FAILURE](#))  
 Message: Failed to create %s
- Error: 1597 SQLSTATE: HY000 ([ER\\_SLAVE\\_MASTER\\_COM\\_FAILURE](#))  
 Message: Master command %s failed: %s
- Error: 1598 SQLSTATE: HY000 ([ER\\_BINLOG\\_LOGGING\\_IMPOSSIBLE](#))  
 Message: Binary logging not possible. Message: %s
- Error: 1599 SQLSTATE: HY000 ([ER\\_VIEW\\_NO\\_CREATION\\_CTX](#))  
 Message: View `%s`.`%s` has no creation context
- Error: 1600 SQLSTATE: HY000 ([ER\\_VIEW\\_INVALID\\_CREATION\\_CTX](#))

- Message: Creation context of view `%s`.`%s` is invalid

  - Error: 1601 SQLSTATE: HY000 ([ER\\_SR\\_INVALID\\_CREATION\\_CTX](#))
- Message: Creation context of stored routine `%s`.`%s` is invalid

  - Error: 1602 SQLSTATE: HY000 ([ER\\_TRG\\_CORRUPTED\\_FILE](#))
- Message: Corrupted TRG file for table `%s`.`%s`

  - Error: 1603 SQLSTATE: HY000 ([ER\\_TRG\\_NO\\_CREATION\\_CTX](#))
- Message: Triggers for table `%s`.`%s` have no creation context

  - Error: 1604 SQLSTATE: HY000 ([ER\\_TRG\\_INVALID\\_CREATION\\_CTX](#))
- Message: Trigger creation context of table `%s`.`%s` is invalid

  - Error: 1605 SQLSTATE: HY000 ([ER\\_EVENT\\_INVALID\\_CREATION\\_CTX](#))
- Message: Creation context of event `%s`.`%s` is invalid

  - Error: 1606 SQLSTATE: HY000 ([ER\\_TRG\\_CANT\\_OPEN\\_TABLE](#))
- Message: Cannot open table for trigger `%s`.`%s`

  - Error: 1607 SQLSTATE: HY000 ([ER\\_CANT\\_CREATE\\_SROUTINE](#))
- Message: Cannot create stored routine `%s`. Check warnings

  - Error: 1608 SQLSTATE: HY000 ([ER\\_SLAVE\\_AMBIGUOUS\\_EXEC\\_MODE](#))
- Message: Ambiguous slave modes combination. %s

  - Error: 1609 SQLSTATE: HY000 ([ER\\_NO\\_FORMAT\\_DESCRIPTION\\_EVENT\\_BEFORE\\_BINLOG\\_STATEMENT](#))
- Message: The BINLOG statement of type `%s` was not preceded by a format description BINLOG statement.

  - Error: 1610 SQLSTATE: HY000 ([ER\\_SLAVE\\_CORRUPT\\_EVENT](#))
- Message: Corrupted replication event was detected

  - Error: 1611 SQLSTATE: HY000 ([ER\\_LOAD\\_DATA\\_INVALID\\_COLUMN](#))
- Message: Invalid column reference (%s) in LOAD DATA

  - Error: 1612 SQLSTATE: HY000 ([ER\\_LOG\\_PURGE\\_NO\\_FILE](#))
- Message: Being purged log %s was not found

  - Error: 1613 SQLSTATE: XA106 ([ER\\_XA\\_RBTIMEOUT](#))
- Message: XA\_RBTIMEOUT: Transaction branch was rolled back: took too long

  - Error: 1614 SQLSTATE: XA102 ([ER\\_XA\\_RBDEADLOCK](#))
- Message: XA\_RBDEADLOCK: Transaction branch was rolled back: deadlock was detected

  - Error: 1615 SQLSTATE: HY000 ([ER\\_NEED\\_REPREPARE](#))
- Message: Prepared statement needs to be re-prepared

  - Error: 1616 SQLSTATE: HY000 ([ER\\_DELAYED\\_NOT\\_SUPPORTED](#))
- Message: DELAYED option not supported for table '%s'

  - Error: 1617 SQLSTATE: HY000 ([WARN\\_NO\\_MASTER\\_INFO](#))
- Message: The master info structure does not exist

  - Error: 1618 SQLSTATE: HY000 ([WARN\\_OPTION\\_IGNORED](#))

Message: <%s> option ignored

- Error: 1619 SQLSTATE: HY000 ([WARN\\_PLUGIN\\_DELETE\\_BUILTIN](#))

Message: Built-in plugins cannot be deleted

- Error: 1620 SQLSTATE: HY000 ([WARN\\_PLUGIN\\_BUSY](#))

Message: Plugin is busy and will be uninstalled on shutdown

- Error: 1621 SQLSTATE: HY000 ([ER\\_VARIABLE\\_IS\\_READONLY](#))

Message: %s variable '%s' is read-only. Use SET %s to assign the value

- Error: 1622 SQLSTATE: HY000 ([ER\\_WARN\\_ENGINE\\_TRANSACTION\\_ROLLBACK](#))

Message: Storage engine %s does not support rollback for this statement. Transaction rolled back and must be restarted

- Error: 1623 SQLSTATE: HY000 ([ER\\_SLAVE\\_HEARTBEAT\\_FAILURE](#))

Message: Unexpected master's heartbeat data: %s

- Error: 1624 SQLSTATE: HY000 ([ER\\_SLAVE\\_HEARTBEAT\\_VALUE\\_OUT\\_OF\\_RANGE](#))

Message: The requested value for the heartbeat period %s %s

- Error: 1625 SQLSTATE: HY000 ([ER\\_NDB\\_REPLICATION\\_SCHEMA\\_ERROR](#))

Message: Bad schema for mysql.ndb\_replication table. Message: %s

- Error: 1626 SQLSTATE: HY000 ([ER\\_CONFLICT\\_FN\\_PARSE\\_ERROR](#))

Message: Error in parsing conflict function. Message: %s

- Error: 1627 SQLSTATE: HY000 ([ER\\_EXCEPTIONS\\_WRITE\\_ERROR](#))

Message: Write to exceptions table failed. Message: %s"

- Error: 1628 SQLSTATE: HY000 ([ER\\_TOO\\_LONG\\_TABLE\\_COMMENT](#))

Message: Comment for table '%s' is too long (max = %lu)

- Error: 1629 SQLSTATE: HY000 ([ER\\_TOO\\_LONG\\_FIELD\\_COMMENT](#))

Message: Comment for field '%s' is too long (max = %lu)

## B.4. Client Error Codes and Messages

Client error information comes from the following source files:

- The Error values and the symbols in parentheses correspond to definitions in the `include/errmsg.h` MySQL source file.
- The Message values correspond to the error messages that are listed in the `libmysql/errmsg.c` file. `%d` and `%s` represent numbers and strings, respectively, that are substituted into the messages when they are displayed.

Because updates are frequent, it is possible that those files will contain additional error information not listed here.

- Error: 2000 ([CR\\_UNKNOWN\\_ERROR](#))

Message: Unknown MySQL error

- Error: 2001 ([CR\\_SOCKET\\_CREATE\\_ERROR](#))

Message: Can't create UNIX socket (%d)

- Error: 2002 ([CR\\_CONNECTION\\_ERROR](#))

- Message: Can't connect to local MySQL server through socket '%s' (%d)
- Error: 2003 (CR\_CONN\_HOST\_ERROR)  
Message: Can't connect to MySQL server on '%s' (%d)
- Error: 2004 (CR\_IPSOCK\_ERROR)  
Message: Can't create TCP/IP socket (%d)
- Error: 2005 (CR\_UNKNOWN\_HOST)  
Message: Unknown MySQL server host '%s' (%d)
- Error: 2006 (CR\_SERVER\_GONE\_ERROR)  
Message: MySQL server has gone away
- Error: 2007 (CR\_VERSION\_ERROR)  
Message: Protocol mismatch; server version = %d, client version = %d
- Error: 2008 (CR\_OUT\_OF\_MEMORY)  
Message: MySQL client ran out of memory
- Error: 2009 (CR\_WRONG\_HOST\_INFO)  
Message: Wrong host info
- Error: 2010 (CR\_LOCALHOST\_CONNECTION)  
Message: Localhost via UNIX socket
- Error: 2011 (CR\_TCP\_CONNECTION)  
Message: %s via TCP/IP
- Error: 2012 (CR\_SERVER\_HANDSHAKE\_ERR)  
Message: Error in server handshake
- Error: 2013 (CR\_SERVER\_LOST)  
Message: Lost connection to MySQL server during query
- Error: 2014 (CR\_COMMANDS\_OUT\_OF\_SYNC)  
Message: Commands out of sync; you can't run this command now
- Error: 2015 (CR\_NAMEDPIPE\_CONNECTION)  
Message: Named pipe: %s
- Error: 2016 (CR\_NAMEDPIPEWAIT\_ERROR)  
Message: Can't wait for named pipe to host: %s pipe: %s (%lu)
- Error: 2017 (CR\_NAMEDPIPEOPEN\_ERROR)  
Message: Can't open named pipe to host: %s pipe: %s (%lu)
- Error: 2018 (CR\_NAMEDPIPESETSTATE\_ERROR)  
Message: Can't set state of named pipe to host: %s pipe: %s (%lu)
- Error: 2019 (CR\_CANT\_READ\_CHARSET)  
Message: Can't initialize character set %s (path: %s)
- Error: 2020 (CR\_NET\_PACKET\_TOO\_LARGE)

Message: Got packet bigger than 'max\_allowed\_packet' bytes

- Error: 2021 (CR\_EMBEDDED\_CONNECTION)

Message: Embedded server

- Error: 2022 (CR\_PROBE\_SLAVE\_STATUS)

Message: Error on SHOW SLAVE STATUS:

- Error: 2023 (CR\_PROBE\_SLAVE\_HOSTS)

Message: Error on SHOW SLAVE HOSTS:

- Error: 2024 (CR\_PROBE\_SLAVE\_CONNECT)

Message: Error connecting to slave:

- Error: 2025 (CR\_PROBE\_MASTER\_CONNECT)

Message: Error connecting to master:

- Error: 2026 (CR\_SSL\_CONNECTION\_ERROR)

Message: SSL connection error

- Error: 2027 (CR\_MALFORMED\_PACKET)

Message: Malformed packet

- Error: 2028 (CR\_WRONG\_LICENSE)

Message: This client library is licensed only for use with MySQL servers having '%s' license

- Error: 2029 (CR\_NULL\_POINTER)

Message: Invalid use of null pointer

- Error: 2030 (CR\_NO\_PREPARE\_STMT)

Message: Statement not prepared

- Error: 2031 (CR\_PARAMS\_NOT\_BOUND)

Message: No data supplied for parameters in prepared statement

- Error: 2032 (CR\_DATA\_TRUNCATED)

Message: Data truncated

- Error: 2033 (CR\_NO\_PARAMETERS\_EXISTS)

Message: No parameters exist in the statement

- Error: 2034 (CR\_INVALID\_PARAMETER\_NO)

Message: Invalid parameter number

- Error: 2035 (CR\_INVALID\_BUFFER\_USE)

Message: Can't send long data for non-string/non-binary data types (parameter: %d)

- Error: 2036 (CR\_UNSUPPORTED\_PARAM\_TYPE)

Message: Using unsupported buffer type: %d (parameter: %d)

- Error: 2037 (CR\_SHARED\_MEMORY\_CONNECTION)

Message: Shared memory: %s

- Error: 2038 (CR\_SHARED\_MEMORY\_CONNECT\_REQUEST\_ERROR)



- Message: Can't open shared memory; client could not create request event (%lu)
- Error: 2039 (CR\_SHARED\_MEMORY\_CONNECT\_ANSWER\_ERROR)  
Message: Can't open shared memory; no answer event received from server (%lu)
- Error: 2040 (CR\_SHARED\_MEMORY\_CONNECT\_FILE\_MAP\_ERROR)  
Message: Can't open shared memory; server could not allocate file mapping (%lu)
- Error: 2041 (CR\_SHARED\_MEMORY\_CONNECT\_MAP\_ERROR)  
Message: Can't open shared memory; server could not get pointer to file mapping (%lu)
- Error: 2042 (CR\_SHARED\_MEMORY\_FILE\_MAP\_ERROR)  
Message: Can't open shared memory; client could not allocate file mapping (%lu)
- Error: 2043 (CR\_SHARED\_MEMORY\_MAP\_ERROR)  
Message: Can't open shared memory; client could not get pointer to file mapping (%lu)
- Error: 2044 (CR\_SHARED\_MEMORY\_EVENT\_ERROR)  
Message: Can't open shared memory; client could not create %s event (%lu)
- Error: 2045 (CR\_SHARED\_MEMORY\_CONNECT\_ABANDONED\_ERROR)  
Message: Can't open shared memory; no answer from server (%lu)
- Error: 2046 (CR\_SHARED\_MEMORY\_CONNECT\_SET\_ERROR)  
Message: Can't open shared memory; cannot send request event to server (%lu)
- Error: 2047 (CR\_CONN\_UNKNOW\_PROTOCOL)  
Message: Wrong or unknown protocol
- Error: 2048 (CR\_INVALID\_CONN\_HANDLE)  
Message: Invalid connection handle
- Error: 2049 (CR\_SECURE\_AUTH)  
Message: Connection using old (pre-4.1.1) authentication protocol refused (client option 'secure\_auth' enabled)
- Error: 2050 (CR\_FETCH\_CANCELED)  
Message: Row retrieval was canceled by mysql\_stmt\_close() call
- Error: 2051 (CR\_NO\_DATA)  
Message: Attempt to read column without prior row fetch
- Error: 2052 (CR\_NO\_STMT\_METADATA)  
Message: Prepared statement contains no metadata
- Error: 2053 (CR\_NO\_RESULT\_SET)  
Message: Attempt to read a row while there is no result set associated with the statement
- Error: 2054 (CR\_NOT\_IMPLEMENTED)  
Message: This feature is not implemented yet
- Error: 2055 (CR\_SERVER\_LOST\_EXTENDED)  
Message: Lost connection to MySQL server at '%s', system error: %d
- Error: 2056 (CR\_STMT\_CLOSED)

Message: Statement closed indirectly because of a preceding %s() call

- Error: 2057 (CR\_NEW\_STMT\_METADATA)

Message: The number of columns in the result set differs from the number of bound buffers. You must reset the statement, rebind the result set columns, and execute the statement again

---

## Appendix C. MySQL Change History

This appendix lists the changes from version to version in the MySQL source code through the latest version of MySQL 5.1, which is currently MySQL 5.1.32. Starting with MySQL 5.0, we began offering a new version of the Manual for each new series of MySQL releases (5.0, 5.1, and so on). For information about changes in previous release series of the MySQL database software, see the corresponding version of this Manual. For information about legacy versions of the MySQL software through the 4.1 series, see *MySQL 3.23, 4.0, 4.1 Reference Manual*.

We update this section as we add new features in the 5.1 series, so that everybody can follow the development process.

Note that we tend to update the manual at the same time we make changes to MySQL. If you find a recent version of MySQL listed here that you can't find on our download page (<http://dev.mysql.com/downloads/>), it means that the version has not yet been released.

The date mentioned with a release version is the date of the last Bazaar ChangeSet on which the release was based, not the date when the packages were made available. The binaries are usually made available a few days after the date of the tagged ChangeSet, because building and testing all packages takes some time.

The manual included in the source and binary distributions may not be fully accurate when it comes to the release changelog entries, because the integration of the manual happens at build time. For the most up-to-date release changelog, please refer to the online version instead.

### C.1. Changes in release 5.1.x-maria (Development)

An overview of which features were added in MySQL 5.1 can be found here: [Section 1.4.1, “What Is New in MySQL 5.1”](#).

For a full list of changes, please refer to the changelog sections for each individual 5.1.x-maria release.

#### C.1.1. Changes in MySQL 5.1.27-maria (Not yet released)

The following changes apply only to builds of MySQL 5.1.27 that include the `MARIA` storage engine.

Functionality added or changed:

- **Important Note:** When MySQL is built with the `Maria` engine, all internal temporary on disk tables will use the `Maria` engine. Using `Maria` temporary tables in place of `MyISAM` tables should result in a performance gain.

#### C.1.2. Changes in MySQL 5.1.26-maria (Not yet released)

The following changes apply only to builds of MySQL 5.1.26 that include the `MARIA` storage engine.

#### C.1.3. Changes in MySQL 5.1.25-maria (Not yet released)

The following changes apply only to builds of MySQL 5.1.25 that include the `MARIA` storage engine.

Functionality added or changed:

- **Important Note:** The behavior of `CHECKSUM TABLE` has been modified so that the checksum operates consistently within all engines by default, unless you use the `--old` option.

If you run `mysqld --old` option, then:

- If table is `MyISAM` with an old-style checksum (5.0), then `CHECKSUM TABLE` returns the 5.0 checksum.
- If the `QUICK` option is specified to `CHECKSUM TABLE`, `NULL` is returned instead.
- When the `EXTENDED` option is specified, the checksum is calculated by looping over all the rows and calculates the checksum using the 5.0 algorithm.

If you run `mysqld` without the `--old` option, then:

- If the table is `MyISAM` with the new-style live checksum (5.1), then the live checksum is returned.
- If the `QUICK` option to `OPTIMIZE TABLE`, `NULL` is returned.

- When the `EXTENDED` option is specified, the checksum is calculated by looping over all the rows and calculating the checksum using the 5.1 algorithm.

In addition, if you run `CHECKSUM TABLE` on `MyISAM` tables with `VARCHAR` columns, using `ROW_FORMAT=fixed` and row-level checksums enabled, then a warning will be raised that the table must be repaired using `REPAIR TABLE` to build the new checksum.

To ensure that tables moved from a MySQL 5.1 environment to MySQL 5.1-maria, or MySQL 6.0 environment, you should run `mysqld` with the `--old` and run `CHECKSUM TABLE ... EXTENDED` to compare using the 5.0 algorithm.

## C.1.4. Changes in MySQL 5.1.24-maria (Not yet released)

The following changes apply only to builds of MySQL 5.1.24 that include the `MARIA` storage engine.

Bugs fixed:

- When creating tables not using the `Maria` engine, it would be possible to create a table using the `TRANSACTIONAL` option, even though this option is not supported by non-`Maria` tables. A warning will now be produced when using these options, but the option will still be recorded within the options for the table to allow for correct modification during `ALTER TABLE` operations. ([Bug#34395](#))

## C.2. Changes in release 5.1.x (Production)

An overview of which features were added in MySQL 5.1 can be found here: [Section 1.4.1, “What Is New in MySQL 5.1”](#).

For a full list of changes, please refer to the changelog sections for each individual 5.1.x release.

For changes relating to MySQL Cluster NDB 6.x, see [Changes in MySQL Cluster NDB 6.X](#) and [7.X](#).

### C.2.1. Changes in MySQL 5.1.36 (Not yet released)

Functionality added or changed:

- **Important Change: Replication:** Previously, incident log events were represented as comments in the output from `mysqlbinlog`, making them effectively silent when playing back the binlog.

(An incident log event represents an incident that could cause the contents of the database to change without that event being recorded in the binary log.)

This meant that, if the SQL were applied to a server, it could potentially lead to the master and the slave having different data. To make it possible to handle incident log events without breaking applications that expect the previous behavior, the nonsense statement `RELOAD DATABASE` is added to the SQL output for that incident log event, which causes an error.

To use this functionality currently requires hand editing of the dump file and handling of each case on an individual basis by a database administrator before applying the output to a server. ([Bug#44442](#))

- The time zone tables for Windows available at [timezones.html](#) have been updated. ([Bug#39923](#))

Bugs fixed:

- **Replication:** When using row-based logging, the length of an event for which the field metadata exceeded 255 bytes in size was incorrectly calculated. This could lead to corruption of the binary log, or cause the server to hang. ([Bug#42749](#))

See also [Bug#44548](#), [Bug#44672](#), [Bug#44752](#).

- **Replication:** The warning `STATEMENT IS NOT SAFE TO LOG IN STATEMENT FORMAT`, issued in situations when it cannot be determined that a statement or other database event can be written reliably to the binary log using the statement-based format, has been changed to `STATEMENT MAY NOT BE SAFE TO LOG IN STATEMENT FORMAT`. ([Bug#42415](#))
- **Replication:** When stopping and restarting the slave while it was replicating temporary tables, the slave server could crash or raise an assertion failure. This was due to the fact that, although temporary tables were saved between slave thread restarts, the reference to the thread being used (`table->in_use`) was not being properly updated when restarting, continuing to reference the old thread instead of the new one. This issue affected statement-based replication only. ([Bug#41725](#))

- `ALTER TABLE` on a view crashed the server. (Bug#44860)
- `UNCOMPRESSED_LENGTH()` returned a garbage result when passed a string shorter than 5 bytes. Now `UNCOMPRESSED_LENGTH()` returns `NULL` and generates a warning. (Bug#44796)
- Several Valgrind warnings were silenced. (Bug#44774, Bug#44792)
- Selecting `RAND(N)` function where `N` is a column of a `constant` table (table with a single row) failed with a `SIGFPE` signal. (Bug#44768)
- Conversion of a string to a different character set could use the same buffer for input and output, leading to incorrect results or warnings. (Bug#44743, Bug#44766)
- `mysqld_safe` could fail to find the `logger` program. (Bug#44736)
- A Valgrind warning related to transaction processing was silenced. (Bug#44664)
- `innochecksum` could incorrectly determine the input file name from the arguments. (Bug#44484)
- Incorrect time was reported at the end of `mysqldump` output. (Bug#44424)
- Caching of `GROUP BY` expressions could lead to mismatches between compile-time and runtime calculations and cause a server crash. (Bug#44399)
- Lettercase conversion in multibyte `cp932` or `sjis` character sequences could produce incorrect results. (Bug#44352)
- `InnoDB` was missing `DB_ROLL_PTR` information in Table Monitor `COLUMNS` output. (Bug#44320)
- Assertion failure could occur for duplicate-key errors in `INSERT INTO ... SELECT` statements. (Bug#44306)
- On 64-bit Windows systems, `myisamchk` did not handle `key_buffer_size` values larger than 4GB. (Bug#43940)
- `EXPLAIN EXTENDED` could crash for `UNION` queries in which the last `SELECT` was not parenthesized and included an `ORDER BY` clause. (Bug#43612)
- Multiple-table updates for `InnoDB` tables could produce incorrect results. (Bug#43580)
- For `DELETE` statements with `ORDER BY var`, where `var` was a global system variable with a `NULL` value, the server could crash. (Bug#42778)
- Builds linked against OpenSSL had a memory leak in association with use of X509 certificates. (Bug#42158)
- There was a race condition when changing `innodb_commit_concurrency` at runtime from zero to nonzero or from nonzero to zero. Now this variable cannot be changed at runtime from zero to nonzero or vice versa. The value can still be changed from one nonzero value to another. (Bug#42101)
- `SELECT ... INTO @var` could produce values different from `SELECT ...` without the `INTO` clause. (Bug#42009)
- `mysql_zap` did not work on Mac OS X. (Bug#41883)
- For views created with a column list clause, column aliases were not substituted when selecting through the view using a `HAVING` clause. (Bug#40825)
- A multiple-table `DELETE` involving a table self-join could cause a server crash. (Bug#39918)
- Creating an `InnoDB` table with a comment containing a '#' character caused foreign key constraints to be omitted. (Bug#39793)
- The `mysql` option `--ignore-spaces` was non-functional. (Bug#39101)
- If a query was such as to produce the error `1054 Unknown column '...' in 'field list'`, using `EXPLAIN EXTENDED` with the query could cause a server crash. (Bug#37362)
- If the `MYSQL_HISTFILE` environment variable was set to `/dev/null`, the `mysql` client overwrote the `/dev/null` device file as a normal file. (Bug#34224)
- `mysqld_safe` mishandled certain parameters if they contained spaces. (Bug#33685)
- `mysqladmin kill` did not work for thread IDs larger than 32 bits. (Bug#32457)
- Several client programs failed to interpret `--skip-password` as “send no password.” (Bug#28479)

- Output from `mysql --html` did not encode the `<`, `>`, or `&` characters. (Bug#27884)
- `mysql_convert_table_format` did not prevent converting tables to `MEMORY` or `BLACKHOLE` tables, which could result in data loss. (Bug#27149)

## C.2.2. Changes in MySQL 5.1.35 (Not yet released)

Bugs fixed:

- **Important Change: Replication:** The transactional behavior of `STOP SLAVE` has changed. Formerly, it took effect immediately, even inside a transaction; now, it waits until the current replication event group (if any) has finished executing, or until the user issues a `KILL QUERY` or `KILL CONNECTION` statement.

This was done in order to solve the problem encountered when replication was stopped while a non-transactional slave was replicating a transaction on the master. (It was impossible to roll back a mixed-engines transaction when one of the engines was non-transactional, which meant that the slave could not safely re-apply any transaction that had been interrupted by `STOP SLAVE`.) (Bug#319, Bug#38205)

See also Bug#43217.

- **Partitioning:** When a value was equal to a `PARTITION ... VALUES LESS THAN (value)` value other than `MAX-VALUE`, the corresponding partition was not pruned. (Bug#42944)
- **Replication:** Unrelated errors occurring during the execution of `RESET SLAVE` could cause the slave to crash. (Bug#44179)
- **Replication:** The `--slave-skip-errors` option had no effect when using row-based logging format. (Bug#39393)
- **Replication:** The following errors were not correctly reported:
  - Failures during slave thread initialization
  - Failures while initializing the relay log position (immediately following the starting of the slave thread)
  - Failures while processing queries passed through the `--init_slave` option.

Information about these types of failures can now be found in the output of `SHOW SLAVE STATUS`. (Bug#38197)

- **Replication:** Killing the thread executing a DDL statement, after it had finished its execution but before it had written the binlog event, caused the error code in the binlog event to be set (incorrectly) to `ER_SERVER_SHUTDOWN` or `ER_QUERY_INTERRUPTED`, which caused replication to fail. (Bug#37145)

See also Bug#27571, Bug#22725.

- **Replication:** Column aliases used inside subqueries were ignored in the binary log. (Bug#35515)
- Valgrind warnings for the `DECODE()`, `ENCRYPT()`, and `FIND_IN_SET()` functions were corrected. (Bug#44358, Bug#44365, Bug#44367)
- On Windows, entries for `build-vs9.bat` and `build-vs9_x64.bat` were missing in `win/Makefile.am`. (Bug#44353)
- Incomplete cleanup of `JOIN_TAB::select` during the filesort of rows for a `GROUP BY` clause inside a subquery caused a server crash. (Bug#44290)
- Not all lock types had proper descriptive strings, resulting in garbage output from `mysqladmin debug`. (Bug#44164)
- Use of `HANDLER` statements with `INFORMATION_SCHEMA` tables caused a server crash. Now `HANDLER` is prohibited with such tables. (Bug#44151)
- Invoking `SHOW TABLE STATUS` from within a stored procedure could cause a `Packets out of order` error. (Bug#43962)
- `myisamchk` could display a negative `Max keyfile length` value. (Bug#43950)
- On 64-bit systems, a `key_buffer_size` value larger than 4GB could cause MyISAM index corruption. (Bug#43932)
- `mysqld_multi` incorrectly passed `--no-defaults` to `mysqld_safe`. (Bug#43876)
- `SHOW VARIABLES` did not properly display the value of `slave_skip_errors`. (Bug#43835)

- On Windows, a server crash occurred for attempts to insert a floating-point value into a `CHAR` column with a maximum length less than the converted floating-point value length. (Bug#43833)
- Incorrect initialization of `MyISAM` table indexes could cause incorrect query results. (Bug#43737)
- `libmysqld` crashed when it was reinitialized. (Bug#43706, Bug#44091)
- `InnoDB` uses random numbers to generate dives into indexes for calculating index cardinality. However, under certain conditions, the algorithm did not generate random numbers, so `ANALYZE TABLE` did not update cardinality estimates properly. A new algorithm has been introduced with better randomization properties, together with a system variable, `innodb_use_legacy_cardinality_algorithm`, that controls which algorithm to use. The default value of the variable is 1 (`ON`), to use the original algorithm for compatibility with existing applications. The variable can be set to 0 (`OFF`) to use the new algorithm with improved randomness. (Bug#43660)
- `UNION` of floating-point numbers did unnecessary rounding. (Bug#43432)
- `ALTER DATABASE ... UPGRADE DATA DIRECTORY NAME` failed when the database contained views. (Bug#43385)
- Certain statements might open a table and then wait for an impending global read lock without noticing whether they hold a table being waiting for by the global read lock, causing a hang. Affected statements are `SELECT ... FOR UPDATE`, `LOCK TABLES ... WRITE`, `TRUNCATE TABLE`, and `LOAD DATA INFILE`. (Bug#43230)
- Using an XML function such as `ExtractValue()` more than once in a single query could produce erroneous results. (Bug#43183)  
See also Bug#43937.
- Full-text prefix searches could hang the connection and cause 100% CPU consumption. (Bug#42907)
- `InnoDB` had excessive contention for a character set mutex. (Bug#42649)
- Incorrect elevation of warning messages to error messages for unsafe statements caused a server crash. (Bug#42640)
- `CHECK TABLE` suggested use of `REPAIR TABLE` for corrupt tables for storage engines not supported by `REPAIR TABLE`. Now `CHECK TABLE` suggests that the user dump and reload the table. (Bug#42563)
- Compressing a table with the `mysampack` utility caused the server to produce Valgrind warnings when it opened the table. (Bug#41541)
- For a `MyISAM` table with `DELAY_KEY_WRITE` enabled, the index file could be corrupted without the table being marked as crashed if the server was killed. (Bug#41330)
- Killing an `INSERT ... SELECT` statement for a `MyISAM` table could cause table corruption if the table had indexes. (Bug#40827)
- A multiple-table `DELETE IGNORE` statement involving a foreign key constraint caused an assertion failure. (Bug#40127)
- Multiple-table `UPDATE` statements did not properly activate triggers. (Bug#39953)
- The `mysql_setpermission` operation for removing database privileges removed global privileges instead. (Bug#39852)
- A stored routine contain a C-style comment could not be dumped and reloaded. (Bug#39559)
- In an `UPDATE` or `DELETE` via a secondary index, `InnoDB` did not store the cursor position. This made `InnoDB` crash in semi-consistent read while attempting to unlock a non-matching record. (Bug#39320)
- The functions listed in Section 11.13.4.2.3, “Creating Geometry Values Using MySQL-Specific Functions”, previously accepted WKB arguments and returned WKB values. They now accept WKB or geometry arguments and return geometry values.  
The functions listed in Section 11.13.4.2.2, “Creating Geometry Values Using WKB Functions”, previously accepted WKB arguments and returned geometry values. They now accept WKB or geometry arguments and return geometry values. (Bug#38990)
- On Windows, running the server with `mysam_use_mmap` enabled caused `MyISAM` table corruption. (Bug#38848)
- `CHECK TABLE` did not properly check whether `MyISAM` tables created by servers from MySQL 4.0 or older needed to be upgraded. This could cause problems upgrading to MySQL 5.1 or higher. (Bug#37631)
- An `UPDATE` statement that updated a column using the same `DES_ENCRYPT()` value for each row actually updated different rows with different values. (Bug#35087)

- For shared-memory connections, the read and write methods did not properly handle asynchronous close events, which could lead to the client locking up waiting for a server response. For example, a call to `mysql_real_query()` would block forever on the client side if the executed statement was aborted on the server side. Thanks to Armin Schöffmann for the bug report and patch. (Bug#33899)
- `CHECKSUM TABLE` was not killable with `KILL QUERY`. (Bug#33146)
- `myisamchk` and `myisampack` were not being linked with the library that enabled support for `*` filename pattern expansion. (Bug#29248)
- For InnoDB tables that have their own `.ibd` tablespace file, a superfluous `ibuf cursor restoration fails!` message could be written to the error log. This warning has been suppressed. (Bug#27276)
- `COMMIT` did not delete savepoints if there were no changes in the transaction. (Bug#26288)
- Several memory allocation functions were not being checked for out-of-memory return values. (Bug#25058)

### C.2.3. Changes in MySQL 5.1.34 (02 April 2009)

Support Ending for AIX 5.2: Per the [MySQL Support Lifecycle policy](#) regarding ending support for OS versions that have reached vendor end of life, we plan to discontinue building or supporting MySQL binaries for AIX 5.2 as of April 30, 2009. This release of MySQL 5.1 (5.1.34) is the last MySQL 5.1 release with support for AIX 5.2. For more information, see the March 24, 2009 note at [MySQL Product Support EOL Announcements](#).

Functionality added or changed:

- The `optimizer_switch` system variable is now available to control optimizations that can be switched on and off. See [Section 7.2.18, “Using optimizer\\_switch to Control the Optimizer”](#).

Bugs fixed:

- **Replication: Important Note:** Binary logging with `--binlog_format=ROW` failed when a change to be logged included more than 251 columns. This issue was not known to occur with mixed-format or statement-based logging. (Bug#42977)

See also [Bug#42914](#).

- **Replication:** Assigning an invalid directory for the `--slave-load-tmpdir` caused the replication slave to crash. (Bug#42861)
- **Replication:** The `mysql.procs_priv` system table was not replicated. (Bug#42217)
- **Replication:** An `INSERT DELAYED` into a `TIMESTAMP` column issued concurrently with an insert on the same column not using `DELAYED`, but applied after the other insert, was logged using the same timestamp as generated by the other (non-`DELAYED`) insert. (Bug#41719)
- **Replication:** The `MIXED` binary logging format did not switch to row-based mode for statements containing the `LOAD_FILE()` function. (Bug#39701)
- **Replication:** When the server SQL mode included `IGNORE_SPACE`, statement-based replication of `LOAD DATA INFILE ... INTO tbl_name` failed because the statement was read incorrectly from the binary log; a trailing space was omitted, causing the statement to fail with a syntax error when run on the slave. (Bug#22504)

See also [Bug#43746](#).

- An attempt by a user who did not have the `SUPER` privilege to kill a system thread could cause a server crash. (Bug#43748)
- On Windows, incorrectly specified link dependencies in `CMakeLists.txt` resulted in link errors for `mysql_embedded`, `mysqltest_embedded`, and `mysql_client_test_embedded`. (Bug#43715)
- `mysql` crashed if a request for the current database name returned an empty result, such as after the client has executed a preceding `SET sql_select_limit=0` statement. (Bug#43254)
- If the value of the `version_comment` system variable was too long, the `mysql` client displayed a truncated startup message. (Bug#43153)
- Queries of the following form returned an empty result:



```
SELECT ... WHERE ... (col=col AND col=col) OR ... (false expression)
```

(Bug#42957)

- The `strings/CHARSET_INFO.txt` file was not included in source distributions. (Bug#42937)
- A dangling pointer in `mysys/my_error.c` could lead to client crashes. (Bug#42675)
- Passing an unknown time zone specification to `CONVERT_TZ()` resulted in a memory leak. (Bug#42502)
- With more than two arguments, `LEAST()`, `GREATEST()`, and `CASE` could unnecessarily return `Illegal mix of collations` errors. (Bug#41627)
- The `mysql` client could misinterpret its input if a line was longer than an internal buffer. (Bug#41486)
- In the `help` command output displayed by `mysql`, the description for the `\c (clear)` command was misleading. (Bug#41268)
- The `load_defaults()`, `my_search_option_files()` and `my_print_default_files()` functions in the C client library were subject to a race condition in multi-threaded operation. (Bug#40552)
- If `--basedir` was specified, `mysqld_safe` did not use it when attempting to locate `my_print_defaults`. (Bug#39326)
- When MySQL was configured with the `--with-max-indexes=128` option, `mysqld` crashed. (Bug#36751)
- Setting the `join_buffer_size` variable to its minimum value produced spurious warnings. (Bug#36446)
- The use of `NAME_CONST()` can result in a problem for `CREATE TABLE ... SELECT` statements when the source column expressions refer to local variables. Converting these references to `NAME_CONST()` expressions can result in column names that are different on the master and slave servers, or names that are too long to be legal column identifiers. A workaround is to supply aliases for columns that refer to local variables.

Now a warning is issued in such cases that indicate possible problems. (Bug#35383)

- An attempt to check or repair an ARCHIVE table that had been subjected to a server crash returned a 144 internal error. The data appeared to be irrecoverable. (Bug#32880)
- The `Time` column for `SHOW PROCESSLIST` output and the value of the `TIME` column of the `INFORMATION_SCHEMA.PROCESSLIST` table now can have negative values. Previously, the column was unsigned and negative values were displayed incorrectly as large positive values. Negative values can occur if a thread alters the time into the future with `SET TIMESTAMP = value` or the thread is executing on a slave and processing events from a master that has its clock set ahead of the slave. (Bug#22047)
- Restoring a `mysqldump` dump file containing `FEDERATED` tables failed because the file contained the data for the table. Now only the table definition is dumped (because the data is located elsewhere). (Bug#21360)

## C.2.4. Changes in MySQL 5.1.33 (13 March 2009)

Support Ending for AIX 5.2: Per the [MySQL Support Lifecycle policy](#) regarding ending support for OS versions that have reached vendor end of life, we plan to discontinue building or supporting MySQL binaries for AIX 5.2 as of April 30, 2009. The next release of MySQL 5.1 (5.1.34) will be the last MySQL 5.1 release with support for AIX 5.2. For more information, see the March 24, 2009 note at [MySQL Product Support EOL Announcements](#).

Functionality added or changed:

- `mysql-test-run.pl` now supports an `--experimental=file_name` option. It enables you to specify a file that contains a list of test cases that should be displayed with the `[ exp-fail ]` code rather than `[ fail ]` if they fail. (Bug#42888)
- The MD5 algorithm now uses the Xfree implementation. (Bug#42434)
- The query cache now checks whether a `SELECT` statement begins with `SQL_NO_CACHE` to determine whether it can skip checking for the query result in the query cache. This is not supported when `SQL_NO_CACHE` occurs within a comment. (Bug#37416)

Bugs fixed:

- **Partitioning:** A duplicate key error raised when inserting into a partitioned table used a different error code from that returned by such an error raised when inserting into a table that was not partitioned. (Bug#38719)

See also [Bug#28842](#).

- **Partitioning:** Several error messages relating to partitioned tables were incorrect or missing. (Bug#36001)
- **Replication:** When `--binlog_format` was set to `STATEMENT`, a statement unsafe for statement-based logging caused an error or warning to be issued even if `sql_log_bin` was set to 0. (Bug#41980)
- **Replication:** When using `MIXED` replication format and temporary tables were created in statement-based mode, but a later operation in the same session caused a switch to row-based mode, the temporary tables were not dropped on the slave at the end of the session. (Bug#40013)

See also [Bug#43046](#).

This regression was introduced by [Bug#20499](#).

- **Replication:** When using the `MIXED` replication format, `UPDATE` and `DELETE` statements that searched for rows where part of the key had nullable `BIT` columns failed. This occurred because operations that inserted the data were replicated as statements, but `UPDATE` and `DELETE` statements affecting the same data were replicated using row-based format.

This issue did not occur when using statement-based replication (only) or row-based replication (only). (Bug#39753)

See also [Bug#39648](#).

- **Replication:** The server SQL mode in effect when a stored procedure was created was not retained in the binary log. This could cause a `CREATE PROCEDURE` statement that succeeded on the master to fail on the slave.

This issue was first noticed when a stored procedure was created when `ANSI_QUOTES` was in effect on the master, but could possibly cause failed `CREATE PROCEDURE` statements and other problems on the slave when using other server SQL modes as well. (Bug#39526)

- **Replication:** If `--secure-file-priv` was set on the slave, it was unable to execute `LOAD DATA INFILE` statements sent from the master when using mixed-format or statement-based replication.

As a result of this fix, this security restriction is now ignored on the slave in such cases; instead the slave checks whether the files were created and should be read by the slave in its `--slave-load-tmpdir`. (Bug#38174)

- **Replication:** Server IDs greater than 2147483647 ( $2^{32} - 1$ ) were represented by negative numbers in the binary log. (Bug#37313)
- **Replication:** When its disk becomes full, a replication slave may wait while writing the binary log, relay log or `MyISAM` tables, continuing after space has been made available. The error message provided in such cases was not clear about the frequency with which checking for free space is done (once every 60 seconds), and how long the server waits after space has been freed before continuing (also 60 seconds); this caused users to think that the server had hung.

These issues have been addressed by making the error message clearer, and dividing it into two separate messages:

1. The error message `DISK IS FULL WRITING 'FILENAME' (ERRCODE: ERROR_CODE). WAITING FOR SOMEONE TO FREE SPACE...` (EXPECT UP TO 60 SECS DELAY FOR SERVER TO CONTINUE AFTER FREEING DISK SPACE) is printed only once.
2. The warning `RETRY IN 60 SECS, MESSAGE REPRINTED IN 600 SECS` is printed once every for every 10 times that the check for free space is made; that is, the check is performed once each 60 seconds, but the reminder that space needs to be freed is printed only once every 10 minutes (600 seconds).

(Bug#22082)

- **Replication:** The statements `DROP PROCEDURE IF EXISTS` and `DROP FUNCTION IF EXISTS` were not written to the binary log if the procedure or function to be dropped did not exist. (Bug#13684)

See also [Bug#25705](#).

- The IBM DB2i storage engine has been added to this release for the IBM i Series platform. For more information, see [The IBM-MDB2I Storage Engine](#). (Bug#44217)
- On 64-bit debug builds, code in `safemalloc` resulted in errors due to use of a 32-bit value for 64-bit allocations.

)

- `make distcheck` failed to properly handle subdirectories of `storage/ndb`. (Bug#43614)
- Use of `USE INDEX` hints could cause `EXPLAIN EXTENDED` to crash. (Bug#43354)
- For `InnoDB` tables, overflow in an `AUTO_INCREMENT` column could cause a server crash. (Bug#43203)
- On 32-bit Windows, `mysqld` could not use large buffers due to a 2GB user mode address limit. (Bug#43082)
- `stderr` should be unbuffered, but when the server redirected `stderr` to a file, it became buffered. (Bug#42790)
- The `DATA_TYPE` column of the `INFORMATION_SCHEMA.COLUMNS` table displayed the `UNSIGNED` attribute for floating-point data types. (The column should contain only the data type name.) (Bug#42758)
- For `InnoDB` tables, spurious duplicate-key errors could occur when inserting into an `AUTO_INCREMENT` column. (Bug#42714)
- `mysqldump` included views that were excluded with the `--ignore-table` option. (Bug#42635)
- An earlier bug fix resulted in the problem that the `InnoDB` plugin could not be used with a server that was compiled with the built-in `InnoDB`. To handle this two changes were made:
  - The server now supports an `--ignore-builtin-innodb` option that causes the server to behave as if the built-in `InnoDB` is not present. This option causes other `InnoDB` options not to be recognized.
  - For the `INSTALL PLUGIN` statement, the server reads option (`my.cnf`) files just as during server startup. This enables the plugin to pick up any relevant options from those files. Consequently, a plugin no longer is started with each option set to its default value.

Because of this change, it is possible to add plugin options to an option file even before loading a plugin (if the `loose` prefix is used). It is also possible to uninstall a plugin, edit `my.cnf`, and install the plugin again. Restarting the plugin this way enables it to the new option values without a server restart.

### Note

`InnoDB` Plugin versions 1.0.4 and higher will take advantage of this bug fix. Although the `InnoDB` Plugin is source code compatible with multiple MySQL releases, a given binary `InnoDB` Plugin can be used only with a specific MySQL release. When `InnoDB` Plugin 1.0.4 is released, it is expected to be compiled for MySQL 5.1.34. For 5.1.33, you can use `InnoDB` Plugin 1.0.3, but you must build from source.

(Bug#42610)

This regression was introduced by Bug#29263.

- With the `ONLY_FULL_GROUP_BY` SQL mode enabled, some legal queries failed. (Bug#42567)
- Tables could enter open table cache for a thread without being properly cleaned up, leading to a server crash. (Bug#42419)
- For `InnoDB` tables, inserting into floating-point `AUTO_INCREMENT` columns failed. (Bug#42400)
- The `InnoDB btr_search_drop_page_hash_when_freed()` function had a race condition. (Bug#42279)
- For `InnoDB` tables, there was a race condition for `ALTER TABLE`, `OPTIMIZE TABLE`, `CREATE INDEX`, and `DROP INDEX` operations when periodically checking whether table copying can be committed. (Bug#42152)
- Parsing of the optional microsecond component of `DATETIME` values did not fail gracefully when that component width was larger than the allowed six places. (Bug#42146)
- In `InnoDB` recovery after a server crash, table lookup could fail and corrupt the data dictionary cache. (Bug#42075)
- `mysqldumpslow` parsed the `--debug` and `--verbose` options incorrectly. (Bug#42027)
- Queries that used the loose index scan access method could return no rows. (Bug#41610)
- In `InnoDB` recovery after a server crash, rollback of a transaction that updated a column from `NULL` to `NULL` could cause another crash. (Bug#41571)
- The error message for a too-long column comment was `Unknown error` rather than a more appropriate message. (Bug#41465)

- Use of `SELECT *` allowed users with rights to only some columns of a view to access all columns. (Bug#41354)
- If the tables underlying a `MERGE` table had a primary key but the `MERGE` table itself did not, inserting a duplicate row into the `MERGE` table caused a server crash. (Bug#41305)
- The server did not robustly handle problems hang if a table opened with `HANDLER` needed to be re-opened because it had been altered to use a different storage engine that does not support `HANDLER`. The server also failed to set an error if the re-open attempt failed. These problems could cause the server to crash or hang. (Bug#41110, Bug#41112)
- `SELECT` statements executed concurrently with `INSERT` statements for a `MyISAM` table could cause incorrect results to be returned from the query cache. (Bug#41098)
- For prepared statements, multibyte character sets were not taking into account when calculating `max_length` for string values and `mysql_stmt_fetch()` could return truncated strings. (Bug#41078)
- Deprecation warnings that referred to MySQL 5.2 were changed to refer to MySQL 6.0. (Bug#41077)
- For user-defined variables in a query result, incorrect length values were returned in the result metadata. (Bug#41030)
- On Windows, starting the server with an invalid value for `innodb_flush_method` caused a crash. (Bug#40757)
- MySQL 5.1 crashed with index merge algorithm and merge tables.  
A query in the `MyISAM` merge table caused a crash if the index merge algorithm was being used. (Bug#40675)
- With strict SQL mode enabled, setting a system variable to an out-of-bounds value caused an assertion failure. (Bug#40657)
- Table temporary scans were slower than necessary due to use of `mmap` rather than caching, even with the `myisam_use_mmap` system variable disabled. (Bug#40634)
- For a view that references a table in another database, `mysqldump` wrote the view name qualified with the current database name. This makes it impossible to reload the dump file into a different database. (Bug#40345)
- On platforms where long and pointer variables have different sizes, `MyISAM` could copy key statistics incorrectly, resulting in a server crash or incorrect cardinality values. (Bug#40321)
- `DELETE` tried to acquire write (not read) locks for tables accessed within a subquery of the `WHERE` clause. (Bug#39843)
- `perror` did not produce correct output for error codes 153 to 163. (Bug#39370)
- Several functions in `libmysqld` called `exit()` when an error occurred rather than returning an error to the caller. (Bug#39289)
- The `innodb_log_arch_dir` system variable is no longer available but was present in some of the sample option files included with MySQL distributions (such as `my-huge.cnf`). The line was present as a comment but uncommenting it would cause server startup failure so the line has been removed. (Bug#38249)
- Setting a savepoint with the same name as an existing savepoint incorrectly deleted any other savepoints that had been set in the meantime. For example, setting savepoints named `a`, `b`, `c`, `b` resulted in savepoints `a`, `b`, rather than the correct savepoints `a`, `c`, `b`. (Bug#38187)
- `--help` output for `myisamchk` did not list the `--HELP` option. (Bug#38103)
- Comparisons between row constructors, such as `(a, b) = (c, d)` resulted in unnecessary `Illegal mix of collations` errors for string columns. (Bug#37601)
- If a user created a view that referenced tables for which the user had disjoint privileges, an assertion failure occurred. (Bug#37191)
- An argument to the `MATCH()` function that was an alias for an expression other than a column name caused a server crash. (Bug#36737)
- The `event`, `general_log`, and `slow_log` tables in the `mysql` database store `server_id` values, but did not use an `UNSIGNED` column and thus were not able to store the full range of ID values. (Bug#36540)
- On Windows, the `_PC` macro in `my_global.h` was causing problems for modern compilers. It has been removed because it is no longer used. (Bug#34309)
- For `DROP FUNCTION` with names that were qualified with a database name, the database name was handled in case-sensitive fashion even with `lower_case_table_names` set to 1. (Bug#33813)

- `mysqldump --compatible=mysql40` emitted statements referring to the `character_set_client` system variable, which is unknown before MySQL 4.1. Now the statements are enclosed in version-specific comments. (Bug#33550)
- Detection by `configure` of several functions such as `setsockopt()`, `bind()`, `sched_yield()`, and `gtty()` could fail. (Bug#31506)
- Use of MBR spatial functions such as `MBRTouches()` with columns of InnoDB tables caused a server crash rather than an error. (Bug#31435)
- The `mysql` client mishandled input parsing if a `delimiter` command was not first on the line. (Bug#31060)
- `SHOW PRIVILEGES` listed the `CREATE ROUTINE` privilege as having a context of `Functions, Procedures`, but it is a database-level privilege. (Bug#30305)
- `mysqld --help` did not work as `root`. (Bug#30261)
- `CHECK TABLE`, `REPAIR TABLE`, `ANALYZE TABLE`, and `OPTIMIZE TABLE` erroneously reported a table to be corrupt if the table did not exist or the statement was terminated with `KILL`. (Bug#29458)
- `SHOW TABLE STATUS` could fail to produce output for tables with non-ASCII characters in their name. (Bug#25830)
- Allocation of stack space for error messages could be too small on HP-UX, leading to stack overflow crashes. (Bug#21476)
- Floating-point numbers could be handled with different numbers of digits depending on whether the text or prepared-statement protocol was used. (Bug#21205)
- Incorrect length metadata could be returned for `LONG TEXT` columns when a multibyte server character set was used. (Bug#19829)
- `ROUND()` sometimes returned different results on different platforms. (Bug#15936)

## C.2.5. Changes in MySQL 5.1.32 (14 February 2009)

Functionality added or changed:

- The `libedit` library was upgraded to version 2.11. (Bug#42433)

Bugs fixed:

- **Security Fix:** Using an XPath expression employing a scalar expression as a `FilterExpr` with `ExtractValue()` or `UpdateXML()` caused the server to crash. Such expressions now cause an error instead. (Bug#42495)
- **Incompatible Change:** The fix for Bug#33699 introduced a change to the `UPDATE` statement such that assigning `NULL` to a `NOT NULL` column caused an error even when strict SQL mode was not enabled. The original behavior before was that such assignments caused an error only in strict SQL mode, and otherwise set the column to the implicit default value for the column data type and generated a warning. (For information about implicit default values, see Section 10.1.4, “Data Type Default Values”.)

The change caused compatibility problems for applications that relied on the original behavior. It also caused replication problems between servers that had the original behavior and those that did not, for applications that assigned `NULL` to `NOT NULL` columns in `UPDATE` statements without strict SQL mode enabled. This change has been reverted so that `UPDATE` again had the original behavior. Problems can still occur if you replicate between servers that have the modified `UPDATE` behavior and those that do not. (Bug#39265)

- **Replication:** `START SLAVE UNTIL` did not work correctly with `--replicate-same-server-id` enabled; when started with this option, the slave did not perform events recorded in the relay log and that originated from a different master.

Log rotation events are automatically generated and written when rotating the binary log or relay log. Such events for relay logs are usually ignored by the slave SQL thread because they have the same server ID as that of the slave. However, when `--replicate-same-server-id` was enabled, the rotation event for the relay log was treated as if it originated on the master, because the log's name and position were incorrectly updated. This caused the `MASTER_POS_WAIT()` function always to return `NULL` and thus to fail. (Bug#38734, Bug#38934)

- **Replication:** `TRUNCATE` statements failed to replicate when statement-based binary logging mode was not available. The issue was observed when using InnoDB with the transaction isolation level set to `READ UNCOMMITTED` (thus forcing InnoDB not to allow statement-based logging). However, the same behavior could be reproduced using any transactional storage engine supporting only row-based logging, regardless of the isolation level. This was due to two separate problems:

1. An error was printed by `InnoDB` for `TRUNCATE` when using statement-based logging mode where the transaction isolation level was set to `READ COMMITTED` or `READ UNCOMMITTED`, because `InnoDB` permits statement-based replication for DML statements. However, `TRUNCATE` is not transactional; since it is the equivalent of `DROP TABLE` followed by `CREATE TABLE`, it is actually DDL, and should therefore be allowed to be replicated as a statement.
2. `TRUNCATE` was not logged in mixed mode because of the error just described; however, this error was not reported to the client.

As a result of this fix, `TRUNCATE` is now treated as DDL for purposes of binary logging and replication; that is, it is always logged as a statement and so no longer causes an error when replicated using a transactional storage engine such as `InnoDB`. (Bug#36763)

See also Bug#42643.

- **Replication:** `mysqlbinlog` replay of `CREATE TEMPORARY TABLE ... LIKE` statements and of `TRUNCATE` statements used on temporary tables failed with Error 1146 (`TABLE ... DOESN'T EXIST`). (Bug#35583)
- **Replication:** In statement mode, `mysqlbinlog` failed to issue a `SET @@autocommit` statement when the autocommit mode was changed. (Bug#34541)
- **Replication:** `LOAD DATA INFILE` statements did not replicate correctly from a master running MySQL 4.1 to a slave running MySQL 5.1 or later. (Bug#31240)
- The use by `libedit` of the `__weak_reference()` macro caused compilation failure on FreeBSD. (Bug#42817)
- A `'%'` character in SQL statements could cause the server to crash. (Bug#42634)
- An optimization introduced for Bug#37553 required an explicit cast to be added for some uses of `TIMEDIFF()` because automatic casting could produce incorrect results. (It was necessary to use `TIME(TIMEDIFF(...))`.) (Bug#42525)
- On the IBM i5 platform, the MySQL configuration process caused the system version of `pthread_setschedprio()` to be used. This function returns `SIGILL` on i5 because it is not supported, causing the server to crash. Now the `my_pthread_setprio()` function in the `mysys` library is used instead. (Bug#42524)
- The SSL certificates included with MySQL distributions were regenerated because the previous ones had expired. (Bug#42366)
- User variables within triggers could cause a crash if the `mysql_change_user()` C API function was invoked. (Bug#42188)
- Dependent subqueries such as the following caused a memory leak proportional to the number of outer rows:

```
SELECT COUNT(*) FROM t1, t2 WHERE t2.b
  IN (SELECT DISTINCT t2.b FROM t2 WHERE t2.b = t1.a);
```

(Bug#42037)

- Some queries using `NAME_CONST(... COLLATE ...)` led to a server crash due to a failed type cast. (Bug#42014)
- On Mac OS X, some of the universal client libraries were not actually universal and were missing code for one or more architectures. (Bug#41940)
- String reallocation could cause memory overruns. (Bug#41868)
- `mysql_install_db` did not pass some relevant options to `mysqld`. (Bug#41828)
- Setting `innodb_locks_unsafe_for_binlog` should be equivalent to setting the transaction isolation level to `READ COMMITTED`. However, if both of those things were done, non-matching semi-consistently read rows were not unlocked when they should have been. (Bug#41671)
- `REPAIR TABLE` crashed for compressed `MyISAM` tables. (Bug#41574)
- For a `TIMESTAMP NOT NULL DEFAULT ...` column, storing `NULL` as the return value from some functions caused a “cannot be NULL” error. `NULL` returns now correctly cause the column default value to be stored. (Bug#41370)
- The server cannot execute `INSERT DELAYED` statements when statement-based binary logging is enabled, but the error message displayed only the table name, not the entire statement. (Bug#41121)
- `FULLTEXT` indexes did not work for Unicode columns that used a custom UCA collation. (Bug#41084)
- The Windows installer displayed incorrect product names in some images. (Bug#40845)



- Changing `innodb_thread_concurrency` at runtime could cause errors. (Bug#40760)
- `SELECT` statements could be blocked by `INSERT DELAYED` statements that were waiting for a lock, even with `low_priority_updates` enabled. (Bug#40536)
- For InnoDB tables that used `ROW_FORMAT=REDUNDANT`, storage size of `NULL` columns could be determined incorrectly. (Bug#40369)
- The query cache stored only partial query results if a statement failed while the results were being sent to the client. This could cause other clients to hang when trying to read the cached result. Now if a statement fails, the result is not cached. (Bug#40264)
- When a `MEMORY` table became full, the error generated was returned to the client but was not written to the error log. (Bug#39886)
- With row-based binary logging, replication of InnoDB tables containing `NULL`-valued `BIT` columns could fail. (Bug#39648)
- The expression `ROW(...) IN (SELECT ... FROM DUAL)` always returned `TRUE`. (Bug#39069)
- The greedy optimizer could cause a server crash due to improper handling of nested outer joins. (Bug#38795)
- Use of `COUNT(DISTINCT)` prevented `NULL` testing in the `HAVING` clause. (Bug#38637)
- The `innodb_stats_on_metadata` system variable was not displayed by `SHOW VARIABLES` and was not settable at runtime. (Bug#38189)
- Enabling the `sync_frm` system variable had no effect on the handling of `.frm` files for views. (Bug#38145)
- For comparison of `NULL` to a subquery result inside `IS NULL`, the comparison could evaluate to `NULL` rather than to `TRUE` or `FALSE`. This occurred for expressions such as:
 

```
SELECT ... WHERE NULL IN (SELECT ...) IS NULL
```

 (Bug#37822)
- Setting `myisam_repair_threads` greater than 1 caused a server crash for table repair or alteration operations for MyISAM tables with multiple `FULLTEXT` indexes. (Bug#37756)
- The `mysql` client sometimes improperly interpreted string escape sequences in non-string contexts. (Bug#36391)
- The query cache stored packets containing the server status of the time when the cached statement was run. This might lead to an incorrect transaction status on the client side if a statement was cached during a transaction and later served outside a transaction context (or vice versa). (Bug#36326)
- If the system time was adjusted backward during query execution, the apparent execution time could be negative. But in some cases these queries would be written to the slow query log, with the negative execution time written as a large unsigned number. Now statements with apparent negative execution time are not written to the slow query log. (Bug#35396)
- `libmysqld` was not built with all character sets. (Bug#32831)
- For `mysqld_multi`, using the `--mysqld=mysqld_safe` option caused the `--defaults-file` and `--defaults-extra-file` options to behave the same way. (Bug#32136)
- Attempts to open a valid `MERGE` table sometimes resulted in a `ER_WRONG_MRG_TABLE` error. This happened after failure to open an invalid `MERGE` table had also generated an `ER_WRONG_MRG_TABLE` error. (Bug#32047)
- For Solaris package installation using `pkgadd`, the postinstall script failed, causing the system tables in the `mysql` database not to be created. (Bug#31164)
- If the default database was dropped, the value of `character_set_database` was not reset to `character_set_server` as it should have been. (Bug#27208)

## C.2.6. Release Notes for MySQL Enterprise 5.1.31sp1 [QSP] (19 March 2009)

This is a *Service Pack* release of the MySQL Enterprise Server 5.1.

This section documents all changes and bugfixes that have been applied since the last MySQL Enterprise Server release (5.1.31).

If you would like to receive more fine-grained and personalized *update alerts* about fixes that are relevant to the version and features you use, please consider subscribing to *MySQL Enterprise* (a commercial MySQL offering). For more details please see [ht-](#)

[tp://www.mysql.com/products/enterprise/advisors.html](http://www.mysql.com/products/enterprise/advisors.html).

Functionality added or changed:

- The `libedit` library was upgraded to version 2.11. ([Bug#42433](#))

Bugs fixed:

- **Security Fix:** Using an XPath expression employing a scalar expression as a `FilterExpr` with `ExtractValue()` or `UpdateXML()` caused the server to crash. Such expressions now cause an error instead. ([Bug#42495](#))
- On the IBM i5 platform, the MySQL configuration process caused the system version of `pthread_setschedprio()` to be used. This function returns `SIGILL` on i5 because it is not supported, causing the server to crash. Now the `my_pthread_setprio()` function in the `mysys` library is used instead. ([Bug#42524](#))
- The SSL certificates included with MySQL distributions were regenerated because the previous ones had expired. ([Bug#42366](#))
- User variables within triggers could cause a crash if the `mysql_change_user()` C API function was invoked. ([Bug#42188](#))
- Some queries using `NAME_CONST( . . . COLLATE . . . )` led to a server crash due to a failed type cast. ([Bug#42014](#))

## C.2.7. Changes in MySQL 5.1.31 (19 January 2009)

Functionality added or changed:

- A new status variable, `Queries`, indicates the number of statements executed by the server. This includes statements executed within stored programs, unlike the `Questions` variable which includes only statements sent to the server by clients. ([Bug#41131](#))
- Performance of `SELECT *` retrievals from `INFORMATION_SCHEMA.COLUMNS` was improved slightly. ([Bug#38918](#))
- Previously, index hints did not work for `FULLTEXT` searches. Now they work as follows:

For natural language mode searches, index hints are silently ignored. For example, `IGNORE INDEX ( i )` is ignored with no warning and the index is still used.

For boolean mode searches, index hints with `FOR ORDER BY` or `FOR GROUP BY` are silently ignored. Index hints with `FOR JOIN` or no `FOR` modifier are honored. In contrast to how hints apply for non-`FULLTEXT` searches, the hint is used for all phases of query execution (finding rows and retrieval, grouping, and ordering). This is true even if the hint is given for a non-`FULLTEXT` index. ([Bug#38842](#))

Bugs fixed:

- **Important Change: Replication:** If a trigger was defined on an `InnoDB` table and this trigger updated a non-transactional table, changes performed on the `InnoDB` table were replicated and were visible on the slave before they were committed on the master, and were not rolled back on the slave after a successful rollback of those changes on the master.

As a result of the fix for this issue, the semantics of mixing non-transactional and transactional tables in a transaction in the first statement of a transaction have changed. Previously, if the first statement in a transaction contained non-transactional changes, the statement was written directly to the binary log. Now, any statement appearing after a `BEGIN` (or immediately following a `COMMIT` if `AUTOCOMMIT = 0`) is always considered part of the transaction and cached. This means that non-transactional changes do not propagate to the slave until the transaction is committed and thus written to the binary log.

See [Section 16.3.1.25, “Replication and Transactions”](#), for more information about this change in behavior. ([Bug#40116](#))

- **Partitioning: Replication:** Changing the transaction isolation level while replicating partitioned `InnoDB` tables could cause statement-based logging to fail. ([Bug#39084](#))
- **Partitioning:** A comparison with an invalid `DATE` value in a query against a partitioned table could lead to a crash of the MySQL server.

### Note

Invalid `DATE` and `DATETIME` values referenced in the `WHERE` clause of a query on a partitioned table are treated as



■ **NULL.** See [Section 17.4, “Partition Pruning”](#), for more information.

([Bug#40972](#))

- **Partitioning:** This bug was introduced in MySQL 5.1.29. ([Bug#40954](#))  
This regression was introduced by [Bug#30573](#), [Bug#33257](#), [Bug#33555](#).
- **Partitioning:** With `READ COMMITTED` transaction isolation level, `InnoDB` uses a semi-consistent read that releases non-matching rows after MySQL has evaluated the `WHERE` clause. However, this was not happening if the table used partitions. ([Bug#40595](#))
- **Partitioning:** A query that timed out when run against a partitioned table failed silently, without providing any warnings or errors, rather than returning `LOCK WAIT TIMEOUT EXCEEDED`. ([Bug#40515](#))
- **Partitioning:** `ALTER TABLE ... REORGANIZE PARTITION` could crash the server when the number of partitions was not changed. ([Bug#40389](#))  
See also [Bug#41945](#).
- **Partitioning:** For a partitioned table having an `AUTO_INCREMENT` column: If the first statement following a start of the server or a `FLUSH TABLES` statement was an `UPDATE` statement, the `AUTO_INCREMENT` column was not incremented correctly. ([Bug#40176](#))
- **Partitioning:** The server attempted to execute the statements `ALTER TABLE ... ANALYZE PARTITION`, `ALTER TABLE ... CHECK PARTITION`, `ALTER TABLE ... OPTIMIZE PARTITION`, and `ALTER TABLE ... REORGANIZE PARTITION` on tables that were not partitioned. ([Bug#39434](#))  
See also [Bug#20129](#).
- **Partitioning:** The value of the `CREATE_COLUMNS` column in `INFORMATION_SCHEMA.TABLES` was not `partitioned` for partitioned tables. ([Bug#38909](#))
- **Partitioning:** When executing an `ORDER BY` query on a partitioned `InnoDB` table using an index that was not in the partition expression, the results were sorted on a per-partition basis rather than for the table as a whole. ([Bug#37721](#))
- **Partitioning:** Dropping or creating an index on a partitioned table managed by the `InnoDB` Plugin locked the table. ([Bug#37453](#))
- **Partitioning:** Partitioned table checking sometimes returned a warning with an error code of 0, making proper response to errors impossible. The fix also renders the error message subject to translation in non-English deployments. ([Bug#36768](#))
- **Partitioning:** `SHOW TABLE STATUS` could show a nonzero value for the `Mean record length` of a partitioned `InnoDB` table, even if the table contained no rows. ([Bug#36312](#))
- **Partitioning:** When `SHOW CREATE TABLE` was used on a partitioned table, all of the table's `PARTITION` and `SUBPARTITION` clauses were output on a single line, making it difficult to read or parse. ([Bug#14326](#))
- **Replication:** Per-table `AUTO_INCREMENT` option values were not replicated correctly for `InnoDB` tables. ([Bug#41986](#))
- **Replication:** Some `log_event` types did not skip the post-header when reading. ([Bug#41961](#))
- **Replication:** Attempting to read a binary log containing an `Incident_log_event` having an invalid incident number could cause the debug server to crash. ([Bug#40482](#))
- **Replication:** When using row-based replication, an update of a primary key that was rolled back on the master due to a duplicate key error was not rolled back on the slave. ([Bug#40221](#))
- **Replication:** When rotating relay log files, the slave deletes relay log files and then edits the relay log index file. Formerly, if the slave shut down unexpectedly between these two events, the relay log index file could then reference relay logs that no longer existed. Depending on the circumstances, this could when restarting the slave cause either a race condition or the failure of replication. ([Bug#38826](#), [Bug#39325](#))
- **Replication:** With row-based replication, `UPDATE` and `DELETE` statements using `LIMIT` and a table's primary key could produce different results on the master and slave. ([Bug#38230](#))
- `resolve_stack_dump` was unable to resolve the stack trace format produced by `mysqld` in MySQL 5.1 and up (see [Section 21.5.1.5, “Using a Stack Trace”](#)). ([Bug#41612](#))
- In example option files provided in MySQL distributions, the `thread_stack` value was increased from 64K to 128K. ([Bug#41577](#))

- The optimizer could ignore an error and rollback request during a filesort, causing an assertion failure. (Bug#41543)
- `DATE_FORMAT()` could cause a server crash for year-zero dates. (Bug#41470)
- `SET PASSWORD` caused a server crash if the account name was given as `CURRENT_USER()`. (Bug#41456)
- When a repair operation was carried out on a `CSV` table, the debug server crashed. (Bug#41441)
- When substituting system constant functions with a constant result, the server was not expecting `NULL` function return values and could crash. (Bug#41437)
- Queries such as `SELECT ... CASE AVG(...) WHEN ...` that used aggregate functions in a `CASE` expression crashed the server. (Bug#41363)
- `INSERT INTO .. SELECT ... FROM` and `CREATE TABLE ... SELECT ... FROM` a `TEMPORARY` table could inadvertently change the locking type of the temporary table from a write lock to a read lock, causing statement failure. (Bug#41348)
- The `INFORMATION_SCHEMA.SCHEMA_PRIVILEGES` table was limited to 7680 rows. (Bug#41079)
- In debug builds, obsolete debug code could be used to crash the server. (Bug#41041)
- Some queries that used a “range checked for each record” scan could return incorrect results. (Bug#40974)
- Certain `SELECT` queries could fail with a `Duplicate entry` error. (Bug#40953)
- For debug servers, `OPTIMIZE TABLE` on a compressed table caused a server crash. (Bug#40949)
- Accessing user variables within triggers could cause a server crash. (Bug#40770)
- `IF(..., CAST(longtext_val AS UNSIGNED), signed_val)` as an argument to an aggregate function could cause an assertion failure. (Bug#40761)
- For single-table `UPDATE` statements, an assertion failure resulted from a runtime error in a stored function (such as a recursive function call or an attempt to update the same table as in the `UPDATE` statement). (Bug#40745)
- `TRUNCATE TABLE` for an `InnoDB` table did not flush cached queries for the table. (Bug#40386)
- Prepared statements allowed invalid dates to be inserted when the `ALLOW_INVALID_DATES` SQL mode was not enabled. (Bug#40365)
- `mc.exe` is no longer needed to compile MySQL on Windows. This makes it possible to build MySQL from source using Visual Studio Express 2008. (Bug#40280)
- The `'` character was incorrectly disallowed in table names. (Bug#40104)
- Support for the `revision` field in `.frm` files has been removed. This addresses the downgrading problem introduced by the fix for Bug#17823. (Bug#40021)
- Retrieval speed from the following `INFORMATION_SCHEMA` tables was improved by shortening the `VARIABLE_VALUE` column to 1024 characters: `GLOBAL_VARIABLES`, `SESSION_VARIABLES`, `GLOBAL_STATUS`, and `SESSION_STATUS`.  
As a result of this change, any variable value longer than 1024 characters will be truncated with a warning. This affects only the `init_connect` system variable. (Bug#39955)
- For an `InnoDB` table, `DROP TABLE` or `ALTER TABLE ... DISCARD TABLESPACE` could take a long time or cause a server crash. (Bug#39939)
- If the operating system is configured to return leap seconds from OS time calls or if the MySQL server uses a time zone definition that has leap seconds, functions such as `NOW()` could return a value having a time part that ends with `:59:60` or `:59:61`. If such values are inserted into a table, they would be dumped as is by `mysqldump` but considered invalid when reloaded, leading to backup/restore problems.  
Now leap second values are returned with a time part that ends with `:59:59`. This means that a function such as `NOW()` can return the same value for two or three consecutive seconds during the leap second. It remains true that literal temporal values having a time part that ends with `:59:60` or `:59:61` are considered invalid.  
For additional details about leap-second handling, see Section 9.7.2, “Time Zone Leap Second Support”. (Bug#39920)
- The server could crash during a sort-order optimization of a dependent subquery. (Bug#39844)

- For a server started with the `--temp-pool` option on Windows, temporary file creation could fail. This option now is ignored except on Linux systems, which was its original intended scope. (Bug#39750)
- `ALTER TABLE` on a table with `FULLTEXT` index that used a pluggable `FULLTEXT` parser could cause debug servers to crash. (Bug#39746)
- With the `ONLY_FULL_GROUP_BY` SQL mode enabled, the check for non-aggregated columns in queries with aggregate functions, but without a `GROUP BY` clause was treating all the parts of the query as if they were in the select list. This is fixed by ignoring the non-aggregated columns in the `WHERE` clause. (Bug#39656)
- The server crashed if an integer field in a CSV file did not have delimiting quotes. (Bug#39616)
- The `do_abi_check` program run during the build process depends on `mysql_version.h` but that file was not created first, resulting in build failure. (Bug#39571)
- `CHECK TABLE` failed for `MyISAM INFORMATION_SCHEMA` tables. (Bug#39541)
- On 64-bit Windows systems, the server accepted `key_buffer_size` values larger than 4GB, but allocated less. (For example, specifying a value of 5GB resulted in 1GB being allocated.) (Bug#39494)
- `InnoDB` could hang trying to open an adaptive hash index. (Bug#39483)
- Following `ALTER TABLE ... DISCARD TABLESPACE` for an `InnoDB` table, an attempt to determine the free space for the table before the `ALTER TABLE` operation had completely finished could cause a server crash. (Bug#39438)
- Use of the `PACK_KEYS` or `MAX_ROWS` table option in `ALTER TABLE` should have triggered table reconstruction but did not. (Bug#39372)
- The server returned a column type of `VARBINARY` rather than `DATE` as the result from the `COALESCE()`, `IFNULL()`, `IF()`, `GREATEST()`, or `LEAST()` functions or `CASE` expression if the result was obtained using `filesort` in an anonymous temporary table during the query execution. (Bug#39283)
- A server built using `yaSSL` for SSL support would crash if configured to use an RSA key and a client sent a cipher list containing a non-RSA key as acceptable. (Bug#39178)
- When built with `Valgrind`, the server failed to access tables created with the `DATA DIRECTORY` or `INDEX DIRECTORY` table option. (Bug#39102)
- With binary logging enabled `CREATE VIEW` was subject to possible buffer overwrite and a server crash. (Bug#39040)
- The fast mutex implementation was subject to excessive lock contention. (Bug#38941)
- Use of `InnoDB` monitoring (`SHOW ENGINE INNODB STATUS` or one of the `InnoDB` Monitor tables) could cause a server crash due to invalid access to a shared variable in a concurrent environment. (Bug#38883)
- `InnoDB` could fail to generate `AUTO_INCREMENT` values after an `UPDATE` statement for the table. (Bug#38839)
- If delayed insert failed to upgrade the lock, it did not free the temporary memory storage used to keep newly constructed `BLOB` values in memory, resulting in a memory leak. (Bug#38693)
- On Windows, a five-second delay occurred at shutdown of applications that used the embedded server. (Bug#38522)
- On Solaris, a scheduling policy applied to the main server process could be unintentionally overwritten in client-servicing threads. (Bug#38477)
- Building MySQL on FreeBSD would result in a failure during the `gen_lex_hash` phase of the build. (Bug#38364)
- On Windows, the embedded server would crash in `mysql_library_init()` if the language file was missing. (Bug#38293)
- A mix of `TRUNCATE TABLE` with `LOCK TABLES` and `UNLOCK TABLES` for an `InnoDB` could cause a server crash. (Bug#38231)
- The `ExtractValue()` function did not work correctly with XML documents containing a `DOCTYPE` declaration. (Bug#38227)
- Queries with a `HAVING` clause could return a spurious row. (Bug#38072)
- The Event Scheduler no longer logs “started in thread” or “executed” successfully messages to the error log. (Bug#38066)
- Use of spatial data types in prepared statements could cause memory leaks or server crashes. (Bug#37956, Bug#37671)

- An error in a debugging check caused crashes in debug servers. ([Bug#37936](#))
  - A `SELECT` with a `NULL NOT IN` condition containing a complex subquery from the same table as in the outer select caused an assertion failure. ([Bug#37894](#))
  - The presence of a `/ * . . . */` comment preceding a query could cause `InnoDB` to use unnecessary gap locks. ([Bug#37885](#))
  - Use of an uninitialized constant in `EXPLAIN` evaluation caused an assertion failure. ([Bug#37870](#))
  - When using `ALTER TABLE` on an `InnoDB` table, the `AUTO_INCREMENT` value could be changed to an incorrect value. ([Bug#37788](#))
  - Primary keys were treated as part of a covering index even if only a prefix of a key column was used. ([Bug#37742](#))
  - Renaming an `ARCHIVE` table to the same name with different lettercase and then selecting from it could cause a server crash. ([Bug#37719](#))
  - The `MONTHNAME()` and `DAYNAME()` functions returned a binary string, so that using `LOWER()` or `UPPER()` had no effect. Now `MONTHNAME()` and `DAYNAME()` return a value in `character_set_connection` character set. ([Bug#37575](#))
  - `TIMEDIFF()` was erroneously treated as always returning a positive result. Also, `CAST()` of `TIME` values to `DECIMAL` dropped the sign of negative values. ([Bug#37553](#))
- See also [Bug#42525](#).
- `SHOW PROCESSLIST` displayed “copy to tmp table” when no such copy was occurring. ([Bug#37550](#))
  - `mysqlcheck` used `SHOW FULL TABLES` to get the list of tables in a database. For some problems, such as an empty `.frm` file for a table, this would fail and `mysqlcheck` then would neglect to check other tables in the database. ([Bug#37527](#))
  - Updating a view with a subquery in the `CHECK` option could cause an assertion failure. ([Bug#37460](#))
  - Statements that displayed the value of system variables (for example, `SHOW VARIABLES`) expect variable values to be encoded in `character_set_system`. However, variables set from the command line such as `basedir` or `datadir` were encoded using `character_set_filesystem` and not converted correctly. ([Bug#37339](#))
  - `CREATE INDEX` could crash with `InnoDB` plugin 1.0.1. ([Bug#37284](#))
  - Certain boolean-mode `FULLTEXT` searches that used the truncation operator did not return matching records and calculated relevance incorrectly. ([Bug#37245](#))
  - On a 32-bit server built without big tables support, the offset argument in a `LIMIT` clause might be truncated due to a 64-bit to 32-bit cast. ([Bug#37075](#))
  - For an `InnoDB` table with a `FOREIGN KEY` constraint, `TRUNCATE TABLE` may be performed using row by row deletion. If an error occurred during this deletion, the table would be only partially emptied. Now if an error occurs, the truncation operation is rolled back and the table is left unchanged. ([Bug#37016](#))
  - The code for the `ut_usecetime()` function in `InnoDB` did not handle errors from the `gettimeofday()` system call. Now it retries `gettimeofday()` several times and updates the value of the `InnoDB_row_lock_time_max` status variable only if `ut_usecetime()` was successful. ([Bug#36819](#))
  - Use of `CONVERT()` with `GROUP BY` to convert numeric values to `CHAR` could return truncated results. ([Bug#36772](#))
  - The `mysql` client, when built with Visual Studio 2005, did not display Japanese characters. ([Bug#36279](#))
  - `CREATE INDEX` for `InnoDB` tables could under very rare circumstances cause the server to crash.. ([Bug#36169](#))
  - A read past the end of the string could occur while parsing the value of the `--innodb-data-file-path` option. ([Bug#36149](#))
  - Setting the `slave_compressed_protocol` system variable to `DEFAULT` failed in the embedded server. ([Bug#35999](#))
  - For upgrades to MySQL 5.1 or higher, `mysql_upgrade` did not re-encode database or table names that contained non-alphanumeric characters. (They would still appear after the upgrade with the `#mysql150#` prefix described in [Section 8.2.3, “Mapping of Identifiers to File Names”](#).) To correct this problem, it was necessary to run `mysqlcheck -all-databases --check-upgrade --fix-db-names --fix-table-names` manually. `mysql_upgrade` now runs that command automatically after performing the initial upgrade. ([Bug#35934](#))
  - `SHOW CREATE TABLE` did not display a printable value for the default value of `BIT` columns. ([Bug#35796](#))

- The columns that store character set and collation names in several `INFORMATION_SCHEMA` tables were lengthened because they were not long enough to store some possible values: `SCHEMATA`, `TABLES`, `COLUMNS`, `CHARACTER_SETS`, `COLLATIONS`, and `COLLATION_CHARACTER_SET_APPLICABILITY`. (Bug#35789)
- The `max_length` metadata value was calculated incorrectly for the `FORMAT()` function, which could cause incorrect result set metadata to be sent to clients. (Bug#35558)
- InnoDB was not updating the `Handler_delete` or `Handler_update` status variables. (Bug#35537)
- InnoDB could fail to generate `AUTO_INCREMENT` values if rows previously had been inserted containing literal values for the `AUTO_INCREMENT` column. (Bug#35498, Bug#36411, Bug#39830)
- The `CREATE_OPTIONS` column for `INFORMATION_SCHEMA.TABLES` did not display the `KEY_BLOCK_SIZE` option. (Bug#35275)
- Selecting from an `INFORMATION_SCHEMA` table into an incorrectly defined `MERGE` table caused an assertion failure. (Bug#35068)
- `perror` on Windows did not know about Win32 system error codes. (Bug#34825)
- `EXPLAIN EXTENDED` evaluation of aggregate functions that required a temporary table caused a server crash. (Bug#34773)
- `SHOW GLOBAL STATUS` shows values that aggregate the session status values for all threads. This did not work correctly for the embedded server. (Bug#34517)
- `mysqldumpslow` did not aggregate times. (Bug#34129)
- `mysql_config` did not output `-ldl` (or equivalent) when needed for `--libmysql-dlibs`, so its output could be insufficient to build applications that use the embedded server. (Bug#34025)
- The `mysql` client incorrectly parsed statements containing the word “delimiter” in mid-statement.

This fix is different from the one applied for this bug in MySQL 5.1.26. (Bug#33812)

See also Bug#38158.

- For a stored procedure containing a `SELECT * ... RIGHT JOIN` query, execution failed for the second call. (Bug#33811)
- Previously, use of index hints with views (which do not have indexes) produced the error `ERROR 1221 (HY000): INCORRECT USAGE OF USE/IGNORE INDEX AND VIEW`. Now this produces `ERROR 1176 (HY000): KEY '...' DOESN'T EXIST IN TABLE '...'`, the same error as for base tables without an appropriate index. (Bug#33461)
- Three conditions were discovered that could cause an upgrade from MySQL 5.0 to 5.1 to fail: 1) Triggers associated with a table that had a `#mysql150#` prefix in the name could cause assertion failure. 2) `ALTER DATABASE ... UPGRADE DATA DIRECTORY NAME` failed for databases that had a `#mysql150#` prefix if there were triggers in the database. 3) `mysqlcheck --fix-table-name` didn't use UTF8 as the default character set, resulting in parsing errors for tables with non-latin symbols in their names and trigger definitions. (Bug#33094, Bug#41385)
- Execution of a prepared statement that referred to a system variable caused a server crash. (Bug#32124)
- Some division operations produced a result with incorrect precision. (Bug#31616)
- Queries executed using join buffering of `BIT` columns could produce incorrect results. (Bug#31399)
- `ALTER TABLE CONVERT TO CHARACTER SET` did not convert `TINYTEXT` or `MEDIUMTEXT` columns to a longer text type if necessary when converting the column to a different character set. (Bug#31291)
- Server variables could not be set to their current values on Linux platforms. (Bug#31177)

See also Bug#6958.

- For installation on Solaris using `pkgadd` packages, the `mysql_install_db` script was generated in the `scripts` directory, but the temporary files used during the process were left there and not deleted. (Bug#31052)
- Static storage engines and plugins that were disabled and dynamic plugins that were installed but disabled were not listed in the `INFORMATION_SCHEMA` appropriate `PLUGINS` or `ENGINES` table. (Bug#29263)
- Some `SHOW` statements and retrievals from the `INFORMATION_SCHEMA` `TRIGGERS` and `EVENTS` tables used a temporary table and incremented the `Created_tmp_disk_tables` status variable, due to the way that `TEXT` columns are handled. The `TRIGGERS.SQL_MODE`, `TRIGGERS.DEFINER`, and `EVENTS.SQL_MODE` columns now are `VARCHAR` to avoid this problem. (Bug#29153)

- For several read only system variables that were viewable with `SHOW VARIABLES`, attempting to view them with `SELECT @@var_name` or set their values with `SET` resulted in an `unknown system variable` error. Now they can be viewed with `SELECT @@var_name` and attempting to set their values results in a message indicating that they are read only. (Bug#28234)
- On Windows, Visual Studio does not take into account some x86 hardware limitations, which led to incorrect results converting large `DOUBLE` values to unsigned `BIGINT` values. (Bug#27483)
- SSL support was not included in some “generic” RPM packages. (Bug#26760)
- The `Questions` status variable is intended as a count of statements sent by clients to the server, but was also counting statements executed within stored routines. (Bug#24289)
- Setting the session value of the `max_allowed_packet` or `net_buffer_length` system variable was allowed but had no effect. The session value of these variables is now read only. (Bug#22891)
- A race condition between the `mysqld.exe` server and the Windows service manager could lead to inability to stop the server from the service manager. (Bug#20430)
- On Windows, moving an `InnoDB .ibd` file and then symlinking to it in the database directory using a `.sym` file caused a server crash. (Bug#11894)

## C.2.8. Changes in MySQL 5.1.30 (14 November 2008 General Availability)

Bugs fixed:

- **Partitioning:** A `SELECT` using a range `WHERE` condition with an `ORDER BY` on a partitioned table caused a server crash. (Bug#40494)
- **Replication:** Row-based replication failed with non-partitioned `MyISAM` tables having no indexes. (Bug#40004)
- With statement-based binary logging format and a transaction isolation level of `READ COMMITTED` or stricter, `InnoDB` printed an error because statement-based logging might lead to inconsistency between master and slave databases. However, this error was printed even when binary logging was not enabled (in which case, no such inconsistency can occur). (Bug#40360)
- The `CHECK TABLE ... FOR UPGRADE` statement did not check for incompatible collation changes made in MySQL 5.1.24 (Bug#27877). This also affects `mysqlcheck` and `mysql_upgrade`, which cause that statement to be executed. See Section 2.12.3, “Checking Whether Table Indexes Must Be Rebuilt”.

Prior to this fix, a binary upgrade (performed without dumping tables with `mysqldump` before the upgrade and reloading the dump file after the upgrade) would corrupt tables that have indexes that use the `utf8_general_ci` or `ucs2_general_ci` collation for columns that contain 'ß' LATIN SMALL LETTER SHARP S (German). After the fix, `CHECK TABLE ... FOR UPGRADE` properly detects the problem and warns about tables that need repair.

However, the fix is not backward compatible and can result in a downgrading problem under these circumstances:

1. Perform a binary upgrade to a version of MySQL that includes the fix.
2. Run `CHECK TABLE ... FOR UPGRADE` (or `mysqlcheck` or `mysql_upgrade`) to upgrade tables.
3. Perform a binary downgrade to a version of MySQL that does not include the fix.

The solution is to dump tables with `mysqldump` before the downgrade and reload the dump file after the downgrade. Alternatively, drop and recreate affected indexes. (Bug#40053)

- Some recent releases for Solaris 10 were built on Solaris 10 U5, which included a new version of `libnsl.so` that does not work on U4 or earlier. To correct this, Solaris 10 builds now are created on machines that do not have that upgraded `libnsl.so`, so that they will work on Solaris 10 installations both with and without the upgraded `libnsl.so`. (Bug#39074)
- XA transaction rollbacks could result in corrupted transaction states and a server crash. (Bug#28323)
- `ALTER TABLE` for an `ENUM` column could change column values. (Bug#23113)

## C.2.9. Changes in MySQL 5.1.29 (11 October 2008)

Functionality added or changed:



- **Important Change:** The `--skip-thread-priority` option is now deprecated in MySQL 5.1 and is removed in MySQL 6.0 such that the server won't change the thread priorities by default. Giving threads different priorities might yield marginal improvements in some platforms (where it actually works), but it might instead cause significant degradation depending on the thread count and number of processors. Meddling with the thread priorities is not a safe bet as it is very dependent on the behavior of the CPU scheduler and system where MySQL is being run. ([Bug#35164](#), [Bug#37536](#))
- **Important Change:** The `--log` option now is deprecated and will be removed (along with the `log` system variable) in the future. Instead, use the `--general_log` option to enable the general query log and the `--general_log_file=file_name` option to set the general query log file name. The values of these options are available in the `general_log` and `general_log_file` system variables, which can be changed at runtime.  
  
Similar changes were made for the `--log-slow-queries` option and `log_slow_queries` system variable. You should use the `--slow_query_log` and `--slow_query_log_file=file_name` options instead (and the `slow_query_log` and `slow_query_log_file` system variables).
- The `BUILD/compile-solaris-*` scripts now compile MySQL with the `mtmalloc` library rather than `malloc`. ([Bug#38727](#))

Bugs fixed:

- **Incompatible Change: Replication:** The default binary logging mode has been changed from `MIXED` to `STATEMENT` for compatibility with MySQL 5.0. ([Bug#39812](#))
- **Incompatible Change:** `CHECK TABLE ... FOR UPGRADE` did not check for incompatible collation changes made in MySQL 5.1.21 ([Bug#29499](#)) and 5.1.23 ([Bug#27562](#), [Bug#29461](#)). This also affects `mysqlcheck` and `mysql_upgrade`, which cause that statement to be executed. See [Section 2.12.3, "Checking Whether Table Indexes Must Be Rebuilt"](#). ([Bug#39585](#))  
  
See also [Bug#40984](#).
- **Incompatible Change:** In connection with view creation, the server created `arc` directories inside database directories and maintained useless copies of `.frm` files there. Creation and renaming procedures of those copies as well as creation of `arc` directories has been discontinued.

This change does cause a problem when downgrading to older server versions which manifests itself under these circumstances:

1. Create a view `v_orig` in MySQL 5.1.29 or higher.
2. Rename the view to `v_new` and then back to `v_orig`.
3. Downgrade to an older 5.1.x server and run `mysql_upgrade`.
4. Try to rename `v_orig` to `v_new` again. This operation fails.

As a workaround to avoid this problem, use either of these approaches:

- Dump your data using `mysqldump` before downgrading and reload the dump file after downgrading.
- Instead of renaming a view after the downgrade, drop it and recreate it.

The downgrade problem introduced by the fix for this bug has been addressed as [Bug#40021](#). ([Bug#17823](#))

- **Important Change: Replication:** The `SUPER` privilege is now required to change the session value of `binlog_format` as well as its global value. For more information about `binlog_format`, see [Section 16.1.2, "Replication Formats"](#). ([Bug#39106](#))
- **Partitioning: Replication:** Replication to partitioned `MyISAM` tables could be slow with row-based binary logging. ([Bug#35843](#))
- **Partitioning:** If an error occurred when evaluating a column of a partitioned table for the partitioning function, the row could be inserted anyway. ([Bug#38083](#))
- **Partitioning:** Using `INSERT ... SELECT` to insert records into a partitioned `MyISAM` table could fail if some partitions were empty and others are not. ([Bug#38005](#))
- **Partitioning:** Ordered range scans on partitioned tables were not always handled correctly. In some cases this caused some rows to be returned twice. The same issue also caused `GROUP BY` query results to be aggregated incorrectly. ([Bug#30573](#), [Bug#33257](#), [Bug#33555](#))

- **Replication:** Server code used in binary logging could in some cases be invoked even though binary logging was not actually enabled, leading to asserts and other server errors. ([Bug#38798](#))
- **Replication:** Replication of `BLACKHOLE` tables did not work with row-based binary logging. ([Bug#38360](#))
- **Replication:** In some cases, a replication master sent a special event to a reconnecting slave to keep the slave's temporary tables, but they still had references to the “old” slave SQL thread and used them to access that thread's data. ([Bug#38269](#))
- **Replication:** Replication filtering rules were inappropriately applied when executing `BINLOG` pseudo-queries. One way in which this problem showed itself was that, when replaying a binary log with `mysqlbinlog`, RBR events were sometimes not executed if the `--replicate-do-db` option was specified. Now replication rules are applied only to those events executed by the slave SQL thread. ([Bug#36099](#))
- **Replication:** For a `CREATE TABLE ... SELECT` statement that creates a table in a database other than the current one, the table could be created in the wrong database on replication slaves if row-based binary logging is used. ([Bug#34707](#))
- **Replication:** A statement did not always commit or roll back correctly when the server was shut down; the error could be triggered by having a failing `UPDATE` or `INSERT` statement on a transactional table, causing an implicit rollback. ([Bug#32709](#))  
See also [Bug#38262](#).
- The Sun Studio compiler failed to build debug versions of the server due to use of features specific to `gcc`. ([Bug#39451](#))
- For a `TIMESTAMP` column in an `InnoDB` table, testing the column with multiple conditions in the `WHERE` clause caused a server crash. ([Bug#39353](#))
- References to local variables in stored procedures are replaced with `NAME_CONST(name, value)` when written to the binary log. However, an “illegal mix of collation” error might occur when executing the log contents if the value's collation differed from that of the variable. Now information about the variable collation is written as well. ([Bug#39182](#))
- Queries of the form `SELECT ... REGEXP BINARY NULL` could lead to a hung or crashed server. ([Bug#39021](#))
- Statements of the form `INSERT ... SELECT .. ON DUPLICATE KEY UPDATE col_name = DEFAULT` could result in a server crash. ([Bug#39002](#))
- Column names constructed due to wild-card expansion done inside a stored procedure could point to freed memory if the expansion was performed after the first call to the stored procedure. ([Bug#38823](#))
- Repeated `CREATE TABLE ... SELECT` statements, where the created table contained an `AUTO_INCREMENT` column, could lead to an assertion failure. ([Bug#38821](#))
- For deadlock between two transactions that required a timeout to resolve, all server tables became inaccessible for the duration of the deadlock. ([Bug#38804](#))
- When inserting a string into a duplicate-key error message, the server could improperly interpret the string, resulting in a crash. ([Bug#38701](#))
- A race condition between threads sometimes caused unallocated memory to be addressed. ([Bug#38692](#))
- A server crash resulted from concurrent execution of a multiple-table `UPDATE` that used a `NATURAL` or `USING` join together with `FLUSH TABLES WITH READ LOCK` or `ALTER TABLE` for the table being updated. ([Bug#38691](#))
- On ActiveState Perl, `mysql-test-run.pl --start-and-exit` started but did not exit. ([Bug#38629](#))
- An uninitialized variable in the query profiling code was corrected (detected by Valgrind). ([Bug#38560](#))
- A server crash resulted from execution of an `UPDATE` that used a derived table together with `FLUSH TABLES`. ([Bug#38499](#))
- Stored procedures involving substrings could crash the server on certain platforms due to invalid memory reads. ([Bug#38469](#))
- The handlerton-to-plugin mapping implementation did not free handler plugin references when the plugin was uninstalled, resulting in a server crash after several install/uninstall cycles. Also, on Mac OS X, the server crashed when trying to access an `EXAMPLE` table after the `EXAMPLE` plugin was installed. ([Bug#37958](#))
- The server crashed if an argument to a stored procedure was a subquery that returned more than one row. ([Bug#37949](#))
- When analyzing the possible index use cases, the server was incorrectly reusing an internal structure, leading to a server crash. ([Bug#37943](#))
- Access checks were skipped for `SHOW PROCEDURE STATUS` and `SHOW FUNCTION STATUS`, which could lead to a server crash or insufficient access checks in subsequent statements. ([Bug#37908](#))



- The `<=>` operator could return incorrect results when comparing `NULL` to `DATE`, `TIME`, or `DATETIME` values. (Bug#37526)
- The combination of a subquery with a `GROUP BY`, an aggregate function calculated outside the subquery, and a `GROUP BY` on the outer `SELECT` could cause the server to crash. (Bug#37348)
- The `NO_BACKSLASH_ESCAPES` SQL mode was ignored for `LOAD DATA INFILE` and `SELECT INTO ... OUTFILE`. The setting is taken into account now. (Bug#37114)
- In some cases, references to views were confused with references to anonymous tables and privilege checking was not performed. (Bug#36086)
- For crash reports on Windows, symbol names in stack traces were not correctly resolved. (Bug#35987)
- `ALTER EVENT` changed the `PRESERVE` attribute of an event even when `PRESERVE` was not specified in the statement. (Bug#35981)
- Host name values in SQL statements were not being checked for `'@'`, which is illegal according to RFC952. (Bug#35924)
- `mysql_install_db` failed on machines that had the host name set to `localhost`. (Bug#35754)
- Dynamic plugins failed to load on i5/OS. (Bug#35743)
- With the `PAD_CHAR_TO_FULL_LENGTH` SQL mode enabled, a `ucs2 CHAR` column returned additional garbage after trailing space characters. (Bug#35720)
- With binary logging enabled, `CREATE TABLE ... SELECT` failed if the source table was a log table. (Bug#34306)
- A trigger for an `InnoDB` table activating multiple times could lead to `AUTO_INCREMENT` gaps. (Bug#31612)
- `mysqldump` could fail to dump views containing a large number of columns. (Bug#31434)
- The server could improperly type user-defined variables used in the select list of a query. (Bug#26020)
- For access to the `INFORMATION_SCHEMA.VIEWS` table, the server did not check the `SHOW VIEW` and `SELECT` privileges, leading to inconsistency between output from that table and the `SHOW CREATE VIEW` statement. (Bug#22763)
- `mysqld_safe` would sometimes fail to remove the pid file for the old `mysql` process after a crash. As a result, the server would fail to start due to a false `A mysqld process already exists...` error. (Bug#11122)

## C.2.10. Changes in MySQL 5.1.28 (28 August 2008)

Functionality added or changed:

- **Important Change:** `mysqlbinlog` now supports `--verbose` and `--base64-output=DECODE-ROWS` options to display row events as commented SQL statements. (The default otherwise is to display row events encoded as base-64 strings using `BINLOG` statements.) See Section 4.6.7.2, “`mysqlbinlog` Row Event Display”. (Bug#31455)
- MySQL source distributions are now available in Zip format. (Bug#27742)
- Added the `SHOW PROFILES` and `SHOW PROFILE` statements to display statement profile data, and the accompanying `INFORMATION_SCHEMA.PROFILING` table. Profiling is controlled via the `profiling` and `profiling_history_size` session variables. see Section 12.5.5.33, “`SHOW PROFILES` Syntax”, and Section 19.26, “The `INFORMATION_SCHEMA.PROFILING` Table”. (Community contribution by Jeremy Cole)

The profiling feature is enabled via the `--enable-community-features` and `--enable-profiling` options to `configure`. These options are enabled by default; to disable them, use `--disable-community-features` and `--disable-profiling`. (Bug#24795)

Bugs fixed:

- **Important Change: Security Fix:** Additional corrections were made for the symlink-related privilege problem originally addressed in MySQL 5.1.24. The original fix did not correctly handle the data directory path name if it contained symlinked directories in its path, and the check was made only at table-creation time, not at table-opening time later. (Bug#32167, CVE-2008-2079)

See also Bug#39277.

- **Security Enhancement:** The server consumed excess memory while parsing statements with hundreds or thousands of nested boolean conditions (such as `OR (OR ... (OR ... ))`). This could lead to a server crash or incorrect statement execution, or cause other client statements to fail due to lack of memory. The latter result constitutes a denial of service. (Bug#38296)
- **Incompatible Change:** There were some problems using `DllMain()` hook functions on Windows that automatically do global and per-thread initialization for `libmysqld.dll`:
  - Per-thread initialization: MySQL internally counts the number of active threads, which causes a delay in `my_end()` if not all threads have exited. But there are threads that can be started either by Windows internally (often in TCP/IP scenarios) or by users. Those threads do not necessarily use `libmysql.dll` functionality but still contribute to the open-thread count. (One symptom is a five-second delay in times for PHP scripts to finish.)
  - Process-initialization: `my_init()` calls `WSAStartup` that itself loads DLLs and can lead to a deadlock in the Windows loader.

To correct these problems, DLL initialization code now is not invoked from `libmysql.dll` by default. To obtain the previous behavior (DLL initialization code will be called), set the `LIBMYSQL_DLLINIT` environment variable to any value. This variable exists only to prevent breakage of existing Windows-only applications that do not call `mysql_thread_init()` and work okay today. Use of `LIBMYSQL_DLLINIT` is discouraged and is removed in MySQL 6.0. (Bug#37226, Bug#33031)

- **Incompatible Change:** Some performance problems of `SHOW ENGINE INNODB STATUS` were reduced by removing `used cells` and `Total number of lock structs in row lock hash table` from the output. Now these values are present only if the `UNIV_DEBUG` symbol is defined at MySQL build time. (Bug#36941, Bug#36942)
- **Incompatible Change:** `SHOW STATUS` took a lot of CPU time for calculating the value of the `InnoDB_buffer_pool_pages_latched` status variable. Now this variable is calculated and included in the output of `SHOW STATUS` only if the `UNIV_DEBUG` symbol is defined at MySQL build time. (Bug#36600)
- **Incompatible Change:** An additional correction to the original MySQL 5.1.23 fix was made to normalize directory names before adding them to the list of directories. This prevents `/etc/` and `/etc` from being considered different, for example. (Bug#20748)

See also Bug#38180.

- **Partitioning:** When a partitioned table had a `TIMESTAMP` column defined with `CURRENT_TIMESTAMP` as the default but with no `ON UPDATE` clause, the column's value was incorrectly set to `CURRENT_TIMESTAMP` when updating across partitions. (Bug#38272)
- **Partitioning:** `myisamchk` failed with an assertion error when analyzing a partitioned `MyISAM` table. (Bug#37537)
- **Partitioning:** A `LIST` partitioned `MyISAM` table returned erroneous results when an index was present on a column in the `WHERE` clause and `NOT IN` was used on that column.

Searches using the index were also much slower then if the index were not present. (Bug#35931)

- **Partitioning:** `SELECT COUNT(*)` was not correct for some partitioned tables using a storage engine that did not support `HA_STATS_RECORDS_IS_EXACT`. Tables using the `ARCHIVE` storage engine were known to be affected.

This was because `ha_partition::records()` was not implemented, and so the default `handler::records()` was used in its place. However, this is not correct behavior if the storage engine does not support `HA_STATS_RECORDS_IS_EXACT`.

The solution was to implement `ha_partition::records()` as a wrapper around the underlying partition records.

As a result of this fix, the `rows` column in the output of `EXPLAIN PARTITIONS` now includes the total number of records in the partitioned table. (Bug#35745)

- **Partitioning:** `MyISAM` recovery enabled with the `--myisam-recover` option did not work for partitioned `MyISAM` tables. (Bug#35161)
- **Partitioning:** When one user was in the midst of a transaction on a partitioned table, a second user performing an `ALTER TABLE` on this table caused the server to hang. (Bug#34604)
- **Replication:** Some kinds of internal errors, such as `OUT OF MEMORY` errors, could cause the server to crash when replicating statements with user variables.

certain internal errors. (Bug#37150)

- **Replication:** Row-based replication did not correctly copy `TIMESTAMP` values from a big-endian storage engine to a little-endian storage engine. (Bug#37076)

- **Replication:** `INSTALL PLUGIN` and `UNINSTALL PLUGIN` caused row-based replication to fail.

### Note

These statements are not replicated; however, when using row-based logging, the changes they introduce in the `mysql` system tables are written to the binary log.

([Bug#35807](#))

- Server-side cursors were not initialized properly, which could cause a server crash. ([Bug#38486](#))
- A server crash or Valgrind warnings could result when a stored procedure selected from a view that referenced a function. ([Bug#38291](#))
- A failure to clean up binary log events was corrected (detected by Valgrind). ([Bug#38290](#))
- Incorrect handling of aggregate functions when loose index scan was used caused a server crash. ([Bug#38195](#))
- Queries containing a subquery with `DISTINCT` and `ORDER BY` could cause a server crash. ([Bug#38191](#))
- Over-aggressive lock acquisition by `InnoDB` when calculating free space for tablespaces could result in performance degradation when multiple threads were executing statements on multi-core machines. ([Bug#38185](#))
- The fix for [Bug#20748](#) caused a problem such that on Unix, MySQL programs looked for options in `~/my.cnf` rather than the standard location of `~/my.cnf`. ([Bug#38180](#))
- If the table definition cache contained tables with many `BLOB` columns, much memory could be allocated to caching `BLOB` values. Now a size limit on the cached `BLOB` values is enforced. ([Bug#38002](#))
- For `InnoDB` tables, `ORDER BY ... DESC` sometimes returned results in ascending order. ([Bug#37830](#))
- If a table has a `BIT NOT NULL` column `c1` with a length shorter than 8 bits and some additional `NOT NULL` columns `c2, ...`, and a `SELECT` query has a `WHERE` clause of the form `(c1 = constant) AND c2 ...`, the query could return an unexpected result set. ([Bug#37799](#))
- The server returned unexpected results if a right side of the `NOT IN` clause consisted of the `NULL` value and some constants of the same type. For example, this query might return 3, 4, 5, and so forth if a table contained those values:

```
SELECT * FROM t WHERE NOT t.id IN (NULL, 1, 2);
```

([Bug#37761](#))

- Setting the session value of the `innodb_table_locks` system variable caused a server crash. ([Bug#37669](#))
- Nesting of `IF()` inside of `SUM()` could cause an extreme server slowdown. ([Bug#37662](#))
- Killing a query that used an `EXISTS` subquery as the argument to `SUM()` or `AVG()` caused a server crash. ([Bug#37627](#))
- When using indexed `ORDER BY` sorting, incorrect query results could be produced if the optimizer switched from a covering index to a non-covering index. ([Bug#37548](#))
- After `TRUNCATE TABLE` for an `InnoDB` table, inserting explicit values into an `AUTO_INCREMENT` column could fail to increment the counter and result in a duplicate-key error for subsequent insertion of `NULL`. ([Bug#37531](#))
- Within stored programs or prepared statements, `REGEXP` could return incorrect results due to improper initialization. ([Bug#37337](#))
- For a `MyISAM` table with `CHECKSUM = 1` and `ROW_FORMAT = DYNAMIC` table options, a data consistency check (maximum record length) could fail and cause the table to be marked as corrupted. ([Bug#37310](#))
- The `max_length` result set metadata value was calculated incorrectly under some circumstances. ([Bug#37301](#))
- If the length of a field was 3, internal `InnoDB` to integer type conversion didn't work on big-endian machines in the `row_search_autoinc_column()` function. ([Bug#36793](#))
- A query which had an `ORDER BY DESC` clause that is satisfied with a reverse range scan could cause a server crash for some specific CPU/compiler combinations. ([Bug#36639](#))
- The `CSV` storage engine returned success even when it failed to open a table's data file. ([Bug#36638](#))
- `SELECT DISTINCT` from a simple view on an `InnoDB` table, where all selected columns belong to the same unique index

- key, returned incorrect results. ([Bug#36632](#))
- Dumping information about locks in use by sending a `SIGHUP` signal to the server or by invoking the `mysqladmin debug` command could lead to a server crash in debug builds or to undefined behavior in production builds. ([Bug#36579](#))
  - If initialization of an `INFORMATION_SCHEMA` plugin failed, `INSTALL PLUGIN` freed some internal plugin data twice. ([Bug#36399](#))
  - For `InnoDB` tables, the `DATA_FREE` column of the `INFORMATION_SCHEMA.TABLES` displayed free space in kilobytes rather than bytes. Now it displays bytes. ([Bug#36278](#))
  - When the fractional part in a multiplication of `DECIMAL` values overflowed, the server truncated the first operand rather than the longest. Now the server truncates so as to produce more precise multiplications. ([Bug#36270](#))
  - The `mysql` client failed to recognize comment lines consisting of `--` followed by a newline. ([Bug#36244](#))
  - The server could crash with an assertion failure (or cause the client to get a “Packets out of order” error) when the expected query result was that it should terminate with a “Subquery returns more than 1 row” error. ([Bug#36135](#))
  - The `UUID()` function returned UUIDs with the wrong time; this was because the offset for the time part in UUIDs was miscalculated. ([Bug#35848](#))
  - The `configure` script did not allow `utf8_hungarian_ci` to be specified as the default collation. ([Bug#35808](#))
  - On 64-bit systems, assigning values of  $2^{63} - 1$  or larger to `key_buffer_size` caused memory overruns. ([Bug#35616](#))
  - For `InnoDB` tables, `REPLACE` statements used “traditional” style locking, regardless of the setting of `innodb_autoinc_lock_mode`. Now `REPLACE` works the same way as “simple inserts” instead of using the old locking algorithm. (`REPLACE` statements are treated in the same way as `INSERT` statements.) ([Bug#35602](#))
  - Freeing of an internal parser stack during parsing of complex stored programs caused a server crash. ([Bug#35577](#), [Bug#37269](#), [Bug#37228](#))
  - `mysqlbinlog` left temporary files on the disk after shutdown, leading to the pollution of the temporary directory, which eventually caused `mysqlbinlog` to fail. This caused problems in testing and other situations where `mysqlbinlog` might be invoked many times in a relatively short period of time. ([Bug#35543](#))
  - Index scans performed with the `sort_union()` access method returned wrong results, caused memory to be leaked, and caused temporary files to be deleted when the limit set by `sort_buffer_size` was reached. ([Bug#35477](#), [Bug#35478](#))
  - Table checksum calculation could cause a server crash for `FEDERATED` tables with `BLOB` columns containing `NULL` values. ([Bug#34779](#))
  - A significant slowdown occurred when many `SELECT` statements that return many rows from `InnoDB` tables were running concurrently. ([Bug#34409](#))
  - `mysql_install_db` failed if the server was running with an SQL mode of `TRADITIONAL`. This program now resets the SQL mode internally to avoid this problem. ([Bug#34159](#))
  - Changes to build files were made to enable the MySQL distribution to compile on Microsoft Visual C++ Express 2008. ([Bug#33907](#))
  - Fast `ALTER TABLE` operations were not fast for columns that used multibyte character sets. ([Bug#33873](#))
  - The internal functions `my_getsystemtime()`, `my_micro_time()`, and `my_micro_time_and_time()` did not work correctly on Windows. One symptom was that uniqueness of `UUID()` values could be compromised. ([Bug#33748](#))
  - Cached queries that used 256 or more tables were not properly cached, so that later query invalidation due to a `TRUNCATE TABLE` for one of the tables caused the server to hang. ([Bug#33362](#))
  - `mysql_upgrade` attempted to use the `/proc` file system even on systems that do not have it. ([Bug#31605](#))
  - `mysql_install_db` failed if the default storage engine was `NDB`. Now it explicitly uses `MyISAM` as the storage engine when running `mysqld --bootstrap`. ([Bug#31315](#))
  - Several MySQL programs could fail if the `HOME` environment variable had an empty value. ([Bug#30394](#))
  - On NetWare, `mysql_install_db` could appear to execute normally even if it failed to create the initial databases. ([Bug#30129](#))
  - The Serbian translation for the `ER_INCORRECT_GLOBAL_LOCAL_VAR` error was corrected. ([Bug#29738](#))

- `TRUNCATE TABLE` for `InnoDB` tables returned a count showing too many rows affected. Now the statement returns 0 for `InnoDB` tables. ([Bug#29507](#))
- The `BUILD/check-cpu` build script failed if `gcc` had a different name (such as `gcc.real` on Debian). ([Bug#27526](#))
- In some cases, the parser interpreted the `;` character as the end of input and misinterpreted stored program definitions. ([Bug#26030](#))
- The `FLUSH PRIVILEGES` statement did not produce an error when it failed. ([Bug#21226](#))
- After executing a prepared statement that accesses a stored function, the next execution would fail to find the function if the stored function cache was flushed in the meantime. ([Bug#12093](#), [Bug#21294](#))

## C.2.11. Changes in MySQL 5.1.27 (Not released)

Functionality added or changed:

- `mysqltest` now installs signal handlers and generates a stack trace if it crashes. ([Bug#37003](#))
- `mysql-test-run.pl` now supports `--client-bindir` and `--client-libdir` options for specifying the directory where client binaries and libraries are located. ([Bug#34995](#))

Bugs fixed:

- **Partitioning: Incompatible Change:** On Mac OS X with `lower_case_table_names = 2`, the server could not read partitioned tables whose names contained uppercase letters.

Partitioned tables using mixed case names should be renamed or dropped before upgrading to this version of the server on Mac OS X. ([Bug#37402](#))

- **Partitioning: Important Note:** The statements `ANALYZE TABLE`, `CHECK TABLE`, `OPTIMIZE TABLE`, and `REPAIR TABLE` are now supported for partitioned tables.

Also as a result of this fix, the following statements which were disabled in MySQL 5.1.24 have been re-enabled:

- `ALTER TABLE ... ANALYZE PARTITION`
- `ALTER TABLE ... CHECK PARTITION`
- `ALTER TABLE ... OPTIMIZE PARTITION`
- `ALTER TABLE ... REPAIR PARTITION`

([Bug#20129](#))

See also [Bug#39434](#).

- **Replication:** Issuing a `DROP DATABASE` while any temporary tables were open caused the server to switch to statement-based mode. ([Bug#38773](#))
- **Replication:** The `--replicate-*-table` options were not evaluated correctly when replicating multi-table updates.

As a result of this fix, replication of multi-table updates no longer fails when an update references a missing table but does not update any of its columns. ([Bug#37051](#))

- The fix for [Bug#33812](#) had the side effect of causing the `mysql` client not to be able to read some dump files produced with `mysqldump`. To address this, that fix was reverted. ([Bug#38158](#))

## C.2.12. Changes in MySQL 5.1.26 (30 June 2008)

Functionality added or changed:

- **Important Change: Incompatible Change:** The `FEDERATED` storage engine is now disabled by default in binary distributions. The engine is still available and can be enabled by starting the server with the `--federated` option. ([Bug#37069](#))

- `mysqltest` was changed to be more robust in the case of a race condition that can occur for rapid disconnect/connect sequences with the server. The account used by `mysqltest` could reach its allowed simultaneous-sessions user limit if the connect attempt occurred before the server had fully processed the preceding disconnect. `mysqltest` now checks specifically for a user-limits error when it connects; if that error occurs, it delays briefly before retrying. (Bug#23921)

Bugs fixed:

- **Replication:** Row-based replication broke for `utf8 CHAR` columns longer than 85 characters. (Bug#37426)
- **Replication:** Performing an insert on a table having an `AUTO_INCREMENT` column and an `INSERT` trigger that was being replicated from a master running MySQL 5.0 or any version of MySQL 5.1 up to and including MySQL 5.1.11 to a slave running MySQL 5.1.12 or later caused the replication slave to crash. (Bug#36443)

See also Bug#33029.

- Some binary distributions had a duplicate “-64bit” suffix in the file name. (Bug#37623)
- `NOT IN` subqueries that selected `MIN()` or `MAX()` values but produced an empty result could cause a server crash. (Bug#37004)
- `ha_innodb.so` was incorrectly installed in the `lib/mysql` directory rather than in `lib/mysql/plugin`. (Bug#36434)
- An empty bit-string literal (`b''`) caused a server crash. Now the value is parsed as an empty bit value (which is treated as an empty string in string context or 0 in numeric context). (Bug#35658)
- The code for detecting a byte order mark (BOM) caused `mysql` to crash for empty input. (Bug#35480)
- The `mysql` client incorrectly parsed statements containing the word “delimiter” in mid-statement.

The fix for this bug had the side effect of causing the problem reported in Bug#38158, so it was reverted in MySQL 5.1.27. (Bug#33812)

## C.2.13. Changes in MySQL 5.1.25 (28 May 2008)

Functionality added or changed:

- **Incompatible Change:** A change has been made to the way that the server handles prepared statements. This affects prepared statements processed at the SQL level (using the `PREPARE` statement) and those processed using the binary client-server protocol (using the `mysql_stmt_prepare()` C API function).

Previously, changes to metadata of tables or views referred to in a prepared statement could cause a server crash when the statement was next executed, or perhaps an error at execute time with a crash occurring later. For example, this could happen after dropping a table and recreating it with a different definition.

Now metadata changes to tables or views referred to by prepared statements are detected and cause automatic reparation of the statement when it is next executed. Metadata changes occur for DDL statements such as those that create, drop, alter, rename, or truncate tables, or that analyze, optimize, or repair tables. Reparation also occurs after referenced tables or views are flushed from the table definition cache, either implicitly to make room for new entries in the cache, or explicitly due to `FLUSH TABLES`.

Reparation is automatic, but to the extent that it occurs, performance of prepared statements is diminished.

Table content changes (for example, with `INSERT` or `UPDATE`) do not cause reparation, nor do `SELECT` statements.

An incompatibility with previous versions of MySQL is that a prepared statement may now return a different set of columns or different column types from one execution to the next. For example, if the prepared statement is `SELECT * FROM t1`, altering `t1` to contain a different number of columns causes the next execution to return a number of columns different from the previous execution.

Older versions of the client library cannot handle this change in behavior. For applications that use prepared statements with the new server, an upgrade to the new client library is strongly recommended.

Along with this change to statement reparation, the default value of the `table_definition_cache` system variable has been increased from 128 to 256. The purpose of this increase is to lessen the chance that prepared statements will need reparation due to referred-to tables/views having been flushed from the cache to make room for new entries.

A new status variable, `Com_stmt_reprepare`, has been introduced to track the number of reparations. (Bug#27420,



[Bug#27430](#), [Bug#27690](#))

- **Important Change:** Some changes were made to `CHECK TABLE ... FOR UPGRADE` and `REPAIR TABLE` with respect to detection and handling of tables with incompatible `.frm` files (files created with a different version of the MySQL server). These changes also affect `mysqlcheck` because that program uses `CHECK TABLE` and `REPAIR TABLE`, and thus also `mysql_upgrade` because that program invokes `mysqlcheck`.
  - If your table was created by a different version of the MySQL server than the one you are currently running, `CHECK TABLE ... FOR UPGRADE` indicates that the table has an `.frm` file with an incompatible version. In this case, the result set returned by `CHECK TABLE` contains a line with a `Msg_type` value of `error` and a `Msg_text` value of `Table upgrade required. Please do "REPAIR TABLE `tbl_name`" to fix it!`
  - `REPAIR TABLE` without `USE_FRM` upgrades the `.frm` file to the current version.
  - If you use `REPAIR TABLE ...USE_FRM` and your table was created by a different version of the MySQL server than the one you are currently running, `REPAIR TABLE` will not attempt to repair the table. In this case, the result set returned by `REPAIR TABLE` contains a line with a `Msg_type` value of `error` and a `Msg_text` value of `Failed repairing incompatible .FRM file.`

Previously, use of `REPAIR TABLE ...USE_FRM` with a table created by a different version of the MySQL server risked the loss of all rows in the table.

([Bug#36055](#))

- `mysql_upgrade` now has a `--tmpdir` option to enable the location of temporary files to be specified. ([Bug#36469](#))
- `mysqldump` now adds the `LOCAL` qualifier to the `FLUSH TABLES` statement that is sent to the server when the `--master-data` option is enabled. This prevents the `FLUSH TABLES` statement from replicating to slaves, which is disadvantageous because it would cause slaves to block while the statement executes. ([Bug#35157](#))

See also [Bug#38303](#).

Bugs fixed:

- **Important Change:** The server no longer issues warnings for truncation of excess spaces for values inserted into `CHAR` columns. This reverts a change in the previous release that caused warnings to be issued. ([Bug#30059](#))
- **Replication:** `CREATE PROCEDURE` and `CREATE FUNCTION` statements containing extended comments were not written to the binary log correctly, causing parse errors on the slave. ([Bug#36570](#))

See also [Bug#32575](#).

- **Replication:** When flushing tables, there was a slight chance that the flush occurred between the processing of one table map event and the next. Since the tables were opened one by one, subsequent locking of tables would cause the slave to crash. This problem was observed when replicating `NDBCLUSTER` or `InnoDB` tables, when executing multi-table updates, and when a trigger or a stored routine performed an (additional) insert on a table so that two tables were effectively being inserted into in the same statement. ([Bug#36197](#))
- **Replication:** `CREATE VIEW` statements containing extended comments were not written to the binary log correctly, causing parse errors on the slave. Now, all comments are stripped from such statements before being written to the binary log. ([Bug#32575](#))

See also [Bug#36570](#).

- On Windows 64-bit systems, temporary variables of `long` types were used to store `ulong` values, causing key cache initialization to receive distorted parameters. The effect was that setting `key_buffer_size` to values of 2GB or more caused memory exhaustion to due allocation of too much memory. ([Bug#36705](#))
- Multiple-table `UPDATE` statements that used a temporary table could fail to update all qualifying rows or fail with a spurious duplicate-key error. ([Bug#36676](#))
- A `REGEXP` match could return incorrect rows when the previous row matched the expression and used `CONCAT( )` with an empty string. ([Bug#36488](#))
- `mysqltest` ignored the value of `--tmpdir` in one place. ([Bug#36465](#))
- When updating an existing instance (for example, from MySQL 5.0 to 5.1, or 5.1 to 6.0), the Instance Configuration Wizard unnecessarily prompted for a `root` password when there was an existing `root` password. ([Bug#36305](#))

- Conversion of a `FLOAT ZEROFILL` value to string could cause a server crash if the value was `NULL`. (Bug#36139)
- On Windows, the installer attempted to use JScript to determine whether the target data directory already existed. On Windows Vista x64, this resulted in an error because the installer was attempting to run the JScript in a 32-bit engine, which wasn't registered on Vista. The installer no longer uses JScript but instead relies on a native WiX command. (Bug#36103)
- `mysqltest` was performing escape processing for the `--replace_result` command, which it should not have been. (Bug#36041)
- An error in calculation of the precision of zero-length items (such as `NULL`) caused a server crash for queries that employed temporary tables. (Bug#36023)
- For `EXPLAIN EXTENDED`, execution of an uncorrelated `IN` subquery caused a crash if the subquery required a temporary table for its execution. (Bug#36011)
- The `MERGE` storage engine did a table scan for `SELECT COUNT(*)` statements when it could calculate the number of records from the underlying tables. (Bug#36006)
- The server crashed inside `NOT IN` subqueries with an impossible `WHERE` or `HAVING` clause, such as `NOT IN (SELECT ... FROM t1, t2, ... WHERE 0)`. (Bug#36005)
- The Event Scheduler was not designed to work under the embedded server. It is now disabled for the embedded server, and the `event_scheduler` system variable is not displayed. (Bug#35997)
- Grouping or ordering of long values in unindexed `BLOB` or `TEXT` columns with the `gbk` or `big5` character set crashed the server. (Bug#35993)
- `SET GLOBAL debug=''` resulted in a Valgrind warning in `DbugParse()`, which was reading beyond the end of the control string. (Bug#35986)
- The “prefer full scan on clustered primary key over full scan of any secondary key” optimizer rule introduced by Bug#26447 caused a performance regression for some queries, so it has been disabled. (Bug#35850)
- The server ignored any covering index used for `ref` access of a table in a query with `ORDER BY` if this index was incompatible with the `ORDER BY` list and there was another covering index compatible with this list. As a result, suboptimal execution plans were chosen for some queries that used an `ORDER BY` clause. (Bug#35844)
- `mysql_upgrade` did not properly update the `mysql.event` table. (Bug#35824)
- An incorrect error and message was produced for attempts to create a `MyISAM` table with an index (`.MYI`) file name that was already in use by some other `MyISAM` table that was open at the same time. For example, this might happen if you use the same value of the `INDEX DIRECTORY` table option for tables belonging to different databases. (Bug#35733)
- Enabling the `read_only` system variable while autocommit mode was enabled caused `SELECT` statements for transactional storage engines to fail. (Bug#35732)
- The combination of `GROUP_CONCAT()`, `DISTINCT`, and `LEFT JOIN` could crash the server when the right table is empty. (Bug#35298)
- Some binaries produced stack corruption messages due to being built with versions of `bison` older than 2.1. Builds are now created using `bison` 2.3. (Bug#34926)
- The `log_output` system variable could be set to an illegal value. (Bug#34820)
- On Windows 64-bit builds, an apparent compiler bug caused memory overruns for code in `innobase/mem/*`. Removed optimizations so as not to trigger this problem. (Bug#34297)
- Several additional configuration scripts in the `BUILD` directory now are included in source distributions. These may be useful for users who wish to build MySQL from source. (See Section 2.10.3, “Installing from the Development Source Tree”, for information about what they do.) (Bug#34291)
- Executing a `FLUSH PRIVILEGES` statement after creating a temporary table in the `mysql` database with the same name as one of the MySQL system tables caused the server to crash.

**Note**

While it is possible to shadow a system table in this way, the temporary table exists only for the current user and connection, and does not effect any user privileges. (Bug#33275)

- `UNION` constructs cannot contain `SELECT ... INTO` except in the final `SELECT`. However, if a `UNION` was used in a sub-



query and an `INTO` clause appeared in the top-level query, the parser interpreted it as having appeared in the `UNION` and raised an error. (Bug#32858)

- Assignment of relative path names to `general_log_file` or `slow_query_log_file` did not always work. (Bug#32748)
- The `mysql.servers` table was not created during installation on Windows. (Bug#28680, Bug#32797)
- The `jp` test suite was not working. (Bug#28563)
- The internal `init_time()` library function was renamed to `my_init_time()` to avoid conflicts with external libraries. (Bug#26294)
- The parser used signed rather than unsigned values in some cases that caused legal lengths in column declarations to be rejected. (Bug#15776)

## C.2.14. Changes in MySQL 5.1.24 (08 April 2008)

Functionality added or changed:

- **Important Change: MySQL Cluster: Packaging:** Beginning with this release, standard MySQL 5.1 binaries are no longer built with support for the `NDBCLUSTER` storage engine, and the `NDBCLUSTER` code included in 5.1 mainline sources is no longer guaranteed to be maintained or supported. Those using MySQL Cluster in MySQL 5.1.23 and earlier MySQL 5.1 mainline releases should upgrade to MySQL Cluster NDB 6.2.15 or a later MySQL Cluster NDB 6.2 or 6.3 release. (Bug#36193)
- **Important Change:** The `FEDERATED` storage engine is not included in binary distributions of MySQL 5.1.24. (It will be included again in 5.1.25.)
- **Replication:** Introduced the `slave_exec_mode` system variable to control whether idempotent or strict mode is used for replication conflict resolution. Idempotent mode suppresses duplicate-key, no-key-found, and some other errors, and is needed for circular replication, multi-master replication, and some other complex replication setups when using MySQL Cluster. Strict mode is the default. (Bug#31609)
- **Replication:** When running the server with `--binlog-format=MIXED` or `--binlog-format=STATEMENT`, a query that referred to a system variable used the slave's value when replayed on the slave. This meant that, if the value of a system variable was inserted into a table, the slave differed from the master. Now, statements that refer to a system variable are marked as “unsafe”, which means that:
  - When the server is using `--binlog-format=MIXED`, the row-based format is used automatically to replicate these statements.
  - When the server is using `--binlog-format=STATEMENT`, these statements produce a warning. (Bug#31168)

See also Bug#34732.

- The `PROCESS` privilege now is required to start or stop the `InnoDB` monitor tables (see Section 13.6.13.2, “`SHOW ENGINE INNODB STATUS` and the `InnoDB` Monitors”). Previously, no privilege was required. (Bug#34053)
- For binary `.tar.gz` packages, `mysqld` and other binaries now are compiled with debugging symbols included to enable easier use with a debugger. If you do not need debugging symbols and are short on disk space, you can use `strip` to remove the symbols from the binaries. (Bug#33252)
- Formerly, when the MySQL server crashed, the generated stack dump was numeric and required external tools to properly resolve the names of functions. This is not very helpful to users having a limited knowledge of debugging techniques. In addition, the generated stack trace contained only the names of functions and was formatted differently for each platform due to different stack layouts.

Now it is possible to take advantage of newer versions of the GNU C Library provide a set of functions to obtain and manipulate stack traces from within the program. On systems that use the ELF binary format, the stack trace contains important information such as the shared object where the call was generated, an offset into the function, and the actual return address. Having the function name also makes possible the name demangling of C++ functions.

The library generates meaningful stack traces on the following platforms: i386, x86\_64, PowerPC, IA64, Alpha, and S390. On other platforms, a numeric stack trace is still produced, and the use of the `resolve_stack_dump` utility is still required. (Bug#31891)

- `mysqltest` now has `mkdir` and `rmdir` commands for creating and removing directories. (Bug#31004)

- The server uses less memory when loading privileges containing table grants. (Patch provided by Google.) ([Bug#25175](#))
- Added the `Uptime_since_flush_status` status variable, which indicates the number of seconds since the most recent `FLUSH STATUS` statement. (Community contribution by Jeremy Cole) ([Bug#24822](#))
- `SHOW OPEN TABLES` now supports `FROM` and `LIKE` clauses. ([Bug#12183](#))
- The new read-only global system variables `report_host`, `report_password`, `report_port`, and `report_user` system variables provide runtime access to the values of the corresponding `--report-host`, `--report-password`, `--report-port`, and `--report-user` options.
- Formerly it was possible to specify an `innodb_flush_method` value of `fdatasync` to obtain the default flush behavior of using `fdatasync()` for flushing. This is no longer possible because it can be confusing that a value of `fdatasync` causes use of `fsync()` rather than `fdatasync()`.
- The use of InnoDB hash indexes now can be controlled by setting the new `innodb_adaptive_hash_index` system variable at server startup. By default, this variable is enabled. See [Section 13.6.10.4, “Adaptive Hash Indexes”](#).

#### Bugs fixed:

- **Important Change: Security Fix:** It was possible to circumvent privileges through the creation of `MyISAM` tables employing the `DATA DIRECTORY` and `INDEX DIRECTORY` options to overwrite existing table files in the MySQL data directory. Use of the MySQL data directory in `DATA DIRECTORY` and `INDEX DIRECTORY` is now disallowed. This is now also true of these options when used with partitioned tables and individual partitions of such tables.

#### Note

Additional fixes were made in MySQL 5.1.28.

([Bug#32167](#), [CVE-2008-2079](#))

See also [Bug#39277](#).

- **Security Fix:** A client that connects to a malicious server could be tricked by the server into sending files from the client host to the server. This occurs because the `libmysqlclient` client library would respond to a `FETCH LOCAL FILE` request from the server even if the request is sent for statements from the client other than `LOAD DATA LOCAL INFILE`. The client library has been modified to respond to a `FETCH LOCAL FILE` request from the server only if it is sent in response to a `LOAD DATA LOCAL INFILE` statement from the client.

The client library now also checks whether `CLIENT_LOCAL_FILE` is set and refuses to send a local file if not.

#### Note

Binary distributions ship with the `local-infile` capability enabled. Applications that do not use this functionality should disable it to be safe.

([Bug#29605](#))

- **Important Change: Security Enhancement:** On Windows Vista and Windows Server 2008, a user without administrative privileges does not have write permissions to the `Program Files` directory where MySQL and the associated data files are normally installed. Using data files located in the standard `Program Files` installation directory could therefore cause MySQL to fail, or lead to potential security issues in an installed instance.

To address the problem, on Windows XP, Windows Vista and Windows Server 2008, the datafiles and data file configuration are now set to the Microsoft recommended `AppData` folder. The `AppData` folder is typically located within the user's home directory.

#### Important

When upgrading an existing 5.1.23 or 6.0.4 installation of MySQL you must take a backup of your data and configuration file (`my.ini`) before installing the new version. To migrate your data, either extract the data and re-import (using `mysqldump`, then upgrade and re-import using `mysql`), or back up your data, upgrade to the new version, and copy your existing data files from your old `datadir` directory to the new directory located within `AppData`.

Failure to back up your data and follow these procedures may lead to data loss.

([Bug#34593](#))

- **Incompatible Change:** In MySQL 5.1.23, the `last_errno` and `last_error` members of the `NET` structure in

`mysql_com.h` were renamed to `client_last_errno` and `client_last_error`. This was found to cause problems for connectors that use the internal `NET` structure for error handling. The change has been reverted. (Bug#34655)

See also Bug#12713.

- **Incompatible Change:** It was possible to use `FRAC_SECOND` as a synonym for `MICROSECOND` with `DATE_ADD()`, `DATE_SUB()`, and `INTERVAL`; now, using `FRAC_SECOND` with anything other than `TIMESTAMPADD()` or `TIMESTAMPDIFF()` produces a syntax error.

It is now possible (and preferable) to use `MICROSECOND` with `TIMESTAMPADD()` and `TIMESTAMPDIFF()`, and `FRAC_SECOND` is now deprecated. (Bug#33834)

- **Incompatible Change:** The `UPDATE` statement allowed `NULL` to be assigned to `NOT NULL` columns (the implicit default value for the column data type was assigned). This was changed so that on error occurs.

This change was reverted, because the original report was determined not to be a bug: Assigning `NULL` to a `NOT NULL` column in an `UPDATE` statement should produce an error only in strict SQL mode and set the column to the implicit default with a warning otherwise, which was the original behavior. See Section 10.1.4, “Data Type Default Values”, and Bug#39265. (Bug#33699)

- **Incompatible Change:** For packages that are built within their own prefix (for example, `/usr/local/mysql`) the plugin directory will be `lib/plugin`. For packages that are built to be installed into a system-wide prefix (such as RPM packages with a prefix of `/usr`), the plugin directory will be `lib/mysql/plugin` to ensure a clean `/usr/lib` hierarchy. In both cases, the `$pkglibdir` configuration setting is used at build time to set the plugin directory.

The current plugin directory location is available as the value of the `plugin_dir` system variable as before, but the `mysql_config` script now has a `--plugindir` option that can be used externally to the server by third-party plugin writers to obtain the default plugin directory path name and configure their installation directory appropriately. (Bug#31736)

- **Incompatible Change:** The `utf8_general_ci` and `ucs2_general_ci` collations did not sort the letter "U+00DF SHARP S" equal to 's'.

As a result of this bug fix, indexes must be rebuilt for columns that use the `utf8_general_ci` or `ucs2_general_ci` collation for columns that contain SHARP S. See Section 2.12.3, “Checking Whether Table Indexes Must Be Rebuilt”. (Bug#27877)

See also Bug#37046.

- **Important Change: Replication:** When the master crashed during an update on a transactional table while in `autocommit` mode, the slave failed. This fix causes every transaction (including `autocommit` transactions) to be recorded in the binlog as starting with a `BEGIN` and ending with a `COMMIT` or `ROLLBACK`. (Bug#26395)
- **Important Change:** InnoDB free space information is now shown in the `Data_free` column of `SHOW TABLE STATUS` and in the `DATA_FREE` column of the `INFORMATION_SCHEMA.TABLES` table. (Bug#32440)

See also Bug#11379.

- **Important Change:** The server handled truncation of values having excess trailing spaces into `CHAR`, `VARCHAR`, and `TEXT` columns in different ways. This behavior has now been made consistent for columns of all three of these types, and now follows the existing behavior of `VARCHAR` columns in this regard; that is, a `Note` is always issued whenever such truncation occurs.

This change does not affect columns of these three types when using a binary encoding; `BLOB` columns are also unaffected by the change, since they always use a binary encoding. (Bug#30059)

- **Important Change:** An `AFTER UPDATE` trigger was not invoked when the `UPDATE` did not make any changes to the table for which the trigger was defined. Now `AFTER UPDATE` triggers behave the same in this regard as do `BEFORE UPDATE` triggers, which are invoked whether the `UPDATE` makes any changes in the table or not. (Bug#23771)
- **Partitioning: Important Note:** The following statements did not function correctly with corrupted or crashed tables and have been disabled:

- `ALTER TABLE ... ANALYZE PARTITION`
- `ALTER TABLE ... CHECK PARTITION`
- `ALTER TABLE ... OPTIMIZE PARTITION`
- `ALTER TABLE ... REPAIR PARTITION`

`ALTER TABLE ... REBUILD PARTITION` is unaffected by this change and continues to be available. This statement and

`ALTER TABLE ... REORGANIZE PARTITION` may be used to analyze and optimize partitioned tables, since these operations cause the partition files to be rebuilt. (Bug#20129)

See also Bug#39434.

- **Replication: Important Note:** Network timeouts between the master and the slave could result in corruption of the relay log. This fix rectifies a long-standing replication issue when using unreliable networks, including replication over wide area networks such as the Internet. If you experience reliability issues and see many `YOU HAVE AN ERROR IN YOUR SQL SYNTAX` errors on replication slaves, we strongly recommend that you upgrade to a MySQL version which includes this fix. (Bug#26489)
- **Partitioning:** In some cases, matching rows from a partitioned `MyISAM` using a `BIT` column as the primary key were not found by queries. (Bug#34358)
- **Partitioning:** Enabling `innodb_file_per_table` produced problems with partitioning and tablespace operations on partitioned `InnoDB` tables, in some cases leading to corrupt partitions or causing the server to crash. (Bug#33429)
- **Partitioning:** A table defined using `PARTITION BY KEY` and having a `BIT` column referenced in the partitioning key did not behave correctly; some rows could be inserted into the wrong partition, causing wrong results to be returned from queries. (Bug#33379)
- **Partitioning:** For `InnoDB` tables, there was a race condition involving the data dictionary and repartitioning. (Bug#33349)
- **Partitioning:** When `ALTER TABLE DROP PARTITION` was executed on a table on which there was a trigger, the statement failed with an error. This occurred even if the trigger did not reference any tables. (Bug#32943)
- **Partitioning:** Currently, all partitions of a partitioned table must use the same storage engine. One may optionally specify the storage engine on a per-partition basis; however, where this is the done, the storage engine must be the same as used by the table as a whole. `ALTER TABLE` did not enforce these rules correctly, the result being that inaccurate error messages were shown when trying to use the statement to change the storage engine used by an individual partition or partitions. (Bug#31931)
- **Partitioning:** Using the `DATA DIRECTORY` and `INDEX DIRECTORY` options for partitions with `CREATE TABLE` or `ALTER TABLE` statements appeared to work on Windows, although they are not supported by MySQL on Windows systems, and subsequent attempts to use the tables referenced caused errors. Now these options are disabled on Windows, and attempting to use them generates a warning. (Bug#30459)
- **Replication:** The failure of a `CREATE TABLE ... ENGINE=InnoDB ... SELECT` statement caused the slave to lose data. (Bug#35762)
- **Replication:** When using row-based replication, a slave could crash at startup because it received a row-based replication event that `InnoDB` could not handle due to an incorrect test of the query string provided by MySQL, which was `NULL` for row-based replication events. (Bug#35226)
- **Replication:** `insert_id` was not written to the binary log for inserts into `BLACKHOLE` tables. (Bug#35178)
- **Replication:** When using statement-based replication and a `DELETE, UPDATE, or INSERT ... SELECT` statement using a `LIMIT` clause is encountered, a warning that the statement is not safe to replicate in statement mode is now issued; when using `MIXED` mode, the statement is now replicated using the row-based format. (Bug#34768)
- **Replication:** `mysqlbinlog` did not output the values of `auto_increment_increment` and `auto_increment_offset` when both were equal to their default values (for both of these variables, the default is 1). This meant that a binary log recorded by a client using the defaults for both variables and then replayed on another client using its own values for either or both of these variables produced erroneous results. (Bug#34732)

See also Bug#31168.

- **Replication:** When the Windows version of `mysqlbinlog` read 4.1 binlogs containing `LOAD DATA INFILE` statements, it output backslashes as path separators, causing problems for client programs expecting forward slashes. In such cases, it now converts `\\` to `/` in directory paths. (Bug#34355)
- **Replication:** `SHOW SLAVE STATUS` failed when slave I/O was about to terminate. (Bug#34305)
- **Replication:** The character sets and collations used for constant identifiers in stored procedures were not replicated correctly. (Bug#34289)
- **Replication:** `mysqlbinlog` from a 5.1 or later MySQL distribution could not read binary logs generated by a 4.1 server when the logs contained `LOAD DATA INFILE` statements. (Bug#34141)

This regression was introduced by Bug#32407.

- **Replication:** A `CREATE USER, DROP USER, or RENAME USER` statement that fails on the master, or that is a duplicate of any of these statements, is no longer written to the binlog; previously, either of these occurrences could cause the slave to fail.

([Bug#33862](#))

See also [Bug#29749](#).

- **Replication:** `SHOW BINLOG EVENTS` could fail when the binlog contained one or more events whose size was close to the value of `max_allowed_packet`. ([Bug#33413](#))
- **Replication:** An extraneous `ROLLBACK` statement was written to the binary log by a connection that did not use any transactional tables. ([Bug#33329](#))
- **Replication:** `mysqlbinlog` failed to release all of its memory after terminating abnormally. ([Bug#33247](#))
- **Replication:** When a stored routine or trigger, running on a master that used MySQL 5.0 or MySQL 5.1.11 or earlier, performed an insert on an `AUTO_INCREMENT` column, the `insert_id` value was not replicated correctly to a slave running MySQL 5.1.12 or later (including any MySQL 6.0 release). ([Bug#33029](#))

See also [Bug#19630](#).

- **Replication:** The error message generated due to lack of a default value for an extra column was not sufficiently informative. ([Bug#32971](#))
- **Replication:** When a user variable was used inside an `INSERT` statement, the corresponding binlog event was not written to the binlog correctly. ([Bug#32580](#))
- **Replication:** When using row-based replication, deletes from a table with a foreign key constraint failed on the slave. ([Bug#32468](#))
- **Replication:** The `--base64-output` option for `mysqlbinlog` was not honored for all types of events. This interfered in some cases with performing point-in-time recovery. ([Bug#32407](#))
- **Replication:** SQL statements containing comments using `--` syntax were not replayable by `mysqlbinlog`, even though such statements replicated correctly. ([Bug#32205](#))
- **Replication:** When using row-based replication from a master running MySQL 5.1.21 or earlier to a slave running 5.1.22 or later, updates of integer columns failed on the slave with `ERROR IN UNKNOWN EVENT: ROW APPLICATION FAILED`. ([Bug#31583](#))

This regression was introduced by [Bug#21842](#).

- **Replication:** Replicating write, update, or delete events from a master running MySQL 5.1.15 or earlier to a slave running 5.1.16 or later caused the slave to crash. ([Bug#31581](#))
- **Replication:** When using row-based replication, the slave stopped when attempting to delete non-existent rows from a slave table without a primary key. In addition, no error was reported when this occurred. ([Bug#31552](#))
- **Replication:** Errors due to server ID conflicts were reported only in the slave's error log; now these errors are also shown in the `Server_IO_State` column in the output of `SHOW SLAVE STATUS`. ([Bug#31316](#))
- **Replication:** `STOP SLAVE` did not stop connection attempts properly. If the IO slave thread was attempting to connect, `STOP SLAVE` waited for the attempt to finish, sometimes for a long period of time, rather than stopping the slave immediately. ([Bug#31024](#))

See also [Bug#30932](#).

- **Replication:** Issuing a `DROP VIEW` statement caused replication to fail if the view did not actually exist. ([Bug#30998](#))
- **Replication:** Replication of `LOAD DATA INFILE` could fail when `read_buffer_size` was larger than `max_allowed_packet`. ([Bug#30435](#))
- **Replication:** Replication crashed with the NDB storage engine when `mysqld` was started with `-character-set-server=ucs2`. ([Bug#29562](#))
- **Replication:** The effects of scheduled events were not always correctly reproduced on the slave when using row-based replication. ([Bug#29020](#))
- **Replication:** Setting `server_id` did not update its value for the current session. ([Bug#28908](#))
- **Replication:** Some older servers wrote events to the binary log using different numbering from what is currently used, even though the file format number in the file is the same. Slaves running MySQL 5.1.18 and later could not read these binary logs properly. Binary logs from these older versions now are recognized and event numbers are mapped to the current numbering so

that they can be interpreted properly. ([Bug#27779](#), [Bug#32434](#))

This regression was introduced by [Bug#22583](#).

- **Replication:** `MASTER_POS_WAIT()` did not return `NULL` when the server was not a slave. ([Bug#26622](#))
- **Replication:** The inspecific error message `WRONG PARAMETERS TO FUNCTION REGISTER_SLAVE` resulted when `START SLAVE` failed to register on the master due to excess length of any the slave server options `--report-host`, `--report-user`, or `--report-password`. An error message specific to each of these options is now returned in such cases. The new error messages are:
  - `FAILED TO REGISTER SLAVE: TOO LONG 'REPORT-HOST'`
  - `FAILED TO REGISTER SLAVE: TOO LONG 'REPORT-USER'`
  - `FAILED TO REGISTER SLAVE; TOO LONG 'REPORT-PASSWORD'`([Bug#22989](#))

See also [Bug#19328](#).

- **Replication:** `START SLAVE UNTIL MASTER_LOG_POS=position` issued on a slave that was using `-log-slave-updates` and that was involved in circular replication would cause the slave to run and stop one event later than that specified by the value of `position`. ([Bug#13861](#))
- **Replication:** `PURGE BINARY LOGS TO` and `PURGE BINARY LOGS BEFORE` did not handle missing binary log files correctly or in the same way. Now for both of these statements, if any files listed in the `.index` file are missing from the file system, the statement fails with an error.
- Manually replacing a binary log file with a directory having the same name caused an error that was not handled correctly. ([Bug#35675](#))
- Using `LOAD DATA INFILE` with a view could crash the server. ([Bug#35469](#))
- Selecting from `INFORMATION_SCHEMA.REFERENTIAL_CONSTRAINTS` could cause a server crash. ([Bug#35406](#))

See also [Bug#35108](#).

- For a `TEMPORARY` table, `DELETE` with no `WHERE` clause could fail when preceded by `DELETE` statements with a `WHERE` clause. ([Bug#35392](#))
- If the server crashed with an `InnoDB` error due to unavailability of undo slots, errors could persist during rollback when the server was restarted: There are two `UNDO` slot caches (for `INSERT` and `UPDATE`). If all slots end up in one of the slot caches, a request for a slot from the other slot cache would fail. This can happen if the request is for an `UPDATE` slot and all slots are in the `INSERT` slot cache, or vice versa. ([Bug#35352](#))
- In some cases, when too many clients tried to connect to the server, the proper `SQLSTATE` code was not returned. ([Bug#35289](#))
- Memory-allocation failures for attempts to set `key_buffer_size` to large values could result in a server crash. ([Bug#35272](#))
- For `InnoDB` tables, `ALTER TABLE DROP` failed if the name of the column to be dropped began with “foreign”. ([Bug#35220](#))
- Queries could return different results depending on whether `ORDER BY` columns were indexed. ([Bug#35206](#))
- When a view containing a reference to `DUAL` was created, the reference was removed when the definition was stored, causing some queries against the view to fail with invalid SQL syntax errors. ([Bug#35193](#))
- `SELECT ... FROM INFORMATION_SCHEMA.REFERENTIAL_CONSTRAINTS` caused the server to crash if the table referenced by a foreign key had been dropped. This issue was observed on Windows platforms only. ([Bug#35108](#))

See also [Bug#35406](#).

- Debugging symbols were missing for some executables in Windows binary distributions. ([Bug#35104](#))
- Non-connection threads were being counted in the value of the `Max_used_connections` status variable. ([Bug#35074](#))
- A query that performed a `ref_or_null` join where the second table used a key having one or columns that could be `NULL` and had a column value that was `NULL` caused the server to crash. ([Bug#34945](#))

This regression was introduced by [Bug#12144](#).

- For some queries, the optimizer used an ordered index scan for `GROUP BY` or `DISTINCT` when it was supposed to use a loose



index scan, leading to incorrect results. (Bug#34928)

- Creating a foreign key on an `InnoDB` table that was created with an explicit `AUTO_INCREMENT` value caused that value to be reset to 1. (Bug#34920)
- `mysqldump` failed to return an error code when using the `--master-data` option without binary logging being enabled on the server. (Bug#34909)
- Under some circumstances, the value of `mysql_insert_id()` following a `SELECT ... INSERT` statement could return an incorrect value. This could happen when the last `SELECT ... INSERT` did not involve an `AUTO_INCREMENT` column, but the value of `mysql_insert_id()` was changed by some previous statements. (Bug#34889)
- Table and database names were mixed up in some places of the subquery transformation procedure. This could affect debugging trace output and further extensions of that procedure. (Bug#34830)
- If `fsync()` returned `ENOLCK`, `InnoDB` could treat this as fatal and cause abnormal server termination. `InnoDB` now retries the operation. (Bug#34823)
- `CREATE SERVER` and `ALTER SERVER` could crash the server if out-of-memory conditions occurred. (Bug#34790)
- `DROP SERVER` does not release memory cached for server structures created by `CREATE SERVER`, so repeated iterations of these statements resulted in a memory leak. `FLUSH PRIVILEGES` now releases the memory allocated for `CREATE SERVER`. (Bug#34789)
- A malformed URL used for a `FEDERATED` table's `CONNECTION` option value in a `CREATE TABLE` statement was not handled correctly and could crash the server. (Bug#34788)
- Queries such as `SELECT ROW(1, 2) IN (SELECT t1.a, 2) FROM t1 GROUP BY t1.a` (combining row constructors and subqueries in the `FROM` clause) could lead to assertion failure or unexpected error messages. (Bug#34763)
- Using `NAME_CONST()` with a negative number and an aggregate function caused MySQL to crash. This could also have a negative impact on replication. (Bug#34749)
- A memory-handling error associated with use of `GROUP_CONCAT()` in subqueries could result in a server crash. (Bug#34747)
- For an indexed integer column `col_name` and a value `N` that is one greater than the maximum value allowed for the data type of `col_name`, conditions of the form `WHERE col_name < N` failed to return rows where the value of `col_name` is `N - 1`. (Bug#34731)
- A server running with the `--debug` option could attempt to dereference a null pointer when opening tables, resulting in a crash. (Bug#34726)
- Assigning an “incremental” value to the `debug` system variable did not add the new value to the current value. For example, if the current `debug` value was `'T'`, the statement `SET debug = '+P'` resulted in a value of `'P'` rather than the correct value of `'P:T'`. (Bug#34678)
- For debug builds, reading from `INFORMATION_SCHEMA.TABLES` or `INFORMATION_SCHEMA.COLUMNS` could cause assertion failures. This could happen under rare circumstances when `INFORMATION_SCHEMA` fails to get information about a table (for example, when a connection is killed). (Bug#34656)
- Executing a `TRUNCATE` statement on a table having both a foreign key reference and a `DELETE` trigger crashed the server. (Bug#34643)
- Some subqueries using an expression that included an aggregate function could fail or in some cases lead to a crash of the server. (Bug#34620)
- Dangerous pointer arithmetic crashed the server on some systems. (Bug#34598)
- Creating a view inside a stored procedure could lead to a crash of the MySQL Server. (Bug#34587)
- A server crash could occur if `INFORMATION_SCHEMA` tables built in memory were swapped out to disk during query execution. (Bug#34529)
- `CAST(AVG(arg) AS DECIMAL)` produced incorrect results for non-`DECIMAL` arguments. (Bug#34512)
- The per-thread debugging settings stack was not being deallocated before thread termination, resulting in a stack memory leak. (Bug#34424)
- Executing an `ALTER VIEW` statement on a table crashed the server. (Bug#34337)
- `InnoDB` could crash if overflow occurred for an `AUTO_INCREMENT` column. (Bug#34335)

- For InnoDB, exporting and importing a table could corrupt TINYBLOB columns, and a subsequent ALTER TABLE could corrupt TINYTEXT columns as well. (Bug#34300)
  - DEFAULT 0 was not allowed for the YEAR data type. (Bug#34274)
  - Under some conditions, a SET GLOBAL innodb\_commit\_concurrency or SET GLOBAL innodb\_autoextend\_increment statement could fail. (Bug#34223)
  - mysqldump attempts to set the character\_set\_results system variable after connecting to the server. This failed for pre-4.1 servers that have no such variable, but mysqldump did not account for this and 1) failed to dump database contents; 2) failed to produce any error message alerting the user to the problem. (Bug#34192)
  - Use of stored functions in the WHERE clause for SHOW OPEN TABLES caused a server crash. (Bug#34166)
  - For a FEDERATED table with an index on a nullable column, accessing the table could crash a server, return an incorrect result set, or return ERROR 1030 (HY000): Got error 1430 from storage engine. (Bug#33946)
  - Passing anything other than an integer to a LIMIT clause in a prepared statement would fail. (This limitation was introduced to avoid replication problems; for example, replicating the statement with a string argument would cause a parse failure in the slave). Now, arguments to the LIMIT clause are converted to integer values, and these converted values are used when logging the statement. (Bug#33851)
  - An internal buffer in mysql was too short. Overextending it could cause stack problems or segmentation violations on some architectures. (This is not a problem that could be exploited to run arbitrary code.) (Bug#33841)
  - A query using WHERE (column1='string1' AND column2=constant1) OR (column1='string2' AND column2=constant2), where coll used a binary collation and string1 matched string2 except for case, failed to match any records even when matches were found by a query using the equivalent clause WHERE column2=constant1 OR column2=constant2. (Bug#33833)
  - Large unsigned integers were improperly handled for prepared statements, resulting in truncation or conversion to negative numbers. (Bug#33798)
  - Reuse of prepared statements could cause a memory leak in the embedded server. (Bug#33796)
  - The server crashed when executing a query that had a subquery containing an equality X=Y where Y referred to a named select list expression from the parent select. The server crashed when trying to use the X=Y equality for ref-based access. (Bug#33794)
  - Some queries using a combination of IN, CONCAT( ), and an implicit type conversion could return an incorrect result. (Bug#33764)
  - In some cases a query that produced a result set when using ORDER BY ASC did not return any results when this was changed to ORDER BY DESC. (Bug#33758)
  - Disabling concurrent inserts caused some cacheable queries not to be saved in the query cache. (Bug#33756)
  - ORDER BY ... DESC sorts could produce misordered results. (Bug#33697)
  - The server could crash when REPEAT or another control instruction was used in conjunction with labels and a LEAVE instruction. (Bug#33618)
  - The parser allowed control structures in compound statements to have mismatched beginning and ending labels. (Bug#33618)
  - make\_binary\_distribution passed the --print-libgcc-file option to the C compiler, but this does not work with the ICC compiler. (Bug#33536)
  - Threads created by the event scheduler were incorrectly counted against the max\_connections thread limit, which could lead to client lockout. (Bug#33507)
  - Dropping a function after dropping the function's creator could cause the server to crash. (Bug#33464)
  - Certain combinations of views, subselects with outer references and stored routines or triggers could cause the server to crash. (Bug#33389)
  - SET GLOBAL myisam\_max\_sort\_file\_size=DEFAULT set myisam\_max\_sort\_file\_size to an incorrect value. (Bug#33382)
- See also Bug#31177.
- ENUM- or SET-valued plugin variables could not be set from the command line. (Bug#33358)



- Loading plugins via command-line options to `mysqld` could cause an assertion failure. (Bug#33345)
- `SLEEP(0)` failed to return on 64-bit Mac OS X due to a bug in `pthread_cond_timedwait()`. (Bug#33304)
- Using **Control-R** in the `mysql` client caused it to crash. (Bug#33288)
- For `MyISAM` tables, `CHECK TABLE` (non-`QUICK`) and any form of `REPAIR TABLE` incorrecly treated rows as corrupted under the combination of the following conditions:
  - The table had dynamic row format
  - The table had a `CHAR` (not `VARCHAR`) column longer than 127 bytes (for multi-byte character sets this could be less than 127 characters)
  - The table had rows with a significant length of more than 127 bytes significant length in that `CHAR` column (that is, a byte beyond byte position 127 must be a non-space character)

This problem affected `CHECK TABLE`, `REPAIR TABLE`, `OPTIMIZE TABLE`, `ALTER TABLE`. `CHECK TABLE` reported and marked the table as crashed if any row was present that fulfilled the third condition. The other statements deleted these rows. (Bug#33222)

- Granting the `UPDATE` privilege on one column of a view caused the server to crash. (Bug#33201)
- For `DECIMAL` columns used with the `ROUND(X,D)` or `TRUNCATE(X,D)` function with a non-constant value of `D`, adding an `ORDER BY` for the function result produced misordered output. (Bug#33143)

See also Bug#33402, Bug#30617.

- The `CSV` engine did not honor update requests for `BLOB` columns when the new column value had the same length as the value to be updated. (Bug#33067)
- After receiving a `SIGHUP` signal, the server could crash, and user-specified log options were ignored when reopening the logs. (Bug#33065)
- When MySQL was built with OpenSSL, the SSL library was not properly initialized with information of which endpoint it was (server or client), causing connection failures. (Bug#33050)
- Under some circumstances a combination of aggregate functions and `GROUP BY` in a `SELECT` query over a view could lead to incorrect calculation of the result type of the aggregate function. This in turn could lead to incorrect results, or to crashes on debug builds of the server. (Bug#33049)
- For `DISTINCT` queries, 4.0 and 4.1 stopped reading joined tables as soon as the first matching row was found. However, this optimization was lost in MySQL 5.0, which instead read all matching rows. This fix for this regression may result in a major improvement in performance for `DISTINCT` queries in cases where many rows match. (Bug#32942)

- Repeated creation and deletion of views within prepared statements could eventually crash the server. (Bug#32890)

See also Bug#34587.

- Incorrect assertions could cause a server crash for `DELETE` triggers for transactional tables. (Bug#32790)
- In some cases where setting a system variable failed, no error was sent to the client, causing the client to hang. (Bug#32757)
- Enabling the `PAD_CHAR_TO_FULL_LENGTH` SQL mode caused privilege-loading operations (such as `FLUSH PRIVILEGES`) to include trailing spaces from grant table values stored in `CHAR` columns. Authentication for incoming connections failed as a result. Now privilege loading does not include trailing spaces, regardless of SQL mode. (Bug#32753)
- The `SHOW ENGINE INNODB STATUS` and `SHOW ENGINE INNODB MUTEX` statements incorrecly required the `SUPER` privilege rather than the `PROCESS` privilege. (Bug#32710)
- Inserting strings with a common prefix into a table that used the `ucs2` character set corrupted the table. (Bug#32705)
- Tables in the `mysql` database that stored the current `sql_mode` value as part of stored program definitions were not updated with newer mode values (`NO_ENGINE_SUBSTITUTION`, `PAD_CHAR_TO_FULL_LENGTH`). This causes various problems defining stored programs if those modes were included in the current `sql_mode` value. (Bug#32633)
- A view created with a string literal for one of the columns picked up the connection character set, but not the collation. Comparison to that field therefore used the default collation for that character set, causing an error if the connection collation was not compatible with the default collation. The problem was caused by text literals in a view being dumped with a character set introducer even when this was not necessary, sometimes leading to a loss of collation information. Now the character set introducer is dumped only if it was included in the original query. (Bug#32538)

See also [Bug#21505](#).

- Queries using `LIKE` on tables having indexed `CHAR` columns using either of the `euojpms` or `ujis` character sets did not return correct results. ([Bug#32510](#))
- Executing a prepared statement associated with a materialized cursor sent to the client a metadata packet with incorrect table and database names. The problem occurred because the server sent the name of the temporary table used by the cursor instead of the table name of the original table.  
  
The same problem occurred when selecting from a view, in which case the name of the table name was sent, rather than the name of the view. ([Bug#32265](#))
- `InnoDB` adaptive hash latches could be held too long, resulting in a server crash. This fix may also provide significant performance improvements on systems on which many queries using `filesort` with temporary tables are being performed. ([Bug#32149](#))
- On Windows, `mysqltest_embedded.exe` did not properly execute the `send` command. ([Bug#32044](#))
- A variable named `read_only` could be declared even though that is a reserved word. ([Bug#31947](#))
- On Windows, the build process failed with four parallel build threads. ([Bug#31929](#))
- Queries testing numeric constants containing leading zeroes against `ZEROFILL` columns were not evaluated correctly. ([Bug#31887](#))
- If an error occurred during file creation, the server sometimes did not remove the file, resulting in an unused file in the file system. ([Bug#31781](#))
- The `mysqld` crash handler failed on Windows. ([Bug#31745](#))
- When upgrading from MySQL 5.1.19 to any version between MySQL 5.1.20 to MySQL 5.1.23, the MySQL Instance Configuration Wizard would fail to account for the change in name for the `mysqld-nt.exe` to `mysqld.exe`, causing MySQL to fail to start properly after the upgrade. ([Bug#31674](#))
- The server returned the error message `OUT OF MEMORY; RESTART SERVER AND TRY AGAIN` when the actual problem was that the sort buffer was too small. Now an appropriate error message is returned in such cases. ([Bug#31590](#))
- A table having an index that included a `BLOB` or `TEXT` column, and that was originally created with a MySQL server using version 4.1 or earlier, could not be opened by a 5.1 or later server. ([Bug#31331](#))
- The `-`, `*`, and `/` operators and the functions `POW()` and `EXP()` could misbehave when used with floating-point numbers. Previously they might return `+INF`, `-INF`, or `NaN` in cases of numeric overflow (including that caused by division by zero) or when invalid arguments were used. Now `NULL` is returned in all such cases. ([Bug#31236](#))
- The `mysql_change_user()` C API function caused global `Com_XXX` status variable values to be incorrect. ([Bug#31222](#))
- When sorting privilege table rows, the server treated escaped wildcard characters (`\%` and `\_`) the same as unescaped wildcard characters (`%` and `_`), resulting in incorrect row ordering. ([Bug#31194](#))
- On Windows, `SHOW PROCESSLIST` could display process entries with a `State` value of `*** DEAD ***`. ([Bug#30960](#))
- `ROUND(X,D)` or `TRUNCATE(X,D)` for non-constant values of `D` could crash the server if these functions were used in an `ORDER BY` that was resolved using `filesort`. ([Bug#30889](#))
- Resetting the query cache by issuing a `SET GLOBAL query_cache_size=0` statement caused the server to crash if it concurrently was saving a new result set to the query cache. ([Bug#30887](#))
- Manifest problems prevented `MySQLInstanceConfig.exe` from running on Windows Vista. ([Bug#30823](#))
- If an alias was used to refer to the value returned by a stored function within a subselect, the outer select recognized the alias but failed to retrieve the value assigned to it in the subselect. ([Bug#30787](#))
- Binary logging for a stored procedure differed depending on whether or not execution occurred in a prepared statement. ([Bug#30604](#))
- An orphaned PID file from a no-longer-running process could cause `mysql.server` to wait for that process to exit even though it does not exist. ([Bug#30378](#))
- The `Table_locks_waited` waited variable was not incremented in the cases that a lock had to be waited for but the waiting thread was killed or the request was aborted. ([Bug#30331](#))

- The `Com_create_function` status variable was not incremented properly. (Bug#30252)
- View metadata returned from `INFORMATION_SCHEMA.VIEWS` was changed by the fix for Bug#11986, causing the information returned in MySQL 5.1 to differ from that returned in 5.0. (Bug#30217)
- `mysqld` displayed the `--enable-pstack` option in its help message even if MySQL was configured without `--with-pstack`. (Bug#29836)
- The `mysql_config` command would output `CFLAGS` values that were incompatible with C++ for the HP-UX platform. (Bug#29645)
- Views were treated as insertable even if some base table columns with no default value were omitted from the view definition. (This is contrary to the condition for insertability that a view must contain all columns in the base table that do not have a default value.) (Bug#29477)
- `myisamchk` always reported the character set for a table as `latin1_swedish_ci (8)` regardless of the table's actual character set. (Bug#29182)
- `InnoDB` could return an incorrect rows-updated value for `UPDATE` statements. (Bug#29157)
- The MySQL preferences pane did not work to start or stop MySQL on Mac OS X 10.5 (Leopard). (Bug#28854)
- For upgrading to a new major version using RPM packages (such as 4.1 to 5.0), if the installation procedure found an existing MySQL server running, it could fail to shut down the old server, but also erroneously removed the server's socket file. Now the procedure checks for an existing server package from a different vendor or major MySQL version. In such case, it refuses to install the server and recommends how to safely remove the old packages before installing the new ones. (Bug#28555)
- `mysqlhotcopy` silently skipped databases with names consisting of two alphanumeric characters. (Bug#28460)
- No information was written to the general query log for the `COM_STMT_CLOSE`, `COM_STMT_RESET`, and `COM_STMT_SEND_LONG_DATA` commands. (These occur when a client invokes the `mysql_stmt_close()`, `mysql_stmt_reset()` and `mysql_stmt_send_long_data()` C API functions.) (Bug#28386)
- Previously, the parser accepted the ODBC `{ OJ ... LEFT OUTER JOIN ... }` syntax for writing left outer joins. The parser now allows `{ OJ ... }` to be used to write other types of joins, such as `INNER JOIN` or `RIGHT OUTER JOIN`. This helps with compatibility with some third-party applications, but is not official ODBC syntax. (Bug#28317)
- The `FEDERATED` storage engine did not perform identifier quoting for column names that are reserved words when sending statements to the remote server. (Bug#28269)
- The SQL parser did not accept an empty `UNION=()` clause. This meant that, when there were no underlying tables specified for a `MERGE` table, `SHOW CREATE TABLE` and `mysqldump` both output statements that could not be executed.  
  
Now it is possible to execute a `CREATE TABLE` or `ALTER TABLE` statement with an empty `UNION=()` clause. However, `SHOW CREATE TABLE` and `mysqldump` do not output the `UNION=()` clause if there are no underlying tables specified for a `MERGE` table. This also means it is now possible to remove the underlying tables for a `MERGE` table using `ALTER TABLE ... UNION=()`. (Bug#28248)
- It was possible to exhaust memory by repeatedly running `index_merge` queries and never performing any `FLUSH TABLES` statements. (Bug#27732)
- When `utf8` was set as the connection character set, using `SPACE()` with a non-Unicode column produced an error. (Bug#27580)  
  
See also Bug#23637.
- The parser rules for the `SHOW PROFILE` statement were revised to work with older versions of `bison`. (Bug#27433)
- `resolveip` failed to produce correct results for host names that begin with a digit. (Bug#27427)
- In `ORDER BY` clauses, mixing aggregate functions and non-grouping columns is not allowed if the `ONLY_FULL_GROUP_BY` SQL mode is enabled. However, in some cases, no error was thrown because of insufficient checking. (Bug#27219)
- For the `--record_log_pos` option, `mysqlhotcopy` now determines the slave status information from the result of `SHOW SLAVE STATUS` by using the `Relay_Master_Log_File` and `Exec_Master_Log_Pos` values rather than the `Master_Log_File` and `Read_Master_Log_Pos` values. This provides a more accurate indication of slave execution relative to the master. (Bug#27101)
- The MySQL Instance Configuration Wizard would not allow you to choose a service name, even though the criteria for the service name were valid. The code that checks the name has been updated to support the correct criteria of any string less than 256 character and not containing either a forward or backward slash character. (Bug#27013)

- Memory corruption, a crash of the MySQL server, or both, could take place if a low-level I/O error occurred while an `ARCHIVE` table was being opened. (Bug#26978)
- `DROP DATABASE` failed for attempts to drop databases with names that contained the legacy `#mysql150#` name prefix. (Bug#26703)
- `config-win.h` unconditionally defined `bool` as `BOOL`, causing problems on systems where `bool` is 1 byte and `BOOL` is 4 bytes. (Bug#26461)
- On Windows, for distributions built with debugging support, `mysql` could crash if the user typed Control-C. (Bug#26243)
- The XPath `boolean()` function did not cast string and nodeset values correctly in some cases. It now returns `TRUE` for any non-empty string or nodeset and 0 for a `NULL` string, as specified in the XPath standard.. (Bug#26051)
- When symbolic links were disabled, either with a server startup option or by enabling the `NO_DIR_IN_CREATE` SQL mode, `CREATE TABLE` silently ignored the `DATA DIRECTORY` and `INDEX DIRECTORY` table options. Now the server issues a warning if symbolic links are disabled when these table options are used. (Bug#25677)
- Attempting to create an index with a prefix on a `DECIMAL` column appeared to succeed with an inaccurate warning message. Now, this action fails with the error `INCORRECT PREFIX KEY; THE USED KEY PART ISN'T A STRING, THE USED LENGTH IS LONGER THAN THE KEY PART, OR THE STORAGE ENGINE DOESN'T SUPPORT UNIQUE PREFIX KEYS.` (Bug#25426)
- `mysqlcheck -A -r` did not correctly identify all tables that needed repairing. (Bug#25347)
- On Windows, an error in `configure.js` caused installation of source distributions to fail. (Bug#25340)
- The `Qcache_free_blocks` status variable did not display a value of 0 if the query cache was disabled. (Bug#25132)
- The client library had no way to return an error if no connection had been established. This caused problems such as `mysql_library_init()` failing silently if no `errmsg.sys` file was available. (Bug#25097)
- On Mac OS X, the StartupItem for MySQL did not work. (Bug#25008)
- For Windows 64-bit builds, enabling shared-memory support caused client connections to fail. (Bug#24992)
- `mysql` did not use its completion table. Also, the table contained few entries. (Bug#24624)
- If a user installed MySQL Server and set a password for the `root` user, and then uninstalled and reinstalled MySQL Server to the same location, the user could not use the MySQL Instance Config wizard to configure the server because the uninstall operation left the previous data directory intact. The config wizard *assumed* that any new install (not an upgrade) would have the default data directory where the `root` user has no password. The installer now writes a registry key named `FoundExistingDataDir`. If the installer finds an existing data directory, the key will have a value of 1, otherwise it will have a value of 0. When `MySQLInstanceConfig.exe` is run, it will attempt to read the key. If it can read the key, and the value is 1 and there is no existing instance of the server (indicating a new installation), the Config Wizard will allow the user to input the old password so the server can be configured. (Bug#24215)
- Logging of statements to log tables was incorrect for statements that contained `utf8`-incompatible binary strings. Incompatible sequences are hex-encoded now. (Bug#23924)
- The MySQL header files contained some duplicate macro definitions that could cause compilation problems. (Bug#23839)
- `SHOW COLUMNS` on a `TEMPORARY` table caused locking issues. (Bug#23588)
- For distributions compiled with the bundled `libedit` library, there were difficulties using the `mysql` client to enter input for non-ASCII or multi-byte characters. (Bug#23097)
- `pererror` reported incomplete or inaccurate information. (Bug#23028, Bug#25177)
- `InnoDB` exhibited thread thrashing with more than 50 concurrent connections under an update-intensive workload. (Bug#22868)
- After stopping and starting the event scheduler, disabled events could remain in the execution queue. (Bug#22738)
- The server produced a confusing error message when attempting to open a table that required a storage engine that was not loaded. (Bug#22708)
- For views or stored programs created with an invalid `DEFINER` value, the error message was confusing (did not tie the problem to the `DEFINER` clause) and has been improved. (Bug#21854)
- Warnings for deprecated syntax constructs used in stored routines make sense to report only when the routine is being created, but they were also being reported when the routine was parsed for loading into the execution cache. Now they are reported only

at routine creation time. ([Bug#21801](#))

- On Mac OS X, `mysqld` did not react to Ctrl-C when run under `gdb`, even when run with the `--gdb` option. ([Bug#21567](#))
- `CREATE ... SELECT` did not always set `DEFAULT` column values in the new table. ([Bug#21380](#))
- `mysql_config` output did not include `-lmygcc` on some platforms when it was needed. ([Bug#21158](#))
- `mysql-stress-test.pl` and `mysqld_multi.server.sh` were missing from some binary distributions. ([Bug#21023](#), [Bug#25486](#))
- The `BENCHMARK()` function, invoked with more than 2147483648 iterations (the size of a signed 32-bit integer), terminated prematurely. ([Bug#20752](#))
- `mysqldumpslow` returned a confusing error message when no configuration file was found. ([Bug#20455](#))
- `MySQLInstanceConfig.exe` could lose the `innodb_data_home_dir` setting when reconfiguring an instance. ([Bug#19797](#))
- `DROP DATABASE` did not drop orphaned `FOREIGN KEY` constraints. ([Bug#18942](#))
- `CREATE TABLE` allowed 0 as the default value for a `TIMESTAMP` column when the server was running in `NO_ZERO_DATE` mode. ([Bug#18834](#))
- A `SET` column whose definition specified 64 elements could not be updated using integer values. ([Bug#15409](#))
- If a `SELECT` calls a stored function in a transaction, and a statement within the function fails, that statement should roll back. Furthermore, if `ROLLBACK` is executed after that, the entire transaction should be rolled back. Before this fix, the failed statement did not roll back when it failed (even though it might ultimately get rolled back by a `ROLLBACK` later that rolls back the entire transaction). ([Bug#12713](#))

See also [Bug#34655](#).

- The parser incorrectly allowed `SQLSTATE '00000'` to be specified for a condition handler. (This is incorrect because the condition must be a failure condition and `'00000'` indicates success.) ([Bug#8759](#))
- `MySQLInstanceConfig.exe` did not save the `innodb_data_home_dir` value to the `my.ini` file under certain circumstances. ([Bug#6627](#))

## C.2.15. Changes in MySQL 5.1.23 (29 January 2008)

Functionality added or changed:

- **Important Change: Partitioning: Security Fix:** It was possible, by creating a partitioned table using the `DATA DIRECTORY` and `INDEX DIRECTORY` options to gain privileges on other tables having the same name as the partitioned table. As a result of this fix, any table-level `DATA DIRECTORY` or `INDEX DIRECTORY` options are now ignored for partitioned tables. ([Bug#32091](#), [CVE-2007-5970](#))

See also [Bug#29325](#), [Bug#32111](#).

- **Incompatible Change:** In MySQL 5.1.6, when log tables were implemented, the default log destination for the general query and slow query log was `TABLE`. This default has been changed to `FILE`, which is compatible with MySQL 5.0, but incompatible with earlier releases of MySQL 5.1 from 5.1.6 to 5.1.20. If you are upgrading from MySQL 5.0 to 5.1.21 or higher, no logging option changes should be necessary. However, if you are upgrading from 5.1.6 through 5.1.20 to 5.1.21 or higher and were using `TABLE` logging, use the `--log-output=TABLE` option explicitly to preserve your server's table-logging behavior.

The MySQL 5.1.23 fix is in addition to a fix in 5.1.21 because it turned out that the default was set in two places, only one of which was fixed the first time. ([Bug#29993](#))

- **Incompatible Change**

The parser accepted statements that contained `/* ... */` that were not properly closed with `*/`, such as `SELECT 1 /* + 2`. Statements that contain unclosed `/*`-comments now are rejected with a syntax error.

This fix has the potential to cause incompatibilities. Because of [Bug#26302](#), which caused the trailing `*/` to be truncated from comments in views, stored routines, triggers, and events, it is possible that objects of those types may have been stored with definitions that now will be rejected as syntactically invalid. Such objects should be dropped and re-created so that their definitions do not contain truncated comments. ([Bug#28779](#))

- **MySQL Cluster:** The following improvements have been made in the `ndb_size.pl` utility:
  - The script can now be used with multiple databases; lists of databases and tables can also be excluded from analysis.
  - Schema name information has been added to index table calculations.
  - The database name is now an optional parameter, the exclusion of which causes all databases to be examined.
  - If selecting from `INFORMATION_SCHEMA` fails, the script now attempts to fall back to `SHOW TABLES`.
  - A `--real_table_name` option has been added; this designates a table to handle unique index size calculations.
  - The report title has been amended to cover cases where more than one database is being analyzed.Support for a `--socket` option was also added.  
For more information, see `ndb_size.pl`. ([Bug#28683](#), [Bug#28253](#))
- **MySQL Cluster:** Mapping of NDB error codes to MySQL storage engine error codes has been improved. ([Bug#28423](#))
- **MySQL Cluster:** The output from the cluster management client showing the progress of data node starts has been improved. ([Bug#23354](#))
- **Partitioning:** Error messages for partitioning syntax errors have been made more descriptive. ([Bug#29368](#))
- **Replication:** Replication of the following SQL functions now switches to row-based logging in `MIXED` mode, and generates a warning in `STATEMENT` mode:
  - `USER()`
  - `CURRENT_USER()` and its alias `CURRENT_USER`
  - `FOUND_ROWS()`
  - `ROW_COUNT()`See [Section 5.2.4.3, “Mixed Binary Logging Format”](#), for more information. ([Bug#12092](#), [Bug#28086](#), [Bug#30244](#))
- `mysqltest` now has a `change_user` command to change the user for the current connection. (It invokes the `mysql_change_user()` C API function.) ([Bug#31608](#))
- `mysql-test-run.pl` now allows a suite name prefix to be specified in command-line arguments that name test cases. The test name syntax now is `[suite_name.]test_name[.suffix]`. For example, `mysql-test-run.pl binlog.mytest` runs the `mytest.test` test in the `binlog` test suite. ([Bug#31400](#))
- The `--event-scheduler` option without a value disabled the event scheduler. Now it enables the event scheduler. ([Bug#31332](#))
- `mysqldump` produces a `-- Dump completed on DATE` comment at the end of the dump if `--comments` is given. The date causes dump files for identical data take at different times to appear to be different. The new options `--dump-date` and `--skip-dump-date` control whether the date is added to the comment. `--skip-dump-date` suppresses date printing. The default is `--dump-date` (include the date in the comment). ([Bug#31077](#))
- Server parser performance was improved for expression parsing by lowering the number of state transitions and reductions needed. ([Bug#30625](#))
- Server parser performance was improved for identifier lists, expression lists, and UDF expression lists. ([Bug#30333](#))
- Server parser performance was improved for boolean expressions. ([Bug#30237](#))
- The `LAST_EXECUTED` column of the `INFORMATION_SCHEMA.EVENTS` table now indicates when the event started executing rather than when it finished executing. As a result, the `ENDS` column is never less than `LAST_EXECUTED`. ([Bug#29830](#))
- The `mysql_odbc_escape_string()` C API function has been removed. It has multi-byte character escaping issues, doesn't honor the `NO_BACKSLASH_ESCAPES` SQL mode and is not needed anymore by Connector/ODBC as of 3.51.17. ([Bug#29592](#))
- If a `MyISAM` table is created with no `DATA DIRECTORY` option, the `.MYD` file is created in the database directory. By default, if `MyISAM` finds an existing `.MYD` file in this case, it overwrites it. The same applies to `.MYI` files for tables created with no `INDEX DIRECTORY` option. To suppress this behavior, start the server with the new `--keep_files_on_create` option, in which case `MyISAM` will not overwrite existing files and returns an error instead. ([Bug#29325](#))



- The default value of the `connect_timeout` system variable was increased from 5 to 10 seconds. This might help in cases where clients frequently encounter errors of the form `Lost connection to MySQL server at 'XXX', system error: errno.` (Bug#28359)
- MySQL now can be compiled with `gcc 4.2.x`. There was a problem involving a conflict with the `min()` and `max()` macros in `my_global.h`. (Bug#28184)
- `mysql-test-run.pl` now supports a `--combination` option for specifying options to the `mysqld` server. This option is similar to `--mysqld` but should be given two or more times. `mysql-test-run.pl` executes multiple test runs, using the options for each instance of `--combination` in successive runs.

For test runs specific to a given test suite, an alternative to the use of `--combination` is to create a `combinations` file in the suite directory. The file should contain a section of options for each test run.

- The argument for the `mysql-test-run.pl --do-test` and `--skip-test` options is now interpreted as a Perl regular expression if there is a pattern metacharacter in the argument value. This allows more flexible specification of which tests to perform or skip.

Bugs fixed:

- **Security Fix: Replication:** It was possible for any connected user to issue a `BINLOG` statement, which could be used to escalate privileges.

Use of the `BINLOG` statement now requires the `SUPER` privilege. (Bug#31611, CVE-2007-6313)

- **Security Fix:** Three vulnerabilities in `yaSSL` versions 1.7.5 and earlier were discovered that could lead to a server crash or execution of unauthorized code. The exploit requires a server with `yaSSL` enabled and `TCP/IP` connections enabled, but does not require valid `MySQL` account credentials. The exploit does not apply to `OpenSSL`.

#### Note

The proof-of-concept exploit is freely available on the Internet. Everyone with a vulnerable `MySQL` configuration is advised to upgrade *immediately*.

(Bug#33814, CVE-2008-0226, CVE-2008-0227)

- **Security Fix:** Using `RENAME TABLE` against a table with explicit `DATA DIRECTORY` and `INDEX DIRECTORY` options can be used to overwrite system table information by replacing the symbolic link points. the file to which the symlink points.

`MySQL` will now return an error when the file to which the symlink points already exists. (Bug#32111, CVE-2007-5969)

- **Security Fix:** `ALTER VIEW` retained the original `DEFINER` value, even when altered by another user, which could allow that user to gain the access rights of the view. Now `ALTER VIEW` is allowed only to the original definer or users with the `SUPER` privilege. (Bug#29908)
- **Security Fix:** When using a `FEDERATED` table, the local server could be forced to crash if the remote server returned a result with fewer columns than expected. (Bug#29801)
- **Security Enhancement:** It was possible to force an error message of excessive length which could lead to a buffer overflow. This has been made no longer possible as a security precaution. (Bug#32707)
- **Incompatible Change:** It is no longer possible to create `CSV` tables with `NULL` columns. However, for backwards compatibility, you can continue to use such tables that were created in previous `MySQL` releases. (Bug#32050)
- **Incompatible Change:** With `ONLY_FULL_GROUP_BY` SQL mode enabled, queries such as `SELECT a FROM t1 HAVING COUNT(*) > 2` were not being rejected as they should have been.

This fix results in the following behavior:

- There is a check against mixing group and non-group columns *only* when `ONLY_FULL_GROUP_BY` is enabled.
- This check is done both for the select list and for the `HAVING` clause if there is one.

This behavior differs from previous versions as follows:

- Previously, the `HAVING` clause was not checked when `ONLY_FULL_GROUP_BY` was enabled; now it is checked.
- Previously, the select list was checked even when `ONLY_FULL_GROUP_BY` was not enabled; now it is checked only when `ONLY_FULL_GROUP_BY` is enabled.

([Bug#31794](#))

- **Incompatible Change:** Inserting a row with a `NULL` value for a `DATETIME` column results in a `CSV` file that the storage engine cannot read.

All `CSV` tables now need to be defined with each column marked as `NOT NULL`. An error is raised if you try to create a `CSV` table with columns that are not defined with `NOT NULL`. ([Bug#31473](#), [Bug#32817](#))

- **Incompatible Change:** `SET PASSWORD` statements now cause an implicit commit, and thus are prohibited within stored functions and triggers. ([Bug#30904](#))
- **Incompatible Change:** The `mysql_install_db` script could fail to locate some components (including `resolveip`) during execution if the `--basedir` option was specified on the command-line or within the `my.cnf` file. This was due to a conflict when comparing the compiled-in values and the supplied values.

The `--source-install` command-line option to the script has been removed and replaced with the `--srcdir` option. `mysql_install_db` now locates components either using the compiled-in options, the `--basedir` option or `--srcdir` option. ([Bug#30759](#))

- **Incompatible Change:** Multiple-table `DELETE` statements containing ambiguous aliases could have unintended side effects such as deleting rows from the wrong table. Example:

```
DELETE FROM t1 AS a2 USING t1 AS a1 INNER JOIN t2 AS a2;
```

Now alias declarations can be declared only in the `table_references` part. Elsewhere in the statement, alias references are allowed but not alias declarations. Statements containing aliases that are no longer allowed must be rewritten. ([Bug#30234](#))

See also [Bug#27525](#).

- **Incompatible Change:** Within a stored routine, it is no longer allowable to declare a cursor for a `SHOW` or `DESCRIBE` statement. This happened to work in some instances, but is no longer supported. In many cases, a workaround for this change is to use the cursor with a `SELECT` query to read from an `INFORMATION_SCHEMA` table that produces the same information as the `SHOW` statement. ([Bug#29223](#))
- **Incompatible Change:** It was possible to create a view having a column whose name consisted of an empty string or space characters only.

One result of this bug fix is that aliases for columns in the view `SELECT` statement are checked to ensure that they are legal column names. In particular, the length must be within the maximum column length of 64 characters, not the maximum alias length of 256 characters. This can cause problems for replication or loading dump files. For additional information and workarounds, see [Section D.4, "Restrictions on Views"](#). ([Bug#27695](#))

See also [Bug#31202](#).

- **Incompatible Change:** Several type-preserving functions and operators returned an incorrect result type that does not match their argument types: `COALESCE()`, `IF()`, `IFNULL()`, `LEAST()`, `GREATEST()`, `CASE`. These now aggregate using the precise SQL types of their arguments rather than the internal type. In addition, the result type of the `STR_TO_DATE()` function is now `DATETIME` by default. ([Bug#27216](#))
- **Incompatible Change:** `GRANT` and `REVOKE` statements now cause an implicit commit, and thus are prohibited within stored functions and triggers. ([Bug#21975](#), [Bug#21422](#), [Bug#17244](#))
- **Incompatible Change:** It was possible for option files to be read twice at program startup, if some of the standard option file locations turned out to be the same directory. Now duplicates are removed from the list of files to be read.

Also, users could not override system-wide settings using `~/my.cnf` because `SYSCONFDIR/my.cnf` was read last. The latter file now is read earlier so that `~/my.cnf` can override system-wide settings.

The fix for this problem had a side effect such that on Unix, MySQL programs looked for options in `~/my.cnf` rather than the standard location of `~/my.cnf`. That problem was addressed as [Bug#38180](#). ([Bug#20748](#))

- **Incompatible Change:** A number of problems existed in the implementation of `MERGE` tables that could cause problems. The problems are summarized below:
  - [Bug#26379](#) - Combination of `FLUSH TABLE` and `REPAIR TABLE` corrupts a `MERGE` table. This was caused in a number of situations:
    1. A thread trying to lock a `MERGE` table performs busy waiting while `REPAIR TABLE` or a similar table administration task is ongoing on one or more of its MyISAM tables.



2. A thread trying to lock a `MERGE` table performs busy waiting until all threads that did `REPAIR TABLE` or similar table administration tasks on one or more of its MyISAM tables in `LOCK TABLES` segments do `UNLOCK TABLES`. The difference against problem #1 is that the busy waiting takes place after the administration task. It is terminated by `UNLOCK TABLES` only.
  3. Two `FLUSH TABLES` within a `LOCK TABLES` segment can invalidate the lock. This does not require a `MERGE` table. The first `FLUSH TABLES` can be replaced by any statement that requires other threads to reopen the table. In 5.0 and 5.1 a single `FLUSH TABLES` can provoke the problem.
- [Bug#26867](#) - Simultaneously executing `LOCK TABLES` and `REPAIR TABLE` on a `MERGE` table would result in memory/cpu hogging.

Trying DML on a `MERGE` table, which has a child locked and repaired by another thread, made an infinite loop in the server.

- [Bug#26377](#) - Deadlock with `MERGE` and `FLUSH TABLE`  
Locking a `MERGE` table and its children in parent-child order and flushing the child deadlocked the server.
- [Bug#25038](#) - Waiting `TRUNCATE`  
Truncating a `MERGE` child, while the `MERGE` table was in use, let the truncate fail instead of waiting for the table to become free.
- [Bug#25700](#) - `MERGE` base tables get corrupted by `OPTIMIZE/ANALYZE/REPAIR TABLE`  
Repairing a child of an open `MERGE` table corrupted the child. It was necessary to `FLUSH` the child first.
- [Bug#30275](#) - `MERGE` tables: `FLUSH TABLES` or `UNLOCK TABLES` causes server to crash.  
Flushing and optimizing locked `MERGE` children crashed the server.
- [Bug#19627](#) - temporary merge table locking  
Use of a temporary `MERGE` table with non-temporary children could corrupt the children.  
Temporary tables are never locked. Creation of tables with non-temporary children of a temporary `MERGE` table is now prohibited.
- [Bug#27660](#) - `Falcon`: `MERGE` table possible  
It was possible to create a `MERGE` table with non-`MyISAM` children.
- [Bug#30273](#) - `MERGE` tables: Can't lock file (errno: 155)  
This was a Windows-only bug. Table administration statements sometimes failed with "Can't lock file (errno: 155)".

The fix introduces the following changes in behavior:

- This patch changes the behavior of temporary `MERGE` tables. Temporary `MERGE` must have temporary children. The old behavior was wrong. A temporary table is not locked. Hence even non-temporary children were not locked. See [Bug#19627](#).
- You cannot change the union list of a non-temporary `MERGE` table when `LOCK TABLES` is in effect. The following does *not* work:

```
CREATE TABLE m1 ... ENGINE=MRG_MYISAM ...;
LOCK TABLES t1 WRITE, t2 WRITE, m1 WRITE;
ALTER TABLE m1 ... UNION=(t1,t2) ...;
```

However, you can do this with a temporary `MERGE` table.

- You cannot create a `MERGE` table with `CREATE ... SELECT`, neither as a temporary `MERGE` table, nor as a non-temporary `MERGE` table. For example, `CREATE TABLE m1 ... ENGINE=MRG_MYISAM ... SELECT ...;` causes the error message: `TABLE IS NOT BASE TABLE`.

([Bug#19627](#), [Bug#25038](#), [Bug#25700](#), [Bug#26377](#), [Bug#26379](#), [Bug#26867](#), [Bug#27660](#), [Bug#30275](#), [Bug#30491](#))

- **Important Change: MySQL Cluster:** `AUTO_INCREMENT` columns had the following problems when used in `NDB` tables:
  - The `AUTO_INCREMENT` counter was not updated correctly when such a column was updated.

- `AUTO_INCREMENT` values were not prefetched beyond statement boundaries.
- `AUTO_INCREMENT` values were not handled correctly with `INSERT IGNORE` statements.
- After being set, `ndb_autoincrement_prefetch_sz` showed a value of 1, regardless of the value it had actually been set to.

As part of this fix, the behavior of `ndb_autoincrement_prefetch_sz` has changed. Setting this to less than 32 no longer has any effect on prefetching within statements (where IDs are now always obtained in batches of 32 or more), but only between statements. The default value for this variable has also changed, and is now 1. ([Bug#25176](#), [Bug#31956](#), [Bug#32055](#))

- **Partitioning: Important Note:** An apostrophe or single quote character (') used in the `DATA DIRECTORY`, `INDEX DIRECTORY`, or `COMMENT` for a `PARTITION` clause caused the server to crash. When used as part of a `CREATE TABLE` statement, the crash was immediate. When used in an `ALTER TABLE` statement, the crash did not occur until trying to perform a `SELECT` or DML statement on the table. In either case, the server could not be completely restarted until the `.FRM` file corresponding to the newly created or altered table was deleted.

### Note

Upgrading to the current (or later) release solves this problem only for tables that are newly created or altered. Tables created or altered in previous versions of the server to include ' characters in `PARTITION` options must still be removed by deleting the corresponding `.FRM` files and re-creating them afterwards.

([Bug#30695](#))

- **Important Note:** The `RENAME DATABASE` statement was removed and replaced with `ALTER DATABASE db_name UPGRADE DATA DIRECTORY NAME`. The `RENAME DATABASE` statement was intended for upgrading database directory names to the encoding format used in 5.1 for representing identifiers in the file system (see [Section 8.2.3](#), “Mapping of Identifiers to File Names”). However, the statement was found to be dangerous because it could result in loss of database contents. See [Section 12.1.32](#), “`RENAME DATABASE Syntax`”, and [Section 12.1.1](#), “`ALTER DATABASE Syntax`”. ([Bug#17565](#), [Bug#21741](#), [Bug#28360](#))

- **Replication: MySQL Cluster:** Row-based replication from or to a big-endian machine where the table used the `NDB` storage engine failed, if the same table on the other machine was either non-`NDB` or the other machine was little-endian. ([Bug#29549](#), [Bug#30790](#))

See also [Bug#24231](#), [Bug#30024](#), [Bug#30133](#), [Bug#30134](#).

- **MySQL Cluster:** An improperly reset internal signal was observed as a hang when using events in the `NDB` API but could result in various errors. ([Bug#33206](#))
- **MySQL Cluster:** Incorrectly handled parameters could lead to a crash in the Transaction Coordinator during a node failure, causing other data nodes to fail. ([Bug#33168](#))
- **MySQL Cluster:** A memory leak occurred if a subscription start request was received by the subscription manager before the node making the request was fully connected to the cluster. ([Bug#32652](#))
- **MySQL Cluster:** A local checkpoint could sometimes be started before the previous LCP was restorable from a global checkpoint. ([Bug#32519](#))
- **MySQL Cluster:** High numbers of API nodes on a slow or congested network could cause connection negotiation to time out prematurely, leading to the following issues:
  - Excessive retries
  - Excessive CPU usage
  - Partially connected API nodes([Bug#32359](#))
- **MySQL Cluster:** When a `mysqld` acting as a cluster SQL node starts the `NDBCLUSTER` storage engine, there is a delay during which some necessary data structures cannot be initialized until after it has connected to the cluster, and all MySQL Cluster tables should be opened as read-only. This worked correctly when the `NDB` binlog thread was running, but when it was not running, Cluster tables were not opened as read-only even when the data structures had not yet been set up. ([Bug#32275](#), [Bug#33763](#))
- **MySQL Cluster:** The failure of a master node could lead to subsequent failures in local checkpointing. ([Bug#32160](#))
- **MySQL Cluster:** The management server was slow to respond when no data nodes were connected to the cluster. This was most noticeable when running `SHOW` in the management client. ([Bug#32023](#))

- **MySQL Cluster:** An error with an `if` statement in `sql/ha_ndbcluster.cc` could potentially lead to an infinite loop in case of failure when working with `AUTO_INCREMENT` columns in `NDB` tables. (Bug#31810)
- **MySQL Cluster:** The `NDB` storage engine code was not safe for strict-alias optimization in `gcc` 4.2.1. (Bug#31761)
- **MySQL Cluster:** It was possible in some cases for a node group to be “lost” due to missed local checkpoints following a system restart. (Bug#31525)
- **MySQL Cluster:** A query against a table with `TEXT` or `BLOB` columns that would return more than a certain amount of data failed with `GOT ERROR 4350 'TRANSACTION ALREADY ABORTED' FROM NDBCLUSTER`. (Bug#31482)

This regression was introduced by Bug#29102.

- **MySQL Cluster:** `NDB` tables having names containing non-alphanumeric characters (such as “\$”) were not discovered correctly. (Bug#31470)
- **MySQL Cluster:** A node failure during a local checkpoint could lead to a subsequent failure of the cluster during a system restart. (Bug#31257)
- **MySQL Cluster:** A cluster restart could sometimes fail due to an issue with table IDs. (Bug#30975)
- **MySQL Cluster:** When handling `BLOB` columns, the addition of read locks to the lock queue was not handled correctly. (Bug#30764)
- **MySQL Cluster:** Discovery of `NDB` tables did not work correctly with `INFORMATION_SCHEMA`. (Bug#30667)
- **MySQL Cluster:** A file system close operation could fail during a node or system restart. (Bug#30646)
- **MySQL Cluster:** Transaction timeouts were not handled well in some circumstances, leading to excessive number of transactions being aborted unnecessarily. (Bug#30379)
- **MySQL Cluster:** The cluster management client could not connect, and would hang instead. This issue affected Mac OS X 64-bit only. (Bug#30366)
- **MySQL Cluster:** Attempting to restore a backup made on a cluster host using one endian to a machine using the other endian could cause the cluster to fail. (Bug#29674)
- **MySQL Cluster:** Log event requests to `ndb_mgmd` could time out, causing it to fail. (Bug#29621)
- **MySQL Cluster:** In some cases, the cluster management server logged entries multiple times following a restart of `mgmd`. (Bug#29565)
- **MySQL Cluster:** `ndb_mgm --help` did not display any information about the `-a` option. (Bug#29509)
- **MySQL Cluster:** An interpreted program of sufficient size and complexity could cause all cluster data nodes to shut down due to buffer overruns. (Bug#29390)
- **MySQL Cluster:** `ndb_size.pl` failed on tables with `FLOAT` columns whose definitions included commas (for example, `FLOAT(6,2)`). (Bug#29228)
- **MySQL Cluster:** The error message for `NDB` error code 275 (`OUT OF TRANSACTION RECORDS FOR COMPLETE PHASE`) was missing. (Bug#29139)
- **MySQL Cluster:** Reads on `BLOB` columns were not locked when they needed to be to guarantee consistency. (Bug#29102)

See also Bug#31482.

- **MySQL Cluster:** A query using joins between several large tables and requiring unique index lookups failed to complete, eventually returning `UNKNOWN ERROR` after a very long period of time. This occurred due to inadequate handling of instances where the Transaction Coordinator ran out of `TransactionBufferMemory`, when the cluster should have returned `NDB` error code 4012 (`REQUEST NDBD TIME-OUT`). (Bug#28804)
- **MySQL Cluster:** There was a short interval during the startup process prior to the beginning of heartbeat detection such that, were an API or management node to reboot or a network failure to occur, data nodes could not detect this, with the result that there could be a lingering connection. (Bug#28445)
- **MySQL Cluster:** The description of the `--print` option provided in the output from `ndb_restore --help` was incorrect. (Bug#27683)
- **MySQL Cluster:** Restoring a backup made on a cluster host using one endian to a machine using the other endian failed for `BLOB` and `DATETIME` columns. (Bug#27543, Bug#30024)

- **MySQL Cluster:** An invalid subselect on an `NDB` table could cause `mysqld` to crash. (Bug#27494)
- **MySQL Cluster:** An attempt to perform a `SELECT ... FROM INFORMATION_SCHEMA.TABLES` whose result included information about `NDB` tables for which the user had no privileges crashed the MySQL Server on which the query was performed. (Bug#26793)
- **MySQL Cluster:** Performing `DELETE` operations after a data node had been shut down could lead to inconsistent data following a restart of the node. (Bug#26450)
- **MySQL Cluster:** `UPDATE IGNORE` could sometimes fail on `NDB` tables due to the use of uninitialized data when checking for duplicate keys to be ignored. (Bug#25817)
- **MySQL Cluster:** The cluster log was formatted inconsistently and contained extraneous newline characters. (Bug#25064)
- **MySQL Cluster:** A restart of the cluster failed when more than 1 REDO phase was in use. (Bug#22696)
- **MySQL Cluster:** When inserting a row into an `NDB` table with a duplicate value for a non-primary unique key, the error issued would reference the wrong key.

This improves on an initial fix for this issue made in MySQL 5.1.13. (Bug#21072)

- **MySQL Cluster:** An insufficiently descriptive and potentially misleading Error 4006 (`CONNECT FAILURE - OUT OF CONNECTION OBJECTS...`) was produced when either of the following two conditions occurred:
    1. There were no more transaction records in the transaction coordinator
    2. An `NDB` object in the `NDB` API was initialized with insufficient parallelism
 Separate error messages are now generated for each of these two cases. (Bug#11313)
  - **Partitioning: Replication:** Replication of partitioned tables using the `InnoDB` storage engine failed with `binlog-format=ROW` or `binlog-format=MIXED`. (Bug#28430)
  - **Partitioning:** It was possible to partition a table to which a foreign key referred. (Bug#32948)
  - **Partitioning:** A query of the form `SELECT col1 FROM table GROUP BY (SELECT col2 FROM table LIMIT 1)` against a partitioned `table` having a `SET` column crashed the server. (Bug#32772)
  - **Partitioning:** `SHOW CREATE TABLE` misreported the value of `AUTO_INCREMENT` for partitioned tables using either of the `InnoDB` or `ARCHIVE` storage engines. (Bug#32247)
  - **Partitioning:** Selecting from `INFORMATION_SCHEMA.PARTITIONS` while partition management statements (for example, `ALTER TABLE ... ADD PARTITION`) were executing caused the server to crash. (Bug#32178)
  - **Partitioning:** An error in the internal function `mysql_unpack_partition()` led to a fatal error in subsequent calls to `open_table_from_share()`. (Bug#32158)
  - **Partitioning:** Repeated updates of a table that was partitioned by `KEY` on a `TIMESTAMP` column eventually crashed the server. (Bug#32067)
  - **Partitioning:** Changing the storage engine used by a table having subpartitions led to a server crash. (Bug#31893)
  - **Partitioning:** `ORDER BY ... DESC` did not always work correctly when selecting from partitioned tables. (Bug#31890)
- See also Bug#31001.
- **Partitioning:** Selecting from a table partitioned by `KEY` on a `VARCHAR` column whose size was greater than 65530 caused the server to crash. (Bug#31705)
  - **Partitioning:** `INSERT DELAYED` on a partitioned table crashed the server. The server now rejects the statement with an error. (Bug#31210)
  - **Partitioning:** Using `ALTER TABLE` to partition an existing table having an `AUTO_INCREMENT` column could crash the server. (Bug#30878)
- This regression was introduced by Bug#27405.
- **Partitioning:** `ALTER TABLE ... COALESCE PARTITION` on a table partitioned by `[LINEAR] HASH` or `[LINEAR] KEY` caused the server to crash. (Bug#30822)
  - **Partitioning:** `LIKE` queries on tables partitioned by `KEY` and using third-party storage engines could return incomplete results. (Bug#30480)

See also [Bug#29320](#), [Bug#29493](#), [Bug#30563](#).

- **Partitioning:** It was not possible to insert the greatest possible value for a given data type into a partitioned table. For example, consider a table defined as shown here:

```
CREATE TABLE t (c BIGINT UNSIGNED)
PARTITION BY RANGE(c) (
PARTITION p0 VALUES LESS THAN MAXVALUE
);
```

The largest possible value for a `BIGINT UNSIGNED` column is 18446744073709551615, but the statement `INSERT INTO t VALUES (18446744073709551615);` would fail, even though the same statement succeeded were `t` not a partitioned table.

In other words, `MAXVALUE` was treated as being equal to the greatest possible value, rather than as a least upper bound. ([Bug#29258](#))

- **Cluster Replication: Replication:** A node failure during replication could lead to buckets out of order; now active subscribers are checked for, rather than empty buckets. ([Bug#31701](#))
- **Cluster Replication: Replication:** Incorrect handling of `INSERT` plus `DELETE` operations with regard to local checkpoints caused data node failures in multi-master replication setups. ([Bug#30914](#))
- **Replication:** When dropping a database containing a stored procedure while using row-based replication, the delete of the stored procedure from the `mysql.proc` table was recorded in the binary log following the `DROP DATABASE` statement. To correct this issue, `DROP DATABASE` now uses statement-based replication. ([Bug#32435](#))
- **Replication:** It was possible for the name of the relay log file to exceed the amount of memory reserved for it, possibly leading to a crash of the server. ([Bug#31836](#))

See also [Bug#28597](#).

- **Replication:** Corruption of log events caused the server to crash on 64-bit Linux systems having 4 GB of memory or more. ([Bug#31793](#))
- **Replication:** Trying to replicate an update of a row that was missing on the slave led to a failure on the slave. ([Bug#31702](#))
- **Replication:** Use of the `@@hostname` system variable in inserts in `mysql_system_tables_data.sql` did not replicate. The workaround is to select its value into a user variable (which does replicate) and insert that. ([Bug#31167](#))
- **Replication:** Table names were displayed as binary “garbage” characters in slave error messages. The issue was observed on 64-bit Windows but may have effected other platforms. ([Bug#30854](#))
- **Replication:** One thread could read uninitialized memory from the stack of another thread. This issue was only known to occur in a `mysqld` process acting as both a master and a slave. ([Bug#30752](#))
- **Replication:** It was possible to set `SQL_SLAVE_SKIP_COUNTER` such that the slave would jump into the middle of a transaction. This fix improves on one made for this bug in MySQL 5.1.20; the previous fix insured that the slave could not be made to jump into the middle of an event group, but the slave failed to recognize that `BEGIN`, `COMMIT`, and `ROLLBACK` statements could begin or end an event group. ([Bug#28618](#))

See also [Bug#12691](#).

- **Replication:** Due a previous change in how the default name and location of the binary log file were determined, replication failed following some upgrades. ([Bug#28597](#), [Bug#28603](#))

See also [Bug#31836](#).

This regression was introduced by [Bug#20166](#).

- **Replication:** Stored procedures having `BIT` parameters were not replicated correctly. ([Bug#26199](#))
- **Replication:** Issuing `SHOW SLAVE STATUS` as `mysqld` was shutting down could cause a crash. ([Bug#26000](#))
- **Replication:** If a temporary error occurred inside an event group on an event that was not the first event of the group, the slave could get caught in an endless loop because the retry counter was reset whenever an event was executed successfully. ([Bug#24860](#))

See also [Bug#12691](#), [Bug#23171](#).

- **Replication:** An `UPDATE` statement using a stored function that modified a non-transactional table was not logged if it failed. This caused the copy of the non-transactional table on the master have a row that the copy on the slave did not.

In addition, when an `INSERT ... ON DUPLICATE KEY UPDATE` statement encountered a duplicate key constraint, but the `UPDATE` did not actually change any data, the statement was not logged. As a result of this fix, such statements are now treated the same for logging purposes as other `UPDATE` statements, and so are written to the binary log. (Bug#23333)

See also [Bug#12713](#).

- **Replication:** A replication slave sometimes failed to reconnect because it was unable to run `SHOW SLAVE HOSTS`. It was not necessary to run this statement on slaves (since the master should track connection IDs), and the execution of this statement by slaves was removed. (Bug#21132)

See also [Bug#13963](#), [Bug#21869](#).

- **Replication:** A replication slave sometimes stopped for changes that were idempotent (that is, such changes should have been considered “safe”), even though it should have simply noted that the change was already done, and continued operation. (Bug#19958)
- **Replication:** Replicating from a master table to a slave table where the size of a `CHAR` or `VARCHAR` column was a different size would cause `mysqld` to crash. For more information on replicating with different column definitions, see [Section 16.3.1.4, “Replication with Differing Tables on Master and Slave”](#).
- **Cluster Replication:** A replication slave could return “garbage” data that was not in recognizable row format due to a problem with the internal `all_set()` method. (Bug#33375)
- **Cluster Replication:** Memory was mistakenly freed for `NdbBlob` objects when adding an index while replicating the cluster, which could cause `mysqld` to crash. (Bug#33142)

See also [Bug#18106](#).

- **Cluster Replication:** Under certain conditions, the slave stopped processing relay logs. This resulted in the logs never being cleared and the slave eventually running out of disk space. (Bug#31958)
- **Cluster Replication:** Replicating `NDB` tables with extra `VARCHAR` columns on the master caused the slave to fail. (Bug#31646)

See also [Bug#29549](#).

- **Cluster Replication:** When the master `mysqld` crashed or was restarted, no `LOST_EVENTS` entry was made in the binlog. (Bug#31484)

See also [Bug#21494](#).

- **Cluster Replication:** An issue with the `mysql.ndb_apply_status` table could cause `NDB` schema autodiscovery to fail in certain rare circumstances. (Bug#20872)
- **Cluster API:** A call to `CHECK_TIMEDOUT_RET()` in `mgmapi.cpp` should have been a call to `DBG_CHECK_TIMEDOUT_RET()`. (Bug#30681)
- **API:** When the language option was not set correctly, API programs calling `mysql_server_init()` crashed. This issue was observed only on Windows platforms. (Bug#31868)
- Corrected a typecast involving `bool` on Mac OS X 10.5 (Leopard), which evaluated differently from earlier Mac OS X versions. (Bug#38217)

- Use of uninitialized memory for `filesort` in a subquery caused a server crash. (Bug#33675)
- `CREATE TABLE ... SELECT` created tables that for date columns used the obsolete `Field_date` type instead of `Field_newdate`. (Bug#33256)
- Some valid `SELECT` statements could not be used as views due to incorrect column reference resolution. (Bug#33133)
- The fix for [Bug#11230](#) and [Bug#26215](#) introduced a significant input-parsing slowdown for the `mysql` client. This has been corrected. (Bug#33057)
- The correct data type for a `NULL` column resulting from a `UNION` could be determined incorrectly in some cases: 1) Not correctly inferred as `NULL` depending on the number of selects; 2) Not inferred correctly as `NULL` if one select used a subquery. (Bug#32848)
- For queries containing `GROUP_CONCAT(DISTINCT col_list ORDER BY col_list)`, there was a limitation that the `DISTINCT` columns had to be the same as `ORDER BY` columns. Incorrect results could be returned if this was not true. (Bug#32798)



- `SHOW EVENTS` and selecting from the `INFORMATION_SCHEMA.EVENTS` table failed if the current database was `INFORMATION_SCHEMA`. (Bug#32775)
- Use of the `cp932` character set with `CAST()` in an `ORDER BY` clause could cause a server crash. (Bug#32726)
- A subquery using an `IS NULL` check of a column defined as `NOT NULL` in a table used in the `FROM` clause of the outer query produced an invalid result. (Bug#32694)
- `mysqld_safe` looked for error messages in the wrong location. (Bug#32679)
- Specifying a non-existent column for an `INSERT DELAYED` statement caused a server crash rather than producing an error. (Bug#32676)
- An issue with the `NO_ENGINE_SUBSTITUTION sql_mode` database can cause the creation of stored routines to fail. If you are having problems with creating stored routines while using this `sql_mode` value, remove this value from your `sql_mode` setting. (Bug#32633)
- Use of `CLIENT_MULTI_QUERIES` caused `libmysqld` to crash. (Bug#32624)
- The `INTERVAL()` function incorrectly handled `NULL` values in the value list. (Bug#32560)
- Use of a `NULL`-returning `GROUP BY` expression in conjunction with `WITH ROLLUP` could cause a server crash. (Bug#32558)  
See also Bug#31095.
- `ORDER BY UpdateXML(...)` caused the server to crash in queries where `UpdateXML()` returned `NULL`. (Bug#32557)
- A `SELECT ... GROUP BY bit_column` query failed with an assertion if the length of the `BIT` column used for the `GROUP BY` was not an integer multiple of 8. (Bug#32556)
- Using `SELECT INTO OUTFILE` with 8-bit `ENCLOSED BY` characters led to corrupted data when the data was reloaded using `LOAD DATA INFILE`. This was because `SELECT INTO OUTFILE` failed to escape the 8-bit characters. (Bug#32533)
- For `FLUSH TABLES WITH READ LOCK`, the server failed to properly detect write-locked tables when running with low-priority updates, resulting in a crash or deadlock. (Bug#32528)
- The rules for valid column names were being applied differently for base tables and views. (Bug#32496)
- A query of the form `SELECT @user_variable := constant AS alias FROM table GROUP BY alias WITH ROLLUP` crashed the server. (Bug#32482)
- Sending several `KILL QUERY` statements to target a connection running `SELECT SLEEP()` could freeze the server. (Bug#32436)
- `ssl-cipher` values in option files were not being read by `libmysqlclient`. (Bug#32429)
- Repeated execution of a query containing a `CASE` expression and numerous `AND` and `OR` relations could crash the server. The root cause of the issue was determined to be that the internal `SEL_ARG` structure was not properly initialized when created. (Bug#32403)
- Referencing within a subquery an alias used in the `SELECT` list of the outer query was incorrectly permitted. (Bug#32400)
- If a global read lock acquired with `FLUSH TABLES WITH READ LOCK` was in effect, executing `ALTER TABLE` could cause a server crash. (Bug#32395)
- An `ORDER BY` query on a view created using a `FEDERATED` table as a base table caused the server to crash. (Bug#32374)
- The `mysqldump` utility did not print enough version information about itself at the top of its output. The output now shows the same information as `mysqldump` invoked with the `-V` option, namely the `mysqldump` version number, the MySQL server version, and the distribution. (Bug#32350)
- Comparison of a `BIGINT NOT NULL` column with a constant arithmetic expression that evaluated to `NULL` mistakenly caused the error `COLUMN '...' CANNOT BE NULL` (error 1048). (Bug#32335)
- Assigning a 65,536-byte string to a `TEXT` column (which can hold a maximum of 65,535 bytes) resulted in truncation without a warning. Now a truncation warning is generated. (Bug#32282)
- The `LAST_DAY()` function returns a `DATE` value, but internally the value did not have the time fields zeroed and calculations involving the value could return incorrect results. (Bug#32270)
- `MIN()` and `MAX()` could return incorrect results when an index was present if a loose index scan was used. (Bug#32268)

- Some uses of user variables in a query could result in a server crash. (Bug#32260)
- Memory corruption could occur due to large index map in `Range checked for each record` status reported by `EXPLAIN SELECT`. The problem was based in an incorrectly calculated length of the buffer used to store a hexadecimal representation of an index map, which could result in buffer overrun and stack corruption under some circumstances. (Bug#32241)
- Various test program cleanups were made: 1) `mytest` and `libmysqltest` were removed. 2) `bug25714` displays an error message when invoked with incorrect arguments or the `--help` option. 3) `mysql_client_test` exits cleanly with a proper error status. (Bug#32221)
- The default grant tables on Windows contained information for host `production.mysql.com`, which should not be there. (Bug#32219)
- Under certain conditions, the presence of a `GROUP BY` clause could cause an `ORDER BY` clause to be ignored. (Bug#32202)
- For comparisons of the form `date_col OP datetime_const` (where `OP` is `=`, `<`, `>`, `<=`, or `>=`), the comparison is done using `DATETIME` values, per the fix for Bug#27590. However that fix caused any index on `date_col` not to be used and compromised performance. Now the index is used again. (Bug#32198)
- `DATETIME` arguments specified in numeric form were treated by `DATE_ADD()` as `DATE` values. (Bug#32180)
- Killing a statement could lead to a race condition in the server. (Bug#32148)
- `InnoDB` does not support `SPATIAL` indexes, but could crash when asked to handle one. Now an error is returned. (Bug#32125)
- The server crashed on optimizations involving a join of `INT` and `MEDIUMINT` columns and a system variable in the `WHERE` clause. (Bug#32103)
- `mysql-test-run.pl` used the `--user` option when starting `mysqld`, which produces warnings if the current user is not `root`. Now `--user` is added only for `root`. (Bug#32078)
- `mysqlslap` was missing from the MySQL 5.1.22 Linux RPM packages. (Bug#32077)
- With `lower_case_table_names` set, `CREATE TABLE LIKE` was treated differently by `libmysqld` than by the non-embedded server. (Bug#32063)
- Within a subquery, `UNION` was handled differently than at the top level, which could result in incorrect results or a server crash. (Bug#32036, Bug#32051)
- On 64-bit platforms, assignments of values to enumeration-valued storage engine-specific system variables were not validated and could result in unexpected values. (Bug#32034)
- A `DELETE` statement with a subquery in the `WHERE` clause would sometimes ignore an error during subquery evaluation and proceed with the delete operation. (Bug#32030)
- Using dates in the range `'0000-00-01'` to `'0000-00-99'` range in the `WHERE` clause could result in an incorrect result set. (These dates are not in the supported range for `DATE`, but different results for a given query could occur depending on position of records containing the dates within a table.) (Bug#32021)
- User-defined functions are not loaded if the server is started with the `--skip-grant-tables` option, but the server did not properly handle this case and issued an `OUT OF MEMORY` error message instead. (Bug#32020)
- If a user-defined function was used in a `SELECT` statement, and an error occurred during UDF initialization, the error did not terminate execution of the `SELECT`, but rather was converted to a warning. (Bug#32007)
- `HOUR()`, `MINUTE()`, and `SECOND()` could return nonzero values for `DATE` arguments. (Bug#31990)
- Changing the SQL mode to cause dates with “zero” parts to be considered invalid (such as `'1000-00-00'`) could result in indexed and non-indexed searches returning different results for a column that contained such dates. (Bug#31928)
- The server used unnecessarily large amounts of memory when user variables were used as an argument to `CONCAT()` or `CONCAT_WS()`. (Bug#31898)
- In debug builds, testing the result of an `IN` subquery against `NULL` caused an assertion failure. (Bug#31884)
- `mysql-test-run.pl` sometimes set up test scenarios in which the same port number was passed to multiple servers, causing one of them to be unable to start. (Bug#31880)
- `SHOW CREATE TRIGGER` caused a server crash. (Bug#31866)



- The server crashed after insertion of a negative value into an `AUTO_INCREMENT` column of an `InnoDB` table. (Bug#31860)
- For `libmysqld` applications, handling of `mysql_change_user()` calls left some pointers improperly updated, leading to server crashes. (Bug#31850)
- Using `ORDER BY` led to the wrong result when using the `ARCHIVE` on a table with a `BLOB` when the table cache was full. The table could also be reported as crashed after the query had completed, even though the table data was intact. (Bug#31833)
- Comparison results for `BETWEEN` were different from those for operators like `<` and `>` for `DATETIME`-like values with trailing extra characters such as `'2007-10-01 00:00:00 GMT-6'`. `BETWEEN` treated the values as `DATETIME`, whereas the other operators performed a binary-string comparison. Now they all uniformly use a `DATETIME` comparison, but generate warnings for values with trailing garbage. (Bug#31800)
- Name resolution for correlated subqueries and `HAVING` clauses failed to distinguish which of two was being performed when there was a reference to an outer aliased field. This could result in error messages about a `HAVING` clause for queries that had no such clause. (Bug#31797)
- The server could crash during `filesort` for `ORDER BY` based on expressions with `INET_NTOA()` or `OCT()` if those functions returned `NULL`. (Bug#31758)
- For tables with certain definitions, `UPDATE` statements could fail to find the correct record to update and report an error when the record did in fact exist. (Bug#31747)
- For a fatal error during a filesort in `find_all_keys()`, the error was returned without the necessary handler uninitialization, causing an assertion failure. (Bug#31742)
- `mysqldslap` failed to commit after the final record load. (Bug#31704)
- The examined-rows count was not incremented for `const` queries. (Bug#31700)
- The server crashed if a thread was killed while locking the `general_log` table at the beginning of statement processing. (Bug#31692)
- The `mysql_change_user()` C API function was subject to buffer overflow. (Bug#31669)
- For `SELECT ... INTO OUTFILE`, if the `ENCLOSED BY` string is empty and the `FIELDS TERMINATED BY` string started with a special character (one of `n`, `t`, `r`, `b`, `0`, `Z`, or `N`), every occurrence of the character within field values would be duplicated. (Bug#31663)
- `SHOW COLUMNS` and `DESCRIBE` displayed `null` as the column type for a view with no valid definer. This caused `mysqldump` to produce a non-reloadable dump file for the view. (Bug#31662)
- The `mysqlbug` script did not include the correct values of `CFLAGS` and `CXXFLAGS` that were used to configure the distribution. (Bug#31644)
- Queries that include a comparison of an `INFORMATION_SCHEMA` table column to `NULL` caused a server crash. (Bug#31633)
- `EXPLAIN EXTENDED` for `SELECT` from `INFORMATION_SCHEMA` tables caused an assertion failure. (Bug#31630)
- `ucs2` does not work as a client character set, but attempts to use it as such were not rejected. Now `character_set_client` cannot be set to `ucs2`. This also affects statements such as `SET NAMES` and `SET CHARACTER SET`. (Bug#31615)
- A buffer used when setting variables was not dimensioned to accommodate the trailing `'\0'` byte, so a single-byte buffer overrun was possible. (Bug#31588)
- `HAVING` could treat lettercase of table aliases incorrectly if `lower_case_table_names` was enabled. (Bug#31562)
- Spurious duplicate-key errors could occur for multiple-row inserts into an `InnoDB` table that activate a trigger. (Bug#31540)
- Using `ALTER EVENT` to rename a disabled event caused it to become enabled. (Bug#31539)
- The fix for Bug#24989 introduced a problem such that a `NULL` thread handler could be used during a rollback operation. This problem is unlikely to be seen in practice. (Bug#31517)
- The length of the result from `IFNULL()` could be calculated incorrectly because the sign of the result was not taken into account. (Bug#31471)
- Queries that used the `ref` access method or index-based subquery execution over indexes that have `DECIMAL` columns could fail with an error `Column col_name cannot be null`. (Bug#31450)

- `InnoDB` now tracks locking and use of tables by MySQL only after a table has been successfully locked on behalf of a transaction. Previously, the locked flag was set and the table in-use counter was updated before checking whether the lock on the table succeeded. A subsequent failure in obtaining a lock on the table led to an inconsistent state as the table was neither locked nor in use. (Bug#31444)
  - `SELECT 1 REGEX NULL` caused an assertion failure for debug servers. (Bug#31440)
  - The `UpdateXML()` function did not check for the validity of all its arguments; in some cases, this could lead to a crash of the server. (Bug#31438)
  - The `mysql_change_user()` C API function caused advisory locks (obtained with `GET_LOCK()`) to malfunction. (Bug#31418)
  - NDB libraries and include files were missing from some binary `tar` file distributions. (Bug#31414)
  - Executing `RENAME` while tables were open for use with `HANDLER` statements could cause a server crash. (Bug#31409)
  - `mysql-test-run.pl` tried to create files in a directory where it could not be expected to have write permission. `mysqltest` created `.reject` files in a directory other than the one where test results go. (Bug#31398)
  - For a table that had been opened with `HANDLER` and marked for reopening after being closed with `FLUSH TABLES, DROP TABLE` did not properly discard the handler. (Bug#31397)
  - Automatically allocated memory for string options associated with a plugin was not freed if the plugin did not get installed. (Bug#31382)
  - `INFORMATION_SCHEMA.TABLES` was returning incorrect information. (Bug#31381)
  - `DROP USER` caused an increase in memory usage. (Bug#31347)
  - For `InnoDB` tables with `READ COMMITTED` isolation level, semi-consistent reads used for `UPDATE` statements skipped rows locked by another transaction, rather than waiting for the locks to be released. Consequently, rows that possibly should have been updated were never examined. (Bug#31310)
  - For an almost-full `MyISAM` table, an insert that failed could leave the table in a corrupt state. (Bug#31305)
  - `myisamchk --unpack` could corrupt a table that when unpacked has static (fixed-length) row format. (Bug#31277)
  - `CONVERT(val, DATETIME)` would fail on invalid input, but processing was not aborted for the `WHERE` clause, leading to a server crash. (Bug#31253)
  - Allocation of an insufficiently large group-by buffer following creation of a temporary table could lead to a server crash. (Bug#31249)
  - Use of `DECIMAL(n, n) ZEROFILL` in `GROUP_CONCAT()` could cause a server crash. (Bug#31227)
  - When a `TIMESTAMP` with a nonzero time part was converted to a `DATE` value, no warning was generated. This caused index lookups to assume that this is a valid conversion and was returning rows that match a comparison between a `TIMESTAMP` value and a `DATE` keypart. Now a warning is generated so that `TIMESTAMP` with a nonzero time part will not match `DATE` values. (Bug#31221)
  - Server variables could not be set to their current values on Linux platforms. (Bug#31177)
- See also [Bug#6958](#).
- With small values of `myisam_sort_buffer_size`, `REPAIR TABLE` for `MyISAM` tables could cause a server crash. (Bug#31174)
  - If `MAKETIME()` returned `NULL` when used in an `ORDER BY` that was evaluated using `filesort`, a server crash could result. (Bug#31160)
  - Data in `BLOB` or `GEOMETRY` columns could be cropped when performing a `UNION` query. (Bug#31158)
  - `LAST_INSERT_ID()` execution could be handled improperly in subqueries. (Bug#31157)
  - An assertion designed to detect a bug in the `ROLLUP` implementation would incorrectly be triggered when used in a subquery context with non-cacheable statements. (Bug#31156)
  - Selecting spatial types in a `UNION` could cause a server crash. (Bug#31155)
  - Use of `GROUP_CONCAT(DISTINCT bit_column)` caused an assertion failure. (Bug#31154)

- The server crashed in the parser when running out of memory. Memory handling in the parser has been improved to gracefully return an error when out-of-memory conditions occur in the parser. ([Bug#31153](#))
- MySQL declares a `UNIQUE` key as a `PRIMARY` key if it doesn't have `NULL` columns and is not a partial key, and the `PRIMARY` key must always be the first key. However, in some cases, a non-first key could be reported as `PRIMARY`, leading to an assert failure by `InnoDB`. This is fixed by correcting the key sort order. ([Bug#31137](#))
- `mysqldump` failed to handle databases containing a `'` character in the name. ([Bug#31113](#))
- Starting the server using `--read-only` and with the Event Scheduler enabled caused it to crash.

**Note**

This issue occurred only when the server had been built with certain nonstandard combinations of `configure` options.

([Bug#31111](#))

- `GROUP BY NULL WITH ROLLUP` could cause a server crash. ([Bug#31095](#))

See also [Bug#32558](#).

- A rule to prefer `filesort` over an indexed `ORDER BY` when accessing all rows of a table was being used even if a `LIMIT` clause was present. ([Bug#31094](#))
- `REGEXP` operations could cause a server crash for character sets such as `ucs2`. Now the arguments are converted to `utf8` if possible, to allow correct results to be produced if the resulting strings contain only 8-bit characters. ([Bug#31081](#))
- Expressions of the form `WHERE col NOT IN (col, ...)`, where the same column was named both times, could cause a server crash in the optimizer. ([Bug#31075](#))
- Internal conversion routines could fail for several multi-byte character sets (`big5`, `cp932`, `euckr`, `gb2312`, `sjis`) for empty strings or during evaluation of `SOUNDS LIKE`. ([Bug#31069](#), [Bug#31070](#))
- Many nested subqueries in a single query could lead to excessive memory consumption and possibly a crash of the server. ([Bug#31048](#))
- Using `ORDER BY` with `ARCHIVE` tables caused a server crash. ([Bug#31036](#))
- A server crash could occur when a non-`DETERMINISTIC` stored function was used in a `GROUP BY` clause. ([Bug#31035](#))
- The `MOD()` function and the `%` operator crashed the server for a divisor less than 1 with a very long fractional part. ([Bug#31019](#))
- Transactions were committed prematurely when `LOCK TABLE` and `SET autocommit = 0` were used together. ([Bug#30996](#))
- On Windows, the `pthread_mutex_trylock()` implementation was incorrect. ([Bug#30992](#))
- A character set introducer followed by a hexadecimal or bit-value literal did not check its argument and could return an ill-formed result for invalid input. ([Bug#30986](#))
- `CHAR(str USING charset)` did not check its argument and could return an ill-formed result for invalid input. ([Bug#30982](#))
- The result from `CHAR(str USING ucs2)` did not add a leading 0x00 byte for input strings with an odd number of bytes. ([Bug#30981](#))
- The `GeomFromText()` function could cause a server crash if the first argument was `NULL` or the empty string. ([Bug#30955](#))
- `MAKEDATE()` incorrectly moved year values in the 100-200 range into the 1970-2069 range. (This is legitimate for 00-99, but three-digit years should be used unchanged.) ([Bug#30951](#))
- When invoked with constant arguments, `STR_TO_DATE()` could use a cached value for the format string and return incorrect results. ([Bug#30942](#))
- `GROUP_CONCAT()` returned `' , '` rather than an empty string when the argument column contained only empty strings. ([Bug#30897](#))
- For `MEMORY` tables, lookups for `NULL` values in `BTREE` indexes could return incorrect results. ([Bug#30885](#))

- A server crash could occur if a stored function that contained a `DROP TEMPORARY TABLE` statement was invoked by a `CREATE TEMPORARY TABLE` statement that created a table of the same name. (Bug#30882)
- Calling `NAME_CONST()` with non-constant arguments triggered an assertion failure. Non-constant arguments are now disallowed. (Bug#30832)
- For a spatial column with a regular (non-`SPATIAL`) index, queries failed if the optimizer tried to use the index. (Bug#30825)
- Values for the `--tc-heuristic-recover` option incorrectly were treated as values for the `--myisam-stats-method` option. (Bug#30821)
- `INFORMATION_SCHEMA.SCHEMATA` was returning incorrect information. (Bug#30795)
- The optimizer incorrectly optimized conditions out of the `WHERE` clause in some queries involving subqueries and indexed columns. (Bug#30788)
- Improper calculation of `CASE` expression results could lead to value truncation. (Bug#30782)
- On Windows, the `pthread_mutex_trylock()` implementation was incorrect. One symptom was that invalidating the query cache could cause a server crash. (Bug#30768)
- A multiple-table `UPDATE` involving transactional and non-transactional tables caused an assertion failure. (Bug#30763)
- User-supplied names foreign key names might not be set to the right key, leading to foreign keys with no name. (Bug#30747)
- Under some circumstances, `CREATE TABLE ... SELECT` could crash the server or incorrectly report that the table row size was too large. (Bug#30736)
- Using the `MIN()` or `MAX()` function to select one part of a multi-part key could cause a crash when the function result was `NULL`. (Bug#30715)
- The embedded server did not properly check column-level privileges. (Bug#30710)
- `INFORMATION_SCHEMA.VIEWS.VIEW_DEFINITION` was incorrect for views that were defined to select from other `INFORMATION_SCHEMA` tables. (Bug#30689)
- Issuing an `ALTER SERVER` statement to update the settings for a `FEDERATED` server would cause the `mysqld` to crash. (Bug#30671)
- The optimizer could ignore `ORDER BY` in cases when the result set is ordered by `filesort`, resulting in rows being returned in incorrect order. (Bug#30666)
- A different execution plan was displayed for `EXPLAIN` than would actually have been used for the `SELECT` because the test of sort keys for `ORDER BY` did not consider keys mentioned in `IGNORE KEYS FOR ORDER BY`. (Bug#30665)
- The `thread_handling` system variable was treated as having a `SESSION` value and as being settable at runtime. Now it has only a `GLOBAL` read-only value. (Bug#30651)
- On Windows, `LIMIT` arguments greater than  $2^{32}$  did not work correctly. (Bug#30639)
- `MyISAM` tables could not exceed 4294967295 ( $2^{32} - 1$ ) rows on Windows. (Bug#30638)
- A failed `HANDLER ... READ` operation could leave the table in a locked state. (Bug#30632)
- `mysql-test-run.pl` could not run `mysqld` with `root` privileges. (Bug#30630)
- The `mysqld_safe` script contained a syntax error. (Bug#30624)
- The optimization that uses a unique index to remove `GROUP BY` did not ensure that the index was actually used, thus violating the `ORDER BY` that is implied by `GROUP BY`. (Bug#30596)
- `SHOW STATUS LIKE 'Ssl_cipher_list'` from a MySQL client connected via SSL returned an empty string rather than a list of available ciphers. (Bug#30593)
- For `MEMORY` tables, `DELETE` statements that remove rows based on an index read could fail to remove all matching rows. (Bug#30590)
- Using `GROUP BY` on an expression of the form `timestamp_col DIV number` caused a server crash due to incorrect calculation of number of decimals. (Bug#30587)
- Executing a `SELECT COUNT(*)` query on an `InnoDB` table partitioned by `KEY` that used a `DOUBLE` column as the partition-

ing key caused the server to crash. ([Bug#30583](#))

- The options available to the `CHECK TABLE` statement were also allowed in `OPTIMIZE TABLE` and `ANALYZE TABLE` statements, but caused corruption during their execution. These options were never supported for these statements, and an error is now raised if you try to apply these options to these statements. ([Bug#30495](#))
- A self-referencing trigger on a partitioned table caused the server to crash instead of failing with an error. ([Bug#30484](#))
- The `mysql_change_user()` C API function did not correctly reset the character set variables to the values they had just after initially connecting. ([Bug#30472](#))
- When expanding a `*` in a `USING` or `NATURAL` join, the check for table access for both tables in the join was done using only the grant information of the first table. ([Bug#30468](#))
- When casting a string value to an integer, cases where the input string contained a decimal point and was long enough to overrun the `unsigned long long` type were not handled correctly. The position of the decimal point was not taken into account which resulted in miscalculated numbers and incorrect truncation to appropriate SQL data type limits. ([Bug#30453](#))
- Versions of `mysqldump` from MySQL 4.1 or higher tried to use `START TRANSACTION WITH CONSISTENT SNAPSHOT` if the `--single-transaction` and `--master-data` options were given, even with servers older than 4.1 that do not support consistent snapshots. ([Bug#30444](#))
- With `libmysqld`, use of prepared statements and the query cache at the same time caused problems. ([Bug#30430](#))
- Issuing a `DELETE` statement having both an `ORDER BY` clause and a `LIMIT` clause could cause `mysqld` to crash. ([Bug#30385](#))
- For `CREATE ... SELECT ... FROM`, where the resulting table contained indexes, adding `SQL_BUFFER_RESULT` to the `SELECT` part caused index corruption in the table. ([Bug#30384](#))
- The `Last_query_cost` status variable value can be computed accurately only for simple “flat” queries, not complex queries such as those with subqueries or `UNION`. However, the value was not consistently being set to 0 for complex queries. ([Bug#30377](#))
- The optimizer made incorrect assumptions about the value of the `is_member` value for user-defined functions, sometimes resulting in incorrect ordering of UDF results. ([Bug#30355](#))
- Queries that had a `GROUP BY` clause and selected `COUNT(DISTINCT bit_column)` returned incorrect results. ([Bug#30324](#))
- Some valid `euc-kr` characters having the second byte in the ranges `[0x41..0x5A]` and `[0x61..0x7A]` were rejected. ([Bug#30315](#))
- When loading a dynamic plugin on FreeBSD, the plugin would fail to load. This was due to a build error where the required symbols would be not exported correctly. ([Bug#30296](#))
- Simultaneous `ALTER TABLE` statements for `BLACKHOLE` tables caused 100% CPU use due to locking problems. ([Bug#30294](#))
- Setting certain values on a table using a spatial index could cause the server to crash. ([Bug#30286](#))
- Tables with a `GEOMETRY` column could be marked as corrupt if you added a non-`SPATIAL` index on a `GEOMETRY` column. ([Bug#30284](#))
- Flushing a merge table between the time it was opened and its child table were actually attached caused the server to crash. ([Bug#30273](#))

This regression was introduced by [Bug#26379](#).

- The query cache does not support retrieval of statements for which column level access control applies, but the server was still caching such statements, thus wasting memory. ([Bug#30269](#))
- Using `DISTINCT` or `GROUP BY` on a `BIT` column in a `SELECT` statement caused the column to be cast internally as an integer, with incorrect results being returned from the query. ([Bug#30245](#))
- `GROUP BY` on `BIT` columns produced incorrect results. ([Bug#30219](#))
- Short-format `mysql` commands embedded within `/*! ... */` comments were parsed incorrectly by `mysql`, which discarded the rest of the comment including the terminating `*/` characters. The result was a malformed (unclosed) comment. Now `mysql` does not discard the `*/` characters. ([Bug#30164](#))

- If the server crashed during an `ALTER TABLE` statement, leaving a temporary file in the database directory, a subsequent `DROP DATABASE` statement failed due to the presence of the temporary file. (Bug#30152)
- When `mysqldump` wrote `DROP DATABASE` statements within version-specific comments, it included the terminating semicolon in the wrong place, causing following statements to fail when the dump file was reloaded. (Bug#30126)
- It was not possible for client applications to distinguish between auto-set and auto-updated `TIMESTAMP` column values.  
To rectify this problem, a new `ON_UPDATE_NOW_FLAG` flag is set by `Field_timestamp` constructors whenever a column should be set to `NOW` on `UPDATE`, and the `get_schema_column_record()` function now reports whether a timestamp column is set to `NOW` on `UPDATE`. In addition, such columns now display `on update CURRENT_TIMESTAMP` in the `Extra` column in the output from `SHOW COLUMNS`. (Bug#30081)
- Some `INFORMATION_SCHEMA` tables are intended for internal use, but could be accessed by using `SHOW` statements. (Bug#30079)
- On some 64-bit systems, inserting the largest negative value into a `BIGINT` column resulted in incorrect data. (Bug#30069)
- `mysqlslap` did not properly handle multiple result sets from stored procedures. (Bug#29985)
- Specifying the `--without-geometry` option for `configure` caused server compilation to fail. (Bug#29972)
- Statements within stored procedures ignored the value of the `low_priority_updates` system variable. (Bug#29963)

See also Bug#26162.

- With auto-reconnect enabled, row fetching for a prepared statement could crash after reconnect occurred because loss of the statement handler was not accounted for. (Bug#29948)
- `mysqldump --skip-events --all-databases` dumped data from the `mysqld.event` table, and when restoring from this dump, events were created in spite of the `--skip-events` option. (Bug#29938)
- When `mysqlslap` was given a query to execute from a file via a `--query=file_name` option, it executed the query one too many times. (Bug#29803)
- `configure` did not find `nss` on some Linux platforms. (Bug#29658)
- It was possible when creating a partitioned table using `CREATE TABLE ... SELECT` to refer in the `PARTITION BY` clause to columns in the table being selected from, which could cause the server to crash. An example of such a statement is:

```
CREATE TABLE t1 (b INT)
PARTITION BY RANGE(t2.b) (
  PARTITION p1 VALUES LESS THAN (10),
  PARTITION p2 VALUES LESS THAN (20)
)
SELECT * FROM t2;
```

The fix is to disallow references in `PARTITION BY` clauses to columns not in the table being created. (Bug#29444)

- If a view used a function in its `SELECT` statement, the columns from the view were not inserted into the `INFORMATION_SCHEMA.COLUMNS` table. (Bug#29408)
- The `mysql` client program now ignores Unicode byte order mark (BOM) characters at the beginning of input files. Previously, it read them and sent them to the server, resulting in a syntax error.

Presence of a BOM does not cause `mysql` to change its default character set. To do that, invoke `mysql` with an option such as `--default-character-set=utf8`. (Bug#29323)

- For transactional tables, an error during a multiple-table `DELETE` statement did not roll back the statement. (Bug#29136)
- The `log` and `log_slow_queries` system variables were displayed by `SHOW VARIABLES` but could not be accessed in expressions as `@@log` and `@@log_slow_queries`. Also, attempting to set them with `SET` produced an incorrect `Unknown system variable` message. Now these variables are treated as synonyms for `general_log` and `slow_query_log`, which means that they can be accessed in expressions and their values can be changed with `SET`. (Bug#29131)
- Denormalized double-precision numbers cannot be handled properly by old MIPS processors. For IRIX, this is now handled by enabling a mode to use a software workaround. (Bug#29085)
- `SHOW VARIABLES` did not display the `relay_log`, `relay_log_index`, or `relay_log_info_file` system variables. (Bug#28893)
- When doing a `DELETE` on a table that involved a `JOIN` with `MyISAM` or `MERGE` tables and the `JOIN` referred to the same table, the operation could fail reporting `ERROR 1030 (HY000): Got error 134 from storage engine`. This was because scans on the table contents would change because of rows that had already been deleted. (Bug#28837)



- Killing an SSL connection on platforms where MySQL is compiled with `-DSIGNAL_WITH_VIO_CLOSE` (Windows, Mac OS X, and some others) could crash the server. (Bug#28812)
- `SHOW VARIABLES` did not correctly display the value of the `thread_handling` system variable. (Bug#28785)
- On Windows, `mysql_upgrade` created temporary files in `C:\` and did not clean them up. (Bug#28774)
- Index hints specified in view definitions were ignored when using the view to select from the base table. (Bug#28702)
- Views do not have indexes, so index hints do not apply. Use of index hints when selecting from a view is now disallowed. (Bug#28701)
- After changing the SQL mode to a restrictive value that would make already-inserted dates in a column be considered invalid, searches returned different results depending on whether the column was indexed. (Bug#28687)
- When running the MySQL Instance Configuration Wizard, a race condition could exist that would fail to connect to a newly configured instance. This was because `mysqld` had not completed the startup process before the next stage of the installation process. (Bug#28628)
- A `SELECT` in one connection could be blocked by `INSERT ... ON DUPLICATE KEY UPDATE` in another connection even when `low_priority_updates` is set. (Bug#28587)
- `mysql_upgrade` could run binaries dynamically linked against incorrect versions of shared libraries. (Bug#28560)
- The result from `CHAR( )` was incorrectly assumed in some contexts to return a single-byte result. (Bug#28550)
- `mysqldump` reversed the event name and program name in one of its error messages. (Bug#28535)
- If a `LIMIT` clause was present, the server could fail to consider indexes that could be used for `ORDER BY` or `GROUP BY`. (Bug#28404)
- The parser confused user-defined function (UDF) and stored function creation for `CREATE FUNCTION` and required that there be a default database when creating UDFs, although there is no such requirement. (Bug#28318, Bug#29816)
- Fast-mutex locking was not thread-safe and optimization-safe on some platforms, which could cause program failures such as out-of-memory errors. (Bug#28284)
- The result of a comparison between `VARBINARY` and `BINARY` columns differed depending on whether the `VARBINARY` column was indexed. (Bug#28076)
- The metadata in some `MYSQL_FIELD` members could be incorrect when a temporary table was used to evaluate a query. (Bug#27990)
- Partition pruning was not used for queries having `<=` or `>=` conditions in the `WHERE` clause on a table using `TO_DAYS( )` in the partitioning expression. (Bug#27927)
- `mysqlbinlog` produced incorrectly formatted `DATETIME` and `TIMESTAMP` values. (Bug#27894)
- Failure to log to the `general_log` or `slow_log` log tables were not logged to the error log at all or were logged incorrectly. (Bug#27858)
- An `ORDER BY` at the end of a `UNION` affected individual `SELECT` statements rather than the overall query result. (Bug#27848)
- `comp_err` created files with permissions such that they might be inaccessible during `make install` operations. (Bug#27789)
- `SHOW COLUMNS` returned `NULL` instead of the empty string for the `Default` value of columns that had no default specified. (Bug#27747)
- With recent versions of `DBD::mysql`, `mysqlhotcopy` generated table names that were doubly qualified with the database name. (Bug#27694)
- The anonymous accounts were not being created during MySQL installation. (Bug#27692)
- Some `SHOW` statements and `INFORMATION_SCHEMA` queries could expose information not allowed by the user's access privileges. (Bug#27629)
- `ALTER TABLE tbl_name ROW_FORMAT=format_type` did not cause the table to be rebuilt. (Bug#27610)
- A race condition between killing a statement and the thread executing the statement could lead to a situation such that the bin-

ary log contained an event indicating that the statement was killed, whereas the statement actually executed to completion. (Bug#27571)

- Some character mappings in the `ascii.xml` file were incorrect.

As a result of this bug fix, indexes must be rebuilt for columns that use the `ascii_general_ci` collation for columns that contain any of these characters: `'`', '['', '\', ']', '~'`. See Section 2.12.3, “Checking Whether Table Indexes Must Be Rebuilt”. (Bug#27562)

- Some queries using the `NAME_CONST()` function failed to return either a result or an error to the client, causing it to hang. This was due to the fact that there was no check to insure that both arguments to this function were constant expressions. (Bug#27545, Bug#32559)
- With the `read_only` system variable enabled, `CREATE DATABASE` and `DROP DATABASE` were allowed to users who did not have the `SUPER` privilege. (Bug#27440)
- For an event with an `ON COMPLETION` value of `PRESERVE`, an `ALTER EVENT` statement that specified no `ON COMPLETION` option caused the value to become `NOT PRESERVE`. (Bug#27407)
- MySQL failed to generate or retrieve an `AUTO_INCREMENT` primary key for `InnoDB` tables with user-defined partitioning. (Bug#27405)
- Changes to the `sql_mode` system variable were not tracked by `INSERT DELAYED`. (Bug#27358)
- A `SELECT` with more than 31 nested dependent subqueries returned an incorrect result. (Bug#27352)
- The `ExtractValue()` and `UpdateXML()` functions performed extremely slowly for large amounts of XML data (greater than 64 KB). These functions now execute approximately 2000 times faster than previously. (Bug#27287)
- On Windows, writes to the debug log were using `freopen()` instead of `fflush()`, resulting in slower performance. (Bug#27099)
- For a table that used different full-text parsers for different `FULLTEXT` indexes, `SHOW CREATE TABLE` displayed the first parser name for all of them. (Bug#27040)
- `STR_TO_DATE()` displayed an error message that referred to `STR_TO_TIME()`. (Bug#27014)
- The `mysql_insert_id()` C API function sometimes returned different results for `libmysqld` and `libmysqlclient`. (Bug#26921)
- Symbolic links on Windows could fail to work. (Bug#26811)
- `mysqld` sometimes miscalculated the number of digits required when storing a floating-point number in a `CHAR` column. This caused the value to be truncated, or (when using a debug build) caused the server to crash. (Bug#26788)

See also Bug#12860.

- `LOAD DATA INFILE` ran very slowly when reading large files into partitioned tables. (Bug#26527)
- It makes no sense to attempt to use `ALTER TABLE ... ORDER BY` to order an `InnoDB` table if there is a user-defined clustered index, because rows are always ordered by the clustered index. Such attempts now are ignored and produce a warning.

Also, in some cases, `InnoDB` incorrectly used a secondary index when the clustered index would produce a faster scan. `EXPLAIN` output now indicates use of the clustered index (for tables that have one) as lines with a `type` value of `index`, a `key` value of `PRIMARY`, and without `Using index` in the `Extra` value. (Bug#26447)

See also Bug#35850.

- Using `HANDLER` to open a table having a storage engine not supported by `HANDLER` properly returned an error, but also improperly prevented the table from being dropped by other connections. (Bug#25856)
- For a prepared statement `stmt`, changing the default database following `PREPARE stmt` but before `EXECUTE stmt` caused `stmt` to be recorded incorrectly in the binary log. (Bug#25843)
- `CREATE TABLE LIKE` did not work when the source table was an `INFORMATION_SCHEMA` table. (Bug#25629)
- Threads that were calculating the estimated number of records for a range scan did not respond to the `KILL` statement. That is, if a `range` join type is possible (even if not selected by the optimizer as a join type of choice and thus not shown by `EXPLAIN`), the query in the `statistics` state (shown by the `SHOW PROCESSLIST`) did not respond to the `KILL` statement. (Bug#25421)



- For InnoDB tables, `CREATE TABLE a AS SELECT * FROM A` would fail. (Bug#25164)
- For `mysql --show-warnings`, warnings were in some cases not displayed. (Bug#25146)
- The `returns` column of the `mysql.proc` table was `CHAR(64)`, which is not long enough to store long data types such as `ENUM` types. The column has been changed to `LONGBLOB` and a warning is generated if truncation occurs when storing a row into the `proc` table. (Bug#24923)
- If the expected precision of an arithmetic expression exceeded the maximum precision supported by MySQL, the precision of the result was reduced by an unpredictable or arbitrary amount, rather than to the maximum precision. In some cases, exceeding the maximum supported precision could also lead to a crash of the server. (Bug#24907)
- For Vista installs, `MySQLInstanceConfig.exe` did not add the default MySQL port to the firewall exceptions. It now provides a checkbox that enables the user a choice of whether to do this. (Bug#24853)
- A `CREATE TRIGGER` statement could cause a deadlock or server crash if it referred to a table for which a table lock had been acquired with `LOCK TABLES`. (Bug#23713)
- For storage engines that do not redefine `handler::index_next_same()` and are capable of indexes, statements that include a `WHERE` clause might select incorrect data. (Bug#22351)
- The parser treated the `INTERVAL()` function incorrectly, leading to situations where syntax errors could result depending on which side of an arithmetic operator the function appeared. (Bug#22312)
- Entries in the general query log were truncated at 1000 characters. (Bug#21557)
- A memory leak occurred when `CREATE TEMPORARY TABLE ... SELECT` was invoked from a stored function that in turn was called from `CREATE TABLE ... SELECT`. (Bug#21136)
- It was possible to execute `CREATE TABLE t1 ... SELECT ... FROM t2` with the `CREATE` privilege for `t1` and `SELECT` privilege for `t2`, even in the absence of the `INSERT` privilege for `t1`. (Bug#20901)
- Worked around an `icc` problem with an incorrect machine instruction being generated in the context of software pre-fetching after a subroutine got in-lined. (Upgrading to `icc 10.0.026` makes the workaround unnecessary.) (Bug#20803)
- If a column selected by a view referred to a stored function, the data type reported for the column in `INFORMATION_SCHEMA.COLUMNS` could be incorrect. (Bug#20550)
- The `mysql_change_user()` C API function changed the value of the `sql_big_selects` session variable. (Bug#20023)  
See also Bug#40363.
- Host names sometimes were treated as case sensitive in account-management statements (`CREATE USER`, `GRANT`, `REVOKE`, and so forth). (Bug#19828)
- Issuing an SQL `KILL` of the active connection caused an error on Mac OS X. (Bug#19723)
- The `readline` library has been updated to version 5.2. This addresses issues in the `mysql` client where history and editing within the client would fail to work as expected. (Bug#18431)
- The `-lmtmalloc` library was removed from the output of `mysql_config` on Solaris, as it caused problems when building `DBD:mysql` (and possibly other applications) on that platform that tried to use `dlopen()` to access the client library. (Bug#18322)
- `MySQLInstanceConfig.exe` failed to grant certain privileges to the `'root'@'%'` account. (Bug#17303)
- The `Aborted_clients` status variable was incremented twice if a client exited without calling `mysql_close()`. (Bug#16918)
- Use of `GRANT` statements with grant tables from an old version of MySQL could cause a server crash. (Bug#16470)
- Clients were ignoring the TCP/IP port number specified as the default port via the `--with-tcp-port` configuration option. (Bug#15327)
- Parameters of type `DATETIME` or `DATE` in stored procedures were silently converted to `VARBINARY`. (Bug#13675)
- Zero-padding of exponent values was not the same across platforms. (Bug#12860)
- Values of types `REAL ZEROFILL`, `DOUBLE ZEROFILL`, `FLOAT ZEROFILL`, were not zero-filled when converted to a character representation in the C prepared statement API. (Bug#11589)

- `mysql` stripped comments from statements sent to the server. Now the `--comments` or `--skip-comments` option can be used to control whether to retain or strip comments. The default is `--skip-comments`. (Bug#11230, Bug#26215)
  - Several buffer-size system variables were either being handled incorrectly for large values (for settings larger than 4GB, they were truncated to values less than 4GB without a warning), or were limited unnecessarily to 4GB even on 64-bit systems. The following changes were made:
    - For `key_buffer_size`, values larger than 4GB are allowed on 64-bit platforms.
    - For `join_buffer_size`, `sort_buffer_size`, and `myisam_sort_buffer_size`, values larger than 4GB are allowed on 64-bit platforms (except Windows, for which large values are truncated to 4GB with a warning).
- In addition, settings for `read_buffer_size` and `read_rnd_buffer_size` are limited to 2GB on all platforms. Larger values are truncated to 2GB with a warning. (Bug#5731, Bug#29419, Bug#29446)
- Executing `DISABLE KEYS` and `ENABLE KEYS` on a non-empty table would cause the size of the index file for the table to grow considerable. This was because the `DISABLE KEYS` operation would only mark the existing index, without deleting the index blocks. The `ENABLE KEYS` operation would re-create the index, adding new blocks, while the previous index blocks would remain. Existing indexes are now dropped and recreated when the `ENABLE KEYS` statement is executed. (Bug#4692)
  - Grant table checks failed in `libmysqld`.

## C.2.16. Changes in MySQL 5.1.22 (24 September 2007 Release Candidate)

Functionality added or changed:

- There is a new `innodb_autoinc_lock_mode` system variable to configure the locking behavior that InnoDB uses for generating auto-increment values. The default behavior now is slightly different from before, which involves a minor incompatibility for multiple-row inserts that specify an explicit value for the auto-increment column in some but not all rows. See Section 13.6.4.3, “`AUTO_INCREMENT` Handling in InnoDB”.

Bugs fixed:

- **MySQL Cluster: Replication:** (Replication): Multi-master replication setups did not handle `--log-slave-updates` correctly. (Bug#30017)
- **MySQL Cluster:** Backups of `TIMESTAMP` columns made with `ndb_restore` on a MySQL Cluster using data nodes hosts of one endian could not be used to restore the cluster's data to data node hosts of the other endian. (Bug#30134)
- **Replication:** Row-based replication from a pre-5.1.22 MySQL Server to a MySQL 5.1.22 was unstable due to an uninitialized variable. (Bug#31076)
- **Replication:** Operations that used the time zone replicated the time zone only for successful operations, but did not replicate the time zone for errors that need to know it. (Bug#29536)
- For an InnoDB table if a `SELECT` was ordered by the primary key and also had a `WHERE field = value` clause on a different field that was indexed, a `DESC` order instruction would be ignored. (Bug#31001)
- `mysql_install_db` could fail to find its message file. (Bug#30678)
- Memory corruption occurred for some queries with a top-level `OR` operation in the `WHERE` condition if they contained equality predicates and other sargable predicates in disjunctive parts of the condition. (Bug#30396)
- `CONNECTION_ID()` always returned 0 for the embedded server (`libmysqld`). (Bug#30389)
- The server created temporary tables for filesort operations in the working directory, not in the directory specified by the `tmpdir` system variable. (Bug#30287)
- Using `KILL QUERY` or `KILL CONNECTION` to kill a `SELECT` statement caused a server crash if the query cache was enabled. (Bug#30201)
- `mysqldump` from the MySQL 5.1.21 distribution could not be used to create a dump from a MySQL 5.1.20 or older server. (Bug#30123)
- Under some circumstances, a UDF initialization function could be passed incorrect argument lengths. (Bug#29804)
- When using a combination of `HANDLER . . . READ` and `DELETE` on a table, MySQL continued to open new copies of the ta-

ble every time, leading to an exhaustion of file descriptors. (Bug#29474)

This regression was introduced by Bug#21587.

- The `mysql_list_fields()` C API function incorrectly set `MYSQL_FIELD::decimals` for some view columns. (Bug#29306)
- Tables using the InnoDB storage engine incremented `AUTO_INCREMENT` values incorrectly with `ON DUPLICATE KEY UPDATE`. (Bug#28781)
- Non-range queries of the form `SELECT ... FROM ... WHERE keypart1=constant, ..., keypartN=constant ORDER BY ... FOR UPDATE` sometimes were unnecessarily blocked waiting for a lock if another transaction was using `SELECT ... FOR UPDATE` on the same table. (Bug#28570)
- On Windows, symbols for yaSSL and taocrypt were missing from `mysqlclient.lib`, resulting in unresolved symbol errors for clients linked against that library. (Bug#27861)
- Read lock requests that were blocked by a pending write lock request were not allowed to proceed if the statement requesting the write lock was killed. (Bug#21281)

## C.2.17. Changes in MySQL 5.1.21 (16 August 2007)

This is a new Beta development release, fixing recently discovered bugs.

### Note

This Beta release, as any other pre-production release, should not be installed on *production* level systems or systems with critical data. It is good practice to back up your data before installing any new version of software. Although MySQL has worked very hard to ensure a high level of quality, protect your data by making a backup as you would for any software beta release. Please refer to our bug database at <http://bugs.mysql.com/> for more details about the individual bugs fixed in this version.

### Note

Subsequent to release, it was discovered that on some platforms, `mysql_install_db` could fail to find its message file, resulting in error messages of the following form:

```
shell> mysql_install_db
Installing MySQL system tables...
070830 9:33:24 [ERROR] Can't find messagefile 'path/share/english/errmsg.sys'
070830 9:33:24 [ERROR] Aborting
```

To deal with this problem, specify a `--language` option to specify the proper path name to the language file directory. For example:

```
shell> mysql_install_db --language=/path/to/share/english/
```

This problem is corrected in MySQL 5.1.22.

This section documents all changes and bug fixes that have been applied since the last official MySQL release. If you would like to receive more fine-grained and personalized *update alerts* about fixes that are relevant to the version and features you use, please consider subscribing to *MySQL Enterprise* (a commercial MySQL offering). For more details please see <http://www.mysql.com/products/enterprise>.

Functionality added or changed:

- **Incompatible Change:** In MySQL 5.1.6, when log tables were implemented, the default log destination for the general query and slow query log was `TABLE`. This default has been changed to `FILE`, which is compatible with MySQL 5.0, but incompatible with earlier releases of MySQL 5.1 from 5.1.6 to 5.1.20. If you are upgrading from MySQL 5.0 to 5.1.21 or higher, no logging option changes should be necessary. However, if you are upgrading from 5.1.6 through 5.1.20 to 5.1.21 or higher and were using `TABLE` logging, use the `--log-output=TABLE` option explicitly to preserve your server's table-logging behavior.

A further fix for this issue was made in MySQL 5.1.23. (Bug#29993)

- **Incompatible Change:** The `innodb_log_arch_dir` system variable (which has been deprecated since MySQL 5.0.24) has been removed and should no longer be used.
- **Incompatible Change:** On Windows only, the `mysqld-nt` has been removed from this release and all future releases. The

`mysqld` server now includes named-pipe support as standard, and you do not have to use the `mysqld-nt` version to enable named-pipe support.

- **Important Change:** The default `mysqld_safe` logging behavior now is `--skip-syslog` rather than `--syslog`, which is compatible with the default behavior of writing an error log file for releases prior to 5.1.20.
- **Replication:** The SQL thread on a slave now is always allowed to enter `InnoDB` even if this would exceed the limit imposed by the `innodb_thread_concurrency` system variable. In cases of high load on the slave server (when `innodb_thread_concurrency` is reached), this change helps the slave stay more up to date with the master; in the previous behavior, the SQL thread was competing for resources with all client threads active on the slave server. (Bug#25078)
- **Replication:** Replication between master and slaves now supports different column numbers within a table on both master and slave. The rules for replication where the table definitions are different has also changed. This supercedes the functionality for replication from the master table to a slave table with more columns that was added in MySQL 5.1.12. For more information, see [Section 16.3.1.4, “Replication with Differing Tables on Master and Slave”](#).
- Several programs now accept `--debug-check` and `--debug-info` options: `mysql`, `mysqladmin`, `mysqlbinlog`, `mysqlcheck`, `mysqldump`, `mysqlimport`, `mysqlshow`, `mysqlslap`, `mysqltest`, `mysql_upgrade`. (Note: `mysql`, `mysqladmin`, `mysqlcheck`, `mysqldump`, `mysqlimport`, `mysqlshow`, and `mysqltest` already accepted `--debug-info`.) `--debug-check` prints debugging information at program exit. `--debug-info` is similar but also prints memory and CPU usage statistics. This patch also corrects a problem for `mysql` that `--debug-info` did not display statistics at exit time. (Bug#30127)
- The `--syslog` option that was introduced in 5.1.20 for `mysqld_safe` (to send error output to `syslog`) did not work correctly: Error output was buffered and not logged immediately. This has been corrected. In addition, some feature changes were made:

### Important

The default `mysqld_safe` logging behavior now is `--skip-syslog` rather than `--syslog`, which is compatible with the default behavior of writing an error log file for releases prior to 5.1.20.

- A new option, `--syslog-tag=tag`, modifies the default tags written by `mysqld_safe` and `mysqld` to `syslog` to be `mysqld_safe-tag` and `mysqld-tag` rather than the default tags of `mysqld_safe` and `mysqld`. (Bug#29992)
- Transaction support in the `FEDERATED` storage engine has been disabled due to issues with multiple active transactions and sessions on the same `FEDERATED` table. (Bug#29875)
- Previously, prepared statements processed using `PREPARE` and `EXECUTE` were not subject to caching in the query cache if they contained any `?` parameter markers. This limitation has been lifted. (Bug#29318)
- It is now possible to set `long_query_time` in microseconds or to 0. Setting this value to 0 causes all queries to be recorded in the slow query log.

Currently, fractional values can be used only when logging to files. We plan to provide this functionality for logging to tables when time-related data types are enhanced to support microsecond resolution. (Bug#25412)

- `INFORMATION_SCHEMA` implementation changes were made that optimize certain types of queries for `INFORMATION_SCHEMA` tables so that they execute more quickly. [Section 7.2.20, “INFORMATION\\_SCHEMA Optimization”](#), provides guidelines on how to take advantage of these optimizations by writing queries that minimize the need for the server to access the file system to obtain the information contained in `INFORMATION_SCHEMA` tables. By writing queries that enable the server to avoid directory scans or opening table files, you will obtain better performance. (Bug#19588)
- Log table locking was redesigned, eliminating several lock-related problems:
  - Truncating `mysql.slow_log` in a stored procedure after use of a cursor caused the thread to lock.
  - Flushing a log table resulted in unnecessary warnings.
  - The server would hang when performing concurrent `ALTER TABLE` or `TRUNCATE TABLE` statements against the log tables.
  - Changing the value of the `general_log` system variable while a global read lock was in place resulted in deadlock.

The changes provide better-defined interface characteristics. See [Section 5.2.1, “Selecting General Query and Slow Query Log Output Destinations”](#). (Bug#17876, Bug#23044, Bug#25422, Bug#29129)

- Added the `--commit`, `--detach`, `--post-system`, and `--pre-system` options for `mysqlslap`.

- A new option, `--syslog-tag=tag`, modifies the default tags written by `mysqld_safe` and `mysqld` to syslog to be `mysqld_safe-tag` and `mysqld-tag` rather than the default tags of `mysqld_safe` and `mysqld`.
- Two options relating to slow query logging have been added for `mysqld`. `--log-slow-slave-statements` causes slow statements executed by a replication slave to be written to the slow query log; `min_examined_row_limit` can be used to cause queries which examine fewer than the stated number of rows not to be logged.

Bugs fixed:

- **Incompatible Change:** Failure to consider collation when comparing space characters could result in incorrect index entry order, leading to incorrect comparisons, inability to find some index values, misordered index entries, misordered `ORDER BY` results, or tables that `CHECK TABLE` reports as having corrupt indexes.

As a result of this bug fix, indexes must be rebuilt for columns that use any of these character sets: `uucjpm8`, `uuc_kr`, `gb2312`, `latin7`, `macce`, `ujis`. See [Section 2.12.3, “Checking Whether Table Indexes Must Be Rebuilt”](#). (Bug#29461)

- **Incompatible Change:** Several issues were identified for stored programs (stored procedures and functions, triggers, and events) and views containing non-ASCII symbols. These issues involved conversion errors due to incomplete character set information when translating these objects to and from stored format, such as:
  - Parsing the original object definition so that it can be stored.
  - Compiling the stored definition into executable form when the object is invoked.
  - Retrieval of object definitions from `INFORMATION_SCHEMA` tables.
  - Displaying the object definition in `SHOW` statements. This issue also affected `mysqldump`, which uses `SHOW`.

The fix for the problems is to store character set information from the object creation context so that this information is available when the object needs to be used later. The context includes the client character set, the connection character set and collation, and the collation of the database with which the object is associated.

As a result of the patch, several tables have new columns:

- In the `mysql` database, the `proc` and `event` tables now have these columns: `character_set_client`, `collation_connection`, `db_collation`, `body_utf8`.
- In `INFORMATION_SCHEMA`, the `VIEWS` table now has these columns: `CHARACTER_SET_CLIENT`, `COLLATION_CONNECTION`. The `ROUTINES`, `TRIGGERS`, and `EVENTS` tables now have these columns: `CHARACTER_SET_CLIENT`, `COLLATION_CONNECTION`, `DATABASE_COLLATION`.

These columns store the session values of the `character_set_client` and `collation_connection` system variables, and the collation of the database with which the object is associated. The values are those in effect at object creation time. (The saved database collation is not the value of the `collation_database` system variable, which applies to the default database; the database that contains the object is not necessarily the default database.)

Several `SHOW` statements now display additional columns corresponding to the new table columns. These statements are: `SHOW CREATE EVENT`, `SHOW CREATE FUNCTION`, `SHOW CREATE PROCEDURE`, `SHOW CREATE VIEW`, `SHOW EVENTS`, `SHOW FUNCTION STATUS`, `SHOW PROCEDURE STATUS`, `SHOW TRIGGERS`.

A new statement, `SHOW CREATE TRIGGER` is introduced and is used by `mysqldump` for producing `CREATE TRIGGER` statements.

Subsequent to the patch just described, it was discovered that the patch broke `mysql_upgrade`; this has been corrected.

### Important

The fixes for the problems just describe affect *all* existing stored programs and views. (For example, you will see warnings about “no creation context.”) To avoid warnings from the server about the use of old definitions from any release prior to 5.1.21, you should dump stored programs and views with `mysqldump` after upgrading to 5.1.21, and then reload them to recreate them with new definitions. Invoke `mysqldump` with a `--default-character-set` option that names the non-ASCII character set that was used for the definitions when the objects were originally defined.

(Bug#25221, Bug#21249, Bug#30027, Bug#16291, Bug#11986, Bug#25212, Bug#19443, Bug#30029)

- **MySQL Cluster: Replication:** (Replication): Inconsistencies could occur between the master and the slave when replicating Disk Data tables. (Bug#19259, Bug#19227)

- **MySQL Cluster:** `DELETE FROM table WHERE primary_key IN (value_list)`, where the `value_list` contained more than one value, called from an `AFTER DELETE` trigger on an NDB table, caused `mysqld` to crash. (Bug#30337)
- **MySQL Cluster:** When restarting a data node, queries could hang during that node's start phase 5, and continue only after the node had entered phase 6. (Bug#29364)
- **MySQL Cluster:** Replica redo logs were inconsistently handled during a system restart. (Bug#29354)
- **MySQL Cluster:** When a node failed to respond to a `COPY_GCI` signal as part of a global checkpoint, the master node was killed instead of the node that actually failed. (Bug#29331)
- **MySQL Cluster:** An invalid comparison made during `REDO` validation that could lead to an `ERROR WHILE READING REDO LOG` condition. (Bug#29118)
- **MySQL Cluster:** The wrong data pages were sometimes invalidated following a global checkpoint. (Bug#29067)
- **MySQL Cluster:** If at least 2 files were involved in `REDO` invalidation, then file 0 of page 0 was not updated and so pointed to an invalid part of the redo log. (Bug#29057)
- **MySQL Cluster:** If a storage engine has its own logging capability, then any statement using both this engine and some other engine not having its own logging could not be correctly logged, due to the fact that entries from one engine could be logged before entries from the other engine were. This did not generate any error messages when it occurred.

Now, if multiple storage engines are used in a statement and at least one of them has its own logging capability, then an error message is generated and the statement is not executed.

### Note

Currently, the only storage engine to have its own logging capability is `NDBCLUSTER`.

(Bug#28722)

- **MySQL Cluster:** Warnings and errors generated by `ndb_config --config-file=file` were sent to `stdout`, rather than to `stderr`. (Bug#25941)
- **MySQL Cluster:** When a cluster backup was terminated using the `ABORT BACKUP` command in the management client, a misleading error message `BACKUP ABORTED BY APPLICATION: PERMANENT ERROR: INTERNAL ERROR` was returned. The error message returned in such cases now reads `BACKUP ABORTED BY USER REQUEST`. (Bug#21052)
- **MySQL Cluster:** Large file support did not work in AIX server binaries. (Bug#10776)
- **Replication:** The thread ID was not reset properly after execution of `mysql_change_user()`, which could cause replication failure when replicating temporary tables. (Bug#29734)
- **Replication:** Storage engine error conditions in row-based replication were not correctly reported to the user. (Bug#29570)
- **Replication:** `INSERT DELAYED` statements on a master server are replicated as non-`DELAYED` inserts on slaves (which is normal, to preserve serialization), but the inserts on the slave did not use concurrent inserts. Now `INSERT DELAYED` on a slave is converted to a concurrent insert when possible, and to a normal insert otherwise. (Bug#29152)
- **Replication:** An error that happened inside `INSERT`, `UPDATE`, or `DELETE` statements performed from within a stored function or trigger could cause inconsistency between master and slave servers. (Bug#27417)
- **Replication:** Slave servers could incorrectly interpret an out-of-memory error from the master and reconnect using the wrong binary log position. (Bug#24192)
- **Replication:** Using the `READ COMMITTED` transaction isolation level caused mixed and statement-based replication to fail. (Bug#23051)
- **Disk Data:** Performing Disk Data schema operations during a node restart could cause forced shutdowns of other data nodes. (Bug#29501)
- **Disk Data:** When dropping a page, the stack's bottom entry could sometime be left "cold" rather than "hot", violating the rules for stack pruning. (Bug#29176)
- **Disk Data:** Disk data meta-information that existed in `ndbd` might not be visible to `mysqld`. (Bug#28720)
- **Disk Data:** The number of free extents was incorrectly reported for some tablespaces. (Bug#28642)
- **Cluster Replication:** When executing a statement where `binlog_format = statement`, the result of the statement was logged both as a statement and as rows. (Bug#29222)



- **Cluster Replication:** `mysqld` would segfault on startup when the `NDB` storage engine was enabled and the default character set was a strictly multi-byte character set such as UCS2.

This issue does *not* apply to character sets that can contain single-byte characters in addition to multi-byte characters such as UTF-8.

Additional issues remain with regard to the use of multi-byte character sets in MySQL Cluster Replication; see [Known Issues in MySQL Cluster Replication](#), for more information. (Bug#27404)

- Prepared statements containing `CONNECTION_ID()` could be written improperly to the binary log. (Bug#30200)
- Use of local variables with non-ASCII names in stored procedures crashed the server. (Bug#30120)
- On Windows, client libraries lacked symbols required for linking. (Bug#30118)
- `--myisam-recover=''` (empty option value) did not disable `MyISAM` recovery. (Bug#30088)
- For the `SHOW TABLE TYPES` statement, the server sent incorrect output to clients, possibly causing them to crash. (Bug#30036)
- The `IS_UPDATABLE` column in the `INFORMATION_SCHEMA.VIEWS` table was not always set correctly. (Bug#30020)
- `SHOW` statements were being written to the slow query log that should not have been. (Bug#30000)
- `REPAIR TABLE ... USE_FRM` could corrupt tables. (Bug#29980)
- For `MyISAM` tables on Windows, `INSERT`, `DELETE`, or `UPDATE` followed by `ALTER TABLE` within `LOCK TABLES` could cause table corruption. (Bug#29957)
- `LOCK TABLES` did not pre-lock tables used in triggers of the locked tables. Unexpected locking behavior and statement failures similar to `FAILED: 1100: TABLE 'xx' WAS NOT LOCKED WITH LOCK TABLES` could result. (Bug#29929)
- `INSERT ... VALUES(CONNECTION_ID(), ...)` statements were written to the binary log in such a way that they could not be properly restored. (Bug#29928)
- Adding `DISTINCT` could cause incorrect rows to appear in a query result. (Bug#29911)
- On Windows, the CMake build process did not produce the embedded server library or related binaries. (Bug#29903)
- Using the `DATE()` function in a `WHERE` clause did not return any records after encountering `NULL`. However, using `TRIM` or `CAST` produced the correct results. (Bug#29898)
- `SESSION_USER()` returned garbage data (rather than the correct value of the empty string) when executed by a slave SQL thread. (Bug#29878)
- Very long prepared statements in stored procedures could cause a server crash. (Bug#29856)
- If query execution involved a temporary table, `GROUP_CONCAT()` could return a result with an incorrect character set. (Bug#29850)
- If one thread was performing concurrent inserts, other threads reading from the same table using equality key searches could see the index values for new rows before the data values had been written, leading to reports of table corruption. (Bug#29838)
- Repeatedly accessing a view in a stored procedure (for example, in a loop) caused a small amount of memory to be allocated per access. Although this memory is deallocated on disconnect, it could be a problem for a long running stored procedures that make repeated access of views. (Bug#29834)
- `mysqldump` produced output that incorrectly discarded the `NO_AUTO_VALUE_ON_ZERO` value of the `sql_mode` variable after dumping triggers. (Bug#29788)
- An assertion failure occurred within `yaSSL` for very long keys. (Bug#29784)
- For `MEMORY` tables, the `index_merge` union access method could return incorrect results. (Bug#29740)
- Comparison of `TIME` values using the `BETWEEN` operator led to string comparison, producing incorrect results in some cases. Now the values are compared as integers. (Bug#29739)
- For a table with a `DATE` column `date_col` such that selecting rows with `WHERE date_col = 'date_val 00:00:00'` yielded a non-empty result, adding `GROUP BY date_col` caused the result to be empty. (Bug#29729)
- In some cases, `INSERT INTO ... SELECT ... GROUP BY` could insert rows even if the `SELECT` by itself produced an

- empty result. ([Bug#29717](#))
- Single-row inserts could report a row count greater than one. ([Bug#29692](#))
  - For the embedded server, the `mysql_stmt_store_result()` C API function caused a memory leak for empty result sets. ([Bug#29687](#))
  - `EXPLAIN` produced `Impossible where` for statements of the form `SELECT ... FROM t WHERE c=0`, where `c` was an `ENUM` column defined as a primary key. ([Bug#29661](#))
  - On Windows, `ALTER TABLE` hung if records were locked in share mode by a long-running transaction. ([Bug#29644](#))
  - `mysqld_safe` produced error messages and did not create the error log file under some circumstances. ([Bug#29634](#))
  - On 64-bit platforms, the filesort code (for queries with `GROUP BY` or `ORDER BY`) could crash due to an incorrect pointer size. ([Bug#29610](#))
  - A left join between two views could produce incorrect results. ([Bug#29604](#))
  - Certain statements with unions, subqueries, and joins could result in huge memory consumption. ([Bug#29582](#))
  - Clients using SSL could hang the server. ([Bug#29579](#))
  - A slave running with `--log-slave-updates` would fail to write `INSERT DELAY IGNORE` statements to its binary log, resulting in different binary log contents on the master and slave. ([Bug#29571](#))
  - An incorrect result was returned when comparing string values that were converted to `TIME` values with `CAST()`. ([Bug#29555](#))
  - `gcov` coverage-testing information was not written if the server crashed. ([Bug#29543](#))
  - In the `ascii` character set, conversion of `DEL (0x7F)` to Unicode incorrectly resulted in `QUESTION MARK (0x3F)` rather than `DEL`. ([Bug#29499](#))
  - A field packet with `NULL` fields caused a `libmysqlclient` crash. ([Bug#29494](#))
  - On Windows, the `mysql` client died if the user entered a statement and Return after entering Control-C. ([Bug#29469](#))
  - The full-text parser could enter an infinite loop if it encountered an illegal multi-byte sequence or a sequence that has no mapping to Unicode. ([Bug#29464](#))
  - Searching a `FULLTEXT` index for a word with the boolean mode truncation operator could cause an infinite loop. ([Bug#29445](#))
  - Corrupt data resulted from use of `SELECT ... INTO OUTFILE 'file_name' FIELDS ENCLOSED BY 'c'`, where `c` is a digit or minus sign, followed by `LOAD DATA INFILE 'file_name' FIELDS ENCLOSED BY 'c'`. ([Bug#29442](#))
  - Killing an `INSERT DELAYED` thread caused a server crash. ([Bug#29431](#))
  - Use of `SHOW BINLOG EVENTS` for a non-existent log file followed by `PURGE BINARY LOGS` caused a server crash. ([Bug#29420](#))
  - Assertion failure could occur for grouping queries that employed `DECIMAL` user variables with assignments to them. ([Bug#29417](#))
  - For `CAST(expr AS DECIMAL(M,D))`, the limits of 65 and 30 on the precision (`M`) and scale (`D`) were not enforced. ([Bug#29415](#))
  - Deleting from a `CSV` table could corrupt it. ([Bug#29411](#))
  - Results for a select query that aliases the column names against a view could duplicate one column while omitting another. This bug could occur for a query over a multiple-table view that includes an `ORDER BY` clause in its definition. ([Bug#29392](#))
  - `mysqldump` created a stray file when a given a too-long file name argument. ([Bug#29361](#))
  - The special “zero” `ENUM` value was coerced to the normal empty string `ENUM` value during a column-to-column copy. This affected `CREATE ... SELECT` statements and `SELECT` statements with aggregate functions on `ENUM` columns in the `GROUP BY` clause. ([Bug#29360](#))
  - Inserting a negative number into a `CSV` table could corrupt it. ([Bug#29353](#))
  - Optimization of queries with `DETERMINISTIC` stored functions in the `WHERE` clause was ineffective: A sequential scan was



always used. (Bug#29338)

- MyISAM corruption could occur with the `cp932_japanese_ci` collation for the `cp932` character set due to incorrect comparison for trailing space. (Bug#29333)
- For updates to InnoDB tables, a `TIMESTAMP` column with the `ON UPDATE CURRENT_TIMESTAMP` attribute could be updated even when no values actually changed. (Bug#29310)
- `FULLTEXT` indexes could be corrupted by certain `gbk` characters. (Bug#29299)
- `SELECT ... INTO OUTFILE` followed by `LOAD DATA` could result in garbled characters when the `FIELDS ENCLOSED BY` clause named a delimiter of `'0'`, `'b'`, `'n'`, `'r'`, `'t'`, `'N'`, or `'Z'` due to an interaction of character encoding and doubling for data values containing the enclosed-by character. (Bug#29294)
- Sort order of the collation wasn't used when comparing trailing spaces. This could lead to incorrect comparison results, incorrectly created indexes, or incorrect result set order for queries that include an `ORDER BY` clause. (Bug#29261)
- `CHECK TABLE` could erroneously report table corruption for a `CSV` table if multiple threads were modifying the table at the same time. (Bug#29253)
- Many threads accessing a `CSV` table simultaneously could cause an assertion failure. (Bug#29252)
- If an `ENUM` column contained `' '` as one of its members (represented with numeric value greater than 0), and the column contained error values (represented as 0 and displayed as `' '`), using `ALTER TABLE` to modify the column definition caused the 0 values to be given the numeric value of the nonzero `' '` member. (Bug#29251)
- Calling `mysql_options()` after `mysql_real_connect()` could cause clients to crash. (Bug#29247)
- `CHECK TABLE` for `ARCHIVE` tables could falsely report table corruption or cause a server crash. (Bug#29207)
- Mixing binary and `utf8` columns in a union caused field lengths to be calculated incorrectly, resulting in truncation. (Bug#29205)
- `AsText()` could fail with a buffer overrun. (Bug#29166)
- Under some circumstances, a `SELECT ... FROM mysql.event` could cause the server to crash. (Bug#29156)
- InnoDB refused to start on some versions of FreeBSD with LinuxThreads. This is fixed by enabling file locking on FreeBSD. (Bug#29155)
- `LOCK TABLES` was not atomic when more than one InnoDB tables were locked. (Bug#29154)
- `mysqld` failed to exit during shutdown. (Bug#29133)
- A network structure was initialized incorrectly, leading to embedded server crashes. (Bug#29117)
- An assertion failure occurred if a query contained a conjunctive predicate of the form `view_column = constant` in the `WHERE` clause and the `GROUP BY` clause contained a reference to a different view column. The fix also enables application of an optimization that was being skipped if a query contained a conjunctive predicate of the form `view_column = constant` in the `WHERE` clause and the `GROUP BY` clause contained a reference to the same view column. (Bug#29104)
- A maximum of 4TB InnoDB free space was reported by `SHOW TABLE STATUS`, which is incorrect on systems with more than 4TB space. (Bug#29097)
- If an `INSERT INTO ... SELECT` statement inserted into the same table that the `SELECT` retrieved from, and the `SELECT` included `ORDER BY` and `LIMIT` clauses, different data was inserted than the data produced by the `SELECT` executed by itself. (Bug#29095)
- Queries that performed a lookup into a `BINARY` index containing key values ending with spaces caused an assertion failure for debug builds and incorrect results for non-debug builds. (Bug#29087)
- The semantics of `BIGINT` depended on platform-specific characteristics. (Bug#29079)
- A byte-order issue in writing a spatial index to disk caused bad index files on some systems. (Bug#29070)
- Creation of a legal stored procedure could fail if no default database had been selected. (Bug#29050)
- `REPLACE`, `INSERT IGNORE`, and `UPDATE IGNORE` did not work for `FEDERATED` tables. (Bug#29019)
- Inserting into InnoDB tables and executing `RESET MASTER` in multiple threads cause assertion failure in debug server binaries. (Bug#28983)

- Updates to a `CSV` table could cause a server crash or update the table with incorrect values. (Bug#28971)
- For a `ucs2` column, `GROUP_CONCAT()` did not convert separators to the result character set before inserting them, producing a result containing a mixture of two different character sets. (Bug#28925)
- Dropping the definer of an active event caused the server to crash. (Bug#28924)
- For a join with `GROUP BY` and/or `ORDER BY` and a view reference in the `FROM` list, the query metadata erroneously showed empty table aliases and database names for the view columns. (Bug#28898)
- Creating an event using `ON SCHEDULE AT CURRENT_TIMESTAMP + INTERVAL ...` could in some cases cause `mysqld` to crash. (Bug#28881)
- Coercion of ASCII values to character sets that are a superset of ASCII sometimes was not done, resulting in `ILLEGAL MIX OF COLLATIONS` errors. These cases now are resolved using repertoire, a new string expression attribute (see Section 9.1.7, “String Repertoire”). (Bug#28875)
- Executing `ALTER EVENT` on an event whose definer's event creation privileges had been revoked cause the server to crash. (Bug#28873)
- `ALTER VIEW` is not supported as a prepared statement but was not being rejected. `ALTER VIEW` is now prohibited as a prepared statement or when called within stored routines. (Bug#28846)
- In strict SQL mode, errors silently stopped the SQL thread even for errors named using the `--slave-skip-errors` option. (Bug#28839)
- Fast `ALTER TABLE` (that works without rebuilding the table) acquired duplicate locks in the storage engine. In `MyISAM`, if `ALTER TABLE` was issued under `LOCK TABLE`, it caused all data inserted after `LOCK TABLE` to disappear. (Bug#28838)
- Runtime changes to the `log_queries_not_using_indexes` system variable were ignored. (Bug#28808)
- Selecting a column not present in the selected-from table caused an extra error to be produced by `SHOW ERRORS`. (Bug#28677)
- Creating an event to be executed at a time close to the end of the allowed range (2038-01-19 03:14:07 UTC) would cause the server to crash. (Bug#28641)
- For a statement of the form `CREATE t1 SELECT integer_constant`, the server created the column using the `DECIMAL` data type for large negative values that are within the range of `BIGINT`. (Bug#28625)
- Starting the server with an `innodb_force_recovery` value of 4 did not work. (Bug#28604)
- For `InnoDB` tables, MySQL unnecessarily sorted records in certain cases when the records were retrieved by `InnoDB` in the proper order already. (Bug#28591)
- `mysql_install_db` could fail to find script files that it needs. (Bug#28585)
- If a stored procedure was created and invoked prior to selecting a default database with `USE`, a `NO DATABASE SELECTED` error occurred. (Bug#28551)
- On Mac OS X, shared-library installation path names were incorrect. (Bug#28544)
- Using the `--skip-add-drop-table` option with `mysqldump` generated incorrect SQL if the database included any views. The recreation of views requires the creation and removal of temporary tables. This option suppressed the removal of those temporary tables. The same applied to `--compact` since this option also invokes `--skip-add-drop-table`. (Bug#28524)
- `mysqlbinlog --hexdump` generated incorrect output due to omission of the “#” comment character for some comment lines. (Bug#28293)
- `InnoDB` could crash if the server was shut down while `innodb_table_monitor` was running. (Bug#28254)
- A race condition in the interaction between `MyISAM` and the query cache code caused the query cache not to invalidate itself for concurrently inserted data. (Bug#28249)
- A duplicate-key error message could display an incorrect key value when not all columns of the key were used to select rows for update. (Bug#28158)
- Indexing column prefixes in `InnoDB` tables could cause table corruption. (Bug#28138)
- Index creation could fail due to truncation of key values to the maximum key length rather than to a multiple of the maximum

- character length. ([Bug#28125](#))
- Instance Manager had a race condition when it received a shutdown request while a guarded `mysqld` instance was starting such that it could fail to stop the `mysqld` instance. ([Bug#28030](#))
  - `SELECT . . . FOR UPDATE` with partitioned tables could cause a server crash. ([Bug#28026](#))
  - On Windows, Instance Manager would crash if an instance object failed to initialize during startup. This could happen if an incorrect `mysqld` path was supplied in the configuration file. ([Bug#28012](#))
  - The `LOCATE ( )` function returned `NULL` if any of its arguments evaluated to `NULL`. Likewise, the predicate, `LOCATE(str, NULL) IS NULL`, erroneously evaluated to `FALSE`. ([Bug#27932](#))
  - Dropping a user-defined function could cause a server crash if the function was still in use by another thread. ([Bug#27564](#))
  - For some event-creation problems, the server displayed messages that implied the problems were errors when they were only warnings. ([Bug#27406](#))
  - Unsafe aliasing in the source caused a client library crash when compiled with `gcc 4` at high optimization levels. ([Bug#27383](#))
  - Index-based range reads could fail for comparisons that involved contraction characters (such as `ch` in Czech or `ll` in Spanish). ([Bug#27345](#))
  - Aggregations in subqueries that refer to outer query columns were not always correctly referenced to the proper outer query. ([Bug#27333](#))
  - Error returns from the `time ( )` system call were ignored. ([Bug#27198](#))
  - Phantom reads could occur under `InnoDB SERIALIZABLE` isolation level. ([Bug#27197](#))
  - The `SUBSTRING ( )` function returned the entire string instead of an empty string when it was called from a stored procedure and when the length parameter was specified by a variable with the value “ 0 ”. ([Bug#27130](#))
  - Some functions when used in partitioning expressions could cause `mysqld` to crash. ([Bug#27084](#))
  - The server acquired a global mutex for temporary tables, although such tables are thread-specific. This affected performance by blocking other threads. ([Bug#27062](#))
  - `FEDERATED` tables had an artificially low maximum of key length. ([Bug#26909](#))
  - Updates to rows in a partitioned table could update the wrong column. ([Bug#26827](#))
  - Index creation could corrupt the table definition in the `.frm` file: 1) A table with the maximum number of key segments and maximum length key name would have a corrupted `.frm` file, due to incorrect calculation of the total key length. 2) `MyISAM` would reject a table with the maximum number of keys and the maximum number of key segments in all keys. (It would allow one less than this total maximum.) Now `MyISAM` accepts a table defined with the maximum. ([Bug#26642](#))
  - The Windows implementation of `pthread_join ( )` was incorrect and could cause crashes. ([Bug#26564](#))
  - After the first read of a `TEMPORARY` table, `CHECK TABLE` could report the table as being corrupt. ([Bug#26325](#))
  - If an operation had an `InnoDB` table, and two triggers, `AFTER UPDATE` and `AFTER INSERT`, competing for different resources (such as two distinct `MyISAM` tables), the triggers were unable to execute concurrently. In addition, `INSERT` and `UPDATE` statements for the `InnoDB` table were unable to run concurrently. ([Bug#26141](#))
  - A number of unsupported constructs — including prohibited constructs, the `UCASE ( )` function, and nested function calls — were permitted in partitioning expressions. ([Bug#26082](#), [Bug#18198](#), [Bug#29308](#))
  - `ALTER DATABASE` did not require at least one option. ([Bug#25859](#))
  - The index merge union access algorithm could produce incorrect results with `InnoDB` tables. The problem could also occur for queries that used `DISTINCT`. ([Bug#25798](#))
  - When using a `FEDERATED` table, the value of `LAST_INSERT_ID ( )` would not correctly update the C API interface, which would affect the autogenerated ID returned both through the C API and the MySQL protocol, affecting Connectors that used the protocol and/or C API. ([Bug#25714](#))
  - The server was blocked from opening other tables while the `FEDERATED` engine was attempting to open a remote table. Now the server does not check the correctness of a `FEDERATED` table at `CREATE TABLE` time, but waits until the table actually is accessed. ([Bug#25679](#))

- Under ActiveState Perl, `mysql-test-run.pl` could kill itself when attempting to kill other processes. (Bug#25657)
- Several `InnoDB` assertion failures were corrected. (Bug#25645)
- A query with `DISTINCT` in the select list to which the loose-scan optimization for grouping queries was applied returned an incorrect result set when the query was used with the `SQL_BIG_RESULT` option. (Bug#25602)
- For a multiple-row insert into a `FEDERATED` table that refers to a remote transactional table, if the insert failed for a row due to constraint failure, the remote table would contain a partial commit (the rows preceding the failed one) instead of rolling back the statement completely. This occurred because the rows were treated as individual inserts.

Now `FEDERATED` performs bulk-insert handling such that multiple rows are sent to the remote table in a batch. This provides a performance improvement and enables the remote table to perform statement rollback properly should an error occur. This capability has the following limitations:

- The size of the insert cannot exceed the maximum packet size between servers. If the insert exceeds this size, it is broken into multiple packets and the rollback problem can occur.
- Bulk-insert handling does not occur for `INSERT ... ON DUPLICATE KEY UPDATE`.

(Bug#25513)

- The `FEDERATED` storage engine failed silently for `INSERT ... ON DUPLICATE KEY UPDATE` if a duplicate key violation occurred. `FEDERATED` does not support `ON DUPLICATE KEY UPDATE`, so now it correctly returns an `ER_DUP_KEY` error if a duplicate key violation occurs. (Bug#25511)
- In a stored function or trigger, when `InnoDB` detected deadlock, it attempted rollback and displayed an incorrect error message (`EXPLICIT OR IMPLICIT COMMIT IS NOT ALLOWED IN STORED FUNCTION OR TRIGGER`). Now `InnoDB` returns an error under these conditions and does not attempt rollback. Rollback is handled outside of `InnoDB` above the function/trigger level. (Bug#24989)
- Dropping a temporary `InnoDB` table that had been locked with `LOCK TABLES` caused a server crash. (Bug#24918)
- On Windows, executables did not include Vista manifests. (Bug#24732)

See also Bug#22563.

- If MySQL/`InnoDB` crashed very quickly after starting up, it would not force a checkpoint. In this case, `InnoDB` would skip crash recovery at next startup, and the database would become corrupt. Now, if the redo log scan at `InnoDB` startup goes past the last checkpoint, crash recovery is forced. (Bug#23710)
- `SHOW INNODB STATUS` caused an assertion failure under high load. (Bug#22819)
- `SHOW BINLOG EVENTS` displayed incorrect values of `End_log_pos` for events associated with transactional storage engines. (Bug#22540)
- When determining which transaction to kill after deadlock has been detected, `InnoDB` now adds the number of locks to a transaction's weight, and avoids killing transactions that have modified non-transactional tables. This should reduce the likelihood of killing long-running transactions containing `SELECT ... FOR UPDATE` or `INSERT/REPLACE INTO ... SELECT` statements, and of causing partial updates if the target is a `MyISAM` table. (Bug#21293)
- `InnoDB` displayed an incorrect error message when a `CREATE TABLE` statement exceeded the `InnoDB` maximum allowable row size. (Bug#21101)
- Under heavy load with a large query cache, invalidating part of the cache could cause the server to freeze (that is, to be unable to service other operations until the invalidation was complete). (Bug#21074)
- On Windows, the server used 10MB of memory for each connection thread, resulting in memory exhaustion. Now each thread uses 1MB. (Bug#20815)
- `InnoDB` produced an unnecessary (and harmless) warning: `InnoDB: Error: trying to declare trx to enter InnoDB, but InnoDB: it already is declared`. (Bug#20090)
- If a slave timed out while registering with the master to which it was connecting, auto-reconnect failed thereafter. (Bug#19328)
- If `InnoDB` reached its limit on the number of concurrent transactions (1023), it wrote a descriptive message to the error log but returned a misleading error message to the client, or an assertion failure occurred. (Bug#18828)
- Under ActiveState Perl, `mysql-test-run.pl` would not run. (Bug#18415)
- The server crashed when the size of an `ARCHIVE` table grew larger than 2GB. (Bug#15787)

- `SQL_BIG_RESULT` had no effect for `CREATE TABLE ... SELECT SQL_BIG_RESULT ...` statements. (Bug#15130)
  - On 64-bit Windows systems, the Config Wizard failed to complete the setup because 64-bit Windows does not resolve dynamic linking of the 64-bit `libmysql.dll` to a 32-bit application like the Config Wizard. (Bug#14649)
  - `mysql_setpermission` tried to grant global-only privileges at the database level. (Bug#14618)
  - For the general query log, logging of prepared statements executed via the C API differed from logging of prepared statements performed with `PREPARE` and `EXECUTE`. Logging for the latter was missing the `Prepare` and `Execute` lines. (Bug#13326)
  - The `TABLE_COMMENT` column of `INFORMATION_SCHEMA.TABLES` and the `Comment` column in the output of `SHOW TABLE STATUS` displayed extraneous information for `InnoDB` and `NDBCLUSTER` tables. (Bug#11379)
- See also Bug#32440.
- The server returned data from `SHOW CREATE TABLE` statement or a `SELECT` statement on an `INFORMATION_SCHEMA` table using the `binary` character set. (Bug#10491)
  - Backup software can cause `ERROR_SHARING_VIOLATION` or `ERROR_LOCK_VIOLATION` conditions during file operations. `InnoDB` now retries forever until the condition goes away. (Bug#9709)

## C.2.18. Changes in MySQL 5.1.20 (25 June 2007)

This is a new Beta development release, fixing recently discovered bugs.

### Note

This Beta release, as any other pre-production release, should not be installed on *production* level systems or systems with critical data. It is good practice to back up your data before installing any new version of software. Although MySQL has worked very hard to ensure a high level of quality, protect your data by making a backup as you would for any software beta release. Please refer to our bug database at <http://bugs.mysql.com/> for more details about the individual bugs fixed in this version.

This section documents all changes and bug fixes that have been applied since the last official MySQL release. If you would like to receive more fine-grained and personalized *update alerts* about fixes that are relevant to the version and features you use, please consider subscribing to *MySQL Enterprise* (a commercial MySQL offering). For more details please see <http://www.mysql.com/products/enterprise>.

Functionality added or changed:

- **Incompatible Change:** It is no longer possible to partition the log tables. (Bug#27816)
- **Incompatible Change:** `mysqld_safe` now supports error logging to `syslog` on systems that support the `logger` command. The new `--syslog` and `--skip-syslog` options can be used instead of the `--log-error` option to control logging behavior, as described in Section 4.3.2, “`mysqld_safe` — MySQL Server Startup Script”. The default is to use `syslog`, which differs from the previous default behavior of writing an error log file.

Currently, logging to `syslog` may fail to operate correctly in some cases, so we recommend that you use `--skip-syslog` or `--log-error`. To maintain the older behavior if you were using no error-logging option, use `--skip-syslog`. If you were using `--log-error`, continue to use it.

Note: In 5.1.21, the default is changed to `--skip-syslog`, which is compatible with releases prior to 5.1.20. (Bug#4858)

- **Important Change: MySQL Cluster:** The `TimeBetweenWatchdogCheckInitial` configuration parameter was added to allow setting of a separate watchdog timeout for memory allocation during startup of the data nodes. See [Defining MySQL Cluster Data Nodes](#), for more information. (Bug#28899)
- **MySQL Cluster:** The cluster management client now stores command history between sessions. (Bug#29073)
- **MySQL Cluster:** `auto_increment_increment` and `auto_increment_offset` are now supported for `NDB` tables. (Bug#26342)
- **MySQL Cluster:** The server source tree now includes scripts to simplify building MySQL with SCI support. For more information about SCI interconnects and these build scripts, see [Configuring MySQL Cluster to use SCI Sockets](#). (Bug#25470)
- **MySQL Cluster:** A new configuration parameter `ODirect` causes `NDB` to attempt using `O_DIRECT` writes for LCP, backups, and redo logs, often lowering CPU usage.
- **Replication:** The `sql_mode`, `foreign_key_checks`, `unique_checks`, character set/collations, and

`sql_auto_is_null` session variables are written to the binary log and honored during replication. See [Section 5.2.4, “The Binary Log”](#).

- If a `MERGE` table cannot be opened or used because of a problem with an underlying table, `CHECK TABLE` now displays information about which table caused the problem. ([Bug#26976](#))
- User variables and stored procedure variables are now supported for use in XPath expressions employed as arguments to the `ExtractValue()` and `UpdateXML()` functions.

This means that:

- XPath can now be used to load data from XML files using virtually any format, and so able to import data from most third party software which either has XML export functionality, or uses XML natively as a storage format.
- Various complex conditions can be put on rows and columns, so one can filter for desired rows (or skip unwanted rows) when loading XML.
- Various types of preprocessing using SQL functions are now possible when loading XML. For example, you can concatenate two XML tag or attribute values into a single column value using `CONCAT()`, or remove some parts of the data using `REPLACE()`.

See [Section 11.10, “XML Functions”](#), for more information. ([Bug#26518](#))

- Binary distributions for some platforms did not include shared libraries; now shared libraries are shipped for all platforms except AIX 5.2 64-bit. *Exception:* The library for the `libmysqld` embedded server is not shared except on Windows. ([Bug#16520](#), [Bug#26767](#), [Bug#13450](#))
- Added a new `PAD_CHAR_TO_FULL_LENGTH` SQL mode. By default, trailing spaces are trimmed from `CHAR` column values on retrieval. If `PAD_CHAR_TO_FULL_LENGTH` is enabled, trimming does not occur and retrieved `CHAR` values are padded to their full length. This mode does not apply to `VARCHAR` columns, for which trailing spaces are retained on retrieval.
- XPath can now be used to load data from XML files using virtually any format, and so able to import data from most third party software which either has XML export functionality, or uses XML natively as a storage format.
- Various complex conditions can be put on rows and columns, so one can filter for desired rows (or skip unwanted rows) when loading XML.
- Various types of preprocessing using SQL functions are now possible when loading XML. For example, you can concatenate two XML tag or attribute values into a single column value using `CONCAT()`, or remove some parts of the data using `REPLACE()`.

Bugs fixed:

- **Security Fix:** A malformed password packet in the connection protocol could cause the server to crash. Thanks for Dormando for reporting this bug, and for providing details and a proof of concept. ([Bug#28984](#), [CVE-2007-3780](#))
- **Security Fix:** `CREATE TABLE LIKE` did not require any privileges on the source table. Now it requires the `SELECT` privilege.

In addition, `CREATE TABLE LIKE` was not isolated from alteration by other connections, which resulted in various errors and incorrect binary log order when trying to execute concurrently a `CREATE TABLE LIKE` statement and either DDL statements on the source table or DML or DDL statements on the target table. ([Bug#23667](#), [Bug#25578](#), [CVE-2007-3781](#))

- **Incompatible Change:** Some error codes had error numbers in MySQL 5.1 different from the numbers in MySQL 5.0. In MySQL 5.1, error numbers have been changed to match the MySQL 5.0 values: Error codes with value of 1458 or higher have changed in MySQL 5.1 now. Client applications designed to work with MySQL 5.1 with hard-coded error code values (for example, in statements such as `if (mysql_errno(mysql) == 1463) { ... }`) need to be updated in the source code. All clients designed to work with MySQL 5.1 that test error codes (for example, in statements such as `if (mysql_errno(mysql) == ER_VIEW_RECURSIVE) { ... }`) should be recompiled. Existing 5.0 clients should now work, without changes or recompilation, against servers for MySQL 5.1.20 or higher. ([Bug#29245](#))
- **Incompatible Change:** When `mysqldump` was run with the `--delete-master-logs` option, binary log files were deleted before it was known that the dump had succeeded, not after. (The method for removing log files used `RESET MASTER` prior to the dump. This also reset the binary log sequence numbering to `.000001`.) Now `mysqldump` flushes the logs (which creates a new binary log number with the next sequence number), performs the dump, and then uses `PURGE BINARY LOGS` to remove the log files older than the new one. This also preserves log numbering because the new log with the next number is generated and only the preceding logs are removed. However, this may affect applications if they rely on the log numbering sequence being reset. ([Bug#24733](#))



- **Incompatible Change:** The use of an `ORDER BY` or `DISTINCT` clause with a query containing a call to the `GROUP_CONCAT()` function caused results from previous queries to be redisplayed in the current result. The fix for this includes replacing a `BLOB` value used internally for sorting with a `VARCHAR`. This means that for long results (more than 65,535 bytes), it is possible for truncation to occur; if so, an appropriate warning is issued. (Bug#23856, Bug#28273)
  - **MySQL Cluster: Replication:** (Replication): A replicated unique key allowed duplicate key inserts on the slave. (Bug#27044)
  - **MySQL Cluster:** Memory corruption could occur due to a problem in the `DBTUP` kernel block. (Bug#29229)
  - **MySQL Cluster:** A query having a large `IN(...)` or `NOT IN(...)` list in the `WHERE` condition on an `NDB` table could cause `mysqld` to crash. (Bug#29185)
  - **MySQL Cluster:** In the event that two data nodes in the same node group and participating in a GCP crashed before they had written their respective `PO.sysfile` files, `QMGR` could refuse to start, issuing an invalid `INSUFFICIENT NODES FOR RESTART` error instead. (Bug#29167)
  - **MySQL Cluster:** Attempting to restore a `NULL` row to a `VARBINARY` column caused `ndb_restore` to fail. (Bug#29103)
  - **MySQL Cluster:** `ndb_error_reporter` now preserves timestamps on files. (Bug#29074)
  - **MySQL Cluster:** It is now possible to set the maximum size of the allocation unit for table memory using the `MaxAllocate` configuration parameter. (Bug#29044)
  - **MySQL Cluster:** When shutting down `mysqld`, the `NDB` binlog process was not shut down before log cleanup began. (Bug#28949)
  - **MySQL Cluster:** `ndb_mgm` could hang when connecting to a non-existent host. (Bug#28847)
  - **MySQL Cluster:** A regression in the heartbeat monitoring code could lead to node failure under high load. This issue affected MySQL 5.1.19 and MySQL Cluster NDB 6.1.10 only. (Bug#28783)
  - **MySQL Cluster:** A corrupt schema file could cause a `FILE ALREADY OPEN` error. (Bug#28770)
  - **MySQL Cluster:** Having large amounts of memory locked caused swapping to disk. (Bug#28751)
  - **MySQL Cluster:** Setting `InitialNoOpenFiles` equal to `MaxNoOfOpenFiles` caused an error. This was due to the fact that the actual value of `MaxNoOfOpenFiles` as used by the cluster was offset by 1 from the value set in `config.ini`. (Bug#28749)
  - **MySQL Cluster:** LCP files were not removed following an initial system restart. (Bug#28726)
  - **MySQL Cluster:** `UPDATE IGNORE` statements involving the primary keys of multiple tables could result in data corruption. (Bug#28719)
  - **MySQL Cluster:** A race condition could result when non-master nodes (in addition to the master node) tried to update active status due to a local checkpoint (that is, between `NODE_FAILREP` and `COPY_GCIREQ` events). Now only the master updates the active status. (Bug#28717)
  - **MySQL Cluster:** A fast global checkpoint under high load with high usage of the redo buffer caused data nodes to fail. (Bug#28653)
  - **MySQL Cluster:** The management client's response to `START BACKUP WAIT COMPLETED` did not include the backup ID. (Bug#27640)
  - **Cluster Replication: Replication:** When replicating `MyISAM` or `InnoDB` tables to a MySQL Cluster, it was not possible to determine exactly what had been applied following a shutdown of the slave cluster or `mysqld` process. (Bug#26783)
  - **Replication:** `DROP USER` statements that named multiple users, only some of which could be dropped, were replicated incorrectly. (Bug#29030)
  - **Replication:** Using events in replication could cause the slave to crash. (Bug#28953)
  - **Replication:** It was possible to set `SQL_SLAVE_SKIP_COUNTER` such that the slave would jump into the middle of an event group. (Bug#28618)
- See also Bug#12691.
- **Replication:** The result of executing of a prepared statement created with `PREPARE s FROM "SELECT 1 LIMIT ?"` was not replicated correctly. (Bug#28464)
  - **Replication:** Recreating a view that already exists on the master would cause a replicating slave to terminate replication with a

'different error message on slave and master' error. ([Bug#28244](#))

- **Replication:** Binary logging of prepared statements could produce syntactically incorrect queries in the binary log, replacing some parameters with variable names rather than variable values. This could lead to incorrect results on replication slaves. ([Bug#26842](#), [Bug#12826](#))
- **Replication:** Connections from one `mysqld` server to another failed on Mac OS X, affecting replication and `FEDERATED` tables. ([Bug#26664](#))

See also [Bug#29083](#).

- **Replication:** When using transactions and replication, shutting down the master in the middle of a transaction would cause all slaves to stop replicating. ([Bug#22725](#))
- **Replication:** Using `CREATE TABLE LIKE ...` would raise an assertion when replicated to a slave. ([Bug#18950](#))
- **Disk Data:** When loading data into a cluster following a version upgrade, the data nodes could forcibly shut down due to page and buffer management failures (that is, `ndbrequire` failures in `PGMAN`). ([Bug#28525](#))
- **Disk Data:** Repeated `INSERT` and `DELETE` operations on a Disk Data table having one or more large `VARCHAR` columns could cause data nodes to fail. ([Bug#20612](#))
- **Cluster API:** The timeout set using the MGM API `ndb_mgm_set_timeout()` function was incorrectly interpreted as seconds rather than as milliseconds. ([Bug#29063](#))
- **Cluster API:** An invalid error code could be set on transaction objects by `BLOB` handling code. ([Bug#28724](#))
- The `TRUNCATE` statement was handled differently by the server when row-based logging was in effect, even though the bin-logging format in effect does not effect the fact that `TRUNCATE` is always logged as a statement. ([Bug#29130](#))
- If one of the queries in a `UNION` used the `SQL_CACHE` option and another query in the `UNION` contained a nondeterministic function, the result was still cached. For example, this query was incorrectly cached:

```
SELECT NOW() FROM t1 UNION SELECT SQL_CACHE 1 FROM t1;
```

([Bug#29053](#))

- Long path names for internal temporary tables could cause stack overflows. ([Bug#29015](#))
- Using an `INTEGER` column from a table to `ROUND()` a number produced different results than using a constant with the same value as the `INTEGER` column. ([Bug#28980](#))
- If a program binds a given number of parameters to a prepared statement handle and then somehow changes `stmt->param_count` to a different number, `mysql_stmt_execute()` could crash the client or server. ([Bug#28934](#))
- Queries using UDFs or stored functions were cached. ([Bug#28921](#))
- `INSERT .. ON DUPLICATE KEY UPDATE` could under some circumstances silently update rows when it should not have. ([Bug#28904](#))
- Queries that used `UUID()` were incorrectly allowed into the query cache. (This should not happen because `UUID()` is non-deterministic.) ([Bug#28897](#))
- Using a `VIEW` created with a non-existing `DEFINER` could lead to incorrect results under some circumstances. ([Bug#28895](#))
- For `InnoDB` tables that use the `utf8` character set, incorrect results could occur for DML statements such as `DELETE` or `UPDATE` that use an index on character-based columns. ([Bug#28878](#))

See also [Bug#29449](#), [Bug#30485](#), [Bug#31395](#).

This regression was introduced by [Bug#13195](#).

- Non-`utf8` characters could get mangled when stored in `CSV` tables. ([Bug#28862](#))
- On Windows, `USE_TLS` was not defined for `mysqlclient.lib`. ([Bug#28860](#))
- In MySQL 5.1.15, a new error code `ER_DUP_ENTRY_WITH_KEY_NAME` (1582) was introduced to replace `ER_DUP_ENTRY` (1062) so that the key name could be provided instead of the key number. This was unnecessary, so `ER_DUP_ENTRY` is used again and the key name is printed. The incompatibility introduced in 5.1.15 no longer applies. ([Bug#28842](#))
- A subquery with `ORDER BY` and `LIMIT 1` could cause a server crash. ([Bug#28811](#))



- Running `SHOW TABLE STATUS` while performing a high number of inserts on partitioned tables with a great many partitions could cause the server to crash. (Bug#28806)
- Using `BETWEEN` with non-indexed date columns and short formats of the date string could return incorrect results. (Bug#28778)
- Selecting `GEOMETRY` columns in a `UNION` caused a server crash. (Bug#28763)
- When constructing the path to the original `.frm` file, `ALTER ... RENAME` was unnecessarily (and incorrectly) lowercasing the entire path when not on a case-insensitive file system, causing the statement to fail. (Bug#28754)
- The `binlog_format` system variable value was empty if the server was started with binary logging disabled. Now it is set to `MIXED`. (Bug#28752)
- Searches on indexed and non-indexed `ENUM` columns could return different results for empty strings. (Bug#28729)
- Executing `EXPLAIN EXTENDED` on a query using a derived table over a grouping subselect could lead to a server crash. This occurred only when materialization of the derived tables required creation of an auxiliary temporary table, an example being when a grouping operation was carried out with usage of a temporary table. (Bug#28728)
- The result of evaluation for a view's `CHECK OPTION` option over an updated record and records of merged tables was arbitrary and dependant on the order of records in the merged tables during the execution of the `SELECT` statement. (Bug#28716)
- The “manager thread” of the LinuxThreads implementation was unintentionally started before `mysqld` had dropped privileges (to run as an unprivileged user). This caused signaling between threads in `mysqld` to fail when the privileges were finally dropped. (Bug#28690)
- Setting an interval of `EVERY 0 SECOND` for a scheduled event caused the server to crash. (Bug#28666)
- For debug builds, `ALTER TABLE` could trigger an assertion failure due to occurrence of a deadlock when committing changes. (Bug#28652)
- Attempting to create an index on a `BIT` column failed after modifying the column. (Bug#28631)
- After an upgrade, the names of stored routines referenced by views were no longer displayed by `SHOW CREATE VIEW`. (Bug#28605)  
This regression was introduced by Bug#23491.
- Conversion of U+00A5 YEN SIGN and U+203E OVERLINE from `ucs2` to `ujis` produced incorrect results. (Bug#28600)
- Killing from one connection a long-running `EXPLAIN QUERY` started from another connection caused `mysqld` to crash. (Bug#28598)
- `SHOW GLOBAL VARIABLES` repeated some variable names. (Bug#28580)
- When one thread attempts to lock two (or more) tables and another thread executes a statement that aborts these locks (such as `REPAIR TABLE`, `OPTIMIZE TABLE`, or `CHECK TABLE`), the thread might get a table object with an incorrect lock type in the table cache. The result is table corruption or a server crash. (Bug#28574)
- Outer join queries with `ON` conditions over constant outer tables did not return `NULL`-complemented rows when conditions were evaluated to `FALSE`. (Bug#28571)
- An update on a multiple-table view with the `CHECK OPTION` clause and a subquery in the `WHERE` condition could cause an assertion failure. (Bug#28561)
- Calling the `UpdateXML()` function using invalid XPath syntax caused memory corruption possibly leading to a crash of the server. (Bug#28558)
- `PURGE MASTER LOGS BEFORE (subquery)` caused a server crash. Subqueries are forbidden in the `BEFORE` clause now. (Bug#28553)
- `mysqldump` calculated the required memory for a hex-blob string incorrectly causing a buffer overrun. This in turn caused `mysqldump` to crash silently and produce incomplete output. (Bug#28522)
- When upgrading from MySQL 5.1.17 to 5.1.18, `mysql_upgrade` and `mysql_fix_privilege_tables` did not upgrade the system tables relating to the Event Scheduler correctly. (Bug#28521)
- Passing a `DECIMAL` value as a parameter of a statement prepared with `PREPARE` resulted in an error. (Bug#28509)
- `mysql_affected_rows()` could return an incorrect result for `INSERT ... ON DUPLICATE KEY UPDATE` if the

`CLIENT_FOUND_ROWS` flag was set. (Bug#28505)

- A query that grouped by the result of an expression returned a different result when the expression was assigned to a user variable. (Bug#28494)
- Subselects returning `LONG` values in MySQL versions later than 5.0.24a returned `LONGLONG` prior to this. The previous behavior was restored. (Bug#28492)

This regression was introduced by Bug#19714.

- Performing `ALTER TABLE ... ADD PARTITION` or `ALTER TABLE DROP PARTITION` could result in inconsistent data, or cause the server to crash, if done concurrently with other accesses to the table. (Bug#28477, Bug#28488)
- Forcing the use of an index on a `SELECT` query when the index had been disabled would raise an error without running the query. The query now executes, with a warning generated noting that the use of a disabled index has been ignored. (Bug#28476)
- The query `SELECT '2007-01-01' + INTERVAL column_name DAY FROM table_name` caused `mysqld` to fail. (Bug#28450)
- A server crash could happen under rare conditions such that a temporary table outgrew heap memory reserved for it and the remaining disk space was not big enough to store the table as a `MyISAM` table. (Bug#28449)
- Using `ALTER TABLE` to move columns resulted only in the columns being renamed. The table contents were not changed. (Bug#28427)
- The test case for `mysqldump` failed with `bin-log` disabled. (Bug#28372)
- Attempting to `LOAD_FILE` from an empty floppy drive under Windows, caused the server to hang. For example, if you opened a connection to the server and then issued the command `SELECT LOAD_FILE('a:test');`, with no floppy in the drive, the server was inaccessible until the modal pop-up dialog box was dismissed. (Bug#28366)
- `mysqltest` used a too-large stack size on PPC/Debian Linux, causing thread-creation failure for tests that use many threads. (Bug#28333)
- When using a `MEMORY` table on Mac OS X, dropping a table and then creating a table with the same name could cause the information of the deleted table to remain accessible, leading to index errors. (Bug#28309)
- The `IS_UPDATABLE` column in the `INFORMATION_SCHEMA.VIEWS` table was not always set correctly. (Bug#28266)
- For `CAST()` of a `NULL` value with type `DECIMAL`, the return value was incorrectly initialized, producing a runtime error for binaries built using Visual C++ 2005. (Bug#28250)
- When the query cache was fully used, issuing `RENAME DATABASE` or `RENAME SCHEMA` could cause the server to hang, with 100% CPU usage. (Bug#28211)
- The `Bytes_received` and `Bytes_sent` status variables could hold only 32-bit values (not 64-bit values) on some platforms. (Bug#28149)
- Some valid identifiers were not parsed correctly. (Bug#28127)
- Storing a large number into a `FLOAT` or `DOUBLE` column with a fixed length could result in incorrect truncation of the number if the column's length was greater than 31. (Bug#28121)
- Sending debugging information from a dump of the Event Scheduler to `COM_DEBUG` could cause the server to crash. (Bug#28075)
- The `PARTITION_COMMENT` column of the `INFORMATION_SCHEMA.PARTITIONS` table had the wrong default value. (Bug#28007)
- `DECIMAL` values beginning with nine 9 digits could be incorrectly rounded. (Bug#27984)
- For attempts to open a non-existent table, the server should report `ER_NO_SUCH_TABLE` but sometimes reported `ER_TABLE_NOT_LOCKED`. (Bug#27907)
- Following an invalid call to `UpdateXML()`, calling the function again (even if valid) crashed the server. (Bug#27898)
- A stored program that uses a variable name containing multibyte characters could fail to execute. (Bug#27876)
- The server made strong assumptions about the structure of the `general_log` and `slow_log` log tables: It supported only the table structure defined in the `mysql` database creation scripts. The server also allowed limited `ALTER TABLE` operations

on the log tables, but adding an `AUTO_INCREMENT` column did not properly initialize the column, and subsequent inserts into the table could fail to generate correct sequence numbers. Now an `ALTER TABLE` statement that adds an `AUTO_INCREMENT` column populates the column correctly. In addition, when the server writes a log table row, it will set columns not present in the original table structure to their default values. (Bug#27857)

- `ON` conditions from `JOIN` expressions were ignored when checking the `CHECK OPTION` clause while updating a multiple-table view that included such a clause. (Bug#27827)
  - On some systems, `udf_example.c` returned an incorrect result length. Also on some systems, `mysql-test-run.pl` could not find the shared object built from `udf_example.c`. (Bug#27741)
  - The modification of a table by a partially completed multi-column update was not recorded in the binlog, rather than being marked by an event and a corresponding error code. (Bug#27716)
  - `SHOW ENGINES` and queries on `INFORMATION_SCHEMA.ENGINES` did not use the same values for representing the same storage engine states. (Bug#27684)
  - `HASH` indexes on `VARCHAR` columns with binary collations did not ignore trailing spaces from strings before comparisons. This could result in duplicate records being successfully inserted into a `MEMORY` table with unique key constraints. A consequence was that internal `MEMORY` tables used for `GROUP BY` calculation contained duplicate rows that resulted in duplicate-key errors when converting those temporary tables to `MyISAM`, and that error was incorrectly reported as a `table is full` error. (Bug#27643)
  - An error occurred trying to connect to `mysqld-debug.exe`. (Bug#27597)
  - A stack overrun could occur when storing `DATETIME` values using repeated prepared statements. (Bug#27592)
  - If a stored function or trigger was killed, it aborted but no error was thrown, allowing the calling statement to continue without noticing the problem. This could lead to incorrect results. (Bug#27563)
  - When `ALTER TABLE` was used to add a new `DATE` column with no explicit default value, `'0000-00-00'` was used as the default even if the SQL mode included the `NO_ZERO_DATE` mode to prohibit that value. A similar problem occurred for `DATETIME` columns. (Bug#27507)
  - `ALTER TABLE ... ENABLE KEYS` could cause `mysqld` to crash when executed on a table containing on a `MyISAM` table containing billions of rows. (Bug#27029)
  - Binary content `0x00` in a `BLOB` column sometimes became `0x5C 0x00` following a dump and reload, which could cause problems with data using multi-byte character sets such as `GBK` (Chinese). This was due to a problem with `SELECT INTO OUTFILE` whereby `LOAD DATA` later incorrectly interpreted `0x5C` as the second byte of a multi-byte sequence rather than as the `SOLIDUS` (“\”) character, used by MySQL as the escape character. (Bug#26711)
  - The server crashed when attempting to open a table having a `#mysql150#` prefix in the database or table name. The server now will not open such tables. (This prefix is reserved by `mysql_upgrade` for accessing 5.0 tables that have names not yet encoded for 5.1.) (Bug#26402)
  - A `FLUSH TABLES WITH READ LOCK` statement followed by a `FLUSH LOGS` statement caused a deadlock if the general log or the slow query log was enabled. (Bug#26380)
  - The query `SELECT /*2*/ user, host, db, info FROM INFORMATION_SCHEMA.PROCESSLIST WHERE (command!='Daemon' || user='event_scheduler') AND (info IS NULL OR info NOT LIKE '%processlist%') ORDER BY INFO` yielded inconsistent results. (Bug#26338)
  - For a given user variable `@v`, the statements `SELECT @v` and `CREATE TABLE ... AS SELECT @v` did not return the same data type. (Bug#26277)
  - Statements within triggers ignored the value of the `low_priority_updates` system variable. (Bug#26162)
- See also Bug#29963.
- The embedded server library displayed error messages at startup if the `mysql.plugin` table was not present. This no longer occurs. (Bug#25800)
  - On Windows, an application that called `mysql_thread_init()` but forgot to call `mysql_thread_end()` would get this error: `ERROR IN MY_THREAD_GLOBAL_END()`. (Bug#25621)
  - Embedded `/* ... */` comments were handled incorrectly within the definitions of stored programs and views, resulting in malformed definitions (the trailing `*/` was stripped). This also affected binary log contents. (Bug#25411, Bug#26302)
  - Due to a race condition, executing `FLUSH PRIVILEGES` in one thread could cause brief table unavailability in other threads. (Bug#24988)

- In `SHOW SLAVE STATUS` output, `Last_Errno` and `Last_Error` were not set after `master_retry_count` errors had occurred. To provide additional information, the statement now displays four additional columns:
  - `Last_IO_Errno`: The number of the last error that caused the I/O thread to stop
  - `Last_IO_Error`: A description of the last error that caused the I/O thread to stop
  - `Last_SQL_Errno`: The number of the last error that caused the SQL thread to stop
  - `Last_SQL_Error`: A description of the last error that caused the SQL thread to stop

Also, `Last_Errno` and `Last_Error` now are aliases for `Last_SQL_Errno` and `Last_SQL_Error`. (Bug#24954)

- A too-long `shared-memory-base-name` value could cause a buffer overflow and crash the server or clients. (Bug#24924)
- When `mysqld` was run as a Windows service, shared memory objects were not created in the global namespace and could not be used by clients to connect. (Bug#24731)
- On some Linux distributions where LinuxThreads and NPTL `glibc` versions both are available, statically built binaries can crash because the linker defaults to LinuxThreads when linking statically, but calls to external libraries (such as `libnss`) are resolved to NPTL versions. This cannot be worked around in the code, so instead if a crash occurs on such a binary/OS combination, print an error message that provides advice about how to fix the problem. (Bug#24611)
- A number of `SHOW` statements caused `mysqld` to crash on recent versions of Solaris. This issue is believed to be present only in MySQL 5.1.12 and later. (Bug#23810)
- The server deducted some bytes from the `key_cache_block_size` option value and reduced it to the next lower 512 byte boundary. The resulting block size was not a power of two. Setting the `key_cache_block_size` system variable to a value that is not a power of two resulted in `MyISAM` table corruption. (Bug#23068, Bug#28478, Bug#25853)
- Conversion errors could occur when constructing the condition for an `IN` predicate. The predicate was treated as if the affected column contains `NULL`, but if the `IN` predicate is inside `NOT`, incorrect results could be returned. (Bug#22855)
- Linux binaries were unable to dump core after executing a `setuid()` call. (Bug#21723)
- Stack overflow caused server crashes. (Bug#21476)
- The server was ignoring the return value of the `parse()` function for full-text parser plugins. (Bug#18839)
- Granting access privileges to an individual table where the database or table name contained an underscore would fail. (Bug#18660)
- The `-lmtmalloc` library was removed from the output of `mysql_config` on Solaris, as it caused problems when building `DBD:mysql` (and possibly other applications) on that platform that tried to use `dlopen()` to access the client library. (Bug#18322)
- The `check-cpu` script failed to detect AMD64 Turion processors correctly. (Bug#17707)
- When using `mysqlbinlog` with `--read-from-remote-server` to load the data direct from a remote MySQL server would cause a core dump when dumping certain binary log events. (Bug#17654)
- Trying to shut down the server following a failed `LOAD DATA INFILE` caused `mysqld` to crash. (Bug#17233)
- The omission of leading zeros in dates could lead to erroneous results when these were compared with the output of certain date and time functions. (Bug#16377)
- Using up-arrow for command-line recall in `mysql` could cause a segmentation fault. (Bug#10218)
- The result for `CAST()` when casting a value to `UNSIGNED` was limited to the maximum signed `BIGINT` value (9223372036854775808), rather than the maximum unsigned value (18446744073709551615). (Bug#8663)
- The internal functions for table preparation, creation, and alteration were not re-execution friendly, causing problems in code that: repeatedly altered a table; repeatedly created and dropped a table; opened and closed a cursor on a table, altered the table, and then reopened the cursor; used `ALTER TABLE` to change a table's current `AUTO_INCREMENT` value; created indexes on `utf8` columns.

Re-execution of `CREATE DATABASE`, `CREATE TABLE`, and `ALTER TABLE` statements in stored routines or as prepared statements also caused incorrect results or crashes. (Bug#4968, Bug#6895, Bug#19182, Bug#19733, Bug#22060, Bug#24879)

## C.2.19. Changes in MySQL 5.1.19 (25 May 2007)

This is a new Beta development release, fixing recently discovered bugs.

### Note

This Beta release, as any other pre-production release, should not be installed on *production* level systems or systems with critical data. It is good practice to back up your data before installing any new version of software. Although MySQL has worked very hard to ensure a high level of quality, protect your data by making a backup as you would for any software beta release. Please refer to our bug database at <http://bugs.mysql.com/> for more details about the individual bugs fixed in this version.

This section documents all changes and bug fixes that have been applied since the last official MySQL release. If you would like to receive more fine-grained and personalized *update alerts* about fixes that are relevant to the version and features you use, please consider subscribing to *MySQL Enterprise* (a commercial MySQL offering). For more details please see <http://www.mysql.com/products/enterprise>.

Functionality added or changed:

- **Incompatible Change:** `INSERT DELAYED` is now downgraded to a normal `INSERT` if the statement uses functions that access tables or triggers, or that is called from a function or a trigger.

This was done to resolve the following interrelated issues:

- The server could abort or deadlock for `INSERT DELAYED` statements for which another insert was performed implicitly (for example, via a stored function that inserted a row).
- A trigger using an `INSERT DELAYED` caused the error `INSERT DELAYED CAN'T BE USED WITH TABLE ... BECAUSE IT IS LOCKED WITH LOCK TABLES` although the target table was not actually locked.
- `INSERT DELAYED` into a table with a `BEFORE INSERT` or `AFTER INSERT` trigger gave an incorrect `NEW` pseudo-column value and caused the server to deadlock or abort.

([Bug#21483](#))

See also [Bug#20497](#), [Bug#21714](#).

- **MySQL Cluster:** Formerly, restoring a cluster backup made on a MySQL 5.0 Cluster to a 5.1 cluster using a 5.1 version of `ndb_restore` did not resize `VARCHAR` columns as might be expected; now, the default behavior of `ndb_restore` in such cases is to resize the `VARCHAR` columns. This changed default behavior can be overridden using the `--no-upgrade` (or `-u`) option when invoking `ndb_restore`. ([Bug#22240](#))
- The `BLACKHOLE` storage engine now supports `INSERT DELAYED`. Previously, `INSERT DELAYED` statements for `BLACKHOLE` tables were not supported, and caused the server to crash. ([Bug#27998](#))
- A new status variable, `Com_call_procedure`, indicates the number of calls to stored procedures. ([Bug#27994](#))
- The `BLACKHOLE` storage engine now supports `LOCK TABLES` and `UNLOCK TABLES`. ([Bug#26241](#))
- `GLOBAL_STATUS`
- `GLOBAL_VARIABLES`
- `SESSION_VARIABLES`
- The data type used for the `VARIABLE_VALUE` column of the following `INFORMATION_SCHEMA` tables has been changed to `VARCHAR`:
  - `GLOBAL_STATUS`
  - `SESSION_STATUS`
  - `GLOBAL_VARIABLES`
  - `SESSION_VARIABLES`
 For more information, see [Section 19.24](#), “The `INFORMATION_SCHEMA GLOBAL_STATUS` and `SESSION_STATUS` Tables”, and [Section 19.25](#), “The `INFORMATION_SCHEMA GLOBAL_VARIABLES` and `SESSION_VARIABLES` Tables”.
- See also [Bug#26994](#).
- `SESSION_STATUS`

Bugs fixed:

- **Security Fix:** UDFs are supposed to be loadable only from the plugin directory, but this restriction was not being enforced. (Bug#28341)
- **Security Fix:** Use of a view could allow a user to gain update privileges for tables in other databases. (Bug#27878, CVE-2007-3782)
- **MySQL Cluster:** When an API node sent more than 1024 signals in a single batch, NDB would process only the first 1024 of these, and then hang. (Bug#28443)
- **MySQL Cluster:** A delay in obtaining `AUTO_INCREMENT` IDs could lead to excess temporary errors. (Bug#28410)
- **MySQL Cluster:** Local checkpoint files relating to dropped NDB tables were not removed. (Bug#28348)
- **MySQL Cluster:** Multiple operations involving deletes followed by reads were not handled correctly.

### Note

This issue could also affect MySQL Cluster Replication.

(Bug#28276)

- **MySQL Cluster:** Repeated insertion of data generated by `mysqldump` into NDB tables could eventually lead to failure of the cluster. (Bug#27437)
- **MySQL Cluster:** Restarting a data node caused SQL nodes to log repeatedly and unnecessarily the status of the event buffer, causing a memory leak of approximately 4 MB for each `mysqld` process each time this occurred.  
(This issue was known to occur in MySQL 5.1.16 and later only.) (Bug#27292)
- **MySQL Cluster:** `ndb_mgmd` failed silently when the cluster configuration file contained invalid `[tcp]` entries. (Bug#27207)
- **MySQL Cluster:** `ndb_connectstring` did not appear in the output of `SHOW VARIABLES`. (Bug#26675)
- **MySQL Cluster:** A failure to release internal resources following an error could lead to problems with single user mode. (Bug#25818)
- **MySQL Cluster:** DDL operations were not supported on a partially started cluster. (Bug#24631)
- **Disk Data:** Extremely large inserts into Disk Data tables could lead to data node failure in some circumstances. (Bug#27942)
- **Cluster API:** In a multi-operation transaction, a delete operation followed by the insertion of an implicit `NULL` failed to overwrite an existing value. (Bug#20535)
- Some `ALTER TABLE` statements that worked in MySQL 5.0 did not work in 5.1. (Bug#28415)
- `mysql_upgrade` failed if certain SQL modes were set. Now it sets the mode itself to avoid this problem. (Bug#28401)
- A query with a `NOT IN` subquery predicate could cause a crash when the left operand of the predicate evaluated to `NULL`. (Bug#28375)
- A buffer overflow could occur when using `DECIMAL` columns on Windows operating systems. (Bug#28361)
- `libmysql.dll` could not be dynamically loaded on Windows. (Bug#28358)
- Grouping queries with correlated subqueries in `WHERE` conditions could produce incorrect results. (Bug#28337)
- `EXPLAIN` for a query on an empty table immediately after its creation could result in a server crash. (Bug#28272)
- Comparing a `DATETIME` column value with a user variable yielded incorrect results. (Bug#28261)
- Portability problems caused by use of `isinf()` were corrected. (Bug#28240)
- When dumping procedures, `mysqldump --compact` generated output that restored the session variable `sql_mode` without first capturing it. When dumping routines, `mysqldump --compact` neither set nor retrieved the value of `sql_mode`. (Bug#28223)
- Comparison of the string value of a date showed as unequal to `CURTIME()`. Similar behavior was exhibited for `DATETIME` values. (Bug#28208)



- For `InnoDB`, in some rare cases the optimizer preferred a more expensive `ref` access to a less expensive range access. (Bug#28189)
- Comparisons of `DATE` or `DATETIME` values for the `IN()` function could yield incorrect results. (Bug#28133)
- It was not possible to use the value `-9223372036854775808` (that is, `-MAXVALUE + 1`) when specifying a `LIST` partition. (Bug#28005)
- The server could hang for `INSERT IGNORE ... ON DUPLICATE KEY UPDATE` if an update failed. (Bug#28000)
- `CAST()` to `DECIMAL` did not check for overflow. (Bug#27957)
- The second execution of a prepared statement from a `UNION` query with `ORDER BY RAND()` caused the server to crash. This problem could also occur when invoking a stored procedure containing such a query. (Bug#27937)
- Views ignored precision for `CAST()` operations. (Bug#27921)
- Changes to some system variables should invalidate statements in the query cache, but invalidation did not happen. (Bug#27792)
- `LOAD DATA` did not use `CURRENT_TIMESTAMP` as the default value for a `TIMESTAMP` column for which no value was provided. (Bug#27670)
- Selecting `MIN()` on an indexed column that contained only `NULL` values caused `NULL` to be returned for other result columns. (Bug#27573)
- Using a `TEXT` local variable in a stored routine in an expression such as `SET var = SUBSTRING(var, 3)` produced an incorrect result. (Bug#27415)
- The error message for error number `137` did not report which database/table combination reported the problem. (Bug#27173)
- A large filesort could result in a division by zero error and a server crash. (Bug#27119)
- Some `InnoDB` variables were missing from the output of `mysqld --verbose --help`. (Bug#26987)
- Flow control optimization in stored routines could cause exception handlers to never return or execute incorrect logic. (Bug#26977)
- Some test suite files were missing from some MySQL-test packages. (Bug#26609)
- Running `CHECK TABLE` concurrently with a `SELECT`, `INSERT` or other statement on Windows could corrupt a MyISAM table. (Bug#25712)
- Concurrent execution of `CREATE TABLE ... SELECT` and other statements involving the target table suffered from various race conditions, some of which might have led to deadlocks. (Bug#24738)
- An attempt to execute `CREATE TABLE ... SELECT` when a temporary table with the same name already existed led to the insertion of data into the temporary table and creation of an empty non-temporary table. (Bug#24508)
- A statement of the form `CREATE TABLE IF NOT EXISTS t1 SELECT f1() AS i` failed with a deadlock error if the stored function `f1()` referred to a table with the same name as the to-be-created table. Now it correctly produces a message that the table already exists. (Bug#22427)
- Quoted labels in stored routines were mishandled, rendering the routines unusable. (Bug#21513)
- `CURDATE()` is less than `NOW()`, either when comparing `CURDATE()` directly (`CURDATE() < NOW()` is true) or when casting `CURDATE()` to `DATE` (`CAST(CURDATE() AS DATE) < NOW()` is true). However, storing `CURDATE()` in a `DATE` column and comparing `col_name < NOW()` incorrectly yielded false. This is fixed by comparing a `DATE` column as `DATETIME` for comparisons to a `DATETIME` constant. (Bug#21103)
- `CREATE TABLE IF NOT EXISTS ... SELECT` caused a server crash if the target table already existed and had a `BEFORE INSERT` trigger. (Bug#20903)
- Deadlock occurred for attempts to execute `CREATE TABLE IF NOT EXISTS ... SELECT` when `LOCK TABLES` had been used to acquire a read lock on the target table. (Bug#20662, Bug#15522)
- For dates with 4-digit year parts less than 200, an incorrect implicit conversion to add a century was applied for date arithmetic performed with `DATE_ADD()`, `DATE_SUB()`, `+ INTERVAL`, and `- INTERVAL`. (For example, `DATE_ADD('0050-01-01 00:00:00', INTERVAL 0 SECOND)` became `'2050-01-01 00:00:00'`.) (Bug#18997)

- Changing the size of a key buffer that is under heavy use could cause a server crash. The fix partially removes the limitation that `LOAD INDEX INTO CACHE` fails unless all indexes in a table have the same block size. Now the statement fails only if `IGNORE LEAVES` is specified. (Bug#17332)

## C.2.20. Changes in MySQL 5.1.18 (08 May 2007)

This is a new Beta development release, fixing recently discovered bugs.

### Note

This Beta release, as any other pre-production release, should not be installed on *production* level systems or systems with critical data. It is good practice to back up your data before installing any new version of software. Although MySQL has worked very hard to ensure a high level of quality, protect your data by making a backup as you would for any software beta release. Please refer to our bug database at <http://bugs.mysql.com/> for more details about the individual bugs fixed in this version.

This section documents all changes and bug fixes that have been applied since the last official MySQL release. If you would like to receive more fine-grained and personalized *update alerts* about fixes that are relevant to the version and features you use, please consider subscribing to *MySQL Enterprise* (a commercial MySQL offering). For more details please see <http://www.mysql.com/products/enterprise>.

Functionality added or changed:

- **Incompatible Change: MySQL Cluster:** The internal specifications for columns in NDB tables has changed to allow compatibility with future MySQL Cluster releases that are expected to implement online adding and dropping of columns. This change is not backward compatible with earlier versions of MySQL Cluster.

See the related note in [MySQL Cluster 5.1 and MySQL Cluster NDB 6.x/7.x Upgrade and Downgrade Compatibility](#), for important information prior to upgrading a MySQL Cluster to MySQL 5.1.18 or later from MySQL 5.1.17 or earlier.

See also [Bug#28205](#).

- **Incompatible Change: Replication:** The `INFORMATION_SCHEMA.EVENTS` and `mysql.event` tables have been changed to facilitate replication of events. When upgrading to MySQL 5.1.18, you must run `mysql_upgrade` prior to working with events. Until you have done so, any statement relating to the Event Scheduler or these tables (including `SHOW EVENTS`) will fail with the errors `EXPECTED FIELD STATUS AT POSITION 12 TO HAVE TYPE ENUM ('ENABLED', 'SLAVESIDE_DISABLED', 'DISABLED')`, `FOUND ENUM('ENABLED', 'DISABLED')` and `TABLE MYSQL.EVENT IS DAMAGED. CAN NOT OPEN`.

These changes were made as part of fixes for the following bugs:

- The effects of scheduled events were not replicated (that is, binary logging of scheduled events did not work).
- Effects of scheduled events on a replication master were both replicated and executed on the slave, causing double execution of events.
- `CREATE FUNCTION` statements and their effects were not replicated correctly.

For more information, see [Section 16.3.1.7, “Replication of Invoked Features”](#). (Bug#17857, Bug#16421, Bug#20384, Bug#17671)

- **Cluster Replication: Incompatible Change:** The definition of the `mysql.ndb_apply_status` table has changed such that an online upgrade is not possible from MySQL 5.1.17 or earlier for a replication slave cluster; you must shut down all SQL nodes as part of the upgrade procedure. See [MySQL Cluster 5.1 and MySQL Cluster NDB 6.x/7.x Upgrade and Downgrade Compatibility](#) before upgrading for details.

For more information about the changes to `mysql.ndb_apply_status` see [MySQL Cluster Replication Schema and Tables](#).

- **Incompatible Change:** Prior to this release, when `DATE` values were compared with `DATETIME` values, the time portion of the `DATETIME` value was ignored, or the comparison could be performed as a string compare. Now a `DATE` value is coerced to the `DATETIME` type by adding the time portion as `00:00:00`. To mimic the old behavior, use the `CAST()` function as shown in this example: `SELECT date_col = CAST(NOW() AS DATE) FROM tablei`. (Bug#28929)
- **Important Change:** When upgrading to MySQL 5.1.18 or later from a previous MySQL version and scheduled events have been used, the upgrade utilities do not accommodate changes in event-related system tables. As a workaround, you can dump events before the upgrade, then restore them from the dump afterwards. This issue was fixed in MySQL 5.1.20.



See also [Bug#28521](#).

- **MySQL Cluster:** The behavior of the `ndb_restore` utility has been changed as follows:
  - It is now possible to restore selected databases or tables using `ndb_restore`.
  - Several options have been added for use with `ndb_restore --print_data` to facilitate the creation of structured data dump files. These options can be used to make dumps made using `ndb_restore` more like those produced by `mysqldump`.

For details of these changes, see `ndb_restore`. ([Bug#26899](#), [Bug#26900](#))
- **MySQL Cluster:** The following changes were made in the `ndb_size.pl` utility:
  - When `ndb_size.pl` calculates a value for a given configuration parameter that is less than the default value, it now suggests the default value instead.
  - The dependency on `HTML::Template` was removed, with the result that the file `ndb_size.tmpl` is no longer needed or included. ([Bug#24227](#), [Bug#24228](#))
- **Cluster Replication: Replication:** Some circular replication setups are now supported for MySQL Cluster. See [Known Issues in MySQL Cluster Replication](#), for detailed information. ([Bug#17095](#), [Bug#25688](#))
- **Cluster API:** The MGM API now supports explicit setting of network timeouts using the `ndb_mgm_set_timeout()` function. A utility function `ndb_mgm_number_of_mgrmd_in_connect_string()` is also implemented to facilitate calculation of timeouts based on the number of management servers in the cluster.
 

For more information, see `ndb_mgm_set_timeout()`, and `ndb_mgm_number_of_mgrmd_in_connect_string()`.
- `mysqld_multi` now understands the `--no-defaults`, `--defaults-file`, and `--defaults-extra-file` options. The `--config-file` option is deprecated; if given, it is treated like `--defaults-extra-file`. ([Bug#27390](#))
- If a set function `S` with an outer reference `S(outer_ref)` cannot be aggregated in the outer query against which the outer reference has been resolved, MySQL interprets `S(outer_ref)` the same way that it would interpret `S(const)`. However, standard SQL requires throwing an error in this situation. An error now is thrown for such queries if the `ANSI SQL` mode is enabled. ([Bug#27348](#))
- Several additional data types are supported for columns in `INFORMATION_SCHEMA` tables: `DATE`, `TIME`, `BLOB`, `FLOAT`, and all integer types. ([Bug#27047](#))
- The output of `mysql --xml` and `mysqldump --xml` now includes a valid XML namespace. ([Bug#25946](#))
- If you use SSL for a client connection, you can tell the client not to authenticate the server certificate by specifying neither `--ssl-ca` nor `--ssl-capath`. The server still verifies the client according to any applicable requirements established via `GRANT` statements for the client, and it still uses any `--ssl-ca/--ssl-capath` values that were passed to server at startup time. ([Bug#25309](#))
- Added a `MASTER_SSL_VERIFY_SERVER_CERT` option for the `CHANGE MASTER TO` statement, and a `Master_Ssl_Verify_Server_Cert` output column to the `SHOW SLAVE STATUS` statement. The option value also is written to the `master.info` file. ([Bug#19991](#))
- The `innodb_log_archive` system variable has been removed. The impact of this change should be low because the variable was unused, anyway.
- Added the `--auto-generate-sql-add-autoincrement`, `--auto-generate-sql-execute-number`, `--auto-generate-sql-guid-primary`, `--auto-generate-sql-secondary-indexes`, `--auto-generate-sql-unique-query-number`, `--auto-generate-sql-unique-write-number`, `--post-query`, and `--pre-query`, options for `mysqldslap`. Removed the `--lock-directory`, `--slave`, and `--use-threads` options.
- Added `--write-binlog` option for `mysqlbinlog`. This option is enabled by default, but can be given as `--skip-write-binlog` to cause `ANALYZE TABLE`, `OPTIMIZE TABLE`, and `REPAIR TABLE` statements generated by `mysqlcheck` not to be written to the binary log. ([Bug#26262](#))
- New command-line options: To alleviate ambiguities in variable names, all variables related to plugins can be specified using a `plugin` part in the name. For example, every time where we used to have `innodb` in the command-line options, you can now write `plugin-innodb`:

```
--skip-plugin-innodb
--plugin-innodb-buffer-pool-size=#
```

Furthermore, this is the preferred syntax. It helps to avoid ambiguities when a plugin, say, `wait`, has an option called `timeout`. `--wait-timeout` will still set a system variable, but `--plugin-wait-timeout` will set the plugin variable. Also, there is a new command-line option `--plugin-load` to install or load plugins at initialization time without using the `mysql.plugin` table.

- The plugin interface and its handling of system variables was changed. Command-line options such as `--skip-innodb` now cause an error if `InnoDB` is not built-in or plugin-loaded. You should use `--loose-skip-innodb` if you do not want any error even if `InnoDB` is not available. The `--loose` prefix modifier should be used for all command-line options where you are uncertain whether the plugin exists and when you want the operation to proceed even if the option is necessarily ignored due to the absence of the plugin. (For a description of how `--loose` works, see [Section 4.2.3.1, “Using Options on the Command Line”](#).)
- Storage engine plugins may now be uninstalled at run time. However, a plugin is not actually uninstalled until after its reference count drops to zero. The `default_storage_engine` system variable consumes a reference count, so uninstalling will not complete until said reference is removed.
- The `mysql_create_system_tables` script was removed because `mysql_install_db` no longer uses it in MySQL 5.1.
- Renamed the `old_mode` system variable to `old`.

Bugs fixed:

- **Security Fix:** The requirement of the `DROP` privilege for `RENAME TABLE` was not enforced. ([Bug#27515](#), [CVE-2007-2691](#))
- **Security Fix:** If a stored routine was declared using `SQL SECURITY INVOKER`, a user who invoked the routine could gain privileges. ([Bug#27337](#), [CVE-2007-2692](#))
- **Security Fix:** A user with only the `ALTER` privilege on a partitioned table could obtain information about the table that should require the `SELECT` privilege. ([Bug#23675](#), [CVE-2007-2693](#))
- **MySQL Cluster: Replication:** (Replication): An `UPDATE` on the master became a `DELETE` on slaves. ([Bug#27378](#))
- **MySQL Cluster:** The cluster waited 30 seconds instead of 30 milliseconds before reading table statistics. ([Bug#28093](#))
- **MySQL Cluster:** Under certain rare circumstances, `ndbd` could get caught in an infinite loop when one transaction took a read lock and then a second transaction attempted to obtain a write lock on the same tuple in the lock queue. ([Bug#28073](#))
- **MySQL Cluster:** Under some circumstances, a node restart could fail to update the Global Checkpoint Index (GCI). ([Bug#28023](#))
- **MySQL Cluster:** `INSERT IGNORE` wrongly ignored `NULL` values in unique indexes. ([Bug#27980](#))
- **MySQL Cluster:** The name of the month “March” was given incorrectly in the cluster error log. ([Bug#27926](#))
- **MySQL Cluster:** `NDB` tables having `MEDIUMINT AUTO_INCREMENT` columns were not restored correctly by `ndb_restore`, causing spurious duplicate key errors. This issue did not affect `TINYINT`, `INT`, or `BIGINT` columns with `AUTO_INCREMENT`. ([Bug#27775](#))
- **MySQL Cluster:** `NDB` tables with indexes whose names contained space characters were not restored correctly by `ndb_restore` (the index names were truncated). ([Bug#27758](#))
- **MySQL Cluster:** An `INSERT` followed by a delete `DELETE` on the same `NDB` table caused a memory leak. ([Bug#27756](#))  
This regression was introduced by [Bug#20612](#).
- **MySQL Cluster:** It was not possible to add a unique index to an `NDB` table while in single user mode. ([Bug#27710](#))
- **MySQL Cluster:** Under certain rare circumstances performing a `DROP TABLE` or `TRUNCATE` on an `NDB` table could cause a node failure or forced cluster shutdown. ([Bug#27581](#))
- **MySQL Cluster:** Memory usage of a `mysqld` process grew even while idle. ([Bug#27560](#))
- **MySQL Cluster:** Using more than 16GB for `DataMemory` caused problems with variable-size columns. ([Bug#27512](#))
- **MySQL Cluster:** A data node failing while another data node was restarting could leave the cluster in an inconsistent state. In certain rare cases, this could lead to a race condition and the eventual forced shutdown of the cluster. ([Bug#27466](#))

- **MySQL Cluster:** When using the `MemReportFrequency` configuration parameter to generate periodic reports of memory usage in the cluster log, `DataMemory` usage was not always reported for all data nodes. (Bug#27444)
- **MySQL Cluster:** When trying to create an `NDB` table after the server was started with `--ndbcluster` but without `--ndb-connectstring`, `mysqld` produced a memory allocation error. (Bug#27359)
- **MySQL Cluster:** Performing a delete followed by an insert during a local checkpoint could cause a `ROWID ALREADY ALLOCATED` error. (Bug#27205)
- **MySQL Cluster:** In an `NDB` table having a `TIMESTAMP` column using `DEFAULT CURRENT_TIMESTAMP`, that column would assume a random value when another column in the same row was updated. (Bug#27127)
- **MySQL Cluster:** Error messages displayed when running in single user mode were inconsistent. (Bug#27021)
- **MySQL Cluster:** On Solaris, the value of an `NDB` table column declared as `BIT(33)` was always displayed as 0. (Bug#26986)
- **MySQL Cluster:** Performing `ALTER TABLE ... ENGINE=MERGE` on an `NDB` table caused `mysqld` to crash. (Bug#26898)
- **MySQL Cluster:** The `NDBCLUSTER` table handler did not set bits in null bytes correctly. (Bug#26591)
- **MySQL Cluster:** In some cases, `AFTER UPDATE` and `AFTER DELETE` triggers on `NDB` tables that referenced subject table did not see the results of operation which caused invocation of the trigger, but rather saw the row as it was prior to the update or delete operation.

This was most noticeable when an update operation used a subquery to obtain the rows to be updated. An example would be `UPDATE tbl1 SET col2 = val1 WHERE tbl1.col1 IN (SELECT col3 FROM tbl2 WHERE col4 = val2)` where there was an `AFTER UPDATE` trigger on table `tbl1`. In such cases, the trigger would fail to execute.

The problem occurred because the actual update or delete operations were deferred to be able to perform them later as one batch. The fix for this bug solves the problem by disabling this optimization for a given update or delete if the table has an `AFTER` trigger defined for this operation. (Bug#26242)

- **MySQL Cluster:** Joins on multiple tables containing `BLOB` columns could cause data nodes run out of memory, and to crash with the error `NDBOBJECTIDMAP: :EXPAND UNABLE TO EXPAND`. (Bug#26176)
- **MySQL Cluster:** `START BACKUP NOWAIT` caused a spurious `OUT OF BACKUP RECORD` error in the management client (`START BACKUP` and `START BACKUP WAIT STARTED` performed normally). (Bug#25446)
- **MySQL Cluster:** Adding of indexes online failed for `NDB` tables having `BLOB` or `TEXT` columns. (Bug#25431)
- **MySQL Cluster:** When a cluster data node suffered a “hard” failure (such as a power failure or loss of a network connection) TCP sockets to the missing node were maintained indefinitely. Now socket-based transporters check for a response and terminate the socket if there is no activity on the socket after 2 hours. (Bug#24793)
- **MySQL Cluster:** The `ndb_resize.pl` utility did not calculate memory usage for indexes correctly. (Bug#24229)
- **MySQL Cluster:** While a data node was stopped, dropping a table then creating an index on a different table caused that node to fail during restart. This was due to the re-use of the dropped table's internal ID for the index without verifying that the index now referred to a different database object. (Bug#21755)
- **MySQL Cluster:** When trying to create tables on an SQL node not connected to the cluster, a misleading error message `TABLE 'TBL_NAME' ALREADY EXISTS` was generated. The error now generated is `COULD NOT CONNECT TO STORAGE ENGINE`. (Bug#11217, Bug#18676)
- **Cluster Replication: Replication:** An SQL node acting as a replication master server could be a single point of failure; that is, if it failed, the replication slave had no way of knowing this, which could result in a mismatch of data between the master and the slave. (Bug#21494)
- **Replication:** Out-of-memory errors were not reported. Now they are written to the error log. (Bug#26844)
- **Replication:** Improved out-of-memory detection when sending logs from a master server to slaves, and log a message when allocation fails. (Bug#26837)
- **Replication:** Aborting a statement on the master that applied to a non-transactional statement broke replication. The statement was written to the binary log but not completely executed on the master. Slaves receiving the statement executed it completely, resulting in loss of data synchrony. Now an error code is written to the error log so that the slaves stop without executing the aborted statement. (That is, replication stops, but synchrony to the point of the stop is preserved and you can investigate the problem.) (Bug#26551)

- **Replication:** When `RAND()` was called multiple times inside a stored procedure, the server did not write the correct random seed values to the binary log, resulting in incorrect replication. (Bug#25543)
- **Replication:** `GRANT` statements were not replicated if the server was started with the `--replicate-ignore-table` or `--replicate-wild-ignore-table` option. (Bug#25482)
- **Replication:** Restoration of the default database after stored routine or trigger execution on a slave could cause replication to stop if the database no longer existed. (Bug#25082)
- **Replication:** If a rotate event occurred in the middle of a non-transaction group, the group position would be updated by the rotate event indicating an illegal group start position that was effectively inside a group. This can happen if, for example, a rotate occurs between an `Intvar` event and the associated `Query` event, or between the table map events and the rows events when using row-based replication. (Bug#23171)
- **Replication:** Row-based replication of `MyISAM` to non-`MyISAM` tables did not work correctly for `BIT` columns. This has been corrected, but the fix introduces an incompatibility into the binary log format. (The incompatibility is corrected by the fix for Bug#27779.) (Bug#22583)
- **Cluster Replication: Disk Data:** An issue with replication of Disk Data tables could in some cases lead to node failure. (Bug#28161)
- **Disk Data:** Changes to a Disk Data table made as part of a transaction could not be seen by the client performing the changes until the transaction had been committed. (Bug#27757)
- **Disk Data:** When in single user mode, it was possible to create log file groups and tablespaces from any SQL node connected to the cluster. (Bug#27712)
- **Disk Data:** `CREATE TABLE ... LIKE disk_data_table` created an in-memory `NDB` table. (Bug#25875)
- **Disk Data:** When restarting a data node following the creation of a large number of Disk Data objects (approximately 200 such objects), the cluster could not assign a node ID to the restarting node. (Bug#25741)
- **Disk Data:** Creating an excessive number of Disk Data tables (1000 or more) could cause data nodes to fail. (Bug#24951)
- **Disk Data:** Changing a column specification or issuing a `TRUNCATE` statement on a Disk Data table caused the table to become an in-memory table.  
This fix supersedes an incomplete fix that was made for this issue in MySQL 5.1.15. (Bug#24667, Bug#25296)
- **Disk Data:** Setting the value of the `UNDO_BUFFER_SIZE` to 64K or less in a `CREATE LOGFILE GROUP` statement led to failure of cluster data nodes. (Bug#24560)
- **Disk Data:** Creating an excessive number of data files for a single tablespace caused data nodes to crash. (Bug#24521)
- **Disk Data:** It was possible to drop the last remaining datafile in a tablespace using `ALTER TABLESPACE`, even when there was still an empty table using the tablespace.

**Note**

The datafile could be not dropped if the table still contained any rows, so this bug involved no loss of data.

(Bug#21699)

- **Cluster Replication:** Some queries that updated multiple tables were not backed up correctly. (Bug#27748)
- **Cluster Replication:** It was possible for API nodes to begin interacting with the cluster subscription manager before they were fully connected to the cluster. (Bug#27728)
- **Cluster Replication:** Under very high loads, checkpoints could be read or written with checkpoint indexes out of order. (Bug#27651)
- **Cluster Replication:** Trying to replicate a large number of frequent updates with a relatively small relay log (`max-relay-log-size` set to 1M or less) could cause the slave to crash. (Bug#27529)
- **Cluster Replication:** Setting `sql_log_bin` to zero did not disable binary logging.

This issue affected only the `NDB` storage engine. (Bug#27076)

- **Cluster API:** For `BLOB` reads on operations with lock mode `LM_CommittedRead`, the lock mode was not upgraded to `LM_Read` before the state of the `BLOB` had already been calculated. The `NDB` API methods affected by this problem included the following:

- `NdbOperation::readTuple()`
  - `NdbScanOperation::readTuples()`
  - `NdbIndexScanOperation::readTuples()` (Bug#27320)
  - **Cluster API:** Using `NdbBlob::writeData()` to write data in the middle of an existing blob value (that is, updating the value) could overwrite some data past the end of the data to be changed. (Bug#27018)
  - A performance degradation was observed for outer join queries to which a not-exists optimization was applied. (Bug#28188)
  - `SELECT * INTO OUTFILE ... FROM INFORMATION_SCHEMA.SCHEMATA` failed with an `ACCESS DENIED` error, even for a user who had the `FILE` privilege. (Bug#28181)
  - Early `NULL`-filtering optimization did not work for `eq_ref` table access. (Bug#27939)
  - Non-grouped columns were allowed by `*` in `ONLY_FULL_GROUP_BY` SQL mode. (Bug#27874)
  - Some equi-joins containing a `WHERE` clause that included a `NOT IN` subquery caused a server crash. (Bug#27870)
  - An error message suggested the use of `mysql_fix_privilege_tables` after an upgrade, but the recommended program is now `mysql_upgrade`. (Bug#27818)
  - Debug builds on Windows generated false alarms about uninitialized variables with some Visual Studio runtime libraries. (Bug#27811)
  - Certain queries that used uncorrelated scalar subqueries caused `EXPLAIN` to crash. (Bug#27807)
  - Performing a `UNION` on two views that had `ORDER BY` clauses resulted in an `Unknown column` error. (Bug#27786)
  - `mysql_install_db` is supposed to detect existing system tables and create only those that do not exist. Instead, it was exiting with an error if tables already existed. (Bug#27783)
  - The `LEAST()` and `GREATEST()` functions compared `DATE` and `DATETIME` values as strings, which in some cases could lead to an incorrect result. (Bug#27759)
  - A memory leak in the event scheduler was uncovered by Valgrind. (Bug#27733)
  - `mysqld` did not check the length of option values and could crash with a buffer overflow for long values. (Bug#27715)
  - Comparisons using row constructors could fail for rows containing `NULL` values. (Bug#27704)
  - `mysqldump` could not connect using SSL. (Bug#27669)
  - `SELECT DISTINCT` could return incorrect results if the select list contained duplicated columns. (Bug#27659)
  - On Linux, the server could not create temporary tables if `lower_case_table_names` was set to 1 and the value of `tmpdir` was a directory name containing any uppercase letters. (Bug#27653)
  - For InnoDB tables, a multiple-row `INSERT` of the form `INSERT INTO t (id...) VALUES (NULL...) ON DUPLICATE KEY UPDATE id=VALUES(id)`, where `id` is an `AUTO_INCREMENT` column, could cause `ERROR 1062 (23000): Duplicate entry...` errors or lost rows. (Bug#27650)
  - When MySQL logged slow query information to a `CSV` table, it used an incorrect formula to calculate the `query_time` and `lock_time` values. (Bug#27638)
  - The XML output representing an empty result was an empty string rather than an empty `<resultset/>` element. (Bug#27608)
  - Comparison of a `DATE` with a `DATETIME` did not treat the `DATE` as having a time part of `00:00:00`. (Bug#27590)
- See also [Bug#32198](#).
- With `NO_AUTO_VALUE_ON_ZERO` SQL mode enabled, `LOAD DATA` operations could assign incorrect `AUTO_INCREMENT` values. (Bug#27586)
  - Group relay log rotation updated only the log position and not the name, causing the slave to stop. (Bug#27583)
  - Incorrect results could be returned for some queries that contained a select list expression with `IN` or `BETWEEN` together with an `ORDER BY` or `GROUP BY` on the same expression using `NOT IN` or `NOT BETWEEN`. (Bug#27532)

- The fix for [Bug#17212](#) provided correct sort order for misordered output of certain queries, but caused significant overall query performance degradation. (Results were correct (good), but returned much more slowly (bad).) The fix also affected performance of queries for which results were correct. The performance degradation has been addressed. ([Bug#27531](#))
- The `CRC32()` function returns an unsigned integer, but the metadata was signed, which could cause certain queries to return incorrect results. (For example, queries that selected a `CRC32()` value and used that value in the `GROUP BY` clause.) ([Bug#27530](#))
- An interaction between `SHOW TABLE STATUS` and other concurrent statements that modify the table could result in a divide-by-zero error and a server crash. ([Bug#27516](#))
- Evaluation of an `IN()` predicate containing a decimal-valued argument caused a server crash. ([Bug#27513](#), [Bug#27362](#), [CVE-2007-2583](#))
- A race condition between `DROP TABLE` and `SHOW TABLE STATUS` could cause the latter to display incorrect information. ([Bug#27499](#))
- In out-of-memory conditions, the server might crash or otherwise not report an error to the Windows event log. ([Bug#27490](#))
- Passing nested row expressions with different structures to an `IN` predicate caused a server crash. ([Bug#27484](#))
- The `decimal.h` header file was incorrectly omitted from binary distributions. ([Bug#27456](#))
- With `innodb_file_per_table` enabled, attempting to rename an InnoDB table to a non-existent database caused the server to exit. ([Bug#27381](#))
- Nested aggregate functions could be improperly evaluated. ([Bug#27363](#))
- A stored function invocation in the `WHERE` clause was treated as a constant. ([Bug#27354](#))
- For the `INFORMATION_SCHEMA_SESSION_STATUS` and `GLOBAL_STATUS` tables, some status values were incorrectly converted to the data type of the `VARIABLE_VALUE` column. ([Bug#27327](#))
- Failure to allocate memory associated with `transaction_prealloc_size` could cause a server crash. ([Bug#27322](#))
- A subquery could get incorrect values for references to outer query columns when it contained aggregate functions that were aggregated in outer context. ([Bug#27321](#))
- The server did not shut down cleanly. ([Bug#27310](#))
- In a view, a column that was defined using a `GEOMETRY` function was treated as having the `LONGBLOB` data type rather than the `GEOMETRY` type. ([Bug#27300](#))
- `mysqldump` crashed if it got no data from `SHOW CREATE PROCEDURE` (for example, when trying to dump a routine defined by a different user and for which the current user had no privileges). Now it prints a comment to indicate the problem. It also returns an error, or continues if the `--force` option is given. ([Bug#27293](#))
- Queries containing subqueries with `COUNT(*)` aggregated in an outer context returned incorrect results. This happened only if the subquery did not contain any references to outer columns. ([Bug#27257](#))
- Use of an aggregate function from an outer context as an argument to `GROUP_CONCAT()` caused a server crash. ([Bug#27229](#))
- String truncation upon insertion into an integer or year column did not generate a warning (or an error in strict mode). ([Bug#27176](#), [Bug#26359](#))
- `mysqlbinlog` produced different output with the `-R` option than without it. ([Bug#27171](#))
- Storing `NULL` values in spatial fields caused excessive memory allocation and crashes on some systems. ([Bug#27164](#))
- Row equalities in `WHERE` clauses could cause memory corruption. ([Bug#27154](#))
- `ON DUPLICATE KEY UPDATE` failed for a table partitioned by `KEY` on a primary key `VARCHAR` column. ([Bug#27123](#))
- `GROUP BY` on a `ucs2` column caused a server crash when there was at least one empty string in the column. ([Bug#27079](#))
- Duplicate members in `SET` or `ENUM` definitions were not detected. Now they result in a warning; if strict SQL mode is enabled, an error occurs instead. ([Bug#27069](#))
- For `FEDERATED` tables, `SHOW CREATE TABLE` could fail when the table name was longer than the connection name. ([Bug#27036](#))



- `mysql_install_db` could terminate with an error after failing to determine that a system table already existed. (Bug#27022)
- In a `MEMORY` table, using a `BTREE` index to scan for updatable rows could lead to an infinite loop. (Bug#26996)
- `make_win_bin_dist` neglected to copy some required `MyISAM` table files. (Bug#26922)
- For `InnoDB` tables having a clustered index that began with a `CHAR` or `VARCHAR` column, deleting a record and then inserting another before the deleted record was purged could result in table corruption. (Bug#26835)
- `mysqldump` would not dump a view for which the `DEFINER` no longer exists. (Bug#26817)
- Duplicates were not properly identified among (potentially) long strings used as arguments for `GROUP_CONCAT(DISTINCT)`. (Bug#26815)
- `ALTER VIEW` requires the `CREATE VIEW` and `DROP` privileges for the view. However, if the view was created by another user, the server erroneously required the `SUPER` privilege. (Bug#26813)
- If the name of a table given to `myisamchk -rq` was a packed table and the name included the `.MYI` extension, `myisamchk` incorrectly created a file with a `.MYI.MYI` extension. (Bug#26782)
- Creating a temporary table with `InnoDB` when using the one-file-per-table setting, and when the host file system for temporary tables was `tmpfs`, would cause an assertion within `mysqld`. This was due to the use of `O_DIRECT` when opening the temporary table file. (Bug#26662)
- `mysql_upgrade` did not detect failure of external commands that it runs. (Bug#26639)
- The range optimizer could cause the server to run out of memory. (Bug#26625)
- The range optimizer could consume a combinatorial amount of memory for certain classes of `WHERE` clauses. (Bug#26624)
- `mysqldump` could crash or exhibit incorrect behavior when some options were given very long values, such as `--fields-terminated-by="some very long string"`. The code has been cleaned up to remove a number of fixed-sized buffers and to be more careful about error conditions in memory allocation. (Bug#26346)
- A possible buffer overflow in `SHOW PROCEDURE CODE` was removed. (Bug#26303)
- The `FEDERATED` engine did not allow the local and remote tables to have different names. (Bug#26257)
- The temporary file-creation code was cleaned up on Windows to improve server stability. (Bug#26233)
- For `MyISAM` tables, `COUNT(*)` could return an incorrect value if the `WHERE` clause compared an indexed `TEXT` column to the empty string (' '). This happened if the column contained empty strings and also strings starting with control characters such as tab or newline. (Bug#26231)
- For `INSERT INTO ... SELECT` where index searches used column prefixes, insert errors could occur when key value type conversion was done. (Bug#26207)
- `mysqlbinlog --base64-output` produced invalid SQL. (Bug#26194)
- For `DELETE FROM tbl_name ORDER BY col_name` (with no `WHERE` or `LIMIT` clause), the server did not check whether `col_name` was a valid column in the table. (Bug#26186)
- Executing an `INSERT ... SELECT ... FROM INFORMATION_SCHEMA.GLOBAL_STATUS` statement from within an event caused a server crash. (Bug#26174)
- `mysqldump` could not dump log tables. (Bug#26121)
- On Windows, trying to use backslash (\) characters in paths for `DATA DIRECTORY` and `INDEX DIRECTORY` when creating partitioned tables caused MySQL to crash.  
  
(You must use / characters when specifying paths for these options, regardless of platform. See [Section 17.1, "Overview of Partitioning in MySQL"](#), for an example using absolute paths for `DATA DIRECTORY` and `INDEX DIRECTORY` when creating a partitioned table on Windows.) (Bug#26074, Bug#25141)
- `mysqldump` crashed for `MERGE` tables if the `--complete-insert (-c)` option was given. (Bug#25993)
- Index hints (`USE INDEX`, `IGNORE INDEX`, `FORCE INDEX`) cannot be used with `FULLTEXT` indexes, but were not being ignored. (Bug#25951)
- Setting a column to `NOT NULL` with an `ON DELETE SET NULL` clause foreign key crashes the server. (Bug#25927)

- Corrupted `MyISAM` tables that have different definitions in the `.frm` and `.MYI` tables might cause a server crash. (Bug#25908)
- If `CREATE TABLE t1 LIKE t2` failed due to a full disk, an empty `t2.frm` file could be created but not removed. This file then caused subsequent attempts to create a table named `t2` to fail. This is easily corrected at the file system level by removing the `t2.frm` file manually, but now the server removes the file if the create operation does not complete successfully. (Bug#25761)
- In certain situations, `MATCH ... AGAINST` returned false hits for `NULL` values produced by `LEFT JOIN` when no full-text index was available. (Bug#25729)
- Concurrent `CREATE SERVER` and `ALTER SERVER` statements could cause a deadlock. (Bug#25721)
- `CREATE SERVER`, `DROP SERVER`, and `ALTER SERVER` did not require any privileges. Now these statements require the `SUPER` privilege. (Bug#25671)
- On Windows, connection handlers did not properly decrement the server's thread count when exiting. (Bug#25621)
- `OPTIMIZE TABLE` might fail on Windows when it attempts to rename a temporary file to the original name if the original file had been opened, resulting in loss of the `.MYD` file. (Bug#25521)
- For `SHOW ENGINE INNODB STATUS`, the `LATEST DEADLOCK INFORMATION` was not always cleared properly. (Bug#25494)
- `mysql_stmt_fetch()` did an invalid memory deallocation when used with the embedded server. (Bug#25492)
- `mysql_upgrade` did not pass a password to `mysqlcheck` if one was given. (Bug#25452)
- On Windows, `mysql_upgrade` was sensitive to lettercase of the names of some required components. (Bug#25405)
- During a call to `mysql_change_user()`, when authentication fails or the database to change to is unknown, a subsequent call to any function that does network communication leads to packets out of order. This problem was introduced in MySQL 5.1.14. (Bug#25371)
- Difficult repair or optimization operations could cause an assertion failure, resulting in a server crash. (Bug#25289)
- For storage engines that allow the current auto-increment value to be set, using `ALTER TABLE ... ENGINE` to convert a table from one such storage engine to another caused loss of the current value. (For storage engines that do not support setting the value, it cannot be retained anyway when changing the storage engine.) (Bug#25262)
- Duplicate entries were not assessed correctly in a `MEMORY` table with a `BTREE` primary key on a `utf8 ENUM` column. (Bug#24985)
- Several math functions produced incorrect results for large unsigned values. `ROUND()` produced incorrect results or a crash for a large number-of-decimals argument. (Bug#24912)
- The result set of a query that used `WITH ROLLUP` and `DISTINCT` could lack some rollup rows (rows with `NULL` values for grouping attributes) if the `GROUP BY` list contained constant expressions. (Bug#24856)
- Selecting the result of `AVG()` within a `UNION` could produce incorrect values. (Bug#24791)
- For queries that used `ORDER BY` with `InnoDB` tables, if the optimizer chose an index for accessing the table but found a covering index that enabled the `ORDER BY` to be skipped, no results were returned. (Bug#24778)
- The `NO_DIR_IN_CREATE` server SQL mode was not enforced for partitioned tables. (Bug#24633)
- `MBRDisjoint()`, `MBRequal()`, `MBRIntersects()`, `MBROverlaps()`, `MBRTouches()`, and `MBRWithin()` were inadvertently omitted from recent versions of MySQL (5.1.14 to 5.1.17). (Bug#24588)
- Access via `my_pread()` or `my_pwrite()` to table files larger than 2GB could fail on some systems. (Bug#24566)
- `MBROverlaps()` returned incorrect values in some cases. (Bug#24563)
- A problem in handling of aggregate functions in subqueries caused predicates containing aggregate functions to be ignored during query execution. (Bug#24484)
- The `MERGE` storage engine could return incorrect results when several index values that compare equality were present in an index (for example, `'gross'` and `'gross '`, which are considered equal but have different lengths). (Bug#24342)
- Some upgrade problems are detected and better error messages suggesting that `mysql_upgrade` be run are produced. (Bug#24248)



- The test for the `MYSQL_OPT_SSL_VERIFY_SERVER_CERT` option for `mysql_options()` was performed incorrectly. Also changed as a result of this bug fix: The `arg` option for the `mysql_options()` C API function was changed from `char *` to `void *`. (Bug#24121)
- Some views could not be created even when the user had the requisite privileges. (Bug#24040)
- The values displayed for the `InnoDB_row_lock_time`, `InnoDB_row_lock_time_avg`, and `InnoDB_row_lock_time_max` status variables were incorrect. (Bug#23666)
- Using `CAST()` to convert `DATETIME` values to numeric values did not work. (Bug#23656)
- A damaged or missing `mysql.event` table caused `SHOW VARIABLES` to fail. (Bug#23631)
- `SHOW CREATE VIEW` qualified references to stored functions in the view definition with the function's database name, even when the database was the default database. This affected `mysqldump` (which uses `SHOW CREATE VIEW` to dump views) because the resulting dump file could not be used to reload the database into a different database. `SHOW CREATE VIEW` now suppresses the database name for references to functions in the default database. (Bug#23491)
- An `INTO OUTFILE` clause is allowed only for the final `SELECT` of a `UNION`, but this restriction was not being enforced correctly. (Bug#23345)
- The `AUTO_INCREMENT` value would not be correctly reported for `InnoDB` tables when using `SHOW CREATE TABLE` statement or `mysqldump` command. (Bug#23313)
- With the `NO_AUTO_VALUE_ON_ZERO` SQL mode enabled, `LAST_INSERT_ID()` could return 0 after `INSERT ... ON DUPLICATE KEY UPDATE`. Additionally, the next rows inserted (by the same `INSERT`, or the following `INSERT` with or without `ON DUPLICATE KEY UPDATE`), would insert 0 for the auto-generated value if the value for the `AUTO_INCREMENT` column was `NULL` or missing. (Bug#23233)
- Implicit conversion of `9912101` to `DATE` did not match `CAST(9912101 AS DATE)`. (Bug#23093)
- `SELECT COUNT(*)` from a table containing a `DATETIME NOT NULL` column could produce spurious warnings with the `NO_ZERO_DATE` SQL mode enabled. (Bug#22824)
- Using `SET GLOBAL` to change the `lc_time_names` system variable had no effect on new connections. (Bug#22648)
- `SOUNDEX()` returned an invalid string for international characters in multi-byte character sets. (Bug#22638)
- A multiple-table `UPDATE` could return an incorrect rows-matched value if, during insertion of rows into a temporary table, the table had to be converted from a `MEMORY` table to a `MyISAM` table. (Bug#22364)
- `COUNT(decimal_expr)` sometimes generated a spurious truncation warning. (Bug#21976)
- `yaSSL` crashed on pre-Pentium Intel CPUs. (Bug#21765)
- A slave that used `--master-ssl-cipher` could not connect to the master. (Bug#21611)
- Database and table names have a maximum length of 64 characters (even if they contain multi-byte characters), but were truncated to 64 bytes.

**Note**

This improves on a previous fix made for this bug in MySQL 5.1.12.

(Bug#21432)

- `InnoDB`: The first read statement, if served from the query cache, was not consistent with the `READ COMMITTED` isolation level. (Bug#21409)
- On Windows, if the server was installed as a service, it did not auto-detect the location of the data directory. (Bug#20376)
- Changing a `utf8` column in an `InnoDB` table to a shorter length did not shorten the data values. (Bug#20095)
- In some cases, the optimizer preferred a range or full index scan access method over lookup access methods when the latter were much cheaper. (Bug#19372)
- Conversion of `DATETIME` values in numeric contexts sometimes did not produce a double (`YYYYMMDDHHMMSS.uuuuuu`) value. (Bug#16546)
- `INSERT...ON DUPLICATE KEY UPDATE` could cause `Error 1032: Can't find record in ...` for inserts into an `InnoDB` table unique index using key column prefixes with an underlying `utf8` string column. (Bug#13191)

- Having the `EXECUTE` privilege for a routine in a database should make it possible to `USE` that database, but the server returned an error instead. This has been corrected. As a result of the change, `SHOW TABLES` for a database in which you have only the `EXECUTE` privilege returns an empty set rather than an error. (Bug#9504)

## C.2.21. Changes in MySQL 5.1.17 (04 April 2007)

This is a new Beta development release, fixing recently discovered bugs.

### Note

This Beta release, as any other pre-production release, should not be installed on *production* level systems or systems with critical data. It is good practice to back up your data before installing any new version of software. Although MySQL has worked very hard to ensure a high level of quality, protect your data by making a backup as you would for any software beta release. Please refer to our bug database at <http://bugs.mysql.com/> for more details about the individual bugs fixed in this version.

This section documents all changes and bug fixes that have been applied since the last official MySQL release. If you would like to receive more fine-grained and personalized *update alerts* about fixes that are relevant to the version and features you use, please consider subscribing to *MySQL Enterprise* (a commercial MySQL offering). For more details please see <http://www.mysql.com/products/enterprise>.

Functionality added or changed:

- **Incompatible Change:** Scheduled events now use the MySQL server time zone to determine their schedules, rather than UTC as in previous releases. Because of this change, scheduled event metadata now includes time zone information, which can be seen in the `TIME_ZONE` column of the `INFORMATION_SCHEMA.EVENTS` table and the `Time zone` column in the output of the `SHOW EVENTS` statement. These columns have been added in this release, along with a `time_zone` column in the `mysql.event` table. Due to these changes, events created in previous versions of MySQL cannot be created, viewed, or used until `mysql.event` has been upgraded. (Bug#16420)
- **Important Change: Replication:** The following options for controlling replication master configuration on a slave are now deprecated.

- `--master-host`
- `--master-user`
- `--master-password`
- `--master-port`
- `--master-connect-retry`
- `--master-ssl`
- `--master-ssl-ca`
- `--master-ssl-capath`
- `--master-ssl-cert`
- `--master-ssl-cipher`
- `--master-ssl-key`

To change the master configuration on a slave you should use the `CHANGE MASTER TO` statement.

See also [Bug#21490](#).

- **Important Change:** The `CREATE EVENT` and `ALTER EVENT` statements now support a `DEFINER` clause, similar to that used in the `CREATE TRIGGER` statement.
- See [Section 12.1.11, “CREATE EVENT Syntax”](#), for detailed information. (Bug#16425)
- **MySQL Cluster:** Added the `--skip-table-check` option (short form `-s`) for `ndb_restore`, which causes the restoration process to ignore any changes that may have occurred in table schemas after the backup was made. Previously, this was the default behavior.

See `ndb_restore`, for more information. (Bug#24363)

- Added a `--no-beep` option to `mysqladmin`. It suppresses the warning beep that is emitted by default for errors such as a failure to connect to the server. (Bug#26964)
- Added the `--service-startup-timeout` option for `mysql.server` to specify how long to wait for the server to start. If the server does not start within the timeout period, `mysql.server` exits with an error. (Bug#26952)
- Prefix lengths for columns in `SPATIAL` indexes can no longer be specified. For tables created in older versions of MySQL that have `SPATIAL` indexes containing prefixed columns, dumping and reloading the table causes the indexes to be created with no prefixes. (The full column width of each column is indexed.) (Bug#26794)
- Added the `innodb_stats_on_metadata` system variable to enable control over whether `InnoDB` performs statistics gathering when metadata statements are executed. See [Section 13.6.3, “InnoDB Startup Options and System Variables”](#). (Bug#26598)
- Statements that affect `mysql` database tables now are written to the binary log using the following rules:
  - Data manipulation statements such as `INSERT` that change data in `mysql` database tables directly are logged according to the settings of the `binlog_format` system variable.
  - Statements such as `GRANT` that change the `mysql` database indirectly are logged as statements regardless of the value of `binlog_format`.

For more details, see [Section 5.2.4.4, “Logging Format for Changes to `mysql` Database Tables”](#). (Bug#25091)

- The server now includes a timestamp in error messages that are logged as a result of unhandled signals (such as `mysqld got signal 11` messages). (Bug#24878)
- The syntax for index hints has been extended to enable more fine-grained control over the optimizer's selection of an execution plan for various phases of query processing. See [Section 12.2.8.2, “Index Hint Syntax”](#). (Bug#21174)
- Added the `--secure-file-priv` option for `mysqld`, which limits the effect of the `LOAD_FILE()` function and the `LOAD DATA` and `SELECT ... INTO OUTFILE` statements to work only with files in a given directory. (Bug#18628)
- Prepared statements now use the query cache under the conditions described in [Section 7.5.5.1, “How the Query Cache Operates”](#). (Bug#735)
- Added the `thread_handling` system variable to control whether the server use a single thread or one thread per connection. The `--one-thread` option now is deprecated; use `--thread_handling=one-thread` instead.
- Statements such as `GRANT` that change the `mysql` database indirectly are logged as statements regardless of the value of `binlog_format`.
- Added the read-only `hostname` system variable, which the server sets at startup to the server host name.
- Online (non-copying) `ADD INDEX` and `DROP INDEX` operations are now performed on dynamic (variable-width) columns. Renaming of `NDB` and `MyISAM` tables and of columns in such tables is now performed without copying or locking the tables. As a result, these operations are now performed much more quickly than previously.  
  
See [Section 12.1.7, “ALTER TABLE Syntax”](#), [Section 12.1.13, “CREATE INDEX Syntax”](#), and [Section 12.1.24, “DROP INDEX Syntax”](#), for more information.
- Data manipulation statements such as `INSERT` that change data in `mysql` database tables directly are logged according to the settings of the `binlog_format` system variable.
- Added the `old_mode` system variable to cause the server to revert to certain behaviors present in older versions. Currently, this variable affects handling of index hints. See [Section 12.2.8.2, “Index Hint Syntax”](#).

Bugs fixed:

- **Incompatible Change:** `INSERT DELAYED` statements are not supported for `MERGE` tables, but the `MERGE` storage engine was not rejecting such statements, resulting in table corruption. Applications previously using `INSERT DELAYED` into `MERGE` table will break when upgrading to versions with this fix. To avoid the problem, remove `DELAYED` from such statements. (Bug#26464)
- **Important Note:** The parser accepted invalid code in SQL condition handlers, leading to server crashes or unexpected execution behavior in stored programs. Specifically, the parser allowed a condition handler to refer to labels for blocks that enclose the handler declaration. This was incorrect because block label scope does not include the code for handlers declared within the labeled block.

The parser now rejects this invalid construct, but if you perform a binary upgrade (without dumping and reloading your databases), existing handlers that contain the construct are still invalid and should be rewritten *even if they appear to function as you expect*.

To find affected handlers, use `mysqldump` to dump all stored procedures and functions, triggers, and events. Then attempt to reload them into an upgraded server. Handlers that contain illegal label references will be rejected.

For more information about condition handlers and writing them to avoid invalid jumps, see [Section 12.8.4.2, “DECLARE for Handlers”](#). (Bug#26503)

- **MySQL Cluster:** It was not possible to set `LockPagesInMainMemory` equal to 0. (Bug#27291)
- **MySQL Cluster:** A race condition could sometimes occur if the node acting as master failed while node IDs were still being allocated during startup. (Bug#27286)
- **MySQL Cluster:** When a data node was taking over as the master node, a race condition could sometimes occur as the node was assuming responsibility for handling of global checkpoints. (Bug#27283)
- **MySQL Cluster:** After putting the cluster in single user mode from one MySQL server, trying to drop an NDB table from a second MySQL server also connected to the cluster would cause the second MySQL server to hang. (Bug#27254)
- **MySQL Cluster:** `mysqld` could crash shortly after a data node failure following certain DML operations. (Bug#27169)
- **MySQL Cluster:** (Disk Data): Under some circumstances, a data node could fail during restart while flushing Disk Data UNDO logs. (Bug#27102)
- **MySQL Cluster:** The same failed request from an API node could be handled by the cluster multiple times, resulting in reduced performance. (Bug#27087)
- **MySQL Cluster:** The failure of a data node while restarting could cause other data nodes to hang or crash. (Bug#27003)
- **MySQL Cluster:** Creating a table on one SQL node while in single user mode caused other SQL nodes to crash. (Bug#26997)
- **MySQL Cluster:** `mysqld` processes would sometimes crash under high load. (Bug#26825)
- **MySQL Cluster:** Using only the `--print_data` option (and no other options) with `ndb_restore` caused `ndb_restore` to fail. (Bug#26741)

This regression was introduced by [Bug#14612](#).

- **MySQL Cluster:** The output from `ndb_restore --print_data` was incorrect for a backup made of a database containing tables with `TINYINT` or `SMALLINT` columns. (Bug#26740)
- **MySQL Cluster:** An infinite loop in an internal logging function could cause trace logs to fill up with `UNKNOWN SIGNAL TYPE` error messages and thus grow to unreasonable sizes. (Bug#26720)
- **MySQL Cluster:** An invalid pointer was returned following a `FSCLOSECONF` signal when accessing the REDO logs during a node restart or system restart. (Bug#26515)
- **MySQL Cluster:** The management client command `node_id STATUS` displayed the message `Node node_id: not connected` when `node_id` was not the node ID of a data node.

#### Note

The `ALL STATUS` command in the cluster management client still displays status information for data nodes only. This is by design. See [Commands in the MySQL Cluster Management Client](#), for more information.

(Bug#21715)

- **MySQL Cluster:** When performing an upgrade or downgrade, no specific error information was made available when trying to upgrade data nodes or SQL nodes before upgrading management nodes. (Bug#21296)
- **MySQL Cluster:** Some values of `MaxNoOfTables` caused the error `JOB BUFFER CONGESTION` to occur. (Bug#19378)
- **Replication:** A multiple-row delayed insert with an auto-increment column could cause duplicate entries to be created on the slave in a replication environment. (Bug#26116, Bug#25507)
- **Replication:** Duplicating the usage of a user variable in a stored procedure or trigger would not be replicated correctly to the slave. (Bug#25167)

- **Replication:** `DROP TRIGGER` statements would not be filtered on the slave when using the `replication-wild-do-table` option. (Bug#24478)
- **Replication:** For `INSERT ... ON DUPLICATE KEY UPDATE` statements where some `AUTO_INCREMENT` values were generated automatically for inserts and some rows were updated, one auto-generated value was lost per updated row, leading to faster exhaustion of the range of the `AUTO_INCREMENT` column.  
  
Because the original problem can affect replication (different values on master and slave), it is recommended that the master and its slaves be upgraded to the current version. (Bug#24432)
- **Replication:** Replication between master and slave would infinitely retry binary log transmission where the `max_allowed_packet` on the master was larger than that on the slave if the size of the transfer was between these two values. (Bug#23775)
- **Replication:** Loading data using `LOAD DATA INFILE` may not replicate correctly (due to character set incompatibilities) if the `character_set_database` variable is set before the data is loaded. (Bug#15126)
- **Replication:** User defined variables used within stored procedures and triggers are not replicated correctly when operating in statement-based replication mode. (Bug#14914, Bug#20141)
- **Disk Data:** A memory overflow could occur with tables having a large amount of data stored on disk, or with queries using a very high degree of parallelism on Disk Data tables. (Bug#26514)
- **Disk Data:** Use of a tablespace whose `INITIAL_SIZE` was greater than 1 GB could cause the cluster to crash. (Bug#26487)
- **Disk Data:** Creating multiple Disk Data tables using different tablespaces could sometimes cause the cluster to fail. (Bug#25992)
- **Disk Data:** `ALTER TABLE ... ADD COLUMN ...` on a Disk Data table moved data for existing non-indexed columns from the tablespace into memory. (Bug#25880)
- **Disk Data:** `DROP INDEX` on a Disk Data table did not always move data from memory into the tablespace. (Bug#25877)
- **Disk Data:** When creating a log file group, setting `INITIAL_SIZE` to less than `UNDO_BUFFER_SIZE` caused data nodes to crash. (Bug#25743)
- **Cluster Replication:** The simultaneous failure of a data node and an SQL node could cause replication to fail. (Bug#27005)
- **Cluster API:** A delete operation using a scan followed by an insert using a scan could cause a data node to fail. (Bug#27203)
- **Cluster API:** (Cluster APIs): `NAND` and `NOR` operations with `NdbScanFilter` did not perform correctly. (Bug#24568)
- **Cluster API:** You can now use the `ndb_mgm_check_connection()` function to determine whether a management server is running. See `ndb_mgm_check_connection()`.
- **MyISAM** tables converted to `ARCHIVE` were excessively large. (Bug#27533)
- `SELECT ... INTO OUTFILE` with a long `FIELDS ENCLOSED BY` value could crash the server. (Bug#27231)
- An `INSERT ... ON DUPLICATE KEY UPDATE` statement might modify values in a table but not flush affected data from the query cache, causing subsequent selects to return stale results. This made the combination of query cache plus `ON DUPLICATE KEY UPDATE` very unreliable. (Bug#27210)

See also [Bug#27006](#), [Bug#27033](#).

This regression was introduced by [Bug#19978](#).

- For `INSERT ... ON DUPLICATE KEY UPDATE` statements on tables containing `AUTO_INCREMENT` columns, `LAST_INSERT_ID()` was reset to 0 if no rows were successfully inserted or changed. “Not changed” includes the case where a row was updated to its current values, but in that case, `LAST_INSERT_ID()` should not be reset to 0. Now `LAST_INSERT_ID()` is reset to 0 only if no rows were successfully inserted or touched, whether or not touched rows were changed. (Bug#27033)

See also [Bug#27210](#), [Bug#27006](#).

This regression was introduced by [Bug#19978](#).

- Invalid optimization of pushdown conditions for queries where an outer join was guaranteed to read only one row from the outer table led to results with too few rows. (Bug#26963)
- For `MERGE` tables defined on underlying tables that contained a short `VARCHAR` column (shorter than four characters), using

- `ALTER TABLE` on at least one but not all of the underlying tables caused the table definitions to be considered different from that of the `MERGE` table, even if the `ALTER TABLE` did not change the definition. (Bug#26881)
- Use of a subquery containing `GROUP BY` and `WITH ROLLUP` caused a server crash. (Bug#26830)
  - Setting `event_scheduler = 1` or `event_scheduler = ON` caused the server to crash if the server had been started with `--skip-grant-tables`. Starting the server with `--skip-grant-tables` now causes `event_scheduler` to be set to `DISABLED` automatically, overriding any other value that may have been set. (Bug#26807)
  - Added support for `--debugger=dbx` for `mysql-test-run.pl` and added support for `--debugger=devenv`, `--debugger=DevEnv`, and `--debugger=/path/to/devenv`. (Bug#26792)
  - A result set column formed by concatenation of string literals was incomplete when the column was produced by a subquery in the `FROM` clause. (Bug#26738)
  - SSL connections failed on Windows. (Bug#26678)
  - When using the result of `SEC_TO_TIME()` for time value greater than 24 hours in an `ORDER BY` clause, either directly or through a column alias, the rows were sorted incorrectly as strings. (Bug#26672)
  - Use of a subquery containing a `UNION` with an invalid `ORDER BY` clause caused a server crash. (Bug#26661)
  - In some error messages, inconsistent format specifiers were used for the translations in different languages. `comp_err` (the error message compiler) now checks for mismatches. (Bug#26571)
  - Views that used a scalar correlated subquery returned incorrect results. (Bug#26560)
  - `UNHEX()` `IS NULL` comparisons failed when `UNHEX()` returned `NULL`. (Bug#26537)
  - On 64-bit Windows, large timestamp values could be handled incorrectly. (Bug#26536)
  - `SHOW CREATE EVENT` failed to display the `STARTS` and `ENDS` clauses for an event defined with `STARTS NOW()`, `ENDS NOW()`, or both. (Bug#26429)
  - If the server was started with `--skip-grant-tables`, selecting from `INFORMATION_SCHEMA` tables causes a server crash. (Bug#26285)
  - For some values of the position argument, the `INSERT()` function could insert a NUL byte into the result. (Bug#26281)
  - For an `INSERT` statement that should fail due to a column with no default value not being assigned a value, the statement succeeded with no error if the column was assigned a value in an `ON DUPLICATE KEY UPDATE` clause, even if that clause was not used. (Bug#26261)
  - `INSERT DELAYED` statements inserted incorrect values into `BIT` columns. (Bug#26238)
  - A query of type `index_merge`, and with a `WHERE` clause having the form `WHERE indexed_column_1=value_1 OR indexed_column_2=value_2` on a partitioned table caused the server to crash. (Bug#26117)
  - `BENCHMARK()` did not work correctly for expressions that produced a `DECIMAL` result. (Bug#26093)
  - For `MEMORY` tables, extending the length of a `VARCHAR` column with `ALTER TABLE` might result in an unusable table. (Bug#26080)
  - The server could hang during binary log rotation. (Bug#26079)
  - `LOAD DATA INFILE` sent an okay to the client before writing the binary log and committing the changes to the table had finished, thus violating ACID requirements. (Bug#26050)
  - `X() IS NULL` and `Y() IS NULL` comparisons failed when `X()` and `Y()` returned `NULL`. (Bug#26038)
  - Indexes on `TEXT` columns were ignored when `ref` accesses were evaluated. (Bug#25971)
  - If a thread previously serviced a connection that was killed, excessive memory and CPU use by the thread occurred if it later serviced a connection that had to wait for a table lock. (Bug#25966)
  - `VIEW` restrictions were applied to `SELECT` statements after a `CREATE VIEW` statement failed, as though the `CREATE` had succeeded. (Bug#25897)
  - Several deficiencies in resolution of column names for `INSERT ... SELECT` statements were corrected. (Bug#25831)
  - Inserting `utf8` data into a `TEXT` column that used a single-byte character set could result in spurious warnings about truncated



data. ([Bug#25815](#))

- On Windows, debug builds of `mysqld` could fail with heap assertions. ([Bug#25765](#))
- In certain cases it could happen that deleting a row corrupted an `RTREE` index. This affected indexes on spatial columns. ([Bug#25673](#))
- Using `mysqlbinlog` on a binary log would crash if there were a large number of row-based events related to a single statement. ([Bug#25628](#))
- Expressions involving `SUM()`, when used in an `ORDER BY` clause, could lead to out-of-order results. ([Bug#25376](#))
- Use of a `GROUP BY` clause that referred to a stored function result together with `WITH ROLLUP` caused incorrect results. ([Bug#25373](#))
- A stored procedure that made use of cursors failed when the procedure was invoked from a stored function. ([Bug#25345](#))
- On Windows, the server exhibited a file-handle leak after reaching the limit on the number of open file descriptors. ([Bug#25222](#))
- The `REPEAT()` function did not allow a column name as the `count` parameter. ([Bug#25197](#))
- A reference to a non-existent column in the `ORDER BY` clause of an `UPDATE ... ORDER BY` statement could cause a server crash. ([Bug#25126](#))
- A view on a join is insertable for `INSERT` statements that store values into only one table of the join. However, inserts were being rejected if the inserted-into table was used in a self-join because MySQL incorrectly was considering the insert to modify multiple tables of the view. ([Bug#25122](#))
- Creating a table with latin characters in the name caused the output of `SHOW FULL TABLES` to have `ERROR` for the table type. ([Bug#25081](#))
- MySQL would not compile when configured using `--without-query-cache`. ([Bug#25075](#))
- It was not possible to use XPath keywords as tag names for expressions used in the `ExtractValue()` function. ([Bug#24747](#))
- Increasing the width of a `DECIMAL` column could cause column values to be changed. ([Bug#24558](#))
- `IF(expr, unsigned_expr, unsigned_expr)` was evaluated to a signed result, not unsigned. This has been corrected. The fix also affects constructs of the form `IS [NOT] {TRUE|FALSE}`, which were transformed internally into `IF()` expressions that evaluated to a signed result.

For existing views that were defined using `IS [NOT] {TRUE|FALSE}` constructs, there is a related implication. The definitions of such views were stored using the `IF()` expression, not the original construct. This is manifest in that `SHOW CREATE VIEW` shows the transformed `IF()` expression, not the original one. Existing views will evaluate correctly after the fix, but if you want `SHOW CREATE VIEW` to display the original construct, you must drop the view and re-create it using its original definition. New views will retain the construct in their definition. ([Bug#24532](#))

- `SHOW ENGINE MUTEX STATUS` failed to produce an `UNKNOWN TABLE ENGINE` error.  
See [Section 12.5.5.16, “SHOW ENGINE Syntax”](#). ([Bug#24392](#))
- A user-defined variable could be assigned an incorrect value if a temporary table was employed in obtaining the result of the query used to determine its value. ([Bug#24010](#))
- `mysqlimport` used a variable of the wrong type for the `--use-threads` option, which could cause a crash on some architectures. ([Bug#23814](#))
- Queries that used a temporary table for the outer query when evaluating a correlated subquery could return incorrect results. ([Bug#23800](#))
- On Windows, debug builds of `mysqlbinlog` could fail with a memory error. ([Bug#23736](#))
- When using certain server SQL modes, the `mysql.proc` table was not created by `mysql_install_db`. ([Bug#23669](#))
- `DOUBLE` values such as `20070202191048.000000` were being treated as illegal arguments by `WEEK()`. ([Bug#23616](#))
- The server could crash if two or more threads initiated query cache resize operation at moments very close in time. ([Bug#23527](#))

- `NOW()` returned the wrong value in statements executed at server startup with the `--init-file` option. (Bug#23240)
- Setting the `slow_query_log_file` system variable caused log output to go to the general log, not the slow query log. (Bug#23225)
- When nesting stored procedures within a trigger on a table, a false dependency error was thrown when one of the nested procedures contained a `DROP TABLE` statement. (Bug#22580)
- Instance Manager did not remove the angel PID file on a clean shutdown. (Bug#22511)
- `EXPLAIN EXTENDED` did not show `WHERE` conditions that were optimized away. (Bug#22331)
- `IN ((subquery))`, `IN (((subquery)))`, and so forth, are equivalent to `IN (subquery)`, which is always interpreted as a table subquery (so that it is allowed to return more than one row). MySQL was treating the “over-parenthesized” subquery as a single-row subquery and rejecting it if it returned more than one row. This bug primarily affected automatically generated code (such as queries generated by Hibernate), because humans rarely write the over-parenthesized forms. (Bug#21904)
- An `INSERT` trigger invoking a stored routine that inserted into a table other than the one on which the trigger was defined would fail with a `TABLE '...' DOESN'T EXIST` referring to the second table when attempting to delete records from the first table. (Bug#21825)
- `CURDATE()` is less than `NOW()`, either when comparing `CURDATE()` directly (`CURDATE() < NOW()` is true) or when casting `CURDATE()` to `DATE` (`CAST(CURDATE() AS DATE) < NOW()` is true). However, storing `CURDATE()` in a `DATE` column and comparing `col_name < NOW()` incorrectly yielded false. This is fixed by comparing a `DATE` column as `DATETIME` for comparisons to a `DATETIME` constant. (Bug#21103)
- When a stored routine attempted to execute a statement accessing a non-existent table, the error was not caught by the routine's exception handler. (Bug#20713, Bug#8407)
- For a stored procedure containing a `SELECT` statement that used a complicated join with an `ON` expression, the expression could be ignored during re-execution of the procedure, yielding an incorrect result. (Bug#20492)
- The conditions checked by the optimizer to allow use of indexes in `IN` predicate calculations were unnecessarily tight and were relaxed. (Bug#20420)
- When a `TIME_FORMAT()` expression was used as a column in a `GROUP BY` clause, the expression result was truncated. (Bug#20293)
- The creation of MySQL system tables was not checked for by `mysql-test-run.pl`. (Bug#20166)
- For index reads, the `BLACKHOLE` engine did not return end-of-file (which it must because `BLACKHOLE` tables contain no rows), causing some queries to crash. (Bug#19717)
- For `expr IN(value_list)`, the result could be incorrect if `BIGINT UNSIGNED` values were used for `expr` or in the value list. (Bug#19342)
- When attempting to call a stored procedure creating a table from a trigger on a table `tbl` in a database `db`, the trigger failed with `ERROR 1146 (42S02): TABLE 'db.tbl' DOESN'T EXIST`. However, the actual reason that such a trigger fails is due to the fact that `CREATE TABLE` causes an implicit `COMMIT`, and so a trigger cannot invoke a stored routine containing this statement. A trigger which does so now fails with `ERROR 1422 (HY000): EXPLICIT OR IMPLICIT COMMIT IS NOT ALLOWED IN STORED FUNCTION OR TRIGGER`, which makes clear the reason for the trigger's failure. (Bug#18914)
- While preparing prepared statements, the server acquired unnecessary table write locks. (Bug#18326)
- The update columns for `INSERT ... SELECT ... ON DUPLICATE KEY UPDATE` could be assigned incorrect values if a temporary table was used to evaluate the `SELECT`. (Bug#16630)
- For `SUBSTRING()` evaluation using a temporary table, when `SUBSTRING()` was used on a `LONGTEXT` column, the `max_length` metadata value of the result was incorrectly calculated and set to 0. Consequently, an empty string was returned instead of the correct result. (Bug#15757)
- Local variables in stored routines or triggers, when declared as the `BIT` type, were interpreted as strings. (Bug#12976)
- For some operations, system tables in the `mysql` database must be accessed. For example, the `HELP` statement requires the contents of the server-side help tables, and `CONVERT_TZ()` might need to read the time zone tables. However, to perform such operations while a `LOCK TABLES` statement is in effect, the server required you to also lock the requisite system tables explicitly or a lock error occurred:

```
mysql> LOCK TABLE t1 READ;
Query OK, 0 rows affected (0.02 sec)
mysql> HELP HELP;
```



```
ERROR 1100 (HY000) at line 4: Table 'help_topic' was not
locked with LOCK TABLES
```

Now, the server implicitly locks the system tables for reading as necessary so that you need not lock them explicitly. These tables are treated as just described:

```
mysql.help_category
mysql.help_keyword
mysql.help_relation
mysql.help_topic
mysql.proc
mysql.time_zone
mysql.time_zone_leap_second
mysql.time_zone_name
mysql.time_zone_transition
mysql.time_zone_transition_type
```

If you want to explicitly place a `WRITE` lock on any of those tables with a `LOCK TABLES` statement, the table must be the only one locked; no other table can be locked with the same statement. ([Bug#9953](#))

## C.2.22. Changes in MySQL 5.1.16 (26 February 2007)

This is a new Beta development release, fixing recently discovered bugs.

### Note

This Beta release, as any other pre-production release, should not be installed on *production* level systems or systems with critical data. It is good practice to back up your data before installing any new version of software. Although MySQL has worked very hard to ensure a high level of quality, protect your data by making a backup as you would for any software beta release. Please refer to our bug database at <http://bugs.mysql.com/> for more details about the individual bugs fixed in this version.

### Note

After release, a trigger failure problem was found to have been introduced. ([Bug#27006](#)) Users affected by this issue should upgrade to MySQL 5.1.17, which corrects the problem.

This section documents all changes and bug fixes that have been applied since the last official MySQL release. If you would like to receive more fine-grained and personalized *update alerts* about fixes that are relevant to the version and features you use, please consider subscribing to *MySQL Enterprise* (a commercial MySQL offering). For more details please see <http://www.mysql.com/products/enterprise>.

Functionality added or changed:

- **Cluster API: Incompatible Change:** The `AbortOption` type is now a member of the `NdbOperation` class; its values and behavior have also changed. `NdbTransaction::AbortOption` can no longer be used, and applications written against the NDB API may need to be rewritten and recompiled to accommodate these changes. For more information about this change, see [The NdbOperation::AbortOption Type](#).

This also affects the behavior of the `NdbTransaction::execute()` method, which now reports failure only if the transaction was actually aborted. See [NdbTransaction::execute\(\)](#), for more information.

- **MySQL Cluster:** Previously, when a data node failed more than 8 times in succession to start, this caused a forced shutdown of the cluster. Now, when a data node fails to start 7 consecutive times, the node will not start again until it is started with the `-initial` option, and a warning to this effect is written to the error log. ([Bug#25984](#))
- **MySQL Cluster:** In the event that all cluster management and API nodes are configured with `ArbitrationRank = 0`, `ndb_mgmd` now issues the following warning when starting: `CLUSTER CONFIGURATION WARNING: NEITHER MGM NOR API NODES ARE CONFIGURED WITH ARBITRATOR, MAY CAUSE COMPLETE CLUSTER SHUTDOWN IN CASE OF HOST FAILURE.` ([Bug#23546](#))
- **MySQL Cluster:** A number of new and more descriptive error messages covering transporter errors were added. ([Bug#22025](#))
- **MySQL Cluster:** A new configuration parameter `MemReportFrequency` allows for additional control of data node memory usage. Previously, only warnings at predetermined percentages of memory allocation were given; setting this parameter allows for that behavior to be overridden. For more information, see [Defining MySQL Cluster Data Nodes](#).
- **Cluster API:** A new `ndb_mgm_get_clusterlog_loglevel()` function was added to the MGM API.

For more information, see `ndb_mgm_get_clusterlog_loglevel()`.

- The `localhost` anonymous user account created during MySQL installation on Windows now has no global privileges. Formerly this account had all global privileges. For operations that require global privileges, the `root` account can be used instead. (Bug#24496)
- In the `INFORMATION_SCHEMA.REFERENTIAL_CONSTRAINTS` table, the `UNIQUE_CONSTRAINT_NAME` column incorrectly named the referenced table. Now it names the referenced constraint, and a new column, `REFERENCED_TABLE_NAME`, names the referenced table. (Bug#21713)
- `RAND()` now allows non-constant initializers (such as a column name) as its argument. In this case, the seed is initialized with the value for each invocation of `RAND()`. (One implication of this is that for equal argument values, `RAND()` will return the same value each time.) (Bug#6172)
- Added the `--auto-generate-sql-load-type` and `--auto-generate-sql-write-number` options for `mysqslap`.
- The bundled yaSSL library was upgraded to version 1.5.8.

## Bugs fixed:

- **Security Fix:** Using an `INFORMATION_SCHEMA` table with `ORDER BY` in a subquery could cause a server crash.  
We would like to thank Oren Isacson of Flowgate Security Consulting and Stefan Streichsbier of SEC Consult for informing us of this problem. (Bug#24630, Bug#26556, CVE-2007-1420)
- **Partitioning: MySQL Cluster:** A query with an `IN` clause against an `NDB` table employing explicit user-defined partitioning did not always return all matching rows. (Bug#25821)
- **MySQL Cluster: Replication:** (Replication): Under some circumstances, the binary log thread could shut down while the slave SQL thread was still using it. (Bug#26015, Bug#26019)
- **MySQL Cluster: Replication:** (Replication): The error message `LAST_ERRNO: 4294967295, ERROR IN WRITE_ROWS EVENT` now supplies a valid error code. (Bug#19896)
- **MySQL Cluster:** An inadvertent use of unaligned data caused `ndb_restore` to fail on some 64-bit platforms, including Sparc and Itanium-2. (Bug#26739)
- **MySQL Cluster:** The `InvalidUndoBufferSize` error used the same error code (763) as the `IncompatibleVersions` error. `InvalidUndoBufferSize` now uses its own error code (779). (Bug#26490)
- **MySQL Cluster:** The failure of a data node when restarting it with `--initial` could lead to failures of subsequent data node restarts. (Bug#26481)
- **MySQL Cluster:** Takeover for local checkpointing due to multiple failures of master nodes was sometimes incorrectly handled. (Bug#26457)
- **MySQL Cluster:** The `LockPagesInMainMemory` parameter was not read until after distributed communication had already started between cluster nodes. When the value of this parameter was 1, this could sometimes result in data node failure due to missed heartbeats. (Bug#26454)
- **MySQL Cluster:** Under some circumstances, following the restart of a management node, all data nodes would connect to it normally, but some of them subsequently failed to log any events to the management node. (Bug#26293)
- **MySQL Cluster:** Condition pushdown did not work with prepared statements. (Bug#26225)
- **MySQL Cluster:** A memory leak could cause problems during a node or cluster shutdown or failure. (Bug#25997)
- **MySQL Cluster:** No appropriate error message was provided when there was insufficient REDO log file space for the cluster to start. (Bug#25801)
- **MySQL Cluster:** An `UPDATE` using an `IN` clause on an `NDB` table on which there was a trigger caused `mysqld` to crash. (Bug#25522)
- **MySQL Cluster:** A memory allocation failure in `SUMA` (the cluster Subscription Manager) could cause the cluster to crash. (Bug#25239)
- **MySQL Cluster:** The `ndb_size.tmp1` file (necessary for using the `ndb_size.pl` script) was missing from binary distributions. (Bug#24191)
- **MySQL Cluster:** The message `ERROR 0 IN READAUTOINCREMENTVALUE(): NO ERROR` was written to the error log whenever

er `SHOW TABLE STATUS` was performed on a Cluster table that did not have an `AUTO_INCREMENT` column.

### Note

This improves on and supersedes an earlier fix that was made for this issue in MySQL 5.1.12.

([Bug#21033](#))

- **MySQL Cluster:** When a node failed due to there being insufficient disk space to perform a local checkpoint, there was no indication that this was the source of the problem. Such a condition now produces an appropriate error message. ([Bug#20121](#))
- **MySQL Cluster:** In the event that cluster backup parameters such as `BackupWriteSize` were incorrectly set, no appropriate error was issued to indicate that this was the case. ([Bug#19146](#))
- **Replication:** If a slave server closed its relay log (for example, due to an error during log rotation), the I/O thread did not recognize this and still tried to write to the log, causing a server crash. ([Bug#10798](#))
- **Cluster API: Disk Data:** A delete and a read performed in the same operation could cause one or more data nodes to crash. This could occur when the operation affected more than 5 columns concurrently, or when one or more of the columns was of the `VARCHAR` type and was stored on disk. ([Bug#25794](#))
- **Cluster API:** After defining a delete operation (using `NdbOperation::deleteTuple()`) on a non-existent primary key of a table having a `BLOB` or `TEXT` column, invoking `NdbTransaction::execute()` caused the calling application to enter an endless loop rather than raising an error.

This issue also affected `ndb_restore`; when restoring tables containing `BLOB` or `TEXT` columns, this could cause it to consume all available memory and then crash. ([Bug#24028](#))

See also [Bug#27308](#), [Bug#30177](#).

- **Cluster API:** `libndbclient.so` was not versioned. ([Bug#13522](#))
- Using `ORDER BY` or `GROUP BY` could yield different results when selecting from a view and selecting from the underlying table. ([Bug#26209](#))
- `DISTINCT` queries that were executed using a loose scan for an `InnoDB` table that had been emptied caused a server crash. ([Bug#26159](#))
- A `WHERE` clause that used `BETWEEN` for `DATETIME` values could be treated differently for a `SELECT` and a view defined as that `SELECT`. ([Bug#26124](#))
- Collation for `LEFT JOIN` comparisons could be evaluated incorrectly, leading to improper query results. ([Bug#26017](#))
- The `WITH CHECK OPTION` clause for views was ignored for updates of multiple-table views when the updates could not be performed on fly and the rows to update had to be put into temporary tables first. ([Bug#25931](#))
- `LOAD DATA INFILE` did not work with pipes. ([Bug#25807](#))
- The `SEC_TO_TIME()` and `QUARTER()` functions sometimes did not handle `NULL` values correctly. ([Bug#25643](#))
- View definitions that used the `!` operator were treated as containing the `NOT` operator, which has a different precedence and can produce different results. ([Bug#25580](#))
- An error in the name resolution of nested `JOIN ... USING` constructs was corrected. ([Bug#25575](#))
- `GROUP BY` and `DISTINCT` did not group `NULL` values for columns that have a `UNIQUE` index. ([Bug#25551](#))
- The `--with-readline` option for `configure` did not work for commercial source packages, but no error message was printed to that effect. Now a message is printed. ([Bug#25530](#))
- A yaSSL program named `test` was installed, causing conflicts with the `test` system utility. It is no longer installed. ([Bug#25417](#))
- For a `UNIQUE` index containing many `NULL` values, the optimizer would prefer the index for `col IS NULL` conditions over other more selective indexes. ([Bug#25407](#))
- An `AFTER UPDATE` trigger on an `InnoDB` table with a composite primary key caused the server to crash. ([Bug#25398](#))
- Passing a `NULL` value to a user-defined function from within a stored procedure crashes the server. ([Bug#25382](#))
- `perror` crashed on some platforms due to failure to handle a `NULL` pointer. ([Bug#25344](#))

- `mysql.server stop` timed out too quickly (35 seconds) waiting for the server to exit. Now it waits up to 15 minutes, to ensure that the server exits. (Bug#25341)
- A query that contained an `EXIST` subquery with a `UNION` over correlated and uncorrelated `SELECT` queries could cause the server to crash. (Bug#25219)
- `mysql_kill()` caused a server crash when used on an SSL connection. (Bug#25203)
- `yaSSL` was sensitive to the presence of whitespace at the ends of lines in PEM-encoded certificates, causing a server crash. (Bug#25189)
- A query with `ORDER BY` and `GROUP BY` clauses where the `ORDER BY` clause had more elements than the `GROUP BY` clause caused a memory overrun leading to a crash of the server. (Bug#25172)
- Use of `ON DUPLICATE KEY UPDATE` defeated the usual restriction against inserting into a join-based view unless only one of the underlying tables is used. (Bug#25123)
- `ALTER TABLE ... ENABLE KEYS` acquired a global lock, preventing concurrent execution of other statements that use tables. (Bug#25044)
- `OPTIMIZE TABLE` caused a race condition in the I/O cache. (Bug#25042)
- A return value of `-1` from user-defined handlers was not handled well and could result in conflicts with server code. (Bug#24987)
- Certain joins using `Range checked for each record` in the query execution plan could cause the server to crash. (Bug#24776)
- `ALTER TABLE` caused loss of `CASCADE` clauses for `InnoDB` tables. (Bug#24741)
- If an `ORDER BY` or `GROUP BY` list included a constant expression being optimized away and, at the same time, containing single-row subselects that returned more than one row, no error was reported. If a query required sorting by expressions containing single-row subselects that returned more than one row, execution of the query could cause a server crash. (Bug#24653)
- For `ALTER TABLE`, using `ORDER BY expression` could cause a server crash. Now the `ORDER BY` clause allows only column names to be specified as sort criteria (which was the only documented syntax, anyway). (Bug#24562)
- Within stored routines or prepared statements, inconsistent results occurred with multiple use of `INSERT ... SELECT ... ON DUPLICATE KEY UPDATE` when the `ON DUPLICATE KEY UPDATE` clause erroneously tried to assign a value to a column mentioned only in its `SELECT` part. (Bug#24491)
- Expressions of the form `(a, b) IN (SELECT a, MIN(b) FROM t GROUP BY a)` could produce incorrect results when column `a` of table `t` contained `NULL` values while column `b` did not. (Bug#24420)
- If a prepared statement accessed a view, access to the tables listed in the query after that view was checked in the security context of the view. (Bug#24404)
- A nested query on a partitioned table returned fewer records than on the corresponding non-partitioned table, when the subquery affected more than one partition. (Bug#24186)
- Expressions of the form `(a, b) IN (SELECT c, d ...)` could produce incorrect results if `a`, `b`, or both were `NULL`. (Bug#24127)
- Queries that evaluate `NULL IN (SELECT ... UNION SELECT ...)` could produce an incorrect result (`FALSE` instead of `NULL`). (Bug#24085)
- Some `UPDATE` statements were slower than in previous versions when the search key could not be converted to a valid value for the type of the search column. (Bug#24035)
- `ISNULL( DATE(NULL) )` and `ISNULL( CAST(NULL AS DATE) )` erroneously returned false. (Bug#23938)
- Within a stored routine, accessing a declared routine variable with `PROCEDURE ANALYSE()` caused a server crash. (Bug#23782)
- For an `InnoDB` table with any `ON DELETE` trigger, `TRUNCATE TABLE` mapped to `DELETE` and activated triggers. Now a fast truncation occurs and triggers are not activated. .

**Important**

As a result of this fix, `TRUNCATE TABLE` now requires the `DROP` privilege rather than the `DELETE` privilege.

(Bug#23556)

- With `ONLY_FULL_GROUP_BY` enables, the server was too strict: Some expressions involving only aggregate values were rejected as non-aggregate (for example, `MAX(a) - MIN(a)`). (Bug#23417)
- The arguments to the `ENCODE()` and the `DECODE()` functions were not printed correctly, causing problems in the output of `EXPLAIN EXTENDED` and in view definitions. (Bug#23409)
- Some queries against `INFORMATION_SCHEMA` that used subqueries failed. . (Bug#23299)
- `readline` detection did not work correctly on NetBSD. (Bug#23293)
- The number of `setsockopt()` calls performed for reads and writes to the network socket was reduced to decrease system call overhead. (Bug#22943)
- Storing values specified as hexadecimal values 64 or more bits long in `BIT(64)`, `BIGINT`, or `BIGINT UNSIGNED` columns did not raise any warning or error if the value was out of range. (Bug#22533)
- Type conversion errors during formation of index search conditions were not correctly checked, leading to incorrect query results. (Bug#22344)
- For the `IF()` and `COALESCE()` function and `CASE` expressions, large unsigned integer values could be mishandled and result in warnings. (Bug#22026)
- Inserting `DEFAULT` into a column with no default value could result in garbage in the column. Now the same result occurs as when inserting `NULL` into a `NOT NULL` column. (Bug#20691)
- Indexes disabled with `ALTER TABLE ... DISABLE KEYS` could in some cases be used by specifying `FORCE INDEX`. (Bug#20604)
- If a duplicate key value was present in the table, `INSERT ... ON DUPLICATE KEY UPDATE` reported a row count indicating that a record was updated, even when no record actually changed due to the old and new values being the same. Now it reports a row count of zero. (Bug#19978)

See also [Bug#27006](#), [Bug#27033](#), [Bug#27210](#).

- `ORDER BY` values of the `DOUBLE` or `DECIMAL` types could change the result returned by a query. (Bug#19690)
- The `readline` library wrote to uninitialized memory, causing `mysql` to crash. (Bug#19474)
- Use of already freed memory caused SSL connections to hang forever. (Bug#19209)
- The server might fail to use an appropriate index for `DELETE` when `ORDER BY`, `LIMIT`, and a non-restricting `WHERE` are present. (Bug#17711)
- The optimizer used a filesort rather than a `const` table read in some cases when the latter was possible. (Bug#16590)
- To enable installation of MySQL RPMs on Linux systems running RHEL 4 (which includes SE-Linux) additional information was provided to specify some actions that are allowed to the MySQL binaries. (Bug#12676)
- `CONNECTION` is no longer treated as a reserved word. (Bug#12204)
- The presence of `ORDER BY` in a view definition prevented the `MERGE` algorithm from being used to resolve the view even if nothing else in the definition required the `TEMPTABLE` algorithm. (Bug#12122)

## C.2.23. Changes in MySQL 5.1.15 (25 January 2007)

This is a new Beta development release, fixing recently discovered bugs.

### Note

This Beta release, as any other pre-production release, should not be installed on *production* level systems or systems with critical data. It is good practice to back up your data before installing any new version of software. Although MySQL has worked very hard to ensure a high level of quality, protect your data by making a backup as you would for any software beta release. Please refer to our bug database at <http://bugs.mysql.com/> for more details about the individual bugs fixed in this version.

This section documents all changes and bug fixes that have been applied since the last official MySQL release. If you would like to receive more fine-grained and personalized *update alerts* about fixes that are relevant to the version and features you use, please

consider subscribing to *MySQL Enterprise* (a commercial MySQL offering). For more details please see <http://www.mysql.com/products/enterprise>.

Functionality added or changed:

- **Incompatible Change: MySQL Cluster:** The `LockPagesInMainMemory` configuration parameter has changed its type and possible values. For more information, see [LockPagesInMainMemory](#).

### Important

The values `true` and `false` are no longer accepted for this parameter. If you were using this parameter and had it set to `false` in a previous release, you must change it to `0`. If you had this parameter set to `true`, you should instead use `1` to obtain the same behavior as previously, or `2` to take advantage of new functionality introduced with this release, as described in the section cited above.

([Bug#25686](#))

- **Incompatible Change:** `InnoDB` rolls back only the last statement on a transaction timeout. A new option, `-innodb_rollback_on_timeout`, causes `InnoDB` to abort and roll back the entire transaction if a transaction timeout occurs (the same behavior as in MySQL 5.0.13 and earlier). ([Bug#24200](#))
- **Incompatible Change:** Previously, the `DATE_FORMAT()` function returned a binary string. Now it returns a string with a character set and collation given by `character_set_connection` and `collation_connection` so that it can return month and weekday names containing non-ASCII characters. ([Bug#22646](#))
- **Incompatible Change:** The following conditions apply to enabling the `read_only` system variable:
  - If you attempt to enable `read_only` while you have any explicit locks (acquired with `LOCK TABLES` or have a pending transaction, an error will occur.
  - If other clients hold explicit table locks or have pending transactions, the attempt to enable `read_only` blocks until the locks are released and the transactions end. While the attempt to enable `read_only` is pending, requests by other clients for table locks or to begin transactions also block until `read_only` has been set.
  - `read_only` can be enabled while you hold a global read lock (acquired with `FLUSH TABLES WITH READ LOCK`) because that does not involve table locks.

Previously, the attempt to enable `read_only` would return immediately even if explicit locks or transactions were pending, so some data changes could occur for statements executing in the server at the same time. ([Bug#22009](#), [Bug#11733](#))

- **Incompatible Change:** Previously, the `ARCHIVE` storage engine created a metadata file with an extension of `.ARM` for each table. The engine no longer creates this file.
- **Important Change:** When using `MERGE` tables the definition of the `MERGE` table and the `MyISAM` tables are checked each time the tables are opened for access (including any `SELECT` or `INSERT` statement. Each table is compared for column order, types, sizes and associated. If there is a difference in any one of the tables then the statement will fail.
- **Important Change:** Previously, duplicate-key errors were indicated by the `ER_DUP_ENTRY` error code (1062). This code is no longer used. Instead, the server returns `ER_DUP_ENTRY_WITH_KEY_NAME` (1582), and the error message indicates the name of the index for which the duplicate occurred. Applications that test for duplicate keys should look for both error codes if they need to be compatible with current and older servers.

See also [Bug#28842](#).

- **MySQL Cluster:** The `NDB` storage engine could leak memory during file operations. ([Bug#21858](#))
- **Replication:** Calling a non-deterministic stored routine when using statement-based replication now throws an error. Formerly, defining such a stored routine would cause an error to be thrown. ([Bug#16456](#))
- On Unix, when searching the standard locations for option files, MySQL programs now also look for `/etc/mysql/my.cnf` after checking for `/etc/my.cnf` and before checking the remaining locations. ([Bug#25104](#))
- The default value of the `max_connections` variable has been increased to 151 in order that Websites running on Apache and using MySQL will not have more processes trying to access MySQL than the default number of connections available.

(The maximum number of Apache processes is determined by the Apache `MaxClient`, which defaults to 256, but is usually set to 150 in the `httpd.conf` commonly distributed with Apache. For more information about `MaxClient`, see [http://httpd.apache.org/docs/2.2/mod/mpm\\_common.html#maxclients](http://httpd.apache.org/docs/2.2/mod/mpm_common.html#maxclients).) ([Bug#23883](#))

- The `Com_create_user` status variable was added (for counting `CREATE USER` statements). ([Bug#22958](#))



- The `--memlock` option relies on system calls that are unreliable on some operating systems. If a crash occurs, the server now checks whether `--memlock` was specified and if so issues some information about possible workarounds. (Bug#22860)
- The (undocumented) `UNIQUE_USERS()` and `GROUP_UNIQUE_USERS()` functions were removed. (Bug#22687)
- Partitioning of tables using the `FEDERATED` storage engine is no longer permitted. Attempting to create such a table or to modify an existing table so that it uses both partitioning and `FEDERATED` now fails with an error. (Bug#22451)
- The `--skip-thread-priority` option now is enabled by default for binary Mac OS X distributions. Use of thread priorities degrades performance on Mac OS X. (Bug#18526)
- `read_only` can be enabled while you hold a global read lock (acquired with `FLUSH TABLES WITH READ LOCK`) because that does not involve table locks.
- The bundled yaSSL library was upgraded to version 1.5.0.
- Remote servers for use with the `FEDERATED` storage engine now can be managed with the new `CREATE/ALTER/DROP SERVER` syntax.
- Added the `--disable-grant-options` option to `configure`. If `configure` is run with this option, the `--bootstrap`, `--skip-grant-tables`, and `--init-file` options for `mysqld` are disabled and cannot be used. For Windows, the `configure.js` script recognizes the `DISABLE_GRANT_OPTIONS` flag, which has the same effect.
- If other clients hold explicit table locks or have pending transactions, the attempt to enable `read_only` blocks until the locks are released and the transactions end. While the attempt to enable `read_only` is pending, requests by other clients for table locks or to begin transactions also block until `read_only` has been set.
- If you attempt to enable `read_only` while you have any explicit locks (acquired with `LOCK TABLES` or have a pending transaction, an error will occur.

#### Bugs fixed:

- **Incompatible Change:** For `ENUM` columns that had enumeration values containing commas, the commas were mapped to `0xff` internally. However, this rendered the commas indistinguishable from true `0xff` characters in the values. This no longer occurs. However, the fix requires that you dump and reload any tables that have `ENUM` columns containing any true `0xff` values. Dump the tables using `mysqldump` with the current server before upgrading from a version of MySQL 5.1 older than 5.1.15 to version 5.1.15 or newer. (Bug#24660)
- **Partitioning: MySQL Cluster:** Non-32-bit, non-aligned columns were not handled correctly in explicitly partitioned `NDB` tables. (Bug#25587)
- **MySQL Cluster: Replication:** (Replication): Connecting a `mysqld` to a cluster where not all nodes were running, starting the remaining cluster nodes, and then disconnecting from the cluster caused the `mysqld` process to crash. (Bug#25387)
- **MySQL Cluster:** It was not possible to create an `NDB` table with a key on two `VARCHAR` columns where both columns had a storage length in excess of 256. (Bug#25746)
- **MySQL Cluster:** Hosts in clusters with large numbers of nodes could experience excessive CPU usage while obtaining configuration data. (Bug#25711)
- **MySQL Cluster:** In some circumstances, shutting down the cluster could cause connected `mysqld` processes to crash. (Bug#25668)
- **MySQL Cluster:** Some aggregate queries such as `SELECT COUNT(*)` performed a table scan on `NDB` tables rather than checking table statistics, causing such queries to perform much more slowly in MySQL Cluster 5.1 than in 5.0. (Bug#25567)
- **MySQL Cluster:** Memory allocations for `TEXT` columns were calculated incorrectly, resulting in space being wasted and other issues. (Bug#25562)
- **MySQL Cluster:** The failure of a master node during a node restart could lead to a resource leak, causing later node failures. (Bug#25554)
- **MySQL Cluster:** The failure of a node during a local checkpoint could lead to other node failures. (Bug#25468)
- **MySQL Cluster:** A node shutdown occurred if the master failed during a commit. (Bug#25364)
- **MySQL Cluster:** Creating a non-unique index with the `USING HASH` clause silently created an ordered index instead of issuing a warning. (Bug#24820)

- **MySQL Cluster:** `ndb_config` failed when trying to use 2 management servers and node IDs. (Bug#23887)
- **MySQL Cluster:** When a data node was shut down using the management client `STOP` command, a connection event (`NDB_LE_Connected`) was logged instead of a disconnection event (`NDB_LE_Disconnected`). (Bug#22773)
- **MySQL Cluster:** The management server did not handle logging of node shutdown events correctly in certain cases. (Bug#22013)
- **MySQL Cluster:** `SELECT` statements with a `BLOB` or `TEXT` column in the selected column list and a `WHERE` condition including a primary key lookup on a `VARCHAR` primary key produced empty result sets. (Bug#19956)
- **MySQL Cluster:** When stopping and restarting multiple data nodes, the last node to be restarted would sometimes hang in Phase 100. (Bug#19645)
- **Replication:** Using row-based replication to replicate to a table having at least one extra `BIT` column with a default value on the slave as compared to the master could cause the slave to fail. (Bug#24490)
- **Replication:** When `SET PASSWORD` was written to the binary log double quotes were included in the statement. If the slave was running in with the server SQL mode set to `ANSI_QUOTES`, then the event failed, which halted the replication process. (Bug#24158)
- **Replication:** A stored procedure, executed from a connection using a binary character set, and which wrote multibyte data, would write incorrectly escaped entries to the binary log. This caused syntax errors, and caused replication to fail. (Bug#23619, Bug#24492)
- **Replication:** Using `CREATE TABLE ... SELECT` and rolling back the transaction would leave an empty table on the master, but the instructions would not be recorded in the binary log and therefore replicated to the slave. This would result in a difference between the master and slave databases. An implicit commit has been added to ensure consistency. (Bug#22865)
- **Replication:** Changes to the `lc_time_names` system variable were not replicated. (Bug#22645)
- **Replication:** For `SET`, `SELECT`, and `DO` statements that invoked a stored function from a database other than the default database, the function invocation could fail to be replicated. (Bug#19725)
- **Disk Data:** Following 3 or more missed local checkpoints by a cluster node, a restart of the node caused incorrect undo information to be used for Disk Data tables. (Bug#25636)
- **Disk Data:** `MEDIUMTEXT` columns of Disk Data tables were stored in memory rather than on disk, even if the columns were not indexed. (Bug#25001)
- **Disk Data:** Performing a node restart with a newly dropped Disk Data table could lead to failure of the node during the restart. (Bug#24917)
- **Disk Data:** Changing a column specification or issuing a `TRUNCATE` statement on a Disk Data table caused the table to become an in-memory table. (Bug#24667, Bug#25296)
- **Disk Data:** When restoring from backup a cluster containing any Disk Data tables with hidden primary keys, a node failure resulted which could lead to a crash of the cluster. (Bug#24166)
- **Disk Data:** Repeated `CREATE`, `DROP`, or `TRUNCATE` in various combinations with system restarts between these operations could lead to the eventual failure of a system restart. (Bug#21948)
- **Disk Data:** Extents that should have been available for re-use following a `DROP TABLE` operation were not actually made available again until after the cluster had performed a local checkpoint. (Bug#17605)
- **Cluster Replication:** Certain errors in replication setups could lead to unexpected node failures. (Bug#25755)
- **Cluster Replication:** Connecting an API node to the cluster during a node restart while performing database operations could cause the restarting node to fail. (Bug#25329)
- **Cluster Replication:** Following a restart of the master cluster, the latest GCI was set to 0 upon reconnection to the slave. (Bug#21806)
- **Cluster API:** Deletion of an `Ndb_cluster_connection` object took a very long time. (Bug#25487)
- **Cluster API:** Invoking the `NdbTransaction::execute()` method using execution type `Commit` and abort option `AO_IgnoreError` could lead to a crash of the transaction coordinator (DBTC). (Bug#25090)
- **Cluster API:** A unique index lookup on a non-existent tuple could lead to a data node timeout (error 4012). (Bug#25059)
- **Cluster API:** When using the `NdbTransaction::execute()` method, a very long timeout (greater than 5 minutes) could



result if the last data node being polled was disconnected from the cluster. (Bug#24949)

- **Cluster API:** Due to an error in the computation of table fragment arrays, some transactions were not executed from the correct starting point. (Bug#24914)
- `mysqltest_embedded` crashed at startup. (Bug#25890)
- Referencing an ambiguous column alias in an expression in the `ORDER BY` clause of a query caused the server to crash. (Bug#25427)
- A number of issues were uncovered by Valgrind. (Bug#25396)
- Using a view in combination with a `USING` clause caused column aliases to be ignored. (Bug#25106)
- A multiple-table `DELETE QUICK` could sometimes cause one of the affected tables to become corrupted. (Bug#25048)
- An assertion failed incorrectly for prepared statements that contained a single-row uncorrelated subquery that was used as an argument of the `IS NULL` predicate. (Bug#25027)
- In the `INFORMATION_SCHEMA.KEY_COLUMN_USAGE` table, the value displayed for the `REFERENCED_TABLE_NAME` column was the table name as encoded for disk storage, not the actual table name. (Bug#25026)
- The `REPEAT()` function could return `NULL` when passed a column for the count argument. (Bug#24947)
- `mysql_upgrade` failed if the `--password` (or `-p`) option was given. (Bug#24896)
- Accessing a fixed record format table with a crashed key definition results in server/`myisamchk` segmentation fault. (Bug#24855)
- `mysqld_multi` and `mysqlaccess` looked for option files in `/etc` even if the `--sysconfdir` option for `configure` had been given to specify a different directory. (Bug#24780)
- If there was insufficient memory available to `mysqld`, this could sometimes cause the server to hang during startup. (Bug#24751)
- Optimizations that are legal only for subqueries without tables and `WHERE` conditions were applied for any subquery without tables. (Bug#24670)
- Under certain rare circumstances, local checkpoints were not performed properly, leading to an inability to restart one or more data nodes. (Bug#24664)
- A workaround was implemented to avoid a race condition in the NPTL `pthread_exit()` implementation. (Bug#24507)
- Under some circumstances, a `REORGANIZE PARTITION` statement could crash `mysqld`. (Bug#24502)
- `mysqltest` crashed with a stack overflow. (Bug#24498)
- Attempts to access a `MyISAM` table with a corrupt column definition caused a server crash. (Bug#24401)
- `ALTER ENABLE KEYS` or `ALTER TABLE DISABLE KEYS` combined with another `ALTER TABLE` option other than `RENAME TO` did nothing. In addition, if `ALTER TABLE` was used on a table having disabled keys, the keys of the resulting table were enabled. (Bug#24395)
- When opening a corrupted `.frm` file during a query, the server crashes. (Bug#24358)
- The `--extern` option for `mysql-test-run.pl` did not function correctly. (Bug#24354)
- Some joins in which one of the joined tables was a view could return erroneous results or crash the server. (Bug#24345)
- The `mysql.server` script used the `source` command, which is less portable than the `.` command; it now uses `.` instead. (Bug#24294)
- A view was not handled correctly if the `SELECT` part contained “\z”. (Bug#24293)
- `mysql_install_db` did not create the `mysql.plugin` table if strict SQL mode was enabled. (Bug#24270)
- A query using `WHERE unsigned_column NOT IN ('negative_value')` could cause the server to crash. (Bug#24261)
- `ALTER TABLE` statements that performed both `RENAME TO` and `{ENABLE|DISABLE} KEYS` operations caused a server crash. (Bug#24219)

- A `FETCH` statement using a cursor on a table which was not in the table cache could sometimes cause the server to crash. (Bug#24117)
- Hebrew-to-Unicode conversion failed for some characters. Definitions for the following Hebrew characters (as specified by the ISO/IEC 8859-8:1999) were added: LEFT-TO-RIGHT MARK (LRM), RIGHT-TO-LEFT MARK (RLM) (Bug#24037)
- On HP-UX, `mysqltest` (non-thread-safe) crashed due to being linked against a thread-safe `libmysys` library. (Bug#23984)
- The server was built even when `configure` was run with the `--without-server` option. (Bug#23973)  
See also Bug#32898.
- The MySQL 5.1.12 binaries for Windows were missing the `FEDERATED`, `EXAMPLE`, and `BLACKHOLE` storage engines. (Bug#23900)
- `ROW_COUNT()` did not work properly as an argument to a stored procedure. (Bug#23760)
- When reading from the standard input on Windows, `mysqlbinlog` opened the input in text mode rather than binary mode and consequently misinterpreted some characters such as Control-Z. (Bug#23735)
- `OPTIMIZE TABLE` tried to sort R-tree indexes such as spatial indexes, although this is not possible (see Section 12.5.2.5, “`OPTIMIZE TABLE Syntax`”). (Bug#23578)
- The row count for `MyISAM` tables was not updated properly, causing `SHOW TABLE STATUS` to report incorrect values. (Bug#23526)
- The Instance Manager `DROP INSTANCE` command did not work. (Bug#23476)
- User-defined variables could consume excess memory, leading to a crash caused by the exhaustion of resources available to the `MEMORY` storage engine, due to the fact that this engine is used by MySQL for variable storage and intermediate results of `GROUP BY` queries. Where `SET` had been used, such a condition could instead give rise to the misleading error message `YOU MAY ONLY USE CONSTANT EXPRESSIONS WITH SET`, rather than `OUT OF MEMORY (NEEDED NNNNNN BYTES)`. (Bug#23443)
- A table created with the `ROW_FORMAT = FIXED` table option lost the option if an index was added or dropped with `CREATE INDEX` or `DROP INDEX`. (Bug#23404)
- A deadlock could occur, with the server hanging on `Closing tables`, with a sufficient number of concurrent `INSERT DELAYED`, `FLUSH TABLES`, and `ALTER TABLE` operations. (Bug#23312)
- Accuracy was improved for comparisons between `DECIMAL` columns and numbers represented as strings. (Bug#23260)
- The Instance Manager `STOP INSTANCE` command took too much time and caused Instance Manager to be unresponsive. (Bug#23215)
- If there was insufficient memory to store or update a blob record in a `MyISAM` table then the table will marked as crashed. (Bug#23196)
- A compressed `MyISAM` table that became corrupted could crash `myisamchk` and possibly the MySQL Server. (Bug#23139)
- `CREATE TABLE ... SELECT` statements were not rolled back correctly. As part of the fix, such a statement now causes an implicit commit before and after it is executed. However, it does not cause a commit when used to create a temporary table. (Bug#22864)
- `mysql_upgrade` failed when called with a `--basedir` path name containing spaces. (Bug#22801)
- Using `INSTALL PLUGIN` followed by a restart of the server caused an error due to memory not being properly initialized. (Bug#22694)
- `SET lc_time_names = value` allowed only exact literal values, not expression values. (Bug#22647)
- A partitioned table that used the `DATA DIRECTORY` option, where the data directory was the same as the directory in which the table definition file resided, became corrupted following `ALTER TABLE ENGINE=ARCHIVE`. This was actually due to an issue with the `ARCHIVE` storage engine, and not with partitioned tables in general. (Bug#22634)
- The `STDDEV()` function returned a positive value for data sets consisting of a single value. (Bug#22555)
- `SHOW COLUMNS` reported some `NOT NULL` columns as `NULL`. (Bug#22377)
- A server crash occurred when using `LOAD DATA` to load a table containing a `NOT NULL` spatial column, when the statement did not load the spatial column. Now a `NULL supplied to NOT NULL column` error occurs. (Bug#22372)

- An `ALTER TABLE` statement that used a `RENAME` clause in combination with a `MODIFY` or `CHANGE` that did not actually change the table (for example, when it changed a column's type from `INT` to `INT`). The behavior caused by this bug differed according to whether or not the storage engine used by the table was transactional or non-transactional. For transactional tables (such as those using the `InnoDB` storage engine), the statement simply failed; for non-transactional tables (such as those using the `MyISAM` storage engine), the `ALTER TABLE` statement succeeding renaming the table, but subsequent `SELECT` statements against the renamed table would fail. ([Bug#22369](#))
- The Instance Manager `STOP INSTANCE` command could not be applied to instances in the `Crashed`, `Failed`, or `Abandoned` state. ([Bug#22306](#))
- `DATE_ADD()` requires complete dates with no “zero” parts, but sometimes did not return `NULL` when given such a date. ([Bug#22229](#))
- Some small double precision numbers (such as `1.00000001e-300`) that should have been accepted were truncated to zero. ([Bug#22129](#))
- Changing the value of `MI_KEY_BLOCK_LENGTH` in `myisam.h` and recompiling MySQL resulted in a `myisamchk` that saw existing `MyISAM` tables as corrupt. ([Bug#22119](#))
- For a non-existent table, `DROP TEMPORARY TABLE` failed with an incorrect error message if `read_only` was enabled. ([Bug#22077](#))
- A crash of the MySQL Server could occur when unpacking a `BLOB` column from a row in a corrupted `MyISAM` table. This could happen when trying to repair a table using either `REPAIR TABLE` or `myisamchk`; it could also happen when trying to access such a “broken” row using statements like `SELECT` if the table was not marked as crashed. ([Bug#22053](#))
- The code for generating `USE` statements for binary logging of `CREATE PROCEDURE` statements resulted in confusing output from `mysqlbinlog` for `DROP PROCEDURE` statements. ([Bug#22043](#))
- `STR_TO_DATE()` returned `NULL` if the format string contained a space following a non-format character. ([Bug#22029](#))
- It was possible to use `DATETIME` values whose year, month, and day parts were all zeroes but whose hour, minute, and second parts contained nonzero values, an example of such an illegal `DATETIME` being `'0000-00-00 11:23:45'`.

**Note**

This fix was reverted in MySQL 5.1.18.

([Bug#21789](#))

See also [Bug#25301](#).

- SSL connections could hang at connection shutdown. ([Bug#21781](#), [Bug#24148](#))
- `yaSSL` crashed on pre-Pentium Intel CPUs. ([Bug#21765](#))
- Using `FLUSH TABLES` in one connection while another connection is using `HANDLER` statements caused a server crash.

**Note**

This fix was reverted in MySQL 5.1.22

([Bug#21587](#))

See also [Bug#29474](#).

- The `FEDERATED` storage engine did not support the `euckr` character set. ([Bug#21556](#))
- `InnoDB` crashed while performing XA recovery of prepared transactions. ([Bug#21468](#))
- It was possible to set the backslash character (“\”) as the delimiter character using `DELIMITER`, but not actually possible to use it as the delimiter. ([Bug#21412](#))
- Using `ALTER TABLE` to convert a `CSV` table containing `NULL` values to `MyISAM` resulted in warnings. ([Bug#21328](#))
- When updating a table that used a `JOIN` of the table itself (for example, when building trees) and the table was modified on one side of the expression, the table would either be reported as crashed or the wrong rows in the table would be updated. ([Bug#21310](#))
- `mysqld_error.h` was not installed when only the client libraries were built. ([Bug#21265](#))

- **InnoDB**: During a restart of the MySQL Server that followed the creation of a temporary table using the **InnoDB** storage engine, MySQL failed to clean up in such a way that **InnoDB** still attempted to find the files associated with such tables. (Bug#20867)
- Selecting into variables sometimes returned incorrect wrong results. (Bug#20836)
- Queries of the form `SELECT ... WHERE string = ANY(...)` failed when the server used a single-byte character set and the client used a multi-byte character set. (Bug#20835)  
  
See also Bug#34760.
- `mysql_fix_privilege_tables.sql` altered the `table_privs.table_priv` column to contain too few privileges, causing loss of the `CREATE VIEW` and `SHOW VIEW` privileges. (Bug#20589)
- A stored routine containing semicolon in its body could not be reloaded from a dump of a binary log. (Bug#20396)
- `SELECT ... FOR UPDATE`, `SELECT ... LOCK IN SHARE MODE`, `DELETE`, and `UPDATE` statements executed using a full table scan were not releasing locks on rows that did not satisfy the `WHERE` condition. (Bug#20390)
- The `BUILD/check-cpu` script did not recognize Celeron processors. (Bug#20061)
- Unsigned `BIGINT` values treated as signed values by the `MOD()` function. (Bug#19955)
- Compiling PHP 5.1 with the MySQL static libraries failed on some versions of Linux. (Bug#19817)
- The `DELIMITER` statement did not work correctly when used in an SQL file run using the `SOURCE` statement. (Bug#19799)
- `mysqltest` incorrectly tried to retrieve result sets for some queries where no result set was available. (Bug#19410)
- `VARBINARY` column values inserted on a MySQL 4.1 server had trailing zeroes following upgrade to MySQL 5.0 or later. (Bug#19371)
- Some `CASE` statements inside stored routines could lead to excessive resource usage or a crash of the server. (Bug#19194, Bug#24854)
- Instance Manager could crash during shutdown. (Bug#19044)
- `myisampack` wrote to unallocated memory, causing a crash. (Bug#17951)
- `FLUSH LOGS` or `mysqladmin flush-logs` caused a server crash if the binary log was not open. (Bug#17733)
- `mysql_fix_privilege_tables` did not accept a password containing embedded space or apostrophe characters. (Bug#17700)
- No warning was issued for use of the `DATA DIRECTORY` or `INDEX DIRECTORY` table options on a platform that does not support them. (Bug#17498)
- The `FEDERATED` storage engine did not support the `utf8` character set. (Bug#17044)
- The optimizer removes expressions from `GROUP BY` and `DISTINCT` clauses if they happen to participate in `expression = constant` predicates of the `WHERE` clause, the idea being that, if the expression is equal to a constant, then it cannot take on multiple values. However, for predicates where the expression and the constant item are of different result types (for example, when a string column is compared to 0), this is not valid, and can lead to invalid results in such cases. The optimizer now performs an additional check of the result types of the expression and the constant; if their types differ, then the expression is not removed from the `GROUP BY` list. (Bug#15881)
- When a prepared statement failed during the prepare operation, the error code was not cleared when it was reused, even if the subsequent use was successful. (Bug#15518)
- Dropping a user-defined function sometimes did not remove the UDF entry from the `mysql.proc` table. (Bug#15439)
- Inserting a row into a table without specifying a value for a `BINARY(N) NOT NULL` column caused the column to be set to spaces, not zeroes. (Bug#14171)
- On Windows, the `SLEEP()` function could sleep too long, especially after a change to the system clock. (Bug#14094, Bug#24686, Bug#17635)
- `mysqldump --order-by-primary` failed if the primary key name was an identifier that required quoting. (Bug#13926)
- Subqueries of the form `NULL IN (SELECT ...)` returned invalid results. (Bug#8804, Bug#23485)

## C.2.24. Changes in MySQL 5.1.14 (05 December 2006)

This is a new Beta development release, fixing recently discovered bugs.

### Note

This Beta release, as any other pre-production release, should not be installed on *production* level systems or systems with critical data. It is good practice to back up your data before installing any new version of software. Although MySQL has worked very hard to ensure a high level of quality, protect your data by making a backup as you would for any software beta release. Please refer to our bug database at <http://bugs.mysql.com/> for more details about the individual bugs fixed in this version.

This section documents all changes and bug fixes that have been applied since the last official MySQL release. If you would like to receive more fine-grained and personalized *update alerts* about fixes that are relevant to the version and features you use, please consider subscribing to *MySQL Enterprise* (a commercial MySQL offering). For more details please see <http://www.mysql.com/products/enterprise>.

Functionality added or changed:

- **Cluster Replication: Incompatible Change:** Two major changes have taken place with regard to the MySQL Cluster system tables. These are:
  1. The `cluster` database is no longer used. The tables formerly found in the `cluster` database are now in the `mysql` database, and have been renamed as `ndb_binlog_index`, `ndb_apply_status`, and `ndb_schema`.
  2. The `mysql.ndb_apply_status` and `mysql.ndb_schema` tables (formerly `cluster.apply_status` and `cluster.schema`) are now created by `ndb_restore`, in the event that they do not already exist on the slave cluster.

### Note

When upgrading from versions of MySQL previous to 5.1.14 to 5.1.14 or later, `mysql_fix_privilege_tables` merely creates a new `mysql.ndb_binlog_index` table, but does not remove the existing `cluster` database (or, if upgrading from MySQL 5.1.7 or earlier, the existing `cluster_replication` database), nor any of the tables in it.

For more information, see [MySQL Cluster Replication Schema and Tables](#). (Bug#14612)

- **Cluster Replication: Incompatible Change:** The `cluster` database is no longer used. The tables formerly found in the `cluster` database are now in the `mysql` database, and have been renamed as `ndb_binlog_index`, `ndb_apply_status`, and `ndb_schema`.
- **Incompatible Change:** The `prepared_stmt_count` system variable has been converted to the `Prepared_stmt_count` global status variable (viewable with the `SHOW GLOBAL STATUS` statement). (Bug#23159)
- **Incompatible Change:** Previously, you could create a user-defined function (UDF) or stored function with the same name as a built-in function, but could not invoke the UDF. Now an error occurs if you try to create such a UDF. The server also now generates a warning if you create a stored function with the same name as a built-in function. It is not considered an error to create a stored function with the same name as a built-in function because you can invoke the function using `db_name.func_name()` syntax. However, the server now generates a warning in this case.

See [Section 8.2.4, “Function Name Parsing and Resolution”](#), for the rules describing how the server interprets references to different kinds of functions. (Bug#22619, Bug#18239)

- **MySQL Cluster:** Backup messages are now printed to the Cluster log. (Bug#24544)
- **MySQL Cluster:** Setting the configuration parameter `LockPagesInMainMemory` had no effect. (Bug#24461)
- **MySQL Cluster:** The error message `MANAGEMENT SERVER CLOSED CONNECTION`, when recorded in the MySQL error log, now includes a timestamp indicating when the error took place. (Bug#21519)
- **MySQL Cluster:** It is now possible to create a unique hashed index on a column that is not defined as `NOT NULL`.

### Note

This change applies only to tables using the `NDB` storage engine.

Unique indexes on columns in `NDB` tables do not store null values because they are mapped to primary keys in an internal index table (and primary keys cannot contain nulls).

Normally, an additional ordered index is created when one creates unique indexes on `NDB` table columns; this can be used to search for `NULL` values. However, if `USING HASH` is specified when such an index is created, no ordered index is created.

The reason for permitting unique hash indexes with null values is that, in some cases, the user wants to save space if a large number of records are pre-allocated but not fully initialized. This also assumes that the user will *not* try to search for null values. Since MySQL does not support indexes that are not allowed to be searched in some cases, the `NDB` storage engine uses a full table scan with pushed conditions for the referenced index columns to return the correct result.

A warning is returned if one creates a unique nullable hash index, since the query optimizer should be provided a hint not to use it with `NULL` values if this can be avoided. ([Bug#21507](#))

- **MySQL Cluster:** (Disk Data): The output of `mysqldump` now includes by default all tablespace and logfile group definitions used by any tables or databases that are dumped.

### Note

The working of the `--all-tablespaces` or `-Y` option for `mysqldump` remains unaffected by this change.

([Bug#20839](#))

- `DROP TRIGGER` now supports an `IF EXISTS` clause. ([Bug#23703](#))
- Direct and indirect usage of stored routines, user-defined functions, and table references is now prohibited in `CREATE EVENT` and `ALTER EVENT` statements.

See [Section 12.1.11, “CREATE EVENT Syntax”](#), and [Section 12.1.2, “ALTER EVENT Syntax”](#), for more specific information. ([Bug#22830](#))

- The XPath operators `<` and `>`, as implemented in the `ExtractValue()` function, operated in reverse.

With this fix, all standard XPath comparison operators should now be supported correctly for use with the `ExtractValue()` and `UpdateXML()` functions. ([Bug#22823](#))

- For the `mysql` client, display of result set metadata now is enabled with the `--column-type-info` option rather than with `--debug-info/-T`.
- `mysqladmin`, `mysqlcheck`, `mysqldump`, `mysqlimport`, and `mysqlshow` now accept the `--debug-info` option, which displays debugging information and memory and CPU usage statistics at program exit.

### Bugs fixed:

- **MySQL Cluster: Replication:** (Replication): If errors occurred during purging of the binary logs, extraneous rows could remain left in the `binlog_index` table. ([Bug#15021](#))
- **MySQL Cluster:** The failure of a data node failure during a schema operation could lead to additional node failures. ([Bug#24752](#))
- **MySQL Cluster:** A committed read could be attempted before a data node had time to connect, causing a timeout error. ([Bug#24717](#))
- **MySQL Cluster:** The simultaneous shutdown of `mysqld` and `ndbd` processes caused unnecessary locking. ([Bug#24655](#))
- **MySQL Cluster:** The failure of the master node in a node group during the allocation of node IDs could cause `ndb_mgmd` to hang. ([Bug#24543](#))
- **MySQL Cluster:** In certain rare cases, a data node could crash due to a typographical error in the MySQL Cluster source code. ([Bug#24476](#))
- **MySQL Cluster:** Creating a new tables containing a `BLOB` column when the server was short of memory could cause the server to crash. ([Bug#24470](#))
- **MySQL Cluster:** Sudden disconnection of an SQL or data node could lead to shutdown of data nodes with the error `FAILED NDBREQUIRE`. ([Bug#24447](#))
- **MySQL Cluster:** Any statement following the execution of `CREATE TABLE ... LIKE ndb_table` (where `ndb_table` was a table using the `NDB` storage engine), would cause the `mysql` client to hang. ([Bug#24301](#))
- **MySQL Cluster:** (Disk Data): Excessive fragmentation of Disk Data files (including log files and data files) could occur dur-



ing the course of normal use. (Bug#24143)

- **MySQL Cluster:** When the management client command `ALL RESTART -i` was executed while one data node was not running, all data nodes in the cluster were shut down. (Bug#24105)
- **MySQL Cluster:** A query using an index scan followed by a delete operation, and then a rollback could cause one or more data nodes to crash. (Bug#24039)
- **MySQL Cluster:** (Disk Data): Under some circumstances, a `DELETE` from a Disk Data table could cause `mysqld` to crash. (Bug#23542)
- **MySQL Cluster:** It was possible for the sum of the `MaxNoOfTables`, `MaxNoOfOrderedIndexes`, and `MaxNoOfUniqueHashIndexes` configuration parameters, plus the number of system tables to exceed the maximum value for a `UInt32` number. In such a case, the cluster's data nodes failed to start, and no reason for this could easily be determined from the error messages provided. (Bug#22548)
- **MySQL Cluster:** A value equal to or greater than the allowed maximum for `LongMessageBuffer` caused all data nodes to crash. (Bug#22547)
- **MySQL Cluster:** Multiple occurrences of error conditions were logged with duplicated error messages rather than being reported with a single error message stating that the error was encountered *N* times. (Bug#22313)
- **MySQL Cluster:** Given a table `mytbl` in a database `mydb` on a MySQL Server acting as an SQL node in a MySQL Cluster, then, following multiple `ALTER TABLE mytbl ENGINE=engine` statements — first, to change the storage engine used for a table to `NDB`, and then again to change the table to use a non-`NDB` storage engine — a `DROP DATABASE mydb` statement executed on any SQL node in the cluster would cause `mydb` to be dropped on *all* SQL nodes in the cluster, even if `mydb` contained non-`NDB` tables. (Bug#21495)
- **MySQL Cluster:** An incorrect error message was displayed in the event that the value of the `MaxNoOfOrderedIndexes` parameter was set too low. (Bug#20065)
- **MySQL Cluster:** An incorrect error message was displayed in the event that the value of the `DataMemory` parameter was insufficient for the amount of data to be stored by the cluster. (Bug#19808)
- **MySQL Cluster:** Some values of `MaxNoOfTriggers` could cause the server to become inaccessible following startup of the data nodes. (Bug#19454)
- **MySQL Cluster:** If the value set for `MaxNoOfAttributes` is excessive, a suitable error message is now returned. (Bug#19352)
- **MySQL Cluster:** Different error messages were returned for similar cases involving failure to allocate memory for Cluster operations. (Bug#19203)
- **MySQL Cluster:** A unique constraint violation was not ignored by an `UPDATE IGNORE` statement when the constraint violation occurred on a non-primary key. (Bug#18487, Bug#24303)
- **Replication:** With row-based binary logging, replicated multiple-statement transaction deadlocks did not return the correct error code, causing the slave SQL thread to stop rather than roll back and re-execute. (Bug#23831)
- **Replication:** Changes to character set variables prior to an action on a replication-ignored table were forgotten by slave servers. (Bug#22877)
- **Replication:** On slave servers, transactions that exceeded the lock wait timeout failed to roll back properly. (Bug#20697)
- **Replication:** SQL statements close to the size of `max_allowed_packet` could produce binary log events larger than `max_allowed_packet` that could not be read by slave servers. (Bug#19402)
- **Disk Data:** `ndb_restore` sometimes failed when attempting to restore Disk Data tables due to data node failure caused by accessing uninitialized memory. (Bug#24331)
- **Disk Data:** It was possible to execute a statement for creating a Disk Data table that referred to a non-existent tablespace, in which case the table created was actually an in-memory `NDB` table. Such a statement now fails instead, with an appropriate error message. (Bug#23576)
- **Cluster API:** Using `BIT` values with any of the comparison methods of the `NdbScanFilter` class caused data nodes to fail. (Bug#24503)
- **Cluster API:** Some MGM API function calls could yield incorrect return values in certain cases where the cluster was operating under a very high load, or experienced timeouts in inter-node communications. (Bug#24011)
- In some cases, a function that should be parsed as a user-defined function was parsed as a stored function. (Bug#24736)

- Some unnecessary Valgrind warnings were removed from the server. ([Bug#24488](#), [Bug#24533](#))
- The server source code had multiple exportable definitions of the `field_in_record_is_null()` function. These are now all declared `static`. ([Bug#24190](#))
- The loose index scan optimization for `GROUP BY` with `MIN` or `MAX` was not applied within other queries, such as `CREATE TABLE ... SELECT ...`, `INSERT ... SELECT ...`, or in the `FROM` clauses of subqueries. ([Bug#24156](#))
- Subqueries for which a pushed-down condition did not produce exactly one key field could cause a server crash. ([Bug#24056](#))
- The size of `MEMORY` tables and internal temporary tables was limited to 4GB on 64-bit Windows systems. ([Bug#24052](#))
- `LAST_DAY('0000-00-00')` could cause a server crash. ([Bug#23653](#))
- A trigger that invoked a stored function could cause a server crash when activated by different client connections. ([Bug#23651](#))
- The stack size for NetWare binaries was increased to 128KB to prevent problems caused by insufficient stack size. ([Bug#23504](#))
- If elements in a non-top-level `IN` subquery were accessed by an index and the subquery result set included a `NULL` value, the quantified predicate that contained the subquery was evaluated to `NULL` when it should return a non-`NULL` value. ([Bug#23478](#))
- When applying the `group_concat_max_len` limit, `GROUP_CONCAT()` could truncate multi-byte characters in the middle. ([Bug#23451](#))
- `mysql_affected_rows()` could return values different from `mysql_stmt_affected_rows()` for the same sequence of statements. ([Bug#23383](#))
- Calculation of `COUNT(DISTINCT)`, `AVG(DISTINCT)`, or `SUM(DISTINCT)` when they are referenced more than once in a single query with `GROUP BY` could cause a server crash. ([Bug#23184](#))
- With row-based binary logging, for `CREATE TABLE IF NOT EXISTS LIKE temporary_table` statements, the `IF NOT EXISTS` clause was not logged. ([Bug#22762](#))
- `BENCHMARK()`, `ENCODE()`, `DECODE()`, and `FORMAT()` could only accept a constant for some parameters, and could not be used in prepared statements. ([Bug#22684](#))
- Queries using a column alias in an expression as part of an `ORDER BY` clause failed, an example of such a query being `SELECT mycol + 1 AS mynum FROM mytable ORDER BY 30 - mynum`. ([Bug#22457](#))
- Using `EXPLAIN` caused a server crash for queries that selected from `INFORMATION_SCHEMA` in a subquery in the `FROM` clause. ([Bug#22413](#))
- Instance Manager option-parsing code caused memory-allocation errors. ([Bug#22242](#))
- Trailing spaces were not removed from Unicode `CHAR` column values when used in indexes. This resulted in excessive usage of storage space, and could affect the results of some `ORDER BY` queries that made use of such indexes.

**Note**

When upgrading, it is necessary to re-create any existing indexes on Unicode `CHAR` columns in order to take advantage of the fix. This can be done by using a `REPAIR TABLE` statement on each affected table.

([Bug#22052](#))

- With row-based binary logging, `CREATE TABLE IF NOT EXISTS SELECT` statements were not logged properly. ([Bug#22027](#))
- In some cases, the parser failed to distinguish a user-defined function from a stored function. ([Bug#21809](#))
- Inserting a default or invalid value into a spatial column could fail with `Unknown error` rather than a more appropriate error. ([Bug#21790](#))
- Evaluation of subqueries that require the filesort algorithm were allocating and freeing the `sort_buffer_size` buffer many times, resulting in slow performance. Now the buffer is allocated once and reused. ([Bug#21727](#))
- Through the C API, the member strings in `MYSQL_FIELD` for a query that contains expressions may return incorrect results. ([Bug#21635](#))
- View columns were always handled as having implicit derivation, leading to `illegal mix of collation errors` for some views in `UNION` operations. Now view column derivation comes from the original expression given in the view defini-



tion. (Bug#21505)

- `INET_ATON()` returned a signed `BIGINT` value, not an unsigned value. (Bug#21466)
- For debug builds, `mysqladmin shutdown` displayed an extraneous `skipped 9 bytes from file: socket (3)` message. (Bug#21428)
- For renaming of views, encoding of table name to file names was not performed. (Bug#21370)
- `CREATE FUNCTION X()` and `CREATE FUNCTION Y()` failed with a syntax error instead of warning the user that these function names are already used (for GIS functions). (Bug#21025)
- `CONCURRENT` did not work correctly for `LOAD DATA INFILE`. (Bug#20637)
- With `lower_case_table_names` set to 1, `SHOW CREATE TABLE` printed incorrect output for table names containing Turkish I (LATIN CAPITAL LETTER I WITH DOT ABOVE). (Bug#20404)
- A query with a subquery that references columns of a view from the outer `SELECT` could return an incorrect result if used from a prepared statement. (Bug#20327)
- For queries that select from a view, the server was returning `MYSQL_FIELD` metadata inconsistently for view names and table names. For view columns, the server now returns the view name in the `table` field and, if the column selects from an underlying table, the table name in the `org_table` field. (Bug#20191)
- Invalidating the query cache caused a server crash for `INSERT INTO ... SELECT` statements that selected from a view. (Bug#20045)
- For a cast of a `DATETIME` value containing microseconds to `DECIMAL`, the microseconds part was truncated without generating a warning. Now the microseconds part is preserved. (Bug#19491)
- The server could send incorrect column count information to the client for queries that produce a larger number of columns than can fit in a two-byte number. (Bug#19216)
- For some problems relating to character set conversion or incorrect string values for `INSERT` or `UPDATE`, the server was reporting truncation or length errors instead. (Bug#18908)
- Constant expressions and some numeric constants used as input parameters to user-defined functions were not treated as constants. (Bug#18761)
- Attempting to use a view containing `DEFINER` information for a non-existent user resulted in an error message that revealed the definer account. Now the definer is revealed only to superusers. Other users receive only an `access denied` message. (Bug#17254)
- `IN()` and `CHAR()` can return `NULL`, but did not signal that to the query processor, causing incorrect results for `IS NULL` operations. (Bug#17047)
- Warnings were generated when explicitly casting a character to a number (for example, `CAST('x' AS SIGNED)`), but not for implicit conversions in simple arithmetic operations (such as `'x' + 0`). Now warnings are generated in all cases. (Bug#11927)
- Metadata for columns calculated from scalar subqueries was limited to integer, double, or string, even if the actual type of the column was different. (Bug#11032)

## C.2.25. Changes in MySQL 5.1.13 (Not released)

This is a new Beta development release, fixing recently discovered bugs.

### Note

This Beta release, as any other pre-production release, should not be installed on *production* level systems or systems with critical data. It is good practice to back up your data before installing any new version of software. Although MySQL has worked very hard to ensure a high level of quality, protect your data by making a backup as you would for any software beta release. Please refer to our bug database at <http://bugs.mysql.com/> for more details about the individual bugs fixed in this version.

This section documents all changes and bug fixes that have been applied since the last official MySQL release. If you would like to receive more fine-grained and personalized *update alerts* about fixes that are relevant to the version and features you use, please consider subscribing to *MySQL Enterprise* (a commercial MySQL offering). For more details please see <http://www.mysql.com/products/enterprise>.

Functionality added or changed:

- **Incompatible Change:** The number of function names affected by `IGNORE_SPACE` was reduced significantly in MySQL 5.1.13, from about 200 to about 30. (For details about `IGNORE_SPACE`, see [Section 8.2.4, “Function Name Parsing and Resolution”](#).) This change improves the consistency of parser operation. However, it also introduces the possibility of incompatibility for old SQL code that relies on the following conditions:

- `IGNORE_SPACE` is disabled.
- The presence or absence of whitespace following a function name is used to distinguish between a built-in function and stored function that have the same name (for example, `PI()` versus `PI ()`).

For functions that are no longer affected by `IGNORE_SPACE` as of MySQL 5.1.13, that strategy no longer works. Either of the following approaches can be used if you have code that is subject to the preceding incompatibility:

- If a stored function has a name that conflicts with a built-in function, refer to the stored function with a schema name qualifier, regardless of whether whitespace is present. For example, write `schema_name.PI()` or `schema_name.PI ()`.
- Alternatively, rename the stored function to use a non-conflicting name and change invocations of the function to use the new name.

([Bug#21114](#))

- **Incompatible Change:** The `innodb_buffer_pool_awe_mem_mb` system variable has been removed and should no longer be used.
- **MySQL Cluster:** A change in the interfaces for the `INFORMATION_SCHEMA.FILES` table has made the table accessible to storage engines other than `NDB`. ([Bug#23013](#))
- Binary distributions of MySQL 5.1.12 were built without support for partitioning. This has been corrected except for NetWare. ([Bug#23949](#))
- If the user specified the server options `--max-connections=N` or `--table-open-cache=M`, a warning would be given in some cases that some values were recalculated, with the result that `--table-open-cache` could be assigned greater value.

In such cases, both the warning and the increase in the `--table-open-cache` value were completely harmless. Note also that it is not possible for the MySQL Server to predict or to control limitations on the maximum number of open files, since this is determined by the operating system.

The value of `--table-open-cache` is no longer increased automatically, and a warning is now given only if some values had to be decreased due to operating system limits. ([Bug#21915](#))

- For the `CALL` statement, stored procedures that take no arguments now can be invoked without parentheses. That is, `CALL p()` and `CALL p` are equivalent. ([Bug#21462](#))
- `mysql_upgrade` now passes all the parameters specified on the command line to both `mysqlcheck` and `mysql` using the `upgrade_defaults` file. ([Bug#20100](#))
- `mysqldump --single-transaction` now uses `START TRANSACTION /*!40100 WITH CONSISTENT SNAPSHOT */` rather than `BEGIN` to start a transaction, so that a consistent snapshot will be used on those servers that support it. ([Bug#19660](#))

Bugs fixed:

- **MySQL Cluster:** Backup of a cluster failed if there were any tables with 128 or more columns. ([Bug#23502](#))
- **MySQL Cluster:** Cluster backups failed when there were more than 2048 schema objects in the cluster. ([Bug#23499](#))
- **MySQL Cluster:** Restoring a cluster failed if there were any tables with 128 or more columns. ([Bug#23494](#))
- **MySQL Cluster:** The management client command `ALL DUMP 1000` would cause the cluster to crash if data nodes were connected to the cluster but not yet fully started. ([Bug#23203](#))
- **MySQL Cluster:** `INSERT ... ON DUPLICATE KEY UPDATE` on an `NDB` table could lead to deadlocks and memory leaks. ([Bug#23200](#))
- **MySQL Cluster:** An `NDB` source file included a `memset()` call with reversed arguments. ([Bug#23169](#))

- **MySQL Cluster:** If a node restart could not be performed from the REDO log, no node takeover took place. This could cause partitions to be left empty during a system restart. ([Bug#22893](#))
- **MySQL Cluster:** Multiple node restarts in rapid succession could cause a system restart to fail , or induce a race condition. ([Bug#22892](#), [Bug#23210](#))
- **MySQL Cluster:** Attempting to create a unique constraint with `USING HASH` on an `NDB` table caused `mysqld` to crash. ([Bug#21873](#))
- **MySQL Cluster:** When inserting a row into an `NDB` table with a duplicate value for a non-primary unique key, the error issued would reference the wrong key. ([Bug#21072](#))
- **MySQL Cluster:** Aborting a cluster backup too soon after starting it caused a forced shutdown of the data nodes. ([Bug#19148](#))
- **Replication:** Column names were not quoted properly for replicated views. ([Bug#19736](#))
- **Replication:** Transient errors in replication from master to slave may trigger multiple `Got fatal error 1236: 'bin-log truncated in the middle of event'` errors on the slave. ([Bug#4053](#))
- **Disk Data:** In the event of an aborted multiple update, the space in the Disk Data log buffer to be freed as a result was actually freed twice, which could eventually lead to a crash. ([Bug#23430](#))
- **Cluster API:** When multiple processes or threads in parallel performed the same ordered scan with exclusive lock and updated the retrieved records, the scan could skip some records, which as a result were not updated. ([Bug#20446](#))
- There was a race condition in the `InnoDB fil_flush_file_spaces()` function. ([Bug#24098](#))
- yaSSL-related memory leaks were detected by Valgrind. ([Bug#23981](#))
- MySQL 5.0.26 introduced an ABI incompatibility, which this release reverts. Programs compiled against 5.0.26 are not compatible with any other version and must be recompiled. ([Bug#23427](#))
- `M % 0` returns `NULL`, but `( M % 0 ) IS NULL` evaluated to false. ([Bug#23411](#))
- For not-yet-authenticated connections, the `Time` column in `SHOW PROCESSLIST` was a random value rather than `NULL`. ([Bug#23379](#))
- `InnoDB` crashed when trying to display an error message about a foreign key constraint violation when the two tables are in different schemas. ([Bug#23368](#))
- MySQL failed to build on Linux/Alpha. ([Bug#23256](#))  
This regression was introduced by [Bug#21250](#).
- If `COMPRESS()` returned `NULL`, subsequent invocations of `COMPRESS()` within a result set or within a trigger also returned `NULL`. ([Bug#23254](#))
- Insufficient memory (`myisam_sort_buffer_size`) could cause a server crash for several operations on `MyISAM` tables: repair table, create index by sort, repair by sort, parallel repair, bulk insert. ([Bug#23175](#))
- The column default value in the output from `SHOW COLUMNS` or `SELECT FROM INFORMATION_SCHEMA.COLUMNS` was truncated to 64 characters. ([Bug#23037](#))
- `mysql` did not check for errors when fetching data during result set printing. ([Bug#22913](#))
- The return value from `my_seek()` was ignored. ([Bug#22828](#))
- Use of `SQL_BIG_RESULT` did not influence the sort plan for query execution. ([Bug#22781](#))
- The optimizer failed to use equality propagation for `BETWEEN` and `IN` predicates with string arguments. ([Bug#22753](#))
- The `Handler_rollback` status variable sometimes was incremented when no rollback had taken place. ([Bug#22728](#))
- The `Host` column in `SHOW PROCESSLIST` output was blank when the server was started with the `--skip-grant-tables` option. ([Bug#22723](#))
- If a table contains an `AUTO_INCREMENT` column, inserting into an insertable view on the table that does not include the `AUTO_INCREMENT` column should not change the value of `LAST_INSERT_ID()`, because the side effects of inserting default values into columns not part of the view should not be visible. MySQL was incorrectly setting `LAST_INSERT_ID()` to zero. ([Bug#22584](#))

- The optimizer used the `ref` join type rather than `eq_ref` for a simple join on strings. (Bug#22367)
- Some queries that used `MAX()` and `GROUP BY` could incorrectly return an empty result. (Bug#22342)
- If an `init_connect` SQL statement produced an error, the connection was silently terminated with no error message. Now the server writes a warning to the error log. (Bug#22158)
- An unhandled `NULL` pointer caused a server crash. (Bug#22138)
- Incorrect warnings occurred for use of `CREATE TABLE ... LIKE` or `REPAIR TABLE` with the log tables. (Bug#21966)
- The optimizer sometimes mishandled R-tree indexes for `GEOMETRY` data types, resulting in a server crash. (Bug#21888)
- Use of a DES-encrypted SSL certificate file caused a server crash. (Bug#21868)
- Use of `PREPARE` with a `CREATE PROCEDURE` statement that contained a syntax error caused a server crash. (Bug#21856)
- Adding a day, month, or year interval to a `DATE` value produced a `DATE`, but adding a week interval produced a `DATETIME` value. Now all produce a `DATE` value. (Bug#21811)
- Use of a subquery that invoked a function in the column list of the outer query resulted in a memory leak. (Bug#21798)
- It was not possible to do an atomic rename of the log tables without the possibility of losing rows. Now you can do this:

```
USE mysql;
CREATE TABLE IF NOT EXISTS general_log2 LIKE general_log;
RENAME TABLE general_log TO general_log_backup, general_log2 TO general_log;
```

(Bug#21785, Bug#17544)

- Within a prepared statement, `SELECT (COUNT(*) = 1)` (or similar use of other aggregate functions) did not return the correct result for statement re-execution. (Bug#21354)
- Within a stored routine, a view definition cannot refer to routine parameters or local variables. However, an error did not occur until the routine was called. Now it occurs during parsing of the routine creation statement.

### Note

A side effect of this fix is that if you have already created such routines, an error will occur if you execute `SHOW CREATE PROCEDURE` or `SHOW CREATE FUNCTION`. You should drop these routines because they are erroneous.

(Bug#20953)

- In `mysql`, invoking `connect` or `\r` with very long `db_name` or `host_name` parameters caused buffer overflow. (Bug#20894)
- `WITH ROLLUP` could group unequal values. (Bug#20825)
- Range searches on columns with an index prefix could miss records. (Bug#20732)
- The server did not allocate sufficient memory for some queries for which a `DISTINCT` to `GROUP BY` conversion is possible and an `ORDER BY` clause is present, resulting in a server crash. (Bug#20503)
- `LIKE` searches failed for indexed `utf8` character columns. (Bug#20471)
- With `sql_mode = TRADITIONAL`, MySQL incorrectly aborted on warnings within stored routines and triggers. (Bug#20028)
- `mysqldump --xml` produced invalid XML for `BLOB` data. (Bug#19745)
- The range analysis optimizer did not take into account predicates for which an index could be used after reading `const` tables. In some cases this resulted in non-optimal execution plans. (Bug#19579)
- `FLUSH INSTANCES` in Instance Manager triggered an assertion failure. (Bug#19368)
- For a debug server, a reference to an undefined user variable in a prepared statement executed with `EXECUTE` caused an assertion failure. (Bug#19356)
- Within a trigger for a base table, selecting from a view on that base table failed. (Bug#19111)
- The value of the `warning_count` system variable was not being calculated correctly (also affecting `SHOW COUNT(*) WARNINGS`). (Bug#19024)

- `DELETE IGNORE` could hang for foreign key parent deletes. (Bug#18819)
- InnoDB used table locks (not row locks) within stored functions. (Bug#18077)
- `mysql` would lose its connection to the server if its standard output was not writable. (Bug#17583)
- At shutdown, Instance Manager told guarded server instances to stop, but did not wait until they actually stopped. (Bug#17486)
- `mysql-test-run` did not work correctly for RPM-based installations. (Bug#17194)
- A client library crash was caused by executing a statement such as `SELECT * FROM t1 PROCEDURE ANALYSE()` using a server side cursor on a table `t1` that does not have the same number of columns as the output from `PROCEDURE ANALYSE()`. (Bug#17039)
- The `WITH CHECK OPTION` for a view failed to prevent storing invalid column values for `UPDATE` statements. (Bug#16813)
- InnoDB showed substandard performance with multiple queries running concurrently. (Bug#15815)
- `ALTER TABLE` was not able to rename a view. (Bug#14959)
- Statements such as `DROP PROCEDURE` and `DROP VIEW` were written to the binary log too late due to a race condition. (Bug#14262)
- A literal string in a `GROUP BY` clause could be interpreted as a column name. (Bug#14019)
- Entries in the slow query log could have an incorrect `Rows_examined` value. (Bug#12240)
- Lack of validation for input and output `TIME` values resulted in several problems: `SEC_TO_TIME()` in some cases did not clip large values to the `TIME` range appropriately; `SEC_TO_TIME()` treated `BIGINT UNSIGNED` values as signed; only truncation warnings were produced when both truncation and out-of-range `TIME` values occurred. (Bug#11655, Bug#20927)
- Several string functions could return incorrect results when given very large length arguments. (Bug#10963)
- `FROM_UNIXTIME()` did not accept arguments up to `POWER(2, 31) - 1`, which it had previously. (Bug#9191)
- `OPTIMIZE TABLE` with `myisam_repair_threads > 1` could result in MyISAM table corruption. (Bug#8283)

## C.2.26. Changes in MySQL 5.1.12 (24 October 2006)

This is a new Beta development release, fixing recently discovered bugs.

This section documents all changes and bug fixes that have been applied since the last official MySQL release. If you would like to receive more fine-grained and personalized *update alerts* about fixes that are relevant to the version and features you use, please consider subscribing to *MySQL Enterprise* (a commercial MySQL offering). For more details please see <http://www.mysql.com/products/enterprise>.

Functionality added or changed:

- **Incompatible Change: MySQL Cluster:** MySQL Cluster node and system restarts formerly required that all fragments use the same local checkpoint (LCP); beginning with this version, it is now possible for different fragments to use different LCPs during restarts. This means that data node file systems must be rebuilt as part of any upgrade to this version by restarting all data nodes with the `--initial` option.

See [MySQL Cluster 5.1 and MySQL Cluster NDB 6.x/7.x Upgrade and Downgrade Compatibility](#), and related sections of the Manual before upgrading a MySQL Cluster to version 5.1.12 or later. (Bug#21478, Bug#21271)

- **Incompatible Change:** In the `INFORMATION_SCHEMA.EVENTS` table, the `EVENT_DEFINITION` column now contains the SQL executed by a scheduled event.

The `EVENT_BODY` column now contains the language used for the statement or statements shown in `EVENT_DEFINITION`. In MySQL 5.1, the value shown in `EVENT_BODY` is always `SQL`.

These changes were made to bring this table into line with the `INFORMATION_SCHEMA.ROUTINES` table, and that table's `ROUTINE_BODY` and `ROUTINE_DEFINITION` columns. (Bug#16992)

- **Incompatible Change:** Support for the BerkeleyDB (BDB) engine has been dropped from this release. Any existing tables that are in BDB format will not be readable from within MySQL from 5.1.12 or newer. You should convert your tables to another storage engine *before* upgrading to 5.1.12.

Because of this change, the `SHOW [BDB] LOGS` statement has been dropped.

- **Incompatible Change:** A number of MySQL constructs are now prohibited in partitioning expressions, beginning with this release. These include the following:
  - A number of MySQL functions. For a complete list of these, see [Section 17.5.3, “Partitioning Limitations Relating to Functions”](#).
  - The bit operators `|`, `&`, `^`, `<<`, `>>`, and `~`.
  - Nested function calls.
  - Calls to stored routines, UDFs, or plugins.
  - Character-to-integer conversions involving non-8-bit character sets or any of the `latin1_german2_ci`, `latin2_czech_cs`, or `cp1250_czech_cs` collations.

These restrictions were added in part as a result of [Bug#18198](#) and related bug reports.

For more information about these and other restrictions on partitioned tables in MySQL, see [Section 17.5, “Restrictions and Limitations on Partitioning”](#).

- **Incompatible Change:** The permitted values for and behaviour of the `event_scheduler` system variable have changed. Permitted values are now `ON`, `OFF`, and `DISABLED`, with `OFF` being the default. It is not possible to change its value to or from `DISABLED` while the server is running.

For details, see [Section 18.4.1, “Event Scheduler Overview”](#).

- **Incompatible Change:** The plugin interface has changed: The `st_mysql_plugin` structure has a new `license` member to indicate the license type. (The allowable values are defined in `mysql/plugin.h`.) This change is not backward compatible, so the API version (`MYSQL_PLUGIN_INTERFACE_VERSION`) has changed. For additional information, see [Section 21.2.3, “Writing Plugins”](#).

- **Incompatible Change:** The full-text parser plugin interface has changed in two ways:

- The `MYSQL_FTPARSER_PARAM` structure has a new `flags` member. This is zero if there are no special flags, or `MYSQL_FTFLAGS_NEED_COPY`, which means that `mysql_add_word()` must save a copy of the word (that is, it cannot use a pointer to the word because the word is in a buffer that will be overwritten.)

This flag might be set or reset by MySQL before calling the parser plugin, by the parser plugin itself, or by the `mysql_parse()` function.

- The `mysql_parse()` and `mysql_add_word()` functions now take a `MYSQL_FTPARSER_PARAM` as their first argument, not a `MYSQL_FTPARSER_PARAM::mysql_ftparam` as before.

These changes are not backward compatible, so the API version (`MYSQL_FTPARSER_INTERFACE_VERSION`) has changed. For additional information, see [Section 21.2.3, “Writing Plugins”](#).

- **Incompatible Change:** Storage engines can be pluggable at runtime, so the distinction between disabled and invalid storage engines no longer applies. This affects the `NO_ENGINE_SUBSTITUTION` SQL mode, as described in [Section 5.1.7, “Server SQL Modes”](#).
- **Incompatible Change:** The namespace for scheduled events has changed, such that events are no longer unique to individual users. This also means that a user with the `EVENT` privilege on a given database can now view, alter, or drop any events defined on that database.

If you used scheduled events in an earlier MySQL 5.1 release, you should rename any of them having the same name and defined on the same database but belonging to different users — so that all events in a given database have unique names — before upgrading to 5.1.12 (or newer).

For additional information, see [Section 18.4.6, “The Event Scheduler and MySQL Privileges”](#).

- **Important Change: Partitioning: MySQL Cluster:** It is no longer possible to create Cluster tables using any partitioning type other than `[LINEAR] KEY`. Attempting to do so now raises an error.
- **Important Change: MySQL Cluster:** `LOAD DATA INFILE` no longer causes an implicit commit for all storage engines. It now causes an implicit commit only for tables using the `NDB` storage engine. ([Bug#11151](#))
- **Important Change: MySQL Cluster:** The status variables `Ndb_connected_host` and `Ndb_connected_port` were renamed to `Ndb_config_from_host` and `Ndb_config_from_port`, respectively.



- **Important Change: Replication:** The default value for the `--binlog-format` server option is now `MIXED`.
- **MySQL Cluster:** The `ndb_config` utility now accepts `-c` as a short form of the `--ndb-connectstring` option. (Bug#22295)
- **MySQL Cluster:** Added the `--bind-address` option for `ndbd`. This allows a data node process to be bound to a specific network interface. (Bug#22195)
- **MySQL Cluster:** The `Ndb_number_of_storage_nodes` system variable was renamed to `Ndb_number_of_data_nodes`. (Bug#20848)
- **MySQL Cluster:** The `HELP` command in the Cluster management client now provides command-specific help. For example, `HELP RESTART` in `ndb_mgm` provides detailed information about the `RESTART` command. (Bug#19620)
- **MySQL Cluster:** A number of erroneous, misleading, or missing error messages have been corrected. (Bug#17297, Bug#19543)
- **MySQL Cluster:** Backup messages are no longer printed to the cluster log.
- **MySQL Cluster:** Added the `--ndb-use-copying-alter-table` option to `mysqld` to provide a fallback in case of problems with online `ALTER TABLE` operations on `NDB` tables.
- **Replication:** The default binary log format (as used during replication) is now Mixed based, automatically using a combination of row-based and statement based log events as appropriate.
- **Cluster API:** Two new `NDB` API methods — `aggregate()` and `validate()` — were added to the `NdbDictionary::Object::Table` class. See `Table::aggregate()`, and `Table::validate()`, for more information. This was done to rectify the following issues:
  - Under some conditions, the data distribution could become unbalanced in a MySQL Cluster with 2 or more node groups following the creation of a new table.
  - Data was stored unevenly between partitions due to all `BLOB` data being placed in partition 0. (Bug#21690)
- The number of `InnoDB` threads is no longer limited to 1,000 on Windows. (Bug#22268)
- The `STATE` column of the `INFORMATION_SCHEMA.PROCESSLIST` table was increased from 30 to 64 characters to accommodate longer state values. (Bug#21652)
- `mysqldump` now has a `--flush-privileges` option. It causes `mysqldump` to emit a `FLUSH PRIVILEGES` statement after dumping the `mysql` database. This option should be used any time the dump contains the `mysql` database and any other database that depends on the data in the `mysql` database for proper restoration. (Bug#21424)
- `mysqlslap` threads now try to connect up to 10 times if the initial connect attempt fails. (Bug#21297)
- For `mysqldump`, the output generated by the server when using the `--xml` option has changed with regard to null values. It now matches the output from `mysqldump --xml`. That is, a column containing a `NULL` value is now reported as
 

```
<field name="column_name" xsi:nil="true" />
```

 whereas a column containing the string value `'NULL'` is reported as
 

```
<field name="column_name">NULL</field>
```

 and a column containing an empty string is reported as
 

```
<field name="column_name">>/field>
```

 (Bug#21263)
- The `mysqld` and `mysqlmanager` man pages have been reclassified from volume 1 to volume 8. (Bug#21220)
- `InnoDB` now honors `IGNORE INDEX`. Previously using `IGNORE INDEX` in cases where an index sort would be slower than a filesort had no effect when used with `InnoDB` tables. (Bug#21174)
- `TIMESTAMP` columns that are `NOT NULL` now are reported that way by `SHOW COLUMNS` and `INFORMATION_SCHEMA`. (Bug#20910)
- Memory consumption of the `InnoDB` data dictionary cache was roughly halved by cleaning up the data structures.

)

- The `BINARY` keyword now is forbidden as a data type attribute in stored routines (for example, `DECLARE v1 VARCHAR(25) BINARY`), because `DECLARE` does not support collations, and in this context `BINARY` specifies the binary collation of the variable's character set. (Bug#20701)
- The following statements now can be executed as prepared statements (using `PREPARE` plus `EXECUTE`):

```
CACHE INDEX
CHANGE MASTER
CHECKSUM {TABLE | TABLES}
{CREATE | RENAME | DROP} DATABASE
{CREATE | RENAME | DROP} USER
FLUSH {TABLE | TABLES | TABLES WITH READ LOCK | HOSTS | PRIVILEGES
      | LOGS | STATUS | MASTER | SLAVE | DES_KEY_FILE | USER_RESOURCES}
GRANT
REVOKE
KILL
LOAD INDEX INTO CACHE
RESET {MASTER | SLAVE | QUERY CACHE}
SHOW BINLOG EVENTS
SHOW CREATE {PROCEDURE | FUNCTION | EVENT | TABLE | VIEW}
SHOW {AUTHORS | CONTRIBUTORS | WARNINGS | ERRORS}
SHOW {MASTER | BINARY} LOGS
SHOW {MASTER | SLAVE} STATUS
SLAVE {START | STOP}
INSTALL PLUGIN
UNINSTALL PLUGIN
```

(Bug#20665)

- In the `INFORMATION_SCHEMA.ROUTINES` table the `ROUTINE_DEFINITION` column now is defined as `NULL` rather than `NOT NULL`. Also, `NULL` rather than the empty string is returned as the column value if the user does not have sufficient privileges to see the routine definition. (Bug#20230)
- The `mysqldumpslow` script has been moved from client RPM packages to server RPM packages. This corrects a problem where `mysqldumpslow` could not be used with a client-only RPM install, because it depends on `my_print_defaults` which is in the server RPM. (Bug#20216)
- The MySQL distribution now compiles on UnixWare 7.13. (Bug#20190)
- `configure` now defines the symbol `DEBUG_ON` in `config.h` to indicate whether the source tree is configured to be compiled with debugging support. (Bug#19517)
- `TEXT` and `BLOB` columns do not support `DEFAULT` values. However, when a default of `' '` was specified, the specification was silently ignored. This now results in a warning, or an error in strict mode. (Bug#19498)
- For `mysqlshow`, if a database name argument contains wildcard characters (such as `"_"`) but matches a single database name exactly, treat the name as a literal name. This allows a command such as `mysqlshow information_schema` work without having to escape the wildcard character. (Bug#19147)
- The source distribution has been updated so that the UDF example can be compiled under Windows with CMake. See Section 21.3.2.5, "Compiling and Installing User-Defined Functions". (Bug#19121)
- The default value of the `tmp_table_size` system variable was lowered from 32MB to 16MB because it is bounded by the value of `max_heap_table_size`, which has a default of 16MB. (Bug#18875)
- Log table changes: By default, the log tables use the `CSV` storage engine, as before. But now the log tables can be altered to use the `MyISAM` storage engine. You cannot use `ALTER TABLE` to alter a log table that is in use. The log must be disabled first. No engines other than `CSV` or `MyISAM` are legal for the log tables. The use of `DROP TABLE` for log tables is similarly restricted: It cannot be used to drop a log table that is in use. The log must be disabled first. (These changes also correct a deadlock that occurred for an attempt to drop an in-use log table.) (Bug#18559)
- Added the `--set-charset` option to `mysqlbinlog` to allow the character set to be specified for processing binary log files. (Bug#18351)
- The `ExtractValue()` function now produces an error when passed an XML fragment that is not well-formed. (Previously, the function allowed invalid XML fragments to be used.) (Bug#18201)
- On Windows, typing Control-C while a query was running caused the `mysql` client to crash. Now it causes `mysql` to attempt to kill the current statement. If this cannot be done, or Control-C is typed again before the statement is killed, `mysql` exits. (In other words, `mysql`'s behavior with regard to Control-C is now the same as it is on Unix platforms.) (Bug#17926)

See also Bug#1989.



- The bundled yaSSL library licensing has added a FLOSS exception similar to MySQL to resolve licensing incompatibilities with MySQL. (See the [extra/yassl/FLOSS-EXCEPTIONS](#) file in a MySQL source distribution for details.) (Bug#16755)
- `SHOW CREATE TABLE` now shows constraints for InnoDB tables. (Bug#16614)
- `EXPLAIN EXTENDED` now shows a `filtered` column that is an estimated percentage of the examined rows that will be joined with the previous tables. This was added while dealing with a problem of MySQL choosing the wrong index for some queries. (Bug#14940)
- The `mysql` client now allows `\l` in the `prompt` command argument to insert the current delimiter into the prompt. (Bug#14448)
- The `mysql` client used the default character set if it automatically reconnected to the server, which is incorrect if the character set had been changed. To enable the character set to remain synchronized on the client and server, the `mysql` command `charset` (or `\C`) that changes the default character set and now also issues a `SET NAMES` statement. The changed character set is used for reconnects. (Bug#11972)
- The `LEFT()` and `RIGHT()` functions return `NULL` if any argument is `NULL`. (Bug#11728)
- If a `DROP VIEW` statement named multiple views, it stopped with an error if a non-existent view was named and did not drop the remaining views. Now it continues on and reports an error at the end, similar to `DROP TABLE`. (Bug#11551)
- For a successful dump, `mysqldump` now writes a SQL comment to the end of the dump file in the following format:

```
-- Dump completed on YYYY-MM-DD hh:mm:ss
```

(Bug#10877)

- There were several issues regarding how `SHOW STATUS` affected some status variables and logging which could impact monitoring the MySQL Server. The behavior of this statement has been modified in two ways:
  - `SHOW STATUS` is no longer logged to the slow query log.
  - `SHOW STATUS` no longer updates any session status variables, except for `com_show_status`.

However, `SHOW STATUS` continues to update *global* status variables to allow monitoring of what the server is actually doing. This is because `SHOW STATUS` creates temporary tables that may affect performance if it is called excessively often. (Bug#10210)

See also Bug#19764.

- For spatial data types, the server formerly returned these as `VARSTRING` values with a binary collation. Now the server returns spatial values as `BLOB` values. (Bug#10166)
- The `LOAD DATA FROM MASTER` and `LOAD TABLE FROM MASTER` statements are deprecated. See [Section 12.6.2.2, “LOAD DATA FROM MASTER Syntax”](#), for recommended alternatives. (Bug#9125, Bug#20596, Bug#14399, Bug#12187, Bug#15025, Bug#18822)
- For the `mysql` client, typing Control-C causes `mysql` to attempt to kill the current statement. If this cannot be done, or Control-C is typed again before the statement is killed, `mysql` exits. Previously, Control-C caused `mysql` to exit in all cases. (Bug#1989)
- It is no longer possible to create partitioned tables using the `CSV` storage engine.
- Binary MySQL distributions no longer include a `mysqld-max` server. Instead, distributions contain a binary that includes the features previously included in the `mysqld-max` binary.
- `SHOW STATUS` is no longer logged to the slow query log.
- Program Database files (extension `pdf`) are now included by default in Windows distributions. These can be used to help diagnose problems with `mysqld` and other tools. See [Section 21.5.1, “Debugging a MySQL Server”](#).
- `INFORMATION_SCHEMA` contains new tables, `GLOBAL_STATUS`, `SESSION_STATUS`, `GLOBAL_VARIABLES`, and `SESSION_VARIABLES`, that correspond to the output from the `SHOW {GLOBAL|SESSION} STATUS` and `SHOW {GLOBAL|SESSION} VARIABLES` statements.
- `SHOW STATUS` no longer updates any session status variables, except for `com_show_status`.
- A new system variable, `lc_time_names`, specifies the locale that controls the language used to display day and month names and abbreviations. This variable affects the output from the `DATE_FORMAT()`, `DAYNAME()` and `MONTHNAME()` functions. See [Section 9.8, “MySQL Server Locale Support”](#).

- Using `--with-debug` to configure MySQL with debugging support enables you to use the `--debug="d,parser_debug"` option when you start the server. This causes the Bison parser that is used to process SQL statements to dump a parser trace to the server's standard error output. Typically, this output is written to the error log.
- The bundled yaSSL library was upgraded to version 1.3.7.
- The Instance Manager `--passwd` option has been renamed to `--print-password-line`. Other options were added to enable management of the IM password file from the command line: `--add-user`, `--drop-user`, `--edit-user`, `--list-users`, `--check-password-file`, `--clean-password-file`, `--username`, and `--password`. The `--mysqld-safe-compatible` option was added to cause the Instance Manner to act similarly to `mysqld_safe`.
- Added the `SHOW CONTRIBUTORS` statement.
- The general query log and slow query logs now can be enabled or disabled at runtime with the `general_log` and `slow_query_log` system variables, and the name of the log files can be changed by setting the `general_log_file` and `slow_query_log_file` system variables. See [Section 5.2.3, “The General Query Log”](#), and [Section 5.2.5, “The Slow Query Log”](#).

## Bugs fixed:

- **Security Fix:** A stored routine created by one user and then made accessible to a different user using `GRANT EXECUTE` could be executed by that user with the privileges of the routine's definer. ([Bug#18630](#), [CVE-2006-4227](#))
- **Security Fix:** On Linux, and possibly other platforms using case-sensitive file systems, it was possible for a user granted rights on a database to create or access a database whose name differed only from that of the first by the case of one or more letters. ([Bug#17647](#), [CVE-2006-4226](#))
- **Security Fix:** If a user has access to `MyISAM` table `t`, that user can create a `MERGE` table `m` that accesses `t`. However, if the user's privileges on `t` are subsequently revoked, the user can continue to access `t` by doing so through `m`. If this behavior is undesirable, you can start the server with the new `--skip-merge` option to disable the `MERGE` storage engine. ([Bug#15195](#), [CVE-2006-4031](#))

- **Incompatible Change:** For `utf8` columns, the full-text parser incorrectly considered several non-word punctuation and whitespace characters as word characters, causing some searches to return incorrect results.

The fix involves a change to the full-text parser, so any tables that have `FULLTEXT` indexes on `utf8` columns must be repaired with `REPAIR TABLE`:

```
REPAIR TABLE tbl_name QUICK;
```

([Bug#19580](#))

- **MySQL Cluster: Packaging:** The `ndb_mgm` program was included in both the `MySQL-ndb-tools` and `MySQL-ndb-management` RPM packages, resulting in a conflict if both were installed. Now `ndb_mgm` is included only in `MySQL-ndb-tools`. ([Bug#21058](#))
- **MySQL Cluster: Replication:** A `DELETE FROM table` with no `WHERE` clause (deleting all rows) running concurrently with `INSERT` statements on a storage engine with row-level locking (such as `NDB`) could produce inconsistent results when using statement-based replication. ([Bug#19066](#))
- **MySQL Cluster: Replication:** (Replication): A node failure could send duplicate events, causing a `mysqld` replicating tables containing `BLOBs` to crash.
- **MySQL Cluster:** (NDB API): Inactivity timeouts for scans were not correctly handled. ([Bug#23107](#))
- **MySQL Cluster:** Inserting into an `NDB` table failed when the table had no primary key but had a unique key added after table was created on one or more `NOT NULL` columns. This occurred when the unique key had been adding using either `ALTER TABLE` or `CREATE UNIQUE KEY`. ([Bug#22838](#))
- **MySQL Cluster:** (NDB API): Attempting to read a non-existent tuple using `Commit` mode for `NdbTransaction::execute()` caused node failures. ([Bug#22672](#))
- **MySQL Cluster:** The `--help` output from `NDB` binaries did not include file-related options. ([Bug#21994](#))
- **MySQL Cluster:** Setting `TransactionDeadlockDetectionTimeout` to a value greater than 12000 would cause scans to deadlock, time out, fail to release scan records, until the cluster ran out of scan records and stopped processing. ([Bug#21800](#))
- **MySQL Cluster:** A scan timeout returned Error 4028 (`NODE FAILURE CAUSED ABORT OF TRANSACTION`) instead of Error 4008 (`NODE FAILURE CAUSED ABORT OF TRANSACTION...`). ([Bug#21799](#))

- **MySQL Cluster:** The node recovery algorithm was missing a version check for tables in the `ALTER_TABLE_COMMITTED` state (as opposed to the `TABLE_ADD_COMMITTED` state, which has the version check). This could cause inconsistent schemas across nodes following node recovery. (Bug#21756)
- **MySQL Cluster:** A memory leak occurred when running `ndb_mgm -e "SHOW"`. (Bug#21670)
- **MySQL Cluster:** The server provided a non-descriptive error message when encountering a fatally corrupted REDO log. (Bug#21615)
- **MySQL Cluster:** The output for the `--help` option used with NDB executable programs (such as `ndbd`, `ndb_mgm`, `ndb_restore`, `ndb_config`, and others mentioned in [MySQL Cluster Programs](#)) referred to the `Ndb.cfg` file, instead of to `my.cnf`. (Bug#21585)
- **MySQL Cluster:** A partial rollback could lead to node restart failures. (Bug#21536)
- **MySQL Cluster:** Partition distribution keys were updated only for the primary and starting replicas during node recovery. This could lead to node failure recovery for clusters having an odd number of replicas.

**Note**

We recommend values for `NumberOfReplicas` that are even powers of 2, for best results.

(Bug#21535)

- **MySQL Cluster:** The `ndb_mgm` management client did not set the exit status on errors, always returning 0 instead. (Bug#21530)
- **MySQL Cluster:** The failure of a unique index read due to an invalid schema version could be handled incorrectly in some cases, leading to unpredictable results. (Bug#21384)
- **MySQL Cluster:** Attempting to create an NDB table on a MySQL server with an existing non-Cluster table with the same name in the same database could result in data loss or corruption. Now, if such a table is encountered during autodiscovery, a warning is written to the error log of the affected `mysqld`, and the local table is overwritten. (Bug#21378)
- **MySQL Cluster:** Cluster logs were not rotated following the first rotation cycle. (Bug#21345)
- **MySQL Cluster:** In a cluster with more than 2 replicas, a manual restart of one of the data nodes could fail and cause the other nodes in the same node group to shut down. (Bug#21213)
- **MySQL Cluster:** The `ndb_size.pl` script did not account for `TEXT` and `BLOB` column values correctly. (Bug#21204)
- **MySQL Cluster:** Some queries involving joins on very large NDB tables could crash the MySQL server. (Bug#21059)
- **MySQL Cluster:** Condition pushdown did not work correctly with `DATETIME` columns. (Bug#21056)
- **MySQL Cluster:** Responses to the `ALL DUMP 1000` management client command were printed multiple times in the cluster log for each cluster node. (Bug#21044)
- **MySQL Cluster:** The message `ERROR 0 IN READAUTOINCREMENTVALUE(): NO ERROR` was written to the error log whenever `SHOW TABLE STATUS` was performed on a Cluster table that did not have an `AUTO_INCREMENT` column. (Bug#21033)
- **MySQL Cluster:** Restarting a data node while DDL operations were in progress on the cluster could cause other data nodes to fail. This could also lead to `mysqld` hanging or crashing under some circumstances. (Bug#21017, Bug#21050)
- **MySQL Cluster:** In some situations with a high disk-load, writing of the redo log could hang, causing a crash with the error message `GCP STOP DETECTED`. (Bug#20904)
- **MySQL Cluster:** A race condition could in some circumstances following a `DROP TABLE`. (Bug#20897)
- **MySQL Cluster:** Under some circumstances, local checkpointing would hang, keeping any unstarted nodes from being started. (Bug#20895)
- **MySQL Cluster:** When the redo buffer ran out of space, a `POINTER TOO LARGE` error was raised and the cluster could become unusable until restarted with `--initial`. (Bug#20892)
- **MySQL Cluster:** A vague error message was returned when reading both schema files during a restart of the cluster. (Bug#20860)
- **MySQL Cluster:** The repeated creating and dropping of a table would eventually lead to NDB Error 826, `TOO MANY TABLES AND ATTRIBUTES ... INSUFFICIENT SPACE`. (Bug#20847)

- **MySQL Cluster:** When attempting to restart the cluster following a data import, the cluster failed during Phase 4 of the restart with `ERROR 2334: JOB BUFFER CONGESTION`. (Bug#20774)
- **MySQL Cluster:** `REPLACE` statements did not work correctly on an `NDB` table having both a primary key and a unique key. In such cases, proper values were not set for columns which were not explicitly referenced in the statement. (Bug#20728)
- **MySQL Cluster:** The server did not honor the value set for `ndb_cache_check_time` in the `my.cnf` file. (Bug#20708)
- **MySQL Cluster:** Truncating a table on one `mysqld` caused other `mysqld` processes connected to the cluster to return `ERROR 1412 (HY000): TABLE DEFINITION HAS CHANGED, PLEASE RETRY TRANSACTION` on subsequent queries. (Bug#20705)
- **MySQL Cluster:** Using an invalid node ID with the management client `STOP` command could cause `ndb_mgm` to hang. (Bug#20575)
- **MySQL Cluster:** Renaming of table columns was not supported as fast as `ALTER TABLE` for `NDB` tables. (Bug#20456)
- **MySQL Cluster:** `ndb_size.pl` and `ndb_error_reporter` were missing from RPM packages. (Bug#20426)
- **MySQL Cluster:** Running `ndbd --nowait-nodes=id` where `id` was the node ID of a node that was already running would fail with an invalid error message. (Bug#20419)
- **MySQL Cluster:** Data nodes added while the cluster was running in single user mode were all assigned node ID 0, which could later cause multiple node failures. Adding nodes while in single user mode is no longer possible. (Bug#20395)
- **MySQL Cluster:** The `ndb_mgm` client command `ALL CLUSTERLOG STATISTICS=15` had no effect. (Bug#20336)
- **MySQL Cluster:** (Direct APIs): `NdbScanOperation::readTuples()` and `NdbIndexScanOperation::readTuples()` ignored the `batch` parameter. (Bug#20252)
- **MySQL Cluster:** A node failure during a scan could sometime cause the node to crash when restarting too quickly following the failure. (Bug#20197)
- **MySQL Cluster:** The failure of a data node when preparing to commit a transaction (that is, while the node's status was `CS_PREPARE_TO_COMMIT`) could cause the failure of other cluster data nodes. (Bug#20185)
- **MySQL Cluster:** `SHOW ENGINE NDB STATUS` could sometimes return an incorrect value of 0 for the latest epoch, which could cause problems with synchronizing the binlog. (Bug#20142)
- **MySQL Cluster:** An internal formatting error caused some management client error messages to be unreadable. (Bug#20016)
- **MySQL Cluster:** Creating tables with variable-size columns caused `DataMemory` to be used but not freed when the tables were dropped. (Bug#20007)
- **MySQL Cluster:** Renaming a table in such a way as to move it to a different database failed to move the table's indexes. (Bug#19967)
- **MySQL Cluster:** Running management client commands while `mgmd` was in the process of disconnecting could cause the management server to fail. (Bug#19932)
- **MySQL Cluster:** Under certain conditions, a starting node could miss transactions, leading to inconsistencies between the primary and backup replicas. (Bug#19929)
- **MySQL Cluster:** An uncommitted row could sometimes be checkpointed and thus incorrectly included in a backup. (Bug#19928)
- **MySQL Cluster:** In some cases where `SELECT COUNT(*)` from an `NDB` table should have yielded an error, `MAX_INT` was returned instead. (Bug#19914)
- **MySQL Cluster:** `TEXT` columns in Cluster tables having both an explicit primary key and a unique key were not correctly updated by `REPLACE` statements. (Bug#19906)
- **MySQL Cluster:** The cluster's data nodes failed while trying to load data when `NoOfFrangmentLogFiles` was set equal to 1. (Bug#19894)
- **MySQL Cluster:** Following the restart of a management node, the Cluster management client did not automatically reconnect. (Bug#19873)
- **MySQL Cluster:** Restoring a backup with `ndb_restore` failed when the backup had been taken from a cluster whose `DataMemory` had been completely used up. (Bug#19852)
- **MySQL Cluster:** Error messages given when trying to make online changes to parameters such as `NoOfReplicas` that can

only be changed via a complete shutdown and restart of the cluster did not indicate the true nature of the problem. (Bug#19787)

- **MySQL Cluster:** Under some circumstances, repeated DDL operations on one `mysqld` could cause failure of a second `mysqld` attached to the same cluster. (Bug#19770)
- **MySQL Cluster:** `ndb_restore` did not always make clear that it had recovered successfully from temporary errors while restoring a cluster backup. (Bug#19651)
- **MySQL Cluster:** Resources for unique indexes on Cluster table columns were incorrectly allocated, so that only one-fourth as many unique indexes as indicated by the value of `UniqueHashIndexes` could be created. (Bug#19623)
- **MySQL Cluster:** `LOAD DATA LOCAL` failed to ignore duplicate keys in Cluster tables. (Bug#19496)
- **MySQL Cluster:** For `ndb_mgmd`, Valgrind revealed problems with a memory leak and a dependency on an uninitialized variable. (Bug#19318, Bug#20333)
- **MySQL Cluster:** A `DELETE` of many rows immediately followed by an `INSERT` on the same table could cause the `ndbd` process on the backup replica to crash. (Bug#19293)
- **MySQL Cluster:** An excessive number of `ALTER TABLE` operations could cause the cluster to fail with NDB error code 773 (`OUT OF STRING MEMORY, PLEASE MODIFY STRINGMEMORY`). (Bug#19275)
- **MySQL Cluster:** A problem with error handling when `ndb_use_exact_count` was enabled could lead to incorrect values returned from queries using `COUNT()`. A warning is now returned in such cases. (Bug#19202)
- **MySQL Cluster:** In rare situations with resource shortages, a crash could result from insufficient `IndexScanOperations`. (Bug#19198)
- **MySQL Cluster:** Running out of `DataMemory` could sometimes crash `ndbd` and `mysqld` processes. (Bug#19185)
- **MySQL Cluster:** It was possible to use port numbers greater than 65535 for `ServerPort` in the `config.ini` file. (Bug#19164)
- **MySQL Cluster:** `ndb_mgm -e show | head` would hang after displaying the first 10 lines of output. (Bug#19047)
- **MySQL Cluster:** The error returned by the cluster when too many nodes were defined did not make clear the nature of the problem. (Bug#19045)
- **MySQL Cluster:** The management client `ALL STOP` command shut down `mgmd` processes (as well as `ndbd` processes). (Bug#18966)
- **MySQL Cluster:** `TRUNCATE TABLE` failed to reset the `AUTO_INCREMENT` counter. (Bug#18864)
- **MySQL Cluster:** Restarting a failed node could sometimes crash the cluster. (Bug#18782)
- **MySQL Cluster:** Trying to create or drop a table while a node was restarting caused the node to crash. This is now handled by raising an error. (Bug#18781)
- **MySQL Cluster:** Repeated `CREATE - INSERT - DROP` operations on tables could in some circumstances cause the MySQL table definition cache to become corrupt, so that some `mysqld` processes could access table information but others could not. (Bug#18595)
- **MySQL Cluster:** A `CREATE TABLE` statement involving foreign key constraints raised an error rather than being silently ignored (see Section 12.1.17, “`CREATE TABLE Syntax`”).

This bug affected Cluster in MySQL 5.1 only. (Bug#18483)

- **MySQL Cluster:** The server failed with a non-descriptive error message when out of data memory. (Bug#18475)
- **MySQL Cluster:** For NDB and possibly `InnoDB` tables, a `BEFORE UPDATE` trigger could insert incorrect values. (Bug#18437)
- **MySQL Cluster:** The `DATA_LENGTH` and `AVG_ROW_LENGTH` columns of the `INFORMATION_SCHEMA.TABLES` table did not report the size of variable-width column values correctly.

See Section 19.2, “The `INFORMATION_SCHEMA.TABLES` Table”, for more information. (Bug#18413)

- **MySQL Cluster:** `SELECT ... FOR UPDATE` failed to lock the selected rows. (Bug#18184)
- **MySQL Cluster:** (Disk Data): Deletes from Disk Data tables used a non-optimal scan to find the rows to be deleted, resulting in poor performance. The fix causes disk order rather than memory order to be used, and can improve performance of Disk



Data deletes by up to ~300% in some cases. ([Bug#17929](#))

- **MySQL Cluster:** `pererror` did not properly report NDB error codes. ([Bug#16561](#))
- **MySQL Cluster:** A problem with takeover during a system restart caused ordered indexes to be rebuilt incorrectly. This also adversely affected MySQL Cluster Replication. ([Bug#15303](#))
- **MySQL Cluster:** A cluster data node could crash when an ordered index became full before the table containing the index was full. ([Bug#14935](#))
- **MySQL Cluster:** The management client `ALL STATUS` command could sometimes report the status of some data nodes incorrectly. ([Bug#13985](#))
- **MySQL Cluster:** New `mysqld` processes were allowed to connect without a restart of the cluster, causing the cluster to crash. ([Bug#13266](#))
- **MySQL Cluster:** Cluster system status variables were not updated properly. ([Bug#11459](#))
- **MySQL Cluster:** (NDBAPI): Update operations on blobs were not checked for illegal operations.

### Note

Read locks with blob update operations are now upgraded from read committed to read shared.

- **MySQL Cluster:** The loss of one or more data nodes could sometimes cause `ndb_mgmd` to use a high amount of CPU (15 percent or more, as opposed to 1 to 2 percent normally).
- **Partitioning:** Old partition and subpartition files were not always removed following `ALTER TABLE ... REORGANIZE PARTITION` statements. ([Bug#20770](#))
- **Cluster Replication: Replication:** In some cases, a large number of MySQL servers sending requests to the cluster simultaneously could cause the cluster to crash. This could also be triggered by many NDB API clients making simultaneous event subscriptions or unsubscriptions. ([Bug#20683](#))
- **Cluster Replication: Replication:** Data definition and data manipulation statements on different tables were not serialised correctly in the binary log. For example, there was no guarantee that a `CREATE TABLE` statement and an update on a different table would occur in the same order in the binary log as they did on the cluster being replicated. ([Bug#18947](#))
- **Replication:** `BIT` columns were not replicated properly under row-based replication. ([Bug#22550](#))
- **Replication:** For row-based replication, log rotation could occur at an improper time. ([Bug#21474](#))
- **Replication:** In mixed-format binary logging mode, stored functions, triggers, and views that use functions in their body that require row-based logging did not replicate reliably because the logging did not switch from statement-based to row-based format. For example, `INSERT INTO t SELECT FROM v`, where `v` is a view that selects `UUID()` could cause problems. This limitation has been removed. ([Bug#20930](#))
- **Replication:** A race condition during slave server shutdown caused an assert failure. ([Bug#20850](#))
- **Replication:** With mixed-format binary logging, `INSERT DELAYED` statements were logged using statement-based logging, and they did not replicate properly for statements that used values such as `UUID()`, `RAND()`, or user-defined variables that require row-based logging. To correct this, the `DELAYED` handler thread now switches to row-based logging if the logging format is mixed. ([Bug#20633](#), [Bug#20649](#))
- **Replication:** With the `auto_increment_increment` system variable set larger than 1, if the next generated `AUTO_INCREMENT` value would be larger than the column's maximum value, the value would be clipped down to that maximum value and inserted, even if the resulting value would not be in the generated sequence. This could cause problems for master-master replication. Now the server clips the value down to the previous value in the sequence, which correctly produces a duplicate-key error if that value already exists in the column. ([Bug#20524](#))
- **Replication:** In mixed binary logging mode, a temporary switch from statement-based logging to row-based logging occurs when storing a row that uses a function such as `UUID()` into a temporary table. However, temporary table changes are not written to the binary log under row-based logging, so the row does not exist on the slave. A subsequent select from the temporary table to a non-temporary table using statement-based logging works correctly on the master, but not on the slave where the row does not exist. Replication no longer switches back from row-based logging to statement-based logging until there are no temporary tables for the session. ([Bug#20499](#))
- **Replication:** `CREATE PROCEDURE`, `CREATE FUNCTION`, `CREATE TRIGGER`, and `CREATE VIEW` statements containing multi-line comments (`/* ... */`) could not be replicated. ([Bug#20438](#))
- **Replication:** A stored procedure that used `LAST_INSERT_ID()` did not replicate properly using statement-based binary log-

ging. ([Bug#20339](#))

- **Replication:** When using row based replication, a `CREATE TABLE ... SELECT` statement was replicated, even if the table creation failed on the master (for example, due to a duplicate key failure). ([Bug#20265](#))
- **Replication:** If a table on a slave server had a higher `AUTO_INCREMENT` counter than the corresponding master table (even though all rows of the two tables were identical), in some cases `REPLACE` or `INSERT ... ON DUPLICATE KEY UPDATE` would not replicate properly using statement-based logging. (Different values would be inserted on the master and slave.) ([Bug#20188](#))
- **Replication:** Shutting down a slave in a replication scenario where temporary tables are in use would cause the slave to produce a core dump. ([Bug#19881](#))
- **Replication:** The effect of a stored function or trigger that caused `AUTO_INCREMENT` values to be generated for multiple tables was not logged properly if statement-based logging was used. Only the first table's value was logged, causing replication to fail. Under mixed logging format, this is dealt with by switching to row-based logging for the function or trigger. For statement-based logging, this remains a problem. ([Bug#19630](#))
- **Replication:** For row-based replication, the `BINLOG` statement did not lock tables properly, causing a crash for some table types. ([Bug#19459](#))
- **Replication:** Column names supplied for a view created on a master server could be lost on a slave server. ([Bug#19419](#))
- **Replication:** The dropping of a temporary table whose name contained a backtick (``) character was not correctly written to the binary log, which also caused it not to be replicated correctly. ([Bug#19188](#))
- **Replication:** With row-based replication, replicating a statement to a slave where the table had additional columns relative to the master table did not work. ([Bug#19069](#))
- **Replication:** Valgrind revealed several issues with `mysqld` that were corrected: A dangling stack pointer being overwritten; possible uninitialized data in a string comparison; memory corruption in replication slaves when switching databases; `syscall()` write parameter pointing to an uninitialized byte. ([Bug#19022](#), [Bug#20579](#), [Bug#20769](#), [Bug#20783](#), [Bug#20791](#))
- **Replication:** A redundant table map event could be generated in the binary log when there were no actual changes to a table being replicated. In addition, a slave failed to stop when attempting to replicate a table that did not exist on the slave. ([Bug#18948](#))
- **Replication:** Row-based replication failed when the query cache was enabled on the slave. ([Bug#17620](#))
- **Replication:** Compilation on Windows would fail if row based replication was disabled using `--without-row-based-replication`. ([Bug#16837](#))
- **Replication:** An invalid `GRANT` statement for which `Ok` was returned on a replication master caused an error on the slave and replication to fail. ([Bug#6774](#))
- **Disk Data:** On some platforms, `ndbd` compiled with `gcc 4` would crash when attempting to run `CREATE LOGFILE GROUP`. ([Bug#21981](#))
- **Disk Data:** Trying to create a Disk Data table using a non-existent tablespace or to drop a non-existent data file from a tablespace produced an uninformative error message. ([Bug#21751](#))
- **Disk Data:** Errors could occur when dropping a data file during a node local checkpoint. ([Bug#21710](#))
- **Disk Data:** Creating a tablespace and log file group, then attempting to restart the cluster without using the `--initial` option and without having created any Disk Data tables could cause a forced shutdown of the cluster and raise a configuration error. ([Bug#21172](#))
- **Disk Data:** `mysqldump` did not back up tablespace or log file group information for Disk Data tables correctly.  
Specifically, `UNDO_BUFFER_SIZE` and `INITIAL_SIZE` values were misreported. This meant that trying to restore from such a backup would produce error 1296: `GOT ERROR 1504 'OUT OF LOGBUFFER MEMORY' FROM NDB`. ([Bug#20809](#))
- **Disk Data:** Running a large number of scans on Disk Data could cause subsequent scans to perform poorly. ([Bug#20334](#))
- **Disk Data:** `INFORMATION_SCHEMA.FILES` records for UNDO files showed incorrect values in the `EXTENT_SIZE`, `FREE_EXTENTS`, and `TOTAL_EXTENTS` columns. ([Bug#20073](#))
- **Disk Data:** A data file created for one tablespace could be dropped using `ALTER TABLESPACE ... DROP DATAFILE` using a different tablespace. ([Bug#20053](#))
- **Disk Data:** Trying to create Disk Data tables when running the cluster in diskless mode caused cluster data nodes to crash.

**Note**

Disk Data tables are now disabled when running in diskless mode.

([Bug#20008](#))

- **Disk Data:** An issue with disk allocation could sometimes cause a forced shutdown of the cluster when running a mix of memory and Disk Data tables. ([Bug#18780](#))
- **Disk Data:** The failure of a `CREATE TABLESPACE` or `CREATE LOGFILE GROUP` statement did not revert all changes made prior to the point of failure. ([Bug#16341](#))
- **Cluster Replication:** One or more of the `mysqld` processes could fail when subjecting a Cluster replication setup with multiple `mysqld` processes on both the master and slave clusters to high loads. ([Bug#19768](#))
- **Cluster API:** The `storage/ndb` directory was missing from the server binary distribution, making it impossible to compile NDB API and MGM API applications. This directory can be found as `/usr/include/storage/ndb` after installing that distribution. ([Bug#21955](#))
- **Cluster API:** Invoking the MGM API function `ndb_mgm_listen_event()` caused a memory leak. ([Bug#21671](#))
- **Cluster API:** The inclusion of `my_config.h` in `NdbApi.h` required anyone wishing to write NDB API applications against MySQL 5.1 to have a complete copy of the 5.1 sources. ([Bug#21253](#))
- **Cluster API:** The MGM API function `ndb_logevent_get_fd()` was not implemented. ([Bug#21129](#))
- **Cluster API:** The `NdbOperation::getBlobHandle()` method, when called with the name of a non-existent column, caused a segmentation fault. ([Bug#21036](#))
- `ALTER EVENT` statements including only a `COMMENT` clause failed with a syntax error on two platforms: Linux for S/390, and OS X 10.4 for 64-bit PPC. ([Bug#23423](#))
- When `event_scheduler` was set to `DISABLED`, its value was not displayed correctly by `SHOW VARIABLES` or `SELECT @@global.event_scheduler`. ([Bug#22662](#))
- `ALTER EVENT` in the body of a stored procedure led to a crash when the procedure was called. This affected only those `ALTER EVENT` statements which changed the interval of the event. ([Bug#22397](#))
- The optimizer could make an incorrect index choice for indexes with a skewed key distribution. ([Bug#22393](#))
- Deleting entries from a large `MyISAM` index could cause index corruption when it needed to shrink. Deletes from an index can happen when a record is deleted, when a key changes and must be moved, and when a key must be un-inserted because of a duplicate key. This can also happen in `REPAIR TABLE` when a duplicate key is found and in `myisamchk` when sorting the records by an index. ([Bug#22384](#))
- Instance Manager had a race condition involving `mysqld` PID file removal. ([Bug#22379](#))
- `yaSSL` had a conflicting definition for `socklen_t` on `hurd-i386` systems. ([Bug#22326](#))
- Conversion of values inserted into a `BIT` column could affect adjacent columns. ([Bug#22271](#))
- Some Linux-x86\_64-icc packages (of previous releases) mistakenly contained 32-bit binaries. Only `ICC` builds are affected, not `gcc` builds. Solaris and FreeBSD x86\_64 builds are not affected. ([Bug#22238](#))
- `mysql_com.h` unnecessarily referred to the `ulong` type. ([Bug#22227](#))
- The source distribution would not build on Windows due to a spurious dependency on `ib_config.h`. ([Bug#22224](#))
- Execution of a prepared statement that uses an `IN` subquery with aggregate functions in the `HAVING` clause could cause a server crash. ([Bug#22085](#))
- The `CSV` storage engine failed to detect some table corruption. ([Bug#22080](#))
- Using `GROUP_CONCAT()` on the result of a subquery in the `FROM` clause that itself used `GROUP_CONCAT()` could cause a server crash. ([Bug#22015](#))
- Running `SHOW MASTER LOGS` at the same time as binary log files were being switched would cause `mysqld` to hang. ([Bug#21965](#))
- `libmysqlclient` defined a symbol `BN_bin2bn` which belongs to OpenSSL. This could break applications that also linked



against OpenSSL's `libcrypto` library. The fix required correcting an error in a build script that was failing to add rename macros for some functions. (Bug#21930)

- `character_set_results` can be `NULL` to signify “no conversion,” but some code did not check for `NULL`, resulting in a server crash. (Bug#21913)
- A misleading error message was displayed when attempting to define a unique key that was not valid for a partitioned table. (Bug#21862)
- A query that used `GROUP BY` and an `ALL` or `ANY` quantified subquery in a `HAVING` clause could trigger an assertion failure. (Bug#21853)
- An `InnoDB` mutex was not acquired and released under the same condition, leading to deadlock in some rare situations involving XA transactions. (Bug#21833)
- A `NUL` byte within a prepared statement string caused the rest of the string not to be written to the query log, allowing logging to be bypassed. (Bug#21813)
- `COUNT( *)` queries with `ORDER BY` and `LIMIT` could return the wrong result.

### Note

This problem was introduced by the fix for Bug#9676, which limited the rows stored in a temporary table to the `LIMIT` clause. This optimization is not applicable to non-group queries with aggregate functions. The current fix disables the optimization in such cases.

(Bug#21787)

- Using `DROP TABLE` with concurrent queries causes `mysqld` to crash. (Bug#21784)
- `INSERT ... SELECT` sometimes generated a spurious `Column count doesn't match value count` error. (Bug#21774)
- `UPGRADE` was treated as a reserved word, although it is not. (Bug#21772)
- A function result in a comparison was replaced with a constant by the optimizer under some circumstances when this optimization was invalid. (Bug#21698)
- Selecting from `INFORMATION_SCHEMA.FILES` could crash the server. (Bug#21676)
- Errors could be generated during the execution of certain prepared statements that ran queries on partitioned tables. (Bug#21658)
- The presence of a subquery in the `ON` clause of a join in a view definition prevented the `MERGE` algorithm from being used for the view in cases where it should be allowed. (Bug#21646)
- When records are merged from the insert buffer and the page needs to be reorganized, `InnoDB` used incorrect column length information when interpreting the records of the page. This caused a server crash due to apparent corruption of secondary indexes in `ROW_FORMAT=COMPACT` that contain prefix indexes of fixed-length columns. Data files should not be corrupted, but the crash was likely to repeat every time the server was restarted. (Bug#21638)
- For character sets having a `mbmaxlen` value of 2, any `ALTER TABLE` statement changed `TEXT` columns to `MEDIUMTEXT`. (Bug#21620)
- `mysql` displayed an empty string for `NULL` values. (Bug#21618)
- Selecting from a `MERGE` table could result in a server crash if the underlying tables had fewer indexes than the `MERGE` table itself. (Bug#21617, Bug#22937)
- A loaded storage engine plugin did not load after a server restart. (Bug#21610)
- For `INSERT ... ON DUPLICATE KEY UPDATE`, use of `VALUES(col_name)` within the `UPDATE` clause sometimes was handled incorrectly. (Bug#21555)
- Subqueries with aggregate functions but no `FROM` clause could return incorrect results. (Bug#21540)
- `mysqldump` incorrectly tried to use `LOCK TABLES` for tables in the `INFORMATION_SCHEMA` database. (Bug#21527)
- The server could crash for the second execution of a function containing a `SELECT` statement that uses an aggregating `IN` subquery. (Bug#21493)

- Memory overruns could occur for certain kinds of subqueries. ([Bug#21477](#))
- A `DATE` can be represented as an integer (such as `20060101`) or as a string (such as `'2006.01.01'`). When a `DATE` (or `TIME`) column is compared in one `SELECT` against both representations, constant propagation by the optimizer led to comparison of `DATE` as a string against `DATE` as an integer. This could result in integer comparisons such as `2006` against `20060101`, erroneously producing a false result. ([Bug#21475](#))
- `myisam_ftdump` produced bad counts for common words. ([Bug#21459](#))
- Adding `ORDER BY` to a `SELECT DISTINCT(expr)` query could produce incorrect results. ([Bug#21456](#))
- The URL into the online manual that is printed in the stack trace message by the server was out of date. ([Bug#21449](#))
- Database and table names have a maximum length of 64 characters (even if they contain multi-byte characters), but were truncated to 64 bytes.

**Note**

An additional fix was made in MySQL 5.1.18.

([Bug#21432](#))

- With `max_sp_recursion` set to 0, a stored procedure that executed a `SHOW CREATE PROCEDURE` statement for itself triggered a recursion limit exceeded error, though the statement involves no recursion. ([Bug#21416](#))
- After `FLUSH TABLES WITH READ LOCK` followed by `UNLOCK TABLES`, attempts to drop or alter a stored routine failed with an error that the routine did not exist, and attempts to execute the routine failed with a lock conflict error. ([Bug#21414](#))
- On 64-bit Windows, a missing table generated error 1017, not the correct value of 1146. ([Bug#21396](#))
- Table aliases in multiple-table `DELETE` statements sometimes were not resolved. ([Bug#21392](#))
- The optimizer sometimes produced an incorrect row-count estimate after elimination of `const` tables. This resulted in choosing extremely inefficient execution plans in some cases when distribution of data in joins were skewed. ([Bug#21390](#))
- For multiple-table `UPDATE` statements, storage engines were not notified of duplicate-key errors. ([Bug#21381](#))
- Using relative paths for `DATA DIRECTORY` or `INDEX DIRECTORY` with a partitioned table generated a warning rather than an error, and caused “junk” files to be created in the server's data directory. ([Bug#21350](#))
- Using `EXPLAIN PARTITIONS` with a query on a table whose partitioning expression was based on the value of a `DATE` column could sometimes cause the server to crash. ([Bug#21339](#))
- The feature of being able to recover a temporary table named `#sql_id` in InnoDB by creating a table named `rsql_id_recover_innodb_tmp_table` was broken by the introduction of the new identifier encoding in MySQL 5.1.6 ([Bug#21313](#))
- It was possible for a stored routine with a non-`latin1` name to cause a stack overrun. ([Bug#21311](#))
- A query result could be sorted improperly when using `ORDER BY` for the second table in a join. ([Bug#21302](#))
- Query results could be incorrect if the `WHERE` clause contained `t.key_part NOT IN (val_list)`, where `val_list` is a list of more than 1000 constants. ([Bug#21282](#))
- Queries that used the `index_merge` and `sort_union` methods to access an InnoDB table could produce inaccurate results. This issue was introduced in MySQL 5.1.10 when a new handler and bitmap interface was implemented. ([Bug#21277](#))
- For user-defined functions created with `CREATE FUNCTION`, the `DEFINER` clause is not legal, but no error was generated. ([Bug#21269](#))
- The `SELECT` privilege was required for an insert on a view, instead of the `INSERT` privilege. ([Bug#21261](#))  
This regression was introduced by [Bug#20989](#).
- `mysql_config --libmysqld-libs` did not produce any SSL options necessary for linking `libmysqld` with SSL support enabled. ([Bug#21239](#))
- Subqueries on `INFORMATION_SCHEMA` tables could erroneously return an empty result. ([Bug#21231](#))
- `mysql_upgrade` created temporary files in a possibly insecure way. ([Bug#21224](#))

- When `DROP DATABASE` or `SHOW OPEN TABLES` was issued while concurrently in another connection issuing `DROP TABLE`, `RENAME TABLE`, `CREATE TABLE LIKE` or any other statement that required a name lock, the server crashed. (Bug#21216, Bug#19403)
- The `--master-data` option for `mysqldump` requires certain privileges, but `mysqldump` generated a truncated dump file without producing an appropriate error message or exit status if the invoking user did not have those privileges. (Bug#21215)
- Using `ALTER TABLE ... REORGANIZE PARTITIONS` to reduce the number of subpartitions to 1 caused the server to crash. (Bug#21210)
- In the package of pre-built time zone tables that is available for download at <http://dev.mysql.com/downloads/timezones.html>, the tables now explicitly use the `utf8` character set so that they work the same way regardless of the system character set value. (Bug#21208)
- Under heavy load (executing more than 1024 simultaneous complex queries), a problem in the code that handles internal temporary tables could lead to writing beyond allocated space and memory corruption.  
  
Use of more than 1024 simultaneous cursors server wide also could lead to memory corruption. This applies to both stored procedure cursors and C API cursors. (Bug#21206)
- When run with the `--use-threads` option, `mysqlimport` returned a random exit code. (Bug#21188)
- A subquery that uses an index for both the `WHERE` and `ORDER BY` clauses produced an empty result. (Bug#21180)
- Running `SHOW TABLE STATUS` on any InnoDB table having at least one record could crash the server. Note that this was not due to any issue in the InnoDB storage engine, but rather with `AUTO_INCREMENT` handling in the partitioning code — however, the table did not have to have an `AUTO_INCREMENT` column for the bug to manifest. (Bug#21173)
- Some prepared statements caused a server crash when executed a second time. (Bug#21166)
- The optimizer assumed that if `(a=x AND b=x)` is true, `(a=x AND b=x) AND a=b` is also true. But that is not always so if `a` and `b` have different data types. (Bug#21159)
- Some `ALTER TABLE` statements affecting a table's subpartitioning could hang. (Bug#21143)
- Certain malformed `INSERT` statements could crash the `mysql` client. (Bug#21142)
- `SHOW INNODB STATUS` contained some duplicate output. (Bug#21113)
- InnoDB was slow with more than 100,000 `.idb` files. (Bug#21112)
- Creating a `TEMPORARY` table with the same name as an existing table that was locked by another client could result in a lock conflict for `DROP TEMPORARY TABLE` because the server unnecessarily tried to acquire a name lock. (Bug#21096)
- Performing an `INSERT` on a view that was defined using a `SELECT` that specified a collation and a column alias caused the server to crash. (Bug#21086)
- Incorrect results could be obtained from re-execution of a parametrized prepared statement or a stored routine with a `SELECT` that uses `LEFT JOIN` with a second table having only one row. (Bug#21081)
- `ALTER VIEW` did not retain existing values of attributes that had been originally specified but were not changed in the `ALTER VIEW` statement. (Bug#21080)
- The `mysam_stats_method` variable was mishandled when set from an option file or on the command line. (Bug#21054)
- With `query_cache_type` set to 0, `RESET QUERY CACHE` was very slow and other threads were blocked during the operation. Now a cache reset is faster and non-blocking. (Bug#21051)
- `mysql` crashed for very long arguments to the `connect` command. (Bug#21042)
- When creating a table using `CREATE ... SELECT` and a stored procedure, there would be a mismatch between the binary log and transaction cache which would cause a server crash. (Bug#21039)
- A query using `WHERE column = constant OR column IS NULL` did not return consistent results on successive invocations. The `column` in each part of the `WHERE` clause could be either the same column, or two different columns, for the effect to be observed. (Bug#21019)
- `mysqldump` sometimes did not select the correct database before trying to dump views from it, resulting in an empty result set that caused `mysqldump` to die with a segmentation fault. (Bug#21014)
- Performance during an import on a table with a trigger that called a stored procedure was severely degraded. (Bug#21013)

- `mysql_upgrade` produced a malformed `upgrade_defaults` file by overwriting the `[client]` group header with a `password` option. This prevented `mysqlcheck` from running successfully when invoked by `mysql_upgrade`. (Bug#21011)

- A query of the form shown here caused the server to crash:

```
SELECT * FROM t1 NATURAL JOIN (
  t2 JOIN (
    t3 NATURAL JOIN t4,
    t5 NATURAL JOIN t6
  )
  ON (t3.id3 = t2.id3 AND t5.id5 = t2.id5)
);
```

(Bug#21007)

- A `SELECT` that used a subquery in the `FROM` clause that did not select from a table failed when the subquery was used in a join. (Bug#21002)
- `REPLACE . . . SELECT` for a view required the `INSERT` privilege for tables other than the table being modified. (Bug#20989)
- `STR_TO_DATE()` sometimes would return `NULL` if the `%D` format specifier was not the last specifier in the format string. (Bug#20987)
- A query using `WHERE NOT (column < ANY (subquery))` yielded a different result from the same query using the same `column` and `subquery` with `WHERE (column > ANY (subquery))`. (Bug#20975)
- Under certain circumstances, `AVG(key_val)` returned a value but `MAX(key_val)` returned an empty set due to incorrect application of `MIN()/MAX()` optimization. (Bug#20954)
- Closing of temporary tables failed if binary logging was not enabled. (Bug#20919)
- Use of zero-length variable names caused a server crash. (Bug#20908)
- Building `mysql` on Windows with CMake 2.4 would fail to create `libmysqld` correctly. (Bug#20907)
- Creating a partitioned table that used the `InnoDB` storage engine and then restarting `mysqld` with `--skip-innodb` caused MySQL to crash. (Bug#20871)
- For certain queries, the server incorrectly resolved a reference to an aggregate function and crashed. (Bug#20868)
- If the binary logging format was changed between the times when a locked table was modified and when it was unlocked, the binary log contents were incorrect. (Bug#20863)
- It was possible to provide the `ExtractValue()` function with input containing “tags” that were not valid XML; for example, it was possible to use tag names beginning with a digit, which are disallowed by the W3C's XML 1.0 specification. Such cases caused the function to return “junk” output rather than an error message signalling the user as to the true nature of the problem. (Bug#20854)
- `InnoDB` (Partitioning): Updating an `InnoDB` table using `HASH` partitioning with a composite primary key would cause the server to hang. (Bug#20852)
- `mysqldump` did not add version-specific comments around `WITH PARSER` and `TABLESPACE . . . STORAGE DISK` clauses for `CREATE TABLE` statements, causing dump files from servers where these features were in use to fail when loaded into older servers. (Bug#20841)
- For multiple `INSERT DELAYED` statements executed in a batch by the delayed-insert handler thread, not all rows were written to the binary log. (Bug#20821)
- The `ExtractValue()` function did not accept XML tag names containing a period (`.`) character. (Bug#20795)
- Using aggregate functions in subqueries yielded incorrect results under certain circumstances due to incorrect application of `MIN()/MAX()` optimization. (Bug#20792)
- On Windows, inserting into a `MERGE` table after renaming an underlying `MyISAM` table caused a server crash. (Bug#20789)
- Within stored routines, some error messages were printed incorrectly. A non-null-terminated string was passed to a message-printing routine that expected a null-terminated string. (Bug#20778)
- Merging multiple partitions having subpartitions into a single partition with subpartitions, or splitting a single partition having subpartitions into multiple partitions with subpartitions, could sometimes crash the server. These issues were associated with a

failure reported in the `partition_range` test. ([Bug#20767](#), [Bug#20893](#), [Bug#20766](#), [Bug#21357](#))

- Searches against a `ZEROFILL` column of a partitioned table could fail when the `ZEROFILL` column was part of the table's partitioning key. ([Bug#20733](#))
- If a column definition contained a character set declaration, but a `DEFAULT` value began with an introducer, the introducer character set was used as the column character set. ([Bug#20695](#))
- An `UPDATE` that referred to a key column in the `WHERE` clause and activated a trigger that modified the column resulted in a loop. ([Bug#20670](#))
- Issuing a `SHOW CREATE FUNCTION` or `SHOW CREATE PROCEDURE` statement without sufficient privileges could crash the `mysql` client. ([Bug#20664](#))
- `INSERT DELAYED` did not honor `SET INSERT_ID` or the `auto_increment_*` system variables. ([Bug#20627](#), [Bug#20830](#))
- A buffer overwrite error in Instance Manager caused a crash. ([Bug#20622](#))
- Loading a plugin caused any an existing plugin with the same name to be lost. ([Bug#20615](#))
- A query selecting records from a single partition of a partitioned table and using `ORDER BY ic DESC` (where `ic` represents an indexed column) could cause errors or crash the server. ([Bug#20583](#))
- If the `auto_increment_offset` setting causes MySQL to generate a value larger than the column's maximum possible value, the `INSERT` statement is accepted in strict SQL mode, whereas but should fail with an error. ([Bug#20573](#))
- In a view defined with `SQL SECURITY DEFINER`, the `CURRENT_USER()` function returned the invoker, not the definer. ([Bug#20570](#))
- The `fill_help_tables.sql` file did not contain a `SET NAMES 'utf8'` statement to indicate its encoding. This caused problems for some settings of the MySQL character set such as `big5`. ([Bug#20551](#))
- Scheduled events that invoked stored procedures executing DDL operations on partitioned tables could crash the server. ([Bug#20548](#))
- Users who had the `SHOW VIEW` privilege for a view and privileges on one of the view's base tables could not see records in `INFORMATION_SCHEMA` tables relating to the base table. ([Bug#20543](#))
- The `fill_help_tables.sql` file did not load properly if the `ANSI_QUOTES` SQL mode was enabled. ([Bug#20542](#))
- The `MD5()`, `SHA1()`, and `ENCRYPT()` functions should return a binary string, but the result sometimes was converted to the character set of the argument. `MAKE_SET()` and `EXPORT_SET()` now use the correct character set for their default separators, resulting in consistent result strings which can be coerced according to normal character set rules. ([Bug#20536](#))
- If a partitioned `InnoDB` table contained an `AUTO_INCREMENT` column, a `SHOW` statement could cause an assertion failure with more than one connection. ([Bug#20493](#))
- Using `EXPLAIN PARTITIONS` with a `UNION` query could crash the server. This could occur whether or not the query actually used any partitioned tables. ([Bug#20484](#))
- Creation of a view as a join of views or tables could fail if the views or tables are in different databases. ([Bug#20482](#))
- `SELECT` statements using `GROUP BY` against a view could have missing columns in the output when there was a trigger defined on one of the base tables for the view. ([Bug#20466](#))
- For connections that required a `SUBJECT` value, a check was performed to verify that the value was correct, but the connection was not refused if not. ([Bug#20411](#))
- `mysql_upgrade` was missing from binary MySQL distributions. ([Bug#20403](#), [Bug#18516](#), [Bug#20556](#))
- Some user-level errors were being written to the server's error log, which is for server errors. ([Bug#20402](#))
- Using `ALTER TABLE ... ENGINE = x`, where `x` was not a storage engine supported by the server, would cause `mysqld` to crash. ([Bug#20397](#))
- User names have a maximum length of 16 characters (even if they contain multi-byte characters), but were being truncated to 16 bytes. ([Bug#20393](#))
- Some queries using `ORDER BY ... DESC` on subpartitioned tables could crash the server. ([Bug#20389](#))

- `mysqlslap` did not enable the `CLIENT_MULTI_RESULTS` flag when connecting, which is necessary for executing stored procedures. (Bug#20365)
- Queries using an indexed column as the argument for the `MIN()` and `MAX()` functions following an `ALTER TABLE ... DISABLE KEYS` statement returned `GOT ERROR 124 FROM STORAGE ENGINE` until `ALTER TABLE ... ENABLE KEYS` was run on the table. (Bug#20357)
- When a statement used a stored function that inserted into an `AUTO_INCREMENT` column, the generated `AUTO_INCREMENT` value was not written into the binary log, so a different value could in some cases be inserted on the slave. (Bug#20341)
- Partitions were represented internally as the wrong data type, which led in some cases to failures of queries such as `SELECT COUNT(*) FROM INFORMATION_SCHEMA.PARTITIONS WHERE PARTITION_NAME = 'partition_name'`. (Bug#20340)
- `PROCEDURE ANALYSE()` returned incorrect values of `M FLOAT(M, D)` and `DOUBLE(M, D)`. (Bug#20305)
- Defining a table partitioned by `LIST` with a single `PARTITION ... VALUES IN (NULL)` clause could lead to server crashes, particularly with queries having `WHERE` conditions comparing the partitioning key with a constant. (Bug#20268, Bug#19801)
- Partition pruning could cause incorrect results from queries, such missing rows, when the partitioning expression relied on a `BIGINT UNSIGNED` column. (Bug#20257)
- For a `MyISAM` table locked with `LOCK TABLES ... WRITE`, queries optimized using the `index_merge` method did not show rows inserted with the lock in place. (Bug#20256)
- `mysqldump` produced a malformed dump file when dumping multiple databases that contained views. (Bug#20221)
- Running `InnoDB` with many concurrent threads could cause memory corruption and a seg fault due to a bug introduced in MySQL 5.1.11. (Bug#20213)
- `SUBSTRING()` results sometimes were stored improperly into a temporary table when multi-byte character sets were used. (Bug#20204)
- The thread for `INSERT DELAYED` rows was maintaining a separate `AUTO_INCREMENT` counter, resulting in incorrect values being assigned if `DELAYED` and non-`DELAYED` inserts were mixed. (Bug#20195)
- The `--default-storage-engine` server option did not work. (Bug#20168)
- For a table having `LINEAR HASH` subpartitions, the `LINEAR` keyword did not appear in the `SUBPARTITION_METHOD` column of the `INFORMATION_SCHEMA.PARTITIONS` table. (Bug#20161)
- For a `DATE` parameter sent via a `MYSQL_TIME` data structure, `mysql_stmt_execute()` zeroed the hour, minute, and second members of the structure rather than treating them as read-only. (Bug#20152)
- `pererror` crashed on Solaris due to `NULL` return value of `strerror()` system call. (Bug#20145)
- `FLUSH TABLES` followed by a `LOCK TABLES` statement to lock a log table and a non-log table caused an infinite loop and high CPU use. Now `FLUSH TABLES` ignores log tables. To flush the log tables, use `FLUSH LOGS` instead. (Bug#20139)
- On Linux, `libmysqlclient` when compiled with yaSSL using the `icc` compiler had a spurious dependency on C++ libraries. (Bug#20119)
- For an `ENUM` column that used the `ucs2` character set, using `ALTER TABLE` to modify the column definition caused the default value to be lost. (Bug#20108)
- For `mysql`, escaping with backslash sometimes did not work. (Bug#20103)
- Queries on tables that were partitioned by `KEY` and had a `VARCHAR` column as the partitioning key produced an empty result set. (Bug#20086)
- A number of dependency issues in the RPM `bench` and `test` packages caused installation of these packages to fail. (Bug#20078)
- Use of `MIN()` or `MAX()` with `GROUP BY` on a `ucs2` column could cause a server crash. (Bug#20076)
- `mysqld --flush` failed to flush `MyISAM` table changes to disk following an `UPDATE` statement for which no updated column had an index. (Bug#20060)
- In MySQL 5.1.11, the `--with-openssl` and `--with-yassl` options were replaced by `--with-ssl`. But no message was issued if the old options were given. Now `configure` produces a message indicating that the new option should be used



and exits. ([Bug#20002](#))

- When a statement is executed that does not generate any rows, an extra table map event and associated binrows event would be generated and written to the binary log. ([Bug#19995](#))
- Join conditions using index prefixes on `utf8` columns of `InnoDB` tables incorrectly ignored rows where the length of the actual value was greater than the length of the index prefix. ([Bug#19960](#))
- `AUTHORS` and `CONTRIBUTORS` were not treated as reserved words. ([Bug#19939](#))
- The `query` command for `mysqltest` did not work. ([Bug#19890](#))
- Identifiers with embedded escape characters were not handled correctly by some `SHOW` statements due to some old code that was doing some extra unescaping. ([Bug#19874](#))
- When executing a `SELECT` with `ORDER BY` on a view that is constructed from a `SELECT` statement containing a stored function, the stored function was evaluated too many times. ([Bug#19862](#))
- Using `SELECT` on a corrupt `MyISAM` table using the dynamic record format could cause a server crash. ([Bug#19835](#))
- Using cursors with `READ COMMITTED` isolation level could cause `InnoDB` to crash. ([Bug#19834](#))
- `CREATE DATABASE`, `RENAME DATABASE`, and `DROP DATABASE` could deadlock in cases where there was a global read lock. ([Bug#19815](#))
- The yaSSL library bundled with `libmysqlclient` had some conflicts with OpenSSL. Now macros are used to rename the conflicting symbols to have a prefix of `ya`. ([Bug#19810](#))
- The `WITH CHECK OPTION` was not enforced when a `REPLACE` statement was executed against a view. ([Bug#19789](#))
- Multiple-table updates with `FEDERATED` tables could cause a server crash. ([Bug#19773](#))
- On 64-bit systems, use of the `cp1250` character set with a primary key column in a `LIKE` clause caused a server crash for patterns having letters in the range 128..255. ([Bug#19741](#))
- `make install` tried to build files that should already have been built by `make all`, causing a failure if installation was performed using a different account than the one used for the initial build. ([Bug#19738](#))
- `InnoDB` unlocked its data directory before committing a transaction, potentially resulting in non-recoverable tables if a server crash occurred before the commit. ([Bug#19727](#))
- An issue with yaSSL prevented Connector/J clients from connecting to the server using a certificate. ([Bug#19705](#))
- For a `MyISAM` table with a `FULLTEXT` index, compression with `myisampack` or a check with `myisamchk` after compression resulted in table corruption. ([Bug#19702](#))
- The `ENGINE` clause was displayed in the output of `SHOW CREATE TABLE` for partitioned tables when the SQL mode included `no_table_options`. ([Bug#19695](#))
- A cast problem caused incorrect results for prepared statements that returned float values when MySQL was compiled with `gcc 4.0`. ([Bug#19694](#))
- `EXPLAIN PARTITIONS` would produce illegible output in the `partitions` column if the length of text to be displayed in that column was too long. This could occur when very many partitions were defined for the table, partitions were given very long names, or due to a combination of the two. ([Bug#19684](#))
- The `mysql_list_fields()` C API function returned the incorrect table name for views. ([Bug#19671](#))
- If a query had a condition of the form `tableX.key = tableY.key`, which participated in equality propagation and also was used for `ref` access, then early `ref`-access `NULL` filtering was not performed for the condition. This could make query execution slower. ([Bug#19649](#))
- Re-execution of a prepared multiple-table `DELETE` statement that involves a trigger or stored function can result in a server crash. ([Bug#19634](#))
- File size specifications for `InnoDB` data files were case sensitive. ([Bug#19609](#))
- `CHECK TABLE` on a `MyISAM` table briefly cleared its `AUTO_INCREMENT` value, while holding only a read lock. Concurrent inserts to that table could use the wrong `AUTO_INCREMENT` value. `CHECK TABLE` no longer modifies the `AUTO_INCREMENT` value. ([Bug#19604](#))

- Some yaSSL public function names conflicted with those from OpenSSL, causing conflicts for applications that linked against both OpenSSL and a version of `libmysqlclient` that was built with yaSSL support. The yaSSL public functions now are renamed to avoid this conflict. (Bug#19575)
- In the `INFORMATION_SCHEMA.FILES` table, the `INITIAL_SIZE`, `MAXIMUM_SIZE`, and `AUTOEXTEND_SIZE` columns incorrectly were being stored as `VARCHAR` rather than `BIGINT`. (Bug#19544)
- InnoDB failed to increment the `handler_read_prev` counter. (Bug#19542)
- Portions of statements related to partitioning were not surrounded by version-specific comments by `mysqldump`, breaking backward compatibility for dump files. (Bug#19488)
- Repeated `DROP TABLE` statements in a stored procedure could sometimes cause the server to crash. (Bug#19399)
- Renaming a database to itself caused a server crash. (Bug#19392)
- Race conditions on certain platforms could cause the Instance Manager to fail to initialize. (Bug#19391)
- When not running in strict mode, the server failed to convert the invalid years portion of a `DATE` or `DATETIME` value to `'0000'` when inserting it into a table.

**Note**

This fix was reverted in MySQL 5.1.18.

(Bug#19370)

See also Bug#25301.

- Use of the `--no-pager` option caused `mysql` to crash. (Bug#19363)
- Multiple calls to a stored procedure that altered a partitioned `MyISAM` table would cause the server to crash. (Bug#19309)
- `ALTER TABLE ... COALESCE PARTITION` did not delete the files associated with the partitions that were removed. (Bug#19305)
- Adding an index to a partitioned table that had been created using `AUTO_INCREMENT = value` caused the `AUTO_INCREMENT` value to be reset. (Bug#19281)
- Multiple-table `DELETE` statements containing a subquery that selected from one of the tables being modified caused a server crash. (Bug#19225)
- The final parenthesis of a `CREATE INDEX` statement occurring in a stored procedure was omitted from the binary log when the stored procedure was called. (Bug#19207)
- An `ALTER TABLE` operation that does not need to copy data, when executed on a table created prior to MySQL 4.0.25, could result in a server crash for subsequent accesses to the table. (Bug#19192)
- SSL connections using yaSSL on OpenBSD could fail. (Bug#19191)
- `ALTER TABLE ... REBUILD PARTITION` could cause the server to hang or crash. (Bug#19122)
- Using `ALTER TABLE` on a subpartitioned table caused the server to crash. (Bug#19067)
- Trying to execute a query having a `WHERE` clause using `int_col = "string_value" OR int_col IS NULL` on a partitioned table whose partitioning or subpartitioning function used the integer column `int_col` would crash the server. (Bug#19055)
- A `SELECT` with a subquery that was bound to the outer query over multiple columns returned different results when a constant was used instead of one of the dependant columns. (Bug#18925)
- It was possible using `ALTER EVENT ... RENAME ...` to move an event to a database on which the user did not have the `EVENT` privilege. (Bug#18897)
- When used in the `DO` clause of a `CREATE EVENT` statement, the statements `CREATE EVENT`, `CREATE FUNCTION`, and `CREATE PROCEDURE` caused the server to crash. (These statements are not permitted inside `CREATE EVENT`.) (Bug#18896, Bug#16409)
- `BIT` columns in a table could cause joins that use the table to fail. (Bug#18895)
- The build process incorrectly tried to overwrite `sql/lex_hash.h`. This caused the build to fail when using a shadow link



- tree pointing to original sources that were owned by another account. ([Bug#18888](#))
- Setting `myisam_repair_threads` caused any repair operation on a `MyISAM` table to fail to update the cardinality of indexes, instead making them always equal to 1. ([Bug#18874](#))
  - The MySQL server startup script `/etc/init.d/mysql` (created from `mysql.server`) is now marked to ensure that the system services `ybind`, `nscd`, `ldap`, and `NTP` are started first (if these are configured on the machine). ([Bug#18810](#))
  - `InnoDB`: Quoted Unicode identifiers were not handled correctly. This included names of tables, columns, and foreign keys. ([Bug#18800](#))
  - Intermediate tables created during the execution of an `ALTER TABLE` statement were visible in the output of `SHOW TABLES`. ([Bug#18775](#))
  - `FEDERATED` tables raised invalid duplicate key errors when attempting on one server to insert rows having the same primary key values as rows that had been deleted from the linked table on the other server. ([Bug#18764](#))
  - Memory used by scheduled events was not freed when the events were dropped. ([Bug#18683](#))
  - The implementation for `UNCOMPRESS()` did not indicate that it could return `NULL`, causing the optimizer to do the wrong thing. ([Bug#18539](#))
  - Referring to a stored function qualified with the name of one database and tables in another database caused a “table doesn't exist” error. ([Bug#18444](#))
  - Identifiers could not contain bytes with a value of 255, though that should be allowed as of the identifier-encoding changes made in MySQL 5.1.6. ([Bug#18396](#))
  - Triggers on tables in the `mysql` database caused a server crash. Triggers for tables in this database now are disallowed. ([Bug#18361](#), [Bug#18005](#))
  - Incorrect type aggregation for `IN()` and `CASE` expressions could lead to an incorrect result. ([Bug#18360](#))
  - The length of the pattern string prefix for `LIKE` operations was calculated incorrectly for multi-byte character sets. As a result, the scanned range was wider than necessary if the prefix contained any multi-byte characters, and rows could be missing from the result set. ([Bug#18359](#), [Bug#16674](#))
  - On Windows, corrected a crash stemming from differences in Visual C runtime library routines from POSIX behavior regarding invalid file descriptors. ([Bug#18275](#))
  - Linking the `pthread` library to single-threaded MySQL libraries caused `dlopen()` to fail at runtime on HP-UX. ([Bug#18267](#))
  - The source distribution failed to compile when configured with the `--with-libwrap` option. ([Bug#18246](#))
  - On Windows, terminating `mysqld` with Control-C could result in a crash during shutdown. ([Bug#18235](#))
  - Selecting data from a `MEMORY` table with a `VARCHAR` column and a `HASH` index over it returned only the first row matched. ([Bug#18233](#))
  - The use of `MIN()` and `MAX()` on columns with an index prefix produced incorrect results in some queries. ([Bug#18206](#))
  - A `UNION` over more than 128 `SELECT` statements that use an aggregate function failed. ([Bug#18175](#))
  - The optimizer did not take advantage of indexes on columns used for the second or third arguments of `BETWEEN`. ([Bug#18165](#))
  - Performing `INSERT ... SELECT ... JOIN ... USING` without qualifying the column names caused `ERROR 1052 "column 'x' in field list is ambiguous"` even in cases where the column references were unambiguous. ([Bug#18080](#))
  - An update that used a join of a table to itself and modified the table on both sides of the join reported the table as crashed. ([Bug#18036](#))
  - Race conditions on certain platforms could cause the Instance Manager to try to restart the same instance multiple times. ([Bug#18023](#))
  - Changing the definition of a `DECIMAL` column with `ALTER TABLE` caused loss of column values. ([Bug#18014](#))
  - For table-format output, `mysql` did not always calculate columns widths correctly for columns containing multi-byte characters in the column name or contents. ([Bug#17939](#))

- The character set was not being properly initialized for `CAST()` with a type like `CHAR(2) BINARY`, which resulted in incorrect results or even a server crash. (Bug#17903)
- Checking a `MyISAM` table (using `CHECK TABLE`) having a spatial index and only one row would wrongly indicate that the table was corrupted. (Bug#17877)
- For a reference to a non-existent index in `FORCE INDEX`, the error message referred to a column, not an index. (Bug#17873)
- A stored procedure that created and invoked a prepared statement was not executed when called in a `mysqld` init-file. (Bug#17843)
- It is possible to create `MERGE` tables into which data cannot be inserted (by not specifying a `UNION` clause. However, when an insert was attempted, the error message was confusing. Now an error occurs indicating that the table is read-only. (Bug#17766)
- Attempting to insert a string of greater than 4096 bytes into a `FEDERATED` table resulted in the error `ERROR 1296 (HY000) AT LINE 2: GOT ERROR 10000 'ERROR ON REMOTE SYSTEM: 1054: UNKNOWN COLUMN 'STRING-VALUE' FROM FEDERATED`. This error was raised regardless of the type of column involved (`VARCHAR`, `TEXT`, and so on.) (Bug#17608)
- If a file name was specified for the `--log` or `--log-slow-queries` options but the server was logging to tables and not files, the server produced no error message. (Bug#17599)
- If the general log table reached a large enough file size (27GB), `SELECT COUNT(*)` on the table caused a server crash. (Bug#17589)
- Using the extended syntax for `TRIM()` — that is, `TRIM(... FROM ...)` — in a `SELECT` statement defining a view caused an invalid syntax error when selecting from the view. (Bug#17526)
- Use of the `--prompt` option or `prompt` command caused `mysql` to be unable to connect to the Instance Manager. (Bug#17485)
- `OPTIMIZE TABLE` and `REPAIR TABLE` yielded incorrect messages or warnings when used on partitioned tables. (Bug#17455)
- `mysqldump` would not dump views that had become invalid because a table named in the view definition had been dropped. Instead, it quit with an error message. Now you can specify the `--force` option to cause `mysqldump` to keep going and write an SQL comment containing the view definition to the dump output. (Bug#17371)
- `N'xxx'` and `_utf8'xxx'` were not treated as equivalent because `N'xxx'` failed to unescape backslashes (`\`) and doubled apostrophe/single quote characters (`'`). (Bug#17313)
- Following a failed attempt to add an index to an `ARCHIVE` table, it was no longer possible to drop the database in which the table had been created. (Bug#17310)
- Assignments of values to variables of type `TEXT` were handled incorrectly in stored routines. (Bug#17225)
- Views created from prepared statements inside of stored procedures were created with a definition that included both `SQL_CACHE` and `SQL_NO_CACHE`. (Bug#17203)
- `mysqldump` wrote an extra pair of `DROP DATABASE` and `CREATE DATABASE` statements if run with the `--add-drop-database` option and the database contained views. (Bug#17201)
- A `TABLE ... DOESN'T EXIST` error could occur for statements that called a function defined in another database. (Bug#17199)
- A prepared statement that altered partitioned table within a stored procedure failed with the error `UNKNOWN PREPARED STATEMENT HANDLER`. (Bug#17138)
- `myisam_ftdump` would fail when trying to open a MyISAM index file that you did not have write permissions to access, even though the command would only be reading from the file. (Bug#17122)
- `ALTER TABLE` on a table created prior to 5.0.3 would cause table corruption if the `ALTER TABLE` did one of the following:
  - Change the default value of a column.
  - Change the table comment.
  - Change the table password.(Bug#17001)

- For statements that have a `DEFINER` clause such as `CREATE TRIGGER` or `CREATE VIEW`, long user names or host names could cause a buffer overflow. (Bug#16899)
- The `PASSWORD()` function returned invalid results when used in some `UNION` queries. (Bug#16881)
- `ORDER BY RAND() LIMIT 1` always set a user variable to the last possible value from the table. (Bug#16861)
- Queries containing a subquery that used aggregate functions could return incorrect results. (Bug#16792)
- Concatenating the results of multiple constant subselects produced incorrect results. (Bug#16716)
- When performing a `GROUP_CONCAT()`, the server transformed `BLOB` columns `VARCHAR` columns, which could cause erroneous results when using Connector/J and possibly other MySQL APIs. (Bug#16712)
- Stored procedures did not use the character set defined for the database in which they were created. (Bug#16676)
- Some server errors were not reported to the client, causing both to try to read from the connection until a hang or crash resulted. (Bug#16581)
- If the files for an open table were removed at the OS level (external to the server), the server exited with an assertion failure. (Bug#16532)
- On Windows, a definition for `mysql_set_server_option()` was missing from the C client library. (Bug#16513)
- `mysqlcheck` tried to check views instead of ignoring them. (Bug#16502)
- Updating a column of a `FEDERATED` table to `NULL` sometimes failed. (Bug#16494)
- For `SELECT ... FOR UPDATE` statements that used `DISTINCT` or `GROUP BY` over all key parts of a unique index (or primary key), the optimizer unnecessarily created a temporary table, thus losing the linkage to the underlying unique index values. This caused a `Result set not updatable` error. (The temporary table is unnecessary because under these circumstances the distinct or grouped columns must also be unique.) (Bug#16458)
- A scheduled event that took longer to execute than the length of time scheduled between successive executions could “skip” executions. For example, an event defined with `EVERY 1 SECOND` — but which required longer than 1 second to complete — might be executed only once every 2 seconds. (Bug#16417)
- A subselect used in the `ON SCHEDULE` clause of a `CREATE EVENT` or `ALTER EVENT` statement caused the server to crash, rather than producing an error as expected. (Bug#16394)
- Grant table modifications sometimes did not refresh the in-memory tables if the host name was `' '` or not specified. (Bug#16297)
- A subquery in the `WHERE` clause of the outer query and using `IN` and `GROUP BY` returned an incorrect result. (Bug#16255)
- A query could produce different results with and without an index, if the `WHERE` clause contained a range condition that used an invalid `DATETIME` constant. (Bug#16249)
- `TIMESTAMPDIFF()` examined only the date and ignored the time when the requested difference unit was months or quarters. (Bug#16226)
- Using tables from MySQL 4.x in MySQL 5.x, in particular those with `VARCHAR` fields and using `INSERT DELAYED` to update data in the table would result in either data corruption or a server crash. (Bug#16218, Bug#17294, Bug#16611)
- The value returned by a stored function returning a string value was not of the declared character set. (Bug#16211)
- The `index_merge/Intersection` optimizer could experience a memory overrun when the number of table columns covered by an index was sufficiently large, possibly resulting in a server crash. (Bug#16201)
- Row equalities (such as `WHERE (a,b) = (c,d)`) were not taken into account by the optimizer, resulting in slow query execution. Now they are treated as conjunctions of equalities between row elements. (Bug#16081)
- Some memory leaks in the `libmysqld` embedded server were corrected. (Bug#16017)
- Values greater than 2 gigabytes used in the `VALUES LESS THAN` clause of a table partitioned by `RANGE` were treated as negative numbers. (Bug#16002)
- A `CREATE TABLE` that produced a `THE PARTITION FUNCTION RETURNS THE WRONG TYPE` error also caused an `INCORRECT INFORMATION IN FILE` to be printed to `STDERR`, and a junk file to be left in the database directory. (Bug#16000)
- The `max_length` metadata value for columns created from `CONCAT()` could be incorrect when the collation of an argument

differed from the collation of the `CONCAT()` itself. In some contexts such as `UNION`, this could lead to truncation of the column contents. (Bug#15962)

- When `NOW()` was used in a `BETWEEN` clause of the definition for a view, it was replaced with a constant in the view. (Bug#15950)
- The server's handling of the number of partitions or subpartitions specified in a `PARTITIONS` or `SUBPARTITIONS` clause was changed. Beginning with this release, the number of partitions must:
  - be a positive, nonzero integer
  - not have any leading zeroes
  - not be an expression

Also beginning with this version, no attempt is made to convert, truncate, or evaluate a `PARTITIONS` or `SUBPARTITIONS` value; instead, the `CREATE TABLE` or `ALTER TABLE` statement containing the `PARTITIONS` or `SUBPARTITIONS` clause now fails with an appropriate error message. (Bug#15890)

- Long multiple-row `INSERT` statements could take a very long time for some multi-byte character sets. (Bug#15811)
- The C API failed to return a status message when invoking a stored procedure. (Bug#15752)
- `mysqlimport` sends a `set @@character_set_database=binary` statement to the server, but this is not understood by pre-4.1 servers. Now `mysqlimport` encloses the statement within a `/*!40101 ... */` comment so that old servers will ignore it. (Bug#15690)
- `DELETE` with `LEFT JOIN` for `InnoDB` tables could crash the server if `innodb_locks_unsafe_for_binlog` was enabled. (Bug#15650)
- `BIN()`, `OCT()`, and `CONV()` did not work with `BIT` values. (Bug#15583)
- Nested natural joins worked executed correctly when executed as a non-prepared statement could fail with an `Unknown column 'col_name' in 'field list'` error when executed as a prepared statement, due to a name resolution problem. (Bug#15355)
- The `MD5()` and `SHA()` functions treat their arguments as case-sensitive strings. But when they are compared, their arguments were compared as case-insensitive strings, which leads to two function calls with different arguments (and thus different results) compared as being identical. This can lead to a wrong decision made in the range optimizer and thus to an incorrect result set. (Bug#15351)
- Invalid escape sequences in option files caused MySQL programs that read them to abort. (Bug#15328)
- `SHOW GRANTS FOR CURRENT_USER` did not return definer grants when executed in `DEFINER` context (such as within a stored procedure defined with `SQL SECURITY DEFINER`), it returned the invoker grants. (Bug#15298)
- The `--collation-server` server option was being ignored. With the fix, if you choose a non-default character set with `--character-set-server`, you should also use `--collation-server` to specify the collation. (Bug#15276)
- Re-executing a stored procedure with a complex stored procedure cursor query could lead to a server crash. (Bug#15217)
- The server crashed if it tried to access a `CSV` table for which the data file had been removed. (Bug#15205)
- When using tables containing `VARCHAR` columns created under MySQL 4.1 with a 5.0 or later server, for some queries the metadata sent to the client could have an empty column name. (Bug#14897)
- An invalid comparison between keys with index prefixes over multi-byte character fields could lead to incorrect result sets if the selected query execution plan used a range scan by an index prefix over a `UTF8` character field. This also caused incorrect results under similar circumstances with many other character sets. (Bug#14896)
- When setting a column to its implicit default value as the result of inserting a `NULL` into a `NOT NULL` column as part of a multi-row insert or `LOAD DATA` operation, the server returned a misleading warning message. (Bug#14770)
- For `BOOLEAN` mode full-text searches on non-indexed columns, `NULL` rows generated by a `LEFT JOIN` caused incorrect query results. (Bug#14708, Bug#25637)
- The parser rejected queries that selected from a table twice using a `UNION` within a subquery. The parser now supports arbitrary subquery, join, and parenthesis operations within `EXISTS` subqueries. A limitation still exists for scalar subqueries: If the subquery contains `UNION`, the first `SELECT` of the `UNION` cannot be within parentheses. For example, `SELECT (SELECT a FROM t1 UNION SELECT b FROM t2)` will work, but `SELECT ((SELECT a FROM t1) UNION (SELECT b FROM t2))` will not. (Bug#14654)

- Using `SELECT` and a table join while running a concurrent `INSERT` operation would join incorrect rows. (Bug#14400)
- Prepared statements caused general log and server memory corruption. (Bug#14346)
- The binary log lacked character set information for table names when dropping temporary tables. (Bug#14157)
- `libmysqld` produced some warnings to `stderr` which could not be silenced. These warnings now are suppressed. (Bug#13717)
- RPM packages had spurious dependencies on Perl modules and other programs. (Bug#13634)
- `InnoDB` locking was improved by removing a gap lock for the case that you try to delete the same row twice within a transaction. (Bug#13544)
- `REPLACE` statements caused activation of `UPDATE` triggers, not `DELETE` and `INSERT` triggers. (Bug#13479)
- The source distribution failed to compile when configured with the `--without-geometry` option. (Bug#12991)
- With settings of `read_buffer_size`  $\geq$  2G and `read_rnd_buffer_size`  $\geq$  2G, `LOAD DATA INFILE` failed with no error message or caused a server crash for files larger than 2GB. (Bug#12982)
- A `B-TREE` index on a `MEMORY` table erroneously reported duplicate entry error for multiple `NULL` values. (Bug#12873)
- Instance Manager didn't close the client socket file when starting a new `mysqld` instance. `mysqld` inherited the socket, causing clients connected to Instance Manager to hang. (Bug#12751)
- On Mac OS X, zero-byte `read()` or `write()` calls to an SMB-mounted file system could return a non-standard return value, leading to data corruption. Now such calls are avoided. (Bug#12620)
- `DATE_ADD()` and `DATE_SUB()` returned `NULL` when the result date was on the day '9999-12-31'. (Bug#12356)
- For very complex `SELECT` statements could create temporary tables that were too large, and for which the temporary files were not removed, causing subsequent queries to fail. (Bug#11824)
- After an `INSERT ... ON DUPLICATE KEY UPDATE` statement that updated an existing row, `LAST_INSERT_ID()` could return a value not in the table. (Bug#11460)
- `USE` did not refresh database privileges when employed to re-select the current database. (Bug#10979)
- The server returns a more informative error message when it attempts to open a `MERGE` table that has been defined to use non-`MyISAM` tables. (Bug#10974)
- The type of the value returned by the `VARIANCE()` function varied according to the type of the input value. The function should always return a `DOUBLE` value. (Bug#10966)
- The same trigger error message was produced under two conditions: The trigger duplicated an existing trigger name, or the trigger duplicated an existing combination of action and event. Now different messages are produced for the two conditions so as to be more informative. (Bug#10946)
- A locking safety check in `InnoDB` reported a spurious error `STORED_SELECT_LOCK_TYPE IS 0 INSIDE ::START_STMT()` for `INSERT ... SELECT` statements in `innodb_locks_unsafe_for_binlog` mode. The safety check was removed. (Bug#10746)
- `CREATE USER` did not respect the 16-character user name limit. (Bug#10668)
- A server or network failure with an open client connection would cause the client to hang even though the server was no longer available.  
  
As a result of this change, the `MYSQL_OPT_READ_TIMEOUT` and `MYSQL_OPT_WRITE_TIMEOUT` options for `mysql_options()` now apply to TCP/IP connections on all platforms. Previously, they applied only to Windows. (Bug#9678)
- `INSERT INTO ... SELECT ... LIMIT 1` could be slow because the `LIMIT` was ignored when selecting candidate rows. (Bug#9676)
- The optimizer could produce an incorrect result after `AND` with collations such as `latin1_german2_ci`, `utf8_czech_ci`, and `utf8_lithianian_ci`. (Bug#9509)
- The `DATA DIRECTORY` table option did not work for `TEMPORARY` tables. (Bug#8706)
- A stored procedure with a `CONTINUE` handler that encountered an error continued to execute a statement that caused an error,

rather with the next statement following the one that caused the error. (Bug#8153)

- For ODBC compatibility, MySQL supports use of `WHERE col_name IS NULL` for `DATE` or `DATETIME` columns that are `NOT NULL`, to allow column values of `'0000-00-00'` or `'0000-00-00 00:00:00'` to be selected. However, this was not working for `WHERE` clauses in `DELETE` statements. (Bug#8143)
- A user variable set to a value selected from an unsigned column was stored as a signed value. (Bug#7498)
- The `--with-collation` option was not honored for client connections. (Bug#7192)
- With `TRADITIONAL` SQL mode, assignment of out-of-bound values and rounding of assigned values was done correctly, but assignment of the same numbers represented as strings sometimes was handled differently. (Bug#6147)
- On an `INSERT` into an updatable but non-insertable view, an error message was issued stating that the view was not updatable. Now the message says the view is not insertable-into. (Bug#5505)
- `EXPLAIN` sometimes returned an incorrect `select_type` for a `SELECT` from a view, compared to the `select_type` for the equivalent `SELECT` from the base table. (Bug#5500)
- Some queries that used `ORDER BY` and `LIMIT` performed quickly in MySQL 3.23, but slowly in MySQL 4.x/5.x due to an optimizer problem. (Bug#4981)
- Incorporated portability fixes into the definition of `__attribute__` in `my_global.h`. (Bug#2717)
- User-created tables having a name beginning with `#sql` were not visible to `SHOW TABLES` and could collide with internal temporary table names. Now they are not hidden and do not collide. (Bug#1405)

## C.2.27. Changes in MySQL 5.1.11 (26 May 2006)

This is a new Beta development release, fixing recently discovered bugs.

This section documents all changes and bug fixes that have been applied since the last official MySQL release. If you would like to receive more fine-grained and personalized *update alerts* about fixes that are relevant to the version and features you use, please consider subscribing to *MySQL Enterprise* (a commercial MySQL offering). For more details please see <http://www.mysql.com/products/enterprise>.

Functionality added or changed:

- **Incompatible Change:** The Event Scheduler can now be in one of three states (on, off, or the new suspended state). In addition, due to the fact that `SET GLOBAL event_scheduler;` now acts in a synchronous rather than asynchronous manner, the Event Scheduler thread can be no longer be activated or deactivated at run time.  
  
For more information regarding these changes, see [Section 18.4.1, “Event Scheduler Overview”](#). (Bug#17619)
- **MySQL Cluster:** The limit of 2048 ordered indexes per cluster has been lifted. There is now no upper limit on the number of ordered indexes (including `AUTO_INCREMENT` columns) that may be used. (Bug#14509)
- Added the `log_queries_not_using_indexes` system variable. (Bug#19616)
- Added the `ssl_ca`, `ssl_capath`, `ssl_cert`, `ssl_cipher`, and `ssl_key` system variables, which display the values given via the corresponding command options. See [Section 5.5.7.3, “SSL Command Options”](#). (Bug#19606)
- The `ENABLE KEYS` and `DISABLE KEYS` clauses for the `ALTER TABLE` statement are now supported for partitioned tables. (Bug#19502)
- Added the `--ssl-verify-server-cert` option to MySQL client programs. This option causes the server's Common Name value in its certificate to be verified against the host name used when connecting to the server, and the connection is rejected if there is a mismatch. Added `MYSQL_OPT_SSL_VERIFY_SERVER_CERT` option for the `mysql_options()` C API function to enable this verification. This feature can be used to prevent man-in-the-middle attacks. Verification is disabled by default. (Bug#17208)
- The default for the `innodb_thread_concurrency` system variable was changed to 8. (Bug#15868)
- It is now possible to use `NEW.var_name` values within triggers as `INOUT` parameters to stored procedures. (Bug#14635)
- Added the `--angel-pid-file` option to `mysqlmanager` for specifying the file in which the angel process records its process ID when `mysqlmanager` runs in daemon mode. (Bug#14106)
- Previously, to build MySQL from source with SSL support enabled, you would invoke `configure` with either the -



`-with-openssl` or `--with-yassl` option. Those options both have been replaced by the `--with-ssl` option. By default, `--with-ssl` causes the bundled yaSSL library to be used. To select OpenSSL instead, give the option as `-with-ssl=path`, where `path` is the directory where the OpenSSL header files and libraries are located.

- The `mysql_get_ssl_cipher()` C API function was added.
- `mysql_explain_log` (a third-party program) is no longer included in MySQL distributions.

#### Bugs fixed:

- **Security Fix:** An SQL-injection security hole has been found in multi-byte encoding processing. The bug was in the server, incorrectly parsing the string escaped with the `mysql_real_escape_string()` C API function.

This vulnerability was discovered and reported by Josh Berkus <[josh@postgresql.org](mailto:josh@postgresql.org)> and Tom Lane <[tgl@sss.pgh.pa.us](mailto:tgl@sss.pgh.pa.us)> as part of the inter-project security collaboration of the OSDB consortium. For more information about SQL injection, please see the following text.

**Discussion.** An SQL injection security hole has been found in multi-byte encoding processing. An SQL injection security hole can include a situation whereby when a user supplied data to be inserted into a database, the user might inject SQL statements into the data that the server will execute. With regards to this vulnerability, when character set-unaware escaping is used (for example, `addslashes()` in PHP), it is possible to bypass the escaping in some multi-byte character sets (for example, SJIS, BIG5 and GBK). As a result, a function such as `addslashes()` is not able to prevent SQL-injection attacks. It is impossible to fix this on the server side. The best solution is for applications to use character set-aware escaping offered by a function such as `mysql_real_escape_string()`.

However, a bug was detected in how the MySQL server parses the output of `mysql_real_escape_string()`. As a result, even when the character set-aware function `mysql_real_escape_string()` was used, SQL injection was possible. This bug has been fixed.

**Workarounds.** If you are unable to upgrade MySQL to a version that includes the fix for the bug in `mysql_real_escape_string()` parsing, but run MySQL 5.0.1 or higher, you can use the `NO_BACKSLASH_ESCAPES` SQL mode as a workaround. (This mode was introduced in MySQL 5.0.1.) `NO_BACKSLASH_ESCAPES` enables an SQL standard compatibility mode, where backslash is not considered a special character. The result will be that queries will fail.

To set this mode for the current connection, enter the following SQL statement:

```
SET sql_mode='NO_BACKSLASH_ESCAPES';
```

You can also set the mode globally for all clients:

```
SET GLOBAL sql_mode='NO_BACKSLASH_ESCAPES';
```

This SQL mode also can be enabled automatically when the server starts by using the command-line option `-sql-mode=NO_BACKSLASH_ESCAPES` or by setting `sql-mode=NO_BACKSLASH_ESCAPES` in the server option file (for example, `my.cnf` or `my.ini`, depending on your system). ([Bug#8378](#), [CVE-2006-2753](#))

See also [Bug#8303](#).

- **Partitioning: MySQL Cluster:** `SELECT MIN(unique_column)` from a Cluster table with user-defined partitioning crashed the server. ([Bug#18730](#))
- **MySQL Cluster: Replication:** (Replication): Memory was not freed after some `ALTER TABLE` operations, which could cause `mysqld` processes to crash. ([Bug#19885](#))
- **MySQL Cluster:** Running `ALL START` in the `NDB` management client or restarting multiple nodes simultaneously could under some circumstances cause the cluster to crash. ([Bug#19930](#))
- **MySQL Cluster:** (NDBAPI): On big-endian platforms, `NdbOperation::write_attr()` did not update 32-bit fields correctly. ([Bug#19537](#))
- **MySQL Cluster:** `TRUNCATE` failed on tables having `BLOB` or `TEXT` columns with the error `LOCK WAIT TIMEOUT EXCEEDED`.

#### Note

This issue affected both in-memory and Disk Data tables.

([Bug#19201](#))

- **MySQL Cluster:** `ALTER TABLE ENGINE=...` failed when used to change a MySQL Cluster table having no explicit primary key to use a different storage engine.

**Note**

As a consequence of this fix, `SHOW CREATE TABLE` no longer displays auto-partitioning information for `NDB-CLUSTER` tables.

([Bug#19010](#))

- **MySQL Cluster:** (NDBAPI): The `Ndb::dropEventOperation()` method failed to clean up all objects used, which could cause memory leaks to occur. ([Bug#17610](#))
- **MySQL Cluster:** Using “stale” `mysqld.FRM` files could cause a newly-restored cluster to fail. This situation could arise when restarting a MySQL Cluster using the `--initial` option while leaving connected `mysqld` processes running. ([Bug#16875](#))
- **MySQL Cluster:** A Cluster whose storage nodes were installed from the `MySQL-ndb-storage-*` RPMs could not perform `CREATE` or `ALTER` operations that made use of non-default character sets or collations. ([Bug#14918](#))
- **MySQL Cluster:** Data node failures could cause excessive CPU usage by `ndb_mgmd`. ([Bug#13987](#))
- **Replication:** The embedded server crashed with row-based replication enabled. ([Bug#18518](#))
- **Cluster Replication:** `mysqld` processes did not always detect cluster shutdown, leading to issues with Cluster replication and schema distribution. ([Bug#19395](#))
- The `Data_free` column in the output of `SHOW TABLE STATUS` always displayed 0 for partitioned tables. ([Bug#19501](#))
- Altering a `VARCHAR` column in a `MyISAM` table to make it longer could cause corruption of the following column. ([Bug#19386](#))
- It was not possible to invoke a stored routine containing dynamic SQL from a scheduled event. ([Bug#19264](#))
- Adding an index to a table created using partitioning by `KEY` and the `MEMORY` storage engine caused the server to crash. ([Bug#19140](#))
- Use of uninitialized user variables in a subquery in the `FROM` clause resulted in invalid entries in the binary log. ([Bug#19136](#))
- A `CREATE TABLE` statement that created a table from a materialized view did not inherit default values from the underlying table. ([Bug#19089](#))
- Premature optimization of nested subqueries in the `FROM` clause that refer to aggregate functions could lead to incorrect results. ([Bug#19077](#))
- When creating a table using `CREATE TABLE ... PARTITION BY ... SELECT ...`, the partitioning clause was ignored. ([Bug#19062](#))
- For dates with 4-digit year parts less than 200, an implicit conversion to add a century was applied for date arithmetic performed with `DATE_ADD()`, `DATE_SUB()`, `+ INTERVAL`, and `- INTERVAL`. (For example, `DATE_ADD('0050-01-01 00:00:00', INTERVAL 0 SECOND)` became `'2050-01-01 00:00:00'`.) Now these operations return `NULL` rather than an incorrect non-`NULL` value. ([Bug#18997](#))
- `BLOB` or `TEXT` arguments to or values returned from stored functions were not copied properly if too long and could become garbled. ([Bug#18587](#))
- The client libraries were not compiled for position-independent code on Solaris-SPARC and AMD x86\_64 platforms. ([Bug#18091](#), [Bug#13159](#), [Bug#14202](#))
- Returning the value of a system variable from a stored function caused a server crash. ([Bug#18037](#))
- Revised memory allocation for local objects within stored functions and triggers to avoid memory leak for repeated function or trigger invocation. ([Bug#17260](#))
- Symlinking `.mysql_history` to `/dev/null` to suppress statement history saving by `mysql` did not work. (`mysql` deleted the symlink and recreated `.mysql_history` as a regular file, and then wrote history to it.) ([Bug#16803](#))
- `IS_USED_LOCK()` could return an incorrect connection identifier. ([Bug#16501](#))
- Simultaneous scheduled events whose actions conflicted with one another could crash the server. ([Bug#16428](#))



- Concurrent reading and writing of privilege structures could crash the server. ([Bug#16372](#))
- The server no longer uses a signal handler for signal 0 because it could cause a crash on some platforms. ([Bug#15869](#))
- `EXPLAIN ... SELECT INTO` caused the client to hang. ([Bug#15463](#))
- `CREATE TABLE ... SELECT ...` statements that used a stored function explicitly or implicitly (through a view) resulted in a `Table not locked` error. ([Bug#15137](#), [Bug#12472](#))
- Display better error message for `ALTER TABLE` operations that will result in duplicate keys due to `AUTO_INCREMENT` resequencing. ([Bug#14573](#))
- The result from `CONV()` is a string, but was not always treated the same way as a string when converted to a real value for an arithmetic operation. ([Bug#13975](#))
- Within a trigger, `SET` used the SQL mode of the invoking statement, not the mode in effect at trigger creation time. ([Bug#6951](#))
- Corrected several problems with the treatment of the `--log-error` option by `mysqld_safe`. These problems were manifest as differences from `mysqld` in error log handling.
  - If a file name was given for `--log-error`, `mysqld_safe` ignored it and did not pass it to `mysqld`, which then wrote error information to `stderr` and resulted in incorrect log rotation when `FLUSH LOGS` was used.
  - `mysqld_safe` now adds `.err` to the end of the file name if no extension is present (the same as `mysqld`).
  - `mysqld_safe` treated a relative path name as relative to its own current working directory. Now it treats a relative path name as relative to the data directory (the same as `mysqld`).

In addition, some argument quoting problems were corrected. ([Bug#6061](#))

- The `basedir` and `tmpdir` system variables could not be accessed via `@@var_name` syntax. ([Bug#1039](#))
- `mysqld_safe` treated a relative path name as relative to its own current working directory. Now it treats a relative path name as relative to the data directory (the same as `mysqld`).
- `mysqld_safe` now adds `.err` to the end of the file name if no extension is present (the same as `mysqld`).
- If a file name was given for `--log-error`, `mysqld_safe` ignored it and did not pass it to `mysqld`, which then wrote error information to `stderr` and resulted in incorrect log rotation when `FLUSH LOGS` was used.
- The patch for [Bug#8303](#) broke the fix for [Bug#8378](#) and was reverted.

In string literals with an escape character (`\`) followed by a multi-byte character that had (`\`) as its second byte, the literal was not interpreted correctly. Now only next byte now is escaped, and not the entire multi-byte character. This means it is a strict reverse of the `mysql_real_escape_string()` function.

## C.2.28. Changes in MySQL 5.1.10 (Not released)

### Note

This was an internal release only, and no binaries were published.

MySQL 5.1.10 includes the patches for recently reported security vulnerabilities in the MySQL client-server protocol. We would like to thank Stefano Di Paola <[stefano.dipaola@wisec.it](mailto:stefano.dipaola@wisec.it)> for finding and reporting these to us.

This section documents all changes and bug fixes that have been applied since the last official MySQL release. If you would like to receive more fine-grained and personalized *update alerts* about fixes that are relevant to the version and features you use, please consider subscribing to *MySQL Enterprise* (a commercial MySQL offering). For more details please see <http://www.mysql.com/products/enterprise>.

Functionality added or changed:

- **Security Enhancement:** Added the global `max_prepared_stmt_count` system variable to limit the total number of prepared statements in the server. This limits the potential for denial-of-service attacks based on running the server out of memory by preparing huge numbers of statements. The current number of prepared statements is available through the `prepared_stmt_count` system variable. ([Bug#16365](#))
- **MySQL Cluster:** It is now possible to restore a MySQL Cluster backup between big-endian and little-endian machines. ([Bug#19255](#))

- **MySQL Cluster:** It is now possible to perform a partial start of a cluster. That is, it is now possible to bring up the cluster without first running `ndbd --initial` on all configured data nodes. (Bug#18606)
- **MySQL Cluster:** It is now possible to install MySQL with Cluster support to a non-default location and change the search path for font description files using either the `--basedir` or `--character-sets-dir` options. (Previously in MySQL 5.1, `ndbd` searched only the default path for character sets.)
- **Packaging:** The `MySQL-shared-compat-5.1.X-.i386.rpm` shared compatibility RPMs no longer contain libraries for MySQL 5.0. This avoids a conflict because the 5.0 and 5.1 libraries share the same `soname` number. They now contain libraries for MySQL 3.23, 4.0, 4.1, and 5.1. (Bug#19288)
- SQL syntax for prepared statements now supports `ANALYZE TABLE`, `OPTIMIZE TABLE`, and `REPAIR TABLE`. (Bug#19308)
- The `ONLY_FULL_GROUP_BY` SQL mode now also applies to the `HAVING` clause. That is, columns not named in the `GROUP BY` clause cannot be used in the `HAVING` clause if not used in an aggregate function. (Bug#18739)
- XPath expressions passed to the `ExtractValue()` and `UpdateXML()` functions can now include the colon character (“ : ”). This enables use of these functions with XML which employs namespaces. (Bug#18170)
- On Windows, some names such as `nul`, `prn`, and `aux` could not be used as file names because they are reserved as device names. These are now allowable names in MySQL. They are encoded by appending `@@@` to the name when the server creates the corresponding file or directory. This occurs on all platforms for portability of the corresponding database object between platforms. (Bug#17870)
- The bundled yaSSL library was upgraded to version 1.3.5. This improves handling of certain problems with SSL-related command options. (Bug#17737)
- You must now have the `DROP` privilege to drop table partitions. (Bug#17139)
- Server and clients ignored the `--sysconfdir` option that was passed to `configure`. The directory specified by this option, if set, now is used as one of the standard locations in which to look for option files. (Bug#15069)
- In result set metadata, the `MYSQL_FIELD.length` value for `BIT` columns now is reported in number of bits. For example, the value for a `BIT(9)` column is 9. (Formerly, the value was related to number of bytes.) (Bug#13601)
- The following statements now cause an implicit commit: `ANALYZE TABLE`, `CHECK TABLE`, `OPTIMIZE TABLE`, and `REPAIR TABLE`.
- Added the `KEY_BLOCK_SIZE` table option and index option. This can be used in `CREATE TABLE`, `ALTER TABLE`, and `CREATE INDEX` statements to provide a hint to the storage engine about the size to use for index key blocks. The engine is allowed to change the value if necessary.
- Added the `sql_big_selects` system variable to the output of `SHOW VARIABLES`.
- The `mysql_upgrade` command has been converted from a shell script to a C program, so it is available on non-Unix systems such as Windows. This program should be run for each MySQL upgrade. See Section 4.4.8, “`mysql_upgrade` — Check Tables for MySQL Upgrade”.
- Added the `REFERENTIAL_CONSTRAINTS` table to `INFORMATION_SCHEMA`. It provides information about foreign keys.
- Added the `have_dynamic_loading` system variable that indicates whether the server supports dynamic loading of plugins.
- Added `--debug` option to Instance Manager.
- Binary distributions that include SSL support now are built using yaSSL when possible.

**Bugs fixed:**

- **Security Fix:** A `NUL` byte within a comment in a statement string caused the rest of the string not to be written to the query log, allowing logging to be bypassed. (Bug#17667, CVE-2006-0903)
- **Security Fix:** A malicious client, using specially crafted invalid `COM_TABLE_DUMP` packets was able to trigger an exploitable buffer overflow on the server. Thanks to Stefano Di Paola <stefano.dipaola@wisec.it> for finding and reporting this bug. (CVE-2006-1518)
- **Security Fix:** A malicious client, using specially crafted invalid login or `COM_TABLE_DUMP` packets was able to read uninitialized memory, which potentially, though unlikely in MySQL, could have led to an information disclosure. (.) Thanks to Stefano Di Paola <stefano.dipaola@wisec.it> for finding and reporting this bug. (CVE-2006-1516, CVE-2006-1517)

- **MySQL Cluster: Replication:** (Replication): Delete and update of rows in a table without a primary key failed on the slave. (Bug#17400)
- **MySQL Cluster:** A 5.1.6 or newer server did not read local checkpoints recorded by any other 5.1 version, thus preventing a system restart following an upgrade. (Bug#19333)
- **MySQL Cluster:** Concurrent `INSERT` and `ROLLBACK` statements from different connections could cause node failures. (Bug#19245)
- **MySQL Cluster:** (Disk Data): Running an `INSERT` and a `DELETE` on a Disk Data table in the same transaction could cause a deadlock. (Bug#19244)
- **MySQL Cluster:** Starting `mysqld` without `--log-bin` caused DDL statements on NDB tables to time out. (Bug#19214)
- **MySQL Cluster:** (NDBAPI): Passing a non-existent index name to `NdbIndexScanOperation::setBound()` caused a segmentation fault. (Bug#19088)
- **MySQL Cluster:** `mysql-test-run.pl` started NDB even for test cases that did not need it. (Bug#19083)
- **MySQL Cluster:** Stopping multiple nodes could cause node failure handling not to be completed. (Bug#19039)
- **MySQL Cluster:** The Cluster binlog `mysqld` accepted updates even though the binary log was not set up, which could lead to updates missing from the binary log. (Bug#18932)
- **MySQL Cluster:** `mysqld` could crash when attempting an update if the cluster had failed previously. (Bug#18798)
- **MySQL Cluster:** An `INSERT` or `UPDATE` of more than 128 bytes of data in a 4-replica cluster could cause data nodes to crash. (Bug#18622)
- **MySQL Cluster:** (Disk Data): `CREATE LOGFILE GROUP` accepted values other than NDB or NDBCLUSTER in the `ENGINE` clause. (Bug#18604)
- **MySQL Cluster:** (Disk Data): Omitting the required `ENGINE` clause from a `CREATE LOGFILE GROUP` or `CREATE TABLESPACE` statement caused the server to crash. An appropriate error message is now returned instead. (Bug#18603)
- **MySQL Cluster:** Queries using `ORDER BY pkN` failed against a LIST-partitioned Cluster table having a multi-column primary key, where `pkN` represents one of the columns making up the primary key. (Bug#18598)
- **MySQL Cluster:** A simultaneous `DROP TABLE` and table update operation utilising a table scan could trigger a node failure. (Bug#18597)
- **MySQL Cluster:** Fragment IDs were not logged correctly, causing `ndb_restore_log` to fail. (Bug#18594)
- **MySQL Cluster:** Repeated use of the `SHOW` and `ALL STATUS` commands in the `ndb_mgm` client could cause the `mgmd` process to crash. (Bug#18591)
- **MySQL Cluster:** `ndbd` sometimes failed to start with the error `NODE FAILURE HANDLING NOT COMPLETED` following a graceful restart. (Bug#18550)
- **MySQL Cluster:** `ndb_restore` failed to restore a backup made from a 5.0 cluster to a 5.1 cluster. (Bug#18210)
- **MySQL Cluster:** Adding an index to an unsigned integer column did not work correctly. (Bug#18133)
- **MySQL Cluster:** A `SELECT` from an NDB table with `ORDER BY indexed_column` and a `LIMIT` clause would fail following `ALTER TABLE`. (Bug#18094)
- **MySQL Cluster:** `mysqldump` included in its output data from the internal `cluster` database. (Bug#17840)
- **MySQL Cluster:** Backups could fail for large clusters with many tables, where the number of tables approached `MaxNoOfTables`. (Bug#17607)
- **MySQL Cluster:** Some queries having a `WHERE` clause of the form `c1=val1 OR c2 LIKE 'val2'` were not evaluated correctly. (Bug#17421)
- **MySQL Cluster:** An issue with `ndb_mgmd` prevented more than 27 `mysqld` processes from connecting to a single cluster at one time. (Bug#17150)
- **MySQL Cluster:** In a 2-node cluster with a node failure, restarting the node with a low value for `StartPartialTimeout` could cause the cluster to come up partitioned (“split-brain” issue).

A similar issue could occur when the cluster was first started with a sufficiently low value for this parameter. (Bug#16447,

[Bug#18612](#)

- **MySQL Cluster:** Performing multiple `ALTER TABLE` operations on the same `NDB` table from different `mysqld` processes in the same cluster led to schema versioning errors when trying to access the table again following the restart of one of the `mysqld` processes. ([Bug#16445](#))
- **MySQL Cluster:** On systems with multiple network interfaces, data nodes would get “stuck” in startup phase 2 if the interface connecting them to the management server was working on node startup while the interface interconnecting the data nodes experienced a temporary outage. ([Bug#15695](#))
- **MySQL Cluster:** On slow networks or CPUs, the management client `SHOW` command could sometimes erroneously show all data nodes as being master nodes belonging to nodegroup 0. ([Bug#15530](#))
- **MySQL Cluster:** Unused open handlers for tables in which the metadata had changed were not properly closed. This could result in stale results from `NDB` tables following an `ALTER TABLE` statement. ([Bug#13228](#))
- **MySQL Cluster:** Uninitialized internal variables could lead to unexpected results. ([Bug#11033](#), [Bug#11034](#))
- **MySQL Cluster:** When attempting to create an index on a `BIT` or `BLOB` column, `ERROR 743: UNSUPPORTED CHARACTER SET IN TABLE OR INDEX` was returned instead of `ERROR 906: UNSUPPORTED ATTRIBUTE TYPE IN INDEX`.
- **Cluster Replication: Partitioning:** Attempting to create an index using multiple columns on an explicitly partitioned table in a replicated Cluster database could cause the master `mysqld` process to crash. ([Bug#18284](#))
- **Cluster Replication: Replication:** An issue with replication caused a `mysqld` connected to a replicated cluster to crash when entering single user mode. ([Bug#18535](#))
- **Replication:** `CREATE VIEW` statements would not be replicated to the slave if the `--replicate-wild-ignore-table` rule was enabled. ([Bug#18715](#))
- **Replication:** Updating a field value when also requesting a lock with `GET_LOCK()` would cause slave servers in a replication environment to terminate. ([Bug#17284](#))
- **Replication:** The binary log would create an incorrect `DROP` query when creating temporary tables during replication. ([Bug#17263](#))
- **Disk Data:** Issuing a `CREATE LOGFILE GROUP` statement during the drop of an `NDB` table would cause database corruption. ([Bug#19141](#))
- **Disk Data:** Concurrent table schema operations and operations on log file groups, tablespaces, data files, or undo files could lead to data node failures. ([Bug#18575](#))
- **Cluster Replication:** Using the `--binlog-do-db` option caused problems with `CREATE TABLE` on the cluster acting as the replication master. ([Bug#19492](#))
- **Cluster Replication:** When taking part in Cluster replication of tables containing `BLOB` columns, `mysqld` falsely reported a large memory leak in the replication buffers when there was none. ([Bug#19247](#))
- **Cluster Replication:** Trying to restore the `apply_status` table from a 5.0 cluster backup failed on a 5.1 server. ([Bug#18935](#))
- A compatibility issue with NPTL (Native POSIX Thread Library) on Linux could result in a deadlock with `FLUSH TABLES WITH READ LOCK` under some conditions. ([Bug#20048](#))
- Some outer joins were incorrectly converted to inner joins. ([Bug#19816](#))  
  
This regression was introduced by [Bug#17146](#).
- A view definition that referred to an alias in the `HAVING` clause could be saved in the `.frm` file with the alias replaced by the expression that it referred to, causing failure of subsequent `SELECT * FROM view_name` statements. ([Bug#19573](#))
- `mysql` displayed `NULL` for strings that are empty or contain only spaces. ([Bug#19564](#))
- Selecting from a view that used `GROUP BY` on a non-constant temporal interval (such as `DATE(col) + INTERVAL TIME_TO_SEC(col) SECOND`) could cause a server crash. ([Bug#19490](#))
- An outer join of two views that was written using `{ OJ ... }` syntax could cause a server crash. ([Bug#19396](#))
- An issue with file handling in the partitioning code could cause `mysqld` to crash when started and then stopped within a very short period of time. ([Bug#19313](#))

- `myisamchk` and `myisam_ftdump` should allow either table names or `.MYI` file names as arguments, but allowed only table names. (Bug#19220)
- InnoDB could read a delete mark from its system tables incorrectly. (Bug#19217)
- Executing a `CREATE EVENT` statement could cause 100% CPU usage. (Bug#19170)
- Eliminated some memory corruption problems that resulted in `double free or corruption` errors and a server crash. (Bug#19154)
- Attempting to set the default value of an `ENUM` or `SET` column to `NULL` caused a server crash. (Bug#19145)
- Index corruption could occur in cases when `key_cache_block_size` was not a multiple of the `myisam-block-size` value (for example, with `--key_cache_block_size=1536` and `--myisam-block-size=1024`). (Bug#19079)
- Instance Manager now finds the version numbers, so that it works properly when the executable name isn't the same as what the Instance Manager launched (such as when wrapping a `libtool`-wrapped executable from the source tree). (Bug#19059)
- Some fast `ALTER TABLE` operations (requiring no temporary table) did not work for all tables. (Bug#19011)
- Successive `ALTER TABLE ... DROP PARTITION` statements on the same subpartitioned table could eventually cause the server to crash. (Bug#18962)
- Creating a table in an InnoDB database with a column name that matched the name of an internal InnoDB column (including `DB_ROW_ID`, `DB_TRX_ID`, `DB_ROLL_PTR` and `DB_MIX_ID`) would cause a crash. MySQL now returns Error 1005 `CANNOT CREATE TABLE` with `errno` set to -1. (Bug#18934)
- The parser leaked memory when its stack needed to be extended. (Bug#18930)
- MySQL would not compile on Linux distributions that use the `tinfo` library. (Bug#18912)
- The server attempted to flush uninitialized log tables during `SIGHUP` processing, causing a crash. (Bug#18848)
- For a reference to a non-existent stored function in a stored routine that had a `CONTINUE` handler, the server continued as though a useful result had been returned, possibly resulting in a server crash. (Bug#18787)
- For single-`SELECT` union constructs of the form `(SELECT ... ORDER BY order_list1 [LIMIT n]) ORDER BY order_list2`, the `ORDER BY` lists were concatenated and the `LIMIT` clause was ignored. (Bug#18767)
- Inserts failed with duplicate key errors on a table partitioned using an `AUTO_INCREMENT` column for the partitioning key. (Bug#18753, Bug#18552)
- It was possible to create a `RANGE`-partitioned table with a partition defined using the clause `VALUES LESS THAN (NULL)`, even though such a partition could never contain any values whatsoever. (Bug#18752)
- Delimited identifiers for partitions were not being treated the same as delimited identifiers for other database objects (such as tables and columns) with regard to allowed characters. (Bug#18750)
- Conversion of a number to a `CHAR UNICODE` string returned an invalid result. (Bug#18691)
- If the second or third argument to `BETWEEN` was a constant expression such as `'2005-09-01 - INTERVAL 6 MONTH` and the other two arguments were columns, `BETWEEN` was evaluated incorrectly. (Bug#18618)
- `LOAD DATA FROM MASTER` would fail when trying to load the `INFORMATION_SCHEMA` database from the master, because the `INFORMATION_SCHEMA` system database would already exist on the slave. (Bug#18607)
- Running an `ALTER TABLE` on a partitioned table simultaneously experiencing a high number of concurrent DML statements could crash the server. (Bug#18572)
- A `LOCK TABLES` statement that failed could cause MyISAM not to update table statistics properly, causing a subsequent `CHECK TABLE` to report table corruption. (Bug#18544)
- `mysqltest` incorrectly interpreted some `ER_xxx` error names given in the `error` command. (Bug#18495)
- InnoDB: `ALTER TABLE` to add or drop a foreign key for an InnoDB table had no effect. (Bug#18477)
- InnoDB did not use a consistent read for `CREATE ... SELECT` when `innodb_locks_unsafe_for_binlog` was set. (Bug#18350)
- `DROP DATABASE` did not drop stored routines associated with the database if the database name was longer than 21 characters. (Bug#18344)

- A query on a table partitioned or subpartitioned by `HASH` did not display all results when using a `WHERE` condition involving a column used in the hashing expression. (Bug#18329, Bug#18423)
- In `mysqltest`, `--sleep=0` had no effect. Now it correctly causes `sleep` commands in test case files to sleep for 0 seconds. (Bug#18312)
- `ExtractValue` function did not return character data within `<![CDATA[ ]>` as expected. (Bug#18285)
- A recent change caused the `mysql` client not to display `NULL` values correctly and to display numeric columns left-justified rather than right-justified. The problems have been corrected. (Bug#18265)
- Updates to a `MEMORY` table caused the size of `BTREE` indexes for the table to increase. (Bug#18160)
- A failed `ALTER TABLE` operation could fail to clean up a temporary `.frm` file. (Bug#18129)
- Event-creation statements enclosed in multi-line comments using `/*!version_number ... */` syntax were not parsed correctly. (Bug#18078)
- `SELECT DISTINCT` queries sometimes returned only the last row. (Bug#18068)
- `InnoDB`: A `DELETE` followed by an `INSERT` and then by an `UPDATE` on a partitioned `InnoDB` table caused subsequent queries to return incorrect results. (Bug#17992)
- It was possible to use trailing spaces in the names of partitions and subpartitions. Attempting to do so now raises the error `INCORRECT PARTITION NAME`. (Bug#17973)
- `LIKE` searches failed on a `CHAR` column used as the partitioning column of a table partitioned by `KEY`. (Bug#17946)
- Executing `SELECT` on a large table that had been compressed within `myisampack` could cause a crash. (Bug#17917)
- The `sql_big_selects` system variable was not displayed by `SHOW VARIABLES`. (Bug#17849)
- `REPAIR TABLE` did not restore the length for packed keys in tables created under MySQL 4.x, which caused them to appear corrupt to `CHECK TABLE` but not to `REPAIR TABLE`. (Bug#17810)
- A range access optimizer heuristic was invalid, causing some queries to be much slower in MySQL 5.0 than in 4.0. (Bug#17379, Bug#18940)
- Logging to the `mysql.general_log` and `mysql.slow_log` tables did not work for Windows builds because the `CSV` storage engine was unavailable. The `CSV` engine now is enabled in Windows builds. (Bug#17368)
- If the `WHERE` condition of a query contained an `OR`-ed `FALSE` term, the set of tables whose rows cannot serve for null-complements in outer joins was determined incorrectly. This resulted in blocking possible conversions of outer joins into joins by the optimizer for such queries. (Bug#17164)
- Casting a string to `DECIMAL` worked, but casting a trimmed string (using `LTRIM()` or `RTRIM()`) resulted in loss of decimal digits. (Bug#17043)
- `MyISAM` table deadlock was possible if one thread issued a `LOCK TABLES` request for write locks and then an administrative statement such as `OPTIMIZE TABLE`, if between the two statements another client meanwhile issued a multiple-table `SELECT` for some of the locked tables. (Bug#16986)
- `ALTER TABLE ... REBUILD PARTITION` returned an inaccurate error message. (Bug#16819)
- Use of `--default-storage-engine=innodb` resulted in an error with the server reporting that `InnoDB` was an unknown table type. (Bug#16691)
- `MySQL-shared-compat-5.1.9-0.i386.rpm` incorrectly depended on `glibc` 2.3 and could not be installed on a `glibc` 2.2 system. (Bug#16539)
- The presence of multiple equalities in a condition after reading a constant table could cause the optimizer not to use an index. This resulted in certain queries being much slower than in MySQL 4.1. (Bug#16504)
- Within a trigger, `CONNECTION_ID()` did not return the connection ID of the thread that caused the trigger to be activated. (Bug#16461)
- The XPath `string-length()` function was not implemented for use with `ExtractValue()`. (Bug#16319)
- The `ExtractValue()` function failed with a syntax error when the XPath expression used special characters such as `ñ` (“N-tilde”). (Bug#16233)



- The `sql_notes` and `sql_warnings` system variables were not always displayed correctly by `SHOW VARIABLES` (for example, they were displayed as `ON` after being set to `OFF`). (Bug#16195)
- If the first argument to `BETWEEN` was a `DATE` or `TIME` column of a view and the other arguments were constants, `BETWEEN` did not perform conversion of the constants to the appropriate temporary type, resulting in incorrect evaluation. (Bug#16069)
- After calling `FLUSH STATUS`, the `max_used_connections` variable did not increment for existing connections and connections which use the thread cache. (Bug#15933)
- `DELETE` and `UPDATE` statements that used large `NOT IN (value_list)` clauses could use large amounts of memory. (Bug#15872)
- InnoDB failure to release an adaptive hash index latch could cause a server crash if the query cache was enabled. (Bug#15758)
- `LAST_INSERT_ID()` in a stored function or trigger returned zero. (Bug#15728)
- The `system_time_zone` and `version_*` system variables could not be accessed via `SELECT @@var_name` syntax. (Bug#15684, Bug#12792)
- If the server were built without partition support, it was possible to run partitioning-related statements with no errors or warnings, even though these statements would have no effect. Now such statements are disallowed unless the server has been compiled using the `--with-partition` option. (Bug#15561)
- Use of `CONVERT_TZ()` in a view definition could result in spurious syntax or access errors. (Bug#15153)
- Prevent recursive views caused by using `RENAME TABLE` on a view after creating it. (Bug#14308)
- Some queries were slower in 5.0 than in 4.1 because some 4.1 cost-evaluation code had not been merged into 5.0. (Bug#14292)
- Avoid trying to include `<asm/atomic.h>` when it doesn't work in C++ code. (Bug#13621)
- Running `myisampack` followed by `myisamchk` with the `--unpack` option would corrupt the `auto_increment` key. (Bug#12633)
- Use of `CONVERT_TZ()` in a stored function or trigger (or in a stored procedure called from a stored function or trigger) caused an error. (Bug#11081)
- When `myisamchk` needed to rebuild a table, `AUTO_INCREMENT` information was lost. (Bug#10405)

## C.2.29. Changes in MySQL 5.1.9 (12 April 2006)

This is a new Beta development release, fixing recently discovered bugs.

### Note

This Beta release, as any other pre-production release, should not be installed on *production* level systems or systems with critical data. It is good practice to back up your data before installing any new version of software. Although MySQL has worked very hard to ensure a high level of quality, protect your data by making a backup as you would for any software beta release. Please refer to our bug database at <http://bugs.mysql.com/> for more details about the individual bugs fixed in this version.

This section documents all changes and bug fixes that have been applied since the last official MySQL release. If you would like to receive more fine-grained and personalized *update alerts* about fixes that are relevant to the version and features you use, please consider subscribing to *MySQL Enterprise* (a commercial MySQL offering). For more details please see <http://www.mysql.com/products/enterprise>.

Functionality added or changed:

- **MySQL Cluster:** The `NDB` storage engine now supports `CREATE TABLE` statements of arbitrary length. (Previously, `CREATE TABLE` statements for MySQL Cluster tables could contain a maximum of 4096 characters only.) (Bug#17813)
- **MySQL Cluster:** Added the `--nowait-nodes` startup option for `ndbd`, making it possible to skip specified nodes without waiting for them to start when starting the cluster. See [Program Options for ndbd and ndbmtD](#).
- `mysqld_safe` no longer checks for a `mysqld-max` binary. Instead, `mysqld_safe` now checks only for the standard `mysqld` server unless another server binary is specified explicitly via `--mysqld` or `--mysqld-version`. If you previously relied on the implicit invocation of `mysqld-max`, you should use an appropriate option now. (Bug#17861)
- For partitioned tables, the output of `SHOW TABLE STATUS` now shows in the `Engine` column the name of the storage en-

gine used by all partitions for the table; in the `Create_options` column, the output now shows `partitioned` for a partitioned table. This change also affects the values shown in the corresponding columns of the `INFORMATION_SCHEMA.TABLES` table. (Bug#17631)

- `SHOW PLUGIN` was renamed to `SHOW PLUGINS`. `SHOW PLUGIN` now is deprecated and generates a warning. (Bug#17112)
- Large file support was re-enabled for the MySQL server binary for the AIX 5.2 platform. (Bug#13571)
- Binary MySQL distributions now include a `mysqld-max` server, in addition to the usual `mysqld` optimized server and the `mysqld-debug` debugging server.

Bugs fixed:

- **Security Fix:** Invalid arguments to `DATE_FORMAT()` caused a server crash. Thanks to Jean-David Maillefer for discovering and reporting this problem to the Debian project and to Christian Hammers from the Debian Team for notifying us of it. (Bug#20729, CVE-2006-3469)
- **Partitioning: MySQL Cluster:** `BLOB` columns did not work correctly with user-partitioned `NDB` tables. (Bug#16796)
- **MySQL Cluster:** An uninitialized internal variable could lead to unexpected results. (Bug#18831)
- **MySQL Cluster:** `TRUNCATE` did not reset the `AUTO_INCREMENT` counter for `MyISAM` tables when issued inside a stored procedure.

#### Note

This bug did not affect `InnoDB` tables.

In addition, `TRUNCATE` does not reset the `AUTO_INCREMENT` counter for `NDB` tables regardless of when it is called.

(Bug#14945)

See also Bug#18864.

- For full-text searches in boolean mode, and when a full-text parser plugin was used, a `MYSQL_FTPARSER_PARAM::ftparser_state` could have been corrupted by recursive calls to the plugin. (Bug#18836)
- `mysql_reconnect()` sent a `SET NAMES` statement to the server, even for pre-4.1 servers that do not understand the statement. (Bug#18830)
- A query against a partitioned table using `WHERE col IS NULL` could produce incorrect results given the following conditions:
  - The table had partitions and subpartitions
  - The partitioning function depended on a single column `col` of one of the MySQL integer types
  - The partitioning function was not monotonically increasing

The same issue could cause the server to crash when run in debug mode. (Bug#18659)

- Partition pruning did not work properly for some kinds of partitioning and subpartitioning, with certain `WHERE` clauses. (Partitions and subpartitions that should have been marked as used were not so marked.) The error could manifest as incorrect content in `EXPLAIN PARTITIONS` output as well as missing rows in the results of affected queries. (Bug#18558)
- Building the server using `--with-example-storage-engine` failed to enable the `EXAMPLE` storage engine in the server. (Bug#18464)
- If `InnoDB` encountered a `HA_ERR_LOCK_TABLE_FULL` error and rolled back a transaction, the transaction was still written to the binary log. (Bug#18283)
- Complex queries with nested joins could cause a server crash. (Bug#18279)
- `COUNT(*)` on a `MyISAM` table could return different results for the base table and a view on the base table. (Bug#18237)
- `EXTRACT(QUARTER FROM date)` returned unexpected results. (Bug#18100)
- Queries using `WHERE ... IS NULL` returned incorrect results from partitioned tables. (Bug#18070)
- Partition pruning did not perform correctly with partitions on `NULL`, and could potentially crash the server. (Bug#18053)



- `MEDIUMINT` columns were not handled in the same way as other column types by partition pruning. Partition pruning would sometimes use inappropriate columns in performing queries. Both of these issues were rectified as part of the same bug fix. (Bug#18025)
- For tables created in a MySQL 4.1 installation upgraded to MySQL 5.0 and up, multiple-table updates could update only the first matching row. (Bug#16281)
- For `mysql.server`, if the `basedir` option was specified after `datadir` in an option file, the setting for `datadir` was ignored and assumed to be located under `basedir`. (Bug#16240)
- Triggers created in one version of the server could not be dropped after upgrading to a newer version. (Bug#15921)
- `CAST(double AS SIGNED INT)` for large `double` values outside the signed integer range truncated the result to be within range, but the result sometimes had the wrong sign, and no warning was generated. (Bug#15098)
- Quoted values could not be used for partition option values. (Bug#13520)
- Delimited identifiers could not be used in defining partitions. (Bug#13433)
- `mysql_config` returned incorrect libraries on `x86_64` systems. (Bug#13158)
- The server was always built as though `--with-extra-charsets=complex` had been specified. (Bug#12076)

## C.2.30. Changes in MySQL 5.1.8 (Not released)

### Note

This was an internal release only, and no binaries were published.

Functionality added or changed:

- **Cluster Replication: Incompatible Change:** The `cluster_replication` database has been renamed to `cluster`. This will effect replication between MySQL Clusters where one cluster is running MySQL 5.1.8 or later, and the other is running MySQL 5.1.7 or earlier. See [MySQL Cluster Replication](#), and especially [MySQL Cluster Replication Schema and Tables](#).
- **Incompatible Change:** The semantics of `ALTER TABLE t ENGINE=X;` for partitioned tables is changed, and now means that the storage engine used for table `t` is changed to `X`.  
  
The previous statement formerly (prior to MySQL 5.1.8) meant that all partitioning was removed from the table. In order to remove the partitioning of a table, the syntax `ALTER TABLE t REMOVE PARTITIONING;` is introduced. The `REMOVE PARTITIONING` option can be used in combination with existing `ALTER TABLE` options such as those employed for adding or dropping columns or indexes. (Bug#17754)
- **Incompatible Change:** For purposes of determining placement, `RANGE` partitioning now treats `NULL` as less than any other value. (Formerly, `NULL` was treated as equal to zero.) See [Section 17.2.6, “How MySQL Partitioning Handles NULL”](#). (Bug#15447)
- **MySQL Cluster:** The stability of `CREATE` and `DROP` operations on `NDB` tables containing `BLOB` columns has been improved. (Bug#17761)
- **MySQL Cluster:** The `NDBCLUSTER` storage engine now supports `INSERT IGNORE` and `REPLACE` statements. Previously, these statements failed with an error. (Bug#17431)
- **Replication:** Triggers from older servers that included no `DEFINER` clause in the trigger definition now execute with the privileges of the invoker (which on the slave is the slave SQL thread). Previously, replication slaves could not replicate such triggers. (Bug#16266)
- **Replication:** The `binlog_format` system variable now can be set to a third format, `MIXED`, as described in [Section 16.1.2, “Replication Formats”](#).
- **Replication:** The `binlog_format` system variable now is dynamic and can be changed at runtime, as described in [Section 16.1.2, “Replication Formats”](#).
- **Replication:** A slave server may now switch the replication format automatically. This happens when the server is running in either `STATEMENT` or `MIXED` format and encounters a row in the binary log that is written in `ROW` logging format. In that case, the slave switches to row-based replication temporarily for that event, and switches back to the previous format afterwards.

- **Disk Data:** You can now have only one log file group at any one time. See [Section 12.1.14, “CREATE LOGFILE GROUP Syntax”](#). ([Bug#16386](#))
- Builds for Windows, Linux, and Unix (except AIX) platforms now have SSL support enabled, in the server as well as in the client libraries. Because part of the SSL code is written in C++, this does introduce dependencies on the system's C++ runtime libraries in several cases, depending on compiler specifics. ([Bug#18195](#))
- Partition pruning was made more stable, particularly in cases involving queries using tests for NULL values in the WHERE clause against subpartitioned tables which were partitioned by `LIST( some_function(col1, ... ,colN) )`. ([Bug#17891](#))
- The output of `SHOW CREATE EVENT` no longer qualifies the event name with the name of the schem to which the event belongs. ([Bug#17714](#))
- The deprecated constructs in the following table now generate warnings. You should not employ them in new applications, as they are likely to be removed in a future version of MySQL. Use the equivalents shown in the table's second column instead. For the same reason, existing applications that depend on the deprecated constructs should be converted to make use of the current equivalents as soon as possible.

Deprecated / Obsolete:	Current / Preferred:
<code>@@table_type</code>	<code>@@storage_engine</code>
<code>@@log_bin_trust_routine_creators</code>	<code>@@log_bin_trust_function_creators</code>
<code>TIMESTAMP(N)</code>	See <a href="#">Section 11.6, “Date and Time Functions”</a> .
<code>TYPE=</code>	<code>ENGINE=</code>
<code>BACKUP TABLE</code>	<code>mysql-dump</code> , <code>mysql-hotcopy</code> , or MySQL Administrator
<code>RESTORE TABLE, LOAD TABLE FROM MASTER</code>	<code>mysql-dump</code> , <code>mysql</code> , or MySQL Administrator
<code>SHOW TABLE TYPES</code>	<code>SHOW [STORAGE] ENGINES</code>
<code>SHOW INNODB STATUS</code>	<code>SHOW ENGINE INNODB STATUS</code>
<code>SHOW MUTEX STATUS</code>	<code>SHOW ENGINE INNODB MUTEX</code>
<code>SHOW BDB LOGS, SHOW LOGS</code>	<code>SHOW ENGINE BDB LOGS</code>

`SHOW BDB LOGS` and `SHOW LOGS` are removed as of MySQL 5.1.12, and the other deprecated items shown in the table are

removed as of MySQL 5.2.5.

### Important

**TYPE vs ENGINE**. In order not to break legacy applications, support for `TYPE = engine_name` — deprecated since MySQL 4.0 — has been restored, but now generates a warning.

*Beginning with MySQL 5.2.5, `TYPE = engine_name` will no longer be available and will produce a syntax error.*

*You should not use `TYPE` in any new applications, and you should immediately begin conversion of existing applications to use the `ENGINE = engine_name` syntax instead.*

([Bug#17501](#))

- Temporary tables may no longer be partitioned. ([Bug#17497](#))
- More specific error messages are now given when attempting to create an excessive number of partitions or subpartitions. (Previously, no distinction was made between an excessive number of partitions and an excessive number of subpartitions.) ([Bug#17393](#))
- Added the `--events` option to `mysqldump` to enable events to be included in the dump output. ([Bug#16853](#))
- For an event having no `STARTS` time specified when it was created, the `mysql.event` table's `start` column now displays the creation time rather than `NULL`.

In addition, both the `SHOW EVENTS` statement's `Starts` column and the `STARTS` column of the `INFORMATION_SCHEMA.EVENTS` table are now empty rather than `NULL` when `STARTS` was not used in the `CREATE EVENT` statement. ([Bug#16537](#))

- Event names are now case-insensitive. That is (for example), you cannot have events with the names `Myevent` and `MyEvent` belonging to the same database and definer. ([Bug#16415](#))
- Description of the `EVENT` privilege has been changed to `To create, alter, drop, and execute events`. ([Bug#16412](#))
- `MICROSECOND` intervals are no longer allowed for events. ([Bug#16411](#))
- Events no longer support times past the end of the Unix epoch. (Formerly, such dates were interpreted as being at the beginning of the Unix epoch.) ([Bug#16396](#))
- The XPath `last()` function is now implemented for use with `ExtractValue()`. ([Bug#16318](#))
- The `ExtractValue()` function with `contains()` now uses the SQL collation in making comparisons. Previously, comparisons were always binary (that is, case-sensitive). ([Bug#16316](#))
- Names of subpartitions must now be unique for an entire table, and not merely within the same partition. ([Bug#15408](#))
- Added the `--sysdate-is-now` option to `mysqld` to enable `SYSDATE()` to be treated as an alias for `NOW()`. See [Section 11.6, "Date and Time Functions"](#). ([Bug#15101](#))
- `mysqldump` now surrounds the `DEFINER`, `SQL SECURITY DEFINER` and `WITH CHECK OPTION` clauses of a `CREATE VIEW` statement with "not in version" comments to prevent errors in earlier versions of MySQL. ([Bug#14871](#))
- The `mysql_ping` function will now retry if the `reconnect` flag is set and error `CR_SERVER_LOST` is encountered during the first attempt to ping the server. ([Bug#14057](#))
- The `mysqltest` utility now converts all `CR/LF` combinations to `LF` to allow test cases intended for Windows to work properly on UNIX-like systems. ([Bug#13809](#))
- The output from `SHOW CREATE TABLE` is more consistent about using uppercase for keywords. Data types still are in lowercase. ([Bug#10460](#))
- The client API now attempts to reconnect using TCP/IP if the `reconnect` flag is set, as is the case with sockets. ([Bug#2845](#))
- The syntax for `CREATE PROCEDURE` and `CREATE FUNCTION` statements now includes a `DEFINER` clause. The `DEFINER` value specifies the security context to be used when checking access privileges at routine invocation time if the routine has the `SQL SECURITY DEFINER` characteristic. See [Section 12.1.15, "CREATE PROCEDURE and CREATE FUNCTION Syntax"](#), for more information.

When `mysqldump` is invoked with the `--routines` option, it now dumps the `DEFINER` value for stored routines.

Bugs fixed:

- **Partitioning: MySQL Cluster:** Trying to insert a value into a non-existent `LIST` partition of an `NDB` table would cause the server to crash.

#### Note

Beginning with MySQL 5.1.12, user-defined partitioning types other than `KEY` or `LINEAR KEY` were disabled for `NDB` tables.

([Bug#17763](#))

- **Partitioning: MySQL Cluster:** A repeated `SELECT` on a partitioned table that used the `NDB` storage engine could cause the server to crash. ([Bug#17390](#))
- **MySQL Cluster: Replication:** `auto_increment` values were not propagated correctly in statement-based replication. ([Bug#18208](#))
- **MySQL Cluster: Replication:** Memory was mistakenly freed for `NdbRecAttr` objects during addition of an index while replicating the cluster, which could cause `mysqld` to crash. ([Bug#18106](#))
- **MySQL Cluster: Replication:** Row-based replication could fail with tables using `VARCHAR` columns for primary keys and having `BLOB` columns. ([Bug#18067](#))
- **MySQL Cluster: Replication:** (Replication): The binary log on the secondary master was not being set up correctly following a table rename. ([Bug#17838](#))
- **MySQL Cluster:** Attempting to restart a node with dropped events still pending would fail. ([Bug#18491](#))
- **MySQL Cluster:** Two `mysqld` processes starting at the same time could cause a race condition. ([Bug#18472](#))
- **MySQL Cluster:** A timeout in the handling of an `ABORT` condition with more than 32 operations could yield a node failure. ([Bug#18414](#))
- **MySQL Cluster:** Two `mysqld` processes did not synchronise `DROP TABLE` binary log events correctly. ([Bug#18395](#))
- **MySQL Cluster:** A node restart immediately following a `CREATE TABLE` would fail.

#### Important

This fix supports 2-node Clusters only.

([Bug#18385](#))

- **MySQL Cluster:** In event of a node failure during a rollback, a “false” lock could be established on the backup for that node, which lock could not be removed without restarting the node. ([Bug#18352](#))
- **MySQL Cluster:** When multiple node restarts were attempted without allowing each restart to complete, the error message returned was `ARRAY INDEX OUT OF BOUNDS` rather than `TOO MANY CRASHED REPLICAS`. ([Bug#18349](#))
- **MySQL Cluster:** The cluster created a crashed replica of a table having an ordered index — or when logging was not enabled, of a table having a table or unique index — leading to a crash of the cluster following 8 successive restarts. ([Bug#18298](#))
- **MySQL Cluster:** Issuing a `DROP LOGFILE GROUP` statement would cause `ndbd` processes to crash if MySQL had been compiled with `gcc4`. ([Bug#18295](#))
- **MySQL Cluster:** When replacing a failed master node, the replacement node could cause the cluster to crash from a buffer overflow if it had an excessively large amount of data to write to the cluster log. ([Bug#18118](#))
- **MySQL Cluster:** Insufficient `StringBuffer` memory when attempting to create a trigger caused the server to crash. ([Bug#18101](#))
- **MySQL Cluster:** Variable-length columns used as primary keys were not handled correctly. ([Bug#18075](#))
- **MySQL Cluster:** `CREATE UNIQUE INDEX` on a column containing non-unique data could cause one or more `ndbd` nodes to hang or crash. ([Bug#18040](#))
- **MySQL Cluster:** Node recovery of tables with `VARCHAR` columns using character sets was inconsistent, which could cause a number of issues, including the data nodes failing to restart and `ALTER TABLE` statements to hang. ([Bug#18026](#))

- **MySQL Cluster:** A `SELECT ... ORDER BY` query on an explicitly partitioned Cluster table with no explicit indexes would crash the server. (Bug#17899)
- **MySQL Cluster:** `ALTER TABLE ... ADD INDEX` failed with `ERROR 756: INDEX ON DISK COLUMN IS NOT SUPPORTED` when run against a Disk Data table having a primary key. (Bug#17888)
- **MySQL Cluster:** In some cases, a single `ndbd` node failed following a system restart. (Bug#17854)
- **MySQL Cluster:** A simultaneous `RENAME` of several tables was logged multiple times. (Bug#17827)
- **MySQL Cluster:** Trying to perform a `DELETE` from an `NDB` table following a `LOCK TABLES` caused the `ndbd` processes to hang. (Bug#17812)
- **MySQL Cluster:** Trying to update very large partitioned tables using the `NDB` storage engine sometimes caused the server to crash. (Bug#17806, Bug#16385)
- **MySQL Cluster:** Using `ALTER TABLE ... ADD PARTITION` on a table partitioned by `LIST` would cause the client to hang. (Bug#17701)
- **MySQL Cluster:** With a single replica, transactions waiting in the log synchronisation queue were not being restarted, causing them to be aborted. (Bug#17536)
- **MySQL Cluster:** `ALTER TABLE` on a partitioned `NDB` table could cause the server to crash. (Bug#17499)
- **MySQL Cluster:** `DELETE` operations on `NDB` tables could cause memory leaks. (Bug#16874)
- **MySQL Cluster:** Some query cache statistics were not always correctly reported for Cluster tables. (Bug#16795)
- **MySQL Cluster:** Restarting nodes were allowed to start and join the cluster too early. (Bug#16772)
- **MySQL Cluster:** `UNDO_BUFFER_SIZE` was limited to 17 MB. (Bug#16657, Bug#17890)
- **MySQL Cluster:** Inserting and deleting `BLOB` column values while a backup was in process could cause data nodes to shut down. (Bug#14028)
- **Replication:** Replication of data stored in a partitioned table would cause slave servers to issue an assertion and terminate. (Bug#18436)
- **Replication:** Use of `TRUNCATE TABLE` for a `TEMPORARY` table on a master server was propagated to slaves properly, but slaves did not decrement the `Slave_open_temp_tables` counter properly. (Bug#17137)
- **Replication:** Slave servers would retry the execution of an SQL statement an infinite number of times, ignoring the value `SLAVE_TRANSACTION_RETRIES` when using the `NDB` engine. (Bug#16228)
- **Replication:** The `DEFINER` value for stored routines was not replicated. (Bug#15963)
- **Disk Data:** `CREATE UNIQUE INDEX` failed with `ERROR 4243: INDEX NOT FOUND`. (Bug#18039)
- **Disk Data:** It was not possible to create more than 9 tablespaces. (Bug#16913)
- A `SELECT ... ORDER BY ...` from a view defined using a function could crash the server. An example of such a view is `CREATE VIEW v1 AS SELECT SQRT(c1) FROM t1`. (Bug#18386)
- The server would crash when `SHOW STATUS` was called on a server linked with `yaSSL`. (Bug#18310)
- The `ExtractValue()` function did not return an error when passed an invalid XPath string. (Bug#18172)
- Using the `position()` function in the XPath argument to `ExtractValue()` crashed the server. (Bug#18171)
- `REPAIR TABLE`, `OPTIMIZE TABLE`, and `ALTER TABLE` operations on transactional tables (or on tables of any type on Windows) could corrupt triggers associated with those tables. (Bug#18153)
- Connecting to a server with a UCS2 default character set with a client using a non-UCS2 character set crashed the server. (Bug#18004)
- Using `ALTER TABLE ... REBUILD PARTITION` without specifying the name of the partition caused the server to crash, rather than reporting a syntax error. (Bug#17947)
- `ALTER TABLE ... REBUILD PARTITION` with no partition name specified would crash the server. (Bug#17940)
- A query with a `WHERE date_column > date_value` condition failed on a table partitioned by `RANGE`. (Bug#17894)

- Renaming and adding a new column to a partitioned table in the same `ALTER TABLE` statement caused the server to crash. (Bug#17772)
- `MyISAM`: Performing a bulk insert on a table referenced by a trigger would crash the table. (Bug#17764)
- Using triggers with partitioned `InnoDB` tables led to incorrect results. (Bug#17744)
- Updating a view that filters certain rows to set a filtered out row to be included in the table caused infinite loop. For example, if the view has a `WHERE` clause of `salary > 100` then issuing an `UPDATE` statement of `SET salary = 200 WHERE id = 10`, caused an infinite loop. (Bug#17726)
- A security enhancement in Visual Studio 8 could cause a MySQL debug server compiled with it to hang when running `SELECT` queries against partitioned tables. (Bug#17722)
- The `EXAMPLE` storage engine did not work on Windows. (Bug#17721)
- `ALTER TABLE ... REORGANIZE PARTITION` failed with `ERROR ON RENAME OF FILENAME ...` on Windows. (Bug#17720)
- The MySQL server could crash with out of memory errors when performing aggregate functions on a `DECIMAL` column. (Bug#17602)
- `NULL` values were written to the `mysql.slow_log` table incorrectly. (Bug#17600)
- `mysql_fix_privilege_tables` did not create the `mysql.plugin` table. (Bug#17568)
- Improper checking of binary log statements could result in a server crash. (Bug#17457)
- Repeated invocations of a stored procedure containing a `SHOW CREATE EVENT` statement would result in the error `PACKETS OUT OF ORDER`. (Bug#17403)
- For `FEDERATED` tables, a `SELECT` statement with an `ORDER BY` clause did not return rows in the proper order. (Bug#17377)
- `SELECT ... WHERE column LIKE 'A%'`, when `column` had a key and used the `latin2_czech_cs` collation, caused the wrong number of rows to be returned. (Bug#17374)
- Calling `CREATE TABLE` or `ALTER TABLE` twice on a partitioned table in a stored procedure or a prepared statement resulted in errors and sometimes server crashes. (Bug#17290)
- Checks for permissions on database operations could be performed in a case-insensitive manner (a user with permissions on database `MYDATABASE` could by accident get permissions on database `myDataBase`), if the privilege data were still cached from a previous check. (Bug#17279)
- Stored procedures that call UDFs and pass local string variables caused server crashes. (Bug#17261)
- A problem with `NULLs` and interval mapping sometimes caused incorrect results or crashes when trying to use less-than searches on partitioned tables. (Bug#17173)
- Attempting to add a new partition to a table partitioned by a unique key would cause an `OUT OF MEMORY` error. (Bug#17169)
- Creating a table with the same name as the mapped name of another table caused a server crash. For example, if MySQL maps the table name `txu#P#p1` to `txu@0023P@0023p1` on disk, creating another table named `txu@0023P@0023p1` crashed the server. (Bug#17142)
- Trying to add a partition to a table having subpartitions could crash the server. (Bug#17140)
- Attempting to use a conflicting `VALUES` clause in `ALTER TABLE ... ADD PARTITION` caused the server to crash. An example of such a conflicting clause would be that uses `VALUES LESS THAN (constant)` (which indicates a range) with a table that is partitioned by `LIST`. (Bug#17127)
- A failed `ALTER TABLE ... ADD PRIMARY KEY` on a partitioned table would result in bad table metadata and could possibly crash the server. (Bug#17097)
- Stored routine names longer than 64 characters were silently truncated. Now the limit is properly enforced and an error occurs. (Bug#17015)
- Cursors in stored routines could cause a server crash. (Bug#16887)
- Triggers created without `BEGIN` and `END` clauses resulted in “You have an error in your SQL syntax” errors when dumping and replaying a binary log. (Bug#16878)

- Using `ALTER TABLE` to increase the length of a `BINARY(M)` column caused column values to be padded with spaces rather than `0x00` bytes. (Bug#16857)
- `ALTER TABLE ... COALESCE PARTITION` failed with an `OUT OF MEMORY` error. (Bug#16810)
- `ALTER TABLE ... ADD COLUMN ... AFTER ...` failed when used on partitioned tables. (Bug#16806)
- If the server was started with the `--skip-grant-tables` option, it was impossible to create a trigger or a view without explicitly specifying a `DEFINER` clause. (Bug#16777)
- In a highly concurrent environment, a server crash or deadlock could result from execution of a statement that used stored functions or activated triggers coincident with alteration of the tables used by these functions or triggers. (Bug#16593)
- Clients compiled from source with the `--without-readline` did not save command history from session to session. (Bug#16557)
- Using `ORDER BY intvar` within a stored procedure (where `intvar` is an integer variable or expression) would crash the server.

**Note**

The use of an integer `i` in an `ORDER BY i` clause for sorting the result by the `i`<sup>th</sup> column is deprecated (and non-standard). It should *not* be used in new applications. See [Section 12.2.8, “SELECT Syntax”](#).

(Bug#16474)

- Slow queries executed by scheduled events were not being written to the slow query log. (Bug#16426)
- `INSERT` statements executed by scheduled events were not written to the general log. (Bug#16413)
- Repeated invocations of a stored procedure containing a `CREATE EVENT` or `ALTER EVENT` statement would crash the server. (Bug#16408)
- Names of subpartitions were not displayed in the output of `SHOW CREATE TABLE`. (Bug#16370)
- The `ExtractValue()` function would not accept expressions which matched element names containing an underscore character. (Bug#16320)
- The `self()` XPath function was not handled correctly by `ExtractValue()`. (Bug#16315)
- The `ExtractValue()` function allowed the use of the `!` character in identifiers by ignoring the illegal character. This is now correctly reported as a syntax error. (Bug#16313)
- A memory leak caused warnings on slaves for certain statements that executed without warning on the master. (Bug#16175)
- No error was reported when subpartitions were defined for a non-subpartitioned table. (Bug#15961)
- Character set conversion of string constants for `UNION` of constant and table column was not done when it was safe to do so. (Bug#15949)
- The `mysql_close()` C API function leaked handles for shared-memory connections on Windows. (Bug#15846)
- A `SELECT` using a function against a nested view would crash the server. (Bug#15683)
- Setting up subpartitions on at least one but not all the partitions of a partitioned table caused the server to crash. (Bug#15407)
- During conversion from one character set to `ucs2`, multi-byte characters with no `ucs2` equivalent were converted to multiple characters, rather than to `0x003F QUESTION MARK`. (Bug#15375)
- `CREATE TABLE ... PARTITION ... AS SELECT ...` would cause the server to crash. (Bug#15336)
- When attempting to insert a `0` into a `LIST`-partitioned table that had no value-list containing `0`, no error was reported. (Bug#15253)
- `SELECT COUNT(*)` for a `MyISAM` table could return different results depending on whether an index was used. (Bug#14980)
- Stored routines that contained only a single statement were not written properly to the dumpfile when using `mysqldump`. (Bug#14857)
- Execution of a stored function or trigger which inserted data into a table while running concurrent selects on the same table



could result in storing incorrect data in the query cache. (Bug#14767)

- Naming a partition using the characters Ç or ç (“c-cedilla”; Unicode 00C7 or 00E7) made unreadable the table containing the partition. (Bug#14527)
- Searches on indexed columns of partitioned tables failed to find all matching rows following updates of the indexed columns. (Bug#14526)
- Creating a partition which depends on an expression containing a column using the UTF8 character set would cause the server to crash. (Bug#14367)
- On Linux, creation of table partitions failed within a stored procedure. (Bug#14363)
- Invoking more than once a prepared statement that creates a partitioned table would crash the server. (Bug#14350)
- The `RENAME TABLE` statement did not move triggers to the new table. (Bug#13525)
- The server would execute stored routines that had a non-existent definer. (Bug#13198)
- The length of a `VARCHAR()` column that used the `utf8` character set would increase each time the table was re-created in a stored procedure or prepared statement, eventually causing the `CREATE TABLE` statement to fail. (Bug#13134)
- Loading of UDFs in a statically linked MySQL caused a server crash. UDF loading is now blocked if the MySQL server is statically linked. (Bug#11835)
- Setting the `myisam_repair_threads` system variable to a value larger than 1 could cause corruption of large `MyISAM` tables. (Bug#11527)
- Issuing `GRANT EXECUTE` on a procedure would display any warnings related to the creation of the procedure. (Bug#7787)

## C.2.31. Changes in MySQL 5.1.7 (27 February 2006)

Functionality added or changed:

- **Incompatible Change:** The `mysql_stmt_attr_get()` C API function now returns a boolean rather than an unsigned int for `STMT_ATTR_UPDATE_MAX_LENGTH`. (Bug#16144)
- **Incompatible Change:** Due to a change in the naming scheme for partitioning and subpartitioning files, it is not possible for the server to read partitioned tables created in previous MySQL versions. Attempting to read pre-5.1.6 partitioned tables with a MySQL 5.1.7 or later server now generates a suitable warning message.

Two possible workarounds are:

- 1. Create a non-partitioned table with the same table schema using a standard `CREATE TABLE` statement (that is, with no partitioning clauses)
  2. Issue a `SELECT INTO` to copy the data into the non-partitioned table before the upgrade  
Following the upgrade, you can partition the new table using `ALTER TABLE ... PARTITION BY ...`
- Alternatively, you can dump the table using `mysqldump` prior to upgrading and reload it afterwards with `LOAD DATA`. In either case, you should drop the pre-5.1.6 partitioned tables before upgrading to 5.1.6 or later.

### Important

If any partitioned tables that were created prior to MySQL 5.1.6 are present following an upgrade to MySQL 5.1.6 or later, it is also not possible to read from the `INFORMATION_SCHEMA.PARTITIONS` table, nor will you be able to drop those tables or the database or databases in which they are located. In this event, you must:

1. Shut down `mysqld`
2. Manually delete the table, partition, and (if any) subpartition files
3. Restart the MySQL Server

(Bug#13437, Bug#16695)

- **Incompatible Change:** `TYPE = engine_name` is no longer accepted as a synonym for the `ENGINE = engine_name` table option. (`TYPE` has been deprecated since MySQL 4.0.)



- **MySQL Cluster:** Attempting to `SELECT ... FROM INFORMATION_SCHEMA.FILES` now raises a warning in the event that the cluster has crashed. (Bug#17087)
- **Replication:** In row-based replication, when executing a `Rows_log_event`, the associated table was locked, the rows applied and the lock released. This did not work since there are storage engines that count locks and perform an autocommit when the number of locks reach zero. Now we ensure that all table maps come before all `ROWS` events in a statement.
- **Disk Data:** Status messages have been added to `ndb_restore` to enable users to know that data files for Disk Data are being created. (Bug#16873)
- **Cluster Replication:** It is now possible to replicate `NDB` tables having no explicit primary key. See [MySQL Cluster Replication](#).
- Creator privileges are now checked for all events before execution. (Bug#17289)
- `CREATE EVENT`, `DROP EVENT`, and `ALTER EVENT` statements are not allowed in triggers. (Bug#16410)
- The SQL mode in effect at the time an event is created or altered is recorded and used during event execution. (Bug#16407)
- New `charset` command added to `mysql` command-line client. By typing `charset name` or `\C name` (such as `\C UTF8`), the client character set can be changed without reconnecting. (Bug#16217)
- Added the `--wait-timeout` option to `mysqlmanager` to allow configuration of the timeout for dropping an inactive connection, and increased the default timeout from 30 seconds to 28,800 seconds (8 hours). (Bug#15980, Bug#12674)
- All subpartitions within a given partitioned table are now guaranteed to have unique names. (Bug#15408)
- `mysqlimport` now has a `--use-threads=N` option for loading data files in parallel using `N` threads.
- Added the `RENAME DATABASE` statement.
- Added the `PROCESSLIST` table to `INFORMATION_SCHEMA`.
- Several changes were made to make upgrades easier:
  - Added the `mysql_upgrade` program that checks all tables for incompatibilities with the current version of MySQL Server and repairs them if necessary. This program should be run for each MySQL upgrade (rather than `mysql_fix_privilege_tables`). See [Section 4.4.8, “mysql\\_upgrade — Check Tables for MySQL Upgrade”](#).
  - Added the `FOR UPGRADE` option for the `CHECK TABLE` statement. This option checks whether tables are incompatible with the current version of MySQL Server.
  - Added the `--check-upgrade` to `mysqlcheck` that invokes `CHECK TABLE` with the `FOR UPGRADE` option. Added the `--fix-db-names` and `--fix-table-names` options to `mysqlcheck`.
- Removed the `have_isam` and `have_raid` system variables.
- Added the `IN NATURAL LANGUAGE MODE` and `IN NATURAL LANGUAGE MODE WITH QUERY EXPANSION` modifiers for full-text searches. See [Section 11.8, “Full-Text Search Functions”](#).

**Bugs fixed:**

- **MySQL Cluster:** Creating `NDB` tables containing `BLOB` columns but no primary key caused unpredictable behavior. (Bug#17559)
- **MySQL Cluster:** Inserting the output of `REPEAT('some_string', some_int)` into a `BLOB` column resulted in the error `INVALID BLOB ATTRIBUTES OR INVALID BLOB PARTS TABLE`. (Bug#17505)
- **MySQL Cluster:** `ndbd` restarts could sometimes fail due to incorrect memory access. (Bug#17417)
- **MySQL Cluster:** Sharing of table names containing special characters between multiple SQL nodes was not handled correctly when binary logging was enabled (a timeout error resulted). (Bug#17415)
- **MySQL Cluster:** Table definitions were not shared between multiple SQL nodes in a cluster without binary logging being enabled. (Bug#17414)
- **MySQL Cluster:** Cluster log file paths were truncated to 128 characters. They may now be as long as `MAX_PATH` (the maximum path length permitted by the operating system). (Bug#17411)
- **MySQL Cluster:** `SHOW CREATE TABLE` would fail when run against a table created in a different session. (Bug#17340)

- **MySQL Cluster:** Following multiple forced shutdowns and restarts of data nodes, `DROP DATABASE` could fail. (Bug#17325)
- **MySQL Cluster:** The `REDO` log would become corrupted (and thus unreadable) in some circumstances, due to a failure in the query handler. (Bug#17295)
- **MySQL Cluster:** An `UPDATE` with an inner join failed to match any records if both tables in the join did not have a primary key. (Bug#17257)
- **MySQL Cluster:** A `DELETE` with a join in the `WHERE` clause failed to retrieve any records if both tables in the join did not have a primary key. (Bug#17249)
- **MySQL Cluster:** `CREATE TEMPORARY TABLE` of a Cluster table would fail with an `UNSUPPORTED` error or crash the server. (Bug#17210, Bug#16552)
- **MySQL Cluster:** The storage engine did not allow views to be updated. (Bug#17206)
- **MySQL Cluster:** When attempting to import data into an `NDB` table using `LOAD DATA INFILE`, the server would hang in the event of a duplicate key error. (Bug#17154)
- **MySQL Cluster:** In some cases, `LOAD DATA INFILE` did not load all data into `NDB` tables. (Bug#17081)
- **MySQL Cluster:** `CREATE TABLE new_tbl LIKE old_tbl;` failed when `old_tbl` used the `NDB` storage engine. (Bug#17005)
- **MySQL Cluster:** An unhandled resources issue could cause node failure with a `DELETE FROM TABLE` affecting thousands of rows. (Bug#16492)
- **MySQL Cluster:** `UNIQUE` keys in Cluster tables were limited to 225 bytes in length. (Bug#15918)
- **MySQL Cluster:** `REPLACE` failed when attempting to update a primary key value in a Cluster table. (Bug#14007)
- **MySQL Cluster:** No error message was generated for setting `NoOfFragmentLogFiles` too low. (Bug#13966)
- **MySQL Cluster:** No error message was generated for setting `MaxNoOfAttributes` too low. (Bug#13965)
- **MySQL Cluster:** Performing large numbers of data manipulation statements on cluster tables using Disk Data could lead to a server crash.
- **Cluster Replication: Replication:** Row-based replication of a cluster failed to take `--binlog-ignore-db` settings into account. (Bug#17188)
- **Replication:** An `ALTER DATABASE` statement on a replication master crashed the slaves. (Bug#17521)
- **Replication:** For a transaction that used `MyISAM` and `InnoDB` tables, interruption of the transaction due to a dropped connection on a master server caused slaves to lose synchrony. (Bug#16559)
- **Replication:** Previously, a stored function invocation was written to the binary log as `DO func_name()` if the invocation changes data and occurs within a non-logged statement, or if the function invokes a stored procedure that produces an error. These invocations now are logged as `SELECT func_name()` instead for better control over error code checking (slave servers could stop due to detecting a different error than occurred on the master). (Bug#14769)
- **Replication:** `BIT` fields were not properly handled when using row-based replication. (Bug#13418)
- **Disk Data:** In some cases, a cluster using Disk Data tables could not be restarted following a normal shutdown. (Bug#16872)
- **Cluster Replication:** Row-based replication was not set up correctly if a backup was already in progress. For example, connecting a `mysqld` instance to a cluster which was being backed up would result in the message `NDB: SKIPPING SETUP TABLE TBL_NAME` being written to the error log. (Bug#17459)
- **Cluster Replication:** Cluster tables not having an explicit primary key could not be replicated. (Bug#14541)
- Column counts were encoded incorrectly in the binary log for row-based logging format. (Bug#17678)
- Data truncations on non-`UNIQUE` indexes could crash `InnoDB` when using multi-byte character sets. (Bug#17530)
- Execution times for scheduled events were not calculated correctly: the last execution time was used as a base rather than the actual start time. (Bug#17494)
- Creating an event and using a whitespace character other than space following the `DO` keyword caused a server crash. (Bug#17453)

- Partitioning with certain `SUBPARTITION BY HASH` clauses caused an error when querying for a partitioned column using an `IS NULL` comparison. (Bug#17430, Bug#17432)
- Race conditions between event creation, dropping, and execution could result in a server crash or hang. (Bug#17373)
- Trying to create a partitioned table with more than 32 attributes failed. (Bug#17179)
- Attempting to add a new partition to a table partitioned by a unique key would cause an `OUT OF MEMORY` error. (Bug#17169)
- `myisam_ftdump` did not work for `FULLTEXT` indexes associated with a parser plugin. (Bug#17116)
- On Windows platforms, some attempts to create partitioned tables from the command line would cause the `mysql` client to hang. (Bug#17082)
- A `SELECT` from the last partition of a subpartitioned table having a `UNIQUE KEY` could crash the MySQL Server. (Bug#16907)
- Statements that contained Unicode characters were not logged to the log tables correctly. (Bug#16905)
- A `SELECT` on a subpartitioned table having a multiple-column `PRIMARY` or `UNIQUE KEY`, and whose partitioning function used only the first column of the key, could cause `mysqld` to crash. (Bug#16901)
- A `RETURN` statement within a trigger caused a server crash. `RETURN` now is disallowed within triggers. To exit immediately, use `LEAVE`. (Bug#16829)
- Using `REPLACE INTO` on a partitioned table having a primary key would crash the server in the event of a duplicate key error. (Bug#16782)
- `DROP TABLE` would sometimes fail on a table having subpartitions that used the default storage engine. (Bug#16775)
- If the query optimizer transformed a `GROUP BY` clause in a subquery, it did not also transform the `HAVING` clause if there was one, producing incorrect results. (Bug#16603)
- Querying the `INFORMATION_SCHEMA.PARTITIONS` table on a non-max server caused a server crash. This also happened following the creation of a table with a very large number (hundreds) of partitions. (Bug#16591, Bug#17141)
- `SHOW CREATE EVENT` displayed no output. (Bug#16423)
- `DROP DATABASE` did not drop events for the database. (Bug#16406)
- The `mysql_fix_privilege_tables.sql` script did not properly initialize the `Event_priv` column to 'Y' for those accounts that should have the `EVENT` privilege. (Bug#16400)
- `SELECT` with `GROUP BY` on a view could cause a server crash. (Bug#16382)
- MySQL server dropped client connection for certain `SELECT` statements against views defined that used `MERGE` algorithm. (Bug#16260)
- Using an XPath expression containing `=` with `ExtractValue()` caused the server to crash. (Bug#16242)
- When used with the `ExtractValue()` function, an XPath expression having no leading `/` character would crash the server. (Bug#16234)
- Using `GROUP BY` on column used in `WHERE` clause could cause empty set to be returned. (Bug#16203)
- `CAST(... AS TIME)` operations returned different results when using versus not using prepared-statement protocol. (Bug#15805)
- The `SELECT` privilege was required for triggers that performed no selects. (Bug#15196)
- The `UPDATE` privilege was required for triggers that performed no updates. (Bug#15166)
- A statement containing `GROUP BY` and `HAVING` clauses could return incorrect results when the `HAVING` clause contained logic that returned `FALSE` for every row. (Bug#14927)
- Killing a long-running query containing a subquery could cause a server crash. (Bug#14851)
- `SUBSTRING_INDEX()` could yield inconsistent results when applied with the same arguments to consecutive rows in a query. (Bug#14676)
- `SET sql_mode = N`, where  $N > 31$ , did not work properly. (Bug#13897)

- `SHOW CREATE TABLE` produced extraneous spaces following the keywords “`PRIMARY KEY`”. (Bug#13883)
- InnoDB could display an incorrect error message for a cascading update. (Bug#9680)
- `CHECKSUM TABLE` returned different values for MyISAM tables depending on whether the `QUICK` or `EXTENDED` option was used. (Bug#8841)
- `SET TRANSACTION ISOLATION LEVEL` acted like `SET SESSION TRANSACTION ISOLATION LEVEL`. That is, it set the isolation level for longer than the next transaction. (Bug#7955)
- Repeated invocation of `my_init()` and `my_end()` caused corruption of character set data and connection failure. (Bug#6536)

## C.2.32. Changes in MySQL 5.1.6 (01 February 2006)

Functionality added or changed:

- **Incompatible Change:** Words with apostrophes are now matched in a `FULLTEXT` search against non-apostrophe words (for example, a search for `Jerry` will match against the term `Jerry's`). Users upgrading to this version must issue `REPAIR TABLE ... QUICK` statements for tables containing `FULLTEXT` indexes. (Bug#14194)
- **Incompatible Change:** This release introduces the `TRIGGER` privilege. Previously, the `SUPER` privilege was needed to create or drop triggers. Now those operations require the `TRIGGER` privilege. This is a security improvement because you no longer need to grant users the `SUPER` privilege to enable them to create triggers. However, the requirement that the account named in a trigger's `DEFINER` clause must have the `SUPER` privilege has changed to a requirement for the `TRIGGER` privilege. After upgrading, be sure to update your grant tables by running `mysql_upgrade`. This will assign the `TRIGGER` privilege to all accounts that had the `SUPER` privilege. (After updating, you might also consider whether any of those accounts no longer need the `SUPER` privilege.) If you fail to update the grant tables, triggers may fail when activated. (Bug#9412)
- **Incompatible Change:** Before MySQL 5.1.6, the server writes general query log and slow query log entries to log files. As of MySQL 5.1.6, the server's logging capabilities for these logs are more flexible. Log entries can be written to log files (as before) or to the `general_log` and `slow_log` tables in the `mysql` database. If logging is enabled, either or both destinations can be selected. The `--log-output` option controls the destination or destinations of log output. See [Section 5.2.1, “Selecting General Query and Slow Query Log Output Destinations”](#).  
  
If logging is enabled, the default destination now is to log to tables, which differs from earlier versions. If you had the server configured for logging to log files formerly, use `--log-output=FILE` to preserve this behavior after an upgrade to MySQL 5.1.6 or higher.
- **Important Change: MySQL Cluster: Replication:** Replication between MySQL Clusters is now supported. It is now also possible to replicate between a MySQL Cluster and a non-cluster database. See [MySQL Cluster Replication](#), for more information.
- **MySQL Cluster:** Added the `ndb_extra_logging` system variable.
- **MySQL Cluster:** The `NDB` storage engine now supports the `CREATE INDEX` and `DROP INDEX` statements.
- **Packaging:** MySQL 5.1.6 introduces some changes to distribution packaging:
  - Distributions include both a `mysqld` optimized server and `mysqld-debug` debugging server. There is no separate debug distribution.
  - There is no longer a `mysqld-max` server. (Note: This changed in MySQL 5.1.9: The `mysqld-max` server also is included in binary distributions.)
  - Server binaries no longer are stripped, except for RPM distributions.
  - Binary distributions for Unix and Unix-like systems no longer include `safe_mysqld` as a link to `mysqld_safe`. `safe_mysqld` has been deprecated since MySQL 4.0 and now is removed.
- The `mysqldump` utility now supports an option for dumping tablespaces. Use `-Y` or `--all-tablespaces` to enable this functionality. (Bug#16753)
- Partition support is not an “engine”, but it was included in the output of `SHOW ENGINES`. Now it is not. The `have_partition_engine` variable was renamed to `have_partitioning`. (Bug#14355, Bug#16718)
- `ANALYZE TABLE` is now supported for partitioned tables. (Bug#13441)
- Added the `--use-threads` option for `mysqslap`.

- Queries against partitioned tables can now take advantage of partition pruning. In some cases, this can result in query execution that is an order of magnitude faster than the same query against a non-partitioned version of the same table.
- There is no longer a `mysqld-max` server. (Note: This changed in MySQL 5.1.9: The `mysqld-max` server also is included in binary distributions.)
- Added the `FILES` table to `INFORMATION_SCHEMA`.
- Binary distributions for Unix and Unix-like systems no longer include `safe_mysqld` as a link to `mysqld_safe`. `safe_mysqld` has been deprecated since MySQL 4.0 and now is removed.
- Special characters in database and table identifiers now are encoded when creating the corresponding directory names and file names. This relaxes the restrictions on the characters that can appear in identifiers. See [Section 8.2.3, “Mapping of Identifiers to File Names”](#).
- Added the `event_scheduler` system variable.
- MySQL 5.1.6 introduces the *Event Scheduler* which allows one to schedule statements for execution at predetermined times. Events can be transient (one-time-only) or recurrent at regular intervals, and may execute queries and statements permitted in stored routines, including compound statements.

Events can be altered after creation, and dropped when no longer needed.

Information about scheduled events can be obtained using the statements `SHOW EVENTS` and `SHOW CREATE EVENT`, or by querying the `INFORMATION_SCHEMA.EVENTS` table. All of these are available beginning in MySQL 5.1.6.

Users must have the `EVENT` privilege (also added in 5.1.6) to create events.

For more information, see [Section 18.4, “Using the Event Scheduler”](#).

- Distributions include both a `mysqld` optimized server and `mysqld-debug` debugging server. There is no separate debug distribution.
- Server binaries no longer are stripped, except for RPM distributions.
- The `ARCHIVE` storage engine now supports the `AUTO_INCREMENT` column attribute and the `AUTO_INCREMENT` table option. [Section 13.11, “The ARCHIVE Storage Engine”](#).
- Server plugins can register their own status variables to be displayed by the `SHOW STATUS` statement.
- Added the `PARTITIONS` table to `INFORMATION_SCHEMA`.
- Added the `EVENTS` table to `INFORMATION_SCHEMA`.

Bugs fixed:

- **MySQL Cluster:** `NDB` leaked disk space when performing repeated `INSERT` or `DELETE` statements. ([Bug#16771](#))
- **MySQL Cluster:** `ndb_delete_all` ran out of memory when processing tables containing `BLOB` columns. ([Bug#16693](#))
- **MySQL Cluster:** Trying to import too many dumped tables requiring resources beyond those allocated in the cluster configuration file caused the server to crash instead of reporting an insufficient resources error. ([Bug#16455](#))
- **MySQL Cluster:** A `BIT` column whose offset and length totaled 32 caused the cluster to crash. ([Bug#16125](#))
- **MySQL Cluster:** The `ndb_autodiscover` test failed sporadically due to a node not being permitted to connect to the cluster. ([Bug#15619](#))
- **MySQL Cluster:** `NDB` returned an incorrect `CAN'T FIND FILE ERROR` for OS error 24; this has been changed to `TOO MANY OPEN FILES`. ([Bug#15020](#))
- **MySQL Cluster:** `CREATE TABLESPACE` statements were incorrectly parsed on 64-bit platforms. (`INITIAL SIZE size` worked, but `INITIAL SIZE = size` failed.) ([Bug#13556](#))
- **MySQL Cluster:** Using `mysqldump` to obtain a dump of a partitioned table employing the `NDB` storage engine produced a non-functional table creation statement. ([Bug#13155](#))
- **Disk Data:** Tablespaces created using parameters with relatively low values (10 MB or less) produced filesizes much smaller than expected. ([Bug#16742](#))

- **Disk Data:** `NDB` returned the wrong error when the tablespace on disk was full. (Bug#16738)
- **Disk Data:** The error message generated by a failed `ADD UNDOFILE` did not provide any reasons for the failure. (Bug#16267)
- **Disk Data:** `DROP LOGFILE GROUP` corrupted the cluster file system and caused `ndbd` to fail when running more than one node on the same system. (Bug#16193)
- **Cluster API:** Upon the completion of a scan where a key request remained outstanding on the primary replica and a starting node died, the scan did not terminate. This caused incomplete error handling for the failed node. (Bug#15908)
- When the fulltext search parser plugin returned more words than half of the length (in bytes) of the query string, the server would crash. (Bug#16722)
- An indexing error sometimes caused values to be assigned to the wrong `RANGE` partition. (Bug#16684)
- An `INSERT` statement in a stored procedure corrupted the binary log. (Bug#16621)
- Trying to add more than one partition in a single `ALTER TABLE ... ADD PARTITION` statement caused the server to crash. (Bug#16534)
- Parallel builds occasionally failed on Solaris. (Bug#16282)
- Inserting a negative value into an integer column used as the partitioning key for a table partitioned by `HASH` could cause the server to crash. (Bug#15968)
- Creating a partitioned table using a storage engine other than the session default storage engine caused the server to crash. (Bug#15966)
- The error message for specifying values for which no partition exists returned wrong values on certain platforms. (Bug#15910)
- Specifying a value for `--tmpdir` without a trailing slash had unpredictable results. (Bug#15904)
- `STR_TO_DATE(1, NULL)` caused a server crash. (Bug#15828, CVE-2006-3081)
- `ALTER TABLE ... ADD PARTITIONS` on a table with one partition crashed the server. (Bug#15820)
- The `mysql_real_connect()` C API function incorrectly reset the `MYSQL_OPT_RECONNECT` option to its default value. (Bug#15719)
- In some cases the query optimizer did not properly perform multiple joins where inner joins followed left joins, resulting in corrupted result sets. (Bug#15633)
- Certain permission management statements could create a `NULL` host name for a user, resulting in a server crash. (Bug#15598)
- Improper memory handling for stored routine variables could cause memory overruns and binary log corruption. (Bug#15588)
- The absence of a table in the left part of a left or right join was not checked prior to name resolution, which resulted in a server crash. (Bug#15538)
- An `ALTER TABLE ... PARTITION BY ...` statement did not have any effect. (Bug#15523)
- Using `RANGE` partitioning with a `CASE` expression as the partitioning function would cause records to be placed in the wrong partition. (Bug#15393)
- Certain subqueries where the inner query was the result of an aggregate function would return different results with MySQL 5.1 than with MySQL 4.1.  
Subselects could also return wrong results when the query cache and grouping were involved. (Bug#15347)
- Attempting to insert data into a partitioned table that used the `BLACKHOLE` storage engine caused `mysqld` to crash. (Bug#14524)
- A `FULLTEXT` query in a prepared statement could result in unexpected behavior. (Bug#14496)
- With a table partitioned by `LIST`, inserting a value which was smaller than any value shown in the partitioning value-lists could cause the server to crash. (Bug#14365)
- The `DATA DIRECTORY` and `INDEX DIRECTORY` clauses of a `CREATE TABLE` statement involving partitions did not work. (Bug#14354)
- `SHOW CREATE TABLE` did not display the `PARTITIONS` clause for tables partitioned by `HASH` or `KEY`. (Bug#14327)



- `ALTER TABLE ... DROP PARTITION` would truncate all `DATE` column values in the table's remaining partitions to `NULL`. (Bug#13644)
- `ALTER TABLE ... ADD PARTITION` could crash the server or cause an `OUT OF MEMORY` error in some circumstances. (Bug#13447)
- The server would allow foreign keys to be declared in the definition of a partitioned table despite the fact that partitioned tables do not support foreign keys (see Section 17.5, “Restrictions and Limitations on Partitioning”). (Bug#13446)
- A `SELECT` from a key-partitioned table with a multi-column key could cause the server to crash. (Bug#13445)
- Issuing a `TRUNCATE` statement twice in succession on the same partitioned table would cause the server to crash. (Bug#13442)
- Using a `REPLACE` statement on a partitioned table caused the server to crash. (Bug#13440)
- Using an identifier rather than a literal integer value in the `LESS THAN` clause of a range-partitioned table could cause the server to crash and corruption of tables. (Bug#13439)
- Using `ENGINE=...` within a `PARTITION` clause could cause the server to crash. (Bug#13438)
- `CREATE TABLE ... LIKE` did not work if the table whose schema was to be copied was a partitioned table. (Bug#13435)
- Multi-byte path names for `LOAD DATA` and `SELECT ... INTO OUTFILE` caused errors. Added the `character_set_filesystem` system variable, which controls the interpretation of string literals that refer to file names. (Bug#12448)
- Temporary table aliasing did not work inside stored functions. (Bug#12198)
- Using the `TRUNCATE( )` function with a negative number for the second argument on a `BIGINT` column returned incorrect results. (Bug#8461)
- Certain Japanese table names were not properly saved during a `CREATE TABLE` statement. (Bug#3906)

## C.2.33. Changes in MySQL 5.1.5 (10 January 2006)

Functionality added or changed:

- **Replication:** Added the `binlog_format` system variable that controls whether to use row-based or statement-based binary logging. Added the `--binlog-format` and `--binlog-row-event-max-size` server options for binary logging control. See Section 16.1.2, “Replication Formats”.
- Added the `--port-open-timeout` option to `mysqld` to control how many seconds the server should wait for the TCP/IP port to become free if it cannot be opened. (Bug#15591)
- A new statement, `BINLOG`, is generated by `mysqlbinlog` to represent row-based events in binary log files. The statement argument, a base 64-encoded string, is decoded by the server to determine the data change indicated by the corresponding event.
- Added the `--create-schema`, `--lock-directory`, `--number-of-queries`, `--only-print`, `--preserve-schema`, and `--slave` options for `mysqld`.
- If `innodb_locks_unsafe_for_binlog` is enabled or if the transaction isolation mode is `READ COMMITTED`, InnoDB can use “semi-consistent” reads. This affects treatment by `UPDATE` statements for rows that are already locked by another transaction. If a row is locked, InnoDB returns the latest committed version to MySQL so that MySQL can determine whether the row matches the `WHERE` condition of the `UPDATE`. If the row matches (must be updated), MySQL reads the row again and this time InnoDB either locks it or waits for a lock on it.

See also Bug#3300.

- Added the `--base64-output` option to `mysqlbinlog` to print all binary log entries using base64 encoding. This is for debugging only. Logs produced using this option should not be applied on production systems.
- Added the `INFORMATION_SCHEMA PLUGINS` table and the `SHOW PLUGIN` statement.
- Two new Hungarian collations are included: `utf8_hungarian_ci` and `ucs2_hungarian_ci`. These support the correct sort order for Hungarian vowels. However, they do not support the correct order for sorting Hungarian consonant contractions; we expect to fix this issue in a future release.
- Plugins now can have status variables that are displayed in the output from `SHOW STATUS`. See Section 21.2.3, “Writing Plugins”.

- Added the `INFORMATION_SCHEMA ENGINES` table.
- Added the XML functions `ExtractValue()` and `UpdateXML()`. `ExtractValue()` returns the content of a fragment of XML matching a given XPath expression. `UpdateXML()` replaces the element selected from a fragment of XML by an XPath expression supplied by the user with a second XML fragment (also user-supplied), and returns the modified XML. See [Section 11.10, “XML Functions”](#).

Bugs fixed:

- `INSERT DELAYED` caused `mysqld` to crash. ([Bug#16095](#))
- The `--plugin_dir` option was not working. Specifying the parser name for fulltext also did not work correctly. ([Bug#16068](#))
- Attempting to insert into a table partitioned by `LIST` a value less than any specified in one of the table's partition definitions resulted in a server crash. In such cases, `mysqld` now returns `ERROR 1500 (HY000): TABLE HAS NO PARTITION FOR VALUE v`, where `v` is the out-of-range value. ([Bug#15819](#))
- Issuing a `DROP USER` command could cause some users to encounter a `hostname is not allowed to connect to this MySQL server` error. ([Bug#15775](#))
- The output of `mysqldump --triggers` did not contain the `DEFINER` clause in dumped trigger definitions. ([Bug#15110](#))
- The output of `SHOW TRIGGERS` contained extraneous whitespace. ([Bug#15103](#))
- Creating a trigger caused a server crash if the table or trigger database was not known because no default database had been selected. ([Bug#14863](#))
- `InnoDB`: Comparison of indexed `VARCHAR CHARACTER SET ucs2 COLLATE ucs2_bin` columns using `LIKE` could fail. ([Bug#14583](#))
- A `COMMIT` statement followed by a `ALTER TABLE` statement on a BDB table caused server crash. ([Bug#14212](#))
- An `INSERT ... SELECT` statement between tables in a `MERGE` set can return errors when statement involves insert into child table from merge table or vice-versa. ([Bug#5390](#))
- `InnoDB`: A semi-consistent read for an `UPDATE` statement with no index column in the `WHERE` condition locked all the rows in the table. ([Bug#3300](#))

## C.2.34. Changes in MySQL 5.1.4 (21 December 2005)

Functionality added or changed:

- Added the `--server-id` option to `mysqlbinlog` to enable only those events created by the server having the given server ID to be extracted. ([Bug#15485](#))
- It is now possible to build the server such that `MyISAM` tables can support up to 128 keys rather than the standard 64. This can be done by configuring the build using the option `--with-max-indexes=N`, where  $N \leq 128$  is the maximum number of indexes to permit per table. ([Bug#10932](#))
- Added the `myisam_use_mmap` system variable.
- Added the `--bdb-data-direct` and `--bdb-log-direct` server options.
- Added the `mysqslap` program, which is designed to emulate client load for a MySQL server and report the timing of each stage. It works as if multiple clients are accessing the server.
- The bundled `BDB` library was upgraded to version 4.4.16.
- Added the `cp1250_polish_ci` collation for the `cp1250` character set.

Bugs fixed:

- **MySQL Cluster:** The `--ndb` option for `perror` did not function. ([Bug#15486](#))



- **MySQL Cluster:** Using `ORDER BY primary_key_column` when selecting from a table having the primary key on a `VARCHAR` column caused a forced shutdown of the cluster. (Bug#15240, Bug#15682, Bug#14828, Bug#15517)
- Server could not be built on default Debian systems with BDB enabled. (Bug#15734)
- `SHOW ENGINES` output showed the `FEDERATED` engine as `DISABLED` even for builds with `FEDERATED` support. (Bug#15559)
- `BDB`: A `DELETE`, `INSERT`, or `UPDATE` of a `BDB` table could cause the server to crash where the query contained a subquery using an index read. (Bug#15536)
- It was not possible to reorganize a partition reusing a discarded partition name.

Now, for example, you can create a table such as this one:

```
CREATE TABLE t1 (a INT)
PARTITION BY RANGE (a) (
  PARTITION p0 VALUES LESS THAN (10),
  PARTITION p1 VALUES LESS THAN (20),
  PARTITION p2 VALUES LESS THAN MAXVALUE
);
```

and then repartition it as shown here:

```
ALTER TABLE t1 REORGANIZE PARTITION p2 INTO (
  PARTITION p2 VALUES LESS THAN (30)
);
```

Previously, attempting to do so would produce the error `ALL PARTITIONS MUST HAVE UNIQUE NAMES IN THE TABLE`. (Bug#15521)

- The `BLACKHOLE` storage engine did not handle transactions properly: Rolled-back transactions were written to the binary log. Now they are not. (Bug#15406)
- A left join on a column that having a `NULL` value could cause the server to crash. (Bug#15268)
- Selecting from a view processed with the temptable algorithm caused a server crash if the query cache was enabled. (Bug#15119)
- Creating a view that referenced a stored function that selected from a view caused a crash upon selection from the view. (Bug#15096)
- Multiple-table update operations were counting updates and not updated rows. As a result, if a row had several updates it was counted several times for the “rows matched” value but updated only once. (Bug#15028)
- `ROW_COUNT()` returned an incorrect result after `EXECUTE` of a prepared statement. (Bug#14956)
- `ANALYZE TABLE` did not properly update table statistics for a `MyISAM` table with a `FULLTEXT` index containing stopwords, so a subsequent `ANALYZE TABLE` would not recognize the table as having already been analyzed. (Bug#14902)
- Creating a view within a stored procedure could result in an out of memory error or a server crash. (Bug#14885)
- `SELECT` queries that began with an opening parenthesis were not being placed in the query cache. (Bug#14652)
- Space truncation was being ignored when inserting into `BINARY` or `VARBINARY` columns. Now space truncation results in a warning, or an error in strict mode. (Bug#14299)
- The maximum value of `MAX_ROWS` was handled incorrectly on 64-bit systems. (Bug#14155)
- For binary string data types, `mysqldump --hex-blob` produced an illegal output value of `0x` rather than `'`. (Bug#13318)
- Some comparisons for the `IN()` operator were inconsistent with equivalent comparisons for the `=` operator. (Bug#12612)
- Attempts to assign `NULL` to a `NOT NULL` column in strict mode now result in a message of `Column 'col_name' cannot be null`, rather than `Column set to default value; NULL supplied to NOT NULL column 'col_name' at row n`. (Bug#11491)
- `SHOW CREATE DATABASE` was sometimes refused when the client had privileges for the database. (Bug#9785)
- Invalid casts to `DATE` values now result in a message of `Incorrect datetime value`, rather than `Truncated incorrect datetime value`. (Bug#8294)

- `mysql` ignored the `MYSQL_TCP_PORT` environment variable. (Bug#5792)

## C.2.35. Changes in MySQL 5.1.3 (29 November 2005)

Functionality added or changed:

- **Plugin API: Incompatible Change:** MySQL 5.1 adds support for a very flexible plugin API that enables loading and unloading of various components at runtime, without restarting the server. Although the work on this is not finished yet, *plugin full-text parsers* are a first step in this direction. This allows users to implement their own input filter on the indexed text, enabling full-text search capability on arbitrary data such as PDF files or other document formats. A pre-parser full-text plugin performs the actual parsing and extraction of the text and hands it over to the built-in MySQL full-text search. (Author: Sergey Vojtovich)

The plugin API requires the `mysql.plugin` table. When upgrading from an older version of MySQL, you should run the `mysql_fix_privilege_tables` command to create this table. See Section 4.4.4, “`mysql_fix_privilege_tables` — Upgrade MySQL System Tables”.

Plugins are installed in the directory named by the `plugin_dir` system variable. This variable also controls the location from which the server loads user-defined functions (UDFs), which is a change from earlier versions of MySQL. That is, all UDF library files now must be installed in the plugin directory. When upgrading from an older version of MySQL, you must migrate your UDF files to the plugin directory.

- **Incompatible Change:** Renamed the `table_cache` system variable to `table_open_cache`. Any scripts that refer to `table_cache` should be updated to use the new name.
- **MySQL Cluster:** `VARCHAR` columns used in MySQL Cluster tables are now variable-sized; that is, they now only allocate as much space as required to store the data. Previously, a `VARCHAR(n)` column allocated `n+2` bytes (aligned to 4 bytes), regardless of whether the actual inserted value required that much space. (In other words, a `VARCHAR` column always required the same, fixed, amount of storage as a `CHAR` column of the same size.)
- **Partitioning:** allows distributing portions of individual tables across a file system, according to rules which can be set when the table is created. In effect, different portions of a table are stored as separate tables in different locations, but from the user point of view, the partitioned table is still a single table. See Chapter 17, *Partitioning*, for further information on this functionality. (Author: Mikael Ronström)
- `RAND()` no longer allows non-constant initializers. (Prior to MySQL 5.1.3, the effect of non-constant initializers is undefined.) (Bug#6172)
- Added the `table_definition_cache` system variable. If you use a large number of tables, you can create a large table definition cache to speed up opening of tables. The table definition cache takes less space and does not use file descriptors, unlike the normal table cache.
- `SET instance_name.option_name=option_value` sets an option to the specified value and writes it to the config file See Section 4.6.10, “`mysqlmanager` — The MySQL Instance Manager”, for more details on these new commands. (Author: Petr Chardin)
- `SHOW instance_name LOG FILES` provides a listing of all log files used by the instance. (Author: Petr Chardin)
- Added the `SHOW AUTHORS` statement.
- Fast `ALTER TABLE`: Operations that change only table metadata and not table data do not require a temporary table to be used, which improves performance. For example, renaming a column changes only the `.frm` file and no longer uses a temporary table.
- **The Instance Manager (IM)** now has some additional functionality:
  - `SHOW instance_name LOG FILES` provides a listing of all log files used by the instance. (Author: Petr Chardin)
  - `SHOW instance_name LOG {ERROR | SLOW | GENERAL} size` retrieves a part of the specified log file. (Author: Petr Chardin)
  - `SET instance_name.option_name=option_value` sets an option to the specified value and writes it to the config file See Section 4.6.10, “`mysqlmanager` — The MySQL Instance Manager”, for more details on these new commands. (Author: Petr Chardin)
- `SHOW instance_name LOG {ERROR | SLOW | GENERAL} size` retrieves a part of the specified log file. (Author: Petr Chardin)

- Added the `SHOW FUNCTION CODE` and `SHOW PROCEDURE CODE` statements (available only for servers that have been built with debugging support). See [Section 12.5.5.29, “SHOW PROCEDURE CODE Syntax”](#).
- The performance of boolean full-text searches (using the “+” Operator) has been improved. See [Section 11.8, “Full-Text Search Functions”](#), for more details about full-text searching. (Author: Sergey Vojtovich)

Bugs fixed:

- `RESET MASTER` failed to delete log files on Windows. One consequence of this change is that server opens the general query and slow log files in shared mode, so now they can be renamed while the server has them open (something not true in previous versions). ([Bug#13377](#))
- Set functions could not be aggregated in outer subqueries. ([Bug#12762](#))

## C.2.36. Changes in MySQL 5.1.2 (Not released)

Functionality added or changed:

- Added the `bdb_cache_parts` and `bdb_region_size` system variables, and allowed `bdb_cache_size` to be larger than 4GB on systems that support it. ([Bug#14895](#))
- Added `MAXLOCKS`, `MINLOCKS`, `MAXWRITE`, and `MINWRITE` as allowable values of the `--bdb-lock-detect` option. ([Bug#14876](#))
- Added `--replace` to `mysqldump`. This option uses `REPLACE INTO`, rather than `INSERT INTO`, when writing the dump-file.
- Added `Transactions`, `XA`, and `Savepoints` columns to `SHOW ENGINES` output.

Bugs fixed:

- Foreign keys were not properly enforced in `TEMPORARY` tables. Foreign keys now are disallowed in `TEMPORARY` tables. ([Bug#12084](#))

## C.2.37. Changes in MySQL 5.1.1 (Not released)

Bugs fixed:

- **Partitioning: MySQL Cluster:** Specifying the wrong nodegroup in a `CREATE TABLE` statement using partitioning would lead to the table name being locked after the statement failed (that is, the table name could not be re-used). ([Bug#12114](#))
- Using `ORDER BY` in a query with a partitioned table on a 64-bit operating system could crash the server. ([Bug#12116](#))
- Performing a `CREATE TABLE` statement with a `PARTITION BY` clause in a prepared statement could crash a server running in debug mode. ([Bug#12097](#))
- When two threads competed for the same table, a deadlock could occur if one thread also had a lock on another table through `LOCK TABLES` and the thread was attempting to remove the table in some manner while the other thread tried to place locks on both tables. ([Bug#10600](#))

## C.3. MySQL Enterprise Monitor Change History

This appendix lists the changes to the MySQL Enterprise Monitor, beginning with the most recent release. Each release section covers added or changed functionality, bug fixes, and known issues, if applicable. All bug fixes are referenced by bug number and include a link to the bug database. Bugs are listed in order of resolution. To find a bug quickly, search by bug number.

### C.3.1. Changes in MySQL Enterprise Monitor 2.1.0 (Not yet released)

This section documents all changes and bug fixes that have been applied since the release of MySQL Enterprise Monitor, version 2.0.6.

## Functionality added or changed:

- The agent should be able to run as a non-root user. However, the startup scripts always started it as root.

The agent chassis now has a new option `--user` to drop privileges after being started as root. Note, this does not work when not started as superuser, nor on Windows.

A new dialog box has also been added to the agent installer. The dialog has the following text: “The agent does not need to run with root user privileges. The agent will switch to the user account provided below when started by the root user.”

The dialog also has a text field to allow the entry of the user account.

A new parameter was also added to the `mysql-monitor-agent.ini` file. The parameter has the format `user=xxx`, where xxx is the user account to be used. ([Bug#33778](#))

## Bugs fixed:

- The recommendation for the rule `Table Cache Not Optimal` says:

```
Recommended Action
SET GLOBAL table_cache = (64 + 16);
```

But an error was generated on executing that query:

```
mysql> SET GLOBAL table_cache = (64 + 16);
ERROR 1193 (HY000): Unknown system variable 'table_cache'

mysql> select version();
+-----+
| version() |
+-----+
| 5.1.31-log |
+-----+
1 row in set (0.01 sec)
```

([Bug#44602](#))

- The Mac OS X version of the Service Manager uses the system JRE. The system JRE loads the libraries located in `/Library/Java/Extensions`. As libraries in the extensions directory take precedence over other libraries, this caused conflicts when user extension libraries were installed there, as these would be used by the JRE when running Service Manager, instead of the shipped libraries. This happened when Java-related products were installed such as Connector/J, Spring, and Hibernate.

This fix stops user-installed extension libraries from being used when the JRE runs the Service Manager, thus giving a “pristine” environment with no library collisions. ([Bug#44157](#))

- Accessing the Query Analyzer tab caused a full table scan to take place on the MySQL Enterprise Monitor database. ([Bug#43989](#))
- The Replication Group was renamed back to its default name after a new topology was discovered. ([Bug#43816](#))
- A new topology was not discovered after the previous replication group was renamed. ([Bug#43815](#))
- On Unix systems, executing the command:

```
./mysqlmonitorctl.sh stop
```

did not make sure that `mysqld` was shutdown before finishing.

This resulted in a situation such as the following:

```
# /opt/mysql/enterprise/monitor-2.0.0.7092/mysqlmonitorctl.sh stop
Using CATALINA_BASE: /opt/mysql/enterprise/monitor/apache-tomcat
Using CATALINA_HOME: /opt/mysql/enterprise/monitor/apache-tomcat
Using CATALINA_TMPDIR: /opt/mysql/enterprise/monitor/apache-tomcat/temp
Using JRE_HOME: /opt/mysql/enterprise/monitor-2.0.0.7092/java
Stopping tomcat service ... [ OK ]
/opt/mysql/enterprise/monitor-2.0.0.7092/mysqlmonitorctl.sh : mysql stopped
```

However, running the following command a few minutes later showed that the MySQL server was still running:

```
# /opt/mysql/enterprise/monitor-2.0.0.7092/mysqlmonitorctl.sh status
MySQL Network MySQL is running
MySQL Network Tomcat is not running
```

(Bug#43803)

- The MySQL Enterprise Monitor upgrade installer incorrectly replaced the `AdvisorScript.jar` in `<instDir>/apache-tomcat/webapps/ROOT/WEB-INF/lib/` with the default Advisor JAR. (Bug#43773)
- The SNMP trap source IP was always set to 127.0.0.1. (Bug#43738)
- The installer exited with a return code 0, even if an error was detected and reported to the user during the installation.

```
../mysqlmonitor-2.1.0.1015-linux-x86-64bit-installer.bin --mode unattended --installdir
/data0/merlin/monitoring/2.1.0.1015/host/38080 --tomcatport 38080 --tomcatshutdownport
38503 --tomcatsslport 38443 --dbport 33300 --usessl 1 --adminuser **user** --adminpassword **pwd**
Error running /data0/merlin/monitoring/2.1.0.1015/host/38080/mysql/bin/mysql
--defaults-file=/data0/merlin/monitoring/2.1.0.1015/host/38080/mysql/my.cnf -S
/data0/merlin/monitoring/2.1.0.1015/qa-merlin/38080/mysql/tmp/mysql.sock -u root -D mysql
-e "update user set Password = PASSWORD('**pwd**') where User = 'root'; update user set
User = '**user**' where User = 'root';delete from user where User = '';flush privileges;"
: ERROR 2002 (HY000): Can't connect to local MySQL server through socket
'/data0/merlin/monitoring/2.1.0.1015/host/38080/mysql/tmp/mysql.sock' (2)
```

(Bug#43676)

- The agent created the `mysql.inventory` table with an engine type of InnoDB, instead of MyISAM, when InnoDB was specified as the default engine type in `my.cnf`. This happened because the agent did not explicitly specify the table engine type to be of MyISAM. (Bug#43551)
- When a trailing space, or tab character, was added at the end of a parameter in the `config.properties` file, MySQL Enterprise Monitor failed to start and generated the following errors in log:

```
ERROR [Thread-1:org.springframework.web.context.ContextLoader] Context initialization
failed
...
Caused by: java.sql.SQLException: Illegal connection port value '13306'
...
```

Resolving the problem required detailed log analysis because the configuration file did not show any apparent problems. (Bug#43540)

- If a host was not a slave during the initial discovery phase, then it would not be displayed in the Replication tab if it subsequently became a slave.

This was because after the initial discovery phase, if a host did not have `slavestatus` present, no subsequent checks were made to check for the host being a slave. It was therefore missed for the purposes of replication discovery and never showed in the Replication tab. (Bug#42997)

- Heat Chart rules could not be disabled or unscheduled. (Bug#42932)
- There were four columns added to the `SHOW SLAVE STATUS` query in MySQL Server 5.1: `Last_IO_Errno`, `Last_IO_Error`, `Last_SQL_Errno`, and `Last_SQL_Error`.

However, these were not displayed within the Replication tab. (Bug#42811)

- The installer used to upgrade from version 1.3 corrupted passwords containing the “?” character. (Bug#42452)
- Sun multi-core processors caused all cores to be reported on the meta information page.

The larger T-series SPARC processors have 32+ cores. This caused the meta information page in the Dashboard to scroll as it reported each one. (Bug#42355)

- The username field for new users was populated by the last username used.

When creating a new user for the second time in Dashboard, the previously created username appeared in the dialog. (Bug#42314)

- The `my.cnf` file for the Enterprise Monitor internal database had the following configuration item:

```
innodb_autoextend_increment = 50M
```

This generated the error:

```
16:36:23 [Warning] option 'innodb_autoextend_increment': unsigned value 52428800
adjusted to 1000
```

This variable is interpreted as being specified in MB, so 50M would be 50 TB. Such a high value results in the variable being adjusted to 1000 MB.

The value in the configuration file should be:

```
innodb_autoextend_increment = 50
```

([Bug#42096](#))

- A number of Advisor rules had advice text that had not been translated into Japanese. The Advisors that contained untranslated rules included Performance, Schema and Security. ([Bug#42067](#))
- `OM_REFRESH` was not supported by MySQL Proxy, it caused an `abort()`.

```
shell> ./mysql-proxy --proxy-backend-addresses=192.168.250.3:3306
network-mysqld-proxy.c.3524: COM_(0x07) is not handled
Aborted (core dumped)

(gdb) bt
0x00b1b402 in ?? ()
0x00cbaf30 in raise () from /lib/i686/noseg/libc.so.6
0x00c811 in abort () from /lib/i686/noseg/libc.so.6
0x08061efc in IA__g_logv at gmessages.c:497
0x08061f66 in IA__g_log at gmessages.c:517
0x08054645 in proxy_read_query_result at network-mysqld-proxy.c:3522
0x0804c5f4 in plugin_call at network-mysqld.c:977
0x0804d45a in network_mysqld_con_handle at network-mysqld.c:1520
0x08057cb9 in event_process_active (base=0x978b260) at event.c:331
0x08057e64 in event_base_loop (base=0x978b260, flags=0) at event.c:449
0x08057d1c in event_base_dispatch (event_base=0x978b260) at event.c:351
0x0804d9d0 in network_mysqld_thread (_srv=0x9789008) at network-mysqld.c:1768
0x0804b84a in main (argc=1, argv=0xbfc4fe84) at mysql-proxy.c:615
```

([Bug#41991](#))

- The MySQL Enterprise Monitor file `my.cnf` specified an initial size of 500M for the central tablespace. However, `innodb_file_per_table` was used as well, resulting in approximately 500M of space being potentially wasted. ([Bug#41967](#))
- After an error was generated due to an incorrect password while trying to create a new user, the following error was obtained when subsequently attempting to create a valid new user:

```
U0002 You must log in to access the requested resource
```

([Bug#41384](#))

- SNMP trap messages were sending 127.0.0.1 as the IP address, and there was no feature to allow the user to configure the IP address contained in the SNMP message, which would have been useful for troubleshooting. ([Bug#41361](#))
- Allowing the heat chart rules to be set to unscheduled caused the user interface to appear broken. ([Bug#41312](#))
- Graphs were incorrect for data that did not change. The graphs appeared as if no data had been gathered.

The Hit Ratios graph had gaps in it where there had not been any activity on the parameters being monitored. For instance, if MyISAM tables were not used, then no Key Cache hit ratio series was plotted, even though the variables were still being collected. ([Bug#41232](#))

- When creating a new Database Administrator user in FireFox 2 the following error message was generated:

```
U0002 You must log in to access the requested resource.
```

This occurred in a new installation using the default administrator account. No Query Analysis permissions were given. However, the operation worked correctly using the Safari web browser. ([Bug#41032](#))

- The **MANAGE SERVERS** page did not refresh in a manner consistent with other pages. This meant that changes to configuration made by others would not be reflected on the page. Also, changes in the status of the servers were not displayed automatically. ([Bug#40792](#))
- The agent installer for Solaris 8 x86 32-bit was missing. ([Bug#40248](#))

- Even though Query Analysis was disabled through the user interface, the queries that go through the agent were still being collected.

When Query Analysis was turned back on in the user interface, those queries were then displayed. ([Bug#40032](#))

- Alerts sent from MySQL Enterprise Monitor used the GMT timezone, for example:

```
Time: 2008-09-17 19:41:08 GMT
```

That was not convenient for users, as their timezones may not have been GMT. ([Bug#39504](#))

- The MySQL Enterprise Monitor upgrade installer replaced the `my.cnf` file. This resulted in the loss of any changes that had been made to the configuration file. ([Bug#36528](#))
- If the “On Save send test trap” checkbox was checked when the SAVE button was clicked and the locale was set to Japanese, an error occurred. The orange error banner was displayed at the top of the page with the error message in Japanese. ([Bug#32069](#))

### C.3.2. Changes in MySQL Enterprise Monitor 2.0.6 (Not yet released)

This section documents all changes and bug fixes that have been applied since the release of MySQL Enterprise Monitor, version 2.0.5.

Bugs fixed:

- An error was generated when an attempt was made to rename a Replication Group to one that had previously been deleted. ([Bug#43846](#))
- A new topology was not discovered after the previous replication group was renamed. ([Bug#43815](#))
- On Unix systems, executing the command:

```
./mysqlmonitorctl.sh stop
```

did not make sure that `mysqld` was shutdown before finishing.

This resulted in a situation such as the following:

```
# /opt/mysql/enterprise/monitor-2.0.0.7092/mysqlmonitorctl.sh stop
Using CATALINA_BASE:   /opt/mysql/enterprise/monitor/apache-tomcat
Using CATALINA_HOME:   /opt/mysql/enterprise/monitor/apache-tomcat
Using CATALINA_TMPDIR: /opt/mysql/enterprise/monitor/apache-tomcat/temp
Using JRE_HOME:        /opt/mysql/enterprise/monitor-2.0.0.7092/java
Stopping tomcat service ... [ OK ]
/opt/mysql/enterprise/monitor-2.0.0.7092/mysqlmonitorctl.sh : mysql stopped
```

However, running the following command a few minutes later showed that the MySQL server was still running:

```
# /opt/mysql/enterprise/monitor-2.0.0.7092/mysqlmonitorctl.sh status
MySQL Network MySQL is running
MySQL Network Tomcat is not running
```

([Bug#43803](#))

- The MySQL Enterprise Monitor upgrade installer incorrectly replaced the `AdvisorScript.jar` in `<instDir>/apache-tomcat/webapps/ROOT/WEB-INF/lib/` with the default Advisor JAR. ([Bug#43773](#))
- The agent created the `mysql.inventory` table with an engine type of InnoDB, instead of MyISAM, when InnoDB was specified as the default engine type in `my.cnf`. This happened because the agent did not explicitly specify the table engine type to be of MyISAM. ([Bug#43551](#))
- If a host was not a slave during the initial discovery phase, then it would not be displayed in the Replication tab if it subsequently became a slave.

This was because after the initial discovery phase, if a host did not have `slavestatus` present, no subsequent checks were made to check for the host being a slave. It was therefore missed for the purposes of replication discovery and never showed in the Replication tab. ([Bug#42997](#))

### C.3.3. Changes in MySQL Enterprise Monitor 2.0.5 (18th March 2009)



This section documents all changes and bug fixes that have been applied since the release of MySQL Enterprise Monitor, version 2.0.4.

Bugs fixed:

- The FreeBSD 7 Agent was inadvertently a Linux binary.

```
shell> file mysqlmonitoragent-2.0.5.7153-freebsd7-x86-32bit-installer.bin
mysqlmonitoragent-2.0.5.7153-freebsd7-x86-32bit-installer.bin: ELF 32-bit LSB executable,
Intel 80386, version 1 (SYSV), for GNU/Linux 2.2.5, dynamically linked (uses shared libs),
stripped
```

([Bug#44263](#))

- Calling the Agent with the option `--agent-run-os-tests` resulted in a crash. This happened on Linux x86-64 systems. The resultant stack trace was:

```
(ga-merlin)
2009-03-04 16:39:42: (critical) chassis.c:1097: could not raise RLIMIT_NOFILE to 8192,
Invalid argument (22). Current limit still 1024.
sigar-test-all.c.124 (test_sigar_pid_get):
  pid = 5188
sigar-test-all.c.106 (test_sigar_mem_get):
...cut...
sigar-test-all.c.427 (test_sigar_file_system_list_get): (items = 13)
[0]
  fs.dirname = /
  fs.devname = /dev/mapper/vg00-root
  fs.type = local
  fs.sys-type-name = ext3
  fs.type = 2
  fsusage.total = 15481840
  fsusage.free = 14116140
  fsusage.used = 1365700
  fsusage.avail = 13329708
  fsusage.files = 1966080
  fsusage.use_percent = 0.100000
[0]
  diskusage.reads = 315302
  diskusage.writes = 6318240
  diskusage.write_bytes = 25879511040
  diskusage.read_bytes = 6561092608
  diskusage.queue = 47457530080206
Segmentation fault
```

On some systems no output was shown, other than the message “Segmentation fault”. ([Bug#43381](#))

- Following a change in the replication configuration, MySQL Enterprise Monitor did not display the new topology correctly. ([Bug#43240](#))
- When a data collection became invalid, the agent sent NULLs for those collection values. However, the timestamps that it sent with the values were the timestamps from the last valid value that was collected.

Due to key constraints on the Service Manager side, MySQL Enterprise Monitor disregarded anything sent with duplicate timestamps, thus the NULLs received from the agent were never processed. Some mechanisms, such as replication discovery, depend on the NULLs to identify a situation where data has become invalid. ([Bug#43239](#))

- MySQL Enterprise Monitor did not add a log entry each time data was purged. The log entry should have noted how many rows of each type of data were purged (historical data, logs, quan data). ([Bug#43159](#))
- MySQL Enterprise Monitor generated a stack overflow. This was as a result of a bug in Hibernate, which caused Hibernate to enter infinite recursion while trying to load a relationship. ([Bug#43107](#))
- The “Table Cache Set Too Low For Startup” and “Table Cache Not Optimal” rules were not supported on MySQL 5.1 because the `table_cache` system variable was deprecated and replaced with `table_open_cache`. ([Bug#42663](#))
- Migrated server was not completely deleted.

In a Monitor that had been updated from 1.3.2 to 2.0.4, with 2 database servers queued for migration, if a server being migrated was deleted, or a migrated server was deleted, this would not be reflected in the user interface or in the license count, until Tomcat was restarted. ([Bug#42604](#))

- The installer used to upgrade from version 1.3 corrupted passwords containing the “?” character. ([Bug#42452](#))
- Sun multi-core processors caused all cores to be reported on the meta information page.

The larger T-series SPARC processors have 32+ cores. This caused the meta information page in the Dashboard to scroll as it



reported each one. ([Bug#42355](#))

- If an attempt was made to disable a rule using the link next to the rule, the following error message was generated:

```
U0002 You must log in to access the requested resource. Go to login page.
```

However, clicking on the link did not prompt the user to login again. ([Bug#42313](#))

- Changing `ssh-agent` from OpenSSH or specifying a malevolent value of `agent-host-id`, could inject data into the monitored MySQL Server.

For example, setting `agent-host-id` to the value “I’m a test” would result in the following message in the error log:

```
2009-01-23 15:45:11: ((error)) agent_mysql_d.c:281: mysql_real_query('INSERT INTO
mysql.inventory (name, value) VALUES ( 'hostid', 'I'm a test' )') on 'mysql' failed: You
have an error in your SQL syntax; check the manual that corresponds to your MySQL server
version for the right syntax to use near 'm a test' )' at line 1 (mysql-errno = 1064)
```

([Bug#42306](#))

- When `SHOW GLOBAL STATUS` returned a value greater than 214748364, it was sent to the Service Manager as 214748364. ([Bug#42245](#))
- The Agent failed to identify local sockets as local on Mac OS X 10.4.

If the Agent was configured to use a Unix domain socket on Mac OS X 10.4, it did not treat the connection as local and failed to provide CPU and memory information to MySQL Enterprise Monitor. This is shown in the log file:

```
2009-01-20 18:15:02: (message) network-socket.c:752: is-local family 0 != 1
2009-01-20 18:15:02: (message) agent_mysql_d.c:322: [mysql] mysql_d is not local or not
directly connected
```

However, this problem did not happen on Mac OS X 10.5. ([Bug#42220](#))

- Some graphs on the **GRAPH** tab were not updated after the page was refreshed, or UPDATE was clicked.

The only way to get an updated graph was to change the graph size (in pixels) and then click UPDATE. ([Bug#42162](#))

- The `my.cnf` file for the Enterprise Monitor internal database had the following configuration item:

```
innodb_autoextend_increment = 50M
```

This generated the error:

```
16:36:23 [Warning] option 'innodb_autoextend_increment': unsigned value 52428800
adjusted to 1000
```

This variable is interpreted as being specified in MB, so 50M would be 50 TB. Such a high value results in the variable being adjusted to 1000 MB.

The value in the configuration file should be:

```
innodb_autoextend_increment = 50
```

([Bug#42096](#))

- A number of Advisor rules had advice text that had not been translated into Japanese. The Advisors that contained untranslated rules included Performance, Schema and Security. ([Bug#42067](#))
- The Service Manager did not handle the case where the agent failed to supply a valid `master_ip`. The Service Manager would then not restart. The logs contained the following:

```
2009-01-09 14:39:50,472 ERROR [main:org.springframework.web.context.ContextLoader] Context
initialization failed
org.springframework.beans.factory.UnsatisfiedDependencyException: Error creating bean with
name 'serverConnectionMonitor' defined in ServletContext resource
[/WEB-INF/applicationContext.xml]: Unsatisfied dependency expressed through constructor
argument with index 2 of type [com.mysql.etools.monitor.bo.Manager]: Error creating bean
with name 'manager' defined in ServletContext resource [/WEB-INF/applicationContext.xml]:
Invocation of init method failed; nested exception is
com.mysql.etools.monitor.pom.UnsupportedAttributeException:
101c6b5b-15eb-49aa-916c-843c51b28d38: mysql.slavestatus.Master_ip
```

[\(Bug#42005\)](#)

- Having too many users with strong privileges generated Service Manager errors and events failed to be triggered.

If there were approximately 1000 users with full privileges and the value of `group_concat_max_len` was set to 100001, the size of the data that the agent sent to the Service Manager was too large and caused Service Manager errors. Also, the Security event “Account has Strong MySQL privileges” did not trigger. ([Bug#41987](#))

- Query Analyzer's Query Type filter for `SELECT` ignored statements starting with parenthesis.

If you sent a statement through Query Analyzer starting with parenthesis, such as:

```
(SELECT 1 FROM dual);
```

and then attempted to filter for `SELECT` queries only, queries starting with parenthesis were not displayed. ([Bug#41968](#))

- The agent angel process was spawning too soon, which caused a duplicate UUID error.

`g_error()` logged a fatal error, and called `abort()`. This terminated the program. Then the angel respawned with the same UUID, but with a -1 session resync request, which the MEM server denied because the old session was still active. This resulted in a permissions denied error (1142) on the `mysql.inventory` table.

```
2008-12-17 18:58:58: (message) agent_mysqlqd.c:313: [mysql] mysqlqd is local and directly connected
2008-12-17 18:58:58: ((error)) agent_mysqlqd.c:444: [mysql] mysql_real_query("SELECT value
FROM mysql.inventory WHERE name = 'uuid'") failed: SELECT command denied to user
'ent_agent'@'127.0.0.1' for table 'inventory' (errno=1142)
2008-12-17 18:58:58: (debug) chassis.c:282: 15134 returned: 15134
2008-12-17 18:58:58: (message) chassis.c:304: [angel] PID=15134 died on signal=6 (it used
0 kBytes max) ... waiting 3min before restart
2008-12-17 18:59:00: (debug) chassis.c:244: we are the child: 15149
2008-12-17 18:59:00: (message) chassis.c:259: [angel] we try to keep PID=15149 alive
2008-12-17 18:59:00: (debug) chassis.c:277: waiting for 15149
2008-12-17 18:59:00: (message) mysql-proxy 0.7.0 started
2008-12-17 18:59:00: (message) MySQL Monitor Agent 2.0.0.7111 started.
```

[\(Bug#41600\)](#)

- `master_uuid` discovery did not work with MySQL Server versions prior to 5.1. `master_uuid` did not show in any Agent to Monitor communications, and no log or error messages were generated.

However, now the bug has been fixed, an Agent monitoring a 5.0 MySQL Server would register the following in its logs:

```
...
<classname>slavestatus</classname>
<instance>12515cdc-8c00-4223-9d2a-2666a403512c</instance>
<attribute>Master_uuid</attribute>
</target>
<utc>2009-03-03T19:58:05.700Z</utc>
<value>b2fd9f86-6e42-49f2-b930-e8fb3e728179</value>
```

Note the presence of `master_uuid`. ([Bug#41525](#))

- The `master_uuid` was not used for replication topology discovery.

The agent collected `master_uuid` by reading the `master.info` file, and then running a `SELECT` directly against its master. This was to try and read the `mysql.inventory` table on the master to obtain the instance `master_uuid`.

However, this was not being used correctly by the replication topology discovery within the server. ([Bug#41519](#))

- Queries such as `SELECT` against the master `mysql.inventory` was not logged on slave-based agents. This made diagnosing topology discovery issues difficult. ([Bug#41518](#))
- After an error was generated due to an incorrect password while trying to create a new user, the following error was obtained when subsequently attempting to create a valid new user:

```
U0002 You must log in to access the requested resource
```

[\(Bug#41384\)](#)

- Agent startup failed on Solaris 10. The error generated was:

```
# ./mysql-monitor-agent start
Bad string
ERROR! /opt/mysql/enterprise/agent/etc/mysql-monitor-agent.ini has to have a
```

```
[mysql-proxy].pid-file setting
```

This was caused by unexpected behavior of the `tr` command. (Bug#41260)

- On the Query Analysis page, if a query was clicked the minimum displayed was greater than the average. (Bug#41259)
- In some circumstances the agent/proxy ran out of file descriptors, causing secondary failures. It could not recover from that state. The relevant part of the log file is shown here:

```
2008-11-27 11:11:00: (critical) last message repeated 2 times
2008-11-27 11:11:00: (critical) job_collect_os.c:411: sigar_cpu_info_list_get() failed
2008-11-27 11:11:00: (critical) job_collect_os.c:445: sigar_cpu_list_get() failed
2008-11-27 11:11:00: (critical) job_collect_os.c:411: sigar_cpu_info_list_get() failed
2008-11-27 11:11:00: (critical) job_collect_os.c:445: sigar_cpu_list_get() failed
2008-11-27 11:11:00: (critical) job_collect_os.c:411: sigar_cpu_info_list_get() failed
2008-11-27 11:11:00: (critical) job_collect_os.c:445: sigar_cpu_list_get() failed
2008-11-27 11:11:00: (critical) job_collect_os.c:411: sigar_cpu_info_list_get() failed
2008-11-27 11:11:00: (critical) job_collect_os.c:445: sigar_cpu_list_get() failed
2008-11-27 11:11:30: (critical) network-socket.c:292: socket(127.0.0.1:3306) failed: Too many open files (24)
2008-11-27 11:11:30: (critical) proxy-plugin.c:1532: Cannot connect, all backends are down.
2008-11-27 11:20:22: (critical) last message repeated 4 times
2008-11-27 11:20:22: (critical) network-io.c:215:
curl_easy_perform('https://user:password@merlin-dashboard:443/heartbeat') failed:
SSL connection timeout (curl-error = 'Timeout was reached' (28), os-error = 'Connection refused' (111))
```

(Bug#41068)

- If an installation of Service Manager 2.0.0.7102 included a `backup` directory, due to a previous upgrade, and was upgraded using at least Service Manager 2.0.0.7103, then the installer displayed an error message and exited.

The error message displayed was:

```
There has been an error.
Error renaming /Applications/mysql/enterprise/monitor/apache-tomcat to
/Applications/mysql/enterprise/monitor/backup/apache-tomcat
The application will exit now
```

(Bug#40996)

- The Agent started without problems and connected to the master. But it was unable to perform a `SELECT` from the table `mysql.inventory` in order to obtain server information. (Bug#40933)
- Canonical Query Text for `Select -1` was displayed as `SELECT -?` instead of `SELECT ?` on the Query Analyzer tab. (Bug#40435)
- The agent installer for Solaris 8 x86 32-bit was missing. (Bug#40248)
- The startup scripts supplied with MySQL Network Monitoring and Advisory tool did not supply all of the LSB `init.d` script options required. A list of the required options can be found at the following website [http://refspecs.freestandards.org/LSB\\_3.1.0/LSB-Core-generic/LSB-Core-generic/iniscriptact.html](http://refspecs.freestandards.org/LSB_3.1.0/LSB-Core-generic/LSB-Core-generic/iniscriptact.html)

The required options missing include `status` and `force-reload`. The option `status` is used by monitoring tools and cluster software such as Red Hat Cluster, to ensure that the service is still running. The `force-reload` option is an alias for restart. (Bug#29848)

- Multiple errors showed in the agent log after issuing a `SHOW INNODB STATUS` statement. The `InnoDB Buffer Pool` graph also went blank. (Bug#27372)

### C.3.4. Changes in MySQL Enterprise Monitor 2.0.4 (5th February 2009)

This section documents all changes and bug fixes that have been applied since the release of MySQL Enterprise Monitor, version 2.0.3.

Bugs fixed:

- The Service Agent did not log connections to, and disconnects from, the monitored database.

This meant it was not possible to check if the Agent was connected to the database by simply looking at the log file. (Bug#42403)

- The Service Agent failed to create the `mysql.inventory` table. The logs displayed the following error message:

```
(critical) (share/mysql-proxy/quan.lua:711) [proxy] please add SELECT permissions for
this user on mysql.inventory to enable the QUAN feature, got Table 'mysql.inventory'
doesn't exist
```

This happened even though the Service Agent used the `root` account. (Bug#42389)

- After installing Service Agent 2.0.4.7138 and then starting it with `--version`, the incorrect version was displayed. Although 2.0.4.7138 was installed, the Service Agent displayed the version number as 2.0.2.7138. (Bug#42263)
- An invalid path was shown in the error message if the upgrade installer failed to find the previous install location.

The error message is shown below, note that the error message displays a different path to that provided by the user:

```
Please specify the directory that contains the previous installation of the MySQL
Enterprise Monitor Agent

Installation directory [/home/mysql/mysql/enterprise/agent]: /var/lib/mysql/agent

Warning: The directory /home/mysql/mysql/enterprise/agent does not contain a
previous installation. Please select the right installation directory.
Press [Enter] to continue :
-----
Please specify the directory that contains the previous installation of the MySQL
Enterprise Monitor Agent
```

(Bug#42200)

- The agent password error in the Service Manager did not log the originating host, making it impossible to determine the agent that failed to log in:

```
ErrorJan 5, 2009 4:56:08 PM<?xml version='1.0'?><exceptions><error><![CDATA[E1702:
IncorrectPasswordException: [agent]]]></error></exceptions>
```

(Bug#42139)

- The Service Manager's JDBC connections did not have `sql_mode` set to include `NO_ENGINE_SUBSTITUTION`. This resulted in the failure of Data Definition Language (DDL) if the Service Manager was inadvertently pointed to an incorrect `mysqld` instance. (Bug#42137)
- A number of Advisor rules had advice text that had not been translated into Japanese. The Advisors that contained untranslated rules included Performance, Schema and Security. (Bug#42067)
- Service Agent configuration files had global read privileges on the filesystem. (Bug#41794)
- When the log files rotated to the maximum allowed by the `log4j` configuration, the metadata contained in the `FileAppender` became out of synchronization due to a logic bug. This caused an assertion error on any subsequent request for the logs tab or data. (Bug#41593)
- SNMP trap messages were sending 127.0.0.1 as the IP address, and there was no feature to allow the user to configure the IP address contained in the SNMP message, which would have been useful for troubleshooting. (Bug#41361)
- On all available test systems, including SUSE Linux Enterprise Server (SLES) 9 and 10 x86-32, x86-64, IA64, and Ubuntu 6.10 x86-64, the agent memory grew incrementally within ~3 hours to ~25M.

The agents then switched to the 'red' condition on the dashboard and no more data was reported. The agent processes were still alive.

This was also present in MySQL Enterprise Monitor version 2.0.0.7111 on Suse 7.3, with the `glibc2.2` x86 agent.

There was no load on the monitored servers, and the problem also occurred when the “self-quan” was not configured. (Bug#41244)

- Although the **MONITOR** tab loaded initially, after a 64-bit MySQL server running a 32-bit MySQL Monitor Agent was clicked, a Null Pointer Exception was generated. (Bug#41164)
- The Service Agent startup configuration did not seem to work and did not generate a log file. (Bug#40583)
- An error generated by a rule failed to clear.

When a rule was created with the `os:disk:fs_used` data item, if the instance was not a valid mount point then the Service Agent reported the error:

```
2008-08-11 17:57:00: (critical) disk-get failed for all: 2
```

Note the above instance was for “all”, and similar results occurred for instance “disk”.

The issue was that upon editing the rule, or even deleting the rule, the agent still showed the above error type. Restarting the agent and the monitoring service failed to remove the error. ([Bug#38709](#))

- If the “On Save send test trap” checkbox was checked when the SAVE button was clicked and the locale was set to Japanese, an error occurred. The orange error banner was displayed at the top of the page with the error message in Japanese. ([Bug#32069](#))

### C.3.5. Changes in MySQL Enterprise Monitor 2.0.3 (23rd January 2009)

This section documents all changes and bug fixes that have been applied since the release of MySQL Enterprise Monitor, version 2.0.2.

Bugs fixed:

- The Service Agent failed to connect to the server, and no error message was displayed in the log file.

However, when the log verbosity level was set to `message`, the following message was recorded:

```
2009-01-12 13:34:43: (warning) agent_mysql.d.c:600: agent connecting to mysql-server
failed: mysql_real_connect(host = '127.0.0.1', port = 3306, socket = ''): Lost connection
to MySQL server at 'reading initial communication packet', system error: 0 (mysql-errno =
2013)
```

([Bug#42044](#))

- There was a mismatch between the contents of an SNMP Trap from MySQL Enterprise Monitor and the definition given in the file `MONITOR.MIB`. ([Bug#41912](#))
- If a copy was made of a standard rule, the resulting Wiki markup was incorrect, resulting in the display of user-interface text containing HTML markup. ([Bug#41375](#))
- Allowing the heat chart rules to be set to unscheduled caused the user interface to appear broken. ([Bug#41312](#))
- When a custom rule requiring disk information was created, for example:

```
[Expression]
%disk_reads% > THRESHOLD

[Thresholds]
Critical Alert: 9000
Warning Alert: 3000
Info Alert: 1000

[Variable Assignment]
variables: %disk_reads%
Data Item: os:disk:disk_reads
Instance: /
```

The following error was written to the file `mysql-service-agent.log`:

```
2007-09-05 17:11:00: (critical) disk-get failed for c0d0p1: 2
```

It therefore appeared that the Service Agent was not able to obtain the required information. ([Bug#30820](#))

### C.3.6. Changes in MySQL Enterprise Monitor 2.0.2 (14th January 2009)

This section documents all changes and bug fixes that have been applied since the release of MySQL Enterprise Monitor, version 2.0.1.

Bugs fixed:

- The COMPLETE SETUP button was missing from the `SETUP` page you were taken to after the current subscription expired. ([Bug#41685](#))
- If the `host-id` of the monitored instance and the `host-id` of the current agent did not match, the agent generated the following error message:

```
Please TRUNCATE TABLE mysql.inventory on this mysql-instance and restart the agent.
```

However, it did not suggest using `sql_log_bin = 0`. This is used for all other actions against this table so that they are not replicated to slaves, each of which has their own copy of this table. (Bug#41673)

- The Agent did not start up when the monitored server had many databases and tables, and was under heavy load. This was because the `trigger_schema` query was taking too long on agent start up. (Bug#41555)
- The Service Agent failed to install on Solaris 10 x86. The following error was generated:

```
Installing
0% _____ 50% _____ 100%
#####
Warning: Problem running post-install step.
Installation may not complete correctly
Error running /usr/local/mysqlagent/bin/mysql-monitor-agent
--defaults-file=/usr/local/mysqlagent/etc/mysql-monitor-agent.ini
--plugins=agent --agent-generate-uuid=true : 2008-12-12 13:06:02: (critical)
Conversion from character set '646' to 'UTF-8' is not supported
2008-12-12 13:06:02: (message) shutting down normally
```

(Bug#41445)

- The console/stdout appender remained in the log4j configuration, which meant that all the MySQL Enterprise Monitor server logs were duplicated to Catalina's stdout, and thus `catalina.out`, which was wasteful, especially as that file was not rotated or managed. (Bug#41439)
- When creating new multiple user accounts, the first attempt worked fine. However, following attempts to create new users did not show the **QUERY ANALYZER OPTIONS** in the **CREATE USER** popup until the role field was changed. (Bug#41430)
- When login privileges were required the Service Manager did not redirect the user to the login page. This resulted in error messages being displayed rather than simply redirecting the user to the login page. This problem typically occurred if it was necessary to restart Tomcat. (Bug#41320)
- The monitor 2.0.0.7105 and 2.0.0.7122 Solaris Intel update installer quits unexpectedly. The installer exits from the GUI in the **BACKUP OF PREVIOUS INSTALLATION** screen, when OpenSolaris is running on top of Sun xVM.

The console output for both installer versions is given below:

```
shell> ./mysqlmonitor-2.0.0.7105-solaris-intel-update-installer.bin
X Error of failed request: BadMatch (invalid parameter attributes)
Major opcode of failed request: 73 (X_GetImage)
Serial number of failed request: 21161
Current serial number in output stream: 21161
```

```
shell> ./mysqlmonitor-2.0.0.7122-solaris-intel-update-installer.bin
X Error of failed request: BadMatch (invalid parameter attributes)
Major opcode of failed request: 73 (X_GetImage)
Serial number of failed request: 21148
Current serial number in output stream: 21148
```

(Bug#41315)

- The **RENAME GROUP** function failed if the new group name was different to the current one only in the case used; for example, if "Merlin" was changed to "MERLIN".

The error generated was:

```
U0105 This group name is already in use. Enter a different name.
```

(Bug#41266)

- The Agent returned an inventory list of all databases and tables. This information was not used by MySQL Enterprise Monitor, other than to populate the `inv_databases` and `inv_tables` tables. For large-scale deployments, where there were many databases and tables, this resulted in redundant XML messages being sent from the Agent to the Service Manager. (Bug#33150)

### C.3.7. Changes in MySQL Enterprise Monitor 2.0.1 (15th December 2008)

This section documents all changes and bug fixes that have been applied since the release of MySQL Enterprise Monitor, version 2.0.0.

Bugs fixed:

- Having an installation with over 420 master binlogs resulted in the `mysql::status` graph not being plotted. (Bug#41314)
- The MySQL Enterprise Monitor installer generated a segfault on RedHat Fedora 10:

```
shell> ./mysqlmonitor-2.0.0.7105-linux-x86-installer.bin
Segmentation fault
```

(Bug#41196)

### C.3.8. Changes in MySQL Enterprise Monitor 2.0.0 (11th December 2008)

This section documents all changes and bug fixes that have been applied since the release of MySQL Enterprise Monitor, version 1.3.3.

Functionality added or changed:

- **Important Change:** The `server-name` configuration parameter is deprecated. For compatibility, during an upgrade, the information will be migrated to a `displayname` configuration parameter within the individual instance configuration files. This configuration parameter is provided only for compatibility, as display name information is now stored within the main repository. Support for `displayname` is also deprecated and will be removed in a future release.
- **Important Note:** The rules “32-Bit Binary Running on 64-Bit AMD Or Intel System” and “Key Buffer Size Greater Than 4 GB” occasionally do not evaluate correctly due to timing issues. This causes them to be displayed with the **SEVERITY** level of “Unknown”. This is a known issue and will be resolved in future versions of MySQL Enterprise Monitor.
- **Important Note:** When you start the Merlin 2.0 agent from the command line on Windows, you get the following error dialog:

```
"mysql-proxy.exe - Entry Point Not Found"
"The procedure entry point libiconv_set_relocation_prefix could not be located in the
dynamic link library iconv.dll"
```

If you click OK the agent works fine after that.

This only occurs when starting the agent from the command line, and only when there is another version of one of the DLLs that the agent uses somewhere on the current path. This error can be avoided by opening a command prompt, typing `SET PATH=` to clear the path, and then starting the agent.

- **Important Note:** If you are monitoring one instance of MySQL server (`mysqld`) and then upgrade that MySQL server, the correct version of the MySQL server is not displayed in the Dashboard. This is a known issue that will be fixed in future versions of MySQL Enterprise Monitor.
- The following has been added to the Tomcat `config.properties` properties file:

```
# max connections in the pool for the repository
default.maxActive=70
```

(Bug#40652)

- The dashboard could be used to change the agent password to one containing the `@` character, or other special characters, which subsequently caused errors. To fix this problem, special characters in passwords are now prevented by the dashboard. The list of disallowed special characters can be found at the following location: [http://en.wikipedia.org/wiki/Percent-encoding#Types\\_of\\_URI\\_characters](http://en.wikipedia.org/wiki/Percent-encoding#Types_of_URI_characters) (Bug#37172)
- The **QUERY ANALYSIS** page was missing the **REFRESH** dropdown control that the **MONITOR**, **EVENTS**, and **GRAPHS** pages had at the top. (Bug#36831)
- The User Interface only returned error strings, without any associated error codes. This meant that if the error string was in a language that the user did not understand, it would be very difficult to determine which error actually occurred.

The User Interface now supports error codes, as well as error strings. This change allows easier testing of multiple locales. (Bug#32131)

- The wording was changed on the fading popup subscription alert. The text “account” was changed to “subscription”. (Bug#31492)
- The alert thresholds for the Query Cache Advisor were changed:



	Information	Warning	Critical
From	95	85	75
To	60	50	40

([Bug#30969](#))

- The agent log file name has changed from `mysql-service-agent.log` to `mysql-monitor-agent.log`. The old log file will be retained during a upgrade install.

Bugs fixed:

- Starting a new agent against an instance that contained many databases broke up the initial discovery packet, causing collections such as CPU usage and their graphs to fail. See also [Bug#33150](#) and [Bug#41314](#). ([Bug#41933](#))
- When altering an existing rule you had to add an empty string, "", to any threshold level that was empty. Otherwise, the rule failed to run and the resulting exceptions caused the **EVENTS** page to be unusable due to duplicate key exceptions. ([Bug#41310](#))
- After installing the 2.0.0.7119 Dashboard the following error was generated in the logs:

```
com.opensymphony.xwork2.util.OgnlValueStack Warning Dec 5, 2008 10:41:26 AM Caught
an Ognl exception while getting property titleAddition
```

([Bug#41252](#))

- The `dc_ng_long_now` table became very large partly due to an unused column `begin_time`. ([Bug#41093](#))
- Although there was a unique constraint on the user name, it was not enforced during first-time setup. This resulted in a stack trace being produced, rather than a more user-friendly error message, if the same name was used for the `admin` and `agent` accounts. ([Bug#40870](#))
- MySQL Enterprise Monitor server had stopped sending up/down SNMP traps. ([Bug#40861](#))
- The Query Analyzer's **EXPLAIN QUERY** tab did not have pop up text or a link to the documentation regarding **SELECT** queries. ([Bug#40841](#))
- When you tried to import a Trial-level advisor JAR using a Trial user account, one of the following error messages was generated:

```
U0009 The uploaded Advisor jar was invalid
```

```
U0161 Please import a Platinum level Advisor .jar to use with this Platinum level product key
```

([Bug#40834](#))

- Meta Info on the Dashboard did not display information for the meta data `os_description`. ([Bug#40830](#))
- Attempting to create an alias of statements such as `COMMIT`, `ROLLBACK`, `BEGIN`, resulted in the error:

```
Can't find template commitTxn.st; group hierarchy is [HTMLFormatting]
org.antlr.stringtemplate.StringTemplateGroup.lookupTemplate(StringTemplateGroup.java:507)
```

([Bug#40736](#))

- Trying to upgrade from 2.0.0.7088 to 2.0.0.7092 failed as there was a missing file. When the update program `mysqlmonitor-2.0.0.7092-solaris-intel-update-installer.bin` was run, the file `/tmp/com/mysql/merlin/server/version.props` could not be found. ([Bug#40692](#))
- On OS X with Java 1.5, Tomcat crashed on launch with the error:

```
Invalid memory access of location 00000007 eip=013df179
```

([Bug#40689](#))

- When the agent was installed using the command line installer and `--enableproxy 0` was specified, the installer should have removed `quan.lua` from the `agent-item-files` option in the INI file. ([Bug#40551](#))



- The Agent could not connect to a database with the `hostname` set to `localhost`. Doing so resulted in the error:  

```
(critical) the MySQL server could not be reached at socket '(null)', we will check in 10 seconds
```

  
(Bug#40530)
- The update installer for the 2.0 Monitor did not have an **IS SSL SUPPORT REQUIRED?** checkbox. Therefore, the appropriate SSL connector definition was commented out in the `conf/server.xml` file. (Bug#40414)
- The Service Manager installer did not uninstall or wipe out the previous installation if you answered “Yes” to the question: “The directory you selected already contains a MySQL installation. If you continue installation all data will be lost. Do you wish to continue?” (Bug#40410)
- If you unchecked the **ENABLE PROXY** checkbox on the **QUERY ANALYSIS CONFIGURATION** screen, the agent's INI file still contained proxy configuration data and was not commented out. (Bug#40272)
- As different queries were sent through the agent it used increasing amounts of memory. (Bug#40260)
- The Service Manager installer set the Java Virtual Machine option `HeapDumpPath` to `<install_root>\temp` on Windows and `/tmp` on other platforms. For consistency the `HeapDumpPath` directory should have been set to `<install_root>\tmp` on Windows. (Bug#40215)
- When using the command line agent setup program, a socket file was not accepted for the monitored instance. (Bug#40085)
- The language option when installing the MySQL Enterprise Monitor in Japanese using the command-line installer has been changed from `jp` to `ja`. (Bug#40082)
- When monitoring MySQL 5.1.24 and above, the user used by the agent to connect to the MySQL server for monitoring must have the `PROCESS` privilege. (Bug#40050)
- The check box option string “Is SSL support required?”, on the Tomcat Server Option dialog of the Monitor installation, was not correctly translated into Japanese. (Bug#39814)
- The base application directory for the MySQL Enterprise Dashboard has been updated from `http://localhost:18080/merlin` to `http://localhost:18080/`. (Bug#39403)
- If the Service Manager or the MySQL Server running the Repository crashed, they did not restart automatically. (Bug#39377)
- If the agent crashed, there was no watchdog, angel or keep-alive mechanism to restart the agent and keep it running. (Bug#39374)
- If the MySQL client libraries were located in a non-standard location, the agent 2.0.0.7042 installer failed with a “library not found” error. (Bug#39317)
- For the rule “Server-Enforced Data Integrity Checking Not Strict”, the Recommended Action did not display correctly. It displayed as `SET sql_mode=modes`, rather than `SET [GLOBAL|SESSION] sql_mode=modes`. (Bug#39261)
- A query that was issued through the proxy, and that had an auto-explain performed on that query, did not give the correct response to a subsequent query of `SELECT FOUND_ROWS()`. (Bug#39223)
- It was not possible to establish a connection with the Dashboard using the SSL protocol (`https://`). (Bug#39198)
- When a 1.3 MySQL Enterprise Monitor installation with many rules scheduled was upgraded to 2.0, the upgraded installation was then found to have only the heat chart rules scheduled. (Bug#39043)
- The agent installer did not allow a second agent to be installed on Windows. (Bug#38976)
- The Dashboard incorrectly displayed that insufficient licenses were available, even though sufficient licenses had been purchased. (Bug#38514)
- After running the MySQL Service Agent uninstall program, the file `/etc/init.d/mysql-service-agent` remained present on the server. (Bug#38490)
- The notice fader continued to display English text after you changed the locale to Japanese. (Bug#38460)
- The **SUBSCRIPTION EXPIRED** pop-up window referred to the “Global Preferences” page, instead of the “Global Settings” page. (Bug#38358)
- An inappropriate time zone was used to parse user-entered date and time strings. (Bug#38323)

- A sigar network stats error was generated on the Solaris platform:

```
# /opt/mysql/enterprise/agent/bin/mysql-service-agent --version
MySQL Service Agent - 1.2.0.7879, (glib lib=2.8.5, headers=2.8.5)

SunOS mysqlprd01 5.10 Generic_127127-11 sun4v sparc SUNW,T5240

2008-07-21 10:07:24: (critical) sigar_net_interface_config_primary_get() failed: 6
2008-07-21 10:08:00: (critical) sigar_net_interface_config_primary_get() failed: 6

# /opt/mysql/enterprise/agent/bin/sigar-test-all >/tmp/test.txt
sigar_net_interface_stat_get(e1000g0:2) failed#
```

([Bug#38302](#))

- After deleting a server from the **SETTINGS, MANAGE SERVERS** tab, at the very bottom of the page the **MONITORING X INSTANCES ON X HOST** values did not reflect the deletion. ([Bug#38225](#))
- The MySQL Enterprise Monitor alert “INFO Alert - Users Can View All Databases On MySQL Server (v 1.5 \*)” from the Security advisor was incorrect. This is because the default server behavior allows users to see databases for which they have privileges, not “all databases on server” as suggested by the alert. ([Bug#38052](#))
- The “Maximum Connection Limit Nearing Or Reached” advisor did not generate a new Critical Alert event when there was an open info success event. ([Bug#37816](#))
- The Linux IA64 installer appeared to crash. The installer appeared to crash on RH4\_IA64 if called with option "--version":

```
-----
<INSTALLER> --version
mysqlmonitorage(30704): unaligned access to 0x6000000000a8413c, ip=0x2000000003ddd5f0
mysqlmonitorage(30704): unaligned access to 0x6000000000a84144, ip=0x2000000003ddd5f1
mysqlmonitorage(30704): unaligned access to 0x6000000000a8414c, ip=0x2000000003ddd600
mysqlmonitorage(30704): unaligned access to 0x6000000000a84154, ip=0x2000000003ddd601
MySQL Enterprise Monitor Agent 0.7.0.1737 --- Built on 2008-06-25 19:31:53
-----
```

However, this warning is harmless and will not impact the operation of the agent. ([Bug#37496](#))

- If the log-level option in the agent configuration file was set to an unknown level by mistake, the `init.d` script appeared to enter an infinite loop. ([Bug#37108](#))
- Malformatted server meta information appeared on the Dashboard; **RAM** and **DISK SPACE** appeared under the **CPU** category. ([Bug#36740](#))
- A “rename” link incorrectly appeared next to the **UPGRADE** category on the **MANAGE RULES** page. ([Bug#36584](#))
- In the case where exceptions were passed through to the User Interface, the substituted arguments in the message contained developer-only information. ([Bug#36580](#))
- **AGENT VERSION, LAST MYSQL CONTACT, OS INFO, CPU INFO, and IP ADDRESSES** were all blank on the dashboard when the agent for the selected server was not functioning. ([Bug#36301](#))
- `mysql-monitor-agent` became confused by the `.DS_Store` files that are created on Mac OS X. ([Bug#36216](#))
- The rule “Key Buffer Size Greater Than 4 GB” incorrectly triggered the following alert:

```
CRITICAL ALERT - KEY BUFFER SIZE GREATER THAN 4 GB
```

However, on non-Windows systems, a key buffer size greater than 4 GB is supported. ([Bug#36143](#))

- Since the repository database for MySQL Enterprise Monitor uses InnoDB there was no way to reduce the size of the data files after an old log/event data purge operation. Further, the purge data operation executed once per day, and had no option to trigger the purge operation manually. ([Bug#35971](#))
- On the Graphs page, if all graphs were expanded, then the Time Display interval updated, the page was refreshed with the EXPAND ALL button displayed, even though all the graphs were already expanded. ([Bug#35917](#), [Bug#35133](#))
- The Meta Info area of the Monitor page incorrectly reported the operating system version number for the MySQL version. ([Bug#35836](#))
- The rule “XA Distributed Transaction Support Enabled For InnoDB” incorrectly sent a warning when the binary log was on. ([Bug#35786](#))
- On the Monitor page, the time displayed for `Last MySQL Contact` lagged behind that for `Last Agent Contact` by a

large amount. ([Bug#35774](#))

- MySQL Enterprise Monitor did not update replication settings correctly. After a slave became the master, the Adviser still referred to it as a slave. ([Bug#35771](#))
- The Adviser email suggested using the `--log-queries-not-using-indexes` option. However, this option is not available in MySQL Server versions prior to 4.1. ([Bug#35770](#))
- Thumbnail graphs did not update properly after a time zone change. ([Bug#35756](#))
- If a system had a global `wait_timeout` lower than the general activity of the agent, the agent was disconnected. The monitored server then logged an error and incremented `Aborted_clients`. ([Bug#35648](#))
- Alerts fired after a blackout period based on data collections that happened during the blackout. ([Bug#35617](#))
- The translation of the ADD ROW button on the Rule Definition window was incorrect. ([Bug#35495](#))
- An uninstallation message asked about removing Apache files, even though Apache is no longer used. ([Bug#35154](#))
- After updating from a previous version to the latest 1.3 version, the **QUERY CACHE HAS SUB-OPTIMAL HIT RATE** was still displayed in English after setting the locale to Japanese. Note, the rule was translated correctly if the full installer was used. ([Bug#35134](#))
- The MySQL Enterprise Monitor uninstall dialog box had missing text when using the Japanese locale. ([Bug#34982](#))
- Running the installer with the `--help` option caused an incorrect message to be displayed. ([Bug#34200](#))
- When using the unattended `unInstall` script on Linux together with the option `--env deleteUserData=yes` the correct warning text was displayed. However, this text should not be displayed in unattended mode. Further, the option `--env deleteUserData=yes` was not displayed by the `--help` output. ([Bug#34071](#))
- Platinum Unlimited customers sometimes received a warning stating incorrectly that their subscription supported zero hosts. ([Bug#34010](#))
- Clicking on the resolution notes link for a closed event on the events tab showed incorrect behaviour. The popup initially showed the resolution notes, but when the resolution tab was clicked the notes disappeared and were replaced by an edit box. ([Bug#33935](#))
- The status on the product information page was not translated when the user locale was set to Japanese. ([Bug#32785](#))
- When the locale was set to Japanese, the date picker still had English month titles. ([Bug#32741](#))
- Flashing display of a pop-up used while saving outgoing email settings was caused by problematic initial placement calculations. ([Bug#32579](#))
- AIX 5.2 Agent did not work on AIX 5.3. ([Bug#32414](#))
- When the First Time Setup program was run it did not prompt the user to allow importing an Advisor bundle. ([Bug#32199](#))
- Agent on MacOSX did not read IP addresses for network interfaces correctly, so the monitor displayed empty host IP addresses. ([Bug#32188](#))
- HTML code in queries was not escaped when reporting replication errors, causing the code to be rendered into the page. ([Bug#32186](#))
- The First Run pop-up defaulted to English rather than to the locale set in the browser. ([Bug#32129](#))
- The error dialog box flashed in the upper left corner before being positioned in the center of the screen. This error dialog box now opens in the center of the screen. ([Bug#32068](#))
- The Events list did not take into account Daylight Time and Standard Time when listing events that happened during 1:00am-1:59am. An event that occurred at 1:10am Standard Time was listed before an event that occurred 50 minutes before it at 1:20am Daylight Time. ([Bug#32016](#))
- The pop-up for editing log levels failed to load due to bad instantiation data. ([Bug#32013](#))
- During the repeated hour of Daylight Savings Time (when 2am turns back into 1am), the graphs were not drawing data. Instead, there was a straight line from the point at 1:00 to the second 1:00, which is what happens if there is no data. The repository did, however, have data for this hour. ([Bug#31997](#))
- Only US English was supported for a locale setting. Other English variants are now available for the `locale` setting on the

[General Settings](#) or the [User Preferences](#) pages. (Bug#31801)

- If the user locale was changed the graph cache would continue to display the graph in the last locale until it timed out. (Bug#31680)
- No init script was installed for the MySQL Network Monitoring Service Manager, and so it did not restart automatically on re-boot. (Bug#31676)
- The graph's displayed time was not the local time of the Dashboard corresponding to the requested time on the monitored server. (Bug#31656)
- Saving a rule with a name that already existed resulted in a stack trace in the window, instead of a more user-friendly error message. (Bug#30925)
- The `network.mysql.com` error messages were remapped thereby causing confusion. For example, the following error message:

```
E9000: MYSQL ENTERPRISE CUSTOMER CENTER IS HAVING DIFFICULTIES FETCHING YOUR CONTRACT INFORMATION.
PLEASE CONTACT ENTERPRISE-FEEDBACK@MYSQL.COM FOR ASSISTANCE.
```

Was remapped to:

```
UNABLE TO CONNECT TO VERIFY CREDENTIALS (Bug#30873)
```

- A newly added server showed as “down” in the user interface, and could potentially have sent a false alarm notification. (Bug#30735)
- The information on the [ADVISORS, CHECK FOR UPDATES](#) page did not accurately reflect how many rules and graphs were actually in the database and available to the user. (Bug#29623)
- The agent did not process `SIGHUP`. (Bug#29380)
- Monitor did not have a facility to stop or downgrade an agent collection frequency. (Bug#28589)
- After an agent installation was updated from 1.0.1.4391 to 1.1.0.4899, the version in the [ADD/REMOVE PROGRAMS](#) menu was incorrectly displayed as 1.0.1.4391, even though the update was successful and the file version of `agent.exe` was correctly displayed as 1.1.0.4899. (Bug#27447)
- When viewing the **RESULTS** of an **EVENT** in the **EVENTS** tab of the **DASHBOARD**, the **NOTIFICATIONS** section did not reflect the **NOTIFICATIONS** settings at the time the **EVENT** was triggered, but rather the **NOTIFICATIONS** settings at the time the **EVENT RESULTS** were viewed. (Bug#26349)
- When the Service Agent was remotely monitoring a MySQL server it incorrectly reported that it could collect operating system information. (Bug#22497)
- The Account Without Password advisor did not report all users who were without a password, it only reported one. (Bug#15165)

## C.4. MySQL Connector/ODBC (MyODBC) Change History

### C.4.1. Changes in MySQL Connector/ODBC 5.1.6 (Not yet released)

Bugs fixed:

- Connector/ODBC failed to build with MySQL 5.1.30 due to incorrect use of the data type `bool`. (Bug#42120)
- Calling `SQLDescribeCol()` with a NULL buffer and nonzero buffer length caused a crash. (Bug#41942)
- MySQL Connector/ODBC updated some fields with random values, rather than with `NULL`. (Bug#41256)
- Calling `SQLDriverConnect()` with a `NULL` pointer for the output buffer caused a crash if `SQL_DRIVER_NOPROMPT` was also specified:

```
SQLDriverConnect(dbc, NULL, "DSN=myodbc5", SQL_NTS, NULL, 0, NULL, SQL_DRIVER_NOPROMPT)
```

(Bug#40316)

- Setting the ADO `Recordset` decimal field value to 44.56 resulted in an incorrect value of 445600.0000 being stored when

the record set was updated with the `Update` method. (Bug#39961)

- The `SQLTablesW` API gave incorrect results. For example, table name and table type were returned as `NULL` rather than as the correct values. (Bug#39957)
- MyODBC would crash when a character set was being used on the server that was not supported in the client, for example `cp1251`:

```
[MySQL][ODBC 5.1 Driver][mysqld-5.0.27-community-nt]Restricted data type attribute violation
```

The fix causes MyODBC to return an error message instead of crashing. (Bug#39831)

- When the `SQLTables` method was called with `NULL` passed as the `tablename` parameter, only one row in the `resultset`, with table name of `NULL` was returned, instead of all tables for the given database. (Bug#39561)
- The `SQLGetInfo()` function returned 0 for `SQL_CATALOG_USAGE` information. (Bug#39560)
- MyODBC Driver 5.1.5 was not able to connect if the connection string parameters contained spaces or tab symbols. For example, if the `SERVER` parameter was specified as “SERVER= localhost” instead of “SERVER=localhost” the following error message will be displayed:

```
[MySQL][ODBC 5.1 Driver] Unknown MySQL server host ' localhost' (11001).
```

(Bug#39085)

- The pointer passed to the `SQLDriverConnect` method to retrieve the output connection string length was one greater than it should have been due to the inclusion of the `NULL` terminator. (Bug#38949)
- Data-at-execution parameters were not supported during positioned update. This meant updating a long text field with a cursor update would erroneously set the value to null. This would lead to the error `Column 'column_name' cannot be null` while updating the database, even when `column_name` had been assigned a valid non-null string. (Bug#37649)
- The `SQLDriverConnect` method truncated the `OutputConnectionString` parameter to 52 characters. (Bug#37278)
- The connection string option `Enable Auto-reconnect` did not work. When the connection failed, it could not be restored, and the errors generated were the same as if the option had not been selected. (Bug#37179)
- Insertion of data into a `LONGTEXT` table field did not work. If such an attempt was made the corresponding field would be found to be empty on examination, or contain random characters. (Bug#36071)
- No result record was returned for `SQLGetTypeInfo` for the `TIMESTAMP` data type. An application would receive the result `return code 100 (SQL_NO_DATA_FOUND)`. (Bug#30626)
- It was not possible to use Connector/ODBC to connect to a server using SSL. The following error was generated:

```
Runtime error '-2147467259 (80004005)':
```

```
[MySQL][ODBC 3.51 Driver]SSL connection error.
```

(Bug#29955)

- When the `recordSet.Update` function was called to update an `adLongVarChar` field, the field was updated but the recordset was immediately lost. This happened with driver cursors, whether the cursor was opened in optimistic or pessimistic mode.

When the next update was called the test code would exit with the following error:

```
-2147467259 : Query-based update failed because the row to update could not be found.
```

(Bug#26950)

## C.4.2. Changes in MySQL Connector/ODBC 5.1.5 (18 August 2008)

Bugs fixed:

- ODBC `TIMESTAMP` string format is not handled properly by the MyODBC driver. When passing a `TIMESTAMP` or `DATE` to MyODBC, in the ODBC format: `{d <date>}` or `{ts <timestamp>}`, the string that represents this is copied once into the SQL statement, and then added again, as an escaped string. (Bug#37342)

- The connector failed to prompt for additional information required to create a DSN-less connection from an application such as Microsoft Excel. ([Bug#37254](#))
- `SQLDriverConnect` does not return `SQL_NO_DATA` on cancel. The ODBC documentation specifies that this method should return `SQL_NO_DATA` when the user cancels the dialog to connect. The connector, however, returns `SQL_ERROR`. ([Bug#36293](#))
- Assigning a string longer than 67 characters to the `TableType` parameter resulted in a buffer overrun when the `SQLTables()` function was called. ([Bug#36275](#))
- The ODBC connector randomly uses logon information stored in `odbc-profile`, or prompts the user for connection information and ignores any settings stored in `odbc-profile`. ([Bug#36203](#))
- After having successfully established a connection, a crash occurs when calling `SQLProcedures()` followed by `SQLFreeStmt()`, using the ODBC C API. ([Bug#36069](#))

### C.4.3. Changes in MySQL Connector/ODBC 5.1.4 (15 April 2008)

Bugs fixed:

- Wrong result obtained when using `sum()` on a `decimal(8,2)` field type. ([Bug#35920](#))
- The driver installer could not create a new DSN if many other drivers were already installed. ([Bug#35776](#))
- The `SQLColAttribute()` function returned `SQL_TRUE` when querying the `SQL_DESC_FIXED_PREC_SCALE` (`SQL_COLUMN_MONEY`) attribute of a `DECIMAL` column. Previously, the correct value of `SQL_FALSE` was returned; this is now again the case. ([Bug#35581](#))
- On Linux, `SQLGetDiagRec()` returned `SQL_SUCCESS` in cases when it should have returned `SQL_NO_DATA`. ([Bug#33910](#))
- The driver crashes ODBC Administrator on attempting to add a new DSN. ([Bug#32057](#))

### C.4.4. Changes in MySQL Connector/ODBC 5.1.3 (26 March 2008)

Platform specific notes:

- **Important Change:** You must uninstall previous 5.1.x editions of Connector/ODBC before installing the new version.
- The HP-UX 11.23 IA64 binary package does not include the GUI bits because of problems building Qt on that platform.
- There is no binary package for Mac OS X on 64-bit PowerPC because Apple does not currently provide a 64-bit PowerPC version of iODBC.
- The installer for 64-bit Windows installs both the 32-bit and 64-bit driver. Please note that Microsoft does not yet supply a 64-bit bridge from ADO to ODBC.

Bugs fixed:

- **Important Change:** In previous versions, the SSL certificate would automatically be verified when used as part of the Connector/ODBC connection. The default mode is now to ignore the verification of certificates. To enforce verification of the SSL certificate during connection, use the `SSLVERIFY` DSN parameter, setting the value to 1. ([Bug#29955](#), [Bug#34648](#))
- Inserting characters to a UTF8 table using surrogate pairs would fail and insert invalid data. ([Bug#34672](#))
- Installation of Connector/ODBC would fail because it was unable to uninstall a previous installed version. The file being requested would match an older release version than any installed version of the connector. ([Bug#34522](#))
- Using `SqlGetData` in combination with `SQL_C_WCHAR` would return overlapping data. ([Bug#34429](#))
- Descriptor records were not cleared correctly when calling `SQLFreeStmt(SQL_UNBIND)`. ([Bug#34271](#))
- The dropdown selection for databases on a server when creating a DSN was too small. The list size now automatically adjusts up to a maximum size of 20 potential databases. ([Bug#33918](#))



- Microsoft Access would be unable to use `DBEngine.RegisterDatabase` to create a DSN using the Connector/ODBC driver. ([Bug#33825](#))
- Connector/ODBC erroneously reported that it supported the `CAST()` and `CONVERT()` ODBC functions for parsing values in SQL statements, which could lead to bad SQL generation during a query. ([Bug#33808](#))
- Using a linked table in Access 2003 where the table has a `BIGINT` column as the first column in the table, and is configured as the primary key, shows `#DELETED` for all rows of the table. ([Bug#24535](#))
- Updating a `RecordSet` when the query involves a `BLOB` field would fail. ([Bug#19065](#))

## C.4.5. Changes in MySQL Connector/ODBC 5.1.2 (13 February 2008)

MySQL Connector/ODBC 5.1.2-beta, a new version of the ODBC driver for the MySQL database management system, has been released. This release is the second beta (feature-complete) release of the new 5.1 series and is suitable for use with any MySQL server version since MySQL 4.1, including MySQL 5.0, 5.1, and 6.0. (It will not work with 4.0 or earlier releases.)

Keep in mind that this is a beta release, and as with any other pre-production release, caution should be taken when installing on production level systems or systems with critical data.

Platform specific notes:

- The HP-UX 11.23 IA64 binary package does not include the GUI bits because of problems building Qt on that platform.
- There is no binary package for Mac OS X on 64-bit PowerPC because Apple does not currently provide a 64-bit PowerPC version of iODBC.
- The installer for 64-bit Windows installs both the 32-bit and 64-bit driver. Please note that Microsoft does not yet supply a 64-bit bridge from ADO to ODBC.
- Due to differences with the installation process used on Windows and potential registry corruption, it is recommended that uninstall any existing versions of Connector/ODBC 5.1.x before upgrading.

See also [Bug#34571](#).

Functionality added or changed:

- Explicit descriptors are implemented. ([Bug#32064](#))
- A full implementation of `SQLForeignKeys` based on the information available from `INFORMATION_SCHEMA` in 5.0 and later versions of the server has been implemented.
- Changed `SQL_ATTR_PARAMSET_SIZE` to return an error until support for it is implemented.
- Disabled `MYSQL_OPT_SSL_VERIFY_SERVER_CERT` when using an SSL connection.
- `SQLForeignKeys` uses `INFORMATION_SCHEMA` when it is available on the server, which allows more complete information to be returned.

Bugs fixed:

- The `SSLCIPHER` option would be incorrectly recorded within the SSL configuration on Windows. ([Bug#33897](#))
- Within the GUI interface, when connecting to a MySQL server on a non-standard port, the connection test within the GUI would fail. The issue was related to incorrect parsing of numeric values within the DSN when the option was not configured as the last parameter within the DSN. ([Bug#33822](#))
- Specifying a non-existent database name within the GUI dialog would result in an empty list, not an error. ([Bug#33615](#))
- When deleting rows from a static cursor, the cursor position would be incorrectly reported. ([Bug#33388](#))
- `SQLGetInfo()` reported characters for `SQL_SPECIAL_CHARACTERS` that were not encoded correctly. ([Bug#33130](#))
- Retrieving data from a `BLOB` column would fail within `SQLGetData` when the target data type was `SQL_C_WCHAR` due to incorrect handling of the character buffer. ([Bug#32684](#))

- Renaming an existing DSN entry would create a new entry with the new name without deleting the old entry. ([Bug#31165](#))
- Reading a `TEXT` column that had been used to store UTF8 data would result in the wrong information being returned during a query. ([Bug#28617](#))
- `SQLForeignKeys` would return an empty string for the schema columns instead of `NULL`. ([Bug#19923](#))
- When accessing column data, `FLAG_COLUMN_SIZE_S32` did not limit the octet length or display size reported for fields, causing problems with Microsoft Visual FoxPro.

The list of ODBC functions that could have caused failures in Microsoft software when retrieving the length of `LONGBLOB` or `LONGTEXT` columns includes:

- `SQLColumns`
- `SQLColAttribute`
- `SQLColAttributes`
- `SQLDescribeCol`
- `SQLSpecialColumns` (theoretically can have the same problem) ([Bug#12805](#), [Bug#30890](#))
- Dynamic cursors on statements with parameters were not supported. ([Bug#11846](#))
- Evaluating a simple numeric expression when using the OLEDB for ODBC provider and ADO would return an error, instead of the result. ([Bug#10128](#))
- Adding or updating a row using `SQLSetPos()` on a result set with aliased columns would fail. ([Bug#6157](#))

## C.4.6. Changes in MySQL Connector/ODBC 5.1.1 (13 December 2007)

MySQL Connector/ODBC 5.1.1-beta, a new version of the ODBC driver for the MySQL database management system, has been released. This release is the first beta (feature-complete) release of the new 5.1 series and is suitable for use with any MySQL server version since MySQL 4.1, including MySQL 5.0, 5.1, and 6.0. (It will not work with 4.0 or earlier releases.)

Keep in mind that this is a beta release, and as with any other pre-production release, caution should be taken when installing on production level systems or systems with critical data.

Includes changes from [Connector/ODBC 3.51.21](#) and [3.51.22](#).

Built using MySQL 5.0.52.

Platform specific notes:

- The HP-UX 11.23 IA64 binary package does not include the GUI bits because of problems building Qt on that platform.
- There is no binary package for Mac OS X on 64-bit PowerPC because Apple does not currently provide a 64-bit PowerPC version of iODBC.
- The installer for 64-bit Windows installs both the 32-bit and 64-bit driver. Please note that Microsoft does not yet supply a 64-bit bridge from ADO to ODBC.
- Due to differences with the installation process used on Windows and potential registry corruption, it is recommended that un-install any existing versions of Connector/ODBC 5.1.x before upgrading.

See also [Bug#34571](#).

Functionality added or changed:

- **Incompatible Change:** Replaced `myodbc3i` (now `myodbc-installer`) with Connector/ODBC 5.0 version.
- **Incompatible Change:** Removed `monitor` (`myodbc3m`) and `dsn-editor` (`myodbc3c`).
- **Incompatible Change:** Disallow `SET NAMES` in initial statement and in executed statements.



- A wrapper for the `SQLGetPrivateProfileStringW()` function, which is required for Unicode support, has been created. This function is missing from the unixODBC driver manager. (Bug#32685)
- Added MSI installer for Windows 64-bit. (Bug#31510)
- Implemented support for `SQLCancel()`. (Bug#15601)
- Added support for `SQL_NUMERIC_STRUCT`. (Bug#3028, Bug#24920)
- Removed non-threadsafe configuration of the driver. The driver is now always built against the threadsafe version of libmysql.
- Implemented native Windows setup library
- Replaced the internal library which handles creation and loading of DSN information. The new library, which was originally a part of Connector/ODBC 5.0, supports Unicode option values.
- The Windows installer now places files in a subdirectory of the `Program Files` directory instead of the Windows system directory.

#### Bugs fixed:

- The `SET NAMES` statement has been disabled because it causes problems in the ODBC driver when determining the current client character set. (Bug#32596)
- `SQLDescribeColW` returned UTF-8 column as `SQL_VARCHAR` instead of `SQL_WVARCHAR`. (Bug#32161)
- ADO was unable to open record set using dynamic cursor. (Bug#32014)
- ADO applications would not open a `RecordSet` that contained a `DECIMAL` field. (Bug#31720)
- Memory usage would increase considerably. (Bug#31115)
- SQL statements are limited to 64KB. (Bug#30983, Bug#30984)
- `SQLSetPos` with `SQL_DELETE` advances dynamic cursor incorrectly. (Bug#29765)
- Using an ODBC prepared statement with bound columns would produce an empty result set when called immediately after inserting a row into a table. (Bug#29239)
- ADO Not possible to update a client side cursor. (Bug#27961)
- Recordset `Update()` fails when using `adUseClient` cursor. (Bug#26985)
- Connector/ODBC would fail to connect to the server if the password contained certain characters, including the semicolon and other punctuation marks. (Bug#16178)
- Fixed `SQL_ATTR_PARAM_BIND_OFFSET`, and fixed row offsets to work with updatable cursors.
- `SQLSetConnectAttr()` did not clear previous errors, possibly confusing `SQLError()`.
- `SQLError()` incorrectly cleared the error information, making it unavailable from subsequent calls to `SQLGetDiagRec()`.
- NULL pointers passed to `SQLGetInfo()` could result in a crash.
- `SQL_ODBC_SQL_CONFORMANCE` was not handled by `SQLGetInfo()`.
- `SQLCopyDesc()` did not correctly copy all records.
- Diagnostics were not correctly cleared on connection and environment handles.

## C.4.7. Changes in MySQL Connector/ODBC 5.1.0 (10 September 2007)

This release is the first of the new 5.1 series and is suitable for use with any MySQL server version since MySQL 4.1, including MySQL 5.0, 5.1, and 6.0. (It will not work with 4.0 or earlier releases.)

Keep in mind that this is an alpha release, and as with any other pre-production release, caution should be taken when installing on production level systems or systems with critical data. Not all of the features planned for the final Connector/ODBC 5.1 release are implemented.

Functionality is based on Connector/ODBC 3.51.20.

Platform specific notes:

- The HP-UX 11.23 IA64 binary package does not include the GUI bits because of problems building Qt on that platform.
- There is no binary package for Mac OS X on 64-bit PowerPC because Apple does not currently provide a 64-bit PowerPC version of iODBC.
- There are no installer packages for Microsoft Windows x64 Edition.
- Due to differences with the installation process used on Windows and potential registry corruption, it is recommended that un-install any existing versions of Connector/ODBC 5.1.x before upgrading.

See also [Bug#34571](#).

Functionality added or changed:

- Added support for Unicode functions (`SQLConnectW`, etc).
- Added descriptor support (`SQLGetDescField`, `SQLGetDescRec`, etc).
- Added support for `SQL_C_WCHAR`.

## C.4.8. Changes in MySQL Connector/ODBC 5.0.12 (Never released)

### Note

Development on Connector/ODBC 5.0.x has ceased. New features and functionality will be incorporated into Connector/ODBC 5.1. See [Section 20.1.2.1, “Connector/ODBC Roadmap”](#).

Bugs fixed:

- Inserting `NULL` values into a `DATETIME` column from Access reports an error. ([Bug#27896](#))
- Tables with `TEXT` columns would be incorrectly identified, returning an `Unknown SQL type - 65535` error. ([Bug#20127](#))

## C.4.9. Changes in MySQL Connector/ODBC 5.0.11 (31 January 2007)

Functionality added or changed:

- Added support for ODBC v2 statement options using attributes.
- Driver now builds and is partially tested under Linux with the iODBC driver manager.

Bugs fixed:

- Connection string parsing for DSN-less connections could fail to identify some parameters. ([Bug#25316](#))
- Updates of `MEMO` or `TEXT` columns from within Microsoft Access would fail. ([Bug#25263](#))
- Transaction support has been added and tested. ([Bug#25045](#))
- Internal function, `my_setpos_delete_ignore()` could cause a crash. ([Bug#22796](#))
- Fixed occasional mis-handling of the `SQL_NUMERIC_C` type.
- Fixed the binding of certain integer types.

## C.4.10. Changes in MySQL Connector/ODBC 5.0.10 (14 December 2006)

Connector/ODBC 5.0.10 is the sixth BETA release.

Functionality added or changed:

- Significant performance improvement when retrieving large text fields in pieces using `SQLGetData()` with a buffer smaller than the whole data. Mainly used in Access when fetching very large text fields. ([Bug#24876](#))
- Added initial unicode support in data and metadata. ([Bug#24837](#))
- Added initial support for removing braces when calling stored procedures and retrieving result sets from procedure calls. ([Bug#24485](#))
- Added loose handling of retrieving some diagnostic data. ([Bug#15782](#))
- Added wide-string type info for `SQLGetTypeInfo()`.

Bugs fixed:

- Editing DSN no longer crashes ODBC data source administrator. ([Bug#24675](#))
- String query parameters are now escaped correctly. ([Bug#19078](#))

### C.4.11. Changes in MySQL Connector/ODBC 5.0.9 (22 November 2006)

Connector/ODBC 5.0.9 is the fifth BETA release.

This is an implementation and testing release, and is not designed for use within a production environment.

Functionality added or changed:

- Added support for column binding as `SQL_NUMERIC_STRUCT`.
- Added recognition of `SQL_C_SHORT` and `SQL_C_TINYINT` as C types.

Bugs fixed:

- Fixed wildcard handling of and listing of catalogs and tables in `SQLTables`.
- Added limit of display size when requested via `SQLColAttribute/SQL_DESC_DISPLAY_SIZE`.
- Fixed buffer length return for `SQLDriverConnect`.
- ODBC v2 behaviour in driver now supports ODBC v3 date/time types (since `DriverManager` maps them).
- Catch use of `SQL_ATTR_PARAMSET_SIZE` and report error until we fully support.
- Fixed statistics to fail if it couldn't be completed.
- Corrected retrieval multiple field types bit and blob/text.
- Fixed `SQLGetData` to clear the NULL indicator correctly during multiple calls.

### C.4.12. Changes in MySQL Connector/ODBC 5.0.8 (17 November 2006)

Connector/ODBC 5.0.8 is the fourth BETA release.

This is an implementation and testing release, and is not designed for use within a production environment.

Functionality added or changed:

- Also made `SQL_DESC_NAME` only fill in the name if there was a data pointer given, otherwise just the length.

- Fixed display size to be length if max length isn't available.
- Made distinction between [CHAR/BINARY](#) (and VAR versions).
- Wildcards now support escaped chars and underscore matching (needed to link tables with underscores in access).

Bugs fixed:

- Fixed binding using [SQL\\_C\\_LONG](#).
- Fixed using wrong pointer for [SQL\\_MAX\\_DRIVER\\_CONNECTIONS](#) in [SQLGetInfo](#).
- Set default return to [SQL\\_SUCCESS](#) if nothing is done for [SQLSpecialColumns](#).
- Fixed MDiagnostic to use correct v2/v3 error codes.
- Allow [SQLDescribeCol](#) to be called to retrieve the length of the column name, but not the name itself.
- Length now used when handling bind parameter (needed in particular for [SQL\\_WCHAR](#)) - this enables updating char data in MS Access.
- Updated retrieval of descriptor fields to use the right pointer types.
- Fixed handling of numeric pointers in [SQLColAttribute](#).
- Fixed type returned for [MYSQL\\_TYPE\\_LONG](#) to [SQL\\_INTEGER](#) instead of [SQL\\_TINYINT](#).
- Fix size return from [SQLDescribeCol](#).
- Fixed string length to chars, not bytes, returned by [SQLGetDiagRec](#).

### C.4.13. Changes in MySQL Connector/ODBC 5.0.7 (08 November 2006)

Connector/ODBC 5.0.7 is the third BETA release.

This is an implementation and testing release, and is not designed for use within a production environment.

Functionality added or changed:

- Added support for [SQLStatistics](#) to [MYODBCShell](#).
- Improved trace/log.

Bugs fixed:

- [SQLBindParameter](#) now handles [SQL\\_C\\_DEFAULT](#).
- Corrected incorrect column index within [SQLStatistics](#). Many more tables can now be linked into MS Access.
- Fixed [SQLDescribeCol](#) returning column name length in bytes rather than chars.

### C.4.14. Changes in MySQL Connector/ODBC 5.0.6 (03 November 2006)

Connector/ODBC 5.0.6 is the second BETA release.

This is an implementation and testing release, and is not designed for use within a production environment.

Features, limitations and notes on this release

- Connector/ODBC supports both [User](#) and [System](#) DSNs.
- Installation is provided in the form of a standard Microsoft System Installer (MSI).

- You no longer have to have Connector/ODBC 3.51 installed before installing this version.

Bugs fixed:

- You no longer have to have Connector/ODBC 3.51 installed before installing this version.
- Connector/ODBC supports both [User](#) and [System](#) DSNs.
- Installation is provided in the form of a standard Microsoft System Installer (MSI).

### **C.4.15. Changes in MySQL Connector/ODBC 5.0.5 (17 October 2006)**

Connector/ODBC 5.0.5 is the first BETA release.

This is an implementation and testing release, and is not designed for use within a production environment.

You no longer have to have Connector/ODBC 3.51 installed before installing this version.

Bugs fixed:

- You no longer have to have Connector/ODBC 3.51 installed before installing this version.

### **C.4.16. Changes in Connector/ODBC 5.0.3 (Connector/ODBC 5.0 Alpha 3) (20 June 2006)**

This is an implementation and testing release, and is not designed for use within a production environment.

Features, limitations and notes on this release:

- The following ODBC API functions have been added in this release:
  - [SQLBindParameter](#)
  - [SQLBindCol](#)

### **C.4.17. Changes in Connector/ODBC 5.0.2 (Never released)**

Connector/ODBC 5.0.2 was an internal implementation and testing release.

### **C.4.18. Changes in Connector/ODBC 5.0.1 (Connector/ODBC 5.0 Alpha 2) (05 June 2006)**

Features, limitations and notes on this release:

- Connector/ODBC 5.0 is Unicode aware.
- Connector/ODBC is currently limited to basic applications. ADO applications and Microsoft Office are not supported.
- Connector/ODBC must be used with a Driver Manager.
- The following ODBC API functions are implemented:
  - [SQLAllocHandle](#)
  - [SQLCloseCursor](#)
  - [SQLColAttribute](#)
  - [SQLColumns](#)
  - [SQLConnect](#)

- `SQLCopyDesc`
- `SQLDisconnect`
- `SQLExecDirect`
- `SQLExecute`
- `SQLFetch`
- `SQLFreeHandle`
- `SQLFreeStmt`
- `SQLGetConnectAttr`
- `SQLGetData`
- `SQLGetDescField`
- `SQLGetDescRec`
- `SQLGetDiagField`
- `SQLGetDiagRec`
- `SQLGetEnvAttr`
- `SQLGetFunctions`
- `SQLGetStmtAttr`
- `SQLGetTypeInfo`
- `SQLNumResultCols`
- `SQLPrepare`
- `SQLRowcount`
- `SQLTables`

The following ODBC API function are implemented, but not yet support all the available attributes/options:

- `SQLSetConnectAttr`
- `SQLSetDescField`
- `SQLSetDescRec`
- `SQLSetEnvAttr`
- `SQLSetStmtAttr`

## C.4.19. Changes in MySQL Connector/ODBC 3.51.27 (20 November 2008)

Bugs fixed:

- The client program hung when the network connection to the server was interrupted. ([Bug#40407](#))
- The connection string option `Enable Auto-reconnect` did not work. When the connection failed, it could not be restored, and the errors generated were the same as if the option had not been selected. ([Bug#37179](#))
- It was not possible to use Connector/ODBC to connect to a server using SSL. The following error was generated:

```
Runtime error '-2147467259 (80004005)':  
[MySQL][ODBC 3.51 Driver]SSL connection error.
```

([Bug#29955](#))

## C.4.20. Changes in MySQL Connector/ODBC 3.51.26 (07 July 2008)

Functionality added or changed:

- There is a new connection option, `FLAG_NO_BINARY_RESULT`. When set this option disables charset 63 for columns with an empty `org_table`. ([Bug#29402](#))

Bugs fixed:

- When an `ADOConnection` is created and attempts to open a schema with `ADOConnection.OpenSchema` an access violation occurs in `myodbc3.dll`. ([Bug#30770](#))
- When `SHOW CREATE TABLE` was invoked and then the field values read, the result was truncated and unusable if the table had many rows and indexes. ([Bug#24131](#))

## C.4.21. Changes in MySQL Connector/ODBC 3.51.25 (11 April 2008)

Bugs fixed:

- The `SQLColAttribute()` function returned `SQL_TRUE` when querying the `SQL_DESC_FIXED_PREC_SCALE` (`SQL_COLUMN_MONEY`) attribute of a `DECIMAL` column. Previously, the correct value of `SQL_FALSE` was returned; this is now again the case. ([Bug#35581](#))
- The driver crashes ODBC Administrator on attempting to add a new DSN. ([Bug#32057](#))
- When accessing column data, `FLAG_COLUMN_SIZE_S32` did not limit the octet length or display size reported for fields, causing problems with Microsoft Visual FoxPro.

The list of ODBC functions that could have caused failures in Microsoft software when retrieving the length of `LONGBLOB` or `LONGTEXT` columns includes:

- `SQLColumns`
- `SQLColAttribute`
- `SQLColAttributes`
- `SQLDescribeCol`
- `SQLSpecialColumns` (theoretically can have the same problem) ([Bug#12805](#), [Bug#30890](#))

## C.4.22. Changes in MySQL Connector/ODBC 3.51.24 (14 March 2008)

Bugs fixed:

- **Security Enhancement:** Accessing a parameter with the type of `SQL_C_CHAR`, but with a numeric type and a length of zero, the parameter marker would get stripped from the query. In addition, an SQL injection was possible if the parameter value had a nonzero length and was not numeric, the text would be inserted verbatim. ([Bug#34575](#))
- **Important Change:** In previous versions, the SSL certificate would automatically be verified when used as part of the Connector/ODBC connection. The default mode is now to ignore the verification of certificates. To enforce verification of the SSL certificate during connection, use the `SSLVERIFY` DSN parameter, setting the value to 1. ([Bug#29955](#), [Bug#34648](#))
- When using ADO, the count of parameters in a query would always return zero. ([Bug#33298](#))
- Using tables with a single quote or other non-standard characters in the table or column names through ODBC would fail. ([Bug#32989](#))

- When using Crystal Reports, table and column names would be truncated to 21 characters, and truncated columns in tables where the truncated name was the duplicated would lead to only a single column being displayed. (Bug#32864)
- `SQLExtendedFetch()` and `SQLFetchScroll()` ignored the rowset size if the `Don't cache result` DSN option was set. (Bug#32420)
- When using the ODBC `SQL_TXN_READ_COMMITTED` option, 'dirty' records would be read from tables as if the option had not been applied. (Bug#31959)
- When creating a System DSN using the ODBC Administrator on Mac OS X, a User DSN would be created instead. The root cause is a problem with the iODBC driver manager used on Mac OS X. The fix works around this issue.

**Note**

ODBC Administrator may still be unable to register a System DSN unless the `/Library/ODBC/odbc.ini` file has the correct permissions. You should ensure that the file is writable by the `admin` group.

(Bug#31495)

- Calling `SQLFetch` or `SQLFetchScroll` would return negative data lengths when using `SQL_C_WCHAR`. (Bug#31220)
- `SQLSetParam()` caused memory allocation errors due to driver manager's mapping of deprecated functions (buffer length - 1). (Bug#29871)
- Static cursor was unable to be used through ADO when dynamic cursors were enabled. (Bug#27351)
- Using `connection.Execute` to create a record set based on a table without declaring the cmd option as `adCmdTable` will fail when communicating with versions of MySQL 5.0.37 and higher. The issue is related to the way that `SQLSTATE` is returned when ADO tries to confirm the existence of the target object. (Bug#27158)
- Updating a `RecordSet` when the query involves a `BLOB` field would fail. (Bug#19065)
- With some connections to MySQL databases using Connector/ODBC, the connection would mistakenly report 'user cancelled' for accesses to the database information. (Bug#16653)

### C.4.23. Changes in MySQL Connector/ODBC 3.51.23 (09 January 2008)

Platform specific notes:

- The HP-UX 11.23 IA64 binary package does not include the GUI bits because of problems building Qt on that platform.
- There is no binary package for Mac OS X on 64-bit PowerPC because Apple does not currently provide a 64-bit PowerPC version of iODBC.
- There are no installer packages for Microsoft Windows x64 Edition.

Bugs fixed:

- Connector/ODBC would incorrectly return `SQL_SUCCESS` when checking for distributed transaction support. (Bug#32727)
- When using unixODBC or directly linked applications where the thread level is set to less than 3 (within `odbcinst.ini`), a thread synchronization issue would lead to an application crash. This was because `SQLAllocStmt()` and `SQLFreeStmt()` did not synchronize access to the list of statements associated with a connection. (Bug#32587)
- Cleaning up environment handles in multithread environments could result in a five (or more) second delay. (Bug#32366)
- Renaming an existing DSN entry would create a new entry with the new name without deleting the old entry. (Bug#31165)
- Setting the default database using the `DefaultDatabase` property of an ADO `Connection` object would fail with the error `Provider does not support this property`. The `SQLGetInfo()` returned the wrong value for `SQL_DATABASE_NAME` when no database was selected. (Bug#3780)

### C.4.24. Changes in MySQL Connector/ODBC 3.51.22 (13 November 2007)

Functionality added or changed:



- The workaround for this bug was removed due to the fixes in MySQL Server 5.0.48 and 5.1.21.

This regression was introduced by [Bug#10491](#).

Bugs fixed:

- The `English` locale would be used when formatting floating point values. The `C` locale is now used for these values. ([Bug#32294](#))
- When accessing information about supported operations, the driver would return incorrect information about the support for `UNION`. ([Bug#32253](#))
- Unsigned integer values greater than the maximum value of a signed integer would be handled incorrectly. ([Bug#32171](#))
- The wrong result was returned by `SQLGetData()` when the data was an empty string and a zero-sized buffer was specified. ([Bug#30958](#))
- Added the `FLAG_COLUMN_SIZE_S32` option to limit the reported column size to a signed 32-bit integer. This option is automatically enabled for ADO applications to provide a work around for a bug in ADO. ([Bug#13776](#))

## C.4.25. Changes in MySQL Connector/ODBC 3.51.21 (08 October 2007)

Bugs fixed:

- When using a rowset/cursor and add a new row with a number of fields, subsequent rows with fewer fields will include the original fields from the previous row in the final `INSERT` statement. ([Bug#31246](#))
- Uninitiated memory could be used when C/ODBC internally calls `SQLGetFunctions()`. ([Bug#31055](#))
- The wrong `SQL_DESC_LITERAL_PREFIX` would be returned for date/time types. ([Bug#31009](#))
- The wrong `COLUMN_SIZE` would be returned by `SQLGetTypeInfo` for the `TIME` columns (`SQL_TYPE_TIME`). ([Bug#30939](#))
- Clicking outside the character set selection box when configuring a new DSN could cause the wrong character set to be selected. ([Bug#30568](#))
- Not specifying a user in the DSN dialog would raise a warning even though the parameter is optional. ([Bug#30499](#))
- `SQLSetParam()` caused memory allocation errors due to driver manager's mapping of deprecated functions (buffer length - 1). ([Bug#29871](#))
- When using ADO, a column marked as `AUTO_INCREMENT` could incorrectly report that the column allowed `NULL` values. This was due to an issue with `NULLABLE` and `IS_NULLABLE` return values from the call to `SQLColumns()`. ([Bug#26108](#))
- Connector/ODBC would return the wrong the error code when the server disconnects the active connection because the configured `wait_timeout` has expired. Previously it would return `HY000`. Connector/ODBC now correctly returns an `SQLSTATE` of `08S01`. ([Bug#3456](#))

## C.4.26. Changes in MySQL Connector/ODBC 3.51.20 (10 September 2007)

Bugs fixed:

- Using `FLAG_NO_PROMPT` doesn't suppress the dialogs normally handled by `SQLDriverConnect`. ([Bug#30840](#))
- The specified length of the user name and authentication parameters to `SQLConnect()` were not being honored. ([Bug#30774](#))
- The wrong column size was returned for binary data. ([Bug#30547](#))
- `SQLGetData()` will now always return `SQL_NO_DATA_FOUND` on second call when no data left, even if requested size is 0. ([Bug#30520](#))
- `SQLGetConnectAttr()` did not reflect the connection state correctly. ([Bug#14639](#))

- Removed checkbox in setup dialog for `FLAG_FIELD_LENGTH` (identified as `Don't Optimize Column Width` within the GUI dialog), which was removed from the driver in 3.51.18.

## C.4.27. Changes in MySQL Connector/ODBC 3.51.19 (10 August 2007)

Connector/ODBC 3.51.19 fixes a specific issue with the 3.51.18 release. For a list of changes in the 3.51.18 release, see [Section C.4.28, "Changes in MySQL Connector/ODBC 3.51.18 \(08 August 2007\)"](#).

Functionality added or changed:

- Because of [Bug#10491](#) in the server, character string results were sometimes incorrectly identified as `SQL_VARBINARY`. Until this server bug is corrected, the driver will identify all variable-length strings as `SQL_VARCHAR`.

## C.4.28. Changes in MySQL Connector/ODBC 3.51.18 (08 August 2007)

Platform specific notes:

- The HP-UX 11.23 IA64 binary package does not include the GUI bits because of problems building Qt on that platform.
- There is no binary package for Mac OS X on 64-bit PowerPC because Apple does not currently provide a 64-bit PowerPC version of iODBC.
- Binary packages for Sun Solaris are now available as `PKG` packages.
- Binary packages as disk images with installers are now available for Mac OS X.
- A binary package without an installer is available for Microsoft Windows x64 Edition. There are no installer packages for Microsoft Windows x64 Edition.

Functionality added or changed:

- **Incompatible Change:** The `FLAG_DEBUG` option was removed.
- When connecting to a specific database when using a DSN, the system tables from the `mysql` database are no longer also available. Previously, tables from the `mysql` database (catalog) were listed as `SYSTEM TABLES` by `SQLTables()` even when a different catalog was being queried. ([Bug#28662](#))
- Installed for Mac OS X has been re-instated. The installer registers the driver at a system (not user) level and makes it possible to create both user and system DSNs using the Connector/ODBC driver. The installer also fixes the situation where the necessary drivers would be installed local to the user, not globally. ([Bug#15326](#), [Bug#10444](#))
- Connector/ODBC now supports batched statements. In order to enable cached statement support you must switch enable the batched statement option (`FLAG_MULTI_STATEMENTS`, 67108864, or `ALLOW MULTIPLE STATEMENTS` within a GUI configuration). Be aware that batched statements create an increased chance of SQL injection attacks and you must ensure that your application protects against this scenario. ([Bug#7445](#))
- The `SQL_ATTR_ROW_BIND_OFFSET_PTR` is now supported for row bind offsets. ([Bug#6741](#))
- The `TRACE` and `TRACEFILE` DSN options have been removed. Use the ODBC driver manager trace options instead.

Bugs fixed:

- When using a table with multiple `TIMESTAMP` columns, the final `TIMESTAMP` column within the table definition would not be updateable. Note that there is still a limitation in MySQL server regarding multiple `TIMESTAMP` columns. ([Bug#9927](#)) ([Bug#30081](#))
- Fixed an issue where the `myodbc3i` would update the user ODBC configuration file (`~/Library/ODBC/odbcinst.ini`) instead of the system `/Library/ODBC/odbcinst.ini`. This was caused because `myodbc3i` was not honoring the `s` and `u` modifiers for the `-d` command-line option. ([Bug#29964](#))
- Getting table metadata (through the `SQLColumns()`) would fail, returning a bad table definition to calling applications. ([Bug#29888](#))

- `DATETIME` column types would return `FALSE` in place of `SQL_SUCCESS` when requesting the column type information. (Bug#28657)
- The `SQL_COLUMN_TYPE`, `SQL_COLUMN_DISPLAY` and `SQL_COLUMN_PRECISION` values would be returned incorrectly by `SQLColumns()`, `SQLDescribeCol()` and `SQLColAttribute()` when accessing character columns, especially those generated through `concat()`. The lengths returned should now conform to the ODBC specification. The `FLAG_FIELD_LENGTH` option no longer has any affect on the results returned. (Bug#27862)
- Obtaining the length of a column when using a character set for the connection of `utf8` would result in the length being returned incorrectly. (Bug#19345)
- The `SQLColumns()` function could return incorrect information about `TIMESTAMP` columns, indicating that the field was not nullable. (Bug#14414)
- The `SQLColumns()` function could return incorrect information about `AUTO_INCREMENT` columns, indicating that the field was not nullable. (Bug#14407)
- A binary package without an installer is available for Microsoft Windows x64 Edition. There are no installer packages for Microsoft Windows x64 Edition.
- There is no binary package for Mac OS X on 64-bit PowerPC because Apple does not currently provide a 64-bit PowerPC version of iODBC.
- `BIT(n)` columns are now treated as `SQL_BIT` data where  $n = 1$  and binary data where  $n > 1$ .
- The wrong value from `SQL_DESC_LITERAL_SUFFIX` was returned for binary fields.
- The `SQL_DATETIME_SUB` column in `SQLColumns()` was not correctly set for date and time types.
- The value for `SQL_DESC_FIXED_PREC_SCALE` was not returned correctly for values in MySQL 5.0 and later.
- The wrong value for `SQL_DESC_TYPE` was returned for date and time types.
- `SQLConnect()` and `SQLDriverConnect()` were rewritten to eliminate duplicate code and ensure all options were supported using both connection methods. `SQLDriverConnect()` now only requires the setup library to be present when the call requires it.
- The HP-UX 11.23 IA64 binary package does not include the GUI bits because of problems building Qt on that platform.
- Binary packages as disk images with installers are now available for Mac OS X.
- Binary packages for Sun Solaris are now available as `PKG` packages.
- The wrong value for `DECIMAL_DIGITS` in `SQLColumns()` was reported for `FLOAT` and `DOUBLE` fields, as well as the wrong value for the scale parameter to `SQLDescribeCol()`, and the `SQL_DESC_SCALE` attribute from `SQLColAttribute()`.
- The `SQL_DATA_TYPE` column in `SQLColumns()` results did not report the correct value for date and time types.

## C.4.29. Changes in MySQL Connector/ODBC 3.51.17 (14 July 2007)

Platform specific notes:

- The HP-UX 11.23 IA64 binary package does not include the GUI bits because of problems building Qt on that platform.
- There is no binary package for Mac OS X on 64-bit PowerPC because Apple does not currently provide a 64-bit PowerPC version of iODBC.
- Binary packages for Sun Solaris are now available as `PKG` packages.
- Binary packages as disk images with installers are now available for Mac OS X.
- A binary package without an installer is available for Microsoft Windows x64 Edition. There are no installer packages for Microsoft Windows x64 Edition.

Functionality added or changed:

- It is now possible to specify a different character set as part of the DSN or connection string. This must be used instead of the `SET NAMES` statement. You can also configure the character set value from the GUI configuration. ([Bug#9498](#), [Bug#6667](#))
- Fixed calling convention ptr and wrong free in `myodbc3i`, and fixed the null terminating (was only one, not two) when writing DSN to string.
- Dis-allow NULL ptr for null indicator when calling `SQLGetData()` if value is null. Now returns `SQL_ERROR` w/state 22002.
- The setup library has been split into its own RPM package, to allow installing the driver itself with no GUI dependencies.

Bugs fixed:

- `myodbc3i` did not correctly format driver info, which could cause the installation to fail. ([Bug#29709](#))
- Connector/ODBC crashed with Crystal Reports due to a rproblem with `SQLProcedures()`. ([Bug#28316](#))
- Fixed a problem where the GUI would crash when configuring or removing a System or User DSN. ([Bug#27315](#))
- Fixed error handling of out-of-memory and bad connections in catalog functions. This might raise errors in code paths that had ignored them in the past. ([Bug#26934](#))
- For a stored procedure that returns multiple result sets, Connector/ODBC returned only the first result set. ([Bug#16817](#))
- Calling `SQLGetDiagField` with `RecNumber 0`, `DiagIdentifier NOT 0` returned `SQL_ERROR`, preventing access to diagnostic header fields. ([Bug#16224](#))
- Added a new DSN option (`FLAG_ZERO_DATE_TO_MIN`) to retrieve `XXXX-00-00` dates as the minimum allowed ODBC date (`XXXX-01-01`). Added another option (`FLAG_MIN_DATE_TO_ZERO`) to mirror this but for bound parameters. `FLAG_MIN_DATE_TO_ZERO` only changes `0000-01-01` to `0000-00-00`. ([Bug#13766](#))
- If there was more than one unique key on a table, the correct fields were not used in handling `SQLSetPos()`. ([Bug#10563](#))
- When inserting a large `BLOB` field, Connector/ODBC would crash due to a memory allocation error. ([Bug#10562](#))
- The driver was using `mysql_odbc_escape_string()`, which does not handle the `NO_BACKSLASH_ESCAPES` SQL mode. Now it uses `mysql_real_escape_string()`, which does. ([Bug#9498](#))
- `SQLColumns()` did not handle many of its parameters correctly, which could lead to incorrect results. The table name argument was not handled as a pattern value, and most arguments were not escaped correctly when they contained non-alphanumeric characters. ([Bug#8860](#))
- There are no binary packages for Microsoft Windows x64 Edition.
- There is no binary package for Mac OS X on 64-bit PowerPC because Apple does not currently provide a 64-bit PowerPC version of iODBC.
- Correctly return error if `SQLBindCol` is called with an invalid column.
- Fixed possible crash if `SQLBindCol()` was not called before `SQLSetPos()`.
- The Mac OS X binary packages are only provided as tarballs, there is no installer.
- The binary packages for Sun Solaris are only provided as tarballs, not the PKG format.
- The HP-UX 11.23 IA64 binary package does not include the GUI bits because of problems building Qt on that platform.

### C.4.30. Changes in MySQL Connector/ODBC 3.51.16 (14 June 2007)

Functionality added or changed:

- Connector/ODBC now supports using SSL for communication. This is not yet exposed in the setup GUI, but must be enabled through configuration files or the DSN. ([Bug#12918](#))

Bugs fixed:

- Calls to `SQLNativeSql()` could cause stack corruption due to an incorrect pointer cast. ([Bug#28758](#))
- Using cursors on results sets with multi-column keys could select the wrong value. ([Bug#28255](#))
- `SQLForeignKeys` does not escape `_` and `%` in the table name arguments. ([Bug#27723](#))
- When using stored procedures, making a `SELECT` or second stored procedure call after an initial stored procedure call, the second statement will fail. ([Bug#27544](#))
- `SQLTables()` did not distinguish tables from views. ([Bug#23031](#))
- Data in `TEXT` columns would fail to be read correctly. ([Bug#16917](#))
- Specifying strings as parameters using the `adBSTR` or `adVarChar` types, (`SQL_WVARCHAR` and `SQL_WLONGVARCHAR`) would be incorrectly quoted. ([Bug#16235](#))
- `SQL_WVARCHAR` and `SQL_WLONGVARCHAR` parameters were not properly quoted and escaped. ([Bug#16235](#))
- Using `BETWEEN` with date values, the wrong results could be returned. ([Bug#15773](#))
- When using the `Don't Cache Results` (option value `1048576`) with Microsoft Access, the connection will fail using DAO/VisualBasic. ([Bug#4657](#))
- Return values from `SQLTables()` may be truncated. (Bugs #22797)

### C.4.31. Changes in MySQL Connector/ODBC 3.51.15 (07 May 2007)

Bugs fixed:

- Connector/ODBC would incorrectly claim to support `SQLProcedureColumns` (by returning true when queried about `SQL-PROCEDURECOLUMNS` with `SQLGetFunctions`), but this functionality is not supported. ([Bug#27591](#))
- An incorrect transaction isolation level may not be returned when accessing the connection attributes. ([Bug#27589](#))
- Adding a new DSN with the `myodbc3i` utility under AIX would fail. ([Bug#27220](#))
- When inserting data using bulk statements (through `SQLBulkOperations`), the indicators for all rows within the insert would not updated correctly. ([Bug#24306](#))
- Using `SQLProcedures` does not return the database name within the returned resultset. ([Bug#23033](#))
- The `SQLTransact()` function did not support an empty connection handle. ([Bug#21588](#))
- Using `SQLDriverConnect` instead of `SQLConnect` could cause later operations to fail. ([Bug#7912](#))
- When using blobs and parameter replacement in a statement with `WHERE CURSOR OF`, the SQL is truncated. ([Bug#5853](#))
- Connector/ODBC would return too many foreign key results when accessing tables with similar names. ([Bug#4518](#))

### C.4.32. Changes in MySQL Connector/ODBC 3.51.14 (08 March 2007)

Functionality added or changed:

- Use of `SQL_ATTR_CONNECTION_TIMEOUT` on the server has now been disabled. If you attempt to set this attribute on your connection the `SQL_SUCCESS_WITH_INFO` will be returned, with an error number/string of `HYC00: Optional feature not supported`. ([Bug#19823](#))
- Added `auto is null` option to Connector/ODBC option parameters. ([Bug#10910](#))
- Added `auto-reconnect` option to Connector/ODBC option parameters.
- Added support for the `HENV` handlers in `SQLEndTran()`.

Bugs fixed:

- On 64-bit systems, some types would be incorrectly returned. ([Bug#26024](#))
- When retrieving `TIME` columns, C/ODBC would incorrectly interpret the type of the string and could interpret it as a `DATE` type instead. ([Bug#25846](#))
- Connector/ODBC may insert the wrong parameter values when using prepared statements under 64-bit Linux. ([Bug#22446](#))
- Using Connector/ODBC, with `SQLBindCol` and binding the length to the return value from `SQL_LEN_DATA_AT_EXEC` fails with a memory allocation error. ([Bug#20547](#))
- Using `DataAdapter`, Connector/ODBC may continually consume memory when reading the same records within a loop (Windows Server 2003 SP1/SP2 only). ([Bug#20459](#))
- When retrieving data from columns that have been compressed using `COMPRESS( )`, the retrieved data would be truncated to 8KB. ([Bug#20208](#))
- The ODBC driver name and version number were incorrectly reported by the driver. ([Bug#19740](#))
- A string format exception would be raised when using iODBC, Connector/ODBC and the embedded MySQL server. ([Bug#16535](#))
- The `SQLDriverConnect( )` ODBC method did not work with recent Connector/ODBC releases. ([Bug#12393](#))

### C.4.33. Changes in MySQL Connector/ODBC 3.51.13 (Never released)

Connector/ODBC 3.51.13 was an internal implementation and testing release.

### C.4.34. Changes in MySQL Connector/ODBC 3.51.12 (11 February 2005)

Functionality added or changed:

- N/A

Bugs fixed:

- Using stored procedures with ADO, where the `CommandType` has been set correctly to `adCmdStoredProc`, calls to stored procedures would fail. ([Bug#15635](#))
- File DSNs could not be saved. ([Bug#12019](#))
- `SQLColumns( )` returned no information for tables that had a column named using a reserved word. ([Bug#9539](#))

### C.4.35. Changes in MySQL Connector/ODBC 3.51.11 (28 January 2005)

Bugs fixed:

- `mysql_list_dbcolumns( )` and `insert_fields( )` were retrieving all rows from a table. Fixed the queries generated by these functions to return no rows. ([Bug#8198](#))
- `SQLGetTypeInfo( )` returned `tinyblob` for `SQL_VARBINARY` and nothing for `SQL_BINARY`. Fixed to return `varbinary` for `SQL_VARBINARY`, `binary` for `SQL_BINARY`, and `longblob` for `SQL_LONGVARBINARY`. ([Bug#8138](#))

## C.5. MySQL Connector/NET Change History

### C.5.1. Changes in MySQL Connector/NET 6.0.4 (Not yet released beta)

This is a new Beta development release, fixing recently discovered bugs.

Bugs fixed:

- A SQL query string containing an escaped backslash caused an exception to be generated:

```

Index and length must refer to a location within the string.
Parameter name: length
at System.String.InternalSubStringWithChecks(Int32 startIndex, Int32 length, Boolean
fAlwaysCopy)
at MySql.Data.MySqlClient.MySqlTokenizer.NextParameter()
at MySql.Data.MySqlClient.Statement.InternalBindParameters(String sql,
MySqlParameterCollection parameters, MySqlPacket packet)
at MySql.Data.MySqlClient.Statement.BindParameters()
at MySql.Data.MySqlClient.PreparableStatement.Execute()
at MySql.Data.MySqlClient.MySqlCommand.ExecuteReader(CommandBehavior behavior)
at MySql.Data.MySqlClient.MySqlCommand.ExecuteNonQuery()

```

(Bug#44960)

- The Microsoft Visual Studio solution file `MySQL-VS2005.sln` was invalid. Several projects could not be loaded and thus it was not possible to build Connector/NET from source. (Bug#44822)
- The `DataReader` in Connector/NET 6.0.3 considered a `BINARY(16)` field as a `GUID` with a length of 16. (Bug#44507)
- When creating a new `DataSet` the following error was generated:

```

Failed to open a connection to database.
Cannot load type with name 'MySql.Data.VisualStudio.StoredProcedureColumnEnumerator'

```

(Bug#44460)

- The Connector/NET `MySQLRoleProvider` reported that there were no roles, even when roles existed. (Bug#44414)

## C.5.2. Changes in MySQL Connector/NET 6.0.3 (28 April 2009 beta)

This is a new Beta development release, fixing recently discovered bugs.

Functionality added or changed:

- The `MySqlTokenizer` failed to split fieldnames from values if they were not separated by a space. This also happened if the string contained certain characters. As a result `MySqlCommand.ExecuteNonQuery` raised an index out of range exception.

The resulting errors are illustrated by the following examples. Note, the example statements do not have delimiting spaces around the `=` operator.

```

INSERT INTO anytable SET Text='test--test';

```

The tokenizer incorrectly interpreted the value as containing a comment.

```

UPDATE anytable SET Project='123-456',Text='Can you explain this ?',Duration=15 WHERE
ID=4711;

```

A `MySqlException` was generated, as the `?` in the value was interpreted by the tokenizer as a parameter sign. The error message generated was:

```

Fatal error encountered during command execution.
EXCEPTION: MySqlException - Parameter '?' must be defined.

```

(Bug#44318)

Bugs fixed:

- `MySQL.Data` was not displayed as a Reference inside Microsoft Visual Studio 2008 Professional.

When a new C# project was created in Microsoft Visual Studio 2008 Professional, `MySQL.Data` was not displayed when `REFERENCES`, `ADD REFERENCE` was selected. (Bug#44141)

- Column types for `SchemaProvider` and `ISSchemaProvider` did not match.

When the source code in `SchemaProvider.cs` and `ISSchemaProvider.cs` were compared it was apparent that they were not using the same column types. The base provider used SQL such as `SHOW CREATE TABLE`, while `ISSchemaProvider` used the schema information tables. Column types used by the base class were `INT64` and the column types used by



`ISSchemaProvider` were `UNSIGNED`. ([Bug#44123](#))

### C.5.3. Changes in MySQL Connector/NET 6.0.2 (07 April 2009 beta)

This is a new Beta development release, fixing recently discovered bugs.

Bugs fixed:

- Connector/Net 6.0.1 did not load in Microsoft Visual Studio 2008 and Visual Studio 2005 Pro.

The following error message was generated:

```
.NET Framework Data Provider for MySQL: The data provider object factory service was not found.
```

([Bug#44064](#))

### C.5.4. Changes in MySQL Connector/NET 6.0.1 (02 April 2009 beta)

This is a new Beta development release, fixing recently discovered bugs.

Bugs fixed:

- An insert and update error was generated by the decimal data type in the Entity Framework, when a German collation was used. ([Bug#43574](#))
- Generating an Entity Data Model (EDM) schema with a table containing columns with data types `MEDIUMTEXT` and `LONGTEXT` generated a runtime error message "Max value too long or too short for Int32". ([Bug#43480](#))

### C.5.5. Changes in MySQL Connector/NET 6.0.0 (02 March 2009 alpha)

This is a new Alpha development release.

Bugs fixed:

- A null reference exception was generated when `MySqlConnection.ClearPool(connection)` was called. ([Bug#42801](#))

### C.5.6. Changes in MySQL Connector/NET 5.3.0 (Not yet released)

Bugs fixed:

- The Web Provider did not work at all on a remote host, and did not create a database when using `autogenerateschema="true"`. ([Bug#39072](#))
- The Connector/NET installer program ended prematurely without reporting the specific error. ([Bug#39019](#))
- When called with an incorrect password the `MembershipProvider.GetPassword()` method threw a `MySQLException` instead of a `MembershipPasswordException`. ([Bug#38939](#))
- Possible overflow in `MySqlPacket.ReadLong()`. ([Bug#36997](#))
- The `TokenizeSql` method was adding query overhead and causing high CPU utilization for larger queries. ([Bug#36836](#))

### C.5.7. Changes in MySQL Connector/NET 5.2.7 (Not yet released)

Bugs fixed:

- The Microsoft Visual Studio solution file `MySQL-VS2005.sln` was invalid. Several projects could not be loaded and thus it



was not possible to build Connector/NET from source. ([Bug#44822](#))

- The Connector/NET MySQLRoleProvider reported that there were no roles, even when roles existed. ([Bug#44414](#))
- When a TableAdapter was created on a DataSet, it was not possible to use a stored procedure with variables. The following error was generated:

```
The method or operation is not implemented
```

([Bug#39409](#))

## C.5.8. Changes in MySQL Connector/NET 5.2.6 (28 April 2009)

Functionality added or changed:

- A new connection string option has been added: `use affected rows`. When `true` the connection will report changed rows instead of found rows. ([Bug#44194](#))

Bugs fixed:

- Calling `GetSchema()` on `Indexes` or `IndexColumns` failed where index or column names were restricted.

In `SchemaProvider.cs`, methods `GetIndexes()` and `GetIndexColumns()` passed their restrictions directly to `GetTables()`. This only worked if the restrictions were no more specific than `schemaName` and `tableName`. If `IndexName` was given, this was passed to `GetTables()` where it was treated as `TableType`. As a result no tables were returned, unless the index name happened to be `BASE TABLE` or `VIEW`. This meant that both methods failed to return any rows. ([Bug#43991](#))

- `GetSchema("MetaDataCollections")` should have returned a table with a column named "NumberOfRestrictions" not "NumberOfRestriction".

This can be confirmed by referencing the [Microsoft Documentation](#). ([Bug#43990](#))

- Requests sent to the Connector/NET role provider to remove a user from a role failed. The query log showed the query was correctly executed within a transaction which was immediately rolled back. The rollback was caused by a missing call to the `Complete` method of the transaction. ([Bug#43553](#))
- When using `MySQLBulkLoader.Load()`, the text file is opened by `NativeDriver.SendFileToServer`. If it encountered a problem opening the file as a stream, an exception was generated and caught. An attempt to clean up resources was then made in the `finally{}` clause by calling `fs.Close()`, but since the stream was never successfully opened, this was an attempt to execute a method of a null reference. ([Bug#43332](#))
- A null reference exception was generated when `MySQLConnection.ClearPool(connection)` was called. ([Bug#42801](#))
- `MySQLMembershipProvider.ValidateUser` only used the `userId` to validate. However, it should also use the `applicationId` to perform the validation correctly.

The generated query was, for example:

```
SELECT Password, PasswordKey, PasswordFormat, IsApproved, Islockedout
FROM my_aspnet_Membership WHERE userId=13
```

Note that `applicationId` is not used. ([Bug#42574](#))

- There was an error in the `ProfileProvider` class in the `private ProfileInfoCollection GetProfiles()` function. The column of the final table was named "lastUpdatdDate" ('e' is missing) instead of the correct "lastUpdatedDate". ([Bug#41654](#))
- The `GetGuid()` method of `MySQLDataReader` did not treat `BINARY(16)` column data as a GUID. When operating on such a column a `FormatException` exception was generated. ([Bug#41452](#))
- When ASP.NET membership was configured to not require password question and answer using `requiresQuestionAndAnswer="false"`, a `SqlNullValueException` was generated when using `MembershipUser.ResetPassword()` to reset the user password. ([Bug#41408](#))

- If a `Stored Procedure` contained spaces in its parameter list, and was then called from Connector/NET, an exception was generated. However, the same `Stored Procedure` called from the MySQL Query Analyzer or the MySQL Client worked correctly.

The exception generated was:

```
Parameter '0' not found in the collection.
```

([Bug#41034](#))

- The `DATETIME` format contained an erroneous space. ([Bug#41021](#))
- When `MySql.Web.Profile.MySQLProfileProvider` was configured, it was not possible to assign a name other than the default name `MySQLProfileProvider`.

If the name `SCC_MySQLProfileProvider` was assigned, an exception was generated when attempting to use `Page.Context.Profile[ 'custom prop' ]`.

The exception generated was:

```
The profile default provider was not found.
```

Note that the exception stated: 'the profile **default provider...**', even though a different name was explicitly requested. ([Bug#40871](#))

- When `ExecuteNonQuery` was called with a command type of `Stored Procedure` it worked for one user but resulted in a hang for another user with the same database permissions.

However, if `CALL` was used in the command text and `ExecuteNonQuery` was used with a command type of `Text`, the call worked for both users. ([Bug#40139](#))

## C.5.9. Changes in MySQL Connector/NET 5.2.5 (19 November 2008)

Bugs fixed:

- Visual Studio 2008 displayed the following error three times on start-up:

```
"Package Load Failure
Package 'MySql.Data.VisualStudio.MySqlDataProviderPackage, MySql.VisualStudio,
Version=5.2.4, Culture=neutral, PublicKeyToken=null' has failed to load properly (GUID =
{79A115C9-B133-4891-9E7B-242509DAD272}). Please contact the package vendor for
assistance. Application restart is recommended, due to possible environment corruption.
Would you like to disable loading the package in the future? You may use
'devenve/resetskipkpgs' to re-enable package loading."
```

([Bug#40726](#))

## C.5.10. Changes in MySQL Connector/NET 5.2.4 (13 November 2008)

Bugs fixed:

- `MySqlDataReader` did not feature a `GetSByte` method. ([Bug#40571](#))
- When working with stored procedures Connector/NET generated an exception `Unknown "table parameters" in information_schema`. ([Bug#40382](#))
- `GetDefaultCollation` and `GetMaxLength` were not thread safe. These functions called the database to get a set of parameters and cached them in two static dictionaries in the function `InitCollections`. However, if many threads called them they would try to insert the same keys in the collections resulting in duplicate key exceptions. ([Bug#40231](#))
- If connection pooling was not set explicitly in the connection string, Connector/NET added “;Pooling=False” to the end of the connection string when `MySqlCommand.ExecuteReader()` was called.

If connection pooling was explicitly set in the connection string, when `MySqlConnection.Open()` was called it converted “Pooling=True” to “pooling=True”.

If `MySqlCommand.ExecuteReader()` was subsequently called, it concatenated “;Pooling=False” to the end of the connection string. The resulting connection string was thus terminated with “pooling=True;Pooling=False”. This disabled connection pooling completely. (Bug#40091)

- The connection string option `Functions Return String` did not set the correct encoding for the result string. Even though the connection string option `Functions Return String=true` is set, the result of `SELECT DES_DECRYPT()` contained “??” instead of the correct national character symbols. (Bug#40076)
- If, when using the `MySqlConnection` transaction object, an exception was thrown, the transaction object was not disposed of and the transaction was not rolled back. (Bug#39817)
- After the `ConnectionString` property was initialized via the public setter of `DbConnectionStringBuilder`, the `GetConnectionString` method of `MySqlConnectionStringBuilder` incorrectly returned `null` when `true` was assigned to the `includePass` parameter. (Bug#39728)
- When using `ProfileProvider`, attempting to update a previously saved property failed. (Bug#39330)
- Reading a negative time value greater than -01:00:00 returned the absolute value of the original time value. (Bug#39294)
- Inserting a negative time value (negative `TimeSpan`) into a `Time` column through the use of `MySqlParameter` caused `MySqlException` to be thrown. (Bug#39275)
- When a data connection was created in the server explorer of Visual Studio 2008 Team, an error was generated when trying to expand stored procedures that had parameters.

Also, if `TABLEADAPTER` was right-clicked and then `ADD, QUERY, USE EXISTING STORED PROCEDURES` selected, if you then attempted to select a stored procedure, the window would close and no error message would be displayed. (Bug#39252)

- The Web Provider did not work at all on a remote host, and did not create a database when using `autogenerateschema=true`. (Bug#39072)
- Connector/NET called hashed password methods not supported in Mono 2.0 Preview 2. (Bug#38895)

## C.5.11. Changes in MySQL Connector/NET 5.2.3 (19 August 2008)

Functionality added or changed:

- Error string was returned after a 28000 second `wait_timeout`. This has been changed to generate a `ConnectionState.Closed` event. (Bug#38119)
- Changed how the procedure schema collection is retrieved. If the connection string contains “`use procedure bodies=true`” then a `SELECT` is performed on the `mysql.proc` table directly, as this is up to 50 times faster than the current Information Schema implementation. If the connection string contains “`use procedure bodies=false`”, then the Information Schema collection is queried. (Bug#36694)
- Changed how the procedure schema collection is retrieved. If `use procedure bodies=true` then the `mysql.proc` table is selected directly as this is up to 50 times faster than the current `information_schema` implementation. If `use procedure bodies=false`, then the `information_schema` collection is queried. (Bug#36694)
- String escaping functionality has been moved from the `MySqlCommand` class to the `MySqlCommandHelper` class, where it can be accessed by the `EscapeString` method. (Bug#36205)

Bugs fixed:

- The `GetOrdinal()` method failed to return the ordinal if the column name string contained an accent. (Bug#38721)
- Connector/Net uninstaller did not clean up all installed files. (Bug#38534)
- There was a short circuit evaluation error in the `MySqlCommand.CheckState()` method. When the statement `connection == null` was true a `NullReferenceException` was thrown and not the expected `InvalidOperationException`. (Bug#38276)
- The provider did not silently create the user if the user did not exist. (Bug#38243)
- Executing a command that resulted in a fatal exception did not close the connection. (Bug#37991)

- When a prepared insert query is run that contains an `UNSIGNED TINYINT` in the parameter list, the complete query and data that should be inserted is corrupted and no error is thrown. (Bug#37968)
- In a .NET application MySQL Connector/NET modifies the connection string so that it contains several occurrences of the same option with different values. This is illustrated by the example that follows.

The original connection string:

```
host=localhost;database=test;uid=****;pwd=****;
connect timeout=25; auto enlist=false;pooling=false;
```

The connection string after closing `MySqlDataReader`:

```
host=localhost;database=test;uid=****;pwd=****;
connect timeout=25;auto enlist=false;pooling=false;
Allow User Variables=True;Allow User Variables=False;
Allow User Variables=True;Allow User Variables=False;
```

(Bug#37955)

- Unnecessary network traffic was generated for the normal case where the web provider schema was up to date. (Bug#37469)
- `MySqlReader.GetOrdinal()` performance enhancements break existing functionality. (Bug#37239)
- The `autogenerateschema` option produced tables with incorrect collations. (Bug#36444)
- `GetSchema` did not work correctly when querying for a collection, if using a non-English locale. (Bug#35459)
- When reading back a stored double or single value using the .NET provider, the value had less precision than the one stored. (Bug#33322)
- Using the MySQL Visual Studio plugin and a MySQL 4.1 server, certain field types (`ENUM`) would not be identified correctly. Also, when looking for tables, the plugin would list all tables matching a wildcard pattern of the database name supplied in the connection string, instead of only tables within the specified database. (Bug#30603)

## C.5.12. Changes in MySQL Connector/NET 5.2.2 (12 May 2008)

Bugs fixed:

- Product documentation incorrectly stated '?' is the preferred parameter marker. (Bug#37349)
- An incorrect value for a bit field would returned in a multi-row query if a preceding value for the field returned `NULL`. (Bug#36313)
- Tables with `GEOMETRY` field types would return an unknown datatype exception. (Bug#36081)
- When using the `MySQLProfileProvider`, setting profile details and then reading back saved data would result in the default values being returned instead of the updated values. (Bug#36000)
- When creating a connection, setting the `ConnectionString` property of `MySqlConnection` to `NULL` would throw an exception. (Bug#35619)
- The `DbCommandBuilder.QuoteIdentifier` method was not implemented. (Bug#35492)
- When using encrypted passwords, the `GetPassword()` function would return the wrong string. (Bug#35336)
- An error would be raised when calling `GetPassword()` with a `NULL` value. (Bug#35332)
- When retrieving data where a field has been identified as containing a GUID value, the incorrect value would be returned when a previous row contained a `NULL` value for that field. (Bug#35041)
- Using the `TableAdapter Wizard` would fail when generating commands that used stored procedures due to the change in supported parameter characters. (Bug#34941)
- When creating a new stored procedured, the new parameter code which allows the use of the @ symbol would interfere with the specification of a `DEFINER`. (Bug#34940)
- When using `SqlDataSource` to open a connection, the connection would not automatically be closed when access had completed. (Bug#34460)

- There was a high level of contention in the connection pooling code that could lead to delays when opening connections and submitting queries. The connection pooling code has been modified to try and limit the effects of the contention issue. ([Bug#34001](#))
- Using the [TableAdaptor](#) wizard in combination with a suitable [SELECT](#) statement, only the associated [INSERT](#) statement would also be created, rather than the required [DELETE](#) and [UPDATE](#) statements. ([Bug#31338](#))
- Fixed problem in datagrid code related to creating a new table. This problem may have been introduced with .NET 2.0 SP1.
- Fixed profile provider that would throw an exception if you were updating a profile that already existed.

### C.5.13. Changes in MySQL Connector/NET 5.2.1 (27 February 2008)

Bugs fixed:

- When using the provider to generate or update users and passwords, the password checking algorithm would not validate the password strength or requirements correctly. ([Bug#34792](#))
- When executing statements that used stored procedures and functions, the new parameter code could fail to identify the correct parameter format. ([Bug#34699](#))
- The installer would fail to the DDEX provider binary if the Visual Studio 2005 component was not selected. The result would lead to Connector/NET not loading properly when using the interface to a MySQL server within Visual Studio. ([Bug#34674](#))
- A number issues were identified in the case, connection and schema areas of the code for [MembershipProvider](#), [RoleProvider](#), [ProfileProvider](#). ([Bug#34495](#))
- When using web providers, the Connector/NET would check the schema and cache the application id, even when the connection string had been set. The effect would be to break the membership provider list. ([Bug#34451](#))
- Attempting to use an isolation level other than the default with a transaction scope would use the default isolation level. ([Bug#34448](#))
- When altering a stored procedure within Visual Studio, the parameters to the procedure could be lost. ([Bug#34359](#))
- A race condition could occur within the procedure cache resulting the cache contents overflowing beyond the configured cache size. ([Bug#34338](#))
- Fixed problem with Visual Studio 2008 integration that caused pop-up menus on server explorer nodes to not function
- The provider code has been updated to fix a number of outstanding issues.

### C.5.14. Changes in MySQL Connector/NET 5.2.0 (11 February 2008)

Functionality added or changed:

- Performing [GetValue\(\)](#) on a field [TINYINT\(1\)](#) returned a [BOOLEAN](#). While not a bug, this caused problems in software that expected an [INT](#) to be returned. A new connection string option [Treat Tiny As Boolean](#) has been added with a default value of [true](#). If set to [false](#) the provider will treat [TINYINT\(1\)](#) as [INT](#). ([Bug#34052](#))
- Added support for [DbDataAdapter UpdateBatchSize](#). Batching is fully supported including collapsing inserts down into the multi-value form if possible.
- DDEX provider now works under Visual Studio 2008 beta 2.
- Added [ClearPool](#) and [ClearAllPools](#) features.

Bugs fixed:

- Some speed improvements have been implemented in the [TokenizeSql](#) process used to identify elements of SQL statements. ([Bug#34220](#))
- When accessing tables from different databases within the same [TransactionScope](#), the same user/password combination would be used for each database connection. Connector/NET does not handle multiple connections within the same transaction scope. An error is now returned if you attempt this process, instead of using the incorrect authorization information.

[Bug#34204](#)

- The status of connections reported through the state change handler was not being updated correctly. ([Bug#34082](#))
- Incorporated some connection string cache optimizations sent to us by Maxim Mass. ([Bug#34000](#))
- In an open connection where the server had disconnected unexpectedly, the status information of the connection would not be updated properly. ([Bug#33909](#))
- Data cached from the connection string could return invalid information because the internal routines were not using case-sensitive semantics. This led to updated connection string options not being recognized if they were of a different case than the existing cached values. ([Bug#31433](#))
- Column name metadata was not using the character set as defined within the connection string being used. ([Bug#31185](#))
- Memory usage could increase and decrease significantly when updating or inserting a large number of rows. ([Bug#31090](#))
- Commands executed from within the state change handler would fail with a `NULL` exception. ([Bug#30964](#))
- When running a stored procedure multiple times on the same connection, the memory usage could increase indefinitely. ([Bug#30116](#))
- Using compression in the MySQL connection with Connector/NET would be slower than using native (uncompressed) communication. ([Bug#27865](#))
- The `MySqlDbType.Datetime` has been replaced with `MySqlDbType.DateTime`. The old format has been obsoleted. ([Bug#26344](#))

## C.5.15. Changes in MySQL Connector/NET 5.1.8 (Not yet released)

Bugs fixed:

- Calling `GetSchema()` on `Indexes` or `IndexColumns` failed where index or column names were restricted.  
  
In `SchemaProvider.cs`, methods `GetIndexes()` and `GetIndexColumns()` passed their restrictions directly to `GetTables()`. This only worked if the restrictions were no more specific than `schemaName` and `tableName`. If `IndexName` was given, this was passed to `GetTables()` where it was treated as `TableType`. As a result no tables were returned, unless the index name happened to be `BASE TABLE` or `VIEW`. This meant that both methods failed to return any rows. ([Bug#43991](#))
- The `DATETIME` format contained an erroneous space. ([Bug#41021](#))
- If connection pooling was not set explicitly in the connection string, Connector/NET added “;Pooling=False” to the end of the connection string when `MySqlCommand.ExecuteReader()` was called.  
  
If connection pooling was explicitly set in the connection string, when `MySqlConnection.Open()` was called it converted “Pooling=True” to “pooling=True”.  
  
If `MySqlCommand.ExecuteReader()` was subsequently called, it concatenated “;Pooling=False” to the end of the connection string. The resulting connection string was thus terminated with “pooling=True;Pooling=False”. This disabled connection pooling completely. ([Bug#40091](#))
- If, when using the `MySqlTransaction` transaction object, an exception was thrown, the transaction object was not disposed of and the transaction was not rolled back. ([Bug#39817](#))
- When a prepared insert query is run that contains an `UNSIGNED TINYINT` in the parameter list, the complete query and data that should be inserted is corrupted and no error is thrown. ([Bug#37968](#))

## C.5.16. Changes in MySQL Connector/NET 5.1.7 (21 August 2008)

Bugs fixed:

- There was a short circuit evaluation error in the `MySqlCommand.CheckState()` method. When the statement `connection == null` was true a `NullReferenceException` was thrown and not the expected `InvalidOperationException`. ([Bug#38276](#))

- Executing a command that resulted in a fatal exception did not close the connection. ([Bug#37991](#))
- In a .NET application MySQL Connector/NET modifies the connection string so that it contains several occurrences of the same option with different values. This is illustrated by the example that follows.

The original connection string:

```
host=localhost;database=test;uid=*****;pwd=*****;
connect timeout=25; auto enlist=false;pooling=false;
```

The connection string after closing `MySqlDataReader`:

```
host=localhost;database=test;uid=*****;pwd=*****;
connect timeout=25;auto enlist=false;pooling=false;
Allow User Variables=True;Allow User Variables=False;
Allow User Variables=True;Allow User Variables=False;
```

([Bug#37955](#))

- As `MySqlDbType.DateTime` is not available in VB .Net the warning `THE DATETIME ENUM VALUE IS OBSOLETE` was always shown during compilation. ([Bug#37406](#))
- An unknown `MySqlErrorCode` was encountered when opening a connection with an incorrect password. ([Bug#37398](#))
- Documentation incorrectly stated that “the DataColumn class in .NET 1.0 and 1.1 does not allow columns with type of UInt16, UInt32, or UInt64 to be autoincrement columns”. ([Bug#37350](#))
- `SemaphoreFullException` is generated when application is closed. ([Bug#36688](#))
- `GetSchema` did not work correctly when querying for a collection, if using a non-English locale. ([Bug#35459](#))
- When reading back a stored double or single value using the .NET provider, the value had less precision than the one stored. ([Bug#33322](#))
- Using the MySQL Visual Studio plugin and a MySQL 4.1 server, certain field types (`ENUM`) would not be identified correctly. Also, when looking for tables, the plugin would list all tables matching a wildcard pattern of the database name supplied in the connection string, instead of only tables within the specified database. ([Bug#30603](#))

## C.5.17. Changes in MySQL Connector/NET 5.1.6 (12 May 2008)

Bugs fixed:

- When creating a connection pool, specifying an invalid IP address will cause the entire application to crash, instead of providing an exception. ([Bug#36432](#))
- An incorrect value for a bit field would returned in a multi-row query if a preceding value for the field returned `NULL`. ([Bug#36313](#))
- The `MembershipProvider` will raise an exception when the connection string is configured with `enablePasswordRetrieval = true` and `RequireQuestionAndAnswer = false`. ([Bug#36159](#))
- When calling `GetNumberOfUsersOnline` an exception is raised on the submitted query due to a missing parameter. ([Bug#36157](#))
- Tables with `GEOMETRY` field types would return an unknown datatype exception. ([Bug#36081](#))
- When creating a connection, setting the `ConnectionString` property of `MySqlConnection` to `NULL` would throw an exception. ([Bug#35619](#))
- The `DbCommandBuilder.QuoteIdentifier` method was not implemented. ([Bug#35492](#))
- When using `SqlDataSource` to open a connection, the connection would not automatically be closed when access had completed. ([Bug#34460](#))
- Attempting to use an isolation level other than the default with a transaction scope would use the default isolation level. ([Bug#34448](#))
- When altering a stored procedure within Visual Studio, the parameters to the procedure could be lost. ([Bug#34359](#))



- A race condition could occur within the procedure cache resulting the cache contents overflowing beyond the configured cache size. ([Bug#34338](#))
- Using the `TableAdaptor` wizard in combination with a suitable `SELECT` statement, only the associated `INSERT` statement would also be created, rather than the required `DELETE` and `UPDATE` statements. ([Bug#31338](#))

## C.5.18. Changes in MySQL Connector/NET 5.1.5 (Not yet released)

Functionality added or changed:

- Performing `GetValue()` on a field `TINYINT(1)` returned a `BOOLEAN`. While not a bug, this caused problems in software that expected an `INT` to be returned. A new connection string option `Treat Tiny As Boolean` has been added with a default value of `true`. If set to `false` the provider will treat `TINYINT(1)` as `INT`. ([Bug#34052](#))

Bugs fixed:

- Some speed improvements have been implemented in the `TokenizeSql` process used to identify elements of SQL statements. ([Bug#34220](#))
- When accessing tables from different databases within the same `TransactionScope`, the same user/password combination would be used for each database connection. Connector/NET does not handle multiple connections within the same transaction scope. An error is now returned if you attempt this process, instead of using the incorrect authorization information. ([Bug#34204](#))
- The status of connections reported through the state change handler was not being updated correctly. ([Bug#34082](#))
- Incorporated some connection string cache optimizations sent to us by Maxim Mass. ([Bug#34000](#))
- In an open connection where the server had disconnected unexpectedly, the status information of the connection would not be updated properly. ([Bug#33909](#))
- Connector/NET would fail to compile properly with `nant`. ([Bug#33508](#))
- Problem with membership provider would mean that `FindUserByEmail` would fail with a `MySQLException` because it was trying to add a second parameter with the same name as the first. ([Bug#33347](#))
- Using compression in the MySQL connection with Connector/NET would be slower than using native (uncompressed) communication. ([Bug#27865](#))

## C.5.19. Changes in MySQL Connector/NET 5.1.4 (20 November 2007)

Bugs fixed:

- Setting the size of a string parameter after the value could cause an exception. ([Bug#32094](#))
- Creation of parameter objects with non-input direction using a constructor would fail. This was caused by some old legacy code preventing their use. ([Bug#32093](#))
- A date string could be returned incorrectly by `MySqlDateTime.ToString()` when the date returned by MySQL was `0000-00-00 00:00:00`. ([Bug#32010](#))
- A syntax error in a set of batch statements could leave the data adapter in a state that appears hung. ([Bug#31930](#))
- Installing over a failed uninstall of a previous version could result in multiple clients being registered in the `machine.config`. This would prevent certain aspects of the MySQL connection within Visual Studio to work properly. ([Bug#31731](#))
- Connector/NET would incorrectly report success when enlisting in a distributed transaction, although distributed transactions are not supported. ([Bug#31703](#))
- Data cached from the connection string could return invalid information because the internal routines were not using case-sensitive semantics. This led to updated connection string options not being recognized if they were of a different case than the existing cached values. ([Bug#31433](#))



- Trying to use a connection that was not open could return an ambiguous and misleading error message. ([Bug#31262](#))
- Column name metadata was not using the character set as defined within the connection string being used. ([Bug#31185](#))
- Memory usage could increase and decrease significantly when updating or inserting a large number of rows. ([Bug#31090](#))
- Commands executed from within the state change handler would fail with a `NULL` exception. ([Bug#30964](#))
- Extracting data through XML functions within a query returns the data as `System.Byte[]`. This was due to Connector/NET incorrectly identifying `BLOB` fields as binary, rather than text. ([Bug#30233](#))
- When running a stored procedure multiple times on the same connection, the memory usage could increase indefinitely. ([Bug#30116](#))
- Column types with only 1-bit (such as `BOOLEAN` and `TINYINT(1)`) were not returned as boolean fields. ([Bug#27959](#))
- When accessing certain statements, the command would timeout before the command completed. Because this cannot always be controlled through the individual command timeout options, a `default command timeout` has been added to the connection string options. ([Bug#27958](#))
- The server error code was not updated in the `Data[]` hash, which prevented `DbProviderFactory` users from accessing the server error code. ([Bug#27436](#))
- The `MySqlDbType.Datetime` has been replaced with `MySqlDbType.DateTime`. The old format has been obsoleted. ([Bug#26344](#))
- Changing the connection string of a connection to one that changes the parameter marker after the connection had been assigned to a command but before the connection is opened could cause parameters to not be found. ([Bug#13991](#))

## C.5.20. Changes in MySQL Connector/NET 5.1.3 (21 September 2007 beta)

This is a new Beta development release, fixing recently discovered bugs.

Bugs fixed:

- An incorrect `ConstraintException` could be raised on an `INSERT` when adding rows to a table with a multiple-column unique key index. ([Bug#30204](#))
- A `DATE` field would be updated with a date/time value, causing a `MySqlDataAdapter.Update()` exception. ([Bug#30077](#))
- The Saudi Hijri calendar was not supported. ([Bug#29931](#))
- Calling `SHOW CREATE PROCEDURE` for routines with a hyphen in the catalog name produced a syntax error. ([Bug#29526](#))
- Connecting to a MySQL server earlier than version 4.1 would raise a `NullException`. ([Bug#29476](#))
- The availability of a MySQL server would not be reset when using pooled connections (`pooling=true`). This would lead to the server being reported as unavailable, even if the server become available while the application was still running. ([Bug#29409](#))
- A `FormatException` error would be raised if a parameter had not been found, instead of `Resources.ParameterMustBeDefined`. ([Bug#29312](#))
- An exception would be thrown when using the Manage Role functionality within the web administrator to assign a role to a user. ([Bug#29236](#))
- Using the membership/role providers when `validationKey` or `decryptionKey` parameters are set to `AutoGenerate`, an exception would be raised when accessing the corresponding values. ([Bug#29235](#))
- Certain operations would not check the `UsageAdvisor` setting, causing log messages from the Usage Advisor even when it was disabled. ([Bug#29124](#))
- Using the same connection string multiple times would result in `Database=dbname` appearing multiple times in the resulting string. ([Bug#29123](#))
- *Visual Studio Plugin*: Adding a new query based on a stored procedure that uses the `SELECT` statement would terminate the query/TableAdapter wizard. ([Bug#29098](#))

- Using `TransactionScope` would cause an `InvalidOperationException`. (Bug#28709)

### C.5.21. Changes in MySQL Connector/NET 5.1.2 (18 June 2007)

This is a new Beta development release, fixing recently discovered bugs.

Bugs fixed:

- Log messages would be truncated to 300 bytes. (Bug#28706)
- Creating a user would fail due to the application name being set incorrectly. (Bug#28648)
- *Visual Studio Plugin*: Adding a new query based on a stored procedure that used a `UPDATE`, `INSERT` or `DELETE` statement would terminate the query/TableAdapter wizard. (Bug#28536)
- *Visual Studio Plugin*: Query Builder would fail to show `TINYTEXT` columns, and any columns listed after a `TINYTEXT` column correctly. (Bug#28437)
- Accessing the results from a large query when using data compression in the connection would fail to return all the data. (Bug#28204)
- *Visual Studio Plugin*: Update commands would not be generated correctly when using the TableAdapter wizard. (Bug#26347)

### C.5.22. Changes in MySQL Connector/NET 5.1.1 (23 May 2007)

Bugs fixed:

- Running the statement `SHOW PROCESSLIST` would return columns as byte arrays instead of native columns. (Bug#28448)
- Installation of the Connector/NET on Windows would fail if VisualStudio had not already been installed. (Bug#28260)
- Connector/NET would look for the wrong table when executing `User.IsRole()`. (Bug#28251)
- Building a connection string within a tight loop would show slow performance. (Bug#28167)
- The `UNSIGNED` flag for parameters in a stored procedure would be ignored when using `MySqlCommandBuilder` to obtain the parameter information. (Bug#27679)
- Using `MySQLDataAdapter.FillSchema()` on a stored procedure would raise an exception: `Invalid attempt to access a field before calling Read()`. (Bug#27668)
- `DATETIME` fields from versions of MySQL before 4.1 would be incorrectly parsed, resulting in an exception. (Bug#23342)
- Fixed password property on `MySqlConnectionStringBuilder` to use `PasswordPropertyText` attribute. This causes dots to show instead of actual password text.

### C.5.23. Changes in MySQL Connector/NET 5.1.0 (01 May 2007)

Functionality added or changed:

- Now compiles for .NET CF 2.0.
- Rewrote stored procedure parsing code using a new SQL tokenizer. Really nasty procedures including nested comments are now supported.
- `GetSchema` will now report objects relative to the currently selected database. What this means is that passing in null as a database restriction will report objects on the currently selected database only.
- Added Membership and Role provider contributed by Sean Wright (thanks!).

### C.5.24. Changes in MySQL Connector/NET 5.0.10 (Not yet released)

Bugs fixed:

---

- If, when using the `MySqlConnection` transaction object, an exception was thrown, the transaction object was not disposed of and the transaction was not rolled back. (Bug#39817)
- Executing a command that resulted in a fatal exception did not close the connection. (Bug#37991)
- When a prepared insert query is run that contains an `UNSIGNED TINYINT` in the parameter list, the complete query and data that should be inserted is corrupted and no error is thrown. (Bug#37968)
- In a .NET application MySQL Connector/NET modifies the connection string so that it contains several occurrences of the same option with different values. This is illustrated by the example that follows.

The original connection string:

```
host=localhost;database=test;uid=****;pwd=****;
connect timeout=25; auto enlist=false;pooling=false;
```

The connection string after closing `MySqlDataReader`:

```
host=localhost;database=test;uid=****;pwd=****;
connect timeout=25;auto enlist=false;pooling=false;
Allow User Variables=True;Allow User Variables=False;
Allow User Variables=True;Allow User Variables=False;
```

(Bug#37955)

- When creating a connection pool, specifying an invalid IP address will cause the entire application to crash, instead of providing an exception. (Bug#36432)
- `GetSchema` did not work correctly when querying for a collection, if using a non-English locale. (Bug#35459)
- When reading back a stored double or single value using the .NET provider, the value had less precision than the one stored. (Bug#33322)

## C.5.25. Changes in MySQL Connector/NET 5.0.9 (Not yet released)

Bugs fixed:

- The `DbCommandBuilder.QuoteIdentifier` method was not implemented. (Bug#35492)
- Setting the size of a string parameter after the value could cause an exception. (Bug#32094)
- Creation of parameter objects with non-input direction using a constructor would fail. This was caused by some old legacy code preventing their use. (Bug#32093)
- A date string could be returned incorrectly by `MySqlDateTime.ToString()` when the date returned by MySQL was `0000-00-00 00:00:00`. (Bug#32010)
- A syntax error in a set of batch statements could leave the data adapter in a state that appears hung. (Bug#31930)
- Installing over a failed uninstall of a previous version could result in multiple clients being registered in the `machine.config`. This would prevent certain aspects of the MySQL connection within Visual Studio to work properly. (Bug#31731)
- Data cached from the connection string could return invalid information because the internal routines were not using case-sensitive semantics. This led to updated connection string options not being recognized if they were of a different case than the existing cached values. (Bug#31433)
- Column name metadata was not using the character set as defined within the connection string being used. (Bug#31185)
- Memory usage could increase and decrease significantly when updating or inserting a large number of rows. (Bug#31090)
- Commands executed from within the state change handler would fail with a `NULL` exception. (Bug#30964)
- When running a stored procedure multiple times on the same connection, the memory usage could increase indefinitely. (Bug#30116)
- The server error code was not updated in the `Data[]` hash, which prevented `DbProviderFactory` users from accessing the server error code. (Bug#27436)

- Changing the connection string of a connection to one that changes the parameter marker after the connection had been assigned to a command but before the connection is opened could cause parameters to not be found. ([Bug#13991](#))

## C.5.26. Changes in MySQL Connector/NET 5.0.8 (21 August 2007)

### Note

This version introduces a new installer technology.

Bugs fixed:

- Extracting data through XML functions within a query returns the data as `System.Byte[]`. This was due to Connector/NET incorrectly identifying `BLOB` fields as binary, rather than text. ([Bug#30233](#))
- An incorrect `ConstraintException` could be raised on an `INSERT` when adding rows to a table with a multiple-column unique key index. ([Bug#30204](#))
- A `DATE` field would be updated with a date/time value, causing a `MySqlDataAdapter.Update()` exception. ([Bug#30077](#))
- Fixed bug where Connector/Net was hand building some date time patterns rather than using the patterns provided under `CultureInfo`. This caused problems with some calendars that do not support the same ranges as Gregorian.. ([Bug#29931](#))
- Calling `SHOW CREATE PROCEDURE` for routines with a hyphen in the catalog name produced a syntax error. ([Bug#29526](#))
- The availability of a MySQL server would not be reset when using pooled connections (`pooling=true`). This would lead to the server being reported as unavailable, even if the server become available while the application was still running. ([Bug#29409](#))
- A `FormatException` error would be raised if a parameter had not been found, instead of `Resources.ParameterMustBeDefined`. ([Bug#29312](#))
- Certain operations would not check the `UsageAdvisor` setting, causing log messages from the Usage Advisor even when it was disabled. ([Bug#29124](#))
- Using the same connection string multiple times would result in `Database=dbname` appearing multiple times in the resulting string. ([Bug#29123](#))
- Log messages would be truncated to 300 bytes. ([Bug#28706](#))
- Accessing the results from a large query when using data compression in the connection will fail to return all the data. ([Bug#28204](#))
- Fixed problem where `MySqlConnection.BeginTransaction` checked the drivers status var before checking if the connection was open. The result was that the driver could report an invalid condition on a previously opened connection.
- Fixed problem where we were not closing prepared statement handles when commands are disposed. This could lead to using up all prepared statement handles on the server.
- Fixed the database schema collection so that it works on servers that are not properly respecting the `lower_case_table_names` setting.
- Fixed problem where any attempt to not read all the records returned from a select where each row of the select is greater than 1024 bytes would hang the driver.
- Fixed problem where a command timing out just after it actually finished would cause an exception to be thrown on the command timeout thread which would then be seen as an unhandled exception.
- Fixed some serious issues with command timeout and cancel that could present as exceptions about thread ownership. The issue was that not all queries cancel the same. Some produce resultsets while others don't. `ExecuteReader` had to be changed to check for this.

## C.5.27. Changes in MySQL Connector/NET 5.0.7 (18 May 2007)

Bugs fixed:

- Running the statement `SHOW PROCESSLIST` would return columns as byte arrays instead of native columns. ([Bug#28448](#))
- Building a connection string within a tight loop would show slow performance. ([Bug#28167](#))
- Using logging (with the `logging=true` parameter to the connection string) would not generate a log file. ([Bug#27765](#))
- The `UNSIGNED` flag for parameters in a stored procedure would be ignored when using `MySQLCommandBuilder` to obtain the parameter information. ([Bug#27679](#))
- Using `MySQLDataAdapter.FillSchema()` on a stored procedure would raise an exception: `Invalid attempt to access a field before calling Read()`. ([Bug#27668](#))
- If you close an open connection with an active transaction, the transaction is not automatically rolled back. ([Bug#27289](#))
- When cloning an open `MySqlConnection` with the `Persist Security Info=False` option set, the cloned connection is not usable because the security information has not been cloned. ([Bug#27269](#))
- Enlisting a null transaction would affect the current connection object, such that further enlistment operations to the transaction are not possible. ([Bug#26754](#))
- Attempting to change the `Connection Protocol` property within a `PropertyGrid` control would raise an exception. ([Bug#26472](#))
- The `charset` property would not be identified during a connection (also affected Visual Studio Plugin). ([Bug#26147](#), [Bug#27240](#))
- The `CreateFormat` column of the `DataTypes` collection did not contain a format specification for creating a new column type. ([Bug#25947](#))
- `DATETIME` fields from versions of MySQL before 4.1 would be incorrectly parsed, resulting in an exception. ([Bug#23342](#))

## C.5.28. Changes in MySQL Connector/NET 5.0.6 (22 March 2007)

Bugs fixed:

- Publisher listed in "Add/Remove Programs" is not consistent with other MySQL products. ([Bug#27253](#))
- `DESCRIBE . . . .` SQL statement returns byte arrays rather than data on MySQL versions older than 4.1.15. ([Bug#27221](#))
- `cmd.Parameters.RemoveAt("Id")` will cause an error if the last item is requested. ([Bug#27187](#))
- `MySQLParameterCollection` and parameters added with `Insert` method can not be retrieved later using `ParameterName`. ([Bug#27135](#))
- Exception thrown when using large values in `UInt64` parameters. ([Bug#27093](#))
- MySQL Visual Studio Plugin 1.1.2 does not work with Connector/Net 5.0.5. ([Bug#26960](#))

## C.5.29. Changes in MySQL Connector/NET 5.0.5 (07 March 2007)

Functionality added or changed:

- Reverted behavior that required parameter names to start with the parameter marker. We apologize for this back and forth but we mistakenly changed the behavior to not match what `SqlCommand` supports. We now support using either syntax for adding parameters however we also respond exactly like `SqlCommand` in that if you ask for the index of a parameter using a syntax different from when you added the parameter, the result will be -1.
- Assembly now properly appears in the Visual Studio 2005 Add/Remove Reference dialog.
- Fixed problem that prevented use of `SchemaOnly` or `SingleRow` command behaviors with stored procedures or prepared statements.
- Added `MySQLParameterCollection.AddWithValue` and marked the `Add(name, value)` method as obsolete.
- Return parameters created with `DeriveParameters` now have the name `RETURN_VALUE`.
- Fixed problem with parameter name hashing where the hashes were not getting updated when parameters were removed from

the collection.

- Fixed problem with calling stored functions when a return parameter was not given.
- Added `Use Procedure Bodies` connection string option to allow calling procedures without using procedure metadata.

Bugs fixed:

- `MySqlConnection.GetSchema` fails with `NullReferenceException` for Foreign Keys. (Bug#26660)
- Connector/NET would fail to install under Windows Vista. (Bug#26430)
- Opening a connection would be slow due to host name lookup. (Bug#26152)
- Incorrect values/formats would be applied when the `OldSyntax` connection string option was used. (Bug#25950)
- Registry would be incorrectly populated with installation locations. (Bug#25928)
- Times with negative values would be returned incorrectly. (Bug#25912)
- Returned data types of a `DataTypes` collection do not contain the right correct CLR Datatype. (Bug#25907)
- `GetSchema` and `DataTypes` would throw an exception due to an incorrect table name. (Bug#25906)
- `MySqlConnection` throws an exception when connecting to MySQL v4.1.7. (Bug#25726)
- `SELECT` did not work correctly when using a `WHERE` clause containing a UTF-8 string. (Bug#25651)
- When closing and then re-opening a connection to a database, the character set specification is lost. (Bug#25614)
- Filling a table schema through a stored procedure triggers a runtime error. (Bug#25609)
- `BINARY` and `VARBINARY` columns would be returned as a string, not binary, datatype. (Bug#25605)
- A critical `ConnectionPool` error would result in repeated `System.NullReferenceException`. (Bug#25603)
- The `UpdateRowSource.FirstReturnedRecord` method does not work. (Bug#25569)
- When connecting to a MySQL Server earlier than version 4.1, the connection would hang when reading data. (Bug#25458)
- Using `ExecuteScalar()` with more than one query, where one query fails, will hang the connection. (Bug#25443)
- When a `MySqlConversionException` is raised on a remote object, the client application would receive a `SerializationException` instead. (Bug#24957)
- When connecting to a server, the return code from the connection could be zero, even though the host name was incorrect. (Bug#24802)
- High CPU utilization would be experienced when there is no idle connection waiting when using pooled connections through `MySqlConnection.GetConnection`. (Bug#24373)
- Connector/NET would not compile properly when used with Mono 1.2. (Bug#24263)
- Applications would crash when calling with `CommandType` set to `StoredProcedure`.

### C.5.30. Changes in MySQL Connector/NET 5.0.4 (Not released)

This is a new Beta development release, fixing recently discovered bugs.

### C.5.31. Changes in MySQL Connector/NET 5.0.3 (05 January 2007)

Functionality added or changed:

- Usage Advisor has been implemented. The Usage Advisor checks your queries and will report if you are using the connection inefficiently.
- PerfMon hooks have been added to monitor the stored procedure cache hits and misses.

- The `MySqlCommand` object now supports asynchronous query methods. This is implemented using the `BeginExecuteNonQuery` and `EndExecuteNonQuery` methods.
- Metadata from stored procedures and stored function execution are cached.
- The `CommandBuilder.DeriveParameters` function has been updated to the procedure cache.
- The `ViewColumns.GetSchema` collection has been updated.
- Improved speed and performance by re-architecting certain sections of the code.
- Support for the embedded server and client library have been removed from this release. Support will be added back to a later release.
- The `ShapZipLib` library has been replaced with the deflate support provided within .NET 2.0.
- SSL support has been updated.

#### Bugs fixed:

- Additional text added to error message ([Bug#25178](#))
- An exception would be raised, or the process would hang, if `SELECT` privileges on a database were not granted and a stored procedure was used. ([Bug#25033](#))
- When adding parameter objects to a command object, if the parameter direction is set to `ReturnValue` before the parameter is added to the command object then when the command is executed it throws an error. ([Bug#25013](#))
- Using `Driver.IsTooOld()` would return the wrong value. ([Bug#24661](#))
- When using a `DBNull.Value` as the value for a parameter value, and then later setting a specific value type, the command would fail with an exception because the wrong type was implied from the `DBNull.Value`. ([Bug#24565](#))
- Stored procedure executions are not thread safe. ([Bug#23905](#))
- Deleting a connection to a disconnected server when using the Visual Studio Plugin would cause an assertion failure. ([Bug#23687](#))
- Nested transactions (which are unsupported) do not raise an error or warning. ([Bug#22400](#))

## C.5.32. Changes in MySQL Connector/NET 5.0.2 (06 November 2006)

#### Functionality added or changed:

- An `Ignore Prepare` option has been added to the connection string options. If enabled, prepared statements will be disabled application-wide. The default for this option is true.
- Implemented a stored procedure cache. By default, the connector caches the metadata for the last 25 procedures that are seen. You can change the number of procedures that are cached by using the `procedure cache` connection string.
- **Important change:** Due to a number of issues with the use of server-side prepared statements, Connector/NET 5.0.2 has disabled their use by default. The disabling of server-side prepared statements does not affect the operation of the connector in any way.

To enable server-side prepared statements you must add the following configuration property to your connector string properties:

```
ignore prepare=false
```

The default value of this property is true.

#### Bugs fixed:

- One system where IPv6 was enabled, Connector/NET would incorrectly resolve host names. ([Bug#23758](#))



- Column names with accented characters were not parsed properly causing malformed column names in result sets. ([Bug#23657](#))
- An exception would be thrown when calling `GetSchemaTable` and `fields` was null. ([Bug#23538](#))
- A `System.FormatException` exception would be raised when invoking a stored procedure with an `ENUM` input parameter. ([Bug#23268](#))
- During installation, an antivirus error message would be raised (indicating a malicious script problem). ([Bug#23245](#))
- Creating a connection through the Server Explorer when using the Visual Studio Plugin would fail. The installer for the Visual Studio Plugin has been updated to ensure that Connector/NET 5.0.2 must be installed. ([Bug#23071](#))
- Using Windows Vista (RC2) as a non-privileged user would raise a `Registry key 'Global' access denied`. ([Bug#22882](#))
- Within Mono, using the `PreparedStatement` interface could result in an error due to a `BitArray` copying error. ([Bug#18186](#))
- Connector/NET did not work as a data source for the `SqlDataSource` object used by ASP.NET 2.0. ([Bug#16126](#))

### C.5.33. Changes in MySQL Connector/NET 5.0.1 (01 October 2006)

Bugs fixed:

- Connector/NET on a Turkish operating system, may fail to execute certain SQL statements correctly. ([Bug#22452](#))
- Starting a transaction on a connection created by `MySql.Data.MySqlClient.MySqlClientFactory`, using `BeginTransaction` without specifying an isolation level, causes the SQL statement to fail with a syntax error. ([Bug#22042](#))
- The `MySqlException` class is now derived from the `DbException` class. ([Bug#21874](#))
- The `#` would not be accepted within column/table names, even though it was valid. ([Bug#21521](#))
- You can now install the Connector/NET MSI package from the command line using the `/passive`, `/quiet`, `/q` options. ([Bug#19994](#))
- Submitting an empty string to a command object through `prepare` raises an `System.IndexOutOfRangeException`, rather than a Connector/Net exception. ([Bug#18391](#))
- Using `ExecuteScalar` with a datetime field, where the value of the field is "0000-00-00 00:00:00", a `MySqlConversionException` exception would be raised. ([Bug#11991](#))
- An `MySql.Data.Types.MySqlConversionException` would be raised when trying to update a row that contained a date field, where the date field contained a zero value (0000-00-00 00:00:00). ([Bug#9619](#))
- Executing multiple queries as part of a transaction returns `There is already an openDataReader associated with this Connection which must be closed first`. ([Bug#7248](#))
- Incorrect field/data lengths could be returned for `VARCHAR` UTF8 columns. Bug (#14592)

### C.5.34. Changes in MySQL Connector/NET 5.0.0 (08 August 2006)

Functionality added or changed:

- Replaced use of `ICSharpCode` with .NET 2.0 internal deflate support.
- Refactored test suite to test all protocols in a single pass.
- Added usage advisor warnings for requesting column values by the wrong type.
- Reimplemented `PacketReader/PacketWriter` support into `MySQLStream` class.
- Reworked connection string classes to be simpler and faster.
- Added procedure metadata caching.



- Added internal implementation of SHA1 so we don't have to distribute the OpenNetCF on mobile devices.
- Implemented `MySqlClientFactory` class.
- Added perfmon hooks for stored procedure cache hits and misses.
- Implemented classes and interfaces for ADO.Net 2.0 support.
- Added Async query methods.
- Implemented Usage Advisor.
- Completely refactored how column values are handled to avoid boxing in some cases.
- Implemented `MySqlConnectionBuilder` class.

Bugs fixed:

- CommandText: Question mark in comment line is being parsed as a parameter. ([Bug#6214](#))

### C.5.35. Changes in MySQL Connector/NET 1.0.11 (Not yet released)

Bugs fixed:

- Attempting to utilize MySQL Connector .Net version 1.0.10 throws a fatal exception under Mono when pooling is enabled. ([Bug#33682](#))
- Setting the size of a string parameter after the value could cause an exception. ([Bug#32094](#))
- Creation of parameter objects with non-input direction using a constructor would fail. This was caused by some old legacy code preventing their use. ([Bug#32093](#))
- Memory usage could increase and decrease significantly when updating or inserting a large number of rows. ([Bug#31090](#))
- Commands executed from within the state change handler would fail with a `NULL` exception. ([Bug#30964](#))
- Extracting data through XML functions within a query returns the data as `System.Byte[]`. This was due to Connector/NET incorrectly identifying `BLOB` fields as binary, rather than text. ([Bug#30233](#))
- Using compression in the MySQL connection with Connector/NET would be slower than using native (uncompressed) communication. ([Bug#27865](#))
- Changing the connection string of a connection to one that changes the parameter marker after the connection had been assigned to a command but before the connection is opened could cause parameters to not be found. ([Bug#13991](#))

### C.5.36. Changes in MySQL Connector/NET 1.0.10 (24 August 2007)

Bugs fixed:

- An incorrect `ConstraintException` could be raised on an `INSERT` when adding rows to a table with a multiple-column unique key index. ([Bug#30204](#))
- The availability of a MySQL server would not be reset when using pooled connections (`pooling=true`). This would lead to the server being reported as unavailable, even if the server became available while the application was still running. ([Bug#29409](#))
- Publisher listed in "Add/Remove Programs" is not consistent with other MySQL products. ([Bug#27253](#))
- `MySqlParameterCollection` and parameters added with `Insert` method can not be retrieved later using `ParameterName`. ([Bug#27135](#))
- `BINARY` and `VARBINARY` columns would be returned as a string, not binary, datatype. ([Bug#25605](#))
- A critical `ConnectionPool` error would result in repeated `System.NullReferenceException`. ([Bug#25603](#))

- When a `MySQLConversionException` is raised on a remote object, the client application would receive a `SerializationException` instead. (Bug#24957)
- High CPU utilization would be experienced when there is no idle connection waiting when using pooled connections through `MySQLPool.GetConnection`. (Bug#24373)

## C.5.37. Changes in MySQL Connector/NET 1.0.9 (02 February 2007)

Functionality added or changed:

- The `ICSharpCode ZipLib` is no longer used by the Connector, and is no longer distributed with it.
- **Important change:** Binaries for .NET 1.0 are no longer supplied with this release. If you need support for .NET 1.0, you must build from source.
- Improved `CommandBuilder.DeriveParameters` to first try and use the procedure cache before querying for the stored procedure metadata. Return parameters created with `DeriveParameters` now have the name `RETURN_VALUE`.
- An `Ignore Prepare` option has been added to the connection string options. If enabled, prepared statements will be disabled application-wide. The default for this option is true.
- Implemented a stored procedure cache. By default, the connector caches the metadata for the last 25 procedures that are seen. You can change the number of procedures that are cached by using the `procedure cache` connection string.
- **Important change:** Due to a number of issues with the use of server-side prepared statements, Connector/NET 5.0.2 has disabled their use by default. The disabling of server-side prepared statements does not affect the operation of the connector in any way.

To enable server-side prepared statements you must add the following configuration property to your connector string properties:

```
ignore prepare=false
```

The default value of this property is true.

Bugs fixed:

- Times with negative values would be returned incorrectly. (Bug#25912)
- `MySQLConnection` throws a `NullReferenceException` and `ArgumentNullException` when connecting to MySQL v4.1.7. (Bug#25726)
- `SELECT` did not work correctly when using a `WHERE` clause containing a UTF-8 string. (Bug#25651)
- When closing and then re-opening a connection to a database, the character set specification is lost. (Bug#25614)
- Trying to fill a table schema through a stored procedure triggers a runtime error. (Bug#25609)
- Using `ExecuteScalar()` with more than one query, where one query fails, will hang the connection. (Bug#25443)
- Additional text added to error message. (Bug#25178)
- When adding parameter objects to a command object, if the parameter direction is set to `ReturnValue` before the parameter is added to the command object then when the command is executed it throws an error. (Bug#25013)
- When connecting to a server, the return code from the connection could be zero, even though the host name was incorrect. (Bug#24802)
- Using `Driver.IsTooOld()` would return the wrong value. (Bug#24661)
- When using a `DBNull.Value` as the value for a parameter value, and then later setting a specific value type, the command would fail with an exception because the wrong type was implied from the `DBNull.Value`. (Bug#24565)
- Stored procedure executions are not thread safe. (Bug#23905)
- The `CommandBuilder` would mistakenly add insert parameters for a table column with auto incrementation enabled. (Bug#23862)

- One system where IPv6 was enabled, Connector/NET would incorrectly resolve host names. ([Bug#23758](#))
- Nested transactions do not raise an error or warning. ([Bug#22400](#))
- An `System.OverflowException` would be raised when accessing a varchar field over 255 bytes. Bug (#23749)
- Within Mono, using the `PreparedStatement` interface could result in an error due to a `BitArray` copying error. (Bug 18186)

### C.5.38. Changes in MySQL Connector/NET 1.0.8 (20 October 2006)

Functionality added or changed:

- Stored procedures are now cached.
- The method for retrieving stored procedured metadata has been changed so that users without `SELECT` privileges on the `mysql.proc` table can use a stored procedure.

Bugs fixed:

- Connector/NET on a Turkish operating system, may fail to execute certain SQL statements correctly. ([Bug#22452](#))
- The `#` would not be accepted within column/table names, even though it was valid. ([Bug#21521](#))
- Calling `Close` on a connection after calling a stored procedure would trigger a `NullReferenceException`. ([Bug#20581](#))
- You can now install the Connector/NET MSI package from the command line using the `/passive`, `/quiet`, `/q` options. ([Bug#19994](#))
- The `DiscoverParameters` function would fail when a stored procedure used a `NUMERIC` parameter type. ([Bug#19515](#))
- When running a query that included a date comparison, a `DateReader` error would be raised. ([Bug#19481](#))
- `IDataRecord.GetString` would raise `NullPointerException` for null values in returned rows. Method now throws `SqlNullValueException`. ([Bug#19294](#))
- Parameter substitution in queries where the order of parameters and table fields did not match would substitute incorrect values. ([Bug#19261](#))
- Submitting an empty string to a command object through `prepare` raises an `System.IndexOutOfRangeException`, rather than a Connector/Net exception. ([Bug#18391](#))
- An exception would be raised when using an output parameter to a `System.String` value. ([Bug#17814](#))
- CHAR type added to `MySqlDbType`. ([Bug#17749](#))
- A `SELECT` query on a table with a date with a value of `'0000-00-00'` would hang the application. ([Bug#17736](#))
- The `CommandBuilder` ignored `Unsigned` flag at Parameter creation. ([Bug#17375](#))
- When working with multiple threads, character set initialization would generate errors. ([Bug#17106](#))
- When using an unsigned 64-bit integer in a stored procedure, the unsigned bit would be lost stored. ([Bug#16934](#))
- `DataReader` would show the value of the previous row (or last row with non-null data) if the current row contained a `datetime` field with a null value. ([Bug#16884](#))
- Unsigned data types were not properly supported. ([Bug#16788](#))
- The connection string parser did not allow single or double quotes in the password. ([Bug#16659](#))
- The `MySqlDateTime` class did not contain constructors. ([Bug#15112](#))
- Called `MySqlCommandBuilder.DeriveParameters` for a stored procedure that has no paramers would cause an application crash. ([Bug#15077](#))
- Using `ExecuteScalar` with a datetime field, where the value of the field is `"0000-00-00 00:00:00"`, a `MySqlConver-`

`IOException` exception would be raised. (Bug#11991)

- An `MySql.Data.Types.MySqlConversionException` would be raised when trying to update a row that contained a date field, where the date field contained a zero value (0000-00-00 00:00:00). (Bug#9619)
- When using `MySqlDataAdapter`, connections to a MySQL server may remain open and active, even though the use of the connection has been completed and the data received. (Bug#8131)
- Executing multiple queries as part of a transaction returns `There is already an openDataReader associated with this Connection which must be closed first.` (Bug#7248)
- Incorrect field/data lengths could be returned for `VARCHAR` UTF8 columns. Bug (#14592)

### C.5.39. Changes in MySQL Connector/NET 1.0.7 (21 November 2005)

Bugs fixed:

- Unsigned `tinyint` (NET byte) would lead to and incorrectly determined parameter type from the parameter value. (Bug#18570)
- A `#42000Query was empty` exception occurred when executing a query built with `MySqlCommandBuilder`, if the query string ended with a semicolon. (Bug#14631)
- The parameter collection object's `Add()` method added parameters to the list without first checking to see whether they already existed. Now it updates the value of the existing parameter object if it exists. (Bug#13927)
- Added support for the `cp932` character set. (Bug#13806)
- Calling a stored procedure where a parameter contained special characters (such as '@') would produce an exception. Note that `ANSI_QUOTES` had to be enabled to make this possible. (Bug#13753)
- The `Ping()` method did not update the `State` property of the `Connection` object. (Bug#13658)
- Implemented the `MySqlCommandBuilder.DeriveParameters` method that is used to discover the parameters for a stored procedure. (Bug#13632)
- A statement that contained multiple references to the same parameter could not be prepared. (Bug#13541)

### C.5.40. Changes in MySQL Connector/NET 1.0.6 (03 October 2005)

Bugs fixed:

- Connector/NET 1.0.5 could not connect on Mono. (Bug#13345)
- Serializing a parameter failed if the first value passed in was `NULL`. (Bug#13276)
- Field names that contained the following characters caused errors: `()%<>/` (Bug#13036)
- The `nant` build sequence had problems. (Bug#12978)
- The Connector/NET 1.0.5 installer would not install alongside Connector/NET 1.0.4. (Bug#12835)

### C.5.41. Changes in MySQL Connector/NET 1.0.5 (29 August 2005)

Bugs fixed:

- Connector/NET could not connect to MySQL 4.1.14. (Bug#12771)
- With multiple hosts in the connection string, Connector/NET would not connect to the last host in the list. (Bug#12628)
- The `ConnectionString` property could not be set when a `MySqlConnection` object was added with the designer. (Bug#12551, Bug#8724)
- The `cp1250` character set was not supported. (Bug#11621)

- A call to a stored procedure caused an exception if the stored procedure had no parameters. (Bug#11542)
- Certain malformed queries would trigger a `Connection must be valid and open` error message. (Bug#11490)
- Trying to use a stored procedure when `Connection.Database` was not populated generated an exception. (Bug#11450)
- Connector/NET interpreted the new decimal data type as a byte array. (Bug#11294)
- Added support to call a stored function from Connector/NET. (Bug#10644)
- Connection could fail when .NET thread pool had no available worker threads. (Bug#10637)
- Calling `MySqlConnection.clone` when a connection string had not yet been set on the original connection would generate an error. (Bug#10281)
- Decimal parameters caused syntax errors. (Bug#10152, Bug#11550, Bug#10486)
- Parameters were not recognized when they were separated by linefeeds. (Bug#9722)
- The `MySqlCommandBuilder` class could not handle queries that referenced tables in a database other than the default database. (Bug#8382)
- Trying to read a `TIMESTAMP` column generated an exception. (Bug#7951)
- Connector/NET could not work properly with certain regional settings. (WL#8228)

## C.5.42. Changes in MySQL Connector/NET 1.0.4 (20 January 2005)

Bugs fixed:

- `MySqlReader.GetInt32` throws exception if column is unsigned. (Bug#7755)
- Quote character `\222` not quoted in `EscapeString`. (Bug#7724)
- `GetBytes` is working no more. (Bug#7704)
- `MySqlDataReader.GetString(index)` returns non-Null value when field is `Null`. (Bug#7612)
- Clone method bug in `MySqlCommand`. (Bug#7478)
- Problem with Multiple resultsets. (Bug#7436)
- `MySqlAdapter.Fill` method throws error message `Non-negative number required`. (Bug#7345)
- `MySqlCommand.Connection` returns an `IDbConnection`. (Bug#7258)
- Calling `prepare` causing exception. (Bug#7243)
- Fixed problem with shared memory connections.
- Added or filled out several more topics in the API reference documentation.
- Fixed another small problem with prepared statements.
- Fixed problem that causes named pipes to not work with some blob functionality.

## C.5.43. Changes in MySQL Connector/NET 1.0.3 (12 October 2004 gamma)

Bugs fixed:

- Invalid query string when using inout parameters (Bug#7133)
- Inserting `DateTime` causes `System.InvalidCastException` to be thrown. (Bug#7132)
- `MySqlDateTime` in Datatables sorting by Text, not Date. (Bug#7032)
- Exception stack trace lost when re-throwing exceptions. (Bug#6983)

- Errors in parsing stored procedure parameters. ([Bug#6902](#))
- InvalidCast when using `DATE_ADD`-function. ([Bug#6879](#))
- Int64 Support in `MySqlCommand` Parameters. ([Bug#6863](#))
- Test suite fails with MySQL 4.0 because of case sensitivity of table names. ([Bug#6831](#))
- `MySqlDataReader.GetChar(int i)` throws `IndexOutOfRangeException` exception. ([Bug#6770](#))
- Integer "out" parameter from stored procedure returned as string. ([Bug#6668](#))
- An Open Connection has been Closed by the Host System. ([Bug#6634](#))
- Fixed Invalid character set index: 200. ([Bug#6547](#))
- Connections now do not have to give a database on the connection string.
- Installer now includes options to install into GAC and create `START MENU` items.
- Fixed major problem with detecting null values when using prepared statements.
- Fixed problem where multiple resultsets having different numbers of columns would cause a problem.
- Added `ServerThread` property to `MySqlConnection` to expose server thread id.
- Added Ping method to `MySqlConnection`.
- Changed the name of the test suite to `MySql.Data.Tests.dll`.
- Now `SHOW COLLATION` is used upon connection to retrieve the full list of charset ids.
- Made MySQL the default named pipe name.

#### C.5.44. Changes in MySQL Connector/NET 1.0.2 (15 November 2004 gamma)

Bugs fixed:

- Fixed Objects not being disposed ([Bug#6649](#))
- Fixed Charset-map for UCS-2 ([Bug#6541](#))
- Fixed Zero date "0000-00-00" is returned wrong when filling Dataset ([Bug#6429](#))
- Fixed double type handling in `MySqlParameter(string parameterName, object value)` ([Bug#6428](#))
- Fixed Installation directory ignored using custom installation ([Bug#6329](#))
- Fixed #HY000 Illegal mix of collations (latin1\_swedish\_ci,IMPLICIT) and (utf8\_general\_ ([Bug#6322](#))
- Added the TableEditor CS and VB sample
- Added charset connection string option
- Fixed problem with `MySqlBinary` where string values could not be used to update extended text columns
- Provider is now using character set specified by server as default
- Updated the installer to include the new samples
- Fixed problem where setting command text leaves the command in a prepared state
- Fixed Long inserts take very long time (Bu #5453)
- Fixed problem where calling stored procedures might cause an "Illegal mix of collations" problem.

#### C.5.45. Changes in MySQL Connector/NET 1.0.1 (27 October 2004 beta)

Bugs fixed:

- Fixed IndexOutOfBounds when reading BLOB with DataReader with GetString(index) ([Bug#6230](#))
- Fixed GetBoolean returns wrong values ([Bug#6227](#))
- Fixed Method TokenizeSql() uses only a limited set of valid characters for parameters ([Bug#6217](#))
- Fixed NET Connector source missing resx files ([Bug#6216](#))
- Fixed System.OverflowException when using YEAR datatype ([Bug#6036](#))
- Fixed MySqlDateTime sets IsZero property on all subseq.records after first zero found ([Bug#6006](#))
- Fixed serializing of floating point parameters (double, numeric, single, decimal) ([Bug#5900](#))
- Fixed missing Reference in DbType setter ([Bug#5897](#))
- Fixed Parsing the ';' char ([Bug#5876](#))
- Fixed DBNull Values causing problems with retrieving/updating queries. ([Bug#5798](#))
- IsNullable error ([Bug#5796](#))
- Fixed problem where MySqlParameterCollection.Add() would throw unclear exception when given a null value ([Bug#5621](#))
- Fixed construtor initialize problems in MySqlCommand() ([Bug#5613](#))
- Fixed Yet Another "object reference not set to an instance of an object" ([Bug#5496](#))
- Fixed Can't display Chinese correctly ([Bug#5288](#))
- Fixed MySqlDataReader and 'show tables from ...' behavior ([Bug#5256](#))
- Fixed problem in PacketReader where it could try to allocate the wrong buffer size in EnsureCapacity
- Fixed problem where using old syntax while using the interfaces caused problems
- Fixed [Bug#5458](#) Calling GetChars on a longtext column throws an exception
- Added test case for resetting the command text on a prepared command
- Fixed [Bug#5388](#) DataReader reports all rows as NULL if one row is NULL
- Fixed problem where connection lifetime on the connect string was not being respected
- Fixed [Bug#5602](#) Possible bug in MySqlParameter(string, object) constructor
- Field buffers being reused to decrease memory allocations and increase speed
- Fixed [Bug#5392](#) MySqlCommand sees "?" as parameters in string literals
- Added Aggregate function test (wasn't really a bug)
- Using PacketWriter instead of Packet for writing to streams
- Implemented SequentialAccess
- Fixed problem with ConnectionInternal where a key might be added more than once
- Fixed Russian character support as well
- Fixed [Bug#5474](#) cannot run a stored procedure populating mysqlcommand.parameters
- Fixed problem where connector was not issuing a CMD\_QUIT before closing the socket
- Fixed problem where Min Pool Size was not being respected
- Refactored compression code into CompressedStream to clean up NativeDriver
- CP1252 is now used for Latin1 only when the server is 4.1.2 and later

- Fixed [Bug#5469](#) Setting DbType throws NullReferenceException
- Virtualized driver subsystem so future releases could easily support client or embedded server support

## C.5.46. Changes in MySQL Connector/NET 1.0.0 (01 September 2004)

Bugs fixed:

- Thai encoding not correctly supported. ([Bug#3889](#))
- Bumped version number to 1.0.0 for beta 1 release.
- Removed all of the XML comment warnings.
- Added [COPYING.rtf](#) file for use in installer.
- Updated many of the test cases.
- Fixed problem with using compression.
- Removed some last references to ByteFX.

## C.5.47. Changes in MySQL Connector/NET Version 0.9.0 (30 August 2004)

- Added test fixture for prepared statements.
- All type classes now implement a [SerializeBinary](#) method for sending their data to a [PacketWriter](#).
- Added [PacketWriter](#) class that will enable future low-memory large object handling.
- Fixed many small bugs in running prepared statements and stored procedures.
- Changed command so that an exception will not be thrown in executing a stored procedure with parameters in old syntax mode.
- [SingleRow](#) behavior now working right even with limit.
- [GetBytes](#) now only works on binary columns.
- Logger now truncates long sql commands so blob columns do not blow out our log.
- host and database now have a default value of "" unless otherwise set.
- Connection Timeout seems to be ignored. ([Bug#5214](#))
- Added test case for bug# 5051: GetSchema not working correctly.
- Fixed problem where [GetSchema](#) would return false for [IsUnique](#) when the column is key.
- [MySqlDataReader](#) [GetXXX](#) methods now using the field level [MySqlValue](#) object and not performing conversions.
- [DataReader](#) returning NULL for time column. ([Bug#5097](#))
- Added test case for [LOAD DATA LOCAL INFILE](#).
- Added replacetext custom nant task.
- Added [CommandBuilderTest](#) fixture.
- Added Last One Wins feature to [CommandBuilder](#).
- Fixed persist security info case problem.
- Fixed [GetBool](#) so that 1, true, "true", and "yes" all count as true.
- Make parameter mark configurable.
- Added the "old syntax" connection string parameter to allow use of @ parameter marker.



- [MySqlCommandBuilder](#). ([Bug#4658](#))
- [ByteFX.MySqlClient](#) caches passwords if `Persist Security Info` is false. ([Bug#4864](#))
- Updated license banner in all source files to include FLOSS exception.
- Added new `.Types` namespace and implementations for most current MySQL types.
- Added [MySqlField41](#) as a subclass of [MySqlField](#).
- Changed many classes to now use the new `.Types` types.
- Changed type `enum int` to `Int32`, `short` to `Int16`, and `bigint` to `Int64`.
- Added dummy types `UInt16`, `UInt32`, and `UInt64` to allow an unsigned parameter to be made.
- Connections are now reset when they are pulled from the connection pool.
- Refactored auth code in driver so it can be used for both auth and reset.
- Added `UserReset` test in `PoolingTests.cs`.
- Connections are now reset using `COM_CHANGE_USER` when pulled from the pool.
- Implemented `SingleResultSet` behavior.
- Implemented support of unicode.
- Added char set mappings for utf-8 and ucs-2.
- Time fields overflow using `bytefx .net mysql driver` ([Bug#4520](#))
- Modified time test in data type test fixture to check for time spans where hours > 24.
- Wrong string with backslash escaping in `ByteFx.Data.MySqlClient.MySqlParameter`. ([Bug#4505](#))
- Added code to Parameter test case `TestQuoting` to test for backslashes.
- [MySqlCommandBuilder](#) fails with multi-word column names. ([Bug#4486](#))
- Fixed bug in `TokenizeSql` where underscore would terminate character capture in parameter name.
- Added test case for spaces in column names.
- [MySqlDataReader.GetBytes](#) do not work correctly. ([Bug#4324](#))
- Added `GetBytes()` test case to `DataReader` test fixture.
- Now reading all server variables in `InternalConnection.Configure` into `Hashtable`.
- Now using `string[]` for index map in `CharSetMap`.
- Added `CRInSQL` test case for carriage returns in SQL.
- Setting `maxPacketSize` to default value in `Driver.ctor`.
- Setting `MySqlDbType` on a parameter doesn't set generic type. ([Bug#4442](#))
- Removed obsolete data types `Long` and `LongLong`.
- Overflow exception thrown when using "use pipe" on connection string. ([Bug#4071](#))
- Changed "use pipe" keyword to "pipe name" or just "pipe".
- Allow reading multiple resultsets from a single query.
- Added flags attribute to `ServerStatusFlags` enum.
- Changed name of `ServerStatus` enum to `ServerStatusFlags`.
- Inserted data row doesn't update properly.

- Error processing show create table. ([Bug#4074](#))
- Change `Packet.ReadLenInteger` to `ReadPackedLong` and added `packet.ReadPackedInteger` that always reads integers packed with 2,3,4.
- Added `syntax.cs` test fixture to test various SQL syntax bugs.
- Improper handling of time values. Now time value of 00:00:00 is not treated as null. ([Bug#4149](#))
- Moved all test suite files into `TestSuite` folder.
- Fixed bug where null column would move the result packet pointer backward.
- Added new nant build script.
- Clear tablename so it will be regen'ed properly during the next `GenerateSchema`. ([Bug#3917](#))
- `GetValues` was always returning zero and was also always trying to copy all fields rather than respecting the size of the array passed in. ([Bug#3915](#))
- Implemented shared memory access protocol.
- Implemented prepared statements for MySQL 4.1.
- Implemented stored procedures for MySQL 5.0.
- Renamed `MySqlInternalConnection` to `InternalConnection`.
- SQL is now parsed as chars, fixes problems with other languages.
- Added logging and allow batch connection string options.
- `RowUpdating` event not set when setting the `DataAdapter` property. ([Bug#3888](#))
- Fixed bug in char set mapping.
- Implemented 4.1 authentication.
- Improved open/auth code in driver.
- Improved how connection bits are set during connection.
- Database name is now passed to server during initial handshake.
- Changed namespace for client to `MySql.Data.MySqlClient`.
- Changed assembly name of client to `MySql.Data.dll`.
- Changed license text in all source files to GPL.
- Added the `MySqlClient.build` Nant file.
- Removed the mono batch files.
- Moved some of the unused files into `notused` folder so nant build file can use wildcards.
- Implemented shared memory access.
- Major revamp in code structure.
- Prepared statements now working for MySql 4.1.1 and later.
- Finished implementing auth for 4.0, 4.1.0, and 4.1.1.
- Changed namespace from `MySQL.Data.MySQLClient` back to `MySql.Data.MySqlClient`.
- Fixed bug in `CharSetMapping` where it was trying to use text names as ints.
- Changed namespace to `MySQL.Data.MySQLClient`.
- Integrated auth changes from UC2004.

- Fixed bug where calling any of the GetXXX methods on a datareader before or after reading data would not throw the appropriate exception (thanks Luca Morelli).
- Added `TimeSpan` code in `parameter.cs` to properly serialize a timespan object to mysql time format (thanks Gianluca Colombo).
- Added `TimeStamp` to parameter serialization code. Prevented `DataAdapter` updates from working right (thanks Michael King).
- Fixed a misspelling in `MySQLHelper.cs` (thanks Patrick Kristiansen).

## C.5.48. Changes in MySQL Connector/NET Version 0.76

- Driver now using charset number given in handshake to create encoding.
- Changed command editor to point to `MySQLClient.Design`.
- Fixed bug in `Version.isAtLeast`.
- Changed `DBConnectionString` to support changes done to `MySQLConnectionString`.
- Removed `SqlCommandEditor` and `DataAdapterPreviewDialog`.
- Using new long return values in many places.
- Integrated new `CompressedStream` class.
- Changed `ConnectionString` and added attributes to allow it to be used in `MySQLClient.Design`.
- Changed `packet.cs` to support newer lengths in `ReadLenInteger`.
- Changed other classes to use new properties and fields of `MySQLConnectionString`.
- `ConnectionInternal` is now using PING to see whether the server is alive.
- Moved toolbox bitmaps into resource folder.
- Changed `field.cs` to allow values to come directly from row buffer.
- Changed to use the new `driver.Send` syntax.
- Using a new packet queueing system.
- Started work handling the "broken" compression packet handling.
- Fixed bug in `StreamCreator` where failure to connect to a host would continue to loop infinitely (thanks Kevin Casella).
- Improved connectstring handling.
- Moved designers into Pro product.
- Removed some old commented out code from `command.cs`.
- Fixed a problem with compression.
- Fixed connection object where an exception throw prior to the connection opening would not leave the connection in the connecting state (thanks Chris Cline).
- Added GUID support.
- Fixed sequence out of order bug (thanks Mark Reay).

## C.5.49. Changes in MySQL Connector/NET Version 0.75

- Enum values now supported as parameter values (thanks Philipp Sumi).
- Year datatype now supported.

- Fixed compression.
- Fixed bug where a parameter with a `TimeSpan` as the value would not serialize properly.
- Fixed bug where default constructor would not set default connection string values.
- Added some XML comments to some members.
- Work to fix/improve compression handling.
- Improved `ConnectionString` handling so that it better matches the standard set by `SqlClient`.
- A `MySqlException` is now thrown if a user name is not included in the connection string.
- Localhost is now used as the default if not specified on the connection string.
- An exception is now thrown if an attempt is made to set the connection string while the connection is open.
- Small changes to `ConnectionString` docs.
- Removed `MultiHostStream` and `MySqlStream`. Replaced it with `Common/StreamCreator`.
- Added support for Use Pipe connection string value.
- Added Platform class for easier access to platform utility functions.
- Fixed small pooling bug where new connection was not getting created after `IsAlive` fails.
- Added `Platform.cs` and `StreamCreator.cs`.
- Fixed `Field.cs` to properly handle 4.1 style timestamps.
- Changed `Common.Version` to `Common.DBVersion` to avoid name conflict.
- Fixed `field.cs` so that text columns return the right field type.
- Added `MySqlError` class to provide some reference for error codes (thanks Geert Veenstra).

### C.5.50. Changes in MySQL Connector/NET Version 0.74

- Added Unix socket support (thanks Mohammad DAMT).
- Only calling `Thread.Sleep` when no data is available.
- Improved escaping of quote characters in parameter data.
- Removed misleading comments from `parameter.cs`.
- Fixed pooling bug.
- Fixed `ConnectionString` editor dialog (thanks marco p (pomarc)).
- `UserId` now supported in connection strings (thanks Jeff Neeley).
- Attempting to create a parameter that is not input throws an exception (thanks Ryan Gregg).
- Added much documentation.
- Checked in new `MultiHostStream` capability. Big thanks to Dan Guisinger for this, he originally submitted the code and idea of supporting multiple machines on the connect string.
- Added a lot of documentation.
- Fixed speed issue with 0.73.
- Changed to `Thread.Sleep(0)` in `MySqlDataStream` to help optimize the case where it doesn't need to wait (thanks Todd German).
- Prepopulating the idlepools to `MinPoolSize`.

- Fixed `MySqlPool` deadlock condition as well as stupid bug where `CreateNewPooledConnection` was not ever adding new connections to the pool. Also fixed `MySqlStream.ReadBytes` and `ReadByte` to not use `TicksPerSecond` which does not appear to always be right. (thanks Matthew J. Peddlesden)
- Fix for precision and scale (thanks Matthew J. Peddlesden).
- Added `Thread.Sleep(1)` to stream reading methods to be more cpu friendly (thanks Sean McGinnis).
- Fixed problem where `ExecuteReader` would sometime return null (thanks Lloyd Dupont).
- Fixed major bug with null field handling (thanks Naucki).
- Enclosed queries for `max_allowed_packet` and `characterset` inside try catch (and set defaults).
- Fixed problem where socket was not getting closed properly (thanks Steve!).
- Fixed problem where `ExecuteNonQuery` was not always returning the right value.
- Fixed `InternalConnection` to not use `@@session.max_allowed_packet` but use `@@max_allowed_packet`. (Thanks Miguel)
- Added many new XML doc lines.
- Fixed sql parsing to not send empty queries (thanks Rory).
- Fixed problem where the reader was not unpeeking the packet on close.
- Fixed problem where user variables were not being handled (thanks Sami Vaaraniemi).
- Fixed loop checking in the `MySqlPool` (thanks Steve M. Brown)
- Fixed `ParameterCollection.Add` method to match `SqlClient` (thanks Joshua Mouch).
- Fixed `ConnectionString` parsing to handle no and yes for boolean and not lowercase values (thanks Naucki).
- Added `InternalConnection` class, changes to pooling.
- Implemented Persist Security Info.
- Added `security.cs` and `version.cs` to project
- Fixed `DateTime` handling in `Parameter.cs` (thanks Burkhard Perens-Golomb).
- Fixed parameter serialization where some types would throw a cast exception.
- Fixed `DataReader` to convert all returned values to prevent casting errors (thanks Keith Murray).
- Added code to `Command.ExecuteReader` to return null if the initial SQL statement throws an exception (thanks Burkhard Perens-Golomb).
- Fixed `ExecuteScalar` bug introduced with restructure.
- Restructure to allow for `LOCAL DATA INFILE` and better sequencing of packets.
- Fixed several bugs related to restructure.
- Early work done to support more secure passwords in Mysql 4.1. Old passwords in 4.1 not supported yet.
- Parameters appearing after system parameters are now handled correctly (Adam M. (adamml)).
- Strings can now be assigned directly to blob fields (Adam M.).
- Fixed float parameters (thanks Pent).
- Improved Parameter constructor and `ParameterCollection.Add` methods to better match `SqlClient` (thanks Joshua Mouch).
- Corrected `Connection.CreateCommand` to return a `MySqlCommand` type.
- Fixed connection string designer dialog box problem (thanks Abraham Guyt).
- Fixed problem with sending commands not always reading the response packet (thanks Joshua Mouch).

- Fixed parameter serialization where some blobs types were not being handled (thanks Sean McGinnis).
- Removed spurious `MessageBox.show` from `DataReader` code (thanks Joshua Mouch).
- Fixed a nasty bug in the split sql code (thanks everyone!).

### C.5.51. Changes in MySQL Connector/NET Version 0.71

- Fixed bug in `MySqlStream` where too much data could attempt to be read (thanks Peter Belbin)
- Implemented `HasRows` (thanks Nash Pherson).
- Fixed bug where tables with more than 252 columns cause an exception (thanks Joshua Kessler).
- Fixed bug where SQL statements ending in `;` would cause a problem (thanks Shane Krueger).
- Fixed bug in driver where error messages were getting truncated by 1 character (thanks Shane Krueger).
- Made `MySqlException` serializable (thanks Mathias Hasselmann).

### C.5.52. Changes in MySQL Connector/NET Version 0.70

- Updated some of the character code pages to be more accurate.
- Fixed problem where readers could be opened on connections that had readers open.
- Moved test to separate assembly `MySqlClientTests`.
- Fixed stupid problem in driver with sequence out of order (Thanks Peter Belbin).
- Added some pipe tests.
- Increased default max pool size to 50.
- Compiles with Mono 0-24.
- Fixed connection and data reader dispose problems.
- Added `String` datatype handling to parameter serialization.
- Fixed sequence problem in driver that occurred after thrown exception (thanks Burkhard Perens-Golomb).
- Added support for `CommandBehavior.SingleRow` to `DataReader`.
- Fixed command sql processing so quotes are better handled (thanks Theo Spears).
- Fixed parsing of double, single, and decimal values to account for non-English separators. You still have to use the right syntax if you using hard coded sql, but if you use parameters the code will convert floating point types to use `'` appropriately internal both into the server and out.
- Added `MySqlStream` class to simplify timeouts and driver coding.
- Fixed `DataReader` so that it is closed properly when the associated connection is closed. [thanks smishra]
- Made client more `SqlClient` compliant so that `DataReaders` have to be closed before the connection can be used to run another command.
- Improved `DBNull.Value` handling in the fields.
- Added several unit tests.
- Fixed `MySqlException` base class.
- Improved driver coding
- Fixed bug where `NextResult` was returning false on the last resultset.

- Added more tests for MySQL.
- Improved casting problems by equating unsigned 32bit values to Int64 and unsigned 16bit values to Int32, and so forth.
- Added new constructor for `MySQLParameter` for (name, type, size, srccol)
- Fixed bug in `MySQLDataReader` where it didn't check for null fieldlist before returning field count.
- Started adding `MySQLClient` unit tests (added `MySQLClient/Tests` folder and some test cases).
- Fixed some things in Connection String handling.
- Moved `INIT_DB` to `MySQLPool`. I may move it again, this is in preparation of the conference.
- Fixed bug inside `CommandBuilder` that prevented inserts from happening properly.
- Reworked some of the internals so that all three execute methods of `Command` worked properly.
- Fixed many small bugs found during benchmarking.
- The first cut of `CoonnectionPooling` is working. "min pool size" and "max pool size" are respected.
- Work to enable multiple resultsets to be returned.
- Character sets are handled much more intelligently now. The driver queries MySQL at startup for the default character set. That character set is then used for conversions if that code page can be loaded. If not, then the default code page for the current OS is used.
- Added code to save the inferred type in the name,value constructor of `Parameter`.
- Also, inferred type if value of null parameter is changed using `Value` property.
- Converted all files to use proper Camel case. MySQL is now `MySql` in all files. `PgSQL` is now `PgSql`.
- Added attribute to `PgSql` code to prevent designer from trying to show.
- Added `MySQLDbType` property to `Parameter` object and added proper conversion code to convert from `DbType` to `MySQLDbType`).
- Removed unused `ObjectToString` method from `MySQLParameter.cs`.
- Fixed `Add(..)` method in `ParameterCollection` so that it doesn't use `Add(name, value)` instead.
- Fixed `IndexOf` and `Contains` in `ParameterCollection` to be aware that parameter names are now stored without `@`.
- Fixed `Command.ConvertSQLToBytes` so it only allows characters that can be in MySQL variable names.
- Fixed `DataReader` and `Field` so that blob fields read their data from `Field.cs` and `GetBytes` works right.
- Added simple query builder editor to `CommandText` property of `MySQLCommand`.
- Fixed `CommandBuilder` and `Parameter` serialization to account for Parameters not storing `@` in their names.
- Removed `MySQLFieldType` enum from `Field.cs`. Now using `MySQLDbType` enum.
- Added `Designer` attribute to several classes to prevent designer view when using VS.Net.
- Fixed Initial catalog typo in `ConnectionString` designer.
- Removed 3 parameter constructor for `MySQLParameter` that conflicted with (name, type, value).
- Changed `MySQLParameter` so `paramName` is now stored without leading `@` (this fixed null inserts when using designer).
- Changed `TypeConverter` for `MySQLParameter` to use the constructor with all properties.

### C.5.53. Changes in MySQL Connector/NET Version 0.68

- Fixed sequence issue in driver.
- Added `DbParametersEditor` to make parameter editing more like `SqlClient`.

- Fixed `Command` class so that parameters can be edited using the designer
- Update connection string designer to support `Use Compression` flag.
- Fixed string encoding so that European characters will work correctly.
- Creating base classes to aid in building new data providers.
- Added support for UID key in connection string.
- Field, parameter, command now using `DBNull.Value` instead of null.
- `CommandBuilder` using `DBNull.Value`.
- `CommandBuilder` now builds insert command correctly when an `auto_insert` field is not present.
- Field now uses `typeof` keyword to return `System.Types` (performance).

### C.5.54. Changes in MySQL Connector/NET Version 0.65

- `MySQLCommandBuilder` now implemented.
- Transaction support now implemented (not all table types support this).
- `GetSchemaTable` fixed to not use `xsd` (for Mono).
- Driver is now Mono-compatible.
- TIME data type now supported.
- More work to improve Timestamp data type handling.
- Changed signatures of all classes to match corresponding `SqlClient` classes.

### C.5.55. Changes in MySQL Connector/NET Version 0.60

- Protocol compression using `SharpZipLib` ([www.icsharpcode.net](http://www.icsharpcode.net)).
- Named pipes on Windows now working properly.
- Work done to improve `Timestamp` data type handling.
- Implemented `IEnumerable` on `DataReader` so `DataGrid` would work.

### C.5.56. Changes in MySQL Connector/NET Version 0.50

- Speed increased dramatically by removing bugging network sync code.
- Driver no longer buffers rows of data (more ADO.Net compliant).
- Conversion bugs related to `TIMESTAMP` and `DATETIME` fields fixed.

## C.6. MySQL Visual Studio Plugin Change History

### Note

As of Connector/NET 5.1.2 (14 June 2007), the Visual Studio Plugin is part of the main Connector/NET package. For the change history for the Visual Studio Plugin, see [Section C.5, "MySQL Connector/NET Change History"](#).

### C.6.1. Changes in MySQL Visual Studio Plugin 1.0.3 (Not yet released)

Bugs fixed:



- Running queries based on a stored procedure would cause the data set designer to terminate. (Bugs #26364)
- DataSet wizard would show all tables instead of only the tables available within the selected database. (Bugs #26348)

## C.6.2. Changes in MySQL Visual Studio Plugin 1.0.2 (Not yet released)

Bugs fixed:

- The Add Connection dialog of the Server Explorer would freeze when accessing databases with capitalized characters in their name. (Bug#24875)
- Creating a connection through the Server Explorer when using the Visual Studio Plugin would fail. The installer for the Visual Studio Plugin has been updated to ensure that Connector/NET 5.0.2 must be installed. (Bug#23071)

## C.6.3. Changes in MySQL Visual Studio Plugin 1.0.1 (4 October 2006)

This is a bug fix release to resolve an incompatibility issue with Connector/NET 5.0.1.

It is critical that this release only be used with Connector/NET 5.0.1. After installing Connector/NET 5.0.1, you will need to make a small change in your machine.config file. This file should be located at `%win%\Microsoft.Net\Framework\v2.0.50727\CONFIG\machine.config` (`%win%` should be the location of your Windows folder). Near the bottom of the file you will see a line like this:

```
<add name="MySQL Data Provider" invariant="MySql.Data.MySqlClient"
description=".Net Framework Data Provider for MySQL"
type="MySql.Data.MySqlClient.MySqlClientFactory, MySql.Data" />
```

It needs to be changed to be like this:

```
<add name="MySQL Data Provider" invariant="MySql.Data.MySqlClient"
description=".Net Framework Data Provider for MySQL"
type="MySql.Data.MySqlClient.MySqlClientFactory, MySql.Data,
Version=5.0.1.0, Culture=neutral, PublicKeyToken=c5687fc88969c44d" />
```

## C.6.4. Changes in MySQL Visual Studio Plugin 1.0.0 (4 October 2006)

Bugs fixed:

- Ability to work with MySQL objects (tables, views, stored procedures, etc) from within Server Explorer.
- DDEX (Data Designer Extensibility) compatibility.

## C.7. MySQL Connector/J Change History

### C.7.1. Changes in MySQL Connector/J 5.1.x

#### C.7.1.1. Changes in MySQL Connector/J 5.1.8 (Not yet released)

Bugs fixed:

- The result set returned by `getIndexInfo()` did not have the format defined in the JDBC API specifications. The fourth column, `DATA_TYPE`, of the result set should be of type `BOOLEAN`. Connector/J however returns `CHAR`. (Bug#44869)
- The result set returned by `getTypeInfo()` did not have the format defined in the JDBC API specifications. The second column, `DATA_TYPE`, of the result set should be of type `INTEGER`. Connector/J however returns `SMALLINT`. (Bug#44868)
- The `DEFERRABILITY` column in database metadata result sets was expected to be of type `SHORT`. However, Connector/J returned it as `INTEGER`.

This affected the following methods: `getImportedKeys()`, `getExportedKeys()`, `getCrossReference()`. (Bug#44867)

- The result set returned by `getColumns()` did not have the format defined in the JDBC API specifications. The fifth column, `DATA_TYPE`, of the result set should be of type `INTEGER`. Connector/J however returns `SMALLINT`. (Bug#44865)
- The result set returned by `getVersionColumns()` did not have the format defined in the JDBC API specifications. The third column, `DATA_TYPE`, of the result set should be of type `INTEGER`. Connector/J however returns `SMALLINT`. (Bug#44863)
- The result set returned by `getBestRowIdentifier()` did not have the format defined in the JDBC API specifications. The third column, `DATA_TYPE`, of the result set should be of type `INTEGER`. Connector/J however returns `SMALLINT`. (Bug#44862)
- Connector/J contains logic to generate a message text specifically for streaming result sets when there are `CommunicationsException` exceptions generated. However, this code was never reached.

In the `CommunicationsException` code:

```
private boolean streamingResultSetInPlay = false;

public CommunicationsException(ConnectionImpl conn, long lastPacketSentTimeMs,
long lastPacketReceivedTimeMs, Exception underlyingException) {

this.exceptionMessage = SQLError.createLinkFailureMessageBasedOnHeuristics(conn,
lastPacketSentTimeMs, lastPacketReceivedTimeMs, underlyingException,
this.streamingResultSetInPlay);
```

`streamingResultSetInPlay` was always false, which in the following code in `SQLError.createLinkFailureMessageBasedOnHeuristics()` never being executed:

```
if (streamingResultSetInPlay) {
    exceptionMessageBuf.append(
        Messages.getString("CommunicationsException.ClientWasStreaming")); //$NON-NLS-1$
} else {
    ...
```

(Bug#44588)

- `Statement.getGeneratedKeys()` retained result set instances until the statement was closed. This caused memory leaks for long-lived statements, or statements used in tight loops. (Bug#44056)
- `LoadBalancingConnectionProxy.doPing()` did not have blacklist awareness.

`LoadBalancingConnectionProxy` implemented `doPing()` to ping all underlying connections, but it threw any exceptions it encountered during this process.

With the global blacklist enabled, it catches these exceptions, adds the host to the global blacklist, and only throws an exception if all hosts are down. (Bug#43421)

- When the MySQL Server was upgraded from 4.0 to 5.0, the Connector/J application then failed to connect to the server. This was because authentication failed when the application ran from EBCDIC platforms such as z/OS. (Bug#43071)
- When connecting with `traceProtocol=true`, no trace data was generated for the server greeting or login request. (Bug#43070)
- A `ConcurrentModificationException` was generated in `LoadBalancingConnectionProxy`:

```
java.util.ConcurrentModificationException
at java.util.HashMap$HashIterator.nextEntry(Unknown Source)
at java.util.HashMap$KeyIterator.next(Unknown Source)
at
com.mysql.jdbc.LoadBalancingConnectionProxy.getGlobalBlacklist(LoadBalancingConnectionProxy.java:520)
at com.mysql.jdbc.RandomBalanceStrategy.pickConnection(RandomBalanceStrategy.java:55)
at
com.mysql.jdbc.LoadBalancingConnectionProxy.pickNewConnection(LoadBalancingConnectionProxy.java:414)
at
com.mysql.jdbc.LoadBalancingConnectionProxy.invoke(LoadBalancingConnectionProxy.java:390)
```

(Bug#42055)

- SQL injection was possible when using a string containing U+00A5 in a client-side prepared statement, and the character set being used was SJIS/Windows-31J. (Bug#41730)
- MySQL Connector/J 5.1.7 was slower than previous versions when the `rewriteBatchedStatements` option was set to `true`.

## ■ Note

The performance regression in `indexOfIgnoreCaseRespectMarker()` has been fixed. It has also been made possible for the driver to rewrite `INSERT` statements with `ON DUPLICATE KEY UPDATE` clauses in them, as long as the `UPDATE` clause contains no reference to `LAST_INSERT_ID()`, as that would cause the driver to return bogus values for `getGeneratedKeys()` invocations. This has resulted in improved performance over version 5.1.7.

(Bug#41532)

- `PreparedStatement.addBatch()` did not check for all parameters being set, which led to inconsistent behavior in `executeBatch()`, especially when rewriting batched statements into multi-value `INSERT`s. (Bug#41161)

### C.7.1.2. Changes in MySQL Connector/J 5.1.7 (21 October 2008)

Functionality added or changed:

- When statements include `ON DUPLICATE UPDATE`, and `rewriteBatchedStatements` is set to true, batched statements are not rewritten into the form `INSERT INTO table VALUES (), (), ()`, instead the statements are executed sequentially.

Bugs fixed:

- `Statement.getGeneratedKeys()` returned two keys when using `ON DUPLICATE KEY UPDATE` and the row was updated, not inserted. (Bug#42309)
- When using the replication driver with `autoReconnect=true`, Connector/J checks in `PreparedStatement.execute` (also called by `CallableStatement.execute`) to determine if the first character of the statement is an “S”, in an attempt to block all statements that are not read-only-safe, for example non-`SELECT` statements. However, this also blocked `CALL`s to stored procedures, even if the stored procedures were defined as `SQL READ DATA` or `NO SQL`. (Bug#40031)
- With large result sets `ResultSet.findColumn` became a performance bottleneck. (Bug#39962)
- Connector/J ignored the value of the MySQL Server variable `auto_increment_increment`. (Bug#39956)
- Connector/J failed to parse `TIMESTAMP` strings for nanos correctly. (Bug#39911)
- When the `LoadBalancingConnectionProxy` handles a `SQLException` with SQL state starting with “08”, it calls `invalidateCurrentConnection`, which in turn removes that `Connection` from `liveConnections` and the `connectionsToHostsMap`, but it did not add the host to the new global blacklist, if the global blacklist was enabled.

There was also the possibility of a `NullPointerException` when trying to update stats, where `connectionsToHostsMap.get(this.currentConn)` was called:

```
int hostIndex = ((Integer) this.hostsToListIndexMap.get(this.connectionsToHostsMap.get(this.currentConn))).intValue
```

This could happen if a client tried to issue a rollback after catching a `SQLException` caused by a connection failure. (Bug#39784)

- When configuring the Java Replication Driver the last slave specified was never used. (Bug#39611)
- When an `INSERT ON DUPLICATE KEY UPDATE` was performed, and the key already existed, the `affected-rows` value was returned as 1 instead of 0. (Bug#39352)
- When using the random load balancing strategy and starting with two servers that were both unavailable, an `IndexOutOfBoundsException` was generated when removing a server from the `whiteList`. (Bug#38782)
- Connector/J threw the following exception when using a read-only connection:

```
java.sql.SQLException: Connection is read-only. Queries leading to data
modification are not allowed.
```

(Bug#38747)

- Connector/J was unable to connect when using a non-latin1 password. (Bug#37570)
- Incorrect result is returned from `isAfterLast()` in streaming `ResultSet` when using `setFetchSize(Integer.MIN_VALUE)`. (Bug#35170)

- When `getGeneratedKeys()` was called on a statement that had not been created with `RETURN_GENERATED_KEYS`, no exception was thrown, and batched executions then returned erroneous values. (Bug#34185)
- The `loadBalance bestResponseTime` blacklists did not have a global state. (Bug#33861)

### C.7.1.3. Changes in MySQL Connector/J 5.1.6 (07 March 2008)

Functionality added or changed:

- Multiple result sets were not supported when using streaming mode to return data. Both normal statements and the result sets from stored procedures now return multiple results sets, with the exception of result sets using registered `OUTPUT` parameters. (Bug#33678)
- XAConnections and datasources have been updated to the JDBC-4.0 standard.
- The profiler event handling has been made extensible via the `profilerEventHandler` connection property.
- Add the `verifyServerCertificate` property. If set to "false" the driver will not verify the server's certificate when `useSSL` is set to "true"

When using this feature, the keystore parameters should be specified by the `clientCertificateKeyStore*` properties, rather than system properties, as the JSSE doesn't it straightforward to have a non-verifying trust store and the "default" key store.

Bugs fixed:

- `DatabaseMetaData.getColumns()` returns incorrect `COLUMN_SIZE` value for `SET` column. (Bug#36830)
- When trying to read `Time` values like "00:00:00" with `ResultSet.getTime(int)` an exception is thrown. (Bug#36051)
- JDBC connection URL parameters is ignored when using `MysqlConnectionPoolDataSource`. (Bug#35810)
- When `useServerPrepStmts=true` and slow query logging is enabled, the connector throws a `NullPointerException` when it encounters a slow query. (Bug#35666)
- When using the keyword "loadbalance" in the connection string and trying to perform load balancing between two databases, the driver appears to hang. (Bug#35660)
- JDBC data type getter method was changed to accept only column name, whereas previously it accepted column label. (Bug#35610)
- Prepared statements from pooled connections caused a `NullPointerException` when `closed()` under JDBC-4.0. (Bug#35489)
- In calling a stored function returning a `bigint`, an exception is encountered beginning:
 

```
java.sql.SQLException: java.lang.NumberFormatException: For input string:
```

 followed by the text of the stored function starting after the argument list. (Bug#35199)
- The JDBC driver uses a different method for evaluating column names in `resultsetmetadata.getColumnname()` and when looking for a column in `resultset.getObject(columnName)`. This causes Hibernate to fail in queries where the two methods yield different results, for example in queries that use alias names:
 

```
SELECT column AS aliasName from table
```

 (Bug#35150)
- `MysqlConnectionPoolDataSource` does not support `ReplicationConnection`. Notice that we implemented `com.mysql.jdbc.Connection` for `ReplicationConnection`, however, only accessors from `ConnectionProperties` are implemented (not the mutators), and they return values from the currently active connection. All other methods from `com.mysql.jdbc.Connection` are implemented, and operate on the currently active connection, with the exception of `resetServerState()` and `changeUser()`. (Bug#34937)
- `ResultSet.getTimestamp()` returns incorrect values for month/day of `TIMESTAMPS` when using server-side prepared statements (not enabled by default). (Bug#34913)

- `RowDataStatic` doesn't always set the metadata in `ResultSetRow`, which can lead to failures when unpacking `DATE`, `TIME`, `DATETIME` and `TIMESTAMP` types when using absolute, relative, and previous result set navigation methods. (Bug#34762)
- When calling `isValid()` on an active connection, if the timeout is nonzero then the `Connection` is invalidated even if the `Connection` is valid. (Bug#34703)
- It was not possible to truncate a `BLOB` using `Blob.truncate()` when using 0 as an argument. (Bug#34677)
- When using a cursor fetch for a statement, the internal prepared statement could cause a memory leak until the connection was closed. The internal prepared statement is now deleted when the corresponding result set is closed. (Bug#34518)
- When retrieving the column type name of a geometry field, the driver would return `UNKNOWN` instead of `GEOMETRY`. (Bug#34194)
- Statements with batched values do not return correct values for `getGeneratedKeys()` when `rewriteBatchedStatements` is set to `true`, and the statement has an `ON DUPLICATE KEY UPDATE` clause. (Bug#34093)
- The internal class `ResultSetInternalMethods` referenced the non-public class `com.mysql.jdbc.CachedResultSetMetaData`. (Bug#33823)
- A `NullPointerException` could be raised when using client-side prepared statements and enabled the prepared statement cache using the `cachePrepStmts`. (Bug#33734)
- Using server side cursors and cursor fetch, the table metadata information would return the data type name instead of the column name. (Bug#33594)
- `ResultSet.getTimestamp()` would throw a `NullPointerException` instead of a `SQLException` when called on an empty `ResultSet`. (Bug#33162)
- Load balancing connection using best response time would incorrectly "stick" to hosts that were down when the connection was first created.

We solve this problem with a black list that is used during the picking of new hosts. If the black list ends up including all configured hosts, the driver will retry for a configurable number of times (the `retriesAllDown` configuration property, with a default of 120 times), sleeping 250ms between attempts to pick a new connection.

We've also went ahead and made the balancing strategy extensible. To create a new strategy, implement the interface `com.mysql.jdbc.BalanceStrategy` (which also includes our standard "extension" interface), and tell the driver to use it by passing in the class name via the `loadBalanceStrategy` configuration property. (Bug#32877)

- During a Daylight Savings Time (DST) switchover, there was no way to store two timestamp/datetime values, as the hours end up being the same when sent as the literal that MySQL requires.

Note that to get this scenario to work with MySQL (since it doesn't support per-value timezones), you need to configure your server (or session) to be in UTC, and tell the driver not to use the legacy date/time code by setting `useLegacyDatetimeCode` to "false". This will cause the driver to always convert to/from the server and client timezone consistently.

This bug fix also fixes Bug#15604, by adding entirely new date/time handling code that can be switched on by `useLegacyDatetimeCode` being set to "false" as a JDBC configuration property. For Connector/J 5.1.x, the default is "true", in trunk and beyond it will be "false" (i.e. the old date/time handling code will be deprecated) (Bug#32577, Bug#15604)

- When unpacking rows directly, we don't hand off error message packets to the internal method which decodes them correctly, so no exception is raised, and the driver then hangs trying to read rows that aren't there. This tends to happen when calling stored procedures, as normal SELECTs won't have an error in this spot in the protocol unless an I/O error occurs. (Bug#32246)
- When using a connection from `ConnectionPoolDataSource`, some `Connection.prepareStatement()` methods would return null instead of the prepared statement. (Bug#32101)
- Using `CallableStatement.setNull()` on a stored function would throw an `ArrayIndexOutOfBoundsException` exception when setting the last parameter to null. (Bug#31823)
- `MysqlValidConnectionChecker` doesn't properly handle connections created using `ReplicationConnection`. (Bug#31790)
- Retrieving the server version information for an active connection could return invalid information if the default character encoding on the host was not ASCII compatible. (Bug#31192)
- Further fixes have been made to this bug in the event that a node is non-responsive. Connector/J will now try a different random node instead of waiting for the node to recover before continuing. (Bug#31053)

- `ResultSet` returned by `Statement.getGeneratedKeys()` is not closed automatically when statement that created it is closed. (Bug#30508)
- `DatabaseMetadata.getColumns()` doesn't return the correct column names if the connection character isn't UTF-8. A bug in MySQL server compounded the issue, but was fixed within the MySQL 5.0 release cycle. The fix includes changes to all the sections of the code that access the server metadata. (Bug#20491)
- Fixed `ResultSetMetadata.getColumnNames()` for result sets returned from `Statement.getGeneratedKeys()` - it was returning null instead of "GENERATED\_KEY" as in 5.0.x.

#### C.7.1.4. Changes in MySQL Connector/J 5.1.5 (09 October 2007)

The following features are new, compared to the 5.0 series of Connector/J

- Support for JDBC-4.0 `NCHAR`, `NVARCHAR` and `NCLOB` types.
- JDBC-4.0 support for setting per-connection client information (which can be viewed in the comments section of a query via `SHOW PROCESSLIST` on a MySQL server, or can be extended to support custom persistence of the information via a public interface).
- Support for JDBC-4.0 XML processing via JAXP interfaces to DOM, SAX and StAX.
- JDBC-4.0 standardized unwrapping to interfaces that include vendor extensions.

Functionality added or changed:

- Added `autoSlowLog` configuration property, overrides `slowQueryThreshold*` properties, driver determines slow queries by those that are slower than  $5 * \text{stddev}$  of the mean query time (outside the 96% percentile).

Bugs fixed:

- When a connection is in read-only mode, queries that are wrapped in parentheses were incorrectly identified DML statements. (Bug#28256)

#### C.7.1.5. Changes in MySQL Connector/J 5.1.4 (Not Released)

Only released internally.

#### C.7.1.6. Changes in MySQL Connector/J 5.1.3 (10 September 2007)

The following features are new, compared to the 5.0 series of Connector/J

- Support for JDBC-4.0 `NCHAR`, `NVARCHAR` and `NCLOB` types.
- JDBC-4.0 support for setting per-connection client information (which can be viewed in the comments section of a query via `SHOW PROCESSLIST` on a MySQL server, or can be extended to support custom persistence of the information via a public interface).
- Support for JDBC-4.0 XML processing via JAXP interfaces to DOM, SAX and StAX.
- JDBC-4.0 standardized unwrapping to interfaces that include vendor extensions.

Functionality added or changed:

- Connector/J now connects using an initial character set of `utf-8` solely for the purpose of authentication to allow user names or database names in any character set to be used in the JDBC connection URL. (Bug#29853)
- Added two configuration parameters:
  - `blobsAreStrings` — Should the driver always treat BLOBs as Strings. Added specifically to work around dubious metadata returned by the server for `GROUP BY` clauses. Defaults to false.



- `functionsNeverReturnBlobs` — Should the driver always treat data from functions returning `BLOBs` as Strings. Added specifically to work around dubious metadata returned by the server for `GROUP BY` clauses. Defaults to false.
- Setting `rewriteBatchedStatements` to `true` now causes CallableStatements with batched arguments to be re-written in the form "CALL (...); CALL (...); ..." to send the batch in as few client-server round trips as possible.
- The driver now picks appropriate internal row representation (whole row in one buffer, or individual byte[]s for each column value) depending on heuristics, including whether or not the row has `BLOB` or `TEXT` types and the overall row-size. The threshold for row size that will cause the driver to use a buffer rather than individual byte[]s is configured by the configuration property `largeRowSizeThreshold`, which has a default value of 2KB.
- The data (and how it is stored) for `ResultSet` rows are now behind an interface which allows us (in some cases) to allocate less memory per row, in that for "streaming" result sets, we re-use the packet used to read rows, since only one row at a time is ever active.
- Added experimental support for statement "interceptors" via the `com.mysql.jdbc.StatementInterceptor` interface, examples are in `com/mysql/jdbc/interceptors`. Implement this interface to be placed "in between" query execution, so that it can be influenced (currently experimental).
- The driver will automatically adjust the server session variable `net_write_timeout` when it determines its been asked for a "streaming" result, and resets it to the previous value when the result set has been consumed. (The configuration property is named `netTimeoutForStreamingResults`, with a unit of seconds, the value '0' means the driver will not try and adjust this value).
- JDBC-4.0 ease-of-development features including auto-registration with the `DriverManager` via the service provider mechanism, standardized Connection validity checks and categorized `SQLExceptions` based on recoverability/retry-ability and class of the underlying error.
- `Statement.setQueryTimeout()`s now affect the entire batch for batched statements, rather than the individual statements that make up the batch.
- Errors encountered during `Statement/PreparedStatement/CallableStatement.executeBatch()` when `rewriteBatchStatements` has been set to `true` now return `BatchUpdateExceptions` according to the setting of `continueBatchOnError`.

If `continueBatchOnError` is set to `true`, the update counts for the "chunk" that were sent as one unit will all be set to `EXECUTE_FAILED`, but the driver will attempt to process the remainder of the batch. You can determine which "chunk" failed by looking at the update counts returned in the `BatchUpdateException`.

If `continueBatchOnError` is set to "false", the update counts returned will contain all updates up-to and including the failed "chunk", with all counts for the failed "chunk" set to `EXECUTE_FAILED`.

Since MySQL doesn't return multiple error codes for multiple-statements, or for multi-value `INSERT/REPLACE`, it is the application's responsibility to handle determining which item(s) in the "chunk" actually failed.

- New methods on `com.mysql.jdbc.Statement`: `setLocalInfileInputStream()` and `getLocalInfileInputStream()`:
  - `setLocalInfileInputStream()` sets an `InputStream` instance that will be used to send data to the MySQL server for a `LOAD DATA LOCAL INFILE` statement rather than a `FileInputStream` or `URLInputStream` that represents the path given as an argument to the statement.
 

This stream will be read to completion upon execution of a `LOAD DATA LOCAL INFILE` statement, and will automatically be closed by the driver, so it needs to be reset before each call to `execute*()` that would cause the MySQL server to request data to fulfill the request for `LOAD DATA LOCAL INFILE`.

If this value is set to `NULL`, the driver will revert to using a `FileInputStream` or `URLInputStream` as required.
  - `getLocalInfileInputStream()` returns the `InputStream` instance that will be used to send data in response to a `LOAD DATA LOCAL INFILE` statement.
 

This method returns `NULL` if no such stream has been set via `setLocalInfileInputStream()`.
- Setting `useBlobToStoreUTF8OutsideBMP` to `true` tells the driver to treat `[MEDIUM/LONG]BLOB` columns as `[LONG]VARCHAR` columns holding text encoded in UTF-8 that has characters outside the BMP (4-byte encodings), which MySQL server can't handle natively.

Set `utf8OutsideBmpExcludedColumnNamePattern` to a regex so that column names matching the given regex will still be treated as `BLOBs`. The regex must follow the patterns used for the `java.util.regex` package. The default is to exclude no columns, and include all columns.

Set `utf8OutsideBmpIncludedColumnNamePattern` to specify exclusion rules to `utf8OutsideBmpExcludedColumnNamePattern`. The regex must follow the patterns used for the `java.util.regex` package.

Bugs fixed:

- `setObject(int, Object, int, int)` delegate in `PreparedStatementWrapper` delegates to wrong method. (Bug#30892)
- NPE with null column values when `padCharsWithSpace` is set to true. (Bug#30851)
- Collation on `VARBINARY` column types would be misidentified. A fix has been added, but this fix only works for MySQL server versions 5.0.25 and newer, since earlier versions didn't consistently return correct metadata for functions, and thus results from subqueries and functions were indistinguishable from each other, leading to type-related bugs. (Bug#30664)
- An `ArithmeticException` or `NullPointerException` would be raised when the batch had zero members and `rewriteBatchedStatements=true` when `addBatch()` was never called, or `executeBatch()` was called immediately after `clearBatch()`. (Bug#30550)
- Closing a load-balanced connection would cause a `ClassCastException`. (Bug#29852)
- Connection checker for JBoss didn't use same method parameters via reflection, causing connections to always seem "bad". (Bug#29106)
- `DatabaseMetaData.getTypeInfo()` for the types `DECIMAL` and `NUMERIC` will return a precision of 254 for server versions older than 5.0.3, 64 for versions 5.0.3-5.0.5 and 65 for versions newer than 5.0.5. (Bug#28972)
- `CallableStatement.executeBatch()` doesn't work when connection property `noAccessToProcedureBodies` has been set to `true`.

The fix involves changing the behavior of `noAccessToProcedureBodies`, in that the driver will now report all parameters as "IN" parameters but allow callers to call `registerOutParameter()` on them without throwing an exception. (Bug#28689)

- `DatabaseMetaData.getColumns()` doesn't contain `SCOPE_*` or `IS_AUTOINCREMENT` columns. (Bug#27915)
- Schema objects with identifiers other than the connection character aren't retrieved correctly in `ResultSetMetadata`. (Bug#27867)
- `Connection.getServerCharacterEncoding()` doesn't work for servers with version  $\geq 4.1$ . (Bug#27182)
- The automated SVN revisions in `DBMD.getDriverVersion()`. The SVN revision of the directory is now inserted into the version information during the build. (Bug#21116)
- Specifying a "validation query" in your connection pool that starts with `"/ * ping */" _exactly_` will cause the driver to instead send a ping to the server and return a fake result set (much lighter weight), and when using a `ReplicationConnection` or a `LoadBalancedConnection`, will send the ping across all active connections.

### C.7.1.7. Changes in MySQL Connector/J 5.1.2 (29 June 2007)

This is a new Beta development release, fixing recently discovered bugs.

Functionality added or changed:

- Setting the configuration property `rewriteBatchedStatements` to `true` will now cause the driver to rewrite batched prepared statements with more than 3 parameter sets in a batch into multi-statements (separated by ";") if they are not plain (that is, without `SELECT` or `ON DUPLICATE KEY UPDATE` clauses) `INSERT` or `REPLACE` statements.

### C.7.1.8. Changes in MySQL Connector/J 5.1.1 (22 June 2007)

This is a new Alpha development release, adding new features and fixing recently discovered bugs.

Functionality added or changed:

- **Incompatible Change:** Pulled vendor-extension methods of `Connection` implementation out into an interface to support



`java.sql.Wrapper` functionality from `ConnectionPoolDataSource`. The vendor extensions are javadoc'd in the `com.mysql.jdbc.Connection` interface.

For those looking further into the driver implementation, it is not an API that is used for plugability of implementations inside our driver (which is why there are still references to `ConnectionImpl` throughout the code).

We've also added server and client `prepareStatement()` methods that cover all of the variants in the JDBC API.

`Connection.serverPrepare(String)` has been re-named to `Connection.serverPrepareStatement()` for consistency with `Connection.clientPrepareStatement()`.

- Row navigation now causes any streams/readers open on the result set to be closed, as in some cases we're reading directly from a shared network packet and it will be overwritten by the "next" row.
- Made it possible to retrieve prepared statement parameter bindings (to be used in `StatementInterceptors`, primarily).
- Externalized the descriptions of connection properties.
- The data (and how it is stored) for `ResultSet` rows are now behind an interface which allows us (in some cases) to allocate less memory per row, in that for "streaming" result sets, we re-use the packet used to read rows, since only one row at a time is ever active.
- Similar to `Connection`, we pulled out vendor extensions to `Statement` into an interface named `com.mysql.Statement`, and moved the `Statement` class into `com.mysql.StatementImpl`. The two methods (javadoc'd in `com.mysql.Statement` are `enableStreamingResults()`, which already existed, and `disableStreamingResults()` which sets the statement instance back to the fetch size and result set type it had before `enableStreamingResults()` was called.
- Driver now picks appropriate internal row representation (whole row in one buffer, or individual byte[]s for each column value) depending on heuristics, including whether or not the row has `BLOB` or `TEXT` types and the overall row-size. The threshold for row size that will cause the driver to use a buffer rather than individual byte[]s is configured by the configuration property `largeRowSizeThreshold`, which has a default value of 2KB.
- Added experimental support for statement "interceptors" via the `com.mysql.jdbc.StatementInterceptor` interface, examples are in `com/mysql/jdbc/interceptors`.

Implement this interface to be placed "in between" query execution, so that you can influence it. (currently experimental).

`StatementInterceptors` are "chainable" when configured by the user, the results returned by the "current" interceptor will be passed on to the next on in the chain, from left-to-right order, as specified by the user in the JDBC configuration property `statementInterceptors`.

- See the sources (fully javadoc'd) for `com.mysql.jdbc.StatementInterceptor` for more details until we iron out the API and get it documented in the manual.
- Setting `rewriteBatchedStatements` to `true` now causes `CallableStatements` with batched arguments to be rewritten in the form `CALL (...); CALL (...); ...` to send the batch in as few client-server round trips as possible.

### C.7.1.9. Changes in MySQL Connector/J 5.1.0 (11 April 2007)

This is the first public alpha release of the current Connector/J 5.1 development branch, providing an insight to upcoming features. Although some of these are still under development, this release includes the following new features and changes (in comparison to the current Connector/J 5.0 production release):

**Important change:** Due to a number of issues with the use of server-side prepared statements, Connector/J 5.0.5 has disabled their use by default. The disabling of server-side prepared statements does not affect the operation of the connector in any way.

To enable server-side prepared statements you must add the following configuration property to your connector string:

```
useServerPrepStmnts=true
```

The default value of this property is `false` (that is, Connector/J does not use server-side prepared statements).

#### Note

The disabling of server-side prepared statements does not affect the operation of the connector. However, if you use the `useTimezone=true` connection option and use client-side prepared statements (instead of server-side prepared statements) you should also set `useSSPSCCompatibleTimezoneShift=true`.

Functionality added or changed:

- Refactored `CommunicationsException` into a JDBC-3.0 version, and a JDBC-4.0 version (which extends `SQLRecoverableException`, now that it exists).

#### Note

This change means that if you were catching `com.mysql.jdbc.CommunicationsException` in your applications instead of looking at the `SQLState` class of `08`, and are moving to Java 6 (or newer), you need to change your imports to that exception to be `com.mysql.jdbc.exceptions.jdbc4.CommunicationsException`, as the old class will not be instantiated for communications link-related errors under Java 6.

- Added support for JDBC-4.0 categorized `SQLExceptions`.
- Added support for JDBC-4.0's `NCLOB`, and `NCHAR/NVARCHAR` types.
- `com.mysql.jdbc.java6.javac` — full path to your Java-6 `javac` executable
- Added support for JDBC-4.0's `SQLXML` interfaces.
- Re-worked Ant buildfile to build JDBC-4.0 classes separately, as well as support building under Eclipse (since Eclipse can't mix/match JDKs).

To build, you must set `JAVA_HOME` to `J2SDK-1.4.2` or `Java-5`, and set the following properties on your Ant command line:

- `com.mysql.jdbc.java6.javac` — full path to your Java-6 `javac` executable
- `com.mysql.jdbc.java6.rtfar` — full path to your Java-6 `rt.jar` file
- New feature — driver will automatically adjust session variable `net_write_timeout` when it determines it has been asked for a "streaming" result, and resets it to the previous value when the result set has been consumed. (configuration property is named `netTimeoutForStreamingResults` value and has a unit of seconds, the value `0` means the driver will not try and adjust this value).
- Added support for JDBC-4.0's client information. The backend storage of information provided via `Connection.setClientInfo()` and retrieved by `Connection.getClientInfo()` is pluggable by any class that implements the `com.mysql.jdbc.JDBC4ClientInfoProvider` interface and has a no-args constructor.

The implementation used by the driver is configured using the `clientInfoProvider` configuration property (with a default of value of `com.mysql.jdbc.JDBC4CommentClientInfoProvider`, an implementation which lists the client information as a comment prepended to every query sent to the server).

This functionality is only available when using Java-6 or newer.

- `com.mysql.jdbc.java6.rtfar` — full path to your Java-6 `rt.jar` file
- Added support for JDBC-4.0's `Wrapper` interface.

## C.7.2. Changes in MySQL Connector/J 5.0.x

### C.7.2.1. Changes in MySQL Connector/J 5.0.8 (09 October 2007)

Functionality added or changed:

- `blobsAreStrings` — Should the driver always treat BLOBs as Strings. Added specifically to work around dubious metadata returned by the server for `GROUP BY` clauses. Defaults to false.
- Added two configuration parameters:
  - `blobsAreStrings` — Should the driver always treat BLOBs as Strings. Added specifically to work around dubious metadata returned by the server for `GROUP BY` clauses. Defaults to false.
  - `functionsNeverReturnBlobs` — Should the driver always treat data from functions returning BLOBs as Strings. Added specifically to work around dubious metadata returned by the server for `GROUP BY` clauses. Defaults to false.
- `functionsNeverReturnBlobs` — Should the driver always treat data from functions returning BLOBs as Strings. Added specifically to work around dubious metadata returned by the server for `GROUP BY` clauses. Defaults to false.

- XAConnections now start in auto-commit mode (as per JDBC-4.0 specification clarification).
- Driver will now fall back to sane defaults for `max_allowed_packet` and `net_buffer_length` if the server reports them incorrectly (and will log this situation at `WARN` level, since it is actually an error condition).

#### Bugs fixed:

- Connections established using URLs of the form `jdbc:mysql:loadbalance://` weren't doing failover if they tried to connect to a MySQL server that was down. The driver now attempts connections to the next "best" (depending on the load balance strategy in use) server, and continues to attempt connecting to the next "best" server every 250 milliseconds until one is found that is up and running or 5 minutes has passed.  
  
If the driver gives up, it will throw the last-received `SQLException`. ([Bug#31053](#))
- `setObject(int, Object, int, int)` delegate in `PreparedStatementWrapper` delegates to wrong method. ([Bug#30892](#))
- NPE with null column values when `padCharsWithSpace` is set to true. ([Bug#30851](#))
- Collation on `VARBINARY` column types would be misidentified. A fix has been added, but this fix only works for MySQL server versions 5.0.25 and newer, since earlier versions didn't consistently return correct metadata for functions, and thus results from subqueries and functions were indistinguishable from each other, leading to type-related bugs. ([Bug#30664](#))
- An `ArithmeticException` or `NullPointerException` would be raised when the batch had zero members and `rewriteBatchedStatements=true` when `addBatch()` was never called, or `executeBatch()` was called immediately after `clearBatch()`. ([Bug#30550](#))

- Closing a load-balanced connection would cause a `ClassCastException`. ([Bug#29852](#))
- Connection checker for JBoss didn't use same method parameters via reflection, causing connections to always seem "bad". ([Bug#29106](#))
- `DatabaseMetaData.getTypeInfo()` for the types `DECIMAL` and `NUMERIC` will return a precision of 254 for server versions older than 5.0.3, 64 for versions 5.0.3-5.0.5 and 65 for versions newer than 5.0.5. ([Bug#28972](#))
- `CallableStatement.executeBatch()` doesn't work when connection property `noAccessToProcedureBodies` has been set to `true`.

The fix involves changing the behavior of `noAccessToProcedureBodies`, in that the driver will now report all parameters as "IN" parameters but allow callers to call `registerOutParameter()` on them without throwing an exception. ([Bug#28689](#))

- When a connection is in read-only mode, queries that are wrapped in parentheses were incorrectly identified DML statements. ([Bug#28256](#))
- `UNSIGNED` types not reported via `DBMD.getTypeInfo()`, and capitalization of type names is not consistent between `DBMD.getColumns()`, `RSMD.getColumnTypeName()` and `DBMD.getTypeInfo()`.

This fix also ensures that the precision of `UNSIGNED MEDIUMINT` and `UNSIGNED BIGINT` is reported correctly via `DBMD.getColumns()`. ([Bug#27916](#))

- `DatabaseMetaData.getColumns()` doesn't contain `SCOPE_*` or `IS_AUTOINCREMENT` columns. ([Bug#27915](#))
- Schema objects with identifiers other than the connection character aren't retrieved correctly in `ResultSetMetadata`. ([Bug#27867](#))
- Cached metadata with `PreparedStatement.execute()` throws `NullPointerException`. ([Bug#27412](#))
- `Connection.getServerCharacterEncoding()` doesn't work for servers with version  $\geq$  4.1. ([Bug#27182](#))
- The automated SVN revisions in `DBMD.getDriverVersion()`. The SVN revision of the directory is now inserted into the version information during the build. ([Bug#21116](#))
- Specifying a "validation query" in your connection pool that starts with `"/ * ping * /"` \_exactly\_ will cause the driver to instead send a ping to the server and return a fake result set (much lighter weight), and when using a `ReplicationConnection` or a `LoadBalancedConnection`, will send the ping across all active connections.

## C.7.2.2. Changes in MySQL Connector/J 5.0.7 (20 July 2007)

Functionality added or changed:

- The driver will now automatically set `useServerPrepStmts` to `true` when `useCursorFetch` has been set to `true`, since the feature requires server-side prepared statements in order to function.
- `tcpKeepAlive` - Should the driver set `SO_KEEPALIVE` (default `true`)?
- Give more information in EOFExceptions thrown out of `MysqlIO` (how many bytes the driver expected to read, how many it actually read, say that communications with the server were unexpectedly lost).
- Driver detects when it is running in a ColdFusion MX server (tested with version 7), and uses the configuration bundle `cold-Fusion`, which sets `useDynamicCharsetInfo` to `false` (see previous entry), and sets `useLocalSessionState` and `autoReconnect` to `true`.
- `tcpNoDelay` - Should the driver set `SO_TCP_NODELAY` (disabling the Nagle Algorithm, default `true`)?
- Added configuration property `slowQueryThresholdNanos` - if `useNanosForElapsedTime` is set to `true`, and this property is set to a nonzero value the driver will use this threshold (in nanosecond units) to determine if a query was slow, instead of using millisecond units.
- `tcpRcvBuf` - Should the driver set `SO_RCV_BUF` to the given value? The default value of '0', means use the platform default value for this property.
- Setting `useDynamicCharsetInfo` to `false` now causes driver to use static lookups for collations as well (makes `ResultSetMetadata.isCaseSensitive()` much more efficient, which leads to performance increase for ColdFusion, which calls this method for every column on every table it sees, it appears).
- Added configuration properties to allow tuning of TCP/IP socket parameters:
  - `tcpNoDelay` - Should the driver set `SO_TCP_NODELAY` (disabling the Nagle Algorithm, default `true`)?
  - `tcpKeepAlive` - Should the driver set `SO_KEEPALIVE` (default `true`)?
  - `tcpRcvBuf` - Should the driver set `SO_RCV_BUF` to the given value? The default value of '0', means use the platform default value for this property.
  - `tcpSndBuf` - Should the driver set `SO_SND_BUF` to the given value? The default value of '0', means use the platform default value for this property.
  - `tcpTrafficClass` - Should the driver set traffic class or type-of-service fields? See the documentation for `java.net.Socket.setTrafficClass()` for more information.
- Setting the configuration parameter `useCursorFetch` to `true` for MySQL-5.0+ enables the use of cursors that allow `Connector/J` to save memory by fetching result set rows in chunks (where the chunk size is set by calling `setFetchSize()` on a `Statement` or `ResultSet`) by using fully-materialized cursors on the server.
- `tcpSndBuf` - Should the driver set `SO_SND_BUF` to the given value? The default value of '0', means use the platform default value for this property.
- `tcpTrafficClass` - Should the driver set traffic class or type-of-service fields? See the documentation for `java.net.Socket.setTrafficClass()` for more information.
- Added new debugging functionality - Setting configuration property `includeInnodbStatusInDeadlockExceptions` to `true` will cause the driver to append the output of `SHOW ENGINE INNODB STATUS` to deadlock-related exceptions, which will enumerate the current locks held inside `InnoDB`.
- Added configuration property `useNanosForElapsedTime` - for profiling/debugging functionality that measures elapsed time, should the driver try to use nanoseconds resolution if available (requires `JDK >= 1.5`)?

#### Note

If `useNanosForElapsedTime` is set to `true`, and this property is set to "0" (or left default), then elapsed times will still be measured in nanoseconds (if possible), but the slow query threshold will be converted from milliseconds to nanoseconds, and thus have an upper bound of approximately 2000 milliseconds (as that threshold is represented as an integer, not a long).

Bugs fixed:

- Don't send any file data in response to `LOAD DATA LOCAL INFILE` if the feature is disabled at the client side. This is to prevent a malicious server or man-in-the-middle from asking the client for data that the client is not expecting. Thanks to Jan Kneschke for discovering the exploit and Andrey "Poohie" Hristov, Konstantin Osipov and Sergei Golubchik for discussions about implications and possible fixes. ([Bug#29605](#))
- Parser in client-side prepared statements runs to end of statement, rather than end-of-line for '#' comments. Also added support for '-' single-line comments. ([Bug#28956](#))
- Parser in client-side prepared statements eats character following '/' if it is not a multi-line comment. ([Bug#28851](#))
- `PreparedStatement.getMetaData()` for statements containing leading one-line comments is not returned correctly.

As part of this fix, we also overhauled detection of DML for `executeQuery()` and `SELECTs` for `executeUpdate()` in plain and prepared statements to be aware of the same types of comments. ([Bug#28469](#))

### C.7.2.3. Changes in MySQL Connector/J 5.0.6 (15 May 2007)

Functionality added or changed:

- Added an experimental load-balanced connection designed for use with SQL nodes in a MySQL Cluster/NDB environment (This is not for master-slave replication. For that, we suggest you look at [ReplicationConnection](#) or [lbpool](#)).

If the JDBC URL starts with `jdbc:mysql:loadbalance://host-1,host-2,...host-n`, the driver will create an implementation of `java.sql.Connection` that load balances requests across a series of MySQL JDBC connections to the given hosts, where the balancing takes place after transaction commit.

Therefore, for this to work (at all), you must use transactions, even if only reading data.

Physical connections to the given hosts will not be created until needed.

The driver will invalidate connections that it detects have had communication errors when processing a request. A new connection to the problematic host will be attempted the next time it is selected by the load balancing algorithm.

There are two choices for load balancing algorithms, which may be specified by the `loadBalanceStrategy` JDBC URL configuration property:

- `random` — the driver will pick a random host for each request. This tends to work better than round-robin, as the randomness will somewhat account for spreading loads where requests vary in response time, while round-robin can sometimes lead to overloaded nodes if there are variations in response times across the workload.
- `bestResponseTime` — the driver will route the request to the host that had the best response time for the previous transaction.
- `bestResponseTime` — the driver will route the request to the host that had the best response time for the previous transaction.
- Added configuration property `padCharsWithSpace` (defaults to `false`). If set to `true`, and a result set column has the `CHAR` type and the value does not fill the amount of characters specified in the DDL for the column, the driver will pad the remaining characters with space (for ANSI compliance).
- When `useLocalSessionState` is set to `true` and connected to a MySQL-5.0 or later server, the JDBC driver will now determine whether an actual `commit` or `rollback` statement needs to be sent to the database when `Connection.commit()` or `Connection.rollback()` is called.

This is especially helpful for high-load situations with connection pools that always call `Connection.rollback()` on connection check-in/check-out because it avoids a round-trip to the server.

- Added configuration property `useDynamicCharsetInfo`. If set to `false` (the default), the driver will use a per-connection cache of character set information queried from the server when necessary, or when set to `true`, use a built-in static mapping that is more efficient, but isn't aware of custom character sets or character sets implemented after the release of the JDBC driver.

#### Note

This only affects the `padCharsWithSpace` configuration property and the `ResultSetMetaData.getColumnDisplayWidth()` method.

- New configuration property, `enableQueryTimeouts` (default `true`).

When enabled, query timeouts set via `Statement.setQueryTimeout()` use a shared `java.util.Timer` instance for scheduling. Even if the timeout doesn't expire before the query is processed, there will be memory used by the `TimerTask` for the given timeout which won't be reclaimed until the time the timeout would have expired if it hadn't been cancelled by the driver. High-load environments might want to consider disabling this functionality. (this configuration property is part of the `maxPerformance` configuration bundle).

- Give better error message when "streaming" result sets, and the connection gets clobbered because of exceeding `net_write_timeout` on the server.
- `random` — the driver will pick a random host for each request. This tends to work better than round-robin, as the randomness will somewhat account for spreading loads where requests vary in response time, while round-robin can sometimes lead to overloaded nodes if there are variations in response times across the workload.
- `com.mysql.jdbc.[NonRegistering]Driver` now understands URLs of the format `jdbc:mysql:replication://` and `jdbc:mysql:loadbalance://` which will create a `ReplicationConnection` (exactly like when using `[NonRegistering]ReplicationDriver`) and an experimental load-balanced connection designed for use with SQL nodes in a MySQL Cluster/NDB environment, respectively.

In an effort to simplify things, we're working on deprecating multiple drivers, and instead specifying different core behavior based upon JDBC URL prefixes, so watch for `[NonRegistering]ReplicationDriver` to eventually disappear, to be replaced with `com.mysql.jdbc.[NonRegistering]Driver` with the new URL prefix.

- Fixed issue where a failed-over connection would let an application call `setReadOnly(false)`, when that call should be ignored until the connection is reconnected to a writable master unless `failoverReadOnly` had been set to `false`.
- Driver will now use `INSERT INTO ... VALUES (DEFAULT)` form of statement for updatable result sets for `ResultSet.insertRow()`, rather than pre-populating the insert row with values from `DatabaseMetaData.getColumns()` (which results in a `SHOW FULL COLUMNS` on the server for every result set). If an application requires access to the default values before `insertRow()` has been called, the JDBC URL should be configured with `populateInsertRowWithDefaultValues` set to `true`.

This fix specifically targets performance issues with ColdFusion and the fact that it seems to ask for updatable result sets no matter what the application does with them.

- More intelligent initial packet sizes for the "shared" packets are used (512 bytes, rather than 16K), and initial packets used during handshake are now sized appropriately as to not require reallocation.

#### Bugs fixed:

- More useful error messages are generated when the driver thinks a result set is not updatable. (Thanks to Ashley Martens for the patch). ([Bug#28085](#))
- `Connection.getTransactionIsolation()` uses `"SHOW VARIABLES LIKE"` which is very inefficient on MySQL-5.0+ servers. ([Bug#27655](#))
- Fixed issue where calling `getGeneratedKeys()` on a prepared statement after calling `execute()` didn't always return the generated keys (`executeUpdate()` worked fine however). ([Bug#27655](#))
- `CALL /* ... */ some_proc()` doesn't work. As a side effect of this fix, you can now use `/* */` and `#` comments when preparing statements using client-side prepared statement emulation.

If the comments happen to contain parameter markers (?), they will be treated as belonging to the comment (that is, not recognized) rather than being a parameter of the statement.

#### Note

The statement when sent to the server will contain the comments as-is, they're not stripped during the process of preparing the `PreparedStatement` or `CallableStatement`.

([Bug#27400](#))

- `ResultSet.get*()` with a column index < 1 returns misleading error message. ([Bug#27317](#))
- Using `ResultSet.get*()` with a column index less than 1 returns a misleading error message. ([Bug#27317](#))
- Comments in DDL of stored procedures/functions confuse procedure parser, and thus metadata about them can not be created, leading to inability to retrieve said metadata, or execute procedures that have certain comments in them. ([Bug#26959](#))



- Fast date/time parsing doesn't take into account `00:00:00` as a legal value. (Bug#26789)
- `PreparedStatement` is not closed in `BlobFromLocator.getBytes()`. (Bug#26592)
- When the configuration property `useCursorFetch` was set to `true`, sometimes server would return new, more exact metadata during the execution of the server-side prepared statement that enables this functionality, which the driver ignored (using the original metadata returned during `prepare()`), causing corrupt reading of data due to type mismatch when the actual rows were returned. (Bug#26173)
- `CallableStatements` with `OUT/INOUT` parameters that are "binary" (`BLOB`, `BIT`, `(VAR) BINARY`, `JAVA_OBJECT`) have extra 7 bytes. (Bug#25715)
- Whitespace surrounding storage/size specifiers in stored procedure parameters declaration causes `NumberFormatException` to be thrown when calling stored procedure on JDK-1.5 or newer, as the Number classes in JDK-1.5+ are whitespace intolerant. (Bug#25624)
- Client options not sent correctly when using SSL, leading to stored procedures not being able to return results. Thanks to Don Cohen for the bug report, testcase and patch. (Bug#25545)
- `Statement.setMaxRows()` is not effective on result sets materialized from cursors. (Bug#25517)
- `BIT(> 1)` is returned as `java.lang.String` from `ResultSet.getObject()` rather than `byte[]`. (Bug#25328)

### C.7.2.4. Changes in MySQL Connector/J 5.0.5 (02 March 2007)

Functionality added or changed:

- Usage Advisor will now issue warnings for result sets with large numbers of rows. You can configure the trigger value by using the `resultSetSizeThreshold` parameter, which has a default value of 100.
- The `rewriteBatchedStatements` feature can now be used with server-side prepared statements.
- **Important change:** Due to a number of issues with the use of server-side prepared statements, Connector/J 5.0.5 has disabled their use by default. The disabling of server-side prepared statements does not affect the operation of the connector in any way.

To enable server-side prepared statements you must add the following configuration property to your connector string:

```
useServerPrepStmts=true
```

The default value of this property is `false` (that is, Connector/J does not use server-side prepared statements).

- Improved speed of `datetime` parsing for ResultSets that come from plain or non-server-side prepared statements. You can enable old implementation with `useFastDateParsing=false` as a configuration parameter.
- Usage Advisor now detects empty results sets and does not report on columns not referenced in those empty sets.
- Fixed logging of XA commands sent to server, it is now configurable via `logXACommands` property (defaults to `false`).
- Added configuration property `localSocketAddress`, which is the host name or IP address given to explicitly configure the interface that the driver will bind the client side of the TCP/IP connection to when connecting.
- We've added a new configuration option `treatUtilDateAsTimestamp`, which is `false` by default, as (1) We already had specific behavior to treat `java.util.Date` as a `java.sql.Timestamp` because it is useful to many folks, and (2) that behavior will very likely be required for drivers JDBC-post-4.0.

Bugs fixed:

- Connection property `socketFactory` wasn't exposed via correctly named mutator/accessor, causing data source implementations that use JavaBean naming conventions to set properties to fail to set the property (and in the case of SJAS, fail silently when trying to set this parameter). (Bug#26326)
- A query execution which timed out did not always throw a `MySQLTimeoutException`. (Bug#25836)
- Storing a `java.util.Date` object in a `BLOB` column would not be serialized correctly during `setObject`. (Bug#25787)
- Timer instance used for `Statement.setQueryTimeout()` created per-connection, rather than per-VM, causing memory leak. (Bug#25514)

- `EscapeProcessor` gets confused by multiple backslashes. We now push the responsibility of syntax errors back on to the server for most escape sequences. (Bug#25399)
- `INOUT` parameters in `CallableStatements` get doubly-escaped. (Bug#25379)
- When using the `rewriteBatchedStatements` connection option with `PreparedStatement.executeBatch()` an internal memory leak would occur. (Bug#25073)
- Fixed issue where field-level for metadata from `DatabaseMetaData` when using `INFORMATION_SCHEMA` didn't have references to current connections, sometimes leading to Null Pointer Exceptions (NPEs) when introspecting them via `ResultSetMetaData`. (Bug#25073)
- `StringUtils.indexOfIgnoreCaseRespectQuotes()` isn't case-insensitive on the first character of the target. This bug also affected `rewriteBatchedStatements` functionality when prepared statements did not use uppercase for the `VALUES` clause. (Bug#25047)
- Client-side prepared statement parser gets confused by in-line comments `/*...*/` and therefore cannot rewrite batch statements or reliably detect the type of statements when they are used. (Bug#25025)
- Results sets from `UPDATE` statements that are part of multi-statement queries would cause an `SQLException` error, "Result is from UPDATE". (Bug#25009)
- Specifying `US-ASCII` as the character set in a connection to a MySQL 4.1 or newer server does not map correctly. (Bug#24840)
- Using `DatabaseMetaData.getSQLKeywords()` does not return a all of the of the reserved keywords for the current MySQL version. Current implementation returns the list of reserved words for MySQL 5.1, and does not distinguish between versions. (Bug#24794)
- Calling `Statement.cancel()` could result in a Null Pointer Exception (NPE). (Bug#24721)
- Using `setFetchSize()` breaks prepared `SHOW` and other commands. (Bug#24360)
- Calendars and timezones are now lazily instantiated when required. (Bug#24351)
- Using `DATETIME` columns would result in time shifts when `useServerPrepStmts` was true. The reason was due to different behavior when using client-side compared to server-side prepared statements and the `useJDBCCompliantTimezoneShift` option. This is now fixed if moving from server-side prepared statements to client-side prepared statements by setting `useSSPSCompatibleTimezoneShift` to `true`, as the driver can't tell if this is a new deployment that never used server-side prepared statements, or if it is an existing deployment that is switching to client-side prepared statements from server-side prepared statements. (Bug#24344)
- Connector/J now returns a better error message when server doesn't return enough information to determine stored procedure/function parameter types. (Bug#24065)
- A connection error would occur when connecting to a MySQL server with certain character sets. Some collations/character sets reported as "unknown" (specifically `cias` variants of existing character sets), and inability to override the detected server character set. (Bug#23645)
- Inconsistency between `getSchemas` and `INFORMATION_SCHEMA`. (Bug#23304)
- `DatabaseMetaData.getSchemas()` doesn't return a `TABLE_CATALOG` column. (Bug#23303)
- When using a JDBC connection URL that is malformed, the `NonRegisteringDriver.getPropertyInfo` method will throw a Null Pointer Exception (NPE). (Bug#22628)
- Some exceptions thrown out of `StandardSocketFactory` were needlessly wrapped, obscuring their true cause, especially when using socket timeouts. (Bug#21480)
- When using a server-side prepared statement the driver would send timestamps to the server using nanoseconds instead of milliseconds. (Bug#21438)
- When using server-side prepared statements and timestamp columns, value would be incorrectly populated (with nanoseconds, not microseconds). (Bug#21438)
- `ParameterMetaData` throws `NullPointerException` when prepared SQL has a syntax error. Added `generateSimpleParameterMetadata` configuration property, which when set to `true` will generate metadata reflecting `VARCHAR` for every parameter (the default is `false`, which will cause an exception to be thrown if no parameter metadata for the statement is actually available). (Bug#21267)
- Fixed an issue where `XADataSources` couldn't be bound into JNDI, as the `DataSourceFactory` didn't know how to cre-



ate instances of them.

Other changes:

- Avoid static synchronized code in JVM class libraries for dealing with default timezones.
- Performance enhancement of initial character set configuration, driver will only send commands required to configure connection character set session variables if the current values on the server do not match what is required.
- Re-worked stored procedure parameter parser to be more robust. Driver no longer requires `BEGIN` in stored procedure definition, but does have requirement that if a stored function begins with a label directly after the "returns" clause, that the label is not a quoted identifier.
- Throw exceptions encountered during timeout to thread calling `Statement.execute*( )`, rather than `RuntimeException`.
- Changed cached result set metadata (when using `cacheResultSetMetadata=true`) to be cached per-connection rather than per-statement as previously implemented.
- Reverted back to internal character conversion routines for single-byte character sets, as the ones internal to the JVM are using much more CPU time than our internal implementation.
- When extracting foreign key information from `SHOW CREATE TABLE` in `DatabaseMetaData`, ignore exceptions relating to tables being missing (which could happen for cross-reference or imported-key requests, as the list of tables is generated first, then iterated).
- Fixed some Null Pointer Exceptions (NPEs) when cached metadata was used with `UpdatableResultSets`.
- Take `localSocketAddress` property into account when creating instances of `CommunicationsException` when the underlying exception is a `java.net.BindException`, so that a friendlier error message is given with a little internal diagnostics.
- Fixed cases where `ServerPreparedStatement` weren't using cached metadata when `cacheResultSetMetadata=true` was used.
- Use a `java.util.TreeMap` to map column names to ordinal indexes for `ResultSet.findColumn()` instead of a `HashMap`. This allows us to have case-insensitive lookups (required by the JDBC specification) without resorting to the many transient object instances needed to support this requirement with a normal `HashMap` with either case-adjusted keys, or case-insensitive keys. (In the worst case scenario for lookups of a 1000 column result set, `TreeMaps` are about half as fast wall-clock time as a `HashMap`, however in normal applications their use gives many orders of magnitude reduction in transient object instance creation which pays off later for CPU usage in garbage collection).
- When using cached metadata, skip field-level metadata packets coming from the server, rather than reading them and discarding them without creating `com.mysql.jdbc.Field` instances.

### C.7.2.5. Changes in MySQL Connector/J 5.0.4 (20 October 2006)

Bugs fixed:

- `DBMD.getColumns()` does not return expected `COLUMN_SIZE` for the SET type, now returns length of largest possible set disregarding whitespace or the "," delimiters to be consistent with the ODBC driver. ([Bug#22613](#))
- Added new `_ci` collations to `CharsetMapping` - `utf8_unicode_ci` not working. ([Bug#22456](#))
- Driver was using milliseconds for `Statement.setQueryTimeout()` when specification says argument is to be in seconds. ([Bug#22359](#))
- Workaround for server crash when calling stored procedures via a server-side prepared statement (driver now detects prepare(stored procedure) and substitutes client-side prepared statement). ([Bug#22297](#))
- Driver issues truncation on write exception when it shouldn't (due to sending big decimal incorrectly to server with server-side prepared statement). ([Bug#22290](#))
- Newlines causing whitespace to span confuse procedure parser when getting parameter metadata for stored procedures. ([Bug#22024](#))
- When using `information_schema` for metadata, `COLUMN_SIZE` for `getColumns()` is not clamped to range of `java.lang.Integer`

as is the case when not using `information_schema`, thus leading to a truncation exception that isn't present when not using `information_schema`. ([Bug#21544](#))

- Column names don't match metadata in cases where server doesn't return original column names (column functions) thus breaking compatibility with applications that expect 1-1 mappings between `findColumn()` and `rsmd.getColumnname()`, usually manifests itself as "Can't find column ()" exceptions. ([Bug#21379](#))
- Driver now sends numeric 1 or 0 for client-prepared statement `setBoolean()` calls instead of '1' or '0'.
- Fixed configuration property `jdbcCompliantTruncation` was not being used for reads of result set values.
- `DatabaseMetaData` correctly reports `true` for `supportsCatalog*` () methods.
- Driver now supports `{call sp}` (without "()") if procedure has no arguments).

### C.7.2.6. Changes in MySQL Connector/J 5.0.3 (26 July 2006 beta)

Functionality added or changed:

- Added configuration option `noAccessToProcedureBodies` which will cause the driver to create basic parameter metadata for `CallableStatements` when the user does not have access to procedure bodies via `SHOW CREATE PROCEDURE` or selecting from `mysql.proc` instead of throwing an exception. The default value for this option is `false`

Bugs fixed:

- Fixed `Statement.cancel()` causes `NullPointerException` if underlying connection has been closed due to server failure. ([Bug#20650](#))
- If the connection to the server has been closed due to a server failure, then the cleanup process will call `Statement.cancel()`, triggering a `NullPointerException`, even though there is no active connection. ([Bug#20650](#))

### C.7.2.7. Changes in MySQL Connector/J 5.0.2 (11 July 2006)

Bugs fixed:

- `MysqlXaConnection.recover(int flags)` now allows combinations of `XAResource.TMSTARTRSCAN` and `TMENDRSCAN`. To simulate the "scanning" nature of the interface, we return all prepared XIDs for `TMSTARTRSCAN`, and no new XIDs for calls with `TMNOFLAGS`, or `TMENDRSCAN` when not in combination with `TMSTARTRSCAN`. This change was made for API compliance, as well as integration with IBM WebSphere's transaction manager. ([Bug#20242](#))
- Fixed `MysqlValidConnectionChecker` for JBoss doesn't work with `MySQLXADataSources`. ([Bug#20242](#))
- Added connection/datasource property `pinGlobalTxToPhysicalConnection` (defaults to `false`). When set to `true`, when using `XAConnections`, the driver ensures that operations on a given XID are always routed to the same physical connection. This allows the `XAConnection` to support `XA START ... JOIN` after `XA END` has been called, and is also a workaround for transaction managers that don't maintain thread affinity for a global transaction (most either always maintain thread affinity, or have it as a configuration option). ([Bug#20242](#))
- Better caching of character set converters (per-connection) to remove a bottleneck for multibyte character sets. ([Bug#20242](#))
- Fixed `ConnectionProperties` (and thus some subclasses) are not serializable, even though some J2EE containers expect them to be. ([Bug#19169](#))
- Fixed driver fails on non-ASCII platforms. The driver was assuming that the platform character set would be a superset of MySQL's `latin1` when doing the handshake for authentication, and when reading error messages. We now use Cp1252 for all strings sent to the server during the handshake phase, and a hard-coded mapping of the `language` system variable to the character set that is used for error messages. ([Bug#18086](#))
- Fixed can't use `XAConnection` for local transactions when no global transaction is in progress. ([Bug#17401](#))

### C.7.2.8. Changes in MySQL Connector/J 5.0.1 (Not Released)

Not released due to a packaging error

## C.7.2.9. Changes in MySQL Connector/J 5.0.0 (22 December 2005)

Bugs fixed:

- Added support for Connector/MXJ integration via url subprotocol `jdbc:mysql:mxj://...` (Bug#14729)
- Idle timeouts cause `XAConnections` to whine about rolling themselves back. (Bug#14729)
- When fix for Bug#14562 was merged from 3.1.12, added functionality for `CallableStatement`'s parameter metadata to return correct information for `.getParameterClassName()`. (Bug#14729)
- Added service-provider entry to `META-INF/services/java.sql.Driver` for JDBC-4.0 support. (Bug#14729)
- Fuller synchronization of `Connection` to avoid deadlocks when using multithreaded frameworks that multithread a single connection (usually not recommended, but the JDBC spec allows it anyways), part of fix to Bug#14972). (Bug#14729)
- Moved all `SQLException` constructor usage to a factory in `SQLException` (ground-work for JDBC-4.0 `SQLState`-based exception classes). (Bug#14729)
- Removed Java5-specific calls to `BigDecimal` constructor (when result set value is `'', (int)0` was being used as an argument indirectly via method return value. This signature doesn't exist prior to Java5.) (Bug#14729)
- Implementation of `Statement.cancel()` and `Statement.setQueryTimeout()`. Both require MySQL-5.0.0 or newer server, require a separate connection to issue the `KILL QUERY` statement, and in the case of `setQueryTimeout()` creates an additional thread to handle the timeout functionality.

Note: Failures to cancel the statement for `setQueryTimeout()` may manifest themselves as `RuntimeExceptions` rather than failing silently, as there is currently no way to unblock the thread that is executing the query being cancelled due to timeout expiration and have it throw the exception instead. (Bug#14729)

- Return "[VAR]BINARY" for `RSMD.getColumnTypeName()` when that is actually the type, and it can be distinguished (MySQL-4.1 and newer). (Bug#14729)
- Attempt detection of the MySQL type `BINARY` (it is an alias, so this isn't always reliable), and use the `java.sql.Types.BINARY` type mapping for it.
- Added unit tests for `XADatasource`, as well as friendlier exceptions for XA failures compared to the "stock" `XAException` (which has no messages).
- If the connection `useTimezone` is set to `true`, then also respect time zone conversions in escape-processed string literals (for example, `"{ts ...}"` and `"{t ...}"`).
- Don't allow `.setAutoCommit(true)`, or `.commit()` or `.rollback()` on an XA-managed connection as per the JDBC specification.
- `XADatasource` implemented (ported from 3.2 branch which won't be released as a product). Use `com.mysql.jdbc.jdbc2.optional.MysqlXADataSource` as your datasource class name in your application server to utilize XA transactions in MySQL-5.0.10 and newer.
- Moved `-bin-g.jar` file into separate `debug` subdirectory to avoid confusion.
- Return original column name for `RSMD.getColumnLabel()` if the column was aliased, alias name for `.getColumnLabel()` (if aliased), and original table name for `.getTableName()`. Note this only works for MySQL-4.1 and newer, as older servers don't make this information available to clients.
- Setting `useJDBCCompliantTimezoneShift=true` (it is not the default) causes the driver to use GMT for *all* `TIMESTAMP/DATETIME` time zones, and the current VM time zone for any other type that refers to time zones. This feature can not be used when `useTimezone=true` to convert between server and client time zones.
- `PreparedStatement.setString()` didn't work correctly when `sql_mode` on server contained `NO_BACKSLASH_ESCAPES` and no characters that needed escaping were present in the string.
- Add one level of indirection of internal representation of `CallableStatement` parameter metadata to avoid class not found issues on JDK-1.3 for `ParameterMetadata` interface (which doesn't exist prior to JDBC-3.0).

## C.7.3. Changes in MySQL Connector/J 3.1.x

### C.7.3.1. Changes in MySQL Connector/J 3.1.15 (Not yet released)

**Important change:** Due to a number of issues with the use of server-side prepared statements, Connector/J 5.0.5 has disabled their use by default. The disabling of server-side prepared statements does not affect the operation of the connector in any way.

To enable server-side prepared statements you must add the following configuration property to your connector string:

```
useServerPrepStmts=true
```

The default value of this property is `false` (that is, Connector/J does not use server-side prepared statements).

Bugs fixed:

- Specifying `US-ASCII` as the character set in a connection to a MySQL 4.1 or newer server does not map correctly. ([Bug#24840](#))

### C.7.3.2. Changes in MySQL Connector/J 3.1.14 (10-19-2006)

Bugs fixed:

- Check and store value for `continueBatchOnError` property in constructor of `Statements`, rather than when executing batches, so that Connections closed out from underneath statements don't cause `NullPointerExceptions` when it is required to check this property. ([Bug#22290](#))
- Fixed [Bug#18258](#) - `DatabaseMetaData.getTables()`, `columns()` with bad catalog parameter threw exception rather than return empty result set (as required by spec). ([Bug#22290](#))
- Driver now sends numeric 1 or 0 for client-prepared statement `setBoolean()` calls instead of '1' or '0'. ([Bug#22290](#))
- Fixed bug where driver would not advance to next host if `roundRobinLoadBalance=true` and the last host in the list is down. ([Bug#22290](#))
- Driver issues truncation on write exception when it shouldn't (due to sending big decimal incorrectly to server with server-side prepared statement). ([Bug#22290](#))
- Fixed bug when calling stored functions, where parameters weren't numbered correctly (first parameter is now the return value, subsequent parameters if specified start at index "2"). ([Bug#22290](#))
- Removed logger autodetection altogether, must now specify logger explicitly if you want to use a logger other than one that logs to `STDERR`. ([Bug#21207](#))
- `DDriver` throws `NPE` when tracing prepared statements that have been closed (in `asSQL()`). ([Bug#21207](#))
- `ResultSet.getSomeInteger()` doesn't work for `BIT(>1)`. ([Bug#21062](#))
- Escape of quotes in client-side prepared statements parsing not respected. Patch covers more than bug report, including `NO_BACKSLASH_ESCAPES` being set, and stacked quote characters forms of escaping (that is, " or "). ([Bug#20888](#))
- Fixed can't pool server-side prepared statements, exception raised when re-using them. ([Bug#20687](#))
- Fixed Updatable result set that contains a `BIT` column fails when server-side prepared statements are used. ([Bug#20485](#))
- Fixed updatable result set throws `ClassCastException` when there is row data and `moveToInsertRow()` is called. ([Bug#20479](#))
- Fixed `ResultSet.getShort()` for `UNSIGNED TINYINT` returns incorrect values when using server-side prepared statements. ([Bug#20306](#))
- `ReplicationDriver` does not always round-robin load balance depending on URL used for slaves list. ([Bug#19993](#))
- Fixed calling `toString()` on `ResultSetMetaData` for driver-generated (that is, from `DatabaseMetaData` method calls, or from `GeneratedKeys()`) result sets would raise a `NullPointerException`. ([Bug#19993](#))
- Connection fails to localhost when using timeout and IPv6 is configured. ([Bug#19726](#))
- `ResultSet.getFloatFromString()` can't retrieve values near `Float.MIN/MAX_VALUE`. ([Bug#18880](#))
- Fixed memory leak with `profileSQL=true`. ([Bug#16987](#))
- Fixed `NullPointerException` in `MySQLDataSourceFactory` due to `Reference` containing `RefAddr`s with null content. ([Bug#16791](#))

### C.7.3.3. Changes in MySQL Connector/J 3.1.13 (26 May 2006)

Bugs fixed:

- Fixed `PreparedStatement.setObject(int, Object, int)` doesn't respect scale of `BigDecimal`s. (Bug#19615)
- Fixed `ResultSet.isNull()` returns incorrect value when extracting native string from server-side prepared statement generated result set. (Bug#19282)
- Fixed invalid classname returned for `ResultSetMetaData.getColumnClassName()` for `BIGINT` type. (Bug#19282)
- Fixed case where driver wasn't reading server status correctly when fetching server-side prepared statement rows, which in some cases could cause warning counts to be off, or multiple result sets to not be read off the wire. (Bug#19282)
- Fixed data truncation and `getWarnings()` only returns last warning in set. (Bug#18740)
- Fixed aliased column names where length of name > 251 are corrupted. (Bug#18554)
- Improved performance of retrieving `BigDecimal`, `Time`, `Timestamp` and `Date` values from server-side prepared statements by creating fewer short-lived instances of `Strings` when the native type is not an exact match for the requested type. (Bug#18496)
- Added performance feature, re-writing of batched executes for `Statement.executeBatch()` (for all DML statements) and `PreparedStatement.executeBatch()` (for INSERTs with VALUE clauses only). Enable by using "rewrite-BatchedStatements=true" in your JDBC URL. (Bug#18041)
- Fixed issue where server-side prepared statements don't cause truncation exceptions to be thrown when truncation happens. (Bug#18041)
- Fixed `CallableStatement.registerOutParameter()` not working when some parameters pre-populated. Still waiting for feedback from JDBC experts group to determine what correct parameter count from `getMetaData()` should be, however. (Bug#17898)
- Fixed calling `clearParameters()` on a closed prepared statement causes NPE. (Bug#17587)
- Map "latin1" on MySQL server to CP1252 for MySQL > 4.1.0. (Bug#17587)
- Added additional accessor and mutator methods on `ConnectionProperties` so that `DataSource` users can use same naming as regular URL properties. (Bug#17587)
- Fixed `ResultSet.isNull()` not always reset correctly for booleans when done via conversion for server-side prepared statements. (Bug#17450)
- Fixed `Statement.getGeneratedKeys()` throws `NullPointerException` when no query has been processed. (Bug#17099)
- Fixed updatable result set doesn't return `AUTO_INCREMENT` values for `insertRow()` when multiple column primary keys are used. (the driver was checking for the existence of single-column primary keys and an autoincrement value > 0 instead of a straightforward `isAutoIncrement()` check). (Bug#16841)
- `DBMD.getColumns()` returns wrong type for `BIT`. (Bug#15854)
- `lib-nodist` directory missing from package breaks out-of-box build. (Bug#15676)
- Fixed issue with `ReplicationConnection` incorrectly copying state, doesn't transfer connection context correctly when transitioning between the same read-only states. (Bug#15570)
- No "dos" character set in MySQL > 4.1.0. (Bug#15544)
- `INOUT` parameter does not store `IN` value. (Bug#15464)
- `PreparedStatement.setObject()` serializes `BigInteger` as object, rather than sending as numeric value (and is thus not complementary to `getObject()` on an `UNSIGNED LONG` type). (Bug#15383)
- Fixed issue where driver was unable to initialize character set mapping tables. Removed reliance on `.properties` files to hold this information, as it turns out to be too problematic to code around class loader hierarchies that change depending on how an application is deployed. Moved information back into the `CharsetMapping` class. (Bug#14938)

- Exception thrown for new decimal type when using updatable result sets. ([Bug#14609](#))
- Driver now aware of fix for `BIT` type metadata that went into MySQL-5.0.21 for server not reporting length consistently. ([Bug#13601](#))
- Added support for Apache Commons logging, use `"com.mysql.jdbc.log.CommonsLogger"` as the value for the `"logger"` configuration property. ([Bug#13469](#))
- Fixed driver trying to call methods that don't exist on older and newer versions of Log4j. The fix is not trying to auto-detect presence of log4j, too many different incompatible versions out there in the wild to do this reliably.  
  
If you relied on autodetection before, you will need to add `"logger=com.mysql.jdbc.log.Log4JLogger"` to your JDBC URL to enable Log4J usage, or alternatively use the new `"CommonsLogger"` class to take care of this. ([Bug#13469](#))
- LogFactory now prepends `"com.mysql.jdbc.log"` to log class name if it can't be found as-specified. This allows you to use "short names" for the built-in log factories, for example `"logger=CommonsLogger"` instead of `"logger=com.mysql.jdbc.log.CommonsLogger"`. ([Bug#13469](#))
- `ResultSet.getShort()` for `UNSIGNED TINYINT` returned wrong values. ([Bug#11874](#))

### C.7.3.4. Changes in MySQL Connector/J 3.1.12 (30 November 2005)

Bugs fixed:

- Process escape tokens in `Connection.prepareStatement(...)`. You can disable this behavior by setting the JDBC URL configuration property `processEscapeCodesForPrepStmts` to `false`. ([Bug#15141](#))
- Usage advisor complains about unreferenced columns, even though they've been referenced. ([Bug#15065](#))
- Driver incorrectly closes streams passed as arguments to `PreparedStatement`s. Reverts to legacy behavior by setting the JDBC configuration property `autoClosePstmtStreams` to `true` (also included in the 3-0-Compat configuration "bundle"). ([Bug#15024](#))
- Deadlock while closing server-side prepared statements from multiple threads sharing one connection. ([Bug#14972](#))
- Unable to initialize character set mapping tables (due to J2EE classloader differences). ([Bug#14938](#))
- Escape processor replaces quote character in quoted string with string delimiter. ([Bug#14909](#))
- `DatabaseMetaData.getColumns()` doesn't return `TABLE_NAME` correctly. ([Bug#14815](#))
- `storesMixedCaseIdentifiers()` returns `false` ([Bug#14562](#))
- `storesLowerCaseIdentifiers()` returns `true` ([Bug#14562](#))
- `storesMixedCaseQuotedIdentifiers()` returns `false` ([Bug#14562](#))
- `storesMixedCaseQuotedIdentifiers()` returns `true` ([Bug#14562](#))
- If `lower_case_table_names=0` (on server):
  - `storesLowerCaseIdentifiers()` returns `false`
  - `storesLowerCaseQuotedIdentifiers()` returns `false`
  - `storesMixedCaseIdentifiers()` returns `true`
  - `storesMixedCaseQuotedIdentifiers()` returns `true`
  - `storesUpperCaseIdentifiers()` returns `false`
  - `storesUpperCaseQuotedIdentifiers()` returns `true`([Bug#14562](#))
- `storesUpperCaseIdentifiers()` returns `false` ([Bug#14562](#))
- `storesUpperCaseQuotedIdentifiers()` returns `true` ([Bug#14562](#))
- If `lower_case_table_names=1` (on server):



- `storesLowerCaseIdentifiers()` returns `true`
  - `storesLowerCaseQuotedIdentifiers()` returns `true`
  - `storesMixedCaseIdentifiers()` returns `false`
  - `storesMixedCaseQuotedIdentifiers()` returns `false`
  - `storesUpperCaseIdentifiers()` returns `false`
  - `storesUpperCaseQuotedIdentifiers()` returns `true`
- (Bug#14562)
- `storesLowerCaseQuotedIdentifiers()` returns `true` (Bug#14562)
  - Fixed `DatabaseMetaData.stores*Identifiers()`:
    - If `lower_case_table_names=0` (on server):
      - `storesLowerCaseIdentifiers()` returns `false`
      - `storesLowerCaseQuotedIdentifiers()` returns `false`
      - `storesMixedCaseIdentifiers()` returns `true`
      - `storesMixedCaseQuotedIdentifiers()` returns `true`
      - `storesUpperCaseIdentifiers()` returns `false`
      - `storesUpperCaseQuotedIdentifiers()` returns `true`
    - If `lower_case_table_names=1` (on server):
      - `storesLowerCaseIdentifiers()` returns `true`
      - `storesLowerCaseQuotedIdentifiers()` returns `true`
      - `storesMixedCaseIdentifiers()` returns `false`
      - `storesMixedCaseQuotedIdentifiers()` returns `false`
      - `storesUpperCaseIdentifiers()` returns `false`
      - `storesUpperCaseQuotedIdentifiers()` returns `true`
- (Bug#14562)
- `storesMixedCaseIdentifiers()` returns `true` (Bug#14562)
  - `storesLowerCaseQuotedIdentifiers()` returns `false` (Bug#14562)
  - Java type conversion may be incorrect for `MEDIUMINT`. (Bug#14562)
  - `storesLowerCaseIdentifiers()` returns `false` (Bug#14562)
  - Added configuration property `useGmtMillisForDatetimes` which when set to `true` causes `ResultSet.getDate()`, `ResultSet.getTimestamp()` to return correct millis-since GMT when `ResultSet.getTime()` is called on the return value (currently default is `false` for legacy behavior). (Bug#14562)
  - Extraneous sleep on `autoReconnect`. (Bug#13775)
  - Reconnect during middle of `executeBatch()` should not occur if `autoReconnect` is enabled. (Bug#13255)
  - `maxQuerySizeToLog` is not respected. Added logging of bound values for `execute()` phase of server-side prepared statements when `profileSQL=true` as well. (Bug#13048)
  - OpenOffice expects `DBMD.supportsIntegrityEnhancementFacility()` to return `true` if foreign keys are supported by the datasource, even though this method also covers support for check constraints, which MySQL *doesn't* have. Setting the configuration property `overrideSupportsIntegrityEnhancementFacility` to `true` causes the driver to return `true` for this method. (Bug#12975)
-

- Added `com.mysql.jdbc.testsuite.url.default` system property to set default JDBC url for testsuite (to speed up bug resolution when I'm working in Eclipse). (Bug#12975)
- `logSlowQueries` should give better info. (Bug#12230)
- Don't increase timeout for failover/reconnect. (Bug#6577)
- Fixed client-side prepared statement bug with embedded `?` characters inside quoted identifiers (it was recognized as a placeholder, when it was not).
- Don't allow `executeBatch()` for `CallableStatements` with registered `OUT/INOUT` parameters (JDBC compliance).
- Fall back to platform-encoding for `URLDecoder.decode()` when parsing driver URL properties if the platform doesn't have a two-argument version of this method.

### C.7.3.5. Changes in MySQL Connector/J 3.1.11 (07 October 2005)

Bugs fixed:

- The configuration property `sessionVariables` now allows you to specify variables that start with the “@” sign. (Bug#13453)
- URL configuration parameters don't allow “&” or “=” in their values. The JDBC driver now parses configuration parameters as if they are encoded using the application/x-www-form-urlencoded format as specified by `java.net.URLDecoder` (<http://java.sun.com/j2se/1.5.0/docs/api/java/net/URLDecoder.html>).  
If the “%” character is present in a configuration property, it must now be represented as `%25`, which is the encoded form of “%” when using application/x-www-form-urlencoded encoding. (Bug#13453)
- Workaround for Bug#13374: `ResultSet.getStatement()` on closed result set returns `NULL` (as per JDBC 4.0 spec, but not backward-compatible). Set the connection property `retainStatementAfterResultSetClose` to `true` to be able to retrieve a `ResultSet`'s statement after the `ResultSet` has been closed via `.getStatement()` (the default is `false`, to be JDBC-compliant and to reduce the chance that code using JDBC leaks `Statement` instances). (Bug#13277)
- `ResultSetMetaData` from `Statement.getGeneratedKeys()` caused a `NullPointerException` to be thrown whenever a method that requires a connection reference was called. (Bug#13277)
- Backport of `VAR[BINARY|CHAR] [BINARY]` types detection from 5.0 branch. (Bug#13277)
- Fixed `NullPointerException` when converting `catalog` parameter in many `DatabaseMetaDataMethods` to `byte[]`s (for the result set) when the parameter is `null`. (`null` isn't technically allowed by the JDBC specification, but we've historically allowed it). (Bug#13277)
- Backport of `Field` class, `ResultSetMetaData.getColumnClassName()`, and `ResultSet.getObject(int)` changes from 5.0 branch to fix behavior surrounding `VARCHAR BINARY/VARBINARY` and related types. (Bug#13277)
- Read response in `MysqlIO.sendFileToServer()`, even if the local file can't be opened, otherwise next query issued will fail, because it is reading the response to the empty `LOAD DATA INFILE` packet sent to the server. (Bug#13277)
- When `gatherPerfMetrics` is enabled for servers older than 4.1.0, a `NullPointerException` is thrown from the constructor of `ResultSet` if the query doesn't use any tables. (Bug#13043)
- `java.sql.Types.OTHER` returned for `BINARY` and `VARBINARY` columns when using `DatabaseMetaData.getColumns()`. (Bug#12970)
- `ServerPreparedStatement.getBinding()` now checks if the statement is closed before attempting to reference the list of parameter bindings, to avoid throwing a `NullPointerException`. (Bug#12970)
- Tokenizer for `=` in URL properties was causing `sessionVariables=...` to be parameterized incorrectly. (Bug#12753)
- `cp1251` incorrectly mapped to `win1251` for servers newer than 4.0.x. (Bug#12752)
- `getExportedKeys()` (Bug#12541)
- Specifying a catalog works as stated in the API docs. (Bug#12541)
- Specifying `NULL` means that catalog will not be used to filter the results (thus all databases will be searched), unless you've set `nullCatalogMeansCurrent=true` in your JDBC URL properties. (Bug#12541)



- `getIndexInfo()` ([Bug#12541](#))
- `getProcedures()` (and thus indirectly `getProcedureColumns()`) ([Bug#12541](#))
- `getImportedKeys()` ([Bug#12541](#))
- Specifying "" means “current” catalog, even though this isn't quite JDBC spec compliant, it is there for legacy users. ([Bug#12541](#))
- `getCrossReference()` ([Bug#12541](#))
- Added `Connection.isMasterConnection()` for clients to be able to determine if a multi-host master/slave connection is connected to the first host in the list. ([Bug#12541](#))
- `getColumns()` ([Bug#12541](#))
- Handling of catalog argument in `DatabaseMetaData.getIndexInfo()`, which also means changes to the following methods in `DatabaseMetaData`:
  - `getBestRowIdentifier()`
  - `getColumns()`
  - `getCrossReference()`
  - `getExportedKeys()`
  - `getImportedKeys()`
  - `getIndexInfo()`
  - `getPrimaryKeys()`
  - `getProcedures()` (and thus indirectly `getProcedureColumns()`)
  - `getTables()`

The `catalog` argument in all of these methods now behaves in the following way:

- Specifying `NULL` means that catalog will not be used to filter the results (thus all databases will be searched), unless you've set `nullCatalogMeansCurrent=true` in your JDBC URL properties.
- Specifying "" means “current” catalog, even though this isn't quite JDBC spec compliant, it is there for legacy users.
- Specifying a catalog works as stated in the API docs.
- Made `Connection.clientPrepare()` available from “wrapped” connections in the `jdbc2.optional` package (connections built by `ConnectionPoolDataSource` instances). ([Bug#12541](#))
- `getBestRowIdentifier()` ([Bug#12541](#))
- Made `Connection.clientPrepare()` available from “wrapped” connections in the `jdbc2.optional` package (connections built by `ConnectionPoolDataSource` instances). ([Bug#12541](#))
- `getTables()` ([Bug#12541](#))
- `getPrimaryKeys()` ([Bug#12541](#))
- `Connection.prepareCall()` is database name case-sensitive (on Windows systems). ([Bug#12417](#))
- `explainSlowQueries` hangs with server-side prepared statements. ([Bug#12229](#))
- Properties shared between master and slave with replication connection. ([Bug#12218](#))
- Geometry types not handled with server-side prepared statements. ([Bug#12104](#))
- `maxPerformance.properties` mis-spells “`elideSetAutoCommits`”. ([Bug#11976](#))
- `ReplicationConnection` won't switch to slave, throws “Catalog can't be null” exception. ([Bug#11879](#))

- `Pstmt.setObject(..., Types.BOOLEAN)` throws exception. (Bug#11798)
- Escape tokenizer doesn't respect stacked single quotes for escapes. (Bug#11797)
- `GEOMETRY` type not recognized when using server-side prepared statements. (Bug#11797)
- Foreign key information that is quoted is parsed incorrectly when `DatabaseMetaData` methods use that information. (Bug#11781)
- The `sendBlobChunkSize` property is now clamped to `max_allowed_packet` with consideration of stream buffer size and packet headers to avoid `PacketTooBigExceptions` when `max_allowed_packet` is similar in size to the default `sendBlobChunkSize` which is 1M. (Bug#11781)
- `CallableStatement.clearParameters()` now clears resources associated with `INOUT/OUTPUT` parameters as well as `INPUT` parameters. (Bug#11781)
- Fixed regression caused by fix for Bug#11552 that caused driver to return incorrect values for unsigned integers when those integers were within the range of the positive signed type. (Bug#11663)
- Moved source code to Subversion repository. (Bug#11663)
- Incorrect generation of testcase scripts for server-side prepared statements. (Bug#11663)
- Fixed statements generated for testcases missing `;` for "plain" statements. (Bug#11629)
- Spurious `!` on console when character encoding is `utf8`. (Bug#11629)
- `StringUtils.getBytes()` doesn't work when using multi-byte character encodings and a length in *characters* is specified. (Bug#11614)
- `DBMD.storesLower/Mixed/UpperIdentifiers()` reports incorrect values for servers deployed on Windows. (Bug#11575)
- Reworked `Field` class, `*Buffer`, and `MysqlIO` to be aware of field lengths  $> Integer.MAX\_VALUE$ . (Bug#11498)
- Escape processor didn't honor strings demarcated with double quotes. (Bug#11498)
- Updated `DBMD.supportsCorrelatedQueries()` to return `true` for versions  $> 4.1$ , `supportsGroupByUnrelated()` to return `true` and `getResultSetHoldability()` to return `HOLD_CURSORS_OVER_COMMIT`. (Bug#11498)
- Lifted restriction of changing streaming parameters with server-side prepared statements. As long as *all* streaming parameters were set before execution, `.clearParameters()` does not have to be called. (due to limitation of client/server protocol, prepared statements can not reset *individual* stream data on the server side). (Bug#11498)
- `ResultSet.moveToCurrentRow()` fails to work when preceded by a call to `ResultSet.moveToInsertRow()`. (Bug#11190)
- `VARBINARY` data corrupted when using server-side prepared statements and `.setBytes()`. (Bug#11115)
- `Statement.getWarnings()` fails with NPE if statement has been closed. (Bug#10630)
- Only get `char[]` from SQL in `PreparedStatement.ParseInfo()` when needed. (Bug#10630)

### C.7.3.6. Changes in MySQL Connector/J 3.1.10 (23 June 2005)

Bugs fixed:

- Initial implementation of `ParameterMetadata` for `PreparedStatement.getParameterMetadata()`. Only works fully for `CallableStatements`, as current server-side prepared statements return every parameter as a `VARCHAR` type.
- Fixed connecting without a database specified raised an exception in `MysqlIO.changeDatabaseTo()`.

### C.7.3.7. Changes in MySQL Connector/J 3.1.9 (22 June 2005)

Bugs fixed:

- Production package doesn't include JBoss integration classes. (Bug#11411)
- Removed nonsensical “costly type conversion” warnings when using usage advisor. (Bug#11411)
- Fixed `PreparedStatement.setClob()` not accepting `null` as a parameter. (Bug#11360)
- Connector/J dumping query into `SQLException` twice. (Bug#11360)
- `autoReconnect` ping causes exception on connection startup. (Bug#11259)
- `Connection.setCatalog()` is now aware of the `useLocalSessionState` configuration property, which when set to `true` will prevent the driver from sending `USE ...` to the server if the requested catalog is the same as the current catalog. (Bug#11115)
- `3-0-Compat` — Compatibility with Connector/J 3.0.x functionality (Bug#11115)
- `maxPerformance` — maximum performance without being reckless (Bug#11115)
- `solarisMaxPerformance` — maximum performance for Solaris, avoids syscalls where it can (Bug#11115)
- Added `maintainTimeStats` configuration property (defaults to `true`), which tells the driver whether or not to keep track of the last query time and the last successful packet sent to the server's time. If set to `false`, removes two syscalls per query. (Bug#11115)
- `VARBINARY` data corrupted when using server-side prepared statements and `ResultSet.getBytes()`. (Bug#11115)
- Added the following configuration bundles, use one or many via the `useConfigs` configuration property:
  - `maxPerformance` — maximum performance without being reckless
  - `solarisMaxPerformance` — maximum performance for Solaris, avoids syscalls where it can
  - `3-0-Compat` — Compatibility with Connector/J 3.0.x functionality(Bug#11115)
- Try to handle `OutOfMemoryErrors` more gracefully. Although not much can be done, they will in most cases close the connection they happened on so that further operations don't run into a connection in some unknown state. When an OOM has happened, any further operations on the connection will fail with a “Connection closed” exception that will also list the OOM exception as the reason for the implicit connection close event. (Bug#10850)
- Setting `cachePrepStmts=true` now causes the `Connection` to also cache the check the driver performs to determine if a prepared statement can be server-side or not, as well as caches server-side prepared statements for the lifetime of a connection. As before, the `prepStmtCacheSize` parameter controls the size of these caches. (Bug#10850)
- Don't send `COM_RESET_STMT` for each execution of a server-side prepared statement if it isn't required. (Bug#10850)
- 0-length streams not sent to server when using server-side prepared statements. (Bug#10850)
- Driver detects if you're running MySQL-5.0.7 or later, and does not scan for `LIMIT ?[ , ?]` in statements being prepared, as the server supports those types of queries now. (Bug#10850)
- Reorganized directory layout. Sources now are in `src` folder. Don't pollute parent directory when building, now output goes to `./build`, distribution goes to `./dist`. (Bug#10496)
- Added support/bug hunting feature that generates `.sql` test scripts to `STDERR` when `autoGenerateTestcaseScript` is set to `true`. (Bug#10496)
- `SQLException` is thrown when using property `characterSetResults` with `cp932` or `eucljms`. (Bug#10496)
- The datatype returned for `TINYINT(1)` columns when `tinyIntIsBit=true` (the default) can be switched between `Types.BOOLEAN` and `Types.BIT` using the new configuration property `transformedBitIsBoolean`, which defaults to `false`. If set to `false` (the default), `DatabaseMetaData.getColumns()` and `ResultSetMetaData.getColumnType()` will return `Types.BOOLEAN` for `TINYINT(1)` columns. If `true`, `Types.BOOLEAN` will be returned instead. Regardless of this configuration property, if `tinyIntIsBit` is enabled, columns with the type `TINYINT(1)` will be returned as `java.lang.Boolean` instances from `ResultSet.getObject(...)`, and `ResultSetMetaData.getColumnClassName()` will return `java.lang.Boolean`. (Bug#10485)
- `SQLException` thrown when retrieving `YEAR(2)` with `ResultSet.getString()`. The driver will now always treat `YEAR` types as `java.sql.Dates` and return the correct values for `getString()`. Alternatively, the `yearIsDateType` connection property can be set to `false` and the values will be treated as `SHORTs`. (Bug#10485)

- Driver doesn't support `{?=CALL( . . . )}` for calling stored functions. This involved adding support for function retrieval to `DatabaseMetaData.getProcedures()` and `getProcedureColumns()` as well. (Bug#10310)
- Unsigned `SMALLINT` treated as signed for `ResultSet.getInt()`, fixed all cases for `UNSIGNED` integer values and server-side prepared statements, as well as `ResultSet.getObject()` for `UNSIGNED TINYINT`. (Bug#10156)
- Made `ServerPreparedStatement.asSql()` work correctly so auto-explain functionality would work with server-side prepared statements. (Bug#10155)
- Double quotes not recognized when parsing client-side prepared statements. (Bug#10155)
- Made JDBC2-compliant wrappers public in order to allow access to vendor extensions. (Bug#10155)
- `DatabaseMetaData.supportsMultipleOpenResults()` now returns `true`. The driver has supported this for some time, DBMD just missed that fact. (Bug#10155)
- Cleaned up logging of profiler events, moved code to dump a profiler event as a string to `com.mysql.jdbc.log.LogUtils` so that third parties can use it. (Bug#10155)
- Made `enableStreamingResults()` visible on `com.mysql.jdbc.jdbc2.optional.StatementWrapper`. (Bug#10155)
- Actually write manifest file to correct place so it ends up in the binary jar file. (Bug#10144)
- Added `createDatabaseIfNotExist` property (default is `false`), which will cause the driver to ask the server to create the database specified in the URL if it doesn't exist. You must have the appropriate privileges for database creation for this to work. (Bug#10144)
- Memory leak in `ServerPreparedStatement` if `serverPrepare()` fails. (Bug#10144)
- `com.mysql.jdbc.PreparedStatement.ParseInfo` does unnecessary call to `toCharArray()`. (Bug#9064)
- Driver now correctly uses CP932 if available on the server for Windows-31J, CP932 and MS932 java encoding names, otherwise it resorts to SJIS, which is only a close approximation. Currently only MySQL-5.0.3 and newer (and MySQL-4.1.12 or .13, depending on when the character set gets backported) can reliably support any variant of CP932.
- Overhaul of character set configuration, everything now lives in a properties file.

### C.7.3.8. Changes in MySQL Connector/J 3.1.8 (14 April 2005)

Bugs fixed:

- Should accept `null` for catalog (meaning use current) in DBMD methods, even though it is not JDBC-compliant for legacy's sake. Disable by setting connection property `nullCatalogMeansCurrent` to `false` (which will be the default value in C/J 3.2.x). (Bug#9917)
- Fixed driver not returning `true` for `-1` when `ResultSet.getBoolean()` was called on result sets returned from server-side prepared statements. (Bug#9778)
- Added a `Manifest.MF` file with implementation information to the `.jar` file. (Bug#9778)
- More tests in `Field.isOpaqueBinary()` to distinguish opaque binary (that is, fields with type `CHAR(n)` and `CHARACTER SET BINARY`) from output of various scalar and aggregate functions that return strings. (Bug#9778)
- `DBMD.getTables()` shouldn't return tables if views are asked for, even if the database version doesn't support views. (Bug#9778)
- Should accept `null` for name patterns in DBMD (meaning “%”), even though it isn't JDBC compliant, for legacy's sake. Disable by setting connection property `nullNamePatternMatchesAll` to `false` (which will be the default value in C/J 3.2.x). (Bug#9769)
- The performance metrics feature now gathers information about number of tables referenced in a `SELECT`. (Bug#9704)
- The logging system is now automatically configured. If the value has been set by the user, via the URL property `logger` or the system property `com.mysql.jdbc.logger`, then use that, otherwise, autodetect it using the following steps:
  1. Log4j, if it is available,
  2. Then JDK1.4 logging,

3. Then fallback to our `STDERR` logging.

([Bug#9704](#))

- `Statement.getMoreResults()` could throw NPE when existing result set was `.close()`d. ([Bug#9704](#))
- Stored procedures with `DECIMAL` parameters with storage specifications that contained “,” in them would fail. ([Bug#9682](#))
- `PreparedStatement.setObject(int, Object, int type, int scale)` now uses scale value for `BigDecimal` instances. ([Bug#9682](#))
- Added support for the c3p0 connection pool's (<http://c3p0.sf.net/>) validation/connection checker interface which uses the light-weight `COM_PING` call to the server if available. To use it, configure your c3p0 connection pool's `connectionTesterClassName` property to use `com.mysql.jdbc.integration.c3p0.MySqlConnectionTester`. ([Bug#9320](#))
- `PreparedStatement.getMetaData()` inserts blank row in database under certain conditions when not using server-side prepared statements. ([Bug#9320](#))
- Better detection of `LIMIT` inside/outside of quoted strings so that the driver can more correctly determine whether a prepared statement can be prepared on the server or not. ([Bug#9320](#))
- `Connection.canHandleAsPreparedStatement()` now makes “best effort” to distinguish `LIMIT` clauses with placeholders in them from ones without in order to have fewer false positives when generating work-arounds for statements the server cannot currently handle as server-side prepared statements. ([Bug#9320](#))
- Fixed `build.xml` to not compile `log4j` logging if `log4j` not available. ([Bug#9320](#))
- Added finalizers to `ResultSet` and `Statement` implementations to be JDBC spec-compliant, which requires that if not explicitly closed, these resources should be closed upon garbage collection. ([Bug#9319](#))
- Stored procedures with same name in different databases confuse the driver when it tries to determine parameter counts/types. ([Bug#9319](#))
- A continuation of [Bug#8868](#), where functions used in queries that should return non-string types when resolved by temporary tables suddenly become opaque binary strings (work-around for server limitation). Also fixed fields with type of `CHAR(n) CHARACTER SET BINARY` to return correct/matching classes for `RSMD.getColumnClassName()` and `ResultSet.getObject()`. ([Bug#9236](#))
- Cannot use `UTF-8` for `characterSetResults` configuration property. ([Bug#9206](#))
- `PreparedStatement.addBatch()` doesn't work with server-side prepared statements and streaming `BINARY` data. ([Bug#9040](#))
- `ServerPreparedStatements` now correctly “stream” `BLOB/CLOB` data to the server. You can configure the threshold chunk size using the JDBC URL property `blobSendChunkSize` (the default is 1MB). ([Bug#8868](#))
- `DATE_FORMAT()` queries returned as `BLOBs` from `getObject()`. ([Bug#8868](#))
- Server-side session variables can be preset at connection time by passing them as a comma-delimited list for the connection property `sessionVariables`. ([Bug#8868](#))
- `BlobFromLocator` now uses correct identifier quoting when generating prepared statements. ([Bug#8868](#))
- Fixed regression in `ping()` for users using `autoReconnect=true`. ([Bug#8868](#))
- Check for empty strings (‘ ’) when converting `CHAR/VARCHAR` column data to numbers, throw exception if `emptyStringsConvertToZero` configuration property is set to `false` (for backward-compatibility with 3.0, it is now set to `true` by default, but will most likely default to `false` in 3.2). ([Bug#8803](#))
- `DATA_TYPE` column from `DBMD.getBestRowIdentifier()` causes `ArrayIndexOutOfBoundsException` when accessed (and in fact, didn't return any value). ([Bug#8803](#))
- `DBMD.supportsMixedCase*Identifiers()` returns wrong value on servers running on case-sensitive file systems. ([Bug#8800](#))
- `DBMD.supportsResultSetConcurrency()` not returning `true` for forward-only/read-only result sets (we obviously support this). ([Bug#8792](#))
- Fixed `ResultSet.getTime()` on a `NULL` value for server-side prepared statements throws NPE.

- Made `Connection.ping()` a public method.
- Added support for new precision-math `DECIMAL` type in MySQL 5.0.3 and up.
- Fixed `DatabaseMetaData.getTables()` returning views when they were not asked for as one of the requested table types.

### C.7.3.9. Changes in MySQL Connector/J 3.1.7 (18 February 2005)

Bugs fixed:

- `PreparedStatement` not creating streaming result sets. (Bug#8487)
- Don't pass `NULL` to `String.valueOf()` in `ResultSet.getNativeConvertToString()`, as it stringifies it (that is, returns `null`), which is not correct for the method in question. (Bug#8487)
- Fixed NPE in `ResultSet.realClose()` when using usage advisor and result set was already closed. (Bug#8428)
- `ResultSet.getString()` doesn't maintain format stored on server, bug fix only enabled when `noDatetimeStringSync` property is set to `true` (the default is `false`). (Bug#8428)
- Added support for `BIT` type in MySQL-5.0.3. The driver will treat `BIT(1-8)` as the JDBC standard `BIT` type (which maps to `java.lang.Boolean`), as the server does not currently send enough information to determine the size of a bitfield when < 9 bits are declared. `BIT(>9)` will be treated as `VARBINARY`, and will return `byte[]` when `getObject()` is called. (Bug#8424)
- Added `useLocalSessionState` configuration property, when set to `true` the JDBC driver trusts that the application is well-behaved and only sets autocommit and transaction isolation levels using the methods provided on `java.sql.Connection`, and therefore can manipulate these values in many cases without incurring round-trips to the database server. (Bug#8424)
- Added `enableStreamingResults()` to `Statement` for connection pool implementations that check `Statement.setFetchSize()` for specification-compliant values. Call `Statement.setFetchSize(>=0)` to disable the streaming results for that statement. (Bug#8424)
- `ResultSet.getBigDecimal()` throws exception when rounding would need to occur to set scale. The driver now chooses a rounding mode of “half up” if non-rounding `BigDecimal.setScale()` fails. (Bug#8424)
- Fixed synchronization issue with `ServerPreparedStatement.serverPrepare()` that could cause deadlocks/crashes if connection was shared between threads. (Bug#8096)
- Emulated locators corrupt binary data when using server-side prepared statements. (Bug#8096)
- Infinite recursion when “falling back” to master in failover configuration. (Bug#7952)
- Disable multi-statements (if enabled) for MySQL-4.1 versions prior to version 4.1.10 if the query cache is enabled, as the server returns wrong results in this configuration. (Bug#7952)
- Removed `dontUnpackBinaryResults` functionality, the driver now always stores results from server-side prepared statements as is from the server and unpacks them on demand. (Bug#7952)
- Fixed duplicated code in `configureClientCharset()` that prevented `useOldUTF8Behavior=true` from working properly. (Bug#7952)
- Added `holdResultsOpenOverStatementClose` property (default is `false`), that keeps result sets open over `statement.close()` or new execution on same statement (suggested by Kevin Burton). (Bug#7715)
- Detect new `sql_mode` variable in string form (it used to be integer) and adjust quoting method for strings appropriately. (Bug#7715)
- Timestamps converted incorrectly to strings with server-side prepared statements and updatable result sets. (Bug#7715)
- Timestamp key column data needed `_binary` stripped for `UpdatableResultSet.refreshRow()`. (Bug#7686)
- Choose correct “direction” to apply time adjustments when both client and server are in GMT time zone when using `ResultSet.get(..., cal)` and `PreparedStatement.set(..., cal)`. (Bug#4718)
- Remove `_binary` introducer from parameters used as in/out parameters in `CallableStatement`. (Bug#4718)



- Always return `byte[]`s for output parameters registered as `*BINARY`. (Bug#4718)
- By default, the driver now scans SQL you are preparing via all variants of `Connection.prepareStatement()` to determine if it is a supported type of statement to prepare on the server side, and if it is not supported by the server, it instead prepares it as a client-side emulated prepared statement. You can disable this by passing `emulateUnsupportedPstmts=false` in your JDBC URL. (Bug#4718)
- Added `dontTrackOpenResources` option (default is `false`, to be JDBC compliant), which helps with memory use for non-well-behaved apps (that is, applications that don't close `Statement` objects when they should). (Bug#4718)
- Send correct value for “boolean” `true` to server for `PreparedStatement.setObject(n, "true", Types.BIT)`. (Bug#4718)
- Fixed bug with `Connection` not caching statements from `prepareStatement()` when the statement wasn't a server-side prepared statement. (Bug#4718)

### C.7.3.10. Changes in MySQL Connector/J 3.1.6 (23 December 2004)

Bugs fixed:

- `DBMD.getProcedures()` doesn't respect catalog parameter. (Bug#7026)
- Fixed hang on `SocketInputStream.read()` with `Statement.setMaxRows()` and multiple result sets when driver has to truncate result set directly, rather than tacking a `LIMIT n` on the end of it.

### C.7.3.11. Changes in MySQL Connector/J 3.1.5 (02 December 2004)

Bugs fixed:

- Use 1MB packet for sending file for `LOAD DATA LOCAL INFILE` if that is `< max_allowed_packet` on server. (Bug#6537)
- `SUM()` on `DECIMAL` with server-side prepared statement ignores scale if zero-padding is needed (this ends up being due to conversion to `DOUBLE` by server, which when converted to a string to parse into `BigDecimal`, loses all “padding” zeros). (Bug#6537)
- Use `DatabaseMetaData.getIdentifierQuoteString()` when building DBMD queries. (Bug#6537)
- Use our own implementation of buffered input streams to get around blocking behavior of `java.io.BufferedInputStream`. Disable this with `useReadAheadInput=false`. (Bug#6399)
- Make auto-deserialization of `java.lang.Objects` stored in `BLOB` columns configurable via `autoDeserialize` property (defaults to `false`). (Bug#6399)
- `ResultSetMetaData.getColumnDisplaySize()` returns incorrect values for multi-byte charsets. (Bug#6399)
- Re-work `Field.isOpaqueBinary()` to detect `CHAR(n) CHARACTER SET BINARY` to support fixed-length binary fields for `ResultSet.getObject()`. (Bug#6399)
- Failing to connect to the server when one of the addresses for the given host name is IPV6 (which the server does not yet bind on). The driver now loops through *all* IP addresses for a given host, and stops on the first one that `accepts()` a `socket.connect()`. (Bug#6348)
- Removed unwanted new `Throwable()` in `ResultSet` constructor due to bad merge (caused a new object instance that was never used for every result set created). Found while profiling for Bug#6359. (Bug#6225)
- `ServerSidePreparedStatement` allocating short-lived objects unnecessarily. (Bug#6225)
- Use null-safe-equals for key comparisons in updatable result sets. (Bug#6225)
- Fixed too-early creation of `StringBuffer` in `EscapeProcessor.escapeSQL()`, also return `String` when escaping not needed (to avoid unnecessary object allocations). Found while profiling for Bug#6359. (Bug#6225)
- `UNSIGNED BIGINT` unpacked incorrectly from server-side prepared statement result sets. (Bug#5729)
- Added experimental configuration property `dontUnpackBinaryResults`, which delays unpacking binary result set values until they're asked for, and only creates object instances for non-numerical values (it is set to `false` by default). For some

usecase/jvm combinations, this is friendlier on the garbage collector. (Bug#5706)

- Don't throw exceptions for `Connection.releaseSavepoint()`. (Bug#5706)
- Inefficient detection of pre-existing string instances in `ResultSet.getNativeString()`. (Bug#5706)
- Use a per-session `Calendar` instance by default when decoding dates from `ServerPreparedStatements` (set to old, less performant behavior by setting property `dynamicCalendars=true`). (Bug#5706)
- Fixed batched updates with server prepared statements weren't looking if the types had changed for a given batched set of parameters compared to the previous set, causing the server to return the error "Wrong arguments to mysql\_stmt\_execute()". (Bug#5235)
- Handle case when string representation of timestamp contains trailing "." with no numbers following it. (Bug#5235)
- Server-side prepared statements did not honor `zeroDateTimeBehavior` property, and would cause class-cast exceptions when using `ResultSet.getObject()`, as the all-zero string was always returned. (Bug#5235)
- Fix comparisons made between string constants and dynamic strings that are converted with either `toUpperCase()` or `toLowerCase()` to use `Locale.ENGLISH`, as some locales "override" case rules for English. Also use `StringUtils.indexOfIgnoreCase()` instead of `toUpperCase().indexOf()`, avoids creating a very short-lived transient `String` instance.

### C.7.3.12. Changes in MySQL Connector/J 3.1.4 (04 September 2004)

Bugs fixed:

- Fixed `ServerPreparedStatement` to read prepared statement metadata off the wire, even though it is currently a placeholder instead of using `MysqlIO.clearInputStream()` which didn't work at various times because data wasn't available to read from the server yet. This fixes sporadic errors users were having with `ServerPreparedStatements` throwing `ArrayIndexOutOfBoundsExceptions`. (Bug#5032)
- Added three ways to deal with all-zero datetimes when reading them from a `ResultSet`: `exception` (the default), which throws an `SQLException` with an `SQLState` of `S1009`; `convertToNull`, which returns `NULL` instead of the date; and `round`, which rounds the date to the nearest closest value which is `'0001-01-01'`. (Bug#5032)
- The driver is more strict about truncation of numerics on `ResultSet.get*()`, and will throw an `SQLException` when truncation is detected. You can disable this by setting `jdbcCompliantTruncation` to `false` (it is enabled by default, as this functionality is required for JDBC compliance). (Bug#5032)
- You can now use URLs in `LOAD DATA LOCAL INFILE` statements, and the driver will use Java's built-in handlers for retrieving the data and sending it to the server. This feature is not enabled by default, you must set the `allowUrlInLocalInfile` connection property to `true`. (Bug#5032)
- `ResultSet.getObject()` doesn't return type `Boolean` for pseudo-bit types from prepared statements on 4.1.x (shortcut for avoiding extra type conversion when using binary-encoded result sets obscured test in `getObject()` for "pseudo" bit type). (Bug#5032)
- Use `com.mysql.jdbc.Message`'s classloader when loading resource bundle, should fix sporadic issues when the caller's classloader can't locate the resource bundle. (Bug#5032)
- `ServerPreparedStatements` dealing with return of `DECIMAL` type don't work. (Bug#5012)
- Track packet sequence numbers if `enablePacketDebug=true`, and throw an exception if packets received out-of-order. (Bug#4689)
- `ResultSet.isNull()` does not work for primitives if a previous `null` was returned. (Bug#4689)
- Optimized integer number parsing, enable "old" slower integer parsing using JDK classes via `useFastIntParsing=false` property. (Bug#4642)
- Added `useOnlyServerErrorMessages` property, which causes message text in exceptions generated by the server to only contain the text sent by the server (as opposed to the `SQLState`'s "standard" description, followed by the server's error message). This property is set to `true` by default. (Bug#4642)
- `ServerPreparedStatement.execute*()` sometimes threw `ArrayIndexOutOfBoundsException` when unpacking field metadata. (Bug#4642)
- Connector/J 3.1.3 beta does not handle integers correctly (caused by changes to support unsigned reads in `Buf-`



`fer.readInt() -> Buffer.readShort()`. (Bug#4510)

- Added support in `DatabaseMetaData.getTables()` and `getTableTypes()` for views, which are now available in MySQL server 5.0.x. (Bug#4510)
- `ResultSet.getObject()` returns wrong type for strings when using prepared statements. (Bug#4482)
- Calling `MysqlPooledConnection.close()` twice (even though an application error), caused NPE. Fixed. (Bug#4482)

### C.7.3.13. Changes in MySQL Connector/J 3.1.3 (07 July 2004)

Bugs fixed:

- Support new time zone variables in MySQL-4.1.3 when `useTimezone=true`. (Bug#4311)
- Error in retrieval of `mediumint` column with prepared statements and binary protocol. (Bug#4311)
- Support for unsigned numerics as return types from prepared statements. This also causes a change in `ResultSet.getObject()` for the `bigint unsigned` type, which used to return `BigDecimal` instances, it now returns instances of `java.lang.BigInteger`. (Bug#4311)
- Externalized more messages (on-going effort). (Bug#4119)
- Null bitmask sent for server-side prepared statements was incorrect. (Bug#4119)
- Added constants for MySQL error numbers (publicly accessible, see `com.mysql.jdbc.MysqlErrorNumbers`), and the ability to generate the mappings of vendor error codes to SQLStates that the driver uses (for documentation purposes). (Bug#4119)
- Added packet debugging code (see the `enablePacketDebug` property documentation). (Bug#4119)
- Use SQL Standard SQL states by default, unless `useSqlStateCodes` property is set to `false`. (Bug#4119)
- Mangle output parameter names for `CallableStatements` so they will not clash with user variable names.
- Added support for `INOUT` parameters in `CallableStatements`.

### C.7.3.14. Changes in MySQL Connector/J 3.1.2 (09 June 2004)

Bugs fixed:

- Don't enable server-side prepared statements for server version 5.0.0 or 5.0.1, as they aren't compatible with the '4.1.2+' style that the driver uses (the driver expects information to come back that isn't there, so it hangs). (Bug#3804)
- `getWarnings()` returns `SQLWarning` instead of `DataTruncation`. (Bug#3804)
- `getProcedureColumns()` doesn't work with wildcards for procedure name. (Bug#3540)
- `getProcedures()` does not return any procedures in result set. (Bug#3539)
- Fixed `DatabaseMetaData.getProcedures()` when run on MySQL-5.0.0 (output of `SHOW PROCEDURE STATUS` changed between 5.0.0 and 5.0.1). (Bug#3520)
- Added `connectionCollation` property to cause driver to issue `set collation_connection=...` query on connection init if default collation for given charset is not appropriate. (Bug#3520)
- `DBMD.getSQLStateType()` returns incorrect value. (Bug#3520)
- Correctly map output parameters to position given in `prepareCall()` versus. order implied during `registerOutParameter()`. (Bug#3146)
- Cleaned up detection of server properties. (Bug#3146)
- Correctly detect initial character set for servers  $\geq$  4.1.0. (Bug#3146)
- Support placeholder for parameter metadata for server  $\geq$  4.1.2. (Bug#3146)

- Added `gatherPerformanceMetrics` property, along with properties to control when/where this info gets logged (see docs for more info).
- Fixed case when no parameters could cause a `NullPointerException` in `CallableStatement.setOutputParameters()`.
- Enabled callable statement caching via `cacheCallableStmts` property.
- Fixed sending of split packets for large queries, enabled nio ability to send large packets as well.
- Added `.toString()` functionality to `ServerPreparedStatement`, which should help if you're trying to debug a query that is a prepared statement (it shows SQL as the server would process).
- Added `logSlowQueries` property, along with `slowQueriesThresholdMillis` property to control when a query should be considered "slow."
- Removed wrapping of exceptions in `MysqlIO.changeUser()`.
- Fixed stored procedure parameter parsing info when size was specified for a parameter (for example, `char()`, `varchar()`).
- `ServerPreparedStatements` weren't actually de-allocating server-side resources when `.close()` was called.
- Fixed case when no output parameters specified for a stored procedure caused a bogus query to be issued to retrieve out parameters, leading to a syntax error from the server.

### C.7.3.15. Changes in MySQL Connector/J 3.1.1 (14 February 2004 alpha)

Bugs fixed:

- Use DocBook version of docs for shipped versions of drivers. (Bug#2671)
- `NULL` fields were not being encoded correctly in all cases in server-side prepared statements. (Bug#2671)
- Fixed rare buffer underflow when writing numbers into buffers for sending prepared statement execution requests. (Bug#2671)
- Fixed `ConnectionProperties` that weren't properly exposed via accessors, cleaned up `ConnectionProperties` code. (Bug#2623)
- Class-cast exception when using scrolling result sets and server-side prepared statements. (Bug#2623)
- Merged unbuffered input code from 3.0. (Bug#2623)
- Enabled streaming of result sets from server-side prepared statements. (Bug#2606)
- Server-side prepared statements were not returning datatype `YEAR` correctly. (Bug#2606)
- Fixed charset conversion issue in `getTables()`. (Bug#2502)
- Implemented multiple result sets returned from a statement or stored procedure. (Bug#2502)
- Implemented `Connection.prepareCall()`, and `DatabaseMetaData.getProcedures()` and `getProcedureColumns()`. (Bug#2359)
- Merged prepared statement caching, and `.getMetaData()` support from 3.0 branch. (Bug#2359)
- Fixed off-by-1900 error in some cases for years in `TimeUtil.fastDate/TimeCreate()` when unpacking results from server-side prepared statements. (Bug#2359)
- Reset `long binary` parameters in `ServerPreparedStatement` when `clearParameters()` is called, by sending `COM_RESET_STMT` to the server. (Bug#2359)
- `NULL` values for numeric types in binary encoded result sets causing `NullPointerExceptions`. (Bug#2359)
- Display where/why a connection was implicitly closed (to aid debugging). (Bug#1673)
- `DatabaseMetaData.getColumns()` is not returning correct column ordinal info for non-'%' column name patterns. (Bug#1673)
- Fixed `NullPointerException` in `ServerPreparedStatement.setTimestamp()`, as well as year and month

- discrepancies in `ServerPreparedStatement.setTimestamp()`, `setDate()`. (Bug#1673)
- Added ability to have multiple database/JVM targets for compliance and regression/unit tests in `build.xml`. (Bug#1673)
  - Fixed sending of queries larger than 16M. (Bug#1673)
  - Merged fix of datatype mapping from MySQL type `FLOAT` to `java.sql.Types.REAL` from 3.0 branch. (Bug#1673)
  - Fixed NPE and year/month bad conversions when accessing some datetime functionality in `ServerPreparedStatements` and their resultant result sets. (Bug#1673)
  - Added named and indexed input/output parameter support to `CallableStatement`. MySQL-5.0.x or newer. (Bug#1673)
  - `CommunicationsException` implemented, that tries to determine why communications was lost with a server, and displays possible reasons when `.getMessage()` is called. (Bug#1673)
  - Detect collation of column for `RSMD.isCaseSensitive()`. (Bug#1673)
  - Optimized `Buffer.readLenByteArray()` to return shared empty byte array when length is 0.
  - Fix support for table aliases when checking for all primary keys in `UpdatableResultSet`.
  - Unpack “unknown” data types from server prepared statements as `Strings`.
  - Implemented `Statement.getWarnings()` for MySQL-4.1 and newer (using `SHOW WARNINGS`).
  - Ensure that warnings are cleared before executing queries on prepared statements, as-per JDBC spec (now that we support warnings).
  - Correctly initialize datasource properties from JNDI Refs, including explicitly specified URLs.
  - Implemented long data (Blobs, Clobs, InputStreams, Readers) for server prepared statements.
  - Deal with 0-length tokens in `EscapeProcessor` (caused by callable statement escape syntax).
  - `DatabaseMetaData` now reports `supportsStoredProcedures()` for MySQL versions  $\geq 5.0.0$
  - Support for `mysql_change_user()`. See the `changeUser()` method in `com.mysql.jdbc.Connection`.
  - Removed `useFastDates` connection property.
  - Support for NIO. Use `useNIO=true` on platforms that support NIO.
  - Check for closed connection on delete/update/insert row operations in `UpdatableResultSet`.
  - Support for transaction savepoints (MySQL  $\geq 4.0.14$  or 4.1.1).
  - Support “old” `profileSql` capitalization in `ConnectionProperties`. This property is deprecated, you should use `profileSQL` if possible.
  - Fixed character encoding issues when converting bytes to ASCII when MySQL doesn't provide the character set, and the JVM is set to a multi-byte encoding (usually affecting retrieval of numeric values).
  - Centralized setting of result set type and concurrency.
  - Fixed bug with `UpdatableResultSets` not using client-side prepared statements.
  - Default result set type changed to `TYPE_FORWARD_ONLY` (JDBC compliance).
  - Fixed `IllegalAccessError` to `Calendar.getTimeInMillis()` in `DateTimeValue` (for JDK  $< 1.4$ ).
  - Allow contents of `PreparedStatement.setBlob()` to be retained between calls to `.execute*()`.
  - Fixed stack overflow in `Connection.prepareCall()` (bad merge).
  - Refactored how connection properties are set and exposed as `DriverPropertyInfo` as well as `Connection` and `DataSource` properties.
  - Reduced number of methods called in average query to be more efficient.
  - Prepared `Statements` will be re-prepared on auto-reconnect. Any errors encountered are postponed until first attempt to re-execute the re-prepared statement.

### C.7.3.16. Changes in MySQL Connector/J 3.1.0 (18 February 2003 alpha)

Bugs fixed:

- Added `useServerPrepStmts` property (default `false`). The driver will use server-side prepared statements when the server version supports them (4.1 and newer) when this property is set to `true`. It is currently set to `false` by default until all bind/fetch functionality has been implemented. Currently only DML prepared statements are implemented for 4.1 server-side prepared statements.
- Added `requireSSL` property.
- Track open `Statements`, close all when `Connection.close()` is called (JDBC compliance).

## C.7.4. Changes in MySQL Connector/J 3.0.x

### C.7.4.1. Changes in MySQL Connector/J 3.0.17 (23 June 2005)

Bugs fixed:

- Workaround for server [Bug#9098](#): Default values of `CURRENT_*` for `DATE`, `TIME`, `DATETIME`, and `TIMESTAMP` columns can't be distinguished from `string` values, so `UpdatableResultSet.moveToInsertRow()` generates bad SQL for inserting default values. ([Bug#8812](#))
- `NON_UNIQUE` column from `DBMD.getIndexInfo()` returned inverted value. ([Bug#8812](#))
- `EUCKR` charset is sent as `SET NAMES euc_kr` which MySQL-4.1 and newer doesn't understand. ([Bug#8629](#))
- Added support for the `EUC_JP_Solaris` character encoding, which maps to a MySQL encoding of `euc_jpms` (backported from 3.1 branch). This only works on servers that support `euc_jpms`, namely 5.0.3 or later. ([Bug#8629](#))
- Use hex escapes for `PreparedStatement.setBytes()` for double-byte charsets including "aliases" `Windows-31J`, `CP934`, `MS932`. ([Bug#8629](#))
- `DatabaseMetaData.supportsSelectForUpdate()` returns correct value based on server version. ([Bug#8629](#))
- Which requires hex escaping of binary data when using multi-byte charsets with prepared statements. ([Bug#8064](#))
- Fixed duplicated code in `configureClientCharset()` that prevented `useOldUTF8Behavior=true` from working properly. ([Bug#7952](#))
- Backported SQLState codes mapping from Connector/J 3.1, enable with `useSqlStateCodes=true` as a connection property, it defaults to `false` in this release, so that we don't break legacy applications (it defaults to `true` starting with Connector/J 3.1). ([Bug#7686](#))
- Timestamp key column data needed `_binary` stripped for `UpdatableResultSet.refreshRow()`. ([Bug#7686](#))
- `MS932`, `SHIFT_JIS`, and `Windows_31J` not recognized as aliases for `sjis`. ([Bug#7607](#))
- Handle streaming result sets with more than 2 billion rows properly by fixing wraparound of row number counter. ([Bug#7601](#))
- `PreparedStatement.fixDecimalExponent()` adding extra `+`, making number unparseable by MySQL server. ([Bug#7601](#))
- Escape sequence `{fn convert(..., type)}` now supports ODBC-style types that are prepended by `SQL_`. ([Bug#7601](#))
- Statements created from a pooled connection were returning physical connection instead of logical connection when `getConnection()` was called. ([Bug#7316](#))
- Support new protocol type `MYSQL_TYPE_VARCHAR`. ([Bug#7081](#))
- Added `useOldUTF8Behavior` configuration property, which causes JDBC driver to act like it did with MySQL-4.0.x and earlier when the character encoding is `utf-8` when connected to MySQL-4.1 or newer. ([Bug#7081](#))
- `DatabaseMetaData.getIndexInfo()` ignored `unique` parameter. ([Bug#7081](#))
- `PreparedStatement.fixDecimalExponent()` adding extra `+`, making number unparseable by MySQL server. ([Bug#7061](#))

- `PreparedStatement` don't encode Big5 (and other multi-byte) character sets correctly in static SQL strings. ([Bug#7033](#))
- Connections starting up failed-over (due to down master) never retry master. ([Bug#6966](#))
- Adding CP943 to aliases for `sjis`. ([Bug#6549](#), [Bug#7607](#))
- `Timestamp/Time` conversion goes in the wrong “direction” when `useTimeZone=true` and server time zone differs from client time zone. ([Bug#5874](#))

### C.7.4.2. Changes in MySQL Connector/J 3.0.16 (15 November 2004)

Bugs fixed:

- Made `TINYINT(1) -> BIT/Boolean` conversion configurable via `tinyIntIsBit` property (default `true` to be JDBC compliant out of the box). ([Bug#5664](#))
- Off-by-one bug in `Buffer.readString(string)`. ([Bug#5664](#))
- `ResultSet.updateByte()` when on insert row throws `ArrayOutOfBoundsException`. ([Bug#5664](#))
- Fixed regression where `useUnbufferedInput` was defaulting to `false`. ([Bug#5664](#))
- `ResultSet.getTimestamp()` on a column with `TIME` in it fails. ([Bug#5664](#))
- Fixed `DatabaseMetaData.getTypes()` returning incorrect (this is, non-negative) scale for the `NUMERIC` type. ([Bug#5664](#))
- Only set `character_set_results` during connection establishment if server version  $\geq$  4.1.1. ([Bug#5664](#))
- Fixed `ResultSetMetaData.isReadOnly()` to detect non-writable columns when connected to MySQL-4.1 or newer, based on existence of “original” table and column names.
- Re-issue character set configuration commands when re-using pooled connections and/or `Connection.changeUser()` when connected to MySQL-4.1 or newer.

### C.7.4.3. Changes in MySQL Connector/J 3.0.15 (04 September 2004)

Bugs fixed:

- `ResultSet.getMetaData()` should not return incorrectly initialized metadata if the result set has been closed, but should instead throw an `SQLException`. Also fixed for `getRow()` and `getWarnings()` and traversal methods by calling `checkClosed()` before operating on instance-level fields that are nullified during `.close()`. ([Bug#5069](#))
- Use `_binary` introducer for `PreparedStatement.setBytes()` and `set*Stream()` when connected to MySQL-4.1.x or newer to avoid misinterpretation during character conversion. ([Bug#5069](#))
- Parse new time zone variables from 4.1.x servers. ([Bug#5069](#))
- `ResultSet` should release `Field[]` instance in `.close()`. ([Bug#5022](#))
- `RSMD.getPrecision()` returning 0 for non-numeric types (should return max length in chars for nonbinary types, max length in bytes for binary types). This fix also fixes mapping of `RSMD.getColumnType()` and `RSMD.getColumnTypeName()` for the `BLOB` types based on the length sent from the server (the server doesn't distinguish between `TINYBLOB`, `BLOB`, `MEDIUMBLOB` or `LOB` at the network protocol level). ([Bug#4880](#))
- “Production” is now “GA” (General Availability) in naming scheme of distributions. ([Bug#4860](#), [Bug#4138](#))
- `DBMD.getColumns()` returns incorrect JDBC type for unsigned columns. This affects type mappings for all numeric types in the `RSMD.getColumnType()` and `RSMD.getColumnTypeNames()` methods as well, to ensure that “like” types from `DBMD.getColumns()` match up with what `RSMD.getColumnType()` and `getColumnTypeNames()` return. ([Bug#4860](#), [Bug#4138](#))
- Calling `.close()` twice on a `PooledConnection` causes NPE. ([Bug#4808](#))
- `DOUBLE` mapped twice in `DBMD.getTypeInfo()`. ([Bug#4742](#))
- Added FLOSS license exemption. ([Bug#4742](#))

- Removed redundant calls to `checkRowPos()` in `ResultSet`. (Bug#4334)
- Failover for `autoReconnect` not using port numbers for any hosts, and not retrying all hosts.

**Warning**

This required a change to the `SocketFactory connect()` method signature, which is now `public Socket connect(String host, int portNumber, Properties props)`; therefore, any third-party socket factories will have to be changed to support this signature.

(Bug#4334)

- Logical connections created by `MysqlConnectionPoolDataSource` will now issue a `rollback()` when they are closed and sent back to the pool. If your application server/connection pool already does this for you, you can set the `rollbackOnPooledClose` property to `false` to avoid the overhead of an extra `rollback()`. (Bug#4334)
- `StringUtils.escapeEasternUnicodeByteStream` was still broken for GBK. (Bug#4010)

#### C.7.4.4. Changes in MySQL Connector/J 3.0.14 (28 May 2004)

Bugs fixed:

- Fixed URL parsing error.

#### C.7.4.5. Changes in MySQL Connector/J 3.0.13 (27 May 2004)

Bugs fixed:

- `No Database Selected` when using `MysqlConnectionPoolDataSource`. (Bug#3920)
- `PreparedStatement.getGeneratedKeys()` method returns only 1 result for batched insertions. (Bug#3873)
- Using a `MySQLDataSource` without server name fails. (Bug#3848)

#### C.7.4.6. Changes in MySQL Connector/J 3.0.12 (18 May 2004)

Bugs fixed:

- Inconsistent reporting of data type. The server still doesn't return all types for \*BLOBs \*TEXT correctly, so the driver won't return those correctly. (Bug#3570)
- `UpdatableResultSet` not picking up default values for `moveToInsertRow()`. (Bug#3557)
- Not specifying database in URL caused `MalformedURLException` exception. (Bug#3554)
- Auto-convert MySQL encoding names to Java encoding names if used for `characterEncoding` property. (Bug#3554)
- Use `junit.textui.TestRunner` for all unit tests (to allow them to be run from the command line outside of Ant or Eclipse). (Bug#3554)
- Added encoding names that are recognized on some JVMs to fix case where they were reverse-mapped to MySQL encoding names incorrectly. (Bug#3554)
- Made `StringRegressionTest` 4.1-unicode aware. (Bug#3520)
- Fixed regression in `PreparedStatement.setString()` and eastern character encodings. (Bug#3520)
- `DBMD.getSQLStateType()` returns incorrect value. (Bug#3520)
- Renamed `StringUtils.escapeSJISByteStream()` to more appropriate `escapeEasternUnicodeByteStream()`. (Bug#3511)
- `StringUtils.escapeSJISByteStream()` not covering all eastern double-byte charsets correctly. (Bug#3511)
- Return creating statement for `ResultSets` created by `getGeneratedKeys()`. (Bug#2957)

- Use `SET character_set_results` during initialization to allow any charset to be returned to the driver for result sets. (Bug#2670)
- Don't truncate `BLOB` or `CLOB` values when using `getBytes()` and/or `setBinary/CharacterStream()`. (Bug#2670)
- Dynamically configure character set mappings for field-level character sets on MySQL-4.1.0 and newer using `SHOW COLLATION` when connecting. (Bug#2670)
- Map `binary` character set to `US-ASCII` to support `DATETIME` charset recognition for servers  $\geq 4.1.2$ . (Bug#2670)
- Use `charsetnr` returned during connect to encode queries before issuing `SET NAMES` on MySQL  $\geq 4.1.0$ . (Bug#2670)
- Add helper methods to `ResultSetMetaData` (`getColumnCharacterEncoding()` and `getColumnCharacterSet()`) to allow end-users to see what charset the driver thinks it should be using for the column. (Bug#2670)
- Only set `character_set_results` for MySQL  $\geq 4.1.0$ . (Bug#2670)
- Allow `url` parameter for `MysqlDataSource` and `MysqlConnectionPool DataSource` so that passing of other properties is possible from inside appservers.
- Don't escape SJIS/GBK/BIG5 when using MySQL-4.1 or newer.
- Backport documentation tooling from 3.1 branch.
- Added `failOverReadOnly` property, to allow end-user to configure state of connection (read-only/writable) when failed over.
- Allow `java.util.Date` to be sent in as parameter to `PreparedStatement.setObject()`, converting it to a `Timestamp` to maintain full precision. (Bug#103)
- Add unsigned attribute to `DatabaseMetaData.getColumns()` output in the `TYPE_NAME` column.
- Map duplicate key and foreign key errors to `SQLState` of `23000`.
- Backported “change user” and “reset server state” functionality from 3.1 branch, to allow clients of `MysqlConnectionPoolDataSource` to reset server state on `getConnection()` on a pooled connection.

#### C.7.4.7. Changes in MySQL Connector/J 3.0.11 (19 February 2004)

Bugs fixed:

- Return `java.lang.Double` for `FLOAT` type from `ResultSetMetaData.getColumnClassName()`. (Bug#2855)
- Return `[B` instead of `java.lang.Object` for `BINARY`, `VARBINARY` and `LONGVARBINARY` types from `ResultSetMetaData.getColumnClassName()` (JDBC compliance). (Bug#2855)
- Issue connection events on all instances created from a `ConnectionPoolDataSource`. (Bug#2855)
- Return `java.lang.Integer` for `TINYINT` and `SMALLINT` types from `ResultSetMetaData.getColumnClassName()`. (Bug#2852)
- Added `useUnbufferedInput` parameter, and now use it by default (due to JVM issue <http://developer.java.sun.com/developer/bugParade/bugs/4401235.html>) (Bug#2578)
- Fixed failover always going to last host in list. (Bug#2578)
- Detect `on/off` or `1, 2, 3` form of `lower_case_table_names` value on server. (Bug#2578)
- `AutoReconnect` time was growing faster than exponentially. (Bug#2447)
- Trigger a `SET NAMES utf8` when encoding is forced to `utf8` or `utf-8` via the `characterEncoding` property. Previously, only the Java-style encoding name of `utf-8` would trigger this.

#### C.7.4.8. Changes in MySQL Connector/J 3.0.10 (13 January 2004)

Bugs fixed:



- Enable caching of the parsing stage of prepared statements via the `cachePrepStmts`, `prepStmtCacheSize`, and `prepStmtCacheSqlLimit` properties (disabled by default). (Bug#2006)
- Fixed security exception when used in Applets (applets can't read the system property `file.encoding` which is needed for `LOAD DATA LOCAL INFILE`). (Bug#2006)
- Speed up parsing of `PreparedStatements`, try to use one-pass whenever possible. (Bug#2006)
- Fixed exception `Unknown character set 'danish'` on connect with JDK-1.4.0 (Bug#2006)
- Fixed mappings in `SQLException` to report deadlocks with `SQLStates` of `41000`. (Bug#2006)
- Removed static synchronization bottleneck from instance factory method of `SingleByteCharsetConverter`. (Bug#2006)
- Removed static synchronization bottleneck from `PreparedStatement.setTimestamp()`. (Bug#2006)
- `ResultSet.findColumn()` should use first matching column name when there are duplicate column names in `SELECT` query (JDBC-compliance). (Bug#2006)
- `maxRows` property would affect internal statements, so check it for all statement creation internal to the driver, and set to 0 when it is not. (Bug#2006)
- Use constants for `SQLStates`. (Bug#2006)
- Map charset `ko18_ru` to `ko18r` when connected to MySQL-4.1.0 or newer. (Bug#2006)
- Ensure that `Buffer.writeString()` saves room for the `\0`. (Bug#2006)
- `ArrayIndexOutOfBoundsException` when parameter number == number of parameters + 1. (Bug#1958)
- Connection property `maxRows` not honored. (Bug#1933)
- Statements being created too many times in `DBMD.extractForeignKeyFromCreateTable()`. (Bug#1925)
- Support escape sequence `{fn convert ... }`. (Bug#1914)
- Implement `ResultSet.updateClob()`. (Bug#1913)
- Autoreconnect code didn't set catalog upon reconnect if it had been changed. (Bug#1913)
- `ResultSet.getObject()` on `TINYINT` and `SMALLINT` columns should return Java type `Integer`. (Bug#1913)
- Added more descriptive error message `Server Configuration Denies Access to DataSource`, as well as retrieval of message from server. (Bug#1913)
- `ResultSetMetaData.isCaseSensitive()` returned wrong value for `CHAR/VARCHAR` columns. (Bug#1913)
- Added `alwaysClearStream` connection property, which causes the driver to always empty any remaining data on the input stream before each query. (Bug#1913)
- `DatabaseMetaData.getSystemFunction()` returning bad function `VResultsSion`. (Bug#1775)
- Foreign Keys column sequence is not consistent in `DatabaseMetaData.getImported/Exported/CrossReference()`. (Bug#1731)
- Fix for `ArrayIndexOutOfBoundsException` exception when using `Statement.setMaxRows()`. (Bug#1695)
- Subsequent call to `ResultSet.updateFoo()` causes NPE if result set is not updatable. (Bug#1630)
- Fix for 4.1.1-style authentication with no password. (Bug#1630)
- Cross-database updatable result sets are not checked for updatability correctly. (Bug#1592)
- `DatabaseMetaData.getColumns()` should return `Types.LONGVARCHAR` for MySQL `LONGTEXT` type. (Bug#1592)
- Fixed regression of `Statement.getGeneratedKeys()` and `REPLACE` statements. (Bug#1576)
- Barge blobs and split packets not being read correctly. (Bug#1576)
- Backported fix for aliased tables and `UpdatableResultSets` in `checkUpdatability()` method from 3.1 branch. (Bug#1534)



- “Friendlier” exception message for `PacketTooLargeException`. ([Bug#1534](#))
- Don't count quoted IDs when inside a 'string' in `PreparedStatement` parsing. ([Bug#1511](#))

### C.7.4.9. Changes in MySQL Connector/J 3.0.9 (07 October 2003)

Bugs fixed:

- `ResultSet.getString/setString` mashing char 127. ([Bug#1247](#))
- Added property to “clobber” streaming results, by setting the `clobberStreamingResults` property to `true` (the default is `false`). This will cause a “streaming” `ResultSet` to be automatically closed, and any outstanding data still streaming from the server to be discarded if another query is executed before all the data has been read from the server. ([Bug#1247](#))
- Added `com.mysql.jdbc.util.BaseBugReport` to help creation of testcases for bug reports. ([Bug#1247](#))
- Backported authentication changes for 4.1.1 and newer from 3.1 branch. ([Bug#1247](#))
- Made `databaseName`, `portNumber`, and `serverName` optional parameters for `MysqlDataSourceFactory`. ([Bug#1246](#))
- Optimized `CLOB.setCharacterStream()`. ([Bug#1131](#))
- Fixed `CLOB.truncate()`. ([Bug#1130](#))
- Fixed deadlock issue with `Statement.setMaxRows()`. ([Bug#1099](#))
- `DatabaseMetaData.getColumns()` getting confused about the keyword “set” in character columns. ([Bug#1099](#))
- Clip +/- INF (to smallest and largest representative values for the type in MySQL) and NaN (to 0) for `setDouble/setFloat()`, and issue a warning on the statement when the server does not support +/- INF or NaN. ([Bug#884](#))
- Don't fire connection closed events when closing pooled connections, or on `PooledConnection.getConnection()` with already open connections. ([Bug#884](#))
- Double-escaping of `'\'` when charset is SJIS or GBK and `'\'` appears in non-escaped input. ([Bug#879](#))
- When emptying input stream of unused rows for “streaming” result sets, have the current thread `yield()` every 100 rows in order to not monopolize CPU time. ([Bug#879](#))
- Issue exception on `ResultSet.getXXX()` on empty result set (wasn't caught in some cases). ([Bug#848](#))
- Don't hide messages from exceptions thrown in I/O layers. ([Bug#848](#))
- Fixed regression in large split-packet handling. ([Bug#848](#))
- Better diagnostic error messages in exceptions for “streaming” result sets. ([Bug#848](#))
- Don't change timestamp TZ twice if `useTimezone==true`. ([Bug#774](#))
- Don't wrap `SQLExceptions` in `RowDataDynamic`. ([Bug#688](#))
- Don't try and reset isolation level on reconnect if MySQL doesn't support them. ([Bug#688](#))
- The `insertRow` in an `UpdatableResultSet` is now loaded with the default column values when `moveToInsertRow()` is called. ([Bug#688](#))
- `DatabaseMetaData.getColumns()` wasn't returning `NULL` for default values that are specified as `NULL`. ([Bug#688](#))
- Change default statement type/concurrency to `TYPE_FORWARD_ONLY` and `CONCUR_READ_ONLY` (spec compliance). ([Bug#688](#))
- Fix `UpdatableResultSet` to return values for `getXXX()` when on insert row. ([Bug#675](#))
- Support `InnoDB` constraint names when extracting foreign key information in `DatabaseMetaData` (implementing ideas from Parwinder Sekhon). ([Bug#664](#), [Bug#517](#))
- Backported 4.1 protocol changes from 3.1 branch (server-side SQL states, new field information, larger client capability flags, connect-with-database, and so forth). ([Bug#664](#), [Bug#517](#))

- `refreshRow` didn't work when primary key values contained values that needed to be escaped (they ended up being doubly escaped). (Bug#661)
- Fixed `ResultSet.previous()` behavior to move current position to before result set when on first row of result set. (Bug#496)
- Fixed `Statement` and `PreparedStatement` issuing bogus queries when `setMaxRows()` had been used and a `LIMIT` clause was present in the query. (Bug#496)
- Faster date handling code in `ResultSet` and `PreparedStatement` (no longer uses `Date` methods that synchronize on static calendars).
- Fixed test for end of buffer in `Buffer.readString()`.

#### C.7.4.10. Changes in MySQL Connector/J 3.0.8 (23 May 2003)

Bugs fixed:

- Fixed SJIS encoding bug, thanks to Naoto Sato. (Bug#378)
- Fix problem detecting server character set in some cases. (Bug#378)
- Allow multiple calls to `Statement.close()`. (Bug#378)
- Return correct number of generated keys when using `REPLACE` statements. (Bug#378)
- Unicode character 0xFFFF in a string would cause the driver to throw an `ArrayOutOfBoundsException`. (Bug#378)
- Fix row data decoding error when using *very* large packets. (Bug#378)
- Optimized row data decoding. (Bug#378)
- Issue exception when operating on an already closed prepared statement. (Bug#378)
- Optimized usage of `EscapeProcessor`. (Bug#378)
- Use JVM charset with file names and `LOAD DATA [LOCAL] INFILE`.
- Fix infinite loop with `Connection.cleanup()`.
- Changed Ant target `compile-core` to `compile-driver`, and made test suite compilation a separate target.
- Fixed result set not getting set for `Statement.executeUpdate()`, which affected `getGeneratedKeys()` and `getUpdateCount()` in some cases.
- Return list of generated keys when using multi-value `INSERTS` with `Statement.getGeneratedKeys()`.
- Allow bogus URLs in `Driver.getPropertyInfo()`.

#### C.7.4.11. Changes in MySQL Connector/J 3.0.7 (08 April 2003)

Bugs fixed:

- Fixed charset issues with database metadata (charset was not getting set correctly).
- You can now toggle profiling on/off using `Connection.setProfileSql(boolean)`.
- 4.1 Column Metadata fixes.
- Fixed `MysqlPooledConnection.close()` calling wrong event type.
- Fixed `StringIndexOutOfBoundsException` in `PreparedStatement.setClob()`.
- `IOExceptions` during a transaction now cause the `Connection` to be closed.
- Remove synchronization from `Driver.connect()` and `Driver.acceptsUrl()`.

- Fixed missing conversion for `YEAR` type in `ResultSetMetaData.getColumnTypeName()`.
- Updatable `ResultSets` can now be created for aliased tables/columns when connected to MySQL-4.1 or newer.
- Fixed `LOAD DATA LOCAL INFILE` bug when file > `max_allowed_packet`.
- Don't pick up indexes that start with `pri` as primary keys for `DBMD.getPrimaryKeys()`.
- Ensure that packet size from `alignPacketSize()` does not exceed `max_allowed_packet` (JVM bug)
- Don't reset `Connection.isReadOnly()` when autoReconnecting.
- Fixed escaping of `0x5c ('\\')` character for GBK and Big5 charsets.
- Fixed `ResultSet.getTimestamp()` when underlying field is of type `DATE`.
- Throw `SQLExceptions` when trying to do operations on a forcefully closed `Connection` (that is, when a communication link failure occurs).

### C.7.4.12. Changes in MySQL Connector/J 3.0.6 (18 February 2003)

Bugs fixed:

- Backported 4.1 charset field info changes from Connector/J 3.1.
- Fixed `Statement.setMaxRows()` to stop sending `LIMIT` type queries when not needed (performance).
- Fixed `DBMD.getTypeInfo()` and `DBMD.getColumns()` returning different value for precision in `TEXT` and `BLOB` types.
- Fixed `SQLExceptions` getting swallowed on initial connect.
- Fixed `ResultSetMetaData` to return "" when catalog not known. Fixes `NullPointerExceptions` with Sun's `CachedRowSet`.
- Allow ignoring of warning for “non transactional tables” during rollback (compliance/usability) by setting `ignoreNonTxTables` property to `true`.
- Clean up `Statement` query/method mismatch tests (that is, `INSERT` not allowed with `.executeQuery()`).
- Fixed `ResultSetMetaData.isWritable()` to return correct value.
- More checks added in `ResultSet` traversal method to catch when in closed state.
- Implemented `Blob.setBytes()`. You still need to pass the resultant `Blob` back into an updatable `ResultSet` or `PreparedStatement` to persist the changes, because MySQL does not support “locators”.
- Add “window” of different `NULL` sorting behavior to `DBMD.nullsAreSortedAtStart` (4.0.2 to 4.0.10, true; otherwise, no).

### C.7.4.13. Changes in MySQL Connector/J 3.0.5 (22 January 2003)

Bugs fixed:

- Fixed `ResultSet.isBeforeFirst()` for empty result sets.
- Added missing `LONGTEXT` type to `DBMD.getColumns()`.
- Implemented an empty `TypeMap` for `Connection.getTypeMap()` so that some third-party apps work with MySQL (IBM WebSphere 5.0 Connection pool).
- Added update options for foreign key metadata.
- Fixed `Buffer.fastSkipLenString()` causing `ArrayIndexOutOfBoundsException` exceptions with some queries when unpacking fields.
- Quote table names in `DatabaseMetaData.getColumns()`, `getPrimaryKeys()`, `getIndexInfo()`, `getBe-`

`stRowIdentifier()`.

- Retrieve `TX_ISOLATION` from database for `Connection.getTransactionIsolation()` when the MySQL version supports it, instead of an instance variable.
- Greatly reduce memory required for `setBinaryStream()` in `PreparedStatement`s.

#### C.7.4.14. Changes in MySQL Connector/J 3.0.4 (06 January 2003)

Bugs fixed:

- Streamlined character conversion and `byte[]` handling in `PreparedStatement`s for `setByte()`.
- Fixed `PreparedStatement.executeBatch()` parameter overwriting.
- Added quoted identifiers to database names for `Connection.setCatalog`.
- Added support for 4.0.8-style large packets.
- Reduce memory footprint of `PreparedStatement`s by sharing outbound packet with `MySQLIO`.
- Added `strictUpdates` property to allow control of amount of checking for “correctness” of updatable result sets. Set this to `false` if you want faster updatable result sets and you know that you create them from `SELECT` statements on tables with primary keys and that you have selected all primary keys in your query.
- Added support for quoted identifiers in `PreparedStatement` parser.

#### C.7.4.15. Changes in MySQL Connector/J 3.0.3 (17 December 2002)

Bugs fixed:

- Allow user to alter behavior of `Statement/PreparedStatement.executeBatch()` via `continueBatchOnError` property (defaults to `true`).
- More robust escape tokenizer: Recognize `--` comments, and allow nested escape sequences (see `test-suite.EscapeProcessingTest`).
- Fixed `Buffer.isLastDataPacket()` for 4.1 and newer servers.
- `NamedPipeSocketFactory` now works (only intended for Windows), see `README` for instructions.
- Changed `charsToByte` in `SingleByteCharConverter` to be non-static.
- Use non-aliased table/column names and database names to fully qualify tables and columns in `UpdatableResultSet` (requires MySQL-4.1 or newer).
- `LOAD DATA LOCAL INFILE ...` now works, if your server is configured to allow it. Can be turned off with the `allowLoadLocalInfile` property (see the `README`).
- Implemented `Connection.nativeSQL()`.
- Fixed `ResultSetMetaData.getColumnTypeName()` returning `BLOB` for `TEXT` and `TEXT` for `BLOB` types.
- Fixed charset handling in `Fields.java`.
- Because of above, implemented `ResultSetMetaData.isAutoIncrement()` to use `Field.isAutoIncrement()`.
- Substitute `' ? '` for unknown character conversions in single-byte character sets instead of `'\0'`.
- Added `CLIENT_LONG_FLAG` to be able to get more column flags (`isAutoIncrement()` being the most important).
- Honor `lower_case_table_names` when enabled in the server when doing table name comparisons in `DatabaseMetaData` methods.
- `DBMD.getImported/ExportedKeys()` now handles multiple foreign keys per table.
- More robust implementation of updatable result sets. Checks that *all* primary keys of the table have been selected.

- Some MySQL-4.1 protocol support (extended field info from selects).
- Check for connection closed in more `Connection` methods (`createStatement`, `prepareStatement`, `setTransactionIsolation`, `setAutoCommit`).
- Fixed `ResultSetMetaData.getPrecision()` returning incorrect values for some floating-point types.
- Changed `SingleByteCharConverter` to use lazy initialization of each converter.

#### C.7.4.16. Changes in MySQL Connector/J 3.0.2 (08 November 2002)

Bugs fixed:

- Implemented `Clob.setString()`.
- Added `com.mysql.jdbc.MinisAdmin` class, which allows you to send `shutdown` command to MySQL server. This is intended to be used when “embedding” Java and MySQL server together in an end-user application.
- Added SSL support. See [README](#) for information on how to use it.
- All `DBMD` result set columns describing schemas now return `NULL` to be more compliant with the behavior of other JDBC drivers for other database systems (MySQL does not support schemas).
- Use `SHOW CREATE TABLE` when possible for determining foreign key information for `DatabaseMetaData`. Also allows cascade options for `DELETE` information to be returned.
- Implemented `Clob.setCharacterStream()`.
- Failover and `autoReconnect` work only when the connection is in an `autoCommit(false)` state, in order to stay transaction-safe.
- Fixed `DBMD.supportsResultSetConcurrency()` so that it returns `true` for `ResultSet.TYPE_SCROLL_INSENSITIVE` and `ResultSet.CONCUR_READ_ONLY` or `ResultSet.CONCUR_UPDATABLE`.
- Implemented `Clob.setAsciiStream()`.
- Removed duplicate code from `UpdatableResultSet` (it can be inherited from `ResultSet`, the extra code for each method to handle updatability I thought might someday be necessary has not been needed).
- Fixed `UnsupportedEncodingException` thrown when “forcing” a character encoding via properties.
- Fixed incorrect conversion in `ResultSet.getLong()`.
- Implemented `ResultSet.updateBlob()`.
- Removed some not-needed temporary object creation by smarter use of `Strings` in `EscapeProcessor`, `Connection` and `DatabaseMetaData` classes.
- Escape `0x5c` character in strings for the SJIS charset.
- `PreparedStatement` now honors stream lengths in `setBinary/Ascii/Character Stream()` unless you set the connection property `useStreamLengthsInPrepStmts` to `false`.
- Fixed issue with updatable result sets and `PreparedStatements` not working.
- Fixed start position off-by-1 error in `Clob.getSubString()`.
- Added `connectTimeout` parameter that allows users of JDK-1.4 and newer to specify a maximum time to wait to establish a connection.
- Fixed various non-ASCII character encoding issues.
- Fixed `ResultSet.isLast()` for empty result sets (should return `false`).
- Added driver property `useHostsInPrivileges`. Defaults to `true`. Affects whether or not `@hostname` will be used in `DBMD.getColumn/TablePrivileges`.
- Fixed `ResultSet.setFetchDirection(FETCH_UNKNOWN)`.

- Added `queriesBeforeRetryMaster` property that specifies how many queries to issue when failed over before attempting to reconnect to the master (defaults to 50).
- Fixed issue when calling `Statement.setFetchSize()` when using arbitrary values.
- Properly restore connection properties when autoReconnecting or failing-over, including `autoCommit` state, and isolation level.
- Implemented `Clob.truncate()`.

### C.7.4.17. Changes in MySQL Connector/J 3.0.1 (21 September 2002)

Bugs fixed:

- Charsets now automatically detected. Optimized code for single-byte character set conversion.
- Fixed `ResultSetMetaData.isSigned()` for `TINYINT` and `BIGINT`.
- Fixed `RowDataStatic.getAt()` off-by-one bug.
- Fixed `ResultSet.getRow()` off-by-one bug.
- Massive code clean-up to follow Java coding conventions (the time had come).
- Implemented `ResultSet.getCharacterStream()`.
- Added limited `Clob` functionality (`ResultSet.getClob()`, `PreparedStatement.setClob()`, `PreparedStatement.setObject(Clob)`).
- `Connection.isClosed()` no longer “pings” the server.
- `Connection.close()` issues `rollback()` when `getAutoCommit()` is `false`.
- Added `socketTimeout` parameter to URL.
- Added `LOCAL TEMPORARY` to table types in `DatabaseMetaData.getTableTypes()`.
- Added `paranoid` parameter, which sanitizes error messages by removing “sensitive” information from them (such as host names, ports, or user names), as well as clearing “sensitive” data structures when possible.

### C.7.4.18. Changes in MySQL Connector/J 3.0.0 (31 July 2002)

Bugs fixed:

- General source-code cleanup.
- The driver now only works with JDK-1.2 or newer.
- Fix and sort primary key names in `DBMetaData` (SF bugs 582086 and 582086).
- `ResultSet.getTimestamp()` now works for `DATE` types (SF bug 559134).
- Float types now reported as `java.sql.Types.FLOAT` (SF bug 579573).
- Support for streaming (row-by-row) result sets (see [README](#)) Thanks to Doron.
- Testsuite now uses Junit (which you can get from <http://www.junit.org>).
- JDBC Compliance: Passes all tests besides stored procedure tests.
- `ResultSet.getDate/Time/Timestamp` now recognizes all forms of invalid values that have been set to all zeros by MySQL (SF bug 586058).
- Added multi-host failover support (see [README](#)).
- Repackaging: New driver name is `com.mysql.jdbc.Driver`, old name still works, though (the driver is now provided by MySQL-AB).

- Support for large packets (new addition to MySQL-4.0 protocol), see [README](#) for more information.
- Better checking for closed connections in [Statement](#) and [PreparedStatement](#).
- Performance improvements in string handling and field metadata creation (lazily instantiated) contributed by Alex Twisleton-Wykeham-Fiennes.
- JDBC-3.0 functionality including [Statement/PreparedStatement.getGeneratedKeys\(\)](#) and [ResultSet.getURL\(\)](#).
- Overall speed improvements via controlling transient object creation in [MysqlIO](#) class when reading packets.
- **!!! LICENSE CHANGE !!!** The driver is now GPL. If you need non-GPL licenses, please contact me [<mark@mysql.com>](mailto:mark@mysql.com).
- Performance enhancements: Driver is now 50–100% faster in most situations, and creates fewer temporary objects.

## C.7.5. Changes in MySQL Connector/J 2.0.x

### C.7.5.1. Changes in MySQL Connector/J 2.0.14 (16 May 2002)

Bugs fixed:

- [ResultSet.getDouble\(\)](#) now uses code built into JDK to be more precise (but slower).
- Fixed typo for [relaxAutoCommit](#) parameter.
- [LogicalHandle.isClosed\(\)](#) calls through to physical connection.
- Added SQL profiling (to [STDERR](#)). Set [profileSql=true](#) in your JDBC URL. See [README](#) for more information.
- [PreparedStatement](#) now releases resources on [.close\(\)](#). (SF bug 553268)
- More code cleanup.
- Quoted identifiers not used if server version does not support them. Also, if server started with [--ansi](#) or [-sql-mode=ANSI\\_QUOTES](#), “” will be used as an identifier quote character, otherwise “'” will be used.

### C.7.5.2. Changes in MySQL Connector/J 2.0.13 (24 April 2002)

Bugs fixed:

- Fixed unicode chars being read incorrectly. (SF bug 541088)
- Faster blob escaping for [PrepStmt](#).
- Added [setURL\(\)](#) to [MySQLXADataSource](#). (SF bug 546019)
- Added [set/getPortNumber\(\)](#) to [DataSource\(s\)](#). (SF bug 548167)
- [PreparedStatement.toString\(\)](#) fixed. (SF bug 534026)
- More code cleanup.
- Rudimentary version of [Statement.getGeneratedKeys\(\)](#) from JDBC-3.0 now implemented (you need to be using JDK-1.4 for this to work, I believe).
- [DBMetaData.getIndexInfo\(\)](#) - bad PAGES fixed. (SF BUG 542201)
- [ResultSetMetaData.getColumnClassName\(\)](#) now implemented.

### C.7.5.3. Changes in MySQL Connector/J 2.0.12 (07 April 2002)

Bugs fixed:

- Fixed [testsuite.Traversal.afterLast\(\)](#) bug, thanks to Igor Lastric.



- Added new types to `getTypeInfo()`, fixed existing types thanks to Al Davis and Kid Kalanon.
- Fixed time zone off-by-1-hour bug in `PreparedStatement` (538286, 528785).
- Added identifier quoting to all `DatabaseMetaData` methods that need them (should fix 518108).
- Added support for `BIT` types (51870) to `PreparedStatement`.
- `ResultSet.insertRow()` should now detect `auto_increment` fields in most cases and use that value in the new row. This detection will not work in multi-valued keys, however, due to the fact that the MySQL protocol does not return this information.
- Relaxed synchronization in all classes, should fix 520615 and 520393.
- `DataSources` - fixed `setUrl` bug (511614, 525565), wrong datasource class name (532816, 528767).
- Added support for `YEAR` type (533556).
- Fixes for `ResultSet` updatability in `PreparedStatement`.
- `ResultSet`: Fixed updatability (values being set to `null` if not updated).
- Added `getTable/ColumnPrivileges()` to `DBMD` (fixes 484502).
- Added `getIdleFor()` method to `Connection` and `MysqlLogicalHandle`.
- `ResultSet.refreshRow()` implemented.
- Fixed `getRow()` bug (527165) in `ResultSet`.
- General code cleanup.

#### C.7.5.4. Changes in MySQL Connector/J 2.0.11 (27 January 2002)

Bugs fixed:

- Full synchronization of `Statement.java`.
- Fixed missing `DELETE_RULE` value in `DBMD.getImported/ExportedKeys()` and `getCrossReference()`.
- More changes to fix `Unexpected end of input stream` errors when reading `BLOB` values. This should be the last fix.

#### C.7.5.5. Changes in MySQL Connector/J 2.0.10 (24 January 2002)

Bugs fixed:

- Fixed null-pointer-exceptions when using `MysqlConnectionPoolDataSource` with Websphere 4 (bug 505839).
- Fixed spurious `Unexpected end of input stream` errors in `MysqlIO` (bug 507456).

#### C.7.5.6. Changes in MySQL Connector/J 2.0.9 (13 January 2002)

Bugs fixed:

- Fixed extra memory allocation in `MysqlIO.readPacket()` (bug 488663).
- Added detection of network connection being closed when reading packets (thanks to Todd Lizambri).
- Fixed casting bug in `PreparedStatement` (bug 488663).
- `DataSource` implementations moved to `org.gjt.mm.mysql.jdbc2.optional` package, and (initial) implementations of `PooledConnectionDataSource` and `XADataSource` are in place (thanks to Todd Wolff for the implementation and testing of `PooledConnectionDataSource` with IBM WebSphere 4).
- Fixed quoting error with escape processor (bug 486265).



- Removed concatenation support from driver (the `||` operator), as older versions of VisualAge seem to be the only thing that use it, and it conflicts with the logical `|||` operator. You will need to start `mysqld` with the `--ansi` flag to use the `||` operator as concatenation (bug 491680).
- `Ant` build was corrupting included `jar` files, fixed (bug 487669).
- Report batch update support through `DatabaseMetaData` (bug 495101).
- Implementation of `DatabaseMetaData.getExported/ImportedKeys()` and `getCrossReference()`.
- Fixed off-by-one-hour error in `PreparedStatement.setTimestamp()` (bug 491577).
- Full synchronization on methods modifying instance and class-shared references, driver should be entirely thread-safe now (please let me know if you have problems).

### C.7.5.7. Changes in MySQL Connector/J 2.0.8 (25 November 2001)

Bugs fixed:

- `XADataSource/ConnectionPoolDataSource` code (experimental)
- `DatabaseMetaData.getPrimaryKeys()` and `getBestRowIdentifier()` are now more robust in identifying primary keys (matches regardless of case or abbreviation/full spelling of `Primary Key` in `Key_type` column).
- Batch updates now supported (thanks to some inspiration from Daniel Rall).
- `PreparedStatement.setAnyNumericType()` now handles positive exponents correctly (adds `+` so MySQL can understand it).

### C.7.5.8. Changes in MySQL Connector/J 2.0.7 (24 October 2001)

Bugs fixed:

- Character sets read from database if `useUnicode=true` and `characterEncoding` is not set. (thanks to Dmitry Vereshchagin)
- Initial transaction isolation level read from database (if available). (thanks to Dmitry Vereshchagin)
- Fixed `PreparedStatement` generating SQL that would end up with syntax errors for some queries.
- `PreparedStatement.setCharacterStream()` now implemented
- Capitalize type names when `capitalizeTypeNames=true` is passed in URL or properties (for `WebObjects`). (thanks to Anjo Krank)
- `ResultSet.getBlob()` now returns `null` if column value was `null`.
- Fixed `ResultSetMetaData.getPrecision()` returning one less than actual on newer versions of MySQL.
- Fixed dangling socket problem when in high availability (`autoReconnect=true`) mode, and finalizer for `Connection` will close any dangling sockets on GC.
- Fixed time zone issue in `PreparedStatement.setTimestamp()`. (thanks to Erik Olofsson)
- `PreparedStatement.setDouble()` now uses full-precision doubles (reverting a fix made earlier to truncate them).
- Fixed `DatabaseMetaData.supportsTransactions()`, and `supportsTransactionIsolationLevel()` and `getTypeInfo()` `SQL_DATETIME_SUB` and `SQL_DATA_TYPE` fields not being readable.
- Updatable result sets now correctly handle `NULL` values in fields.
- `PreparedStatement.setBoolean()` will use `1/0` for values if your MySQL version is 3.21.23 or higher.
- Fixed `ResultSet.isAfterLast()` always returning `false`.

### C.7.5.9. Changes in MySQL Connector/J 2.0.6 (16 June 2001)

Bugs fixed:

- Fixed `PreparedStatement` parameter checking.
- Fixed case-sensitive column names in `ResultSet.java`.

### C.7.5.10. Changes in MySQL Connector/J 2.0.5 (13 June 2001)

Bugs fixed:

- `ResultSet.insertRow()` works now, even if not all columns are set (they will be set to `NULL`).
- Added `Byte` to `PreparedStatement.setObject()`.
- Fixed data parsing of `TIMESTAMP` values with 2-digit years.
- Added `ISOLATION` level support to `Connection.setIsolationLevel()`
- `DataBaseMetaData.getCrossReference()` no longer `ArrayIndexOOB`.
- `ResultSet.getBoolean()` now recognizes `-1` as `true`.
- `ResultSet` has `+/-Inf/inf` support.
- `getObject()` on `ResultSet` correctly does `TINYINT->Byte` and `SMALLINT->Short`.
- Fixed `ResultSetMetaData.getColumnTypeName` for `TEXT/BLOB`.
- Fixed `ArrayIndexOutOfBounds` when sending large `BLOB` queries. (Max size packet was not being set)
- Fixed `NPE` on `PreparedStatement.executeUpdate()` when all columns have not been set.
- Fixed `ResultSet.getBlob()` `ArrayIndex` out-of-bounds.

### C.7.5.11. Changes in MySQL Connector/J 2.0.3 (03 December 2000)

Bugs fixed:

- Fixed composite key problem with updatable result sets.
- Faster ASCII string operations.
- Fixed off-by-one error in `java.sql.Blob` implementation code.
- Fixed incorrect detection of `MAX_ALLOWED_PACKET`, so sending large blobs should work now.
- Added detection of `-/+INF` for doubles.
- Added `ultraDevHack` URL parameter, set to `true` to allow (broken) Macromedia UltraDev to use the driver.
- Implemented `getBigDecimal()` without scale component for JDBC2.

### C.7.5.12. Changes in MySQL Connector/J 2.0.1 (06 April 2000)

Bugs fixed:

- Columns that are of type `TEXT` now return as `Strings` when you use `getObject()`.
- Cleaned up exception handling when driver connects.
- Fixed `RSMD.isWritable()` returning wrong value. Thanks to Moritz Maass.
- `DatabaseMetaData.getPrimaryKeys()` now works correctly with respect to `key_seq`. Thanks to Brian Slesinsky.

- Fixed many JDBC-2.0 traversal, positioning bugs, especially with respect to empty result sets. Thanks to Ron Smits, Nick Brook, Cessar Garcia and Carlos Martinez.
- No escape processing is done on `PreparedStatement` anymore per JDBC spec.
- Fixed some issues with updatability support in `ResultSet` when using multiple primary keys.

#### **C.7.5.13. Changes in MySQL Connector/J 2.0.0pre5 (21 February 2000)**

- Fixed Bad Handshake problem.

#### **C.7.5.14. Changes in MySQL Connector/J 2.0.0pre4 (10 January 2000)**

- Fixes to `ResultSet` for `insertRow()` - Thanks to Cesar Garcia
- Fix to Driver to recognize JDBC-2.0 by loading a JDBC-2.0 class, instead of relying on JDK version numbers. Thanks to John Baker.
- Fixed `ResultSet` to return correct row numbers
- `Statement.getUpdateCount()` now returns rows matched, instead of rows actually updated, which is more SQL-92 like.

10-29-99

- `Statement/PreparedStatement.getMoreResults()` bug fixed. Thanks to Noel J. Bergman.
- Added `Short` as a type to `PreparedStatement.setObject()`. Thanks to Jeff Crowder
- Driver now automagically configures maximum/preferred packet sizes by querying server.
- Autoreconnect code uses fast ping command if server supports it.
- Fixed various bugs with respect to packet sizing when reading from the server and when alloc'ing to write to the server.

#### **C.7.5.15. Changes in MySQL Connector/J 2.0.0pre (17 August 1999)**

- Now compiles under JDK-1.2. The driver supports both JDK-1.1 and JDK-1.2 at the same time through a core set of classes. The driver will load the appropriate interface classes at runtime by figuring out which JVM version you are using.
- Fixes for result sets with all nulls in the first row. (Pointed out by Tim Endres)
- Fixes to column numbers in `SQLExceptions` in `ResultSet` (Thanks to Blas Rodriguez Somoza)
- The database no longer needs to be specified to connect. (Thanks to Christian Motschke)

#### **C.7.6. Changes in MySQL Connector/J 1.2b (04 July 1999)**

- Better Documentation (in progress), in `doc/mm.doc/book1.html`
- DBMD now allows null for a column name pattern (not in spec), which it changes to '%'
- DBMD now has correct types/lengths for `getXXX()`.
- `ResultSet.getDate()`, `getTime()`, and `getTimestamp()` fixes. (contributed by Alan Wilken)
- `EscapeProcessor` now handles `{ }` and `{ or }` inside quotes correctly. (thanks to Alik for some ideas on how to fix it)
- Fixes to properties handling in `Connection`. (contributed by Juho Tikkala)
- `ResultSet.getObject()` now returns null for NULL columns in the table, rather than bombing out. (thanks to Ben Grosman)

- `ResultSet.getObject()` now returns Strings for types from MySQL that it doesn't know about. (Suggested by Chris Perdue)
- Removed `DataInput/Output` streams, not needed, 1/2 number of method calls per IO operation.
- Use default character encoding if one is not specified. This is a work-around for broken JVMs, because according to spec, EVERY JVM must support "ISO8859\_1", but they do not.
- Fixed `Connection` to use the platform character encoding instead of "ISO8859\_1" if one isn't explicitly set. This fixes problems people were having loading the character- converter classes that didn't always exist (JVM bug). (thanks to Fritz Elfert for pointing out this problem)
- Changed `MysqlIO` to re-use packets where possible to reduce memory usage.
- Fixed escape-processor bugs pertaining to { } inside quotes.

## C.7.7. Changes in MySQL Connector/J 1.2.x and lower

### C.7.7.1. Changes in MySQL Connector/J 1.2a (14 April 1999)

- Fixed character-set support for non-Javasoft JVMs (thanks to many people for pointing it out)
- Fixed `ResultSet.getBoolean()` to recognize 'y' & 'n' as well as '1' & '0' as boolean flags. (thanks to Tim Pizey)
- Fixed `ResultSet.getTimestamp()` to give better performance. (thanks to Richard Swift)
- Fixed `getBytes()` for numeric types. (thanks to Ray Bellis)
- Fixed `DatabaseMetaData.getTypeInfo()` for DATE type. (thanks to Paul Johnston)
- Fixed `EscapeProcessor` for "fn" calls. (thanks to Piyush Shah at locomotive.org)
- Fixed `EscapeProcessor` to not do extraneous work if there are no escape codes. (thanks to Ryan Gustafson)
- Fixed `Driver` to parse URLs of the form "jdbc:mysql://host:port" (thanks to Richard Lobb)

### C.7.7.2. Changes in MySQL Connector/J 1.1i (24 March 1999)

- Fixed Timestamps for `PreparedStatement`s
- Fixed null pointer exceptions in `RSMD` and `RS`
- Re-compiled with jikes for valid class files (thanks ms!)

### C.7.7.3. Changes in MySQL Connector/J 1.1h (08 March 1999)

- Fixed escape processor to deal with unmatched { and } (thanks to Craig Coles)
- Fixed escape processor to create more portable (between DATETIME and TIMESTAMP types) representations so that it will work with BETWEEN clauses. (thanks to Craig Longman)
- `MysqlIO.quit()` now closes the socket connection. Before, after many failed connections some OS's would run out of file descriptors. (thanks to Michael Brinkman)
- Fixed `NullPointerException` in `Driver.getPropertyInfo`. (thanks to Dave Potts)
- Fixes to `MysqlDefs` to allow all \*text fields to be retrieved as Strings. (thanks to Chris at Leverage)
- Fixed `setDouble` in `PreparedStatement` for large numbers to avoid sending scientific notation to the database. (thanks to J.S. Ferguson)
- Fixed `getScale()` and `getPrecision()` in `RSMD`. (contrib'd by James Klicman)
- Fixed `getObject()` when field was DECIMAL or NUMERIC (thanks to Bert Hobbs)

- `DBMD.getTables()` bombed when passed a null table-name pattern. Fixed. (thanks to Richard Lobb)
- Added check for "client not authorized" errors during connect. (thanks to Hannes Wallnoefer)

#### **C.7.7.4. Changes in MySQL Connector/J 1.1g (19 February 1999)**

- Result set rows are now byte arrays. Blobs and Unicode work bidirectionally now. The `useUnicode` and encoding options are implemented now.
- Fixes to `PreparedStatement` to send binary set by `setXXXStream` to be sent untouched to the MySQL server.
- Fixes to `getDriverPropertyInfo()`.

#### **C.7.7.5. Changes in MySQL Connector/J 1.1f (31 December 1998)**

- Changed all `ResultSet` fields to Strings, this should allow Unicode to work, but your JVM must be able to convert between the character sets. This should also make reading data from the server be a bit quicker, because there is now no conversion from `StringBuffer` to `String`.
- Changed `PreparedStatement.streamToString()` to be more efficient (code from Uwe Schaefer).
- URL parsing is more robust (throws SQL exceptions on errors rather than `NullPointerExceptions`)
- `PreparedStatement` now can convert Strings to Time/Date values via `setObject()` (code from Robert Currey).
- IO no longer hangs in `Buffer.readInt()`, that bug was introduced in 1.1d when changing to all byte-arrays for result sets. (Pointed out by Samo Login)

#### **C.7.7.6. Changes in MySQL Connector/J 1.1b (03 November 1998)**

- Fixes to `DatabaseMetaData` to allow both IBM VA and J-Builder to work. Let me know how it goes. (thanks to Jac Kersing)
- Fix to `ResultSet.getBoolean()` for NULL strings (thanks to Barry Lagerweij)
- Beginning of code cleanup, and formatting. Getting ready to branch this off to a parallel JDBC-2.0 source tree.
- Added "final" modifier to critical sections in `MysqlIO` and `Buffer` to allow compiler to inline methods for speed.

9-29-98

- If object references passed to `setXXX()` in `PreparedStatement` are null, `setNull()` is automatically called for you. (Thanks for the suggestion goes to Erik Ostrom)
- `setObject()` in `PreparedStatement` will now attempt to write a serialized representation of the object to the database for objects of `Types.OTHER` and objects of unknown type.
- `Util` now has a static method `readObject()` which given a `ResultSet` and a column index will re-instantiate an object serialized in the above manner.

#### **C.7.7.7. Changes in MySQL Connector/J 1.1 (02 September 1998)**

- Got rid of "ugly hack" in `MysqlIO.nextRow()`. Rather than catch an exception, `Buffer.isLastDataPacket()` was fixed.
- `Connection.getCatalog()` and `Connection.setCatalog()` should work now.
- `Statement.setMaxRows()` works, as well as setting by property `maxRows`. `Statement.setMaxRows()` overrides `maxRows` set via properties or url parameters.
- Automatic re-connection is available. Because it has to "ping" the database before each query, it is turned off by default. To use it, pass in "autoReconnect=true" in the connection URL. You may also change the number of reconnect tries, and the initial timeout value via "maxReconnects=n" (default 3) and "initialTimeout=n" (seconds, default 2) parameters. The timeout is an ex-

ponential backoff type of timeout; for example, if you have initial timeout of 2 seconds, and maxReconnects of 3, then the driver will timeout 2 seconds, 4 seconds, then 16 seconds between each re-connection attempt.

### C.7.7.8. Changes in MySQL Connector/J 1.0 (24 August 1998)

- Fixed handling of blob data in Buffer.java
- Fixed bug with authentication packet being sized too small.
- The JDBC Driver is now under the LGPL

8-14-98

- Fixed Buffer.readLenString() to correctly read data for BLOBS.
- Fixed PreparedStatement.stringToStream to correctly read data for BLOBS.
- Fixed PreparedStatement.setDate() to not add a day. (above fixes thanks to Vincent Partington)
- Added URL parameter parsing (?user=... and so forth).

### C.7.7.9. Changes in MySQL Connector/J 0.9d (04 August 1998)

- Big news! New package name. Tim Endres from ICE Engineering is starting a new source tree for GNU GPL'd Java software. He's graciously given me the org.gjt.mm package directory to use, so now the driver is in the org.gjt.mm.mysql package scheme. I'm "legal" now. Look for more information on Tim's project soon.
- Now using dynamically sized packets to reduce memory usage when sending commands to the DB.
- Small fixes to getTypeInfo() for parameters, and so forth.
- DatabaseMetaData is now fully implemented. Let me know if these drivers work with the various IDEs out there. I've heard that they're working with JBuilder right now.
- Added JavaDoc documentation to the package.
- Package now available in .zip or .tar.gz.

### C.7.7.10. Changes in MySQL Connector/J 0.9 (28 July 1998)

- Implemented getTypeInfo(). Connection.rollback() now throws an SQLException per the JDBC spec.
- Added PreparedStatement that supports all JDBC API methods for PreparedStatement including InputStreams. Please check this out and let me know if anything is broken.
- Fixed a bug in ResultSet that would break some queries that only returned 1 row.
- Fixed bugs in DatabaseMetaData.getTables(), DatabaseMetaData.getColumns() and DatabaseMetaData.getCatalogs().
- Added functionality to Statement that allows executeUpdate() to store values for IDs that are automatically generated for AUTO\_INCREMENT fields. Basically, after an executeUpdate(), look at the SQLWarnings for warnings like "LAST\_INSERTED\_ID = 'some number', COMMAND = 'your SQL query'". If you are using AUTO\_INCREMENT fields in your tables and are executing a lot of executeUpdate(s) on one Statement, be sure to clearWarnings() every so often to save memory.

### C.7.7.11. Changes in MySQL Connector/J 0.8 (06 July 1998)

- Split MysqlIO and Buffer to separate classes. Some ClassLoaders gave an IllegalAccessException error for some fields in those two classes. Now mm.mysql works in applets and all classloaders. Thanks to Joe Ennis <jce@mail.boone.com> for pointing out the problem and working on a fix with me.

### C.7.7.12. Changes in MySQL Connector/J 0.7 (01 July 1998)

- Fixed DatabaseMetadata problems in `getColumns()` and bug in switch statement in the Field constructor. Thanks to Costin Manolache <costin@tdiinc.com> for pointing these out.

### C.7.7.13. Changes in MySQL Connector/J 0.6 (21 May 1998)

- Incorporated efficiency changes from Richard Swift <Richard.Swift@kanatek.ca> in `MysqlIO.java` and `ResultSet.java`:
- We're now 15% faster than gwe's driver.
- Started working on `DatabaseMetaData`.
- The following methods are implemented:
  - `getTables()`
  - `getTableTypes()`
  - `getColumns()`
  - `getCatalogs()`

## C.8. MySQL Connector/MXJ Change History

### C.8.1. Changes in MySQL Connector/MXJ 5.0.6 (04 May 2007)

Functionality added or changed:

- Updated internal jar file names to include version information and be more consistent with Connector/J jar naming. For example, `connector-mxj.jar` is now `mysql-connector-mxj-${mxj-version}.jar`.
- Updated commercial license files.
- Added copyright notices to some classes which were missing them.
- Added `InitializeUser` and `QueryUtil` classes to support new feature.
- Added new tests for initial-user & expanded some existing tests.
- `ConnectorMXJUrlTestExample` and `ConnectorMXJObjectTestExample` now demonstrate the initialization of user/password and creating the initial database (rather than using "test").
- Added new connection property `initialize-user` which, if set to `true` will remove the default, un-passworded anonymous and root users, and create the user/password from the connection url.
- Removed obsolete field `SimpleMysqlJDynamicMBean.lastInvocation`.
- Clarified code in `DefaultsMap.entrySet()`.
- Removed obsolete `PatchedStandardSocketFactory` java file.
- Added `main(String[])` to `com/mysql/management/AllTestsSuite.java`.
- Errors reading `portFile` are now reported using `stacktrace(err)`, previously `System.err` was used.
- `portFile` now contains a new-line to be consistent with `pidFile`.
- Fixed where `versionString.trim()` was ignored.
- Removed references to `File.deleteOnExit`, a warning is printed instead.

Bugs fixed:

- Changed tests to shutdown mysqld prior to deleting files.
- Fixed port file to always be written to datadir.
- Added os.name-os.arch to resource directory mapping properties file.
- Swapped out commercial binaries for v5.0.40.
- Delete `portFile` on shutdown.
- Moved `platform-map.properties` into `db-files.jar`.
- Clarified the startup max wait numbers.
- Updated `build.xml` in preparation for next beta build.
- Removed `use-default-architecture` property replaced.
- Added null-check to deal with C/MXJ being loaded by the bootstrap classloaders with JVMs for which `getClassLoader()` returns null.
- Added robustness around reading portfile.
- Removed `PatchedStandardSocketFactory` (fixed in Connector/J 5.0.6).
- Refactored duplication from tests and examples to `QueryUtil`.
- Removed obsolete `InitializePasswordExample`

## C.8.2. Changes in MySQL Connector/MXJ 5.0.5 (14 March 2007)

Bugs fixed:

- Moved `MysqldFactory` to main package.
- Reformatting: Added newlines some files which did not end in them.
- Swapped out commercial binaries for v5.0.36.
- Found and removed dynamic linking in `mysql_kill`; updated solution.
- Changed protected constructor of `SimpleMysqldDynamicMBean` from taking a `MysqldResource` to taking a `MysqldFactory`, in order to lay groundwork for addressing BUG discovered by Andrew Rubinger. See: [MySQL Forums](#) (Actual testing with JBoss, and filing a bug, is still required.)
- `build.xml: usage` now slightly more verbose; some reformatting.
- Now incorporates Reggie Bennett's `SafeTerminateProcess` and only calls the unsafe `TerminateProcess` as a final last resort.
- New windows `kill.exe` fixes bug where mysqld was being force terminated. Issue reported by bruno haleblan and others, see: [MySQL Forums](#).
- Replaced `Boolean.parseBoolean` with JDK 1.4 compliant `valueOf`.
- Changed `connector-mxj.properties` default mysql version to 5.0.37.
- In testing so far mysqld reliably shuts down cleanly much faster.
- Added testcase to `com.mysql.management.jmx.AcceptanceTest` which demonstrates that `dataDir` is a mutable MBean property.
- Updated `build.xml` in prep for next release.
- Changed `SimpleMysqldDynamicMBean` to create `MysqldResource` on demand in order to allow setting of `datadir`. (Rubinger bug groundwork).
- Clarified the synchronization of `MysqldResource` methods.



- `SIGHUP` is replaced with `MySQLShutdown<PID>` event.
- Clarified the immutability of `baseDir`, `dataDir`, `pidFile`, `portFile`.
- Added 5.1.15 binaries to the repository.
- Removed 5.1.14 binaries from the repository.
- Added `getDataDir()` to interface `MySqlResourceI`.
- Added 5.1.14 binaries to repository.
- Replaced windows `kill.exe` resource with re-written version specific to `mysqld`.
- Added Patched `StandardSocketFactory` from Connector/J 5-0 HEAD.
- Ensured 5.1.14 compatibility.
- Swapped out gpl binaries for v5.0.37.
- Removed 5.0.22 binaries from the repository.

### C.8.3. Changes in MySQL Connector/MXJ 5.0.4 (28 January 2007)

Bugs fixed:

- Allow multiple calls to start server from URL connection on non-3306 port. ([Bug#24004](#))
- Updated `build.xml` to build to handle with different gpl and commercial `mysqld` version numbers.
- Only populate the options map from the help text if specifically requested or in the MBean case.
- Introduced property for Linux & WinXX to default to 32bit versions.
- Swapped out gpl binaries for v5.0.27.
- Swapped out commercial binaries for v5.0.32.
- Moved `mysqld` binary resourced into separate jar file NOTICE: `CLASSPATH` will now need to `connector-mxj-db-files.jar`.
- Minor test robustness improvements.
- Moved default version string out of java class into a text editable properties file (`connector-mxj.properties`) in the resources directory.
- Fixed test to be tollerant of `/tmp` being a symlink to `/foo/tmp`.

### C.8.4. Changes in MySQL Connector/MXJ 5.0.3 (24 June 2006)

Bugs fixed:

- Removed unused imports, formatted code, made minor edits to tests.
- Removed "TeeOutputStream" - no longer needed.
- Swapped out the `mysqld` binaries for MySQL v5.0.22.

### C.8.5. Changes in MySQL Connector/MXJ 5.0.2 (15 June 2006)

Bugs fixed:

- Replaced string parsing with JDBC connection attempt for determining if a `mysqld` is "ready for connections" `CLASSPATH` will now need to include Connector/J jar.

- "platform" directories replace spaces with underscores
- extracted array and list printing to ListToString utility class
- Swapped out the mysqld binaries for MySQL v5.0.21
- Added trace level logging with Aspect/J. `CLASSPATH` will now need to include `lib/aspectjrt.jar`
- reformatted code
- altered to be "basedir" rather than "port" oriented.
- help parsing test reflects current help options
- insulated users from problems with "." in basedir
- swapped out the mysqld binaries for MySQL v5.0.18
- Made tests more robust by deleting the `/tmp/test-c.mxj` directory before running tests.
- `ServerLauncherSocketFactory.shutdown` API change: now takes File parameter (basedir) instead of port.
- socket is now "mysql.sock" in datadir
- added ability to specify "mysql-version" as an url parameter
- Extended timeout for help string parsing, to avoid cases where the help text was getting prematurely flushed, and thus truncated.
- swapped out the mysqld binaries for MySQL v5.0.19
- `MysqldResource` now tied to `dataDir` as well as `basedir` (API CHANGE)
- moved PID file into datadir
- `ServerLauncherSocketFactory.shutdown` now works across JVMs.
- extracted `splitLines(String)` to `Str` utility class
- `ServerLauncherSocketFactory.shutdown(port)` no longer throws, only reports to `System.err`
- `ServerLauncherSocketFactory` now treats URL parameters in the form of `&server.foo=null` as `serverOptionMap.put("foo", null)`
- `ServerLauncherSocketFactory.shutdown` API change: now takes 2 File parameters (basedir, datadir)

## C.8.6. Changes in MySQL Connector/MXJ 5.0.1 (Never released)

This was an internal only release.

## C.8.7. Changes in MySQL Connector/MXJ 5.0.0 (09 December 2005)

Bugs fixed:

- Removed `HelpOptionsParser`'s need to reference a `MysqldResource`.
- Reorganized utils into a single "Utils" collaborator.
- Minor test tweaks
- Altered examples and tests to use new Connector/J 5.0 URL syntax for launching Connector/MXJ ("`jdbc:mysql:mxj://`")
- Swapped out the mysqld binaries for MySQL v5.0.16.
- Ditched "ClassUtil" (merged with `Str`).
- Minor refactorings for type casting and exception handling.

## C.9. MySQL Proxy Change History

### C.9.1. Changes in MySQL Proxy 0.7.0 (Not yet released)

Bugs fixed:

- **Security Enhancement:** Accessing `mysql-proxy` using a client or backend with a MySQL protocol less than MySQL 5.0 would result in `mysql-proxy` aborting with an assertion. This is because `mysql-proxy` only supports MySQL Protocol 5.0 or higher. The proxy will now report a fault. ([Bug#31419](#))
- Using `mysql-proxy` with very large return datasets from queries, with or without manipulate of the dataset within the Lua engine could cause a crash. ([Bug#39332](#))
- If a submitted packet was smaller than expected by the protocol, MySQL Proxy would terminate. ([Bug#36743](#))
- When using `mysql-proxy` in a master-master replication scenario, a failure in one of the replication masters would fail to be identified by the proxy and connections would not be redirected to the other master. ([Bug#35295](#))

### C.9.2. Changes in MySQL Proxy 0.6.1 (06 February 2008)

Functionality added or changed:

- Fixed assertions on write-errors
- Fixed sending fake server-greetings in `connect_server()`.
- Fixed error handling for socket functions on Windows.
- Added new features to `run-tests.lua`.

### C.9.3. Changes in MySQL Proxy 0.6.0 (11 September 2007)

Functionality added or changed:

- When using read/write splitting and the `rw-splitting.lua` example script, connecting a second user to the proxy returns an error message. ([Bug#30867](#))
- Added support in `read_query_result()` to overwrite the result-set.
- Added `--no-daemon` and `--pid-file`.
- Added hooks for `read_auth()`, `read_handshake()` and `read_auth_result()`.
- Added handling of `proxy.connection.backend_ndx` in `connect_server()` and `read_query()` to support read/write splitting.
- Added support for `proxy.response.packets`.
- Added testcases.
- Added `--no-proxy` to disable the proxy.
- Added support for listening UNIX sockets.
- Added a global lua-scope `proxy.global.*`.
- Added connection pooling.

Bugs fixed:

- Fixed assertion on `COM_BINLOG_DUMP`. ([Bug#29764](#))
- Fixed assertion on result-packets like `[ field-len | fields | EOF | ERR ]`. ([Bug#29732](#))

- Fixed assertion at login with empty password + empty default db. (Bug#29719)
- Fixed assertion at `COM_SHUTDOWN`. (Bug#29719)
- Fixed crash if `proxy.connection` is used in `connect_server()`.
- Fixed check for `glib2` to require at least 2.6.0.
- Fixed assertion when all backends are down and we try to connect.
- Fixed connection-stalling if `read_query_result()` throws an `assert()` ion.
- Fixed len-encoding on `proxy.resultsets`.
- Fixed compilation on win32.
- Fixed assertion when connecting to the MySQL 6.0.1.
- Fixed decoding of len-encoded ints for 3-byte notation.
- Fixed `inj.resultset.affected_rows` on `SELECT` queries.
- Fixed handling of (SQL) `NULL` in result-sets.
- Fixed mem-leak with `proxy.response.*` is used.

#### C.9.4. Changes in MySQL Proxy 0.5.1 (30 June 2007)

Functionality added or changed:

- Added `resultset.affected_rows` and `resultset.insert_id`.
- Changed `--proxy.profiling` to `--proxy-skip-profiling`.
- Added missing dependency to `libmysqlclient-dev` to the `INSTALL` file.
- Added `inj.query_time` and `inj.response_time` into the lua scripts.
- Added support for pre-4.1 passwords in a 4.1 connection.
- Added script examples for rewriting and injection.
- Added `proxy.VERSION`.
- Added support for UNIX sockets.
- Added protection against duplicate resultsets from a script.

Bugs fixed:

- Fixed mysql check in configure to die when `mysql.h` isn't detected.
- Fixed handling of duplicate ERR on `COM_CHANGE_USER` in MySQL 5.1.18+.
- Fixed compile error with MySQL 4.1.x on missing `COM_STMT_*`.
- Fixed crash on fields > 250 bytes when the resultset is inspected.
- Fixed warning if `connect_server()` is not provided.
- Fixed assertion when a error occurs at initial script exec time.
- Fixed assertion when `read_query_result()` is not provided when `PROXY_SEND_QUERY` is used.

#### C.9.5. Changes in MySQL Proxy 0.5.0 (19 June 2007)

This is the first beta release.

Bugs fixed:

- Added [automake/autoconf](#) support.
- Added [cmake](#) support.

---

## Appendix D. Restrictions and Limits

The discussion here describes restrictions that apply to the use of MySQL features such as subqueries or views.

### D.1. Restrictions on Stored Routines, Triggers, and Events

Some of the restrictions noted here apply to all stored routines; that is, both to stored procedures and stored functions. Some of these restrictions apply to stored functions but not to stored procedures.

The restrictions for stored functions also apply to triggers. There are also some restrictions specific to triggers.

The restrictions for stored procedures also apply to the `DO` clause of Event Scheduler event definitions. There are also some restrictions specific to events.

Stored routines cannot contain arbitrary SQL statements. The following statements are disallowed:

- The locking statements `LOCK TABLES` and `UNLOCK TABLES`.
- `ALTER VIEW`. (Before MySQL 5.1.21, this restriction is enforced only for stored functions.)
- `LOAD DATA` and `LOAD TABLE`.
- SQL prepared statements (`PREPARE`, `EXECUTE`, `DEALLOCATE PREPARE`) can be used in stored procedures, but not stored functions or triggers. Implication: You cannot use dynamic SQL within stored functions or triggers (where you construct dynamically statements as strings and then execute them).

In addition, SQL statements that are not permitted within prepared statements are also not permitted in stored routines. See [Section 12.7, “SQL Syntax for Prepared Statements”](#), for a list of statements supported as prepared statements. Statements not listed there are not supported for SQL prepared statements and thus are also not supported for stored routines unless noted otherwise in [Section 18.2, “Using Stored Routines \(Procedures and Functions\)”](#).

- Inserts cannot be delayed. `INSERT DELAYED` syntax is accepted but the statement is handled as a normal `INSERT`.
- Within all stored programs (stored procedures and functions, triggers, and events), the parser treats `BEGIN [WORK]` as the beginning of a `BEGIN . . . END` block. Begin a transaction in this context with `START TRANSACTION` instead.

For stored functions (but not stored procedures), the following additional statements or operations are disallowed:

- Statements that perform explicit or implicit commit or rollback. Support for these statements is not required by the SQL standard, which states that each DBMS vendor may decide whether to allow them.
- Statements that return a result set. This includes `SELECT` statements that do not have an `INTO var_list` clause and other statements such as `SHOW`, `EXPLAIN`, and `CHECK TABLE`. A function can process a result set either with `SELECT . . . INTO var_list` or by using a cursor and `FETCH` statements. See [Section 12.8.3.3, “SELECT . . . INTO Statement”](#).
- `FLUSH` statements.
- Stored functions cannot be used recursively.
- Within a stored function or trigger, it is not permitted to modify a table that is already being used (for reading or writing) by the statement that invoked the function or trigger.
- If you refer to a temporary table multiple times in a stored function under different aliases, a `Can't reopen table: 'tbl_name'` error occurs, even if the references occur in different statements within the function.
- A stored function acquires table locks before executing, to avoid inconsistency in the binary log due to mismatch of the order in which statements execute and when they appear in the log. When statement-based binary logging is used, statements that invoke a function are recorded rather than the statements executed within the function. Consequently, stored functions that update the same underlying tables do not execute in parallel. In contrast, stored procedures do not acquire table-level locks. All statements executed within stored procedures are written to the binary log even for statement-based binary logging. See [Section 18.6, “Binary Logging of Stored Programs”](#).

Although some restrictions normally apply to stored functions and triggers but not to stored procedures, those restrictions do apply to stored procedures if they are invoked from within a stored function or trigger. For example, if you use `FLUSH` in a stored procedure, that stored procedure cannot be called from a stored function or trigger.

It is possible for the same identifier to be used for a routine parameter, a local variable, and a table column. Also, the same local variable name can be used in nested blocks. For example:

```
CREATE PROCEDURE p (i INT)
BEGIN
  DECLARE i INT DEFAULT 0;
  SELECT i FROM t;
  BEGIN
    DECLARE i INT DEFAULT 1;
    SELECT i FROM t;
  END;
END;
```

In such cases the identifier is ambiguous and the following precedence rules apply:

- A local variable takes precedence over a routine parameter or table column
- A routine parameter takes precedence over a table column
- A local variable in an inner block takes precedence over a local variable in an outer block

The behavior that variables take precedence over table columns is non-standard.

Use of stored routines can cause replication problems. This issue is discussed further in [Section 18.6, “Binary Logging of Stored Programs”](#).

`INFORMATION_SCHEMA` does not have a `PARAMETERS` table until MySQL 6.0, so applications that need to acquire routine parameter information at runtime must use workarounds such as parsing the output of `SHOW CREATE` statements or the `param_list` column of the `mysql.proc` table. `param_list` contents can be processed from within a stored routine, unlike the output from `SHOW`.

There are no stored routine debugging facilities.

Before MySQL 5.1.4, `CALL` statements cannot be prepared. This true both for server-side prepared statements and for SQL prepared statements.

`UNDO` handlers are not supported.

`FOR` loops are not supported.

To prevent problems of interaction between server threads, when a client issues a statement, the server uses a snapshot of routines and triggers available for execution of the statement. That is, the server calculates a list of procedures, functions, and triggers that may be used during execution of the statement, loads them, and then proceeds to execute the statement. This means that while the statement executes, it will not see changes to routines performed by other threads.

For triggers, the following additional statements or operations are disallowed:

- Triggers currently are not activated by foreign key actions.
- When using row-based replication, triggers on the slave are not activated by statements originating on the master. This does not apply when using statement-based replication. For more information, see [Section 16.3.1.26, “Replication and Triggers”](#).
- The `RETURN` statement is disallowed in triggers, which cannot return a value. To exit a trigger immediately, use the `LEAVE` statement.
- Triggers are not allowed on tables in the `mysql` database.

The following limitations are specific to the Event Scheduler:

- In MySQL 5.1.6 only, any table referenced in an event's action statement must be fully qualified with the name of the schema in which it occurs (that is, as `schema_name.table_name`).
- Beginning with MySQL 5.1.8, event names are handled in case-insensitive fashion. For example, this means that you cannot have two events in the same database (and — prior to MySQL 5.1.12 — with the same definer) with the names `anEvent` and `AnEvent`.

### ■ Important

If you have events created in MySQL 5.1.7 or earlier which are assigned to the same database and have the same definer, and whose names differ only with respect to lettercase, then you must rename these events to respect case-sensitive handling before upgrading to MySQL 5.1.8 or later.

- An event may not be created, altered, or dropped by a stored routine, trigger, or another event. An event also may not create, alter, or drop stored routines or triggers. (Bug#16409, Bug#18896)
- Event timings using the intervals `YEAR`, `QUARTER`, `MONTH`, and `YEAR_MONTH` are resolved in months; those using any other interval are resolved in seconds. There is no way to cause events scheduled to occur at the same second to execute in a given order. In addition — due to rounding, the nature of threaded applications, and the fact that a nonzero length of time is required to create events and to signal their execution — events may be delayed by as much as 1 or 2 seconds. However, the time shown in the `INFORMATION_SCHEMA.EVENTS` table's `LAST_EXECUTED` column or the `mysql.event` table's `last_executed` column is always accurate to within one second of the actual event execution time. (See also Bug#16522.)
- Each execution of the statements contained in the body of an event takes place in a new connection; thus, these statements has no effect in a given user session on the server's statement counts such as `Com_select` and `Com_insert` that are displayed by `SHOW STATUS`. However, such counts *are* updated in the global scope. (Bug#16422)
- Prior to MySQL 5.1.12, you could not view another user's events in the `INFORMATION_SCHEMA.EVENTS` table. In other words, any query made against this table was treated as though it contained the condition `DEFINER = CURRENT_USER()` in the `WHERE` clause.
- Events do not support times later than the end of the Unix Epoch; this is approximately the beginning of the year 2038. Prior to MySQL 5.1.8, handling in scheduled events of dates later than this was buggy; starting with MySQL 5.1.8, such dates are specifically disallowed by the Event Scheduler. (Bug#16396)
- In MySQL 5.1.6, `INFORMATION_SCHEMA.EVENTS` shows `NULL` in the `SQL_MODE` column. Beginning with MySQL 5.1.7, the `SQL_MODE` displayed is that in effect when the event was created.
- In MySQL 5.1.6, the only way to drop or alter an event created by a user who was not the definer of that event was by manipulation of the `mysql.event` system table by the MySQL `root` user or by another user with privileges on this table. Beginning with MySQL 5.1.7, `DROP USER` drops all events for which that user was the definer; also beginning with MySQL 5.1.7 `DROP SCHEMA` drops all events associated with the dropped schema.
- References to stored functions, user-defined functions, and tables in the `ON SCHEDULE` clauses of `CREATE EVENT` and `ALTER EVENT` statements are not supported. Beginning with MySQL 5.1.13, these sorts of references are disallowed. (See Bug#22830 for more information.)
- Generally speaking, statements which are not permitted in stored routines or in SQL prepared statements are also not allowed in the body of an event. For more information, see Section 12.7, “SQL Syntax for Prepared Statements”.
- When upgrading to MySQL 5.1.18 or 5.1.19 from a previous MySQL version where scheduled events were in use, the upgrade utilities `mysql_upgrade` and `mysql_fix_privilege_tables` do not accomodate changes in system tables relating to the Event Scheduler. This issue was fixed in MySQL 5.1.20 (see Bug#28521).

**Stored routines and triggers in MySQL Cluster.** Stored functions, stored procedures, and triggers are all supported by tables using the `NDB` storage engine; however, it is important to keep in mind that they do *not* propagate automatically between MySQL Servers acting as Cluster SQL nodes. This is because of the following:

- Stored routine definitions are kept in tables in the `mysql` system database using the `MyISAM` storage engine, and so do not participate in clustering.
- The `.TRN` and `.TRG` files containing trigger definitions are not read by the `NDB` storage engine, and are not copied between Cluster nodes.

Any stored routine or trigger that interacts with MySQL Cluster tables must be re-created by running the appropriate `CREATE PROCEDURE`, `CREATE FUNCTION`, or `CREATE TRIGGER` statements on each MySQL Server that participates in the cluster where you wish to use the stored routine or trigger. Similarly, any changes to existing stored routines or triggers must be carried out explicitly on all Cluster SQL nodes, using the appropriate `ALTER` or `DROP` statements on each MySQL Server accessing the cluster.

### Warning

Do *not* attempt to work around the issue described in the first item mentioned previously by converting any `mysql` database tables to use the `NDB` storage engine. *Altering the system tables in the `mysql` database is not supported* and is very likely to produce undesirable results.



## D.2. Restrictions on Server-Side Cursors

Server-side cursors are implemented in the C API via the `mysql_stmt_attr_set()` function. The same implementation is used for cursors in stored routines. A server-side cursor allows a result set to be generated on the server side, but not transferred to the client except for those rows that the client requests. For example, if a client executes a query but is only interested in the first row, the remaining rows are not transferred.

In MySQL, a server-side cursor is materialized into a temporary table. Initially, this is a `MEMORY` table, but is converted to a `MyISAM` table if its size reaches the value of the `max_heap_table_size` system variable. One limitation of the implementation is that for a large result set, retrieving its rows through a cursor might be slow.

Cursors are read only; you cannot use a cursor to update rows.

`UPDATE WHERE CURRENT OF` and `DELETE WHERE CURRENT OF` are not implemented, because updatable cursors are not supported.

Cursors are non-holdable (not held open after a commit).

Cursors are asensitive.

Cursors are non-scrollable.

Cursors are not named. The statement handler acts as the cursor ID.

You can have open only a single cursor per prepared statement. If you need several cursors, you must prepare several statements.

You cannot use a cursor for a statement that generates a result set if the statement is not supported in prepared mode. This includes statements such as `CHECK TABLE`, `HANDLER READ`, and `SHOW BINLOG EVENTS`.

## D.3. Restrictions on Subqueries

- In MySQL 5.1 before 5.1.16, if you compare a `NULL` value to a subquery using `ALL`, `ANY`, or `SOME`, and the subquery returns an empty result, the comparison might evaluate to the non-standard result of `NULL` rather than to `TRUE` or `FALSE`. As of 5.1.16, the comparison evaluates to `TRUE` or `FALSE` except for subqueries inside `IS NULL`, such as this:

```
SELECT ... WHERE NULL IN (SELECT ...) IS NULL
```

As of 5.1.32, the `IS NULL` limitation is removed and the comparison evaluates to `TRUE` or `FALSE`.

- A subquery's outer statement can be any one of: `SELECT`, `INSERT`, `UPDATE`, `DELETE`, `SET`, or `DO`.
- Subquery optimization for `IN` is not as effective as for the `=` operator or for the `IN(value_list)` operator.

A typical case for poor `IN` subquery performance is when the subquery returns a small number of rows but the outer query returns a large number of rows to be compared to the subquery result.

The problem is that, for a statement that uses an `IN` subquery, the optimizer rewrites it as a correlated subquery. Consider the following statement that uses an uncorrelated subquery:

```
SELECT ... FROM t1 WHERE t1.a IN (SELECT b FROM t2);
```

The optimizer rewrites the statement to a correlated subquery:

```
SELECT ... FROM t1 WHERE EXISTS (SELECT 1 FROM t2 WHERE t2.b = t1.a);
```

If the inner and outer queries return  $M$  and  $N$  rows, respectively, the execution time becomes on the order of  $O(M \times N)$ , rather than  $O(M+N)$  as it would be for an uncorrelated subquery.

An implication is that an `IN` subquery can be much slower than a query written using an `IN(value_list)` operator that lists the same values that the subquery would return.

- In general, you cannot modify a table and select from the same table in a subquery. For example, this limitation applies to statements of the following forms:

```
DELETE FROM t WHERE ... (SELECT ... FROM t ...);
UPDATE t ... WHERE col = (SELECT ... FROM t ...);
{INSERT|REPLACE} INTO t (SELECT ... FROM t ...);
```

Exception: The preceding prohibition does not apply if you are using a subquery for the modified table in the `FROM` clause. Example:

```
UPDATE t ... WHERE col = (SELECT * FROM (SELECT ... FROM t...) AS _t ...);
```

Here the prohibition does not apply because the result from a subquery in the `FROM` clause is stored as a temporary table, so the relevant rows in `t` have already been selected by the time the update to `t` takes place.

- Row comparison operations are only partially supported:
  - For `expr IN (subquery)`, `expr` can be an  $n$ -tuple (specified via row constructor syntax) and the subquery can return rows of  $n$ -tuples.
  - For `expr op {ALL|ANY|SOME} (subquery)`, `expr` must be a scalar value and the subquery must be a column subquery; it cannot return multiple-column rows.

In other words, for a subquery that returns rows of  $n$ -tuples, this is supported:

```
(val_1, ..., val_n) IN (subquery)
```

But this is not supported:

```
(val_1, ..., val_n) op {ALL|ANY|SOME} (subquery)
```

The reason for supporting row comparisons for `IN` but not for the others is that `IN` is implemented by rewriting it as a sequence of `=` comparisons and `AND` operations. This approach cannot be used for `ALL`, `ANY`, or `SOME`.

- Row constructors are not well optimized. The following two expressions are equivalent, but only the second can be optimized:

```
(col1, col2, ...) = (val1, val2, ...)
col1 = val1 AND col2 = val2 AND ...
```

- Subqueries in the `FROM` clause cannot be correlated subqueries. They are materialized (executed to produce a result set) before evaluating the outer query, so they cannot be evaluated per row of the outer query.
- The optimizer is more mature for joins than for subqueries, so in many cases a statement that uses a subquery can be executed more efficiently if you rewrite it as a join.

An exception occurs for the case where an `IN` subquery can be rewritten as a `SELECT DISTINCT` join. Example:

```
SELECT col FROM t1 WHERE id_col IN (SELECT id_col2 FROM t2 WHERE condition);
```

That statement can be rewritten as follows:

```
SELECT DISTINCT col FROM t1, t2 WHERE t1.id_col = t2.id_col AND condition;
```

But in this case, the join requires an extra `DISTINCT` operation and is not more efficient than the subquery.

- Possible future optimization: MySQL does not rewrite the join order for subquery evaluation. In some cases, a subquery could be executed more efficiently if MySQL rewrote it as a join. This would give the optimizer a chance to choose between more execution plans. For example, it could decide whether to read one table or the other first.

Example:

```
SELECT a FROM outer_table AS ot
WHERE a IN (SELECT a FROM inner_table AS it WHERE ot.b = it.b);
```

For that query, MySQL always scans `outer_table` first and then executes the subquery on `inner_table` for each row. If `outer_table` has a lot of rows and `inner_table` has few rows, the query probably will not be as fast as it could be.

The preceding query could be rewritten like this:

```
SELECT a FROM outer_table AS ot, inner_table AS it
WHERE ot.a = it.a AND ot.b = it.b;
```

In this case, we can scan the small table (`inner_table`) and look up rows in `outer_table`, which will be fast if there is an index on `(ot.a, ot.b)`.

- Possible future optimization: A correlated subquery is evaluated for each row of the outer query. A better approach is that if the outer row values do not change from the previous row, do not evaluate the subquery again. Instead, use its previous result.
- Possible future optimization: A subquery in the `FROM` clause is evaluated by materializing the result into a temporary table, and this table does not use indexes. This does not allow the use of indexes in comparison with other tables in the query, although that might be useful.
- Possible future optimization: If a subquery in the `FROM` clause resembles a view to which the merge algorithm can be applied, rewrite the query and apply the merge algorithm so that indexes can be used. The following statement contains such a subquery:

```
SELECT * FROM (SELECT * FROM t1 WHERE t1.t1_col)
             AS _t1, t2 WHERE t2.t2_col;
```

The statement can be rewritten as a join like this:

```
SELECT * FROM t1, t2 WHERE t1.t1_col AND t2.t2_col;
```

This type of rewriting would provide two benefits:

- It avoids the use of a temporary table for which no indexes can be used. In the rewritten query, the optimizer can use indexes on `t1`.
- It gives the optimizer more freedom to choose between different execution plans. For example, rewriting the query as a join allows the optimizer to use `t1` or `t2` first.
- Possible future optimization: For `IN`, `= ANY`, `<> ANY`, `= ALL`, and `<> ALL` with uncorrelated subqueries, use an in-memory hash for a result or a temporary table with an index for larger results. Example:

```
SELECT a FROM big_table AS bt
WHERE non_key_field IN (SELECT non_key_field FROM table WHERE condition)
```

In this case, we could create a temporary table:

```
CREATE TABLE t (key (non_key_field))
(SELECT non_key_field FROM table WHERE condition)
```

Then, for each row in `big_table`, do a key lookup in `t` based on `bt.non_key_field`.

## D.4. Restrictions on Views

View processing is not optimized:

- It is not possible to create an index on a view.
- Indexes can be used for views processed using the merge algorithm. However, a view that is processed with the temptable algorithm is unable to take advantage of indexes on its underlying tables (although indexes can be used during generation of the temporary tables).

Subqueries cannot be used in the `FROM` clause of a view.

There is a general principle that you cannot modify a table and select from the same table in a subquery. See [Section D.3, “Restrictions on Subqueries”](#).

The same principle also applies if you select from a view that selects from the table, if the view selects from the table in a subquery and the view is evaluated using the merge algorithm. Example:

```
CREATE VIEW v1 AS
SELECT * FROM t2 WHERE EXISTS (SELECT 1 FROM t1 WHERE t1.a = t2.a);
UPDATE t1, v2 SET t1.a = 1 WHERE t1.b = v2.b;
```

If the view is evaluated using a temporary table, you *can* select from the table in the view subquery and still modify that table in the outer query. In this case the view will be stored in a temporary table and thus you are not really selecting from the table in a subquery and modifying it “at the same time.” (This is another reason you might wish to force MySQL to use the temptable algorithm by specifying `ALGORITHM = TEMPTABLE` in the view definition.)

You can use `DROP TABLE` or `ALTER TABLE` to drop or alter a table that is used in a view definition. No warning results from

the `DROP` or `ALTER` operation, even though this invalidates the view. Instead, an error occurs later, when the view is used. `CHECK TABLE` can be used to check for views that have been invalidated by `DROP` or `ALTER` operations.

A view definition is “frozen” by certain statements:

- If a statement prepared by `PREPARE` refers to a view, the view definition seen each time the statement is executed later will be the definition of the view at the time it was prepared. This is true even if the view definition is changed after the statement is prepared and before it is executed. Example:

```
CREATE VIEW v AS SELECT RAND();
PREPARE s FROM 'SELECT * FROM v';
ALTER VIEW v AS SELECT NOW();
EXECUTE s;
```

The result returned by the `EXECUTE` statement is a random number, not the current date and time.

- If a statement in a stored routine refers to a view, the view definition seen by the statement are its definition the first time that statement is executed. For example, this means that if the statement is executed in a loop, further iterations of the statement see the same view definition, even if the definition is changed later in the loop. Example:

```
CREATE VIEW v AS SELECT 1;
delimiter //
CREATE PROCEDURE p ()
BEGIN
  DECLARE i INT DEFAULT 0;
  WHILE i < 5 DO
    SELECT * FROM v;
    SET i = i + 1;
    ALTER VIEW v AS SELECT 2;
  END WHILE;
END;
//
delimiter ;
CALL p();
```

When the procedure `p()` is called, the `SELECT` returns 1 each time through the loop, even though the view definition is changed within the loop.

As of MySQL 5.1.21, `ALTER VIEW` is prohibited within stored routines, so this restriction does not apply.

With regard to view updatability, the overall goal for views is that if any view is theoretically updatable, it should be updatable in practice. This includes views that have `UNION` in their definition. Currently, not all views that are theoretically updatable can be updated. The initial view implementation was deliberately written this way to get usable, updatable views into MySQL as quickly as possible. Many theoretically updatable views can be updated now, but limitations still exist:

- Updatable views with subqueries anywhere other than in the `WHERE` clause. Some views that have subqueries in the `SELECT` list may be updatable.
- You cannot use `UPDATE` to update more than one underlying table of a view that is defined as a join.
- You cannot use `DELETE` to update a view that is defined as a join.

There exists a shortcoming with the current implementation of views. If a user is granted the basic privileges necessary to create a view (the `CREATE VIEW` and `SELECT` privileges), that user will be unable to call `SHOW CREATE VIEW` on that object unless the user is also granted the `SHOW VIEW` privilege.

That shortcoming can lead to problems backing up a database with `mysqldump`, which may fail due to insufficient privileges. This problem is described in [Bug#22062](#).

The workaround to the problem is for the administrator to manually grant the `SHOW VIEW` privilege to users who are granted `CREATE VIEW`, since MySQL doesn't grant it implicitly when views are created.

Views do not have indexes, so index hints do not apply. Use of index hints when selecting from a view is disallowed.

`SHOW CREATE VIEW` displays view definitions using an `AS alias_name` clause for each column. If a column is created from an expression, the default alias is the expression text, which can be quite long. As of MySQL 5.1.23, aliases for column names in `CREATE VIEW` statements are checked against the maximum column length of 64 characters (not the maximum alias length of 256 characters). As a result, views created from the output of `SHOW CREATE VIEW` fail if any column alias exceeds 64 characters. This can cause problems in the following circumstances for views with too-long aliases:

- View definitions fail to replicate to newer slaves that enforce the column-length restriction.

- Dump files created with `mysqldump` cannot be loaded into servers that enforce the column-length restriction.

A workaround for either problem is to modify each problematic view definition to use aliases that provide shorter column names. Then the view will replicate properly, and can be dumped and reloaded without causing an error. To modify the definition, drop and create the view again with `DROP VIEW` and `CREATE VIEW`, or replace the definition with `CREATE OR REPLACE VIEW`.

For problems that occur when reloading view definitions in dump files, another workaround is to edit the dump file to modify its `CREATE VIEW` statements. However, this does not change the original view definitions, which may cause problems for subsequent dump operations.

## D.5. Restrictions on XA Transactions

XA transaction support is limited to the `InnoDB` storage engine.

For “external XA,” a MySQL server acts as a Resource Manager and client programs act as Transaction Managers. For “Internal XA”, storage engines within a MySQL server act as RMs, and the server itself acts as a TM. Internal XA support is limited by the capabilities of individual storage engines. Internal XA is required for handling XA transactions that involve more than one storage engine. The implementation of internal XA requires that a storage engine support two-phase commit at the table handler level, and currently this is true only for `InnoDB`.

For `XA START`, the `JOIN` and `RESUME` clauses are not supported.

For `XA END`, the `SUSPEND [FOR MIGRATE]` clause is not supported.

The requirement that the `bqual` part of the `xid` value be different for each XA transaction within a global transaction is a limitation of the current MySQL XA implementation. It is not part of the XA specification.

If an XA transaction has reached the `PREPARED` state and the MySQL server is killed (for example, with `kill -9` on Unix) or shuts down abnormally, the transaction can be continued after the server restarts. However, if the client reconnects and commits the transaction, the transaction will be absent from the binary log even though it has been committed. This means the data and the binary log have gone out of synchrony. An implication is that XA cannot be used safely together with replication.

It is possible that the server will roll back a pending XA transaction, even one that has reached the `PREPARED` state. This happens if a client connection terminates and the server continues to run, or if clients are connected and the server shuts down gracefully. (In the latter case, the server marks each connection to be terminated, and then rolls back the `PREPARED` XA transaction associated with it.) It should be possible to commit or roll back a `PREPARED` XA transaction, but this cannot be done without changes to the binary logging mechanism.

## D.6. Restrictions on Character Sets

- Identifiers are stored in `mysql` database tables (`user`, `db`, and so forth) using `utf8`, but identifiers can contain only characters in the Basic Multilingual Plane (BMP). Supplementary characters are not allowed in identifiers.
- The `ucs2` character sets has the following restrictions:
  - It cannot be used as a client character set, which means that it does not work for `SET NAMES` or `SET CHARACTER SET`. (See [Section 9.1.4](#), “Connection Character Sets and Collations”.)
  - It is currently not possible to use `LOAD DATA INFILE` to load data files that use this character set.
  - `FULLTEXT` indexes cannot be created on a column that this character set. However, you can perform `IN BOOLEAN MODE` searches on the column without an index.
- The `REGEXP` and `RLIKE` operators work in byte-wise fashion, so they are not multi-byte safe and may produce unexpected results with multi-byte character sets. In addition, these operators compare characters by their byte values and accented characters may not compare as equal even if a given collation treats them as equal.

## D.7. Limits in MySQL

This section lists current limits in MySQL 5.1.

### D.7.1. Limits of Joins

The maximum number of tables that can be referenced in a single join is 61. This also applies to the number of tables that can be referenced in the definition of a view.

## D.7.2. The Maximum Number of Columns Per Table

There is a hard limit of 4096 columns per table, but the effective maximum may be less for a given table. The exact limit depends on several interacting factors, listed in the following discussion.

- Every table has a maximum row size of 65,535 bytes. This maximum applies to all storage engines, but a given engine might have additional constraints that result in a lower effective maximum row size.

The maximum row size constrains the number of columns because the total width of all columns cannot exceed this size. For example, `utf8` characters require up to three bytes per character, so for a `CHAR(255) CHARACTER SET utf8` column, the server must allocate  $255 \times 3 = 765$  bytes per value. Consequently, a table cannot contain more than  $65,535 / 765 = 85$  such columns.

Storage for variable-length columns includes length bytes, which are assessed against the row size. For example, a `VARCHAR(255) CHARACTER SET utf8` column takes two bytes to store the length of the value, so each value can take up to 767 bytes.

`BLOB` and `TEXT` columns count from one to four plus eight bytes each toward the row-size limit because their contents are stored separately.

Declaring columns `NULL` can reduce the maximum number of columns allowed. `NULL` columns require additional space in the row to record whether or not their values are `NULL`.

For `MyISAM` tables, each `NULL` column takes one bit extra, rounded up to the nearest byte. The maximum row length in bytes can be calculated as follows:

```
row length = 1
             + (sum of column lengths)
             + (number of NULL columns + delete_flag + 7)/8
             + (number of variable-length columns)
```

`delete_flag` is 1 for tables with static row format. Static tables use a bit in the row record for a flag that indicates whether the row has been deleted. `delete_flag` is 0 for dynamic tables because the flag is stored in the dynamic row header.

These calculations do not apply for `InnoDB` tables, for which storage size is no different for `NULL` columns than for `NOT NULL` columns.

The following statement to create table `t1` succeeds because the columns require 32,765 + 2 bytes and 32,766 + 2 bytes, which falls within the maximum row size of 65,535 bytes:

```
mysql> CREATE TABLE t1
-> (c1 VARCHAR(32765) NOT NULL, c2 VARCHAR(32766) NOT NULL);
Query OK, 0 rows affected (0.01 sec)
```

The following statement to create table `t2` fails because the columns are `NULL` and require additional space that causes the row size to exceed 65,535 bytes:

```
mysql> CREATE TABLE t2
-> (c1 VARCHAR(32765) NULL, c2 VARCHAR(32766) NULL);
ERROR 1118 (42000): Row size too large. The maximum row size for the
used table type, not counting BLOBs, is 65535. You have to change some
columns to TEXT or BLOBs
```

- Each table has an `.frm` file that contains the table definition. The `.frm` file size limit is fixed at 64KB. If a table definition reaches this size, no more columns can be added. The expression that checks information to be stored in the `.frm` file against the limit looks like this:

```
if (info_length+(ulong) create_fields.elements*FCOMP+288+
    n_length+int_length+com_length > 65535L || int_count > 255)
```

The relevant factors in this expression are:

- `info_length` is space needed for “screens.” This is related to MySQL's Unireg heritage.
- `create_fields.elements` is the number of columns.
- `FCOMP` is 17.
- `n_length` is the total length of all column names, including one byte per name as a separator.
- `int_length` is related to the list of values for SET and ENUM columns.

- `com_length` is the total length of column and table comments.

Thus, using long column names can reduce the maximum number of columns, as can the inclusion of `ENUM` or `SET` columns, or use of column or table comments.

- Individual storage engines might impose additional restrictions that limit table column count. Examples:
  - `InnoDB` allows no more than 1000 columns.
  - `InnoDB` restricts row size to something less than half a database page (approximately 8000 bytes), not including `VARBINARY`, `VARCHAR`, `BLOB`, or `TEXT` columns.
  - Different `InnoDB` storage formats (`COMPRESSED`, `REDUNDANT`) use different amounts of page header and trailer data, which affects the amount of storage available for rows.

### D.7.3. Windows Platform Limitations

The following limitations apply only to the Windows platform:

- The number of open file descriptors on Windows is limited to a maximum of 2048, which may limit the ability to open a large number of tables simultaneously. This limit is due to the compatibility functions used to open files on Windows that use the POSIX compatibility layer.

This limitation will also cause problems if you try to set `open_files_limit` to a value greater than the 2048 file limit.

- On Windows 32-bit platforms it is not possible to use more than 2GB of RAM within a single process, including MySQL. This is because the physical address limit on Windows 32-bit is 4GB and the default setting within Windows is to split the virtual address space between kernel (2GB) and user/applications (2GB).

To use more memory than this you will need to use a 64-bit version of Windows.

- When using `MyISAM` tables, you cannot use aliases within Windows link to the data files on another volume and then link back to the main MySQL `datadir` location.

This facility is often used to move the data and index files to a RAID or other fast solution, while retaining the main `.FRM` files in the default data directory configured with the `datadir` option.

- The timers within MySQL used on Windows are of a lower precision than the timers used on Linux. For most situations you may not notice a difference, but the delay implied by a call to `SLEEP()` on Windows and Linux may differ slightly due to the differences in precision.
- There is no 64-bit OLEDB Provider for ODBC (MSDASQL) in any 64-bit Windows operating system up to and including Windows Vista. In practical terms this means that you can't use the MySQL ODBC driver from ADO and other users of OLEDB.

## Symbols

! (logical NOT), 722  
 != (not equal), 718  
 ", 621  
 #mysql50 identifier prefix, 622, 625  
 %, 742  
 % (modulo), 746  
 % (wildcard character), 619  
 & (bitwise AND), 786  
 && (logical AND), 722  
 () (parentheses), 716  
 (Control-Z) \Z, 619, 905  
 \* (multiplication), 741  
 + (addition), 741  
 - (subtraction), 741  
 - (unary minus), 741  
 --password option, 492  
 -p option, 492  
 .my.cnf file, 184, 186, 187, 483, 493, 511  
 .mysql\_history file, 217, 493  
 .pid (process ID) file, 527  
 / (division), 742  
 /etc/passwd, 466, 912  
 := (assignment), 631  
 < (less than), 719  
 <<, 173  
 << (left shift), 787  
 <= (less than or equal), 718  
 <=> (equal to), 718  
 <> (not equal), 718  
 <errortext>Table is full</errortext> error  
   MySQL Cluster, 2091, 2095  
 = (assignment), 631  
 = (equal), 718  
 > (greater than), 719  
 >= (greater than or equal), 719  
 >> (right shift), 787  
 \" (double quote), 618  
 \' (single quote), 618  
 \. (mysql client command), 169, 222  
 \0 (ASCII NUL), 618, 905  
 \b (backspace), 618, 905  
 \n (linefeed), 619, 905  
 \n (newline), 619, 905  
 \N (NULL), 905  
 \r (carriage return), 619, 905  
 \t (tab), 619, 905  
 \Z (Control-Z) ASCII 26, 619, 905  
 \ (escape), 619  
 ^ (bitwise XOR), 787  
 \_ (wildcard character), 619  
 \_rowid, 868  
 ` , 621  
 | (bitwise OR), 786  
 || (logical OR), 722  
 ~, 787

## A

abort-slave-event-count option  
   mysqld, 1356  
 aborted clients, 2124  
 aborted connection, 2124  
 ABS(), 743  
 access control, 478  
 access denied errors, 2118

access privileges, 469  
 account names, 476  
 account privileges  
   adding, 487  
 accounts  
   anonymous user, 109  
   root, 109  
 ACID, 19, 1043  
 ACLs, 469  
 ACOS(), 743  
 Active Server Pages (ASP), 1558  
 ActiveState Perl, 148  
 add-drop-database option  
   mysqldump, 239  
 add-drop-table option  
   mysqldump, 239  
 add-locks option  
   mysqldump, 239  
 add-user option  
   mysqlmanager, 293  
 ADDDATE(), 751  
 adding  
   character sets, 667  
   native functions, 2069  
   new account privileges, 487  
   new functions, 2060  
   new user privileges, 487  
   new users, 82, 85  
   procedures, 2070  
   user-defined functions, 2061  
 addition (+), 741  
 ADDTIME(), 751  
 addtodest option  
   mysqlhotcopy, 290  
 administration  
   server, 224  
 administrative programs, 178  
 AES\_DECRYPT(), 788  
 AES\_ENCRYPT(), 788  
 After create  
   thread state, 603  
 age  
   calculating, 160  
 alias, 2138  
 alias names  
   case sensitivity, 623  
 aliases  
   for expressions, 806  
   for tables, 910  
   in GROUP BY clauses, 806  
   names, 621  
   on expressions, 909  
 ALL, 913, 924  
 ALL join type  
   optimizer, 535  
 all-databases option  
   mysqlcheck, 232  
   mysqldump, 239  
 all-in-1 option  
   mysqlcheck, 232  
 all-tablespaces option  
   mysqldump, 239  
 allocating local table  
   thread state, 607  
 allow-keywords option  
   mysqldump, 239  
 allow-suspicious-udfs option  
   mysqld, 329, 467  
 allowold option  
   mysqlhotcopy, 290



- ALLOW\_INVALID\_DATES SQL mode, 444
  - ALTER COLUMN, 844
  - ALTER DATABASE, 836
  - ALTER EVENT, 836
  - ALTER FUNCTION, 839
  - ALTER LOGFILE GROUP, 838
    - (see also MySQL Cluster Disk Data)
  - ALTER PROCEDURE, 839
  - ALTER SCHEMA, 836
  - ALTER SERVER, 839
  - ALTER TABLE, 839, 845, 2141
  - ALTER TABLESPACE, 851
    - (see also MySQL Cluster Disk Data)
  - ALTER VIEW, 851
  - altering
    - database, 836
    - schema, 836
  - analyze option
    - myisamchk, 269
    - mysqlcheck, 232
  - ANALYZE TABLE, 956
    - and partitioning, 1423
  - Analyzing
    - thread state, 603
  - AND
    - bitwise, 786
    - logical, 722
  - angel-pid-file option
    - mysqlmanager, 293
  - anonymous user, 109, 110, 478, 480
  - ANSI mode
    - running, 16
  - ansi option
    - mysqld, 329
  - ANSI SQL mode, 443, 447
  - ANSI\_QUOTES SQL mode, 444
  - answering questions
    - etiquette, 11
  - ANY, 924
  - Apache, 176
  - API's
    - list of, 31
  - APIs, 1484
    - Perl, 2043
  - approximate-value literals, 829
  - arbitrator, 2092, 2098
  - ARCHIVE storage engine, 1019, 1115
  - Area(), 822, 822
  - argument processing, 2065
  - arithmetic expressions, 741
  - arithmetic functions, 786
  - AS, 909, 913
  - AS/400, 76
  - AsBinary(), 818
  - ASCII(), 726
  - ASIN(), 743
  - AsText(), 818
  - ATAN(), 743
  - ATAN2(), 743
  - attackers
    - security against, 465
  - attribute promotion
    - replication, 1381
  - auto-generate-sql option
    - mysqslap, 258
  - auto-generate-sql-add-autoincrement option
    - mysqslap, 258
  - auto-generate-sql-execute-number option
    - mysqslap, 258
  - auto-generate-sql-guid-primary option
    - mysqslap, 258
  - auto-generate-sql-load-type option
    - mysqslap, 258
  - auto-generate-sql-secondary-indexes option
    - mysqslap, 258
  - auto-generate-sql-unique-query-number option
    - mysqslap, 258
  - auto-generate-sql-unique-write-number option
    - mysqslap, 258
  - auto-generate-sql-write-number option
    - mysqslap, 258
  - AUTO-INCREMENT
    - ODBC, 1555
  - auto-rehash option
    - mysql, 212
  - auto-repair option
    - mysqlcheck, 233
  - autoclose option
    - mysqld\_safe, 196
  - autocommit session variable, 416
  - automatic\_sp\_privileges system variable, 360
  - AUTO\_INCREMENT, 173, 689
    - and NULL values, 2138
    - and replication, 1378
  - auto\_increment\_increment system variable, 1345
  - auto\_increment\_offset system variable, 1348
  - AVG(), 801
  - AVG(DISTINCT), 801
- ## B
- backslash
    - escape character, 618
  - backspace (\b), 618, 905
  - backup option
    - myisamchk, 268
    - myisampack, 272
  - BACKUP TABLE, 956
  - backups, 512
    - database, 956
    - databases and tables, 235, 289
  - back\_log system variable, 360
  - base64-output option
    - mysqlbinlog, 280
  - basedir option
    - mysql.server, 199
    - mysqld, 329
    - mysqld\_safe, 196
    - mysql\_install\_db, 205
    - mysql\_upgrade, 208
  - basedir system variable, 360
  - batch mode, 168
  - batch option
    - mysql, 212
  - batch SQL files, 209
  - Bazaar tree, 92
  - BdMPolyFromText(), 814
  - BdMPolyFromWKB(), 815
  - BdPolyFromText(), 815
  - BdPolyFromWKB(), 815
  - BEGIN, 936, 1011
    - XA transactions, 945
  - benchmark suite, 531
  - BENCHMARK(), 791
  - benchmarks, 531
  - BETWEEN ... AND, 719
  - big-tables option
    - mysqld, 330
  - big5, 2100, 2102
  - BIGINT data type, 683

- big\_tables session variable, 416
- BIN(), 726
- BINARY, 775
- BINARY data type, 687, 699
- binary distributions, 38
  - installing, 80
  - on Linux, 124
- binary log, 454
  - event groups, 1006
- bind-address option
  - mysqld, 330
  - mysqlmanager, 293
- BINLOG, 997
- Binlog Dump
  - thread command, 601
- BINLOG statement
  - mysqlbinlog output, 285
- binlog-do-db option
  - mysqld, 1360
- binlog-format option
  - mysqld, 330
- binlog-ignore-db option
  - mysqld, 1361
- binlog-row-event-max-size option
  - mysqld, 1359
- binlog\_cache\_size system variable, 1362
- binlog\_format system variable, 1363
- BIT data type, 682
- BitKeeper tree, 92
- BIT\_AND(), 801
- BIT\_COUNT, 173
- BIT\_COUNT(), 787
- bit\_functions
  - example, 173
- BIT\_LENGTH(), 726
- BIT\_OR, 173
- BIT\_OR(), 801
- BIT\_XOR(), 801
- BLACKHOLE storage engine, 1019, 1118
- BLOB
  - inserting binary data, 619
  - size, 706
- BLOB columns
  - default values, 700
  - indexing, 580, 868
- BLOB data type, 687, 700
- Block Nested-Loop join algorithm, 549
- block-search option
  - mysamchk, 269
- BOOL data type, 682
- BOOLEAN data type, 682
- bootstrap option
  - mysqld, 331
- Borland Builder 4, 1559
- Boundary(), 819
- brackets
  - square, 682
- brief option
  - mysqlaccess, 277
- buffer sizes
  - client, 1484
  - mysqld server, 591
- Buffer(), 824
- bug reports
  - criteria for, 12
- bugs
  - known, 2143
  - reporting, 12
- bugs database, 12
- bugs.mysql.com, 12

- building
  - client programs, 1838
- bulk\_insert\_buffer\_size system variable, 361

## C

- C API
  - data types, 1758
  - functions, 1762
  - linking problems, 1834
- C prepared statement API
  - functions, 1810
- C++ APIs, 2044
- C++ Builder, 1559
- C++ compiler
  - gcc, 89
- C++ compiler cannot create executables, 94
- C:\my.cnf file, 511
- CACHE INDEX, 997
  - and partitioning, 1431
- caches
  - clearing, 997
- calculating
  - dates, 160
- calendar, 764
- CALL, 889
- calling sequences for aggregate functions
  - UDF, 2064
- calling sequences for simple functions
  - UDF, 2063
- can't create/write to file, 2127
- carriage return (\r), 619, 905
- CASE, 723, 1016
- case sensitivity
  - in access checking, 476
  - in identifiers, 623
  - in names, 623
  - in searches, 2136
  - in string comparisons, 733
- case-sensitivity
  - of database names, 17
  - of table names, 17
- CAST, 775
- cast functions, 774
- cast operators, 774
- casts, 716, 718, 774
- CC environment variable, 89, 89, 95, 147
- cc1plus problems, 94
- CEIL(), 744
- CEILING(), 744
- Centroid(), 823
- CFLAGS environment variable, 89, 95, 147
- cflags option
  - mysql\_config, 307
- CHANGE MASTER TO, 1002
- Change user
  - thread command, 601
- ChangeLog, 2207
- changes
  - log, 2207
  - MySQL 5.1, 2208
  - MySQL 5.1-maria, 2207
- changes to privileges, 481
- changing
  - column, 844
  - column order, 2142
  - field, 844
  - table, 839, 845, 2141
- Changing master
  - thread state, 609

- changing socket location, 89, 107, 2135
- CHAR data type, 686, 698
- CHAR VARYING data type, 687
- CHAR(), 726
- CHARACTER data type, 686
- character sets, 90, 666
  - adding, 667
  - and replication, 1379
- Character sets, 635
- CHARACTER VARYING data type, 687
- character-set-client-handshake option
  - mysqld, 331
- character-set-filesystem option
  - mysqld, 331
- character-set-server option
  - mysqld, 332
- character-sets-dir option
  - myisamchk, 268
  - myisampack, 272
  - mysql, 212
  - mysqldadmin, 228
  - mysqldbinfo, 280
  - mysqlcheck, 233
  - mysqld, 331
  - mysqldump, 239
  - mysqlexport, 249
  - mysqlshow, 253
- characters
  - multi-byte, 670
- CHARACTER\_LENGTH(), 726
- CHARACTER\_SETS
  - INFORMATION\_SCHEMA table, 1463
- character\_sets\_dir system variable, 363
- character\_set\_client system variable, 361
- character\_set\_connection system variable, 361
- character\_set\_database system variable, 362
- character\_set\_filesystem system variable, 362
- character\_set\_results system variable, 362
- character\_set\_server system variable, 362
- character\_set\_system system variable, 363
- charset command
  - mysql, 218
- charset option
  - comp\_err, 203
- CHARSET(), 792
- CHAR\_LENGTH(), 726
- check option
  - myisamchk, 267
  - mysqlcheck, 233
- check options
  - myisamchk, 267
- CHECK TABLE, 957
  - and partitioning, 1423
- check-only-changed option
  - myisamchk, 267
  - mysqlcheck, 233
- check-password-file option
  - mysqlmanager, 293
- check-upgrade option
  - mysqlcheck, 233
- checking
  - tables for errors, 520
- Checking master version
  - thread state, 608
- checking permissions
  - thread state, 603
- Checking table
  - thread state, 603
- checkpoint option
  - mysqlhotcopy, 290
- checksum errors, 129
- CHECKSUM TABLE, 959
- Chinese, Japanese, Korean character sets
  - frequently asked questions, 2100
- choosing
  - a MySQL version, 35
- choosing types, 707
- chroot option
  - mysqld, 332
  - mysqlhotcopy, 291
- CJK
  - FAQ, 2100
- CJK (Chinese, Japanese, Korean)
  - Access, PHP, etc., 2100, 2104
  - availability of specific characters, 2100, 2106
  - available character sets, 2100, 2100
  - big5, 2100, 2102
  - character sets available, 2100, 2100
  - characters displayed as question marks, 2100
  - CJKV, 2100, 2108
  - collations, 2100, 2100, 2107, 2108
  - conversion problems with Japanese character sets, 2100, 2103
  - data truncation, 2100, 2104
  - Database and table names, 2100, 2109
  - documentation in Chinese, 2100, 2109
  - documentation in Japanese, 2100, 2109
  - documentation in Korean, 2100, 2109
  - gb2312, gbk, 2100, 2100
  - Japanese character sets, 2100, 2103
  - Korean character set, 2100, 2104
  - LIKE and FULLTEXT, 2100, 2106
  - MySQL 4.0 behavior, 2100, 2105
  - ORDER BY treatment, 2100, 2100, 2107, 2108
  - problems with Access, PHP, etc., 2100, 2104
  - problems with Big5 character sets (Chinese), 2100, 2102
  - problems with data truncation, 2100, 2104
  - problems with euckr character set (Korean), 2100, 2104
  - problems with GB character sets (Chinese), 2100, 2100
  - problems with LIKE and FULLTEXT, 2100, 2106
  - problems with Yen sign (Japanese), 2100, 2103
  - rejected characters, 2100, 2108
  - sort order problems, 2100, 2100, 2107, 2108
  - sorting problems, 2100, 2100, 2107, 2108
  - testing availability of characters, 2100, 2106
  - Unicode collations, 2100, 2108
  - Vietnamese, 2100, 2108
  - Yen sign, 2100, 2103
- clean-password-file option
  - mysqlmanager, 293
- cleaning up
  - thread state, 603
- clear command
  - mysql, 218
- Clearing
  - thread state, 610
- clearing
  - caches, 997
- client connection threads, 611
- client programs, 178
  - building, 1838
- client tools, 1484
- clients
  - debugging, 2077
  - threaded, 1838
- CLOSE, 1015
- Close stmt
  - thread command, 601
- closing
  - tables, 588
- closing tables

- thread state, 603
- clustered index
  - InnoDB, 1083
- CMake, 97
- COALESCE(), 720
- COERCIBILITY(), 792
- ColdFusion, 1559
- collating
  - strings, 669
- collation
  - adding, 670
- COLLATION(), 792
- collation-server option
  - mysqld, 332
- COLLATIONS
  - INFORMATION\_SCHEMA table, 1463
- COLLATION\_CHARACTER\_SET\_APPLICABILITY
  - INFORMATION\_SCHEMA table, 1463
- collation\_connection system variable, 363
- collation\_database system variable, 363
- collation\_server system variable, 363
- column
  - changing, 844
  - types, 682
- column comments, 867
- column format, 867
- column names
  - case sensitivity, 623
- column storage, 867
- column-names option
  - mysql, 212
- column-type-info option
  - mysql, 212
- columns
  - changing, 2142
  - displaying, 252
  - indexes, 580
  - names, 621
  - other types, 707
  - selecting, 159
  - storage requirements, 704
- COLUMNS
  - INFORMATION\_SCHEMA table, 1460
- columns option
  - mysqlimport, 249
- COLUMN\_PRIVILEGES
  - INFORMATION\_SCHEMA table, 1462
- comma-separated values data, reading, 903, 912
- command options
  - mysql, 209
  - mysqladmin, 227
  - mysqld, 328
- command syntax, 3, 1216
- command-line history
  - mysql, 217
- command-line tool, 209
- commands
  - for binary distribution, 80
- commands out of sync, 2127
- Comment syntax, 633
- comments
  - adding, 633
  - starting, 22
- comments option
  - mysql, 212
  - mysqldump, 239
- COMMIT, 19, 936
  - XA transactions, 945
- commit option
  - mysqlaccess, 277
  - mysqlslap, 258
- Committing events to binlog
  - thread state, 610
- compact option
  - mysqldump, 240
- comparison operators, 717
- compatibility
  - between MySQL versions, 113
  - with mSQL, 736
  - with ODBC, 623, 684, 716, 719, 866, 915
  - with Oracle, 17, 803, 933
  - with PostgreSQL, 18
  - with standard SQL, 15
  - with Sybase, 936
- compatible option
  - mysqldump, 240
- compiler
  - C++ gcc, 89
- compiling
  - on Windows, 100
  - optimizing, 590
  - problems, 94
  - speed, 589
  - statically, 89
  - user-defined functions, 2067
- complete-insert option
  - mysqldump, 240
- completion\_type system variable, 364
- compliance
  - Y2K, 697
- composite partitioning, 1412
- compound statements, 1010
- compress option
  - mysql, 212
  - mysqladmin, 228
  - mysqlcheck, 233
  - mysqldump, 240
  - mysqlimport, 249
  - mysqlshow, 253
  - mysqlslap, 258
- COMPRESS(), 788
- compressed tables, 271, 1029
- comp\_err, 177, 202
  - charset option, 203
  - debug option, 203
  - debug-info option, 203
  - header\_file option, 203
  - help option, 203
  - in\_file option, 203
  - name\_file option, 203
  - out\_dir option, 203
  - out\_file option, 203
  - statefile option, 203
  - version option, 203
- CONCAT(), 727
- concatenation
  - string, 618, 727
- CONCAT\_WS(), 727
- concurrency option
  - mysqlslap, 258
- concurrent inserts, 575, 578
- concurrent\_insert system variable, 364
- Conditions, 1012
- config-file option
  - mysqld\_multi, 200
  - my\_print\_defaults, 308
- config.cache, 94
- config.cache file, 94
- configuration files, 483
- configuration options, 85

- configure
  - disable-grant-options option, 91
  - enable-community-features option, 91
  - enable-profiling option, 91
  - enable-thread-safe-client option, 90
  - localstatedir option, 89
  - prefix option, 89
  - running after prior invocation, 94
  - with-big-tables option, 91
  - with-charset option, 90
  - with-client-ldflags option, 89
  - with-collation option, 90
  - with-debug option, 90
  - with-embedded-server option, 89
  - with-extra-charsets option, 90, 90
  - with-unix-socket-path option, 89
  - with-zlib-dir option, 91
  - without-server option, 88
- configure option
  - with-low-memory, 94
- configure script, 85
- Connect
  - thread command, 601
- connect command
  - mysql, 218
- Connect Out
  - thread command, 601
- connecting
  - remotely with SSH, 504
  - to the server, 151, 181
  - verification, 478
- Connecting to master
  - thread state, 608
- connection
  - aborted, 2124
- CONNECTION\_ID(), 792
- Connector/C, 1484
- Connector/C++, 1484
- Connector/JDBC, 1484
- Connector/MXJ, 1484
- Connector/NET, 1484, 1565
  - reporting problems, 1630
- Connector/ODBC, 1484, 1486
  - Borland, 1558
  - Borland Database Engine, 1558
  - reporting problems, 1564, 1564
- Connector/OpenOffice.org, 1484
- Connectors
  - MySQL, 1484
- connect\_timeout system variable, 365
- connect\_timeout variable, 216, 230
- console option
  - mysqld, 332
- const table
  - optimizer, 534, 913
- constant table, 541
- constraints, 23
- CONSTRAINTS
  - INFORMATION\_SCHEMA table, 1464
- Contains(), 825
- contributing companies
  - list of, 32
- contributors
  - list of, 25
- control flow functions, 723
- CONV(), 744
- conventions
  - syntax, 2
  - typographical, 2, 1215
- CONVERT, 775
- CONVERT TO, 846
- converting HEAP to MyISAM
  - thread state, 603
- CONVERT\_TZ(), 751
- ConvexHull(), 824
- copy option
  - mysqlaccess, 277
- copy to tmp table
  - thread state, 603
- copying databases, 123
- copying tables, 876
- Copying to group table
  - thread state, 603
- Copying to tmp table
  - thread state, 603
- Copying to tmp table on disk
  - thread state, 603
- core-file option
  - mysqld, 332
- core-file-size option
  - mysqld\_safe, 196
- correct-checksum option
  - myisamchk, 268
- correlated subqueries, 926
- COS(), 744
- COT(), 744
- count option
  - myisam\_ftdump, 262
  - mysqladmin, 228
  - mysqlshow, 253
- COUNT(), 801
- COUNT(DISTINCT), 801
- counting
  - table rows, 164
- crash, 2072
  - recovery, 520
  - repeated, 2132
  - replication, 1386
- crash-me, 531
- crash-me program, 529, 531
- CRC32(), 744
- CREATE DATABASE, 852
- Create DB
  - thread command, 601
- CREATE EVENT, 852
- CREATE FUNCTION, 859, 962
- CREATE INDEX, 856
- CREATE LOGFILE GROUP, 859
  - (see also MySQL Cluster Disk Data)
- create option
  - mysqslap, 259
- CREATE PROCEDURE, 859
- CREATE SCHEMA, 852
- CREATE SERVER, 863
- CREATE TABLE, 864
  - DIRECTORY options
  - and replication, 1382
- CREATE TABLE ... SELECT
  - and replication, 1379
- CREATE TABLESPACE, 878
  - (see also MySQL Cluster Disk Data)
- CREATE TRIGGER, 879
- CREATE USER, 948
- CREATE VIEW, 882
- create-options option
  - mysqldump, 240
- create-schema option
  - mysqslap, 259
- creating
  - bug reports, 12

- database, 852
  - databases, 154
  - default startup options, 186
  - function, 962
  - schema, 852
  - tables, 155
  - Creating delayed handler
    - thread state, 607
  - Creating index
    - thread state, 603
  - Creating sort index
    - thread state, 603
  - creating table
    - thread state, 603
  - Creating table from master dump
    - thread state, 609
  - Creating tmp table
    - thread state, 603
  - creating user accounts, 948
  - CROSS JOIN, 913
  - Crosses(), 825
  - CR\_SERVER\_GONE\_ERROR, 2122
  - CR\_SERVER\_LOST\_ERROR, 2122
  - CSV data, reading, 903, 912
  - csv option
    - mysqslap, 259
  - CSV storage engine, 1019, 1116
  - CURDATE(), 752
  - CURRENT\_DATE, 752
  - CURRENT\_TIME, 752
  - CURRENT\_TIMESTAMP, 752
  - CURRENT\_USER(), 792
  - Cursors, 1014
  - CURTIME(), 752
  - customers
    - of MySQL, 530
  - CXX environment variable, 89, 89, 94, 94, 95, 147
  - CXXFLAGS environment variable, 89, 95, 147
- D**
- Daemon
    - thread command, 601
  - data
    - character sets, 666
    - importing, 222, 247
    - loading into tables, 156
    - retrieving, 157
    - size, 579
  - DATA DIRECTORY
    - and replication, 1382
  - Data truncation with CJK characters, 2100, 2104
  - data type
    - BIGINT, 683
    - BINARY, 687, 699
    - BIT, 682
    - BLOB, 687, 700
    - BOOL, 682, 707
    - BOOLEAN, 682, 707
    - CHAR, 686, 698
    - CHAR VARYING, 687
    - CHARACTER, 686
    - CHARACTER VARYING, 687
    - DATE, 685, 692
    - DATETIME, 685, 692
    - DEC, 684
    - DECIMAL, 684, 829
    - DOUBLE, 684
    - DOUBLE PRECISION, 684
    - ENUM, 688, 701
    - FIXED, 684
    - FLOAT, 684, 684, 684
    - GEOMETRY, 813
    - GEOMETRYCOLLECTION, 813
    - INT, 683
    - INTEGER, 683
    - LINestring, 813
    - LONG, 700
    - LONGBLOB, 688
    - LONGTEXT, 688
    - MEDIUMBLOB, 687
    - MEDIUMINT, 683
    - MEDIUMTEXT, 687
    - MULTILINESTRING, 813
    - MULTIPOINT, 813
    - MULTIPOLYGON, 813
    - NATIONAL CHAR, 686
    - NATIONAL VARCHAR, 687
    - NCHAR, 686
    - NUMERIC, 684
    - NVARCHAR, 687
    - POINT, 813
    - POLYGON, 813
    - REAL, 684
    - SET, 688, 702
    - SMALLINT, 683
    - TEXT, 687, 700
    - TIME, 685, 696
    - TIMESTAMP, 685, 692
    - TINYBLOB, 687
    - TINYINT, 682
    - TINYTEXT, 687
    - VARBINARY, 687, 699
    - VARCHAR, 687, 698
    - VARCHARACTER, 687
    - YEAR, 685, 697
  - data types, 682
    - C API, 1758
    - overview, 682
  - data-file-length option
    - mysamchk, 268
  - database
    - altering, 836
    - creating, 852
    - deleting, 885
  - Database information
    - obtaining, 966
  - database metadata, 1457
  - database names
    - case sensitivity, 623
    - case-sensitivity, 17
  - database option
    - mysql, 212
    - mysqlbinlog, 280
  - DATABASE(), 793
  - databases
    - backups, 512
    - copying, 123
    - creating, 154
    - defined, 3
    - displaying, 252
    - dumping, 235, 289
    - information about, 167
    - names, 621
    - replicating, 1330
    - selecting, 155
    - symbolic links, 615
    - using, 154
  - databases option
    - mysqlcheck, 233

- mysqldump, 240
- datadir option
  - mysql.server, 199
  - mysqld, 333
  - mysqld\_safe, 196
  - mysql\_install\_db, 206
  - mysql\_upgrade, 208
- datadir system variable, 365
- DataJunction, 1560
- DATE, 2137
- date and time functions, 749
- Date and Time types, 691
- date calculations, 160
- DATE columns
  - problems, 2137
- DATE data type, 685, 692
- date functions
  - Y2K compliance, 697
- date types, 705
  - Y2K issues, 697
- date values
  - problems, 693
- DATE(), 752
- DATEDIFF(), 752
- dates
  - used with partitioning, 1404
  - used with partitioning (examples), 1406, 1409, 1413, 1427
- DATETIME data type, 685, 692
- datetime\_format system variable, 365
- DATE\_ADD(), 752
- date\_format system variable, 365
- DATE\_FORMAT(), 754
- DATE\_SUB(), 752, 755
- DAY(), 755
- DAYNAME(), 755
- DAYOFMONTH(), 755
- DAYOFWEEK(), 756
- DAYOFYEAR(), 756
- db option
  - mysqlaccess, 277
- db table
  - sorting, 480
- DB2 SQL mode, 448
- DBI interface, 2043
- DBI->quote, 619
- DBI->trace, 2074
- DBI/DBD interface, 2043
- DBI\_TRACE environment variable, 147, 2074
- DBI\_USER environment variable, 147
- DEBUG package, 2077
- DEALLOCATE PREPARE, 1007, 1010
- Debug
  - thread command, 601
- debug option
  - comp\_err, 203
  - make\_win\_bin\_dist, 204
  - myisamchk, 265
  - myisampack, 272
  - mysql, 212
  - mysqlaccess, 277
  - mysqladmin, 228
  - mysqlbinlog, 280
  - mysqlcheck, 233
  - mysqld, 333
  - mysqldump, 240
  - mysqldumpslow, 288
  - mysqlhotcopy, 291
  - mysqlimport, 249
  - mysqlmanager, 293
  - mysqlshow, 253
  - mysqlslap, 259
  - my\_print\_defaults, 308
- debug system variable, 365
- debug-check option
  - mysql, 212
  - mysqladmin, 228
  - mysqlbinlog, 281
  - mysqlcheck, 233
  - mysqldump, 240
  - mysqlimport, 249
  - mysqlshow, 253
  - mysqlslap, 259
  - mysql\_upgrade, 208
- debug-info option
  - comp\_err, 203
  - mysql, 212
  - mysqladmin, 228
  - mysqlbinlog, 281
  - mysqlcheck, 233
  - mysqldump, 240
  - mysqlimport, 250
  - mysqlshow, 253
  - mysqlslap, 259
  - mysql\_upgrade, 208
- debugging
  - client, 2077
  - server, 2072
- debugging support, 85
- DEC data type, 684
- decimal arithmetic, 829
- DECIMAL data type, 684, 829
- decimal point, 682
- DECLARE, 1011
- DECODE(), 789
- decode\_bits myisamchk variable, 266
- DEFAULT
  - constraint, 24
- default
  - privileges, 109
- default host name, 181
- default installation location, 45
- default options, 186
- DEFAULT value clause, 688, 867
- default values, 529, 688, 867, 895
  - BLOB and TEXT columns, 700
  - explicit, 688
  - implicit, 688
  - suppression, 24
- DEFAULT(), 797
- default-character-set option
  - mysql, 213
  - mysqladmin, 228
  - mysqlcheck, 233
  - mysqld, 333
  - mysqldump, 240
  - mysqlimport, 250
  - mysqlshow, 253
- default-collation option
  - mysqld, 333
- default-mysqld-path option
  - mysqlmanager, 293
- default-storage-engine option
  - mysqld, 334
- default-table-type option
  - mysqld, 334
- default-time-zone option
  - mysqld, 334
- defaults
  - embedded, 1755
- defaults-extra-file option, 189

- mysql\_d\_multi, 200
- mysql\_d\_safe, 196
- my\_print\_defaults, 308
- defaults-file option, 190
  - mysql\_d\_multi, 200
  - mysql\_d\_safe, 196
  - mysqlmanager, 293
  - my\_print\_defaults, 308
- defaults-group-suffix option, 190
  - my\_print\_defaults, 308
- default\_week\_format system variable, 366
- DEGREES(), 744
- delay-key-write option
  - mysql\_d, 334, 1027
- DELAYED, 898
  - when ignored, 897
- Delayed insert
  - thread command, 601
- delayed inserts
  - thread states, 607
- delayed-insert option
  - mysqldump, 240
- delayed\_insert\_limit, 899
- delayed\_insert\_limit system variable, 367
- delayed\_insert\_timeout system variable, 367
- delayed\_queue\_size system variable, 367
- delay\_key\_write system variable, 366
- DELETE, 890
- delete option
  - mysqlimport, 250
- delete-master-logs option
  - mysqldump, 241
- deleting
  - database, 885
  - foreign key, 846, 1066
  - function, 962
  - index, 845, 886
  - primary key, 845
  - rows, 2139
  - schema, 885
  - table, 887
  - user, 489, 948
  - users, 489, 948
- deleting from main table
  - thread state, 604
- deleting from reference tables
  - thread state, 604
- deletion
  - mysql.sock, 2135
- delimiter command
  - mysql, 218
- delimiter option
  - mysql, 213
  - mysqlslap, 259
- Delphi, 1559
- derived tables, 926
- des-key-file option
  - mysql\_d, 334
- DESC, 933
- DESCRIBE, 167, 933
- description option
  - myisamchk, 269
- design
  - issues, 2143
  - limitations, 529
- DES\_DECRYPT(), 789
- DES\_ENCRYPT(), 789
- detach option
  - mysqlslap, 259
- development source tree, 92
- Difference(), 824
- digits, 682
- Dimension(), 819
- directory structure
  - default, 45
- disable named command
  - mysql, 213
- disable-grant-options option
  - configure, 91
- disable-keys option
  - mysqldump, 241
- disable-log-bin option
  - mysqlbinlog, 281
- DISCARD TABLESPACE, 846, 1048
- discard\_or\_import\_tablespace
  - thread state, 604
- disconnect-slave-event-count option
  - mysql\_d, 1356
- disconnecting
  - from the server, 151
- Disjoint(), 825
- disk full, 2134
- disk issues, 615
- disks
  - splitting data across, 617
- display size, 682
- display triggers, 993
- display width, 682
- displaying
  - database information, 252
  - information
    - Cardinality, 979
    - Collation, 979
    - SHOW, 966, 969, 979, 980, 993
    - table status, 991
- Distance(), 825
- DISTINCT, 159, 560, 913
  - AVG(), 801
  - COUNT(), 801
  - MAX(), 802
  - MIN(), 802
  - SUM(), 803
- DISTINCTROW, 913
- DIV, 742
- division (/), 742
- div\_precision\_increment system variable, 368
- DNS, 614
- DO, 893
- DocBook XML
  - documentation source format, 1
- Documentation
  - in Chinese, 2100, 2109
  - in Japanese, 2100, 2109
  - in Korean, 2100, 2109
- Documenters
  - list of, 29
- DOUBLE data type, 684
- DOUBLE PRECISION data type, 684
- double quote ("), 618
- downgrading, 112, 119
- downloading, 42
- drbd
  - FAQ, 2109
  - DRBD, 2109, 2110
  - DRBD license, 2110, 2110
  - DROP ... IF EXISTS
    - and replication, 1382
  - DROP DATABASE, 885
  - Drop DB
    - thread command, 601



- DROP EVENT, 886
  - DROP FOREIGN KEY, 846, 1066
  - DROP FUNCTION, 887, 962
  - DROP INDEX, 845, 886
  - DROP LOGFILE GROUP, 886
    - (see also MySQL Cluster Disk Data)
  - DROP PREPARE, 1010
  - DROP PRIMARY KEY, 845
  - DROP PROCEDURE, 887
  - DROP SCHEMA, 885
  - DROP SERVER, 887
  - DROP TABLE, 887
  - DROP TABLESPACE, 888
    - (see also MySQL Cluster Disk Data)
  - DROP TRIGGER, 888
  - DROP USER, 948
  - DROP VIEW, 888
  - drop-user option
    - mysqlmanager, 293
  - dropping
    - user, 489, 948
  - dryrun option
    - mysqlhotcopy, 291
  - DUAL, 909
  - dump option
    - mysiam\_ftdump, 262
  - dump-date option
    - mysqldump, 241
  - DUMPFIELD, 912
  - dumping
    - databases and tables, 235, 289
  - dynamic table characteristics, 1028
- E**
- edit command
    - mysql, 218
  - edit-user option
    - mysqlmanager, 293
  - ego command
    - mysql, 218
  - Eiffel Wrapper, 2045
  - ELT(), 727
  - email lists, 9
  - embedded MySQL server library, 1754
  - embedded option
    - make\_win\_bin\_dist, 204
    - mysql\_config, 307
  - enable-community-features option
    - configure, 91
  - enable-named-pipe option
    - mysqld, 335
  - enable-profiling option
    - configure, 91
  - enable-pstack option
    - mysqld, 335
  - enable-thread-safe-client option
    - configure, 90
  - ENCODE(), 789
  - ENCRYPT(), 790
  - encryption, 497
  - encryption functions, 787
  - end
    - thread state, 604
  - END, 1011
  - EndPoint(), 820
  - engine option
    - mysqlslap, 259
  - ENGINES
    - INFORMATION\_SCHEMA table, 1469
    - engine\_condition\_pushdown system variable, 368
    - entering
      - queries, 152
    - ENUM
      - size, 707
    - ENUM data type, 688, 701
    - Envelope(), 819
    - environment variable
      - CC, 89, 89, 95, 147
      - CFLAGS, 89, 95, 147
      - CXX, 89, 89, 94, 95, 147
      - CXXFLAGS, 89, 95, 147
      - DBI\_TRACE, 147, 2074
      - DBI\_USER, 147
      - HOME, 147, 217
      - LD\_LIBRARY\_PATH, 149
      - LD\_RUN\_PATH, 125, 131, 147, 149
      - MYSQL\_DEBUG, 147, 181, 2077
      - MYSQL\_GROUP\_SUFFIX, 147
      - MYSQL\_HISTFILE, 147, 217
      - MYSQL\_HOME, 147
      - MYSQL\_HOST, 147, 184
      - MYSQL\_PS1, 147
      - MYSQL\_PWD, 147, 181, 184
      - MYSQL\_TCP\_PORT, 147, 181, 510, 511
      - MYSQL\_UNIX\_PORT, 105, 147, 181, 510, 511
      - PATH, 81, 147, 181
      - TMPDIR, 105, 147
      - TZ, 147, 2135
      - UMASK, 147, 2130
      - UMASK\_DIR, 147, 2130
      - USER, 147, 184
    - environment variables, 180, 193, 483
      - CXX, 94
      - list of, 147
    - equal (=), 718
    - Equals(), 825
    - eq\_ref join type
      - optimizer, 534
    - Errcode, 309
    - errno, 309
    - Error
      - thread command, 601
    - error messages
      - can't find file, 2130
      - displaying, 309
      - languages, 667, 667
    - errors
      - access denied, 2118
      - and replication, 1387
      - checking tables for, 520
      - common, 2117
      - directory checksum, 129
      - handling for UDFs, 2066
      - in subqueries, 928
      - known, 2143
      - linking, 2129
      - list of, 2118
      - lost connection, 2120
      - reporting, 1, 12, 12
    - error\_count session variable, 416
    - ERROR\_FOR\_DIVISION\_BY\_ZERO SQL mode, 444
    - escape (\), 619
    - escape characters, 618
    - estimating
      - query performance, 540
    - event groups, 1006
    - event restrictions, 2514
    - event scheduler, 1436
      - thread states, 610

- Event Scheduler, 1441
    - altering events, 836
    - and MySQL privileges, 1445
    - and mysqladmin debug, 1445
    - and replication, 1382
    - and SHOW PROCESSLIST, 1443
    - concepts, 1442
    - creating events, 852
    - dropping events, 886
    - enabling and disabling, 1443
    - event metadata, 1445
    - obtaining status information, 986, 1445
    - SQL statements, 1444
    - starting and stopping, 1443
  - event-scheduler option
    - mysqld, 335
  - events, 1436, 1441
    - altering, 836
    - creating, 852
    - dropping, 886
    - metadata, 1445
    - status variables, 1447
  - EVENTS
    - INFORMATION\_SCHEMA table, 1446, 1471
  - events option
    - mysqldump, 241
  - event\_scheduler system variable, 369
  - exact-value literals, 829
  - example option
    - mysqld\_multi, 200
  - EXAMPLE storage engine, 1019, 1110
  - examples
    - compressed tables, 272
    - myisamchk output, 523
    - queries, 169
  - exe-suffix option
    - make\_win\_bin\_dist, 204
  - Execute
    - thread command, 601
  - EXECUTE, 1007, 1010
  - execute option
    - mysql, 213
  - executing
    - thread state, 604
  - executing SQL statements from text files, 168, 222
  - Execution of init\_command
    - thread state, 604
  - EXISTS
    - with subqueries, 925
  - exit command
    - mysql, 218
  - exit-info option
    - mysqld, 336
  - EXP(), 744
  - expire\_logs\_days system variable, 369
  - EXPLAIN, 532, 933
  - EXPLAIN PARTITIONS, 1424, 1425
  - EXPLAIN used with partitioned tables, 1424
  - explicit default values, 688
  - EXPORT\_SET(), 727
  - expression aliases, 806, 909
  - expressions
    - extended, 163
  - extend-check option
    - myisamchk, 267, 268
  - extended option
    - mysqlcheck, 233
  - extended-insert option
    - mysqldump, 241
  - extensions
    - to standard SQL, 15
  - ExteriorRing(), 822
  - external locking, 336, 347, 404, 520, 578, 606
  - external-locking option
    - mysqld, 336
  - extra-file option
    - my\_print\_defaults, 308
  - EXTRACT(), 756
  - extracting
    - dates, 160
  - ExtractValue(), 778
- ## F
- FALSE, 620, 620
    - testing for, 719, 719
  - fast option
    - myisamchk, 267
    - mysqlcheck, 233
  - fatal signal 11, 94
  - features of MySQL, 4
  - FEDERATED storage engine, 1019, 1110
  - Fetch
    - thread command, 601
  - FETCH, 1015
  - field
    - changing, 844
  - Field List
    - thread command, 602
  - FIELD(), 727
  - fields-enclosed-by option
    - mysqldump, 241, 250
  - fields-escaped-by option
    - mysqldump, 241, 250
  - fields-optionally-enclosed-by option
    - mysqldump, 241, 250
  - fields-terminated-by option
    - mysqldump, 241, 250
  - FILE, 729
  - files
    - binary log, 454
    - config.cache, 94
    - error messages, 667
    - general query log, 453
    - log, 85, 462
    - my.cnf, 1378
    - not found message, 2130
    - permissions, 2130
    - repairing, 268
    - script, 168
    - size limits, 2125
    - slow query log, 461
    - text, 222, 247
    - tmp, 105
  - FILES
    - INFORMATION\_SCHEMA table, 1474
    - (see also MySQL Cluster Disk Data)
  - filesort optimization, 558
  - FIND\_IN\_SET(), 728
  - Finished reading one binlog; switching to next binlog
    - thread state, 608
  - first-slave option
    - mysqldump, 241
  - fix-db-names option
    - mysqlcheck, 233
  - fix-table-names option
    - mysqlcheck, 233
  - FIXED data type, 684
  - fixed-point arithmetic, 829
  - FLOAT data type, 684, 684, 684

- floating-point number, 684
  - floating-point values
    - and replication, 1384
  - floats, 620
  - FLOOR(), 745
  - FLUSH, 997
    - and replication, 1384
  - flush option
    - mysqld, 336
  - flush system variable, 369
  - flush tables, 226
  - flush-logs option
    - mysqldump, 241
  - flush-privileges option
    - mysqldump, 241
  - Flushing tables
    - thread state, 604
  - flushlog option
    - mysqlhotcopy, 291
  - flush\_time system variable, 370
  - FOR UPDATE, 913
  - FORCE INDEX, 919, 2141
  - FORCE KEY, 919
  - force option
    - myisamchk, 267, 268
    - myisampack, 272
    - mysql, 213
    - mysqldadmin, 228
    - mysqlcheck, 233
    - mysqldump, 241
    - mysqlimport, 250
    - mysql\_convert\_table\_format, 303
    - mysql\_install\_db, 206
    - mysql\_upgrade, 208
  - force-read option
    - mysqlbinlog, 281
  - foreign key
    - constraint, 23
    - deleting, 846, 1066
  - foreign keys, 21, 171, 845
  - foreign\_key\_checks session variable, 416
  - FORMAT(), 728
  - Forums, 11
  - FOUND\_ROWS(), 793
  - FreeBSD troubleshooting, 95
  - freeing items
    - thread state, 604
  - frequently-asked questions about DRBD, 2109
  - frequently-asked questions about MySQL Cluster, 2091
  - FROM, 909
  - FROM\_DAYS(), 756
  - FROM\_UNIXTIME(), 756
  - ft\_boolean\_syntax system variable, 370
  - ft\_max\_word\_len myisamchk variable, 266
  - ft\_max\_word\_len system variable, 370
  - ft\_min\_word\_len myisamchk variable, 266
  - ft\_min\_word\_len system variable, 371
  - ft\_query\_expansion\_limit system variable, 371
  - ft\_stopword\_file myisamchk variable, 266
  - ft\_stopword\_file system variable, 371
  - full disk, 2134
  - full-text search, 765
  - FULLTEXT, 765
  - fulltext
    - stopword list, 773
  - FULLTEXT initialization
    - thread state, 604
  - fulltext join type
    - optimizer, 534
  - function
    - creating, 962
    - deleting, 962
  - function names
    - parsing, 626
    - resolving ambiguity, 626
  - functions, 709
    - and replication, 1384
    - arithmetic, 786
    - bit, 786
    - C API, 1762
    - C prepared statement API, 1810
    - cast, 774
    - control flow, 723
    - date and time, 749
    - encryption, 787
    - GROUP BY, 800
    - grouping, 716
    - information, 791
    - mathematical, 743
    - miscellaneous, 796
    - native
      - adding, 2069
      - new, 2060
      - stored, 1437
      - string, 724
      - string comparison, 733
      - user-defined, 2060
        - adding, 2061
  - Functions
    - user-defined, 962, 962
  - functions for SELECT and WHERE clauses, 709
- ## G
- gap lock
    - InnoDB, 1055, 1074, 1077, 1078
  - gb2312, gbk, 2100, 2100
  - gcc, 89
  - gdb
    - using, 2073
  - gdb option
    - mysqld, 336
  - general information, 1
  - General Public License, 3
  - general query log, 453
  - general-log option
    - mysqld, 336
  - general\_log system variable, 372
  - general\_log\_file system variable, 372
  - geographic feature, 806
  - GeomCollFromText(), 814
  - GeomCollFromWKB(), 815
  - geometry, 807
  - GEOMETRY data type, 813
  - GEOMETRYCOLLECTION data type, 813
  - GeometryCollection(), 816
  - GeometryCollectionFromText(), 814
  - GeometryCollectionFromWKB(), 815
  - GeometryFromText(), 814
  - GeometryFromWKB(), 815
  - GeometryN(), 823
  - GeometryType(), 819
  - GeomFromText(), 814, 818
  - GeomFromWKB(), 815, 818
  - geospatial feature, 807
  - getting MySQL, 42
  - GET\_FORMAT(), 756
  - GET\_LOCK(), 797
  - GIS, 806, 806
  - GLength(), 820, 821

- global privileges, 948, 955
  - GLOBAL\_STATUS
    - INFORMATION\_SCHEMA table, 1480
  - GLOBAL\_VARIABLES
    - INFORMATION\_SCHEMA table, 1480
  - go command
    - mysql, 218
  - goals of MySQL, 4
  - got handler lock
    - thread state, 607
  - got old table
    - thread state, 607
  - GRANT, 948
  - GRANT statement, 487
  - grant tables
    - re-creating, 105
    - sorting, 479, 480
    - structure, 473
    - upgrading, 204
  - granting
    - privileges, 948
  - GRANTS, 979
  - greater than (>), 719
  - greater than or equal (>=), 719
  - GREATEST(), 720
  - GROUP BY, 559
    - aliases in, 806
    - extensions to standard SQL, 805, 910
  - GROUP BY functions, 800
  - grouping
    - expressions, 716
  - GROUP\_CONCAT(), 802
  - group\_concat\_max\_len system variable, 372
- ## H
- HANDLER, 893
  - Handlers, 1013
  - handling
    - errors, 2066
  - Has read all relay log; waiting for the slave I/O thread to update it
    - thread state, 609
  - Has sent all binlog to slave; waiting for binlog to be updated
    - thread state, 608
  - hash partitioning, 1409
  - hash partitions
    - managing, 1423
    - splitting and merging, 1423
  - have\_archive system variable, 373
  - have\_blackhole\_engine system variable, 373
  - have\_compress system variable, 373
  - have\_crypt system variable, 373
  - have\_csv system variable, 373
  - have\_dynamic\_loading system variable, 373
  - have\_example\_engine system variable, 373
  - have\_federated\_engine system variable, 373
  - have\_geometry system variable, 373
  - have\_innodb system variable, 373
  - have\_isam system variable, 373
  - have\_merge\_engine system variable, 373
  - have\_openssl system variable, 373
  - have\_partitioning system variable, 373
  - have\_query\_cache system variable, 373
  - have\_raid system variable, 374
  - have\_row\_based\_replication system variable, 374
  - have\_rtree\_keys system variable, 374
  - have\_ssl system variable, 374
  - have\_symlink system variable, 374
  - HAVING, 910
  - header\_file option
    - comp\_err, 203
  - HEAP storage engine, 1019, 1107
  - help command
    - mysql, 218
  - help option
    - comp\_err, 203
    - myisamchk, 265
    - myisampack, 272
    - myisam\_ftdump, 262
    - mysql, 212
    - mysqlaccess, 277
    - mysqladmin, 228
    - mysqlbinlog, 280
    - mysqlcheck, 232
    - mysqld, 329
    - mysqldump, 239
    - mysqldumpslow, 288
    - mysqld\_multi, 200
    - mysqld\_safe, 196
    - mysqlhotcopy, 290
    - mysqlimport, 249
    - mysqlmanager, 293
    - mysqlshow, 253
    - mysqlslap, 258
    - mysql\_convert\_table\_format, 303
    - mysql\_find\_rows, 304
    - mysql\_setpermission, 305
    - mysql\_upgrade, 208
    - mysql\_waitpid, 306
    - my\_print\_defaults, 308
    - error, 309
    - resolveip, 311
    - resolve\_stack\_dump, 309
  - HELP option
    - myisamchk, 265
  - HELP statement, 934
  - HEX(), 728, 745
  - hex-blob option
    - mysqldump, 241
  - hexadecimal values, 620
  - hexdump option
    - mysqlbinlog, 281
  - HIGH\_NOT\_PRECEDENCE SQL mode, 444
  - HIGH\_PRIORITY, 913
  - hints, 16
    - index, 909, 919
  - history of MySQL, 4
  - HOME environment variable, 147, 217
  - host name
    - default, 181
  - host name caching, 614
  - host name resolution, 614
  - host option, 183
    - mysql, 213
    - mysqlaccess, 277
    - mysqladmin, 229
    - mysqlbinlog, 281
    - mysqlcheck, 234
    - mysqldump, 241
    - mysqlhotcopy, 291
    - mysqlimport, 250
    - mysqlshow, 253
    - mysqlslap, 259
    - mysql\_convert\_table\_format, 303
    - mysql\_setpermission, 305
  - host table, 481
    - sorting, 480
  - host.frm
    - problems finding, 103
  - hostname system variable, 374

- HOUR(), 757
  - howto option
    - mysqlaccess, 277
  - html option
    - mysql, 213
- I**
- i-am-a-dummy option
  - mysql, 215
- i5/OS, 76
- IBM i5/OS, 76
- icc
  - and MySQL Cluster support, 2071
- ID
  - unique, 1833
- identifiers, 621
  - case sensitivity, 623
  - quoting, 621
- identity session variable, 417
- IF, 1016
- IF(), 723
- IFNULL(), 724
- IGNORE
  - with partitioned tables, 897
- IGNORE INDEX, 919
- IGNORE KEY, 919
- ignore option
  - mysqlimport, 250
- ignore-builtin-innodb option
  - mysqld, 1052
- ignore-lines option
  - mysqlimport, 250
- ignore-spaces option
  - mysql, 213
- ignore-table option
  - mysqldump, 241
- IGNORE\_SPACE SQL mode, 444
- implicit default values, 688
- IMPORT TABLESPACE, 846, 1048
- importing
  - data, 222, 247
- IN, 720, 924
- include option
  - mysql\_config, 307
- increasing
  - performance, 1390, 1392
- increasing with replication
  - speed, 1330
- index
  - deleting, 845, 886
  - rebuilding, 122
- INDEX DIRECTORY
  - and replication, 1382
- index hints, 909, 919
- index join type
  - optimizer, 535
- index-record lock
  - InnoDB, 1055, 1074, 1077, 1078
- indexes, 856
  - and BLOB columns, 580, 868
  - and IS NULL, 582
  - and LIKE, 582
  - and NULL values, 868
  - and TEXT columns, 580, 868
  - assigning to key cache, 997
  - block size, 376
  - columns, 580
  - leftmost prefix of, 582
  - multi-column, 580
    - multiple-part, 856
    - names, 621
    - use of, 581
- index\_merge join type
  - optimizer, 534
- index\_subquery join type
  - optimizer, 535
- INET\_ATON(), 798
- INET\_NTOA(), 798
- information functions, 791
- information option
  - myisamchk, 267
- INFORMATION\_SCHEMA, 1457
- init
  - thread state, 604
- Init DB
  - thread command, 602
- init-file option
  - mysqld, 337
- Initialized
  - thread state, 610
- init\_connect system variable, 374
- init\_file system variable, 375
- init\_slave system variable, 1356
- INNER JOIN, 913
- innochecksum, 179, 261
- InnoDB, 1043
  - clustered index, 1083
  - gap lock, 1055, 1074, 1077, 1078
  - index-record lock, 1055, 1074, 1077, 1078
  - Monitors, 1071, 1085, 1093, 1101, 1102
  - next-key lock, 1055, 1074, 1077, 1078
  - NFS, 1044, 1102
  - record-level locks, 1055, 1074, 1077, 1078
  - secondary index, 1083
  - semi-consistent read, 1055
  - Solaris 10 x86\_64 issues, 129
  - transaction isolation levels, 1073
- innodb option
  - mysqld, 1052
- InnoDB storage engine, 1019, 1043
- InnoDB tables, 19
- innodb\_status\_file option
  - mysqld, 1052
- INSERT, 571, 895
- insert
  - thread state, 607
- INSERT ... SELECT, 897
- INSERT DELAYED, 898, 898
- INSERT statement
  - grant privileges, 488
- INSERT(), 728
- insert-ignore option
  - mysqldump, 242
- insertable views
  - insertable, 1450
- inserting
  - speed of, 571
- inserts
  - concurrent, 575, 578
- insert\_id session variable, 417
- install option
  - mysqlmanager, 293
- INSTALL PLUGIN, 963
- installation layouts, 45
- installation overview, 82
- installing
  - binary distribution, 80
  - Linux RPM packages, 71
  - Mac OS X PKG packages, 74

- overview, 33
- Perl, 147
- Perl on Windows, 148
- Solaris PKG packages, 75
- source distribution, 82
- user-defined functions, 2067
- installing plugins, 963
- INSTR(), 728
- INT data type, 683
- integer arithmetic, 829
- INTEGER data type, 683
- integers, 620
- interactive\_timeout system variable, 375
- InteriorRingN(), 822
- internal compiler errors, 94
- internal locking, 575
- internals, 2046
- internationalization, 635
- Internet Relay Chat, 12
- Intersection(), 824
- Intersects(), 825
- INTERVAL(), 721
- introducer
  - string literal, 618, 640
- invalid data
  - constraint, 24
- in\_file option
  - comp\_err, 203
- IRC, 12
- IS boolean\_value, 719
- IS NOT boolean\_value, 719
- IS NOT NULL, 719
- IS NULL, 548, 719
  - and indexes, 582
- isamlog, 179, 270
- IsClosed(), 821
- IsEmpty(), 819
- ISNULL(), 721
- ISOLATION LEVEL, 943
- IsRing(), 821
- IsSimple(), 820
- IS\_FREE\_LOCK(), 798
- IS\_USED\_LOCK(), 798
- ITERATE, 1017
- iterations option
  - mysqslap, 259

## J

- Japanese character sets
  - conversion, 2100, 2103
- Japanese, Korean, Chinese character sets
  - frequently asked questions, 2100
- join
  - nested-loop algorithm, 552
- JOIN, 913
- join algorithm
  - Block Nested-Loop, 549
  - Nested-Loop, 549
- join option
  - myisampack, 272
- join type
  - ALL, 535
  - const, 534
  - eq\_ref, 534
  - fulltext, 534
  - index, 535
  - index\_merge, 534
  - index\_subquery, 535
  - range, 535

- ref, 534
- ref\_or\_null, 534
- system, 533
- unique\_subquery, 534
- join\_buffer\_size system variable, 375

## K

- keepold option
  - mysqlhotcopy, 291
- keep\_files\_on\_create system variable, 376
- Key cache
  - MyISAM, 583
- key cache
  - assigning indexes to, 997
- key partitioning, 1411
- key partitions
  - managing, 1423
  - splitting and merging, 1423
- key space
  - MyISAM, 1028
- keys, 580
  - foreign, 21, 171
  - multi-column, 580
  - searching on two, 172
- keys option
  - mysqlshow, 254
- keys-used option
  - myisamchk, 268
- keywords, 628
- key\_buffer\_size myisamchk variable, 266
- key\_buffer\_size system variable, 376
- key\_cache\_age\_threshold system variable, 377
- key\_cache\_block\_size system variable, 377
- key\_cache\_division\_limit system variable, 378
- KEY\_COLUMN\_USAGE
  - INFORMATION\_SCHEMA table, 1464
- Kill
  - thread command, 602
- KILL, 999
- Killed
  - thread state, 604
- Killing slave
  - thread state, 609
- known errors, 2143
- Korean, 2100, 2104
- Korean, Chinese, Japanese character sets
  - frequently asked questions, 2100

## L

- language option
  - mysqld, 337
- language support
  - error messages, 667
- language system variable, 378
- large page support, 612
- large-pages option
  - mysqld, 337
- large\_files\_support system variable, 378
- large\_pages system variable, 378
- large\_page\_size system variable, 379
- last row
  - unique ID, 1833
- LAST\_DAY(), 757
- last\_insert\_id session variable, 417
- LAST\_INSERT\_ID(), 21, 897
  - and replication, 1378
- LAST\_INSERT\_ID() and stored routines, 1439
- LAST\_INSERT\_ID() and triggers, 1439
- LAST\_INSERT\_ID(<replaceable>expr</replaceable>), 794

- layout of installation, 45
- LCASE(), 728
- lc\_time\_names system variable, 379
- ldata option
  - mysql\_install\_db, 206
- LD\_LIBRARY\_PATH environment variable, 149
- LD\_RUN\_PATH environment variable, 125, 131, 147, 149
- LEAST(), 721
- LEAVE, 1017
- ledir option
  - mysqld\_safe, 196
- LEFT JOIN, 548, 913
- LEFT OUTER JOIN, 913
- LEFT(), 728
- leftmost prefix of indexes, 582
- legal names, 621
- length option
  - myisam\_ftdump, 262
- LENGTH(), 729
- less than (<), 719
- less than or equal (<=), 718
- libmysqld, 1754
  - options, 1755
- libmysqld-libs option
  - mysql\_config, 307
- libraries
  - list of, 30
- library
  - mysqlclient, 1484
  - mysqld, 1484
- libs option
  - mysql\_config, 307
- libs\_r option
  - mysql\_config, 307
- license system variable, 379
- LIKE, 733
  - and indexes, 582
  - and wildcards, 582
- LIMIT, 564, 793, 911
  - and replication, 1385
- limitations
  - design, 529
  - MySQL Limitations, 2521
  - replication, 1378
- limits
  - file-size, 2125
  - MySQL Limits, limits in MySQL, 2521
- line-numbers option
  - mysql, 213
- linear hash partitioning, 1410
- linear key partitioning, 1412
- linefeed (\n), 619, 905
- LineFromText(), 814
- LineFromWKB(), 815
- lines-terminated-by option
  - mysqldump, 242, 250
- LINestring data type, 813
- LineString(), 816
- LineStringFromText(), 814
- LineStringFromWKB(), 815
- linking, 1838
  - errors, 2129
  - problems, 1834
  - speed, 589
- links
  - symbolic, 615
- Linux
  - binary distribution, 124
  - source distribution, 124
- list partitioning, 1407
  - list partitions
    - adding and dropping, 1419
    - managing, 1419
  - list-users option
    - mysqlmanager, 294
  - literals, 618
  - LN(), 745
  - LOAD DATA
    - and replication, 1385
  - LOAD DATA FROM MASTER, 1004
  - LOAD DATA INFILE, 900, 2138
  - load emulation, 254
  - LOAD INDEX INTO CACHE
    - and partitioning, 1431
  - LOAD TABLE FROM MASTER, 1005
  - loading
    - tables, 156
  - LOAD\_FILE(), 729
  - local option
    - mysqlimport, 250
  - local-infile option
    - mysql, 213
    - mysqld, 467
  - local-load option
    - mysqlbinlog, 281
  - localization, 635
  - localstatedir option
    - configure, 89
  - LOCALTIME, 757
  - LOCALTIMESTAMP, 757
  - local\_infile system variable, 379
  - LOCATE(), 729
  - LOCK IN SHARE MODE, 913
  - Lock Monitor
    - InnoDB, 1093
  - LOCK TABLES, 939
  - lock-all-tables option
    - mysqldump, 242
  - lock-directory option
    - mysqslap, 259
  - lock-tables option
    - mysqldump, 242
    - mysqlimport, 250
  - Locked
    - thread state, 604
  - locked\_in\_memory system variable, 379
  - locking, 590
    - external, 336, 347, 404, 520, 578, 606
    - internal, 575
    - row-level, 21, 575
    - table-level, 575
  - locking methods, 575
  - log
    - changes, 2207
  - log files, 85
    - maintaining, 462
  - log option
    - mysqld, 338
    - mysqld\_multi, 200
    - mysqlmanager, 294
  - log system variable, 380
  - LOG(), 745
  - log-bin option
    - mysqld, 1359
  - log-bin-index option
    - mysqld, 1360
  - log-bin-trust-function-creators option
    - mysqld, 1361
  - log-error option
    - mysqld, 338

- mysqldump, 242
  - mysqld\_safe, 196
  - log-isam option
    - mysqld, 338
  - log-long-format option
    - mysqld, 339
  - log-output option
    - mysqld, 339
  - log-queries-not-using-indexes option
    - mysqld, 339
  - log-short-format option
    - mysqld, 340
  - log-slave-updates option
    - mysqld, 1349
  - log-slow-admin-statements option
    - mysqld, 340
  - log-slow-queries option
    - mysqld, 340
  - log-slow-slave-statements option
    - mysqld, 1350
  - log-tc option
    - mysqld, 340
  - log-tc-size option
    - mysqld, 341
  - log-warnings option
    - mysqld, 341, 1350
  - LOG10(), 746
  - LOG2(), 745
  - logging slow query
    - thread state, 604
  - logical operators, 721
  - login
    - thread state, 604
  - logs
    - server, 450
  - log\_bin system variable, 380
  - log\_bin\_trust\_function\_creators system variable, 380
  - log\_error system variable, 380
  - log\_output system variable, 380
  - log\_queries\_not\_using\_indexes system variable, 381
  - log\_slave\_updates system variable, 381
  - log\_slow\_queries system variable, 381
  - log\_warnings system variable, 381
  - Long Data
    - thread command, 602
  - LONG data type, 700
  - LONGBLOB data type, 688
  - LONGTEXT data type, 688
  - long\_query\_time system variable, 382
  - LOOP, 1017
  - lost connection errors, 2120
  - low-priority option
    - mysqlexport, 250
  - low-priority-updates option
    - mysqld, 341
  - LOWER(), 729
  - lower\_case\_file\_system system variable, 382
  - lower\_case\_table\_names system variable, 383
  - low\_priority\_updates system variable, 382
  - LPAD(), 729
  - LTRIM(), 729
- M**
- Mac OS X, 1486
    - installation, 74
  - mailing list address, 1
  - mailing lists, 9
    - archive location, 9
    - guidelines, 11
  - main features of MySQL, 4
  - maintaining
    - log files, 462
    - tables, 527
  - maintenance
    - tables, 230
  - MAKEDATE(), 757
  - MAKETIME(), 758
  - make\_binary\_distribution, 177
  - MAKE\_SET(), 730
  - make\_win\_bin\_dist, 177, 203
    - debug option, 204
    - embedded option, 204
    - exe-suffix option, 204
    - no-debug option, 204
    - no-embedded option, 204
    - only-debug option, 204
  - Making temp file
    - thread state, 609
  - manual
    - available formats, 1
    - online location, 1
    - syntax conventions, 2
    - typographical conventions, 2
  - master-connect-retry option
    - mysqld, 1350
  - master-data option
    - mysqldump, 242
  - master-host option
    - mysqld, 1350
  - master-info-file option
    - mysqld, 1350
  - master-password option
    - mysqld, 1350
  - master-port option
    - mysqld, 1351
  - master-retry-count option
    - mysqld, 1351
  - master-ssl option
    - mysqld, 1351
  - master-ssl-ca option
    - mysqld, 1351
  - master-ssl-capath option
    - mysqld, 1351
  - master-ssl-cert option
    - mysqld, 1351
  - master-ssl-cipher option
    - mysqld, 1351
  - master-ssl-key option
    - mysqld, 1351
  - master-user option
    - mysqld, 1351
  - MASTER\_POS\_WAIT(), 798, 1005
  - MATCH ... AGAINST(), 765
  - matching
    - patterns, 163
  - math, 829
  - mathematical functions, 743
  - MAX(), 802
  - MAX(DISTINCT), 802
  - max-binlog-dump-events option
    - mysqld, 1362
  - max-record-length option
    - myisamchk, 268
  - max-relay-log-size option
    - mysqld, 1351
  - MAXDB SQL mode, 448
  - maximum memory used, 226
  - maximums
    - maximum columns per table, 2522



- maximum tables per join, 2521
- max\_allowed\_packet system variable, 383
- max\_allowed\_packet variable, 216
- max\_binlog\_cache\_size system variable, 1364
- max\_binlog\_size system variable, 1364
- max\_connections system variable, 384
- MAX\_CONNECTIONS\_PER\_HOUR, 489
- max\_connect\_errors system variable, 384
- max\_delayed\_threads system variable, 384
- max\_error\_count system variable, 385
- max\_heap\_table\_size system variable, 385
- max\_insert\_delayed\_threads system variable, 386
- max\_join\_size system variable, 386
- max\_join\_size variable, 217
- max\_length\_for\_sort\_data system variable, 386
- max\_prepared\_stmt\_count system variable, 386
- MAX\_QUERIES\_PER\_HOUR, 489
- max\_relay\_log\_size system variable, 387
- max\_seeks\_for\_key system variable, 387
- max\_sort\_length system variable, 388
- max\_sp\_recursion\_depth system variable, 388
- max\_tmp\_tables system variable, 388
- MAX\_UPDATES\_PER\_HOUR, 489
- MAX\_USER\_CONNECTIONS, 489
- max\_user\_connections system variable, 389
- max\_write\_lock\_count system variable, 389
- MBR, 824
- MBRContains(), 824
- MBRDisjoint(), 824
- MBREqual(), 824
- MBRIntersects(), 824
- MBROverlaps(), 824
- MBRTouches(), 825
- MBRWithin(), 825
- MD5(), 790
- medium-check option
  - myisamchk, 267
  - mysqlcheck, 234
- MEDIUMBLOB data type, 687
- MEDIUMINT data type, 683
- MEDIUMTEXT data type, 687
- memlock option
  - mysqld, 342
- MEMORY storage engine, 1019, 1107
  - and replication, 1386
- memory usage
  - myisamchk, 270
- memory use, 226, 611
- MERGE storage engine, 1019, 1104
- MERGE tables
  - defined, 1104
- metadata
  - database, 1457
  - stored routines, 1438
  - triggers, 1441
  - views, 1451
- method option
  - mysqlhotcopy, 291
- methods
  - locking, 575
- MICROSECOND(), 758
- Microsoft Access, 1556
- Microsoft ADO, 1558
- Microsoft Excel, 1557
- Microsoft Visual Basic, 1557
- Microsoft Visual InterDev, 1558
- MID(), 730
- MIN(), 802
- MIN(DISTINCT), 802
- min-examined-row-limit option
  - mysqld, 342
- Minimum Bounding Rectangle, 824
- minus
  - unary (-), 741
- MINUTE(), 758
- min\_examined\_row\_limit system variable, 389
- mirror sites, 42
- miscellaneous functions, 796
- MIT-pthreads, 96
- MLineFromText(), 814
- MLineFromWKB(), 815
- MOD (modulo), 746
- MOD(), 746
- modes
  - batch, 168
- modulo (%), 746
- modulo (MOD), 746
- monitor
  - terminal, 151
- monitoring-interval option
  - mysqlmanager, 294
- Monitors
  - InnoDB, 1071, 1085, 1093, 1101, 1102
- Mono, 1565
- MONTH(), 758
- MONTHNAME(), 758
- MPointFromText(), 814
- MPointFromWKB(), 815
- MPolyFromText(), 814
- MPolyFromWKB(), 815
- mSQL compatibility, 736
- mysql2mysql, 307
- MSSQL SQL mode, 448
- multi mysqld, 199
- multi-byte character sets, 2128
- multi-byte characters, 670
- multi-column indexes, 580
- MULTILINESTRING data type, 813
- MultiLineString(), 816
- MultiLineStringFromText(), 814
- MultiLineStringFromWKB(), 815
- multiple servers, 506
- multiple-part index, 856
- multiplication (\*), 741
- MULTIPOINT data type, 813
- MultiPoint(), 816
- MultiPointFromText(), 814
- MultiPointFromWKB(), 815
- MULTIPOLYGON data type, 813
- MultiPolygon(), 816
- MultiPolygonFromText(), 814
- MultiPolygonFromWKB(), 815
- My
  - derivation, 4
- my.cnf file, 1378
- MyISAM
  - compressed tables, 271, 1029
- MyISAM key cache, 583
- MyISAM storage engine, 1019, 1024
- myisam-block-size option
  - mysqld, 343
- myisam-recover option
  - mysqld, 343, 1027
- myisamchk, 90, 179, 262
  - analyze option, 269
  - backup option, 268
  - block-search option, 269
  - character-sets-dir option, 268
  - check option, 267
  - check-only-changed option, 267

- correct-checksum option, 268
- data-file-length option, 268
- debug option, 265
- description option, 269
- example output, 523
- extend-check option, 267, 268
- fast option, 267
- force option, 267, 268
- help option, 265
- HELP option, 265
- information option, 267
- keys-used option, 268
- max-record-length option, 268
- medium-check option, 267
- no-symlinks option, 268
- options, 265
- parallel-recover option, 268
- quick option, 268
- read-only option, 267
- recover option, 268
- safe-recover option, 269
- set-auto-increment[ option, 269
- set-character-set option, 269
- set-collation option, 269
- silent option, 266
- sort-index option, 269
- sort-records option, 269
- sort-recover option, 269
- tmpdir option, 269
- unpack option, 269
- update-state option, 268
- verbose option, 266
- version option, 266
- wait option, 266
- mysamlog, 179, 270
- mysampack, 179, 271, 878, 1029
  - backup option, 272
  - character-sets-dir option, 272
  - debug option, 272
  - force option, 272
  - help option, 272
  - join option, 272
  - silent option, 272
  - test option, 272
  - tmpdir option, 272
  - verbose option, 272
  - version option, 272
  - wait option, 272
- mysam\_block\_size mysamchk variable, 266
- mysam\_data\_pointer\_size system variable, 390
- mysam\_ftdump, 179, 261
  - count option, 262
  - dump option, 262
  - help option, 262
  - length option, 262
  - stats option, 262
  - verbose option, 262
- mysam\_max\_sort\_file\_size system variable, 390
- mysam\_recover\_options system variable, 390
- mysam\_repair\_threads system variable, 390
- mysam\_sort\_buffer\_size system variable, 391
- mysam\_stats\_method system variable, 391
- mysam\_use\_mmap system variable, 392
- MyODBC, 1486
- MySQL
  - defined, 3
  - introduction, 3
  - pronunciation, 4
  - upgrading, 207
- mysql, 178, 209
  - auto-rehash option, 212
  - batch option, 212
  - character-sets-dir option, 212
  - charset command, 218
  - clear command, 218
  - column-names option, 212
  - column-type-info option, 212
  - comments option, 212
  - compress option, 212
  - connect command, 218
  - database option, 212
  - debug option, 212
  - debug-check option, 212
  - debug-info option, 212
  - default-character-set option, 213
  - delimiter command, 218
  - delimiter option, 213
  - disable named commands, 213
  - edit command, 218
  - ego command, 218
  - execute option, 213
  - exit command, 218
  - force option, 213
  - go command, 218
  - help command, 218
  - help option, 212
  - host option, 213
  - html option, 213
  - i-am-a-dummy option, 215
  - ignore-spaces option, 213
  - line-numbers option, 213
  - local-infile option, 213
  - named-commands option, 213
  - no-auto-rehash option, 213
  - no-beep option, 213
  - no-named-commands option, 213
  - no-pager option, 214
  - no-tee option, 214
  - nopager command, 218
  - notee command, 218
  - nowarning command, 218
  - one-database option, 214
  - pager command, 219
  - pager option, 214
  - password option, 214
  - pipe option, 214
  - port option, 214
  - print command, 219
  - prompt command, 219
  - prompt option, 214
  - protocol option, 214
  - quick option, 214
  - quit command, 219
  - raw option, 214
  - reconnect option, 215
  - rehash command, 219
  - safe-updates option, 215
  - secure-auth option, 215
  - show-warnings option, 215
  - sigint-ignore option, 215
  - silent option, 215
  - skip-column-names option, 215
  - skip-line-numbers option, 215
  - socket option, 215
  - source command, 219
  - SSL options, 215
  - status command, 219
  - system command, 219
  - table option, 215
  - tee command, 219

- tee option, 215
- unbuffered option, 215
- use command, 219
- user option, 216
- verbose option, 216
- version option, 216
- vertical option, 216
- wait option, 216
- warnings command, 219
- xml option, 216
- MySQL binary distribution, 35
- MySQL C type, 1758
- MySQL Cluster
  - <errortext>Table is full</errortext> error, 2091, 2095
  - <foreignphrase>vs</foreignphrase> replication, 2091, 2093
  - and transactions, 2091, 2096
  - arbitrator, 2092, 2098
  - compiling with icc, 2071
  - data types supported, 2092, 2098
  - error messages, 2091, 2096
  - FAQ, 2091
  - hardware requirements, 2091, 2094
  - how to obtain, 2091, 2092
  - importing existing tables, 2092, 2097
  - master node, 2091, 2093
  - memory requirements, 2091, 2094
  - ndb\_size.pl (utility), 2095
  - networking requirements, 2091, 2091, 2093, 2095
  - node types, 2093
  - number of computers required, 2091, 2093
  - platforms supported, 2091, 2094
  - roles of computers, 2091, 2093
  - security, 2096
  - SQL statements, 2091, 2096
  - starting and stopping, 2092, 2098
  - storage requirements, 704
  - thread states, 610
  - using in a virtual machine, 2091, 2095
- mysql command options, 209
- mysql commands
  - list of, 217
- MySQL Dolphin name, 4
- MySQL history, 4
- mysql history file, 217
- MySQL Instance Manager, 292
- MySQL mailing lists, 9
- MySQL name, 4
- mysql prompt command, 220
- MySQL server
  - mysqld, 194, 312
- mysql source (command for reading from text files), 169, 222
- MySQL source distribution, 35
- MySQL storage engines, 1019
- MySQL system tables
  - and replication, 1386
- MySQL version, 42
- mysql \. (command for reading from text files), 169, 222
- MySQL++, 2044
- mysql.event table, 1447
- mysql.server, 177, 198
  - basedir option, 199
  - datadir option, 199
  - pid-file option, 199
  - service-startup-timeout option, 199
  - use-manager option, 199
  - use-mysqld\_safe option, 199
  - user option, 199
- mysql.sock
  - changing location of, 89
  - protection, 2135
- MYSQL323 SQL mode, 448
- MYSQL40 SQL mode, 448
- mysqlaccess, 179, 276
  - brief option, 277
  - commit option, 277
  - copy option, 277
  - db option, 277
  - debug option, 277
  - help option, 277
  - host option, 277
  - howto option, 277
  - old\_server option, 277
  - password option, 277
  - plan option, 277
  - preview option, 277
  - relnotes option, 277
  - rhost option, 278
  - rollback option, 278
  - spassword option, 278
  - superuser option, 278
  - table option, 278
  - user option, 278
  - version option, 278
- mysqladmin, 178, 224, 852, 886, 990, 994, 997, 999
  - character-sets-dir option, 228
  - compress option, 228
  - count option, 228
  - debug option, 228
  - debug-check option, 228
  - debug-info option, 228
  - default-character-set option, 228
  - force option, 228
  - help option, 228
  - host option, 229
  - no-beep option, 229
  - password option, 229
  - pipe option, 229
  - port option, 229
  - protocol option, 229
  - relative option, 229
  - silent option, 229
  - sleep option, 229
  - socket option, 229
  - SSL options, 229
  - user option, 229
  - verbose option, 229
  - version option, 229
  - vertical option, 229
  - wait option, 230
- mysqladmin command options, 227
- mysqladmin option
  - mysqld\_multi, 200
- mysqlbinlog, 179, 278
  - base64-output option, 280
  - character-sets-dir option, 280
  - database option, 280
  - debug option, 280
  - debug-check option, 281
  - debug-info option, 281
  - disable-log-bin option, 281
  - force-read option, 281
  - help option, 280
  - hexdump option, 281
  - host option, 281
  - local-load option, 281
  - offset option, 281
  - password option, 281
  - port option, 281
  - position option, 281
  - protocol option, 281

- read-from-remote-server option, 281
- result-file option, 282
- server-id option, 282
- set-charset option, 282
- short-form option, 282
- socket option, 282
- start-datetime option, 282
- start-position option, 282
- stop-datetime option, 282
- stop-position option, 282
- to-last-log option, 282
- user option, 282
- verbose option, 282
- version option, 282
- write-binlog option, 283
- mysqlbug, 204
- mysqlbug script, 15
- mysqlcheck, 178, 230
  - all-databases option, 232
  - all-in-1 option, 232
  - analyze option, 232
  - auto-repair option, 233
  - character-sets-dir option, 233
  - check option, 233
  - check-only-changed option, 233
  - check-upgrade option, 233
  - compress option, 233
  - databases option, 233
  - debug option, 233
  - debug-check option, 233
  - debug-info option, 233
  - default-character-set option, 233
  - extended option, 233
  - fast option, 233
  - fix-db-names option, 233
  - fix-table-names option, 233
  - force option, 233
  - help option, 232
  - host option, 234
  - medium-check option, 234
  - optimize option, 234
  - password option, 234
  - pipe option, 234
  - port option, 234
  - protocol option, 234
  - quick option, 234
  - repair option, 234
  - silent option, 234
  - socket option, 234
  - SSL options, 234
  - tables option, 234
  - use-frm option, 234
  - user option, 235
  - verbose option, 235
  - version option, 235
- mysqlclient library, 1484
- mysqld, 177
  - abort-slave-event-count option, 1356
  - allow-suspicious-udfs option, 329, 467
  - ansi option, 329
  - basedir option, 329
  - big-tables option, 330
  - bind-address option, 330
  - binlog-do-db option, 1360
  - binlog-format option, 330
  - binlog-ignore-db option, 1361
  - binlog-row-event-max-size option, 1359
  - bootstrap option, 331
  - character-set-client-handshake option, 331
  - character-set-filesystem option, 331
  - character-set-server option, 332
  - character-sets-dir option, 331
  - chroot option, 332
  - collation-server option, 332
  - command options, 328
  - console option, 332
  - core-file option, 332
  - datadir option, 333
  - debug option, 333
  - default-character-set option, 333
  - default-collation option, 333
  - default-storage-engine option, 334
  - default-table-type option, 334
  - default-time-zone option, 334
  - delay-key-write option, 334, 1027
  - des-key-file option, 334
  - disconnect-slave-event-count option, 1356
  - enable-named-pipe option, 335
  - enable-pstack option, 335
  - event-scheduler option, 335
  - exit-info option, 336
  - external-locking option, 336
  - flush option, 336
  - gdb option, 336
  - general-log option, 336
  - help option, 329
  - ignore-builtin-innodb option, 1052
  - init-file option, 337
  - innodb option, 1052
  - innodb\_status\_file option, 1052
  - language option, 337
  - large-pages option, 337
  - local-infile option, 467
  - log option, 338
  - log-bin option, 1359
  - log-bin-index option, 1360
  - log-bin-trust-function-creators option, 1361
  - log-error option, 338
  - log-isam option, 338
  - log-long-format option, 339
  - log-output option, 339
  - log-queries-not-using-indexes option, 339
  - log-short-format option, 340
  - log-slave-updates option, 1349
  - log-slow-admin-statements option, 340
  - log-slow-queries option, 340
  - log-slow-slave-statements option, 1350
  - log-tc option, 340
  - log-tc-size option, 341
  - log-warnings option, 341, 1350
  - low-priority-updates option, 341
  - master-connect-retry option, 1350
  - master-host option, 1350
  - master-info-file option, 1350
  - master-password option, 1350
  - master-port option, 1351
  - master-retry-count option, 1351
  - master-ssl option, 1351
  - master-ssl-ca option, 1351
  - master-ssl-capath option, 1351
  - master-ssl-cert option, 1351
  - master-ssl-cipher option, 1351
  - master-ssl-key option, 1351
  - master-user option, 1351
  - max-binlog-dump-events option, 1362
  - max-relay-log-size option, 1351
  - memlock option, 342
  - min-examined-row-limit option, 342
  - myisam-block-size option, 343
  - myisam-recover option, 343, 1027

- MySQL server, 194, 312
- old-passwords option, 343, 467
- old-style-user-limits option, 343
- one-thread option, 344
- open-files-limit option, 344
- pid-file option, 344
- plugin-load option, 344
- port option, 345
- port-open-timeout option, 345
- read-only option, 1351
- relay-log option, 1351
- relay-log-index option, 1351
- relay-log-info-file option, 1352
- relay-log-purge option, 1352
- relay-log-space-limit option, 1352
- replicate-do-db option, 1352
- replicate-do-table option, 1353
- replicate-ignore-db option, 1353
- replicate-ignore-table option, 1353
- replicate-rewrite-db option, 1354
- replicate-same-server-id option, 1354
- replicate-wild-do-table option, 1354
- replicate-wild-ignore-table option, 1354
- report-host option, 1354
- report-password option, 1355
- report-port option, 1355
- report-user option, 1355
- safe-mode option, 345
- safe-show-database option, 346, 467
- safe-user-create option, 346, 467
- secure-auth option, 346, 467
- secure-file-priv option, 346, 467
- server-id option, 1343
- shared-memory option, 347
- shared-memory-base-name option, 347
- show-slave-auth-info option, 1355
- skip-concurrent-insert option, 347
- skip-external-locking option, 347
- skip-grant-tables option, 347, 467
- skip-host-cache option, 347
- skip-innodb option, 347
- skip-merge option, 468
- skip-name-resolve option, 347, 468
- skip-networking option, 347, 468
- skip-safemalloc option, 348
- skip-show-database option, 348, 468
- skip-slave-start option, 1355
- skip-stack-trace option, 348
- skip-symbolic-links option, 348
- skip-thread-priority option, 348
- slave-load-tmpdir option, 1355
- slave-net-timeout option, 1355
- slave-skip-errors option, 1355
- slave\_compressed\_protocol option, 1355
- slow-query-log option, 349
- socket option, 349
- sporadic-binlog-dump-fail option, 1362
- sql-mode option, 349
- SSL options, 347, 468
- standalone option, 347
- starting, 469
- symbolic-links option, 348
- sysdate-is-now option, 350
- tc-heuristic-recover option, 350
- temp-pool option, 350
- tmpdir option, 351
- transaction-isolation option, 350
- user option, 351
- verbose option, 351
- version option, 351
- mysqld library, 1484
- mysqld option
  - mysqld\_multi, 200
  - mysqld\_safe, 196
- mysqld options, 591
- mysqld server
  - buffer sizes, 591
- mysqld-safe-compatible option
- mysqlmanager, 294
- mysqld-version option
- mysqld\_safe, 196
- mysqldump, 123, 178, 235
  - add-drop-database option, 239
  - add-drop-table option, 239
  - add-locks option, 239
  - all-databases option, 239
  - all-tablespaces option, 239
  - allow-keywords option, 239
  - character-sets-dir option, 239
  - comments option, 239
  - compact option, 240
  - compatible option, 240
  - complete-insert option, 240
  - compress option, 240
  - create-options option, 240
  - databases option, 240
  - debug option, 240
  - debug-check option, 240
  - debug-info option, 240
  - default-character-set option, 240
  - delayed-insert option, 240
  - delete-master-logs option, 241
  - disable-keys option, 241
  - dump-date option, 241
  - events option, 241
  - extended-insert option, 241
  - fields-enclosed-by option, 241, 250
  - fields-escaped-by option, 241, 250
  - fields-optionally-enclosed-by option, 241, 250
  - fields-terminated-by option, 241, 250
  - first-slave option, 241
  - flush-logs option, 241
  - flush-privileges option, 241
  - force option, 241
  - help option, 239
  - hex-blob option, 241
  - host option, 241
  - ignore-table option, 241
  - insert-ignore option, 242
  - lines-terminated-by option, 242, 250
  - lock-all-tables option, 242
  - lock-tables option, 242
  - log-error option, 242
  - master-data option, 242
  - no-autocommit option, 243
  - no-create-db option, 243
  - no-create-info option, 243
  - no-data option, 243
  - no-set-names option, 243
  - opt option, 243
  - order-by-primary option, 243
  - password option, 243
  - pipe option, 243
  - port option, 243
  - problems, 247, 2520
  - protocol option, 243
  - quick option, 244
  - quote-names option, 244
  - replace option, 244
  - result-file option, 244

- routines option, 244
- set-charset option, 244
- single-transaction option, 244
- skip-comments option, 244
- skip-opt option, 245
- socket option, 245
- SSL options, 245
- tab option, 245
- tables option, 245
- triggers option, 245
- tz-utc option, 245
- user option, 245
- verbose option, 245
- version option, 245
- views, 247, 2520
- where option, 245
- workarounds, 247, 2520
- xml option, 245
- mysqldumpslow, 179, 288
  - debug option, 288
  - help option, 288
  - verbose option, 289
- mysqld\_multi, 177, 199
  - config-file option, 200
  - defaults-extra-file option, 200
  - defaults-file option, 200
  - example option, 200
  - help option, 200
  - log option, 200
  - mysqladmin option, 200
  - mysqld option, 200
  - no-defaults option, 200
  - no-log option, 201
  - password option, 201
  - silent option, 201
  - tcp-ip option, 201
  - user option, 201
  - verbose option, 201
  - version option, 201
- mysqld\_safe, 177, 194
  - autoclose option, 196
  - basedir option, 196
  - core-file-size option, 196
  - datadir option, 196
  - defaults-extra-file option, 196
  - defaults-file option, 196
  - help option, 196
  - ledir option, 196
  - log-error option, 196
  - mysqld option, 196
  - mysqld-version option, 196
  - nice option, 196
  - no-defaults option, 197
  - open-files-limit option, 197
  - pid-file option, 197
  - port option, 197
  - skip-kill-mysqld option, 197
  - skip-syslog option, 197
  - socket option, 197
  - syslog option, 197
  - syslog-tag option, 197
  - timezone option, 197
  - user option, 197
- mysqlhotcopy, 179, 289
  - addtodest option, 290
  - allowold option, 290
  - checkpoint option, 290
  - chroot option, 291
  - debug option, 291
  - dryrun option, 291
  - flushlog option, 291
  - help option, 290
  - host option, 291
  - keepold option, 291
  - method option, 291
  - noindices option, 291
  - password option, 291
  - port option, 291
  - quiet option, 291
  - record\_log\_pos option, 291
  - regexp option, 291
  - resetmaster option, 291
  - resetslave option, 291
  - socket option, 291
  - suffix option, 291
  - tmpdir option, 292
  - user option, 292
- mysqlimport, 123, 178, 247, 901
  - character-sets-dir option, 249
  - columns option, 249
  - compress option, 249
  - debug option, 249
  - debug-check option, 249
  - debug-info option, 250
  - default-character-set option, 250
  - delete option, 250
  - force option, 250
  - help option, 249
  - host option, 250
  - ignore option, 250
  - ignore-lines option, 250
  - local option, 250
  - lock-tables option, 250
  - low-priority option, 250
  - password option, 250
  - pipe option, 250
  - port option, 251
  - protocol option, 251
  - replace option, 251
  - silent option, 251
  - socket option, 251
  - SSL options, 251
  - use-threads option, 251
  - user option, 251
  - verbose option, 251
  - version option, 251
- mysqlmanager, 179, 292
  - add-user option, 293
  - angel-pid-file option, 293
  - bind-address option, 293
  - check-password-file option, 293
  - clean-password-file option, 293
  - debug option, 293
  - default-mysqld-path option, 293
  - defaults-file option, 293
  - drop-user option, 293
  - edit-user option, 293
  - help option, 293
  - install option, 293
  - list-users option, 294
  - log option, 294
  - monitoring-interval option, 294
  - mysqld-safe-compatible option, 294
  - password option, 294
  - password-file option, 294
  - pid-file option, 294
  - port option, 294
  - print-defaults option, 294
  - print-password-line option, 294
  - remove option, 295

- run-as-service option, 295
- socket option, 295
- standalone option, 295
- user option, 295
- username option, 295
- version option, 295
- wait-timeout option, 295
- mysqlshow, 178, 252
  - character-sets-dir option, 253
  - compress option, 253
  - count option, 253
  - debug option, 253
  - debug-check option, 253
  - debug-info option, 253
  - default-character-set option, 253
  - help option, 253
  - host option, 253
  - keys option, 254
  - password option, 254
  - pipe option, 254
  - port option, 254
  - protocol option, 254
  - show-table-type option, 254
  - socket option, 254
  - SSL options, 254
  - status option, 254
  - user option, 254
  - verbose option, 254
  - version option, 254
- mysqlslap, 178, 254
  - auto-generate-sql option, 258
  - auto-generate-sql-add-autoincrement option, 258
  - auto-generate-sql-execute-number option, 258
  - auto-generate-sql-guid-primary option, 258
  - auto-generate-sql-load-type option, 258
  - auto-generate-sql-secondary-indexes option, 258
  - auto-generate-sql-unique-query-number option, 258
  - auto-generate-sql-unique-write-number option, 258
  - auto-generate-sql-write-number option, 258
  - commit option, 258
  - compress option, 258
  - concurrency option, 258
  - create option, 259
  - create-schema option, 259
  - csv option, 259
  - debug option, 259
  - debug-check option, 259
  - debug-info option, 259
  - delimiter option, 259
  - detach option, 259
  - engine option, 259
  - help option, 258
  - host option, 259
  - iterations option, 259
  - lock-directory option, 259
  - number-char-cols option, 259
  - number-int-cols option, 259
  - number-of-queries option, 259
  - only-print option, 259
  - password option, 259, 260
  - pipe option, 260
  - port option, 260
  - post-query option, 260
  - post-system option, 260
  - pre-query option, 260
  - pre-system option, 260
  - preserve-schema option, 260
  - protocol option, 260
  - query option, 260
  - shared-memory-base-name option, 260
  - silent option, 260
  - slave option, 260
  - socket option, 260
  - SSL options, 260
  - use-threads option, 261
  - user option, 261
  - verbose option, 261
  - version option, 261
- mysqltest
  - MySQL Test Suite, 2046
- mysql\_affected\_rows(), 1765
- mysql\_autocommit(), 1766
- MYSQL\_BIND C type, 1806
- mysql\_change\_user(), 1766
- mysql\_character\_set\_name(), 1767
- mysql\_close(), 1768
- mysql\_commit(), 1768
- mysql\_config, 307
  - cflags option, 307
  - embedded option, 307
  - include option, 307
  - libmysqld-libs option, 307
  - libs option, 307
  - libs\_r option, 307
  - plugindir option, 307
  - port option, 307
  - socket option, 307
  - version option, 307
- mysql\_connect(), 1768
- mysql\_convert\_table\_format, 179, 303
  - force option, 303
  - help option, 303
  - host option, 303
  - password option, 303
  - port option, 303
  - socket option, 304
  - type option, 304
  - user option, 304
  - verbose option, 304
  - version option, 304
- mysql\_create\_db(), 1768
- mysql\_data\_seek(), 1769
- MYSQL\_DEBUG environment variable, 147, 181, 2077
- mysql\_debug(), 1769
- mysql\_drop\_db(), 1770
- mysql\_dump\_debug\_info(), 1770
- mysql\_eof(), 1771
- mysql\_errno(), 1771
- mysql\_error(), 1772
- mysql\_escape\_string(), 1772
- mysql\_fetch\_field(), 1772
- mysql\_fetch\_fields(), 1773
- mysql\_fetch\_field\_direct(), 1773
- mysql\_fetch\_lengths(), 1774
- mysql\_fetch\_row(), 1774
- MYSQL\_FIELD C type, 1758
- mysql\_field\_count(), 1775, 1786
- MYSQL\_FIELD\_OFFSET C type, 1759
- mysql\_field\_seek(), 1776
- mysql\_field\_tell(), 1776
- mysql\_find\_rows, 179, 304
  - help option, 304
  - regex option, 304
  - rows option, 304
  - skip-use-db option, 304
  - start\_row option, 304
- mysql\_fix\_extensions, 179, 304
- mysql\_fix\_privilege\_tables, 178, 204
- mysql\_free\_result(), 1776
- mysql\_get\_character\_set\_info(), 1777

- 
- mysql\_get\_client\_info(), 1777
  - mysql\_get\_client\_version(), 1777
  - mysql\_get\_host\_info(), 1777
  - mysql\_get\_proto\_info(), 1778
  - mysql\_get\_server\_info(), 1778
  - mysql\_get\_server\_version(), 1778
  - mysql\_get\_ssl\_cipher(), 1778
  - MYSQL\_GROUP\_SUFFIX environment variable, 147
  - mysql\_hex\_string(), 1779
  - MYSQL\_HISTFILE environment variable, 147, 217
  - MYSQL\_HOME environment variable, 147
  - MYSQL\_HOST environment variable, 147, 184
  - mysql\_info(), 849, 896, 907, 932, 1779
  - mysql\_init(), 1780
  - mysql\_insert\_id(), 21, 897, 1780
  - mysql\_install\_db, 104, 178, 205
    - basedir option, 205
    - datadir option, 206
    - force option, 206
    - ldata option, 206
    - rpm option, 206
    - skip-name-resolve option, 206
    - srcdir option, 206
    - user option, 206
    - verbose option, 206
    - windows option, 206
  - mysql\_kill(), 1781
  - mysql\_library\_end(), 1782
  - mysql\_library\_init(), 1782
  - mysql\_list\_dbs(), 1783
  - mysql\_list\_fields(), 1784
  - mysql\_list\_processes(), 1784
  - mysql\_list\_tables(), 1785
  - mysql\_more\_results(), 1785
  - mysql\_next\_result(), 1785
  - mysql\_num\_fields(), 1786
  - mysql\_num\_rows(), 1787
  - mysql\_options(), 1787
  - mysql\_ping(), 1790
  - MYSQL\_PS1 environment variable, 147
  - MYSQL\_PWD environment variable, 147, 181, 184
  - mysql\_query(), 1791, 1832
  - mysql\_real\_connect(), 1792
  - mysql\_real\_escape\_string(), 619, 1794
  - mysql\_real\_query(), 1795
  - mysql\_refresh(), 1796
  - mysql\_reload(), 1797
  - MYSQL\_RES C type, 1758
  - mysql\_rollback(), 1797
  - MYSQL\_ROW C type, 1758
  - mysql\_row\_seek(), 1798
  - mysql\_row\_tell(), 1798
  - mysql\_secure\_installation, 178, 206
  - mysql\_select\_db(), 1798
  - mysql\_server\_end(), 1832
  - mysql\_server\_init(), 1832
  - mysql\_setpermission, 179, 305
    - help option, 305
    - host option, 305
    - password option, 305
    - port option, 305
    - socket option, 305
    - user option, 305
  - mysql\_set\_character\_set(), 1799
  - mysql\_set\_local\_infile\_default(), 1799, 1799
  - mysql\_set\_server\_option(), 1800
  - mysql\_shutdown(), 1801
  - mysql\_sqlstate(), 1801
  - mysql\_ssl\_set(), 1802
  - mysql\_stat(), 1802
  - MYSQL\_STMT C type, 1806
  - mysql\_stmt\_affected\_rows(), 1813
  - mysql\_stmt\_attr\_get(), 1813
  - mysql\_stmt\_attr\_set(), 1814
  - mysql\_stmt\_bind\_param(), 1814
  - mysql\_stmt\_bind\_result(), 1815
  - mysql\_stmt\_close(), 1816
  - mysql\_stmt\_data\_seek(), 1816
  - mysql\_stmt\_errno(), 1816
  - mysql\_stmt\_error(), 1817
  - mysql\_stmt\_execute(), 1817
  - mysql\_stmt\_fetch(), 1820
  - mysql\_stmt\_fetch\_column(), 1823
  - mysql\_stmt\_field\_count(), 1824
  - mysql\_stmt\_free\_result(), 1824
  - mysql\_stmt\_init(), 1824
  - mysql\_stmt\_insert\_id(), 1824
  - mysql\_stmt\_num\_rows(), 1825
  - mysql\_stmt\_param\_count(), 1825
  - mysql\_stmt\_param\_metadata(), 1825
  - mysql\_stmt\_prepare(), 1826
  - mysql\_stmt\_reset(), 1826
  - mysql\_stmt\_result\_metadata, 1827
  - mysql\_stmt\_row\_seek(), 1828
  - mysql\_stmt\_row\_tell(), 1828
  - mysql\_stmt\_send\_long\_data(), 1828
  - mysql\_stmt\_sqlstate(), 1830
  - mysql\_stmt\_store\_result(), 1830
  - mysql\_store\_result(), 1803, 1832
  - MYSQL\_TCP\_PORT environment variable, 147, 181, 510, 511
  - mysql\_thread\_end(), 1831
  - mysql\_thread\_id(), 1804
  - mysql\_thread\_init(), 1831
  - mysql\_thread\_safe(), 1831
  - MYSQL\_TIME C type, 1808
  - mysql\_tzinfo\_to\_sql, 178, 206
  - MYSQL\_UNIX\_PORT environment variable, 105, 147, 181, 510, 511
  - mysql\_upgrade, 178, 207, 483
    - basedir option, 208
    - datadir option, 208
    - debug-check option, 208
    - debug-info option, 208
    - force option, 208
    - help option, 208
    - mysql\_upgrade\_info file, 208
    - tmpdir option, 208
    - user option, 208
    - verbose option, 208
  - mysql\_upgrade\_info file
    - mysql\_upgrade, 208
  - mysql\_use\_result(), 1804
  - mysql\_waitpid, 180, 305
    - help option, 306
    - verbose option, 306
    - version option, 306
  - mysql\_warning\_count(), 1805
  - mysql\_zap, 180, 306
  - my\_bool C type, 1759
  - my\_bool values
    - printing, 1759
  - my\_init(), 1831
  - my\_print\_defaults, 180, 308
    - config-file option, 308
    - debug option, 308
    - defaults-extra-file option, 308
    - defaults-file option, 308
    - defaults-group-suffix option, 308
    - extra-file option, 308
    - help option, 308
    - no-defaults option, 308
-



verbose option, 308  
 version option, 308  
 my\_ulonglong C type, 1759  
 my\_ulonglong values  
   printing, 1759

## N

named pipes, 63, 67  
 named-commands option  
   mysql, 213  
 named\_pipe system variable, 392  
 names, 621  
   case sensitivity, 623  
   variables, 631  
 NAME\_CONST(), 798, 1455  
 name\_file option  
   comp\_err, 203  
 naming  
   releases of MySQL, 35  
 NATIONAL CHAR data type, 686  
 NATIONAL VARCHAR data type, 687  
 native functions  
   adding, 2069  
 native thread support, 34  
 NATURAL LEFT JOIN, 913  
 NATURAL LEFT OUTER JOIN, 913  
 NATURAL RIGHT JOIN, 913  
 NATURAL RIGHT OUTER JOIN, 913  
 NCHAR data type, 686  
 NDB, 2091, 2093  
 ndb option  
   perror, 310  
 NDB storage engine  
   FAQ, 2091  
 NDBCLUSTER, 2091, 2093  
 ndb\_size.pl (utility), 2095  
 negative values, 620  
 nested queries, 922  
 Nested-Loop join algorithm, 549  
 nested-loop join algorithm, 552  
 net etiquette, 11  
 netmask notation  
   in account names, 477  
 NetWare, 78  
 net\_buffer\_length system variable, 392  
 net\_buffer\_length variable, 217  
 net\_read\_timeout system variable, 393  
 net\_retry\_count system variable, 393  
 net\_write\_timeout system variable, 393  
 new procedures  
   adding, 2070  
 new system variable, 394  
 new users  
   adding, 82, 85  
 newline (\n), 619, 905  
 next-key lock  
   InnoDB, 1055, 1074, 1077, 1078  
 NFS  
   InnoDB, 1044, 1102  
 nice option  
   mysqld\_safe, 196  
 no matching rows, 2139  
 no-auto-rehash option  
   mysql, 213  
 no-autocommit option  
   mysqldump, 243  
 no-beep option  
   mysql, 213  
   mysqldadmin, 229  
 no-create-db option  
   mysqldump, 243  
 no-create-info option  
   mysqldump, 243  
 no-data option  
   mysqldump, 243  
 no-debug option  
   make\_win\_bin\_dist, 204  
 no-defaults option, 190  
   mysqld\_multi, 200  
   mysqld\_safe, 197  
   my\_print\_defaults, 308  
 no-embedded option  
   make\_win\_bin\_dist, 204  
 no-log option  
   mysqld\_multi, 201  
 no-named-commands option  
   mysql, 213  
 no-pager option  
   mysql, 214  
 no-set-names option  
   mysqldump, 243  
 no-symlinks option  
   myisamchk, 268  
 no-tee option  
   mysql, 214  
 noindices option  
   mysqlhotcopy, 291  
 non-delimited strings, 693  
 Non-transactional tables, 2139  
 nopager command  
   mysql, 218  
 NOT  
   logical, 722  
 NOT BETWEEN, 720  
 not equal (!=), 718  
 not equal (<>), 718  
 NOT EXISTS  
   with subqueries, 925  
 NOT IN, 721  
 NOT LIKE, 735  
 NOT NULL  
   constraint, 24  
 NOT REGEXP, 735  
 notee command  
   mysql, 218  
 Novell NetWare, 78  
 NOW(), 758  
 nowarning command  
   mysql, 218  
 NO\_AUTO\_CREATE\_USER SQL mode, 444  
 NO\_AUTO\_VALUE\_ON\_ZERO SQL mode, 445  
 NO\_BACKSLASH\_ESCAPES SQL mode, 445  
 NO\_DIR\_IN\_CREATE SQL mode, 445  
 NO\_ENGINE\_SUBSTITUTION SQL mode, 445  
 NO\_FIELD\_OPTIONS SQL mode, 445  
 NO\_KEY\_OPTIONS SQL mode, 445  
 NO\_TABLE\_OPTIONS SQL mode, 445  
 NO\_UNSIGNED\_SUBTRACTION SQL mode, 445  
 NO\_ZERO\_DATE SQL mode, 446  
 NO\_ZERO\_IN\_DATE SQL mode, 446  
 NUL, 618, 905  
 NULL, 162, 2138  
   ORDER BY, 558, 910  
   testing for null, 718, 719, 719, 720, 724  
   thread state, 604  
 NULL value, 162, 621  
 NULL values  
   and AUTO\_INCREMENT columns, 2138  
   and indexes, 868

- and TIMESTAMP columns, 2138
  - vs. empty values, 2138
  - NULLIF(), 724
  - number-char-cols option
    - mysqslap, 259
  - number-int-cols option
    - mysqslap, 259
  - number-of-queries option
    - mysqslap, 259
  - numbers, 620
  - NUMERIC data type, 684
  - numeric types, 705
  - numeric-dump-file option
    - resolve\_stack\_dump, 309
  - NumGeometries(), 823
  - NumInteriorRings(), 822
  - NumPoints(), 821
  - NVARCHAR data type, 687
- O**
- obtaining information about partitions, 1424
  - OCT(), 746
  - OCTET\_LENGTH(), 730
  - ODBC, 1486
  - ODBC compatibility, 623, 684, 716, 719, 866, 915
  - offset option
    - mysqlbinlog, 281
  - OLAP, 803
  - old system variable, 394
  - old-passwords option
    - mysqld, 343, 467
  - old-style-user-limits option
    - mysqld, 343
  - OLD\_PASSWORD(), 790
  - old\_passwords system variable, 394
  - old\_server option
    - mysqlaccess, 277
  - ON DUPLICATE KEY UPDATE, 895
  - one-database option
    - mysql, 214
  - one-thread option
    - mysqld, 344
  - one\_shot system variable, 395
  - online location of manual, 1
  - only-debug option
    - make\_win\_bin\_dist, 204
  - only-print option
    - mysqslap, 259
  - ONLY\_FULL\_GROUP\_BY
    - SQL mode, 805
  - ONLY\_FULL\_GROUP\_BY SQL mode, 446
  - OPEN, 1015
  - Open Source
    - defined, 3
  - open tables, 226, 588
  - open-files-limit option
    - mysqld, 344
    - mysqld\_safe, 197
  - OpenGIS, 806
  - opening
    - tables, 588
  - Opening master dump table
    - thread state, 610
  - Opening mysql.ndb\_apply\_status
    - thread state, 610
  - Opening table
    - thread state, 604
  - Opening tables
    - thread state, 604
  - opens, 226
  - OpenSSL, 497, 497
  - open\_files\_limit system variable, 395
  - open\_files\_limit variable, 283
  - operating systems
    - file-size limits, 2125
    - supported, 34
    - Windows versus Unix, 69
  - operations
    - arithmetic, 741
  - operators, 709
    - assignment, 631
    - cast, 740, 774
    - logical, 721
    - precedence, 716
  - opt option
    - mysqldump, 243
  - optimization
    - subquery, 561
    - tips, 572
  - optimizations, 540, 544
  - optimize option
    - mysqlcheck, 234
  - OPTIMIZE TABLE, 959
    - and partitioning, 1423
  - optimizer
    - and replication, 1386
    - controlling, 595
  - optimizer\_prune\_level system variable, 395
  - optimizer\_search\_depth system variable, 395
  - optimizer\_switch system variable, 396, 565
  - optimizing
    - DISTINCT, 560
    - filesort, 558
    - GROUP BY, 559
    - LEFT JOIN, 548
    - LIMIT, 564
    - tables, 523
  - option files, 186, 483
  - option modifiers, 186
  - options
    - command-line
      - mysql, 209
      - mysqladmin, 227
    - configure, 85
    - embedded server, 1755
    - libmysqld, 1755
    - myisamchk, 265
    - provided by MySQL, 151
    - replication, 1378
  - OR, 172, 544
    - bitwise, 786
    - logical, 722
  - OR Index Merge optimization, 544
  - Oracle compatibility, 17, 803, 933
  - ORACLE SQL mode, 448
  - ORD(), 730
  - ORDER BY, 159, 845, 910
    - NULL, 558, 910
  - order-by-primary option
    - mysqldump, 243
  - OUTFILE, 912
  - out\_dir option
    - comp\_err, 203
  - out\_file option
    - comp\_err, 203
  - Overlaps(), 826
  - overview, 1

- P**
- packages
    - list of, 31
  - PAD\_CHAR\_TO\_FULL\_LENGTH SQL mode, 446
  - pager command
    - mysql, 219
  - pager option
    - mysql, 214
  - parallel-recover option
    - myisamchk, 268
  - parameters
    - server, 591
  - parentheses ( and ), 716
  - PARTITION, 1401
  - partition management, 1418
  - partition pruning, 1426
  - partitioning, 1401
    - advantages, 1403
    - and dates, 1404
    - and foreign keys, 1430
    - and FULLTEXT indexes, 1430
    - and key cache, 1431
    - and server SQL mode, 1429
    - and subqueries, 1431
    - and temporary tables, 1430, 1431
    - by hash, 1409
    - by key, 1411
    - by linear hash, 1410
    - by linear key, 1412
    - by list, 1407
    - by range, 1405
    - concepts, 1402
    - data type of partitioning key, 1431
    - enabling, 1401
    - functions supported in partitioning expressions, 1434
    - limitations, 1428
    - operators disallowed in partitioning expressions, 1429
    - operators supported in partitioning expressions, 1429
    - optimization, 1425, 1426
    - resources, 1402
    - storage engines (limitations), 1434
    - subpartitioning, 1431
    - support, 1401
    - types, 1404
  - Partitioning
    - maximum number of partitions, 1430
  - partitioning information statements, 1424
  - partitioning keys and primary keys, 1431
  - partitioning keys and unique keys, 1431
  - partitions
    - adding and dropping, 1418
    - analyzing, 1423
    - checking, 1423
    - managing, 1418
    - modifying, 1418
    - optimizing, 1423
    - repairing, 1423
    - splitting and merging, 1418
  - PARTITIONS
    - INFORMATION\_SCHEMA table, 1469
  - password
    - root user, 109
  - password encryption
    - reversibility of, 790
  - password option, 183
    - mysql, 214
    - mysqlaccess, 277
    - mysqladmin, 229
    - mysqlbinlog, 281
    - mysqlcheck, 234
    - mysqldump, 243
    - mysqld\_multi, 201
    - mysqlhotcopy, 291
    - mysqlimport, 250
    - mysqlmanager, 294
    - mysqlshow, 254
    - mysqlslap, 259, 260
    - mysql\_convert\_table\_format, 303
    - mysql\_setpermission, 305
  - PASSWORD(), 478, 491, 790, 2127
  - password-file option
    - mysqlmanager, 294
  - passwords
    - administrator guidelines, 492
    - for users, 486
    - forgotten, 2130
    - hashing, 493
    - lost, 2130
    - resetting, 2130
    - security, 469, 492
    - setting, 491, 952, 955
    - user guidelines, 492
  - PATH environment variable, 81, 147, 181
  - pattern matching, 163, 735
  - performance
    - benchmarks, 531
    - disk issues, 615
    - estimating, 540
    - improving, 579, 1390, 1392
  - PERIOD\_ADD(), 759
  - PERIOD\_DIFF(), 759
  - Perl
    - installing, 147
    - installing on Windows, 148
  - Perl API, 2043
  - Perl DBI/DBD
    - installation problems, 149
  - permission checks
    - effect on speed, 532
  - perrow, 180, 309
    - ndb option, 2096
    - help option, 309
    - ndb option, 310
    - silent option, 310
    - verbose option, 310
    - version option, 310
  - phantom rows, 1078
  - PHP API, 1839
  - PI(), 746
  - pid-file option
    - mysql.server, 199
    - mysqld, 344
    - mysqld\_safe, 197
    - mysqlmanager, 294
  - pid\_file system variable, 396
  - Ping
    - thread command, 602
  - pipe option, 183
    - mysql, 214, 234
    - mysqladmin, 229
    - mysqldump, 243
    - mysqlimport, 250
    - mysqlshow, 254
    - mysqlslap, 260
  - PIPES\_AS\_CONCAT SQL mode, 447
  - plan option
    - mysqlaccess, 277
  - plugin API, 2047

- plugin-load option
  - mysqld, 344
- plugindir option
  - mysql\_config, 307
- plugins
  - adding, 2047
  - installing, 963
  - uninstalling, 964
- PLUGINS
  - INFORMATION\_SCHEMA table, 1468
- plugin\_dir system variable, 396
- POINT data type, 813
- point in time recovery, 518
- Point(), 816
- PointFromText(), 814
- PointFromWKB(), 815
- PointN(), 821
- PointOnSurface(), 823
- PolyFromText(), 814
- PolyFromWKB(), 815
- POLYGON data type, 813
- Polygon(), 816
- PolygonFromText(), 814
- PolygonFromWKB(), 815
- port option, 183
  - mysql, 214
  - mysqladmin, 229
  - mysqlbinlog, 281
  - mysqlcheck, 234
  - mysqld, 345
  - mysqldump, 243
  - mysqld\_safe, 197
  - mysqlhotcopy, 291
  - mysqlexport, 251
  - mysqlmanager, 294
  - mysqlshow, 254
  - mysqslap, 260
  - mysql\_config, 307
  - mysql\_convert\_table\_format, 303
  - mysql\_setpermission, 305
- port system variable, 397
- port-open-timeout option
  - mysqld, 345
- portability, 529
  - types, 707
- porting
  - to other systems, 2071
- position option
  - mysqlbinlog, 281
- POSITION(), 730
- post-install
  - multiple servers, 506
- post-installation
  - setup and testing, 100
- post-query option
  - mysqslap, 260
- post-system option
  - mysqslap, 260
- PostgreSQL compatibility, 18
- POSTGRES SQL mode, 448
- POW(), 746
- POWER(), 746
- pre-query option
  - mysqslap, 260
- pre-system option
  - mysqslap, 260
- precedence
  - operator, 716
- precision
  - arithmetic, 829
  - precision math, 829
- prefix option
  - configure, 89
- preload\_buffer\_size system variable, 397
- Prepare
  - thread command, 602
- PREPARE, 1007, 1009
  - XA transactions, 945
- prepared statements, 1007, 1009, 1010, 1010, 1805
  - repreparation, 1010
- prepared\_stmt\_count system variable, 397
- preparing
  - thread state, 605
- preserve-schema option
  - mysqslap, 260
- preview option
  - mysqlaccess, 277
- primary key
  - constraint, 23
  - deleting, 845
- PRIMARY KEY, 845, 868
- primary keys
  - and partitioning keys, 1431
- print command
  - mysql, 219
- print-defaults option, 190
  - mysqlmanager, 294
- print-password-line option
  - mysqlmanager, 294
- privilege
  - changes, 481
- privilege information
  - location, 473
- privilege system, 469
- privileges
  - access, 469
  - adding, 487
  - and replication, 1386
  - default, 109
  - deleting, 489, 948
  - display, 979
  - dropping, 489, 948
  - granting, 948
  - revoking, 955
- problems
  - access denied errors, 2118
  - common errors, 2117
  - compiling, 94
  - DATE columns, 2137
  - date values, 693
  - installing on IBM-AIX, 136
  - installing on Solaris, 129
  - installing Perl, 149
  - linking, 2129
  - lost connection errors, 2120
  - ODBC, 1564
  - reporting, 12
  - starting the server, 107
  - table locking, 577
  - time zone, 2135
- PROCEDURE, 911
- procedures
  - adding, 2070
  - stored, 21, 1437
- process support, 34
- processes
  - display, 982
- processing
  - arguments, 2065
- Processing events

- thread state, 610
- Processing events from schema table
  - thread state, 610
- Processlist
  - thread command, 602
- PROCESLIST, 982
  - INFORMATION\_SCHEMA table, 1478
- PROFILING
  - INFORMATION\_SCHEMA table, 1480
- profiling session variable, 417
- profiling\_history\_size session variable, 417
- program variables
  - setting, 190
- program-development utilities, 180
- programs
  - administrative, 178
  - client, 178, 1838
  - crash-me, 529
  - stored, 1010, 1436
  - utility, 178
- prompt command
  - mysql, 219
- prompt option
  - mysql, 214
- prompts
  - meanings, 153
- pronunciation
  - MySQL, 4
- protocol option, 183
  - mysql, 214
  - mysqladmin, 229
  - mysqlbinlog, 281
  - mysqlcheck, 234
  - mysqldump, 243
  - mysqlimport, 251
  - mysqlshow, 254
  - mysqlslap, 260
- protocol\_version system variable, 397
- PURGE BINARY LOGS, 1001
- PURGE MASTER LOGS, 1001
- Purging old relay logs
  - thread state, 605
- Python API, 2044

**Q**

- QUARTER(), 759
- queries
  - entering, 152
  - estimating performance, 540
  - examples, 169
  - speed of, 532
  - Twin Studies project, 174
- Query
  - thread command, 602
- Query Cache, 595
- query end
  - thread state, 605
- query option
  - mysqlslap, 260
- query\_alloc\_block\_size system variable, 397
- query\_cache\_limit system variable, 398
- query\_cache\_min\_res\_unit system variable, 398
- query\_cache\_size system variable, 398
- query\_cache\_type system variable, 399
- query\_cache\_wlock\_invalidate system variable, 399
- query\_prealloc\_size system variable, 400
- questions, 226
  - answering, 11
- Queueing master event to the relay log

- thread state, 608
- quick option
  - myisamchk, 268
  - mysql, 214
  - mysqlcheck, 234
  - mysqldump, 244
- quiet option
  - mysqlhotcopy, 291
- Quit
  - thread command, 602
- quit command
  - mysql, 219
- QUOTE(), 730
- quote-names option
  - mysqldump, 244
- quotes
  - in strings, 619
- quoting, 619
- quoting binary data, 619
- quoting of identifiers, 621

**R**

- RADIANS(), 746
- RAND(), 747
- rand\_seed1 session variable, 417
- rand\_seed2 session variable, 417
- range join type
  - optimizer, 535
- range partitioning, 1405
- range partitions
  - adding and dropping, 1419
  - managing, 1419
- range\_alloc\_block\_size system variable, 400
- raw option
  - mysql, 214
- re-creating
  - grant tables, 105
- READ COMMITTED
  - transaction isolation level, 944
- READ UNCOMMITTED
  - transaction isolation level, 944
- read-from-remote-server option
  - mysqlbinlog, 281
- read-only option
  - myisamchk, 267
  - mysqld, 1351
- Reading event from the relay log
  - thread state, 609
- Reading from net
  - thread state, 605
- Reading master dump table data
  - thread state, 610
- read\_buffer\_size myisamchk variable, 266
- read\_buffer\_size system variable, 400
- read\_only system variable, 401
- read\_rnd\_buffer\_size system variable, 401
- REAL data type, 684
- REAL\_AS\_FLOAT SQL mode, 447
- Rebuilding the index on master dump table
  - thread state, 610
- reconfiguring, 94, 94
- reconnect option
  - mysql, 215
- Reconnecting after a failed binlog dump request
  - thread state, 608
- Reconnecting after a failed master event read
  - thread state, 609
- record-level locks
  - InnoDB, 1055, 1074, 1077, 1078

- record\_log\_pos option
  - mysqlhotcopy, 291
- RECOVER
  - XA transactions, 945
- recover option
  - myisamchk, 268
- recovery
  - from crash, 520
  - point in time, 518
- reducing
  - data size, 579
- ref join type
  - optimizer, 534
- references, 845
- REFERENTIAL\_CONSTRAINTS
  - INFORMATION\_SCHEMA table, 1479
- Refresh
  - thread command, 602
- ref\_or\_null, 548
- ref\_or\_null join type
  - optimizer, 534
- REGEXP, 736
- REGEXP operator, 735
- regexp option
  - mysqlhotcopy, 291
  - mysql\_find\_rows, 304
- Register Slave
  - thread command, 602
- Registering slave on master
  - thread state, 608
- regular expression syntax, 735
- rehash command
  - mysql, 219
- Related(), 826
- relational databases
  - defined, 3
- relative option
  - mysqladmin, 229
- relay-log option
  - mysqld, 1351
- relay-log-index option
  - mysqld, 1351
- relay-log-info-file option
  - mysqld, 1352
- relay-log-purge option
  - mysqld, 1352
- relay-log-space-limit option
  - mysqld, 1352
- relay\_log\_purge system variable, 402
- relay\_log\_space\_limit system variable, 402
- release numbers, 35
- RELEASE SAVEPOINT, 938
- releases
  - naming scheme, 35
  - testing, 36
  - updating, 37
- RELEASE\_LOCK(), 799
- relnotes option
  - mysqlaccess, 277
- remove option
  - mysqlmanager, 295
- Removing duplicates
  - thread state, 605
- removing tmp table
  - thread state, 605
- rename
  - thread state, 605
- RENAME DATABASE, 888
- rename result table
  - thread state, 605
- RENAME TABLE, 889
- RENAME USER, 954
- renaming user accounts, 954
- Reopen tables
  - thread state, 605
- reordering
  - columns, 2142
- repair
  - tables, 230
- Repair by sorting
  - thread state, 605
- Repair done
  - thread state, 605
- repair option
  - mysqlcheck, 234
- repair options
  - myisamchk, 268
- REPAIR TABLE, 960
  - and partitioning, 1423
- Repair with keycache
  - thread state, 605
- repairing
  - tables, 521
- REPEAT, 1018
- REPEAT(), 730
- REPEATABLE READ
  - transaction isolation level, 944
- replace, 180
- REPLACE, 907
- replace option
  - mysqldump, 244
  - mysqlimport, 251
- replace utility, 310
- REPLACE(), 730
- replicate-do-db option
  - mysqld, 1352
- replicate-do-table option
  - mysqld, 1353
- replicate-ignore-db option
  - mysqld, 1353
- replicate-ignore-table option
  - mysqld, 1353
- replicate-rewrite-db option
  - mysqld, 1354
- replicate-same-server-id option
  - mysqld, 1354
- replicate-wild-do-table option
  - mysqld, 1354
- replicate-wild-ignore-table option
  - mysqld, 1354
- replication, 1330
  - and AUTO\_INCREMENT, 1378
  - and character sets, 1379
  - and CREATE TABLE ... SELECT, 1379
  - and DATA DIRECTORY, 1382
  - and DROP ... IF EXISTS, 1382
  - and errors on slave, 1387
  - and floating-point values, 1384
  - and FLUSH, 1384
  - and functions, 1384
  - and INDEX DIRECTORY, 1382
  - and invoked features, 1382
  - and LAST\_INSERT\_ID(), 1378
  - and LIMIT, 1385
  - and LOAD DATA, 1385
  - and MEMORY tables, 1386
  - and mysql (system) database, 1386
  - and partial updates, 1388
  - and privileges, 1386
  - and query optimizer, 1386

- and reserved words, 1386
- and scheduled events, 1382
- and slow query log, 1386
- and stored routines, 1382
- and temporary tables, 1387
- and time zones, 1387
- and TIMESTAMP, 1378
- and transactions, 1387, 1388
- and triggers, 1382, 1388
- and TRUNCATE, 1389
- and variables, 1389
- and views, 1389
- attribute promotion, 1381
- crashes, 1386
- row-based vs statement-based, 1339
- shutdown and restart, 1386, 1387, 1387
- statements incompatible with STATEMENT mode, 1340
- timeouts, 1387
- with differing tables on master and slave, 1380
- replication formats
  - compared, 1339
- replication implementation, 1395
- replication limitations, 1378
- replication master
  - thread states, 608
- replication masters, 1386
  - statements, 1001
- replication options, 1378
- replication slave
  - thread states, 608, 609, 609
- replication slaves
  - statements, 1002
- report-host option
  - mysqld, 1354
- report-password option
  - mysqld, 1355
- report-port option
  - mysqld, 1355
- report-user option
  - mysqld, 1355
- reporting
  - bugs, 12
  - Connector/NET problems, 1630
  - Connector/ODBC problems, 1564, 1564
  - errors, 1, 12
- report\_host system variable, 402
- report\_password system variable, 402
- report\_port system variable, 403
- report\_user system variable, 403
- Requesting binlog dump
  - thread state, 608
- REQUIRE GRANT option, 953
- reschedule
  - thread state, 607
- reserved words, 628
  - and replication, 1386
- RESET MASTER, 1002
- RESET SLAVE, 1006
- Reset stmt
  - thread command, 602
- resetmaster option
  - mysqldhotcopy, 291
- resetslave option
  - mysqldhotcopy, 291
- resolveip, 180, 310
  - help option, 311
  - silent option, 311
  - version option, 311
- resolve\_stack\_dump, 180, 309
  - help option, 309
- numeric-dump-file option, 309
- symbols-file option, 309
- version option, 309
- restarting
  - the server, 103
- RESTORE TABLE, 961
- restrictions
  - events, 2514
  - server-side cursors, 2517
  - stored routines, 2514
  - subqueries, 2517
  - triggers, 2514
  - views, 2519
- result-file option
  - mysqlbinlog, 282
  - mysqldump, 244
- retrieving
  - data from tables, 157
- RETURN, 1018
- return (\r), 619, 905
- return values
  - UDFs, 2066
- REVERSE(), 731
- REVOKE, 955
- revoking
  - privileges, 955
- rhost option
  - mysqlaccess, 278
- RIGHT JOIN, 913
- RIGHT OUTER JOIN, 913
- RIGHT(), 731
- RLIKE, 736
- ROLLBACK, 19, 936
  - XA transactions, 945
- rollback option
  - mysqlaccess, 278
- ROLLBACK TO SAVEPOINT, 938
- Rolling back
  - thread state, 605
- ROLLUP, 803
- root password, 109
- root user
  - password resetting, 2130
- ROUND(), 748
- rounding, 829
- rounding errors, 683
- ROUTINES
  - INFORMATION\_SCHEMA table, 1465
- routines option
  - mysqldump, 244
- ROW, 925
- row subqueries, 925
- row-based replication
  - advantages, 1341
  - disadvantages, 1341
- row-level locking, 575
- rows
  - counting, 164
  - deleting, 2139
  - locking, 21
  - matching problems, 2139
  - selecting, 158
  - sorting, 159
- rows option
  - mysql\_find\_rows, 304
- ROW\_COUNT(), 796
- RPAD(), 731
- RPM file, 71
- rpm option
  - mysql\_install\_db, 206

- RPM Package Manager, 71
  - RTRIM(), 731
  - RTS-threads, 2078
  - Ruby API, 2044
  - run-as-service option
    - mysqlmanager, 295
  - running
    - ANSI mode, 16
    - batch mode, 168
    - multiple servers, 506
    - queries, 152
  - running configure after prior invocation, 94
- S**
- safe-mode option
    - mysqld, 345
  - safe-recover option
    - myisamchk, 269
  - safe-show-database option
    - mysqld, 346, 467
  - safe-updates option, 223
    - mysql, 215
  - safe-user-create option
    - mysqld, 346, 467
  - Sakila, 4
  - SAVEPOINT, 938
  - Saving state
    - thread state, 605
  - scale
    - arithmetic, 829
  - schema
    - altering, 836
    - creating, 852
    - deleting, 885
  - SCHEMA(), 796
  - SCHEMATA
    - INFORMATION\_SCHEMA table, 1458
  - SCHEMA\_PRIVILEGES
    - INFORMATION\_SCHEMA table, 1461
  - script files, 168
  - scripts, 194, 199
    - mysqlbug, 15
    - mysql\_install\_db, 104
    - SQL, 209
  - searching
    - and case sensitivity, 2136
    - full-text, 765
    - MySQL Web pages, 12
    - two keys, 172
  - Searching rows for update
    - thread state, 605
  - SECOND(), 759
  - secondary index
    - InnoDB, 1083
  - secure-auth option
    - mysql, 215
    - mysqld, 346, 467
  - secure-file-priv option
    - mysqld, 346, 467
  - secure\_auth system variable, 403
  - secure\_file\_priv system variable, 403
  - security
    - against attackers, 465
    - security system, 469
  - SEC\_TO\_TIME(), 759
  - SELECT
    - LIMIT, 908
    - optimizing, 532, 933
    - Query Cache, 595
    - SELECT INTO, 1012
    - SELECT INTO TABLE, 19
    - SELECT speed, 540
    - selecting
      - databases, 155
    - select\_limit variable, 217
    - semi-consistent read
      - InnoDB, 1055
    - Sending binlog event to slave
      - thread state, 608
    - SEQUENCE, 173
    - sequence emulation, 795
    - sequences, 173
    - SERIAL, 682, 683
    - SERIAL DEFAULT VALUE, 689
    - SERIALIZABLE
      - transaction isolation level, 944
    - server
      - connecting, 151, 181
      - debugging, 2072
      - disconnecting, 151
      - logs, 450
      - restart, 103
      - shutdown, 103
      - signal handling, 448
      - starting, 102
      - starting and stopping, 106
      - starting problems, 107
    - server administration, 224
    - server variables, 352, 994
    - server-id option
      - mysqlbinlog, 282
      - mysqld, 1343
    - server-side cursor restrictions, 2517
    - servers
      - multiple, 506
    - server\_id system variable, 403
    - service-startup-timeout option
      - mysql.server, 199
    - session server variables, 415
    - session system variables, 415
    - session variable
      - autocommit, 416
      - big\_tables, 416
      - error\_count, 416
      - foreign\_key\_checks, 416
      - identity, 417
      - insert\_id, 417
      - last\_insert\_id, 417
      - profiling, 417
      - profiling\_history\_size, 417
      - rand\_seed1, 417
      - rand\_seed2, 417
      - sql\_auto\_is\_null, 417
      - sql\_big\_selects, 417
      - sql\_buffer\_result, 417
      - sql\_log\_bin, 418
      - sql\_log\_off, 418
      - sql\_log\_update, 418
      - sql\_notes, 418
      - sql\_quote\_show\_create, 418
      - sql\_safe\_updates, 418
      - sql\_warnings, 418
      - timestamp, 418
      - unique\_checks, 418
      - warning\_count, 418
    - session variables
      - and replication, 1389
      - server, 415
      - system, 415



- SESSION\_STATUS
  - INFORMATION\_SCHEMA table, 1480
- SESSION\_USER(), 796
- SESSION\_VARIABLES
  - INFORMATION\_SCHEMA table, 1480
- SET, 964, 1011
  - CHARACTER SET, 642, 966
  - NAMES, 642, 644, 966
  - ONE\_SHOT, 966
  - size, 707
- SET data type, 688, 702
- SET GLOBAL SQL\_SLAVE\_SKIP\_COUNTER, 1006
- Set option
  - thread command, 602
- SET OPTION, 964
- SET PASSWORD, 955
- SET PASSWORD statement, 491
- SET sql\_log\_bin, 1002
- SET TRANSACTION, 943
- set-auto-increment[ option
  - myisamchk, 269
- set-character-set option
  - myisamchk, 269
- set-charset option
  - mysqlbinlog, 282
  - mysqldump, 244
- set-collation option
  - myisamchk, 269
- setting
  - passwords, 491
- setting passwords, 955
- setting program variables, 190
- setup
  - post-installation, 100
  - thread state, 606
- SHA(), 790
- SHA1(), 790
- shared-memory option
  - mysqld, 347
- shared-memory-base-name option, 183
  - mysqld, 347
  - mysqlslap, 260
- shared\_memory system variable, 404
- shared\_memory\_base\_name system variable, 404
- shell syntax, 3, 1216
- short-form option
  - mysqlbinlog, 282
- SHOW AUTHORS, 966, 967
- SHOW BINARY LOGS, 967
- SHOW BINLOG EVENTS, 967, 968
- SHOW CHARACTER SET, 966, 968
- SHOW COLLATION, 966, 968
- SHOW COLUMNS, 966, 969
- SHOW CONTRIBUTORS, 966, 970
- SHOW CREATE DATABASE, 966, 970
- SHOW CREATE EVENT, 966
- SHOW CREATE FUNCTION, 966, 971
- SHOW CREATE PROCEDURE, 966, 971
- SHOW CREATE SCHEMA, 966, 970
- SHOW CREATE TABLE, 966, 971
- SHOW CREATE TRIGGER, 966, 972
- SHOW CREATE VIEW, 966, 972
- SHOW DATABASES, 966, 972
- SHOW ENGINE, 966, 973
- SHOW ENGINE INNODB STATUS, 973
- SHOW ENGINE NDB STATUS, 973
- SHOW ENGINE NDBCLUSTER STATUS, 973
- SHOW ENGINES, 966, 975
- SHOW ERRORS, 966, 976
  - and MySQL Cluster, 2096
- SHOW EVENTS, 966, 977
- SHOW extensions, 1481
- SHOW FIELDS, 966, 970
- SHOW FUNCTION CODE, 966, 978
- SHOW FUNCTION STATUS, 966, 978
- SHOW GRANTS, 966, 979
- SHOW INDEX, 966, 979
- SHOW INNODB STATUS, 966
- SHOW KEYS, 966, 979
- SHOW MASTER LOGS, 967, 967
- SHOW MASTER STATUS, 967, 980
- SHOW OPEN TABLES, 966, 980
- SHOW PLUGINS, 966, 981
- SHOW PRIVILEGES, 966, 981
- SHOW PROCEDURE CODE, 966, 981
- SHOW PROCEDURE STATUS, 966, 982
- SHOW PROCESSLIST, 966, 982
- SHOW PROFILE, 966, 984, 984
- SHOW PROFILES, 966, 984
- SHOW SCHEDULER STATUS, 966, 1445
- SHOW SCHEMAS, 966, 972
- SHOW SLAVE HOSTS, 967, 986
- SHOW SLAVE STATUS, 967, 987
- SHOW STATUS, 966
- SHOW STORAGE ENGINES, 975
- SHOW TABLE STATUS, 966
- SHOW TABLE TYPES, 966, 975
- SHOW TABLES, 966, 993
- SHOW TRIGGERS, 966, 993
- SHOW VARIABLES, 966
- SHOW WARNINGS, 966, 995
  - and MySQL Cluster, 2096
- SHOW with WHERE, 1457, 1481
- show-slave-auth-info option
  - mysqld, 1355
- show-table-type option
  - mysqlshow, 254
- show-warnings option
  - mysql, 215
- showing
  - database information, 252
- Shutdown
  - thread command, 602
- shutdown\_timeout variable, 230
- shutting down
  - the server, 103
- Shutting down
  - thread state, 610
- sigint-ignore option
  - mysql, 215
- SIGN(), 748
- signals
  - server response, 448
- silent column changes, 877
- silent option
  - myisamchk, 266
  - myisampack, 272
  - mysql, 215
  - mysqladmin, 229
  - mysqlcheck, 234
  - mysqld\_multi, 201
  - mysqlimport, 251
  - mysqlslap, 260
  - perorr, 310
  - resolveip, 311
- SIN(), 748
- single quote (\'), 618
- single-transaction option
  - mysqldump, 244
- size of tables, 2125

- sizes
  - display, 682
- skip-column-names option
  - mysql, 215
- skip-comments option
  - mysqldump, 244
- skip-concurrent-insert option
  - mysqld, 347
- skip-external-locking option
  - mysqld, 347
- skip-grant-tables option
  - mysqld, 347, 467
- skip-host-cache option
  - mysqld, 347
- skip-innodb option
  - mysqld, 347
- skip-kill-mysqld option
  - mysqld\_safe, 197
- skip-line-numbers option
  - mysql, 215
- skip-merge option
  - mysqld, 468
- skip-name-resolve option
  - mysqld, 347, 468
  - mysql\_install\_db, 206
- skip-networking option
  - mysqld, 347, 468
- skip-opt option
  - mysqldump, 245
- skip-safemalloc option
  - mysqld, 348
- skip-show-database option
  - mysqld, 348, 468
- skip-slave-start option
  - mysqld, 1355
- skip-stack-trace option
  - mysqld, 348
- skip-symbolic-links option
  - mysqld, 348
- skip-syslog option
  - mysqld\_safe, 197
- skip-thread-priority option
  - mysqld, 348
- skip-use-db option
  - mysql\_find\_rows, 304
- skip\_external\_locking system variable, 404
- skip\_networking system variable, 404
- skip\_show\_database system variable, 404
- slave option
  - mysqld, 260
- slave-load-tmpdir option
  - mysqld, 1355
- slave-net-timeout option
  - mysqld, 1355
- slave-skip-errors option
  - mysqld, 1355
- slave\_compressed\_protocol option
  - mysqld, 1355
- slave\_compressed\_protocol system variable, 1357
- slave\_exec\_mode system variable, 1357
- slave\_load\_tmpdir system variable, 1357
- slave\_net\_timeout system variable, 1358
- slave\_skip\_errors system variable, 1358
- slave\_transaction\_retries system variable, 1358
- Sleep
  - thread command, 602
- sleep option
  - mysqldadmin, 229
- SLEEP(), 799
- slow queries, 226
- slow query log, 461
  - and replication, 1386
- slow-query-log option
  - mysqld, 349
- slow\_launch\_time system variable, 404
- slow\_query\_log system variable, 404
- slow\_query\_log\_file system variable, 405
- SMALLINT data type, 683
- socket location
  - changing, 89
- socket option, 183
  - mysql, 215
  - mysqldadmin, 229
  - mysqlbinlog, 282
  - mysqlcheck, 234
  - mysqld, 349
  - mysqldump, 245
  - mysqld\_safe, 197
  - mysqlhotcopy, 291
  - mysqlimport, 251
  - mysqlmanager, 295
  - mysqlshow, 254
  - mysqld, 260
  - mysql\_config, 307
  - mysql\_convert\_table\_format, 304
  - mysql\_setpermission, 305
- socket system variable, 405
- Solaris
  - installation, 75
  - Solaris installation problems, 129
  - Solaris troubleshooting, 95
  - Solaris x86\_64 issues, 1091
- SOME, 924
- sort-index option
  - myisamchk, 269
- sort-records option
  - myisamchk, 269
- sort-recover option
  - myisamchk, 269
- sorting
  - character sets, 666
  - data, 159
  - grant tables, 479, 480
  - table rows, 159
- Sorting for group
  - thread state, 606
- Sorting for order
  - thread state, 606
- Sorting index
  - thread state, 606
- Sorting result
  - thread state, 606
- sort\_buffer\_size myisamchk variable, 266
- sort\_buffer\_size system variable, 405
- sort\_key\_blocks myisamchk variable, 266
- SOUNDEX(), 731
- SOUNDS LIKE, 732
- source (mysql client command), 169, 222
- source command
  - mysql, 219
- source distribution
  - installing, 82
- source distributions
  - on Linux, 124
- SPACE(), 732
- spassword option
  - mysqlaccess, 278
- Spatial Extensions in MySQL, 806
- speed
  - compiling, 589

- increasing with replication, 1330
- inserting, 571
- linking, 589
- of queries, 532, 540
- sporadic-binlog-dump-fail option
  - mysqld, 1362
- SQL
  - defined, 3
- SQL mode, 443
  - ALLOW\_INVALID\_DATES, 444
  - ANSI, 443, 447
  - ANSI\_QUOTES, 444
  - DB2, 448
  - ERROR\_FOR\_DIVISION\_BY\_ZERO, 444
  - HIGH\_NOT\_PRECEDENCE, 444
  - IGNORE\_SPACE, 444
  - MAXDB, 448
  - MSSQL, 448
  - MYSQL323, 448
  - MYSQL40, 448
  - NO\_AUTO\_CREATE\_USER, 444
  - NO\_AUTO\_VALUE\_ON\_ZERO, 445
  - NO\_BACKSLASH\_ESCAPES, 445
  - NO\_DIR\_IN\_CREATE, 445
  - NO\_ENGINE\_SUBSTITUTION, 445
  - NO\_FIELD\_OPTIONS, 445
  - NO\_KEY\_OPTIONS, 445
  - NO\_TABLE\_OPTIONS, 445
  - NO\_UNSIGNED\_SUBTRACTION, 445
  - NO\_ZERO\_DATE, 446
  - NO\_ZERO\_IN\_DATE, 446
  - ONLY\_FULL\_GROUP\_BY, 446, 805
  - ORACLE, 448
  - PAD\_CHAR\_TO\_FULL\_LENGTH, 446
  - PIPES\_AS\_CONCAT, 447
  - POSTGRESQL, 448
  - REAL\_AS\_FLOAT, 447
  - strict, 444
  - STRICT\_ALL\_TABLES, 447
  - STRICT\_TRANS\_TABLES, 443, 447
  - TRADITIONAL, 443, 448
- SQL scripts, 209
- SQL statements
  - replication masters, 1001
  - replication slaves, 1002
- SQL-92
  - extensions to, 15
- sql-mode option
  - mysqld, 349
- sql\_auto\_is\_null session variable, 417
- SQL\_BIG\_RESULT, 913
- sql\_big\_selects session variable, 417
- SQL\_BUFFER\_RESULT, 913
- sql\_buffer\_result session variable, 417
- SQL\_CACHE, 597, 913
- SQL\_CALC\_FOUND\_ROWS, 913
- sql\_log\_bin session variable, 418
- sql\_log\_off session variable, 418
- sql\_log\_update session variable, 418
- sql\_mode system variable, 406
- sql\_notes session variable, 418
- SQL\_NO\_CACHE, 597, 913
- sql\_quote\_show\_create session variable, 418
- sql\_safe\_updates session variable, 418
- sql\_select\_limit system variable, 406
- SQL\_SLAVE\_SKIP\_COUNTER, 1006
- sql\_slave\_skip\_counter system variable, 1356, 1358
- SQL\_SMALL\_RESULT, 913
- sql\_warnings session variable, 418
- sql\_yacc.cc problems, 94
- SQRT(), 748
- square brackets, 682
- srcdir option
  - mysql\_install\_db, 206
- SRID(), 819
- SSH, 504
- SSL, 497
- SSL and X509 Basics, 497
- SSL command options, 499
- ssl option, 500
- SSL options, 184
  - mysql, 215
  - mysqladmin, 229
  - mysqlcheck, 234
  - mysqld, 347, 468
  - mysqldump, 245
  - mysqlimport, 251
  - mysqlshow, 254
  - mysqslap, 260
- SSL related options, 953
- ssl-ca option, 500
- ssl-capath option, 500
- ssl-cert option, 500
- ssl-cipher option, 500
- ssl-key option, 500
- ssl-verify-server-cert option, 500
- ssl\_ca system variable, 406
- ssl\_capath system variable, 407
- ssl\_cert system variable, 407
- ssl\_cipher system variable, 407
- ssl\_key system variable, 407
- standalone option
  - mysqld, 347
  - mysqlmanager, 295
- Standard Monitor
  - InnoDB, 1093
- Standard SQL
  - differences from, 19, 954
  - extensions to, 15, 16
- standards compatibility, 15
- START
  - XA transactions, 945
- START SLAVE, 1006
- START TRANSACTION, 936
- start-datetime option
  - mysqlbinlog, 282
- start-position option
  - mysqlbinlog, 282
- starting
  - comments, 22
  - mysqld, 469
  - the server, 102
  - the server automatically, 106
- Starting many servers, 506
- starting slave
  - thread state, 610
- StartPoint(), 821
- startup options
  - default, 186
- startup parameters, 591
  - mysql, 209
  - mysqladmin, 227
  - tuning, 590
- start\_row option
  - mysql\_find\_rows, 304
- statefile option
  - comp\_err, 203
- statement-based replication
  - advantages, 1340
  - disadvantages, 1340

- unsafe statements, 1340
- statements
  - compound, 1010
  - GRANT, 487
  - INSERT, 488
  - replication masters, 1001
  - replication slaves, 1002
- statically
  - compiling, 89
- Statistics
  - thread command, 602
- statistics
  - thread state, 606
- STATISTICS
  - INFORMATION\_SCHEMA table, 1460
- stats option
  - myisam\_ftdump, 262
- stats\_method myisamchk variable, 266
- status
  - tables, 991
- status command
  - mysql, 219
  - results, 226
- status option
  - mysqlshow, 254
- status variables, 427, 990
- STD(), 802
- STDDEV(), 803
- STDDEV\_POP(), 803
- STDDEV\_SAMP(), 803
- STOP SLAVE, 1007
- stop-datetime option
  - mysqlbinlog, 282
- stop-position option
  - mysqlbinlog, 282
- stopping
  - the server, 106
- stopword list
  - user-defined, 773
- storage engine
  - ARCHIVE, 1115
- storage engines
  - choosing, 1019
- storage requirements
  - data type, 704
- storage space
  - minimizing, 579
- storage\_engine system variable, 408
- stored functions, 1437
  - and INSERT DELAYED, 897
- stored procedures, 1437
- stored procedures and triggers
  - defined, 21
- stored programs, 1010, 1436
- stored routine restrictions, 2514
- stored routines
  - and replication, 1382
  - LAST\_INSERT\_ID(), 1439
  - metadata, 1438
- storing row into queue
  - thread state, 607
- STRAIGHT\_JOIN, 532, 539, 549, 549, 913, 913
- STRCMP(), 735
- strict SQL mode, 444
- STRICT\_ALL\_TABLES SQL mode, 447
- STRICT\_TRANS\_TABLES SQL mode, 443, 447
- string collating, 669
- string comparison functions, 733
- string comparisons
  - case sensitivity, 733
  - string concatenation, 618, 727
  - string functions, 724
  - string literal introducer, 618, 640
  - string replacement
    - replace utility, 310
  - string types, 698
  - strings
    - defined, 618
    - escaping characters, 618
    - non-delimited, 693
  - striping
    - defined, 615
  - STR\_TO\_DATE(), 759
  - SUBDATE(), 760
  - subpartitioning, 1412
  - subpartitions, 1412
  - subqueries, 922
    - correlated, 926
    - errors, 928
    - rewriting as joins, 930
    - with ALL, 924
    - with ANY, IN, SOME, 924
    - with EXISTS, 925
    - with NOT EXISTS, 925
    - with ROW, 925
  - subquery, 922
  - subquery optimization, 561
  - subquery restrictions, 2517
  - subselects, 922
  - SUBSTR(), 732
  - SUBSTRING(), 732
  - SUBSTRING\_INDEX(), 732
  - SUBTIME(), 760
  - subtraction (-), 741
  - suffix option
    - mysqlhotcopy, 291
  - SUM(), 803
  - SUM(DISTINCT), 803
  - superuser, 109
  - superuser option
    - mysqlaccess, 278
  - support
    - for operating systems, 34
  - suppression
    - default values, 24
  - Sybase compatibility, 936
  - symbolic links, 615, 617
  - symbolic-links option
    - mysqld, 348
  - symbols-file option
    - resolve\_stack\_dump, 309
  - SymDifference(), 824
  - Syncing ndb table schema operation and binlog
    - thread state, 610
  - sync\_binlog system variable, 1365
  - sync\_frm system variable, 408
  - syntax
    - regular expression, 735
  - syntax conventions, 2
  - SYSDATE(), 760
  - sysdate-is-now option
    - mysqld, 350
  - syslog option
    - mysqld\_safe, 197
  - syslog-tag option
    - mysqld\_safe, 197
  - system
    - privilege, 469
    - security, 463
  - system command

- mysql, 219
- System lock
  - thread state, 606
- system optimization, 590
- system table
  - optimizer, 533, 913
- system variable
  - automatic\_sp\_privileges, 360
  - auto\_increment\_increment, 1345
  - auto\_increment\_offset, 1348
  - back\_log, 360
  - basedir, 360
  - binlog\_cache\_size, 1362
  - binlog\_format, 1363
  - bulk\_insert\_buffer\_size, 361
  - character\_sets\_dir, 363
  - character\_set\_client, 361
  - character\_set\_connection, 361
  - character\_set\_database, 362
  - character\_set\_filesystem, 362
  - character\_set\_results, 362
  - character\_set\_server, 362
  - character\_set\_system, 363
  - collation\_connection, 363
  - collation\_database, 363
  - collation\_server, 363
  - completion\_type, 364
  - concurrent\_insert, 364
  - connect\_timeout, 365
  - datadir, 365
  - datetime\_format, 365
  - date\_format, 365
  - debug, 365
  - default\_week\_format, 366
  - delayed\_insert\_limit, 367
  - delayed\_insert\_timeout, 367
  - delayed\_queue\_size, 367
  - delay\_key\_write, 366
  - div\_precision\_increment, 368
  - engine\_condition\_pushdown, 368
  - event\_scheduler, 369
  - expire\_logs\_days, 369
  - flush, 369
  - flush\_time, 370
  - ft\_boolean\_syntax, 370
  - ft\_max\_word\_len, 370
  - ft\_min\_word\_len, 371
  - ft\_query\_expansion\_limit, 371
  - ft\_stopword\_file, 371
  - general\_log, 372
  - general\_log\_file, 372
  - group\_concat\_max\_len, 372
  - have\_archive, 373
  - have\_blackhole\_engine, 373
  - have\_compress, 373
  - have\_crypt, 373
  - have\_csv, 373
  - have\_dynamic\_loading, 373
  - have\_example\_engine, 373
  - have\_federated\_engine, 373
  - have\_geometry, 373
  - have\_innodb, 373
  - have\_isam, 373
  - have\_merge\_engine, 373
  - have\_openssl, 373
  - have\_partitioning, 373
  - have\_query\_cache, 373
  - have\_raid, 374
  - have\_row\_based\_replication, 374
  - have\_rtree\_keys, 374
  - have\_ssl, 374
  - have\_symlink, 374
  - hostname, 374
  - init\_connect, 374
  - init\_file, 375
  - init\_slave, 1356
  - interactive\_timeout, 375
  - join\_buffer\_size, 375
  - keep\_files\_on\_create, 376
  - key\_buffer\_size, 376
  - key\_cache\_age\_threshold, 377
  - key\_cache\_block\_size, 377
  - key\_cache\_division\_limit, 378
  - language, 378
  - large\_files\_support, 378
  - large\_pages, 378
  - large\_page\_size, 379
  - lc\_time\_names, 379
  - license, 379
  - local\_infile, 379
  - locked\_in\_memory, 379
  - log, 380
  - log\_bin, 380
  - log\_bin\_trust\_function\_creators, 380
  - log\_error, 380
  - log\_output, 380
  - log\_queries\_not\_using\_indexes, 381
  - log\_slave\_updates, 381
  - log\_slow\_queries, 381
  - log\_warnings, 381
  - long\_query\_time, 382
  - lower\_case\_file\_system, 382
  - lower\_case\_table\_names, 383
  - low\_priority\_updates, 382
  - max\_allowed\_packet, 383
  - max\_binlog\_cache\_size, 1364
  - max\_binlog\_size, 1364
  - max\_connections, 384
  - max\_connect\_errors, 384
  - max\_delayed\_threads, 384
  - max\_error\_count, 385
  - max\_heap\_table\_size, 385
  - max\_insert\_delayed\_threads, 386
  - max\_join\_size, 386
  - max\_length\_for\_sort\_data, 386
  - max\_prepared\_stmt\_count, 386
  - max\_relay\_log\_size, 387
  - max\_seeks\_for\_key, 387
  - max\_sort\_length, 388
  - max\_sp\_recursion\_depth, 388
  - max\_tmp\_tables, 388
  - max\_user\_connections, 389
  - max\_write\_lock\_count, 389
  - min\_examined\_row\_limit, 389
  - myisam\_data\_pointer\_size, 390
  - myisam\_max\_sort\_file\_size, 390
  - myisam\_recover\_options, 390
  - myisam\_repair\_threads, 390
  - myisam\_sort\_buffer\_size, 391
  - myisam\_stats\_method, 391
  - myisam\_use\_mmap, 392
  - named\_pipe, 392
  - net\_buffer\_length, 392
  - net\_read\_timeout, 393
  - net\_retry\_count, 393
  - net\_write\_timeout, 393
  - new, 394
  - old, 394
  - old\_passwords, 394
  - one\_shot, 395

open\_files\_limit, 395  
 optimizer\_prune\_level, 395  
 optimizer\_search\_depth, 395  
 optimizer\_switch, 396  
 pid\_file, 396  
 plugin\_dir, 396  
 port, 397  
 preload\_buffer\_size, 397  
 prepared\_stmt\_count, 397  
 protocol\_version, 397  
 query\_alloc\_block\_size, 397  
 query\_cache\_limit, 398  
 query\_cache\_min\_res\_unit, 398  
 query\_cache\_size, 398  
 query\_cache\_type, 399  
 query\_cache\_wlock\_invalidate, 399  
 query\_prealloc\_size, 400  
 range\_alloc\_block\_size, 400  
 read\_buffer\_size, 400  
 read\_only, 401  
 read\_rnd\_buffer\_size, 401  
 relay\_log\_purge, 402  
 relay\_log\_space\_limit, 402  
 report\_host, 402  
 report\_password, 402  
 report\_port, 403  
 report\_user, 403  
 secure\_auth, 403  
 secure\_file\_priv, 403  
 server\_id, 403  
 shared\_memory, 404  
 shared\_memory\_base\_name, 404  
 skip\_external\_locking, 404  
 skip\_networking, 404  
 skip\_show\_database, 404  
 slave\_compressed\_protocol, 1357  
 slave\_exec\_mode, 1357  
 slave\_load\_tmpdir, 1357  
 slave\_net\_timeout, 1358  
 slave\_skip\_errors, 1358  
 slave\_transaction\_retries, 1358  
 slow\_launch\_time, 404  
 slow\_query\_log, 404  
 slow\_query\_log\_file, 405  
 socket, 405  
 sort\_buffer\_size, 405  
 sql\_mode, 406  
 sql\_select\_limit, 406  
 sql\_slave\_skip\_counter, 1356, 1358  
 ssl\_ca, 406  
 ssl\_capath, 407  
 ssl\_cert, 407  
 ssl\_cipher, 407  
 ssl\_key, 407  
 storage\_engine, 408  
 sync\_binlog, 1365  
 sync\_frm, 408  
 system\_time\_zone, 408  
 table\_cache, 408  
 table\_definition\_cache, 409  
 table\_lock\_wait\_timeout, 409  
 table\_open\_cache, 409  
 table\_type, 410  
 thread\_cache\_size, 410  
 thread\_concurrency, 410  
 thread\_handling, 411  
 thread\_stack, 411  
 timed\_mutexes, 412  
 time\_format, 411  
 time\_zone, 412

tmpdir, 412  
 tmp\_table\_size, 412  
 transaction\_alloc\_block\_size, 413  
 transaction\_prealloc\_size, 413  
 tx\_isolation, 414  
 updatable\_views\_with\_limit, 414  
 version, 414  
 version\_comment, 414  
 version\_compile\_machine, 414  
 version\_compile\_os, 414  
 wait\_timeout, 415  
 system variables, 352, 418, 994  
   and replication, 1389  
 system\_time\_zone system variable, 408  
 SYSTEM\_USER(), 796

## T

tab (t), 619, 905  
 tab option  
   mysqldump, 245  
 table  
   changing, 839, 845, 2141  
   deleting, 887  
   rebuilding, 122  
   repair, 122  
   row size, 704  
 table aliases, 910  
 table cache, 588  
 Table Dump  
   thread command, 602  
 table is full, 416, 2125  
 Table lock  
   thread state, 606  
 Table Monitor  
   InnoDB, 1093, 1102  
 table names  
   case sensitivity, 623  
   case-sensitivity, 17  
 table option  
   mysql, 215  
   mysqlaccess, 278  
 table scans  
   avoiding, 566  
 table types  
   choosing, 1019  
 table-level locking, 575  
 tables  
   BLACKHOLE, 1118  
   changing column order, 2142  
   checking, 267  
   closing, 588  
   compressed, 271  
   compressed format, 1029  
   const, 534  
   constant, 541  
   copying, 876  
   counting rows, 164  
   creating, 155  
   CSV, 1116  
   defragment, 1029  
   defragmenting, 528, 959  
   deleting rows, 2139  
   displaying, 252  
   displaying status, 991  
   dumping, 235, 289  
   dynamic, 1028  
   error checking, 520  
   EXAMPLE, 1110  
   FEDERATED, 1110

- flush, 226
- fragmentation, 959
- HEAP, 1107
- host, 481
- improving performance, 579
- information, 523
- information about, 167
- InnoDB, 1043
- loading data, 156
- maintenance, 230
- maintenance schedule, 527
- maximum size, 2125
- MEMORY, 1107
- MERGE, 1104
- merging, 1104
- multiple, 166
- MyISAM, 1024
- names, 621
- open, 588
- opening, 588
- optimizing, 523
- partitioning, 1104
- repair, 230
- repairing, 521
- retrieving data, 157
- selecting columns, 159
- selecting rows, 158
- sorting rows, 159
- symbolic links, 616
- system, 533
- too many, 589
- unique ID for last row, 1833
- updating, 19
- TABLES
  - INFORMATION\_SCHEMA table, 1458
- tables option
  - mysqlcheck, 234
  - mysqldump, 245
- Tablespace Monitor
  - InnoDB, 1071, 1085, 1093
- table\_cache system variable, 408
- table\_definition\_cache system variable, 409
- table\_lock\_wait\_timeout system variable, 409
- table\_open\_cache, 588
- table\_open\_cache system variable, 409
- TABLE\_PRIVILEGES
  - INFORMATION\_SCHEMA table, 1462
- table\_type system variable, 410
- TAN(), 749
- tar
  - problems on Solaris, 75, 129
- tc-heuristic-recover option
  - mysqld, 350
- Tcl API, 2044
- tcp-ip option
  - mysqld\_multi, 201
- TCP/IP, 63, 67
- tee command
  - mysql, 219
- tee option
  - mysql, 215
- temp-pool option
  - mysqld, 350
- temporary file
  - write access, 105
- temporary tables
  - and replication, 1387
  - internal, 614
  - problems, 2142
- terminal monitor
  - defined, 151
- test option
  - myisampack, 272
- testing
  - connection to the server, 478
  - installation, 102
  - of MySQL releases, 36
  - post-installation, 100
- testing mysqld
  - mysqltest, 2046
- TEXT
  - size, 706
- TEXT columns
  - default values, 700
  - indexing, 580, 868
- TEXT data type, 687, 700
- text files
  - importing, 222, 247
- thread cache, 611
- thread command
  - Binlog Dump, 601
  - Change user, 601
  - Close stmt, 601
  - Connect, 601
  - Connect Out, 601
  - Create DB, 601
  - Daemon, 601
  - Debug, 601
  - Delayed insert, 601
  - Drop DB, 601
  - Error, 601
  - Execute, 601
  - Fetch, 601
  - Field List, 602
  - Init DB, 602
  - Kill, 602
  - Long Data, 602
  - Ping, 602
  - Prepare, 602
  - Processlist, 602
  - Query, 602
  - Quit, 602
  - Refresh, 602
  - Register Slave, 602
  - Reset stmt, 602
  - Set option, 602
  - Shutdown, 602
  - Sleep, 602
  - Statistics, 602
  - Table Dump, 602
  - Time, 602
- thread commands, 601
- thread packages
  - differences between, 2079
- thread state
  - After create, 603
  - allocating local table, 607
  - Analyzing, 603
  - Changing master, 609
  - Checking master version, 608
  - checking permissions, 603
  - Checking table, 603
  - cleaning up, 603
  - Clearing, 610
  - closing tables, 603
  - Committing events to binlog, 610
  - Connecting to master, 608
  - converting HEAP to MyISAM, 603
  - copy to tmp table, 603
  - Copying to group table, 603

- Copying to tmp table, 603
- Copying to tmp table on disk, 603
- Creating delayed handler, 607
- Creating index, 603
- Creating sort index, 603
- creating table, 603
- Creating table from master dump, 609
- Creating tmp table, 603
- deleting from main table, 604
- deleting from reference tables, 604
- discard\_or\_import\_tablespace, 604
- end, 604
- executing, 604
- Execution of init\_command, 604
- Finished reading one binlog; switching to next binlog, 608
- Flushing tables, 604
- freeing items, 604
- FULLTEXT initialization, 604
- got handler lock, 607
- got old table, 607
- Has read all relay log; waiting for the slave I/O thread to update it, 609
- Has sent all binlog to slave; waiting for binlog to be updated, 608
- init, 604
- Initialized, 610
- insert, 607
- Killed, 604
- Killing slave, 609
- Locked, 604
- logging slow query, 604
- login, 604
- Making temp file, 609
- NULL, 604
- Opening master dump table, 610
- Opening mysql.ndb\_apply\_status, 610
- Opening table, 604
- Opening tables, 604
- preparing, 605
- Processing events, 610
- Processing events from schema table, 610
- Purging old relay logs, 605
- query end, 605
- Queueing master event to the relay log, 608
- Reading event from the relay log, 609
- Reading from net, 605
- Reading master dump table data, 610
- Rebuilding the index on master dump table, 610
- Reconnecting after a failed binlog dump request, 608
- Reconnecting after a failed master event read, 609
- Registering slave on master, 608
- Removing duplicates, 605
- removing tmp table, 605
- rename, 605
- rename result table, 605
- Reopen tables, 605
- Repair by sorting, 605
- Repair done, 605
- Repair with keycache, 605
- Requesting binlog dump, 608
- reschedule, 607
- Rolling back, 605
- Saving state, 605
- Searching rows for update, 605
- Sending binlog event to slave, 608
- setup, 606
- Shutting down, 610
- Sorting for group, 606
- Sorting for order, 606
- Sorting index, 606
- Sorting result, 606
- starting slave, 610
- statistics, 606
- storing row into queue, 607
- Syncing ndb table schema operation and binlog, 610
- System lock, 606
- Table lock, 606
- update, 607
- Updating, 606
- updating main table, 606
- updating reference tables, 606
- upgrading lock, 607
- User lock, 606
- waiting for delay\_list, 607
- Waiting for event from ndbcluster, 610
- Waiting for first event from ndbcluster, 610
- waiting for handler insert, 607
- waiting for handler lock, 607
- waiting for handler open, 607
- Waiting for INSERT, 607
- Waiting for master to send event, 608
- Waiting for master update, 608
- Waiting for ndbcluster binlog update to reach current position, 610
- Waiting for ndbcluster to start, 610
- Waiting for next activation, 610
- Waiting for scheduler to stop, 611
- Waiting for schema epoch, 610
- Waiting for slave mutex on exit, 609, 609
- Waiting for table, 606
- Waiting for tables, 606
- Waiting for the next event in relay log, 609
- Waiting for the slave SQL thread to free enough relay log space, 609
- Waiting on cond, 606
- Waiting on empty queue, 611
- Waiting to finalize termination, 608
- Waiting to reconnect after a failed binlog dump request, 608
- Waiting to reconnect after a failed master event read, 609
- Writing to net, 606
- thread states
  - delayed inserts, 607
  - event scheduler, 610
  - general, 603
  - MySQL Cluster, 610
  - replication master, 608
  - replication slave, 608, 609, 609
- thread support, 34
  - non-native, 96
- threaded clients, 1838
- threads, 226, 982, 2046
  - display, 982
  - RTS, 2078
- thread\_cache\_size system variable, 410
- thread\_concurrency system variable, 410
- thread\_handling system variable, 411
- thread\_stack system variable, 411
- Time
  - thread command, 602
- TIME data type, 685, 696
- time types, 705
- time zone problems, 2135
- time zone tables, 206
- time zones
  - and replication, 1387
  - leap seconds, 679
  - support, 676
  - upgrading, 678
- TIME(), 761
- TIMEDIFF(), 761
- timed\_mutexes system variable, 412
- timeout, 365, 797, 899



- connect\_timeout variable, 216, 230
- shutdown\_timeout variable, 230
- timeouts (replication), 1387
- TIMESTAMP
  - and NULL values, 2138
  - and replication, 1378
- TIMESTAMP data type, 685, 692
- timestamp session variable, 418
- TIMESTAMP(), 761
- TIMESTAMPADD(), 761
- TIMESTAMPDIFF(), 761
- timezone option
  - mysqld\_safe, 197
- time\_format system variable, 411
- TIME\_FORMAT(), 761
- TIME\_TO\_SEC(), 762
- time\_zone system variable, 412
- TINYBLOB data type, 687
- TINYINT data type, 682
- TINYTEXT data type, 687
- tips
  - optimization, 572
- TMPDIR environment variable, 105, 147
- tmpdir option
  - mysamchk, 269
  - mysampack, 272
  - mysqld, 351
  - mysqlhotcopy, 292
  - mysql\_upgrade, 208
- tmpdir system variable, 412
- tmp\_table\_size system variable, 412
- to-last-log option
  - mysqlbinlog, 282
- TODO
  - symlinks, 617
- tools
  - command-line, 209
  - list of, 31
  - mysqld\_multi, 199
  - mysqld\_safe, 194
- Touches(), 826
- TO\_DAYS(), 762
- trace DBI method, 2074
- TRADITIONAL SQL mode, 443, 448
- transaction isolation level, 943
  - READ COMMITTED, 944
  - READ UNCOMMITTED, 944
  - REPEATABLE READ, 944
  - SERIALIZABLE, 944
- transaction-isolation option
  - mysqld, 350
- transaction-safe tables, 19, 1043
- transactions
  - and replication, 1387, 1388
  - support, 19, 1043
- transaction\_alloc\_block\_size system variable, 413
- transaction\_prealloc\_size system variable, 413
- Translators
  - list of, 29
- trigger restrictions, 2514
- trigger, creating, 879
- trigger, dropping, 888
- triggers, 21, 993, 1436, 1439
  - and INSERT DELAYED, 897
  - and replication, 1382, 1388
  - LAST\_INSERT\_ID(), 1439
  - metadata, 1441
- TRIGGERS
  - INFORMATION\_SCHEMA table, 1467
- triggers option

- mysqldump, 245
- TRIM(), 732
- troubleshooting
  - FreeBSD, 95
  - Solaris, 95
- TRUE, 620, 620
  - testing for, 719, 719
- TRUNCATE, 931
  - and replication, 1389
- TRUNCATE(), 749
- tutorial, 151
- Twin Studies
  - queries, 174
- tx\_isolation system variable, 414
- type conversions, 716, 718
- type option
  - mysql\_convert\_table\_format, 304
- types
  - column, 682
  - columns, 707
  - data, 682
  - date, 705
  - Date and Time, 691
  - numeric, 705
  - of tables, 1019
  - portability, 707
  - strings, 698
  - time, 705
- typographical conventions, 2, 1215
- TZ environment variable, 147, 2135
- tz-utc option
  - mysqldump, 245

## U

- UCASE(), 733
- UCS-2, 635
- UDFs, 962, 962
  - compiling, 2067
  - defined, 2060
  - return values, 2066
- ulimit, 2128
- UMASK environment variable, 147, 2130
- UMASK\_DIR environment variable, 147, 2130
- unary minus (-), 741
- unbuffered option
  - mysql, 215
- UNCOMPRESS(), 791
- UNCOMPRESSED\_LENGTH(), 791
- UNHEX(), 733
- Unicode, 635
- Unicode Collation Algorithm, 658
- UNINSTALL PLUGIN, 964
- uninstalling plugins, 964
- UNION, 172, 921
- Union(), 824
- UNIQUE, 845
- unique ID, 1833
- unique key
  - constraint, 23
- unique keys
  - and partitioning keys, 1431
- unique\_checks session variable, 418
- unique\_subquery join type
  - optimizer, 534
- Unix, 1486, 1565
- UNIX\_TIMESTAMP(), 762
- UNKNOWN
  - testing for, 719, 719
- unloading

- tables, 157
  - UNLOCK TABLES, 939
  - unnamed views, 926
  - unpack option
    - myisamchk, 269
  - UNSIGNED, 682, 689
  - UNTIL, 1018
  - updatable views, 1450
  - updatable\_views\_with\_limit system variable, 414
  - update
    - thread state, 607
  - UPDATE, 932
  - update-state option
    - myisamchk, 268
  - UpdateXML(), 779
  - updating
    - releases of MySQL, 37
    - tables, 19
  - Updating
    - thread state, 606
  - updating main table
    - thread state, 606
  - updating reference tables
    - thread state, 606
  - upgrading, 112, 112
    - different architecture, 123
    - grant tables, 204
    - to &current-series;, 113
  - upgrading lock
    - thread state, 607
  - upgrading MySQL, 207
  - UPPER(), 733
  - uptime, 226
  - URLs for downloading MySQL, 42
  - USE, 936
  - use command
    - mysql, 219
  - USE INDEX, 919
  - USE KEY, 919
  - use-frm option
    - mysqlcheck, 234
  - use-manager option
    - mysql.server, 199
  - use-mysqld\_safe option
    - mysql.server, 199
  - use-threads option
    - mysqlimport, 251
    - mysqslap, 261
  - user accounts
    - creating, 948
    - renaming, 954
  - USER environment variable, 147, 184
  - User lock
    - thread state, 606
  - user names
    - and passwords, 486
  - user option, 184
    - mysql, 216
    - mysql.server, 199
    - mysqlaccess, 278
    - mysqladmin, 229
    - mysqlbinlog, 282
    - mysqlcheck, 235
    - mysqld, 351
    - mysqldump, 245
    - mysqld\_multi, 201
    - mysqld\_safe, 197
    - mysqlhotcopy, 292
    - mysqlimport, 251
    - mysqlmanager, 295
    - mysqlshow, 254
    - mysqslap, 261
    - mysql\_convert\_table\_format, 304
    - mysql\_install\_db, 206
    - mysql\_setpermission, 305
    - mysql\_upgrade, 208
  - user privileges
    - adding, 487
    - deleting, 489, 948
    - dropping, 489, 948
  - user table
    - sorting, 479
  - user variables, 631
    - and replication, 1389
  - USER(), 796
  - User-defined functions, 962, 962
  - user-defined functions
    - adding, 2060, 2061
  - username option
    - mysqlmanager, 295
  - users
    - adding, 82, 85
    - deleting, 489, 948
    - root, 109
  - USER\_PRIVILEGES
    - INFORMATION\_SCHEMA table, 1461
  - uses
    - of MySQL, 530
  - using multiple disks to start data, 617
  - UTC\_DATE(), 763
  - UTC\_TIME(), 763
  - UTC\_TIMESTAMP(), 763
  - UTF-8, 635
  - utilities
    - program-development, 180
  - utility programs, 178
  - UUID(), 799
  - UUID\_SHORT(), 799
- ## V
- valid numbers
    - examples, 620
  - VALUES(), 800
  - VARBINARY data type, 687, 699
  - VARCHAR
    - size, 706
  - VARCHAR data type, 687, 698
  - VARCHARACTER data type, 687
  - variables
    - and replication, 1389
    - environment, 180
    - mysqld, 591
    - server, 352, 994
    - status, 427, 990
    - system, 352, 418, 994
    - user, 631
  - VARIANCE(), 803
  - VAR\_POP(), 803
  - VAR\_SAMP(), 803
  - verbose option
    - myisamchk, 266
    - myisampack, 272
    - myisam\_ftdump, 262
    - mysql, 216
    - mysqladmin, 229
    - mysqlbinlog, 282
    - mysqlcheck, 235
    - mysqld, 351
    - mysqldump, 245

- mysqldumpslow, 289
  - mysqld\_multi, 201
  - mysqlexport, 251
  - mysqlshow, 254
  - mysqlslap, 261
  - mysql\_convert\_table\_format, 304
  - mysql\_install\_db, 206
  - mysql\_upgrade, 208
  - mysql\_waitpid, 306
  - my\_print\_defaults, 308
  - perror, 310
  - version
    - choosing, 35
    - latest, 42
  - version option
    - comp\_err, 203
    - myisamchk, 266
    - myisampack, 272
    - mysql, 216
    - mysqlaccess, 278
    - mysqladmin, 229
    - mysqlbinlog, 282
    - mysqlcheck, 235
    - mysqld, 351
    - mysqldump, 245
    - mysqld\_multi, 201
    - mysqlexport, 251
    - mysqlmanager, 295
    - mysqlshow, 254
    - mysqlslap, 261
    - mysql\_config, 307
    - mysql\_convert\_table\_format, 304
    - mysql\_waitpid, 306
    - my\_print\_defaults, 308
    - perror, 310
    - resolveip, 311
    - resolve\_stack\_dump, 309
  - version system variable, 414
  - VERSION(), 796
  - version\_comment system variable, 414
  - version\_compile\_machine system variable, 414
  - version\_compile\_os system variable, 414
  - vertical option
    - mysql, 216
    - mysqladmin, 229
  - Vietnamese, 2100, 2108
  - view restrictions, 2519
  - views, 22, 882, 1436, 1448
    - algorithms, 1448
    - and replication, 1389
    - metadata, 1451
    - updatable, 22, 882, 1450
  - VIEWS
    - INFORMATION\_SCHEMA table, 1466
  - Views
    - limitations, 2520
    - privileges, 2520
    - problems, 2520
  - virtual memory
    - problems while compiling, 94
  - Vision, 1560
  - Visual Objects, 1558
  - Visual Studio, 97
- ## W
- wait option
    - myisamchk, 266
    - myisampack, 272
    - mysql, 216
    - mysqladmin, 230
    - wait-timeout option
      - mysqlmanager, 295
    - waiting for delay\_list
      - thread state, 607
    - Waiting for event from ndbcluster
      - thread state, 610
    - Waiting for first event from ndbcluster
      - thread state, 610
    - waiting for handler insert
      - thread state, 607
    - waiting for handler lock
      - thread state, 607
    - waiting for handler open
      - thread state, 607
    - Waiting for INSERT
      - thread state, 607
    - Waiting for master to send event
      - thread state, 608
    - Waiting for master update
      - thread state, 608
    - Waiting for ndbcluster binlog update to reach current position
      - thread state, 610
    - Waiting for ndbcluster to start
      - thread state, 610
    - Waiting for next activation
      - thread state, 610
    - Waiting for scheduler to stop
      - thread state, 611
    - Waiting for schema epoch
      - thread state, 610
    - Waiting for slave mutex on exit
      - thread state, 609, 609
    - Waiting for table
      - thread state, 606
    - Waiting for tables
      - thread state, 606
    - Waiting for the next event in relay log
      - thread state, 609
    - Waiting for the slave SQL thread to free enough relay log space
      - thread state, 609
    - Waiting on cond
      - thread state, 606
    - Waiting on empty queue
      - thread state, 611
    - Waiting to finalize termination
      - thread state, 608
    - Waiting to reconnect after a failed binlog dump request
      - thread state, 608
    - Waiting to reconnect after a failed master event read
      - thread state, 609
    - wait\_timeout system variable, 415
    - warnings command
      - mysql, 219
    - warning\_count session variable, 418
    - WEEK(), 763
    - WEEKDAY(), 764
    - WEEKOFYEAR(), 764
    - Well-Known Binary format, 813
    - Well-Known Text format, 812
    - WHERE, 540
      - with SHOW, 1457, 1481
    - where option
      - mysqldump, 245
    - WHILE, 1018
    - widths
      - display, 682
    - Wildcard character (%), 619
    - Wildcard character (\_, 619
    - wildcards

- and LIKE, 582
- in account names, 477
- in mysql.columns\_priv table, 480
- in mysql.db table, 480
- in mysql.host table, 480
- in mysql.procs\_priv table, 480
- in mysql.tables\_priv table, 480

Windows, 1486, 1565

- compiling on, 100
- open issues, 71
- upgrading, 68
- versus Unix, 69

windows option

- mysql\_install\_db, 206

with-big-tables option, 85

- configure, 91

with-client-ldflags option

- configure, 89

with-debug option

- configure, 90

with-embedded-server option

- configure, 89

with-extra-charsets option

- configure, 90

with-unix-socket-path option

- configure, 89

with-zlib-dir option

- configure, 91

Within(), 826

without-server option, 85

- configure, 88

WKB format, 813

WKT format, 812

wrappers

- Eiffel, 2045

write access

- tmp, 105

write-binlog option

- mysqlbinlog, 283

write\_buffer\_size myisamchk variable, 266

Writing to net

- thread state, 606

## X

X(), 820

X509/Certificate, 497

XA BEGIN, 945

XA COMMIT, 945

XA PREPARE, 945

XA RECOVER, 945

XA ROLLBACK, 945

XA START, 945

XA transactions, 944

- transaction identifiers, 945

xid

- XA transaction identifier, 945

xml option

- mysql, 216
- mysqldump, 245

XOR

- bitwise, 787
- logical, 722

## Y

Y(), 820

yaSSL, 497, 497

Year 2000 compliance, 697

Year 2000 issues, 697

YEAR data type, 685, 697

YEAR(), 764

YEARWEEK(), 764

Yen sign (Japanese), 2100, 2103

## Z

ZEROFILL, 682, 689, 1836